

BASIC AND RF CONTROLLER ELECTRICAL RADIATOR

BASIC



**GEBRUIKERS- EN
INSTALLATIEHANDLEIDING**
REGELING VOOR
ELEKTRISCHE RADIATOR

**MANUEL D'UTILISATION
ET D'INSTALLATION**
CONTRÔLEUR POUR
RADIATEUR ÉLECTRIQUE

**GEBRAUCHS- UND
INSTALLATIONSANWEISUNG**
HEIZUNGSREGLER FÜR
ELEKTRO HEIZKÖRPER

**USER AND
INSTALLATION MANUAL**
CONTROLLER FOR
ELECTRICAL RADIATOR

**MANUALE DI INSTALLAZIONE
E D'USO**
DISPOSITIVO DI CONTROLLO PER
RADIATORE ELETTRICO

**INSTRUKCJA INSTALACJI
I UŻYTKOWANIA**
TERMOSTAT DO GRZEJNIKA
ELEKTRYCZNEGO

RF

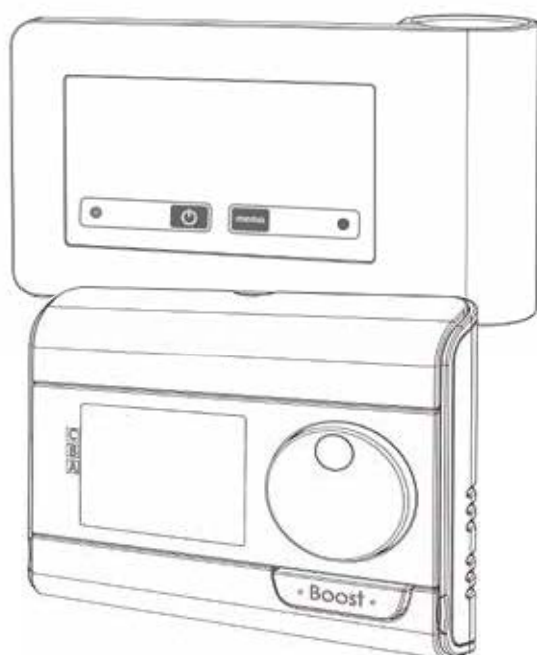

VEILIGHEIDSINSTRUCTIES



Het toestel mag niet gebruikt worden door personen (onder wie kinderen) met verminderde lichamelijke, zintuiglijke of mentale capaciteiten, of zonder ervaring of kennis, tenzij deze personen onder toezicht werken of instructies krijgen.

Kinderen mogen niet met de regeling spelen, ook niet onder toezicht.



De radiator mag nooit worden afgedekt en mag niet onder een stopcontact gemonteerd worden.

De radiator dient ten alle tijden afgeschakeld te kunnen worden. In geval van een stekker aansluiting dient dit mogelijk te zijn door een externe schakelaar. In geval van een bedrade vaste aansluiting dient het elektrisch circuit juist afgezekerd te zijn.

Bij de montage van de radiator gelieve de lokale/nationale regels te volgen voor de elektrische installatie en onze algemene voorwaarden.

AFVALVERWIJDERING VOLGENS DE AEEA-RICHTLIJN (2012/19/EU)



Het symbool op het kenplaatje van de radiator geeft aan dat de radiator niet als huisvuil mag worden behandeld, maar gesorteerd moet worden. Wanneer de radiator het einde van zijn levensduur heeft bereikt, moet het worden ingeleverd bij een inzamelingsinrichting voor elektrische en elektronische producten.

Voor meer informatie over recyclage- en inzamelingsinrichtingen kunt u contact opnemen met uw lokale overheid/gemeente of afvalophalingsdienst, van toepassing in de landen waar deze richtlijn is omgezet.

TECHNISCHE SPECIFICATIES

- Bedrijfsspanning: 230 VAC 50 Hz
- Maximaal vermogen van 1500W, weerstandsbelasting
- Voedingskabel klasse II, 800 mm, 3 stroomdraden.



De zwarte (onzichtbare en afgeschermd) kabel is een communicatiekabel die enkel van toepassing is in Frankrijk, mag zeker niet op de aarding aangesloten worden en dient dus steeds afgeschermd te zijn. Indien de voedingskabel beschadigd is, gelieve uw installateur te contacteren.

- Verbruik in stand-by: <0,5W
- Elektronische PID-regeling, aangestuurd door een relais+triac-schakeling
- IPX4



- Klasse II, na installatie onder de verantwoordelijkheid van de installateur (volgens EN60335-1)

VERKLARING VAN DE PRODUCENT



Wij verklaren onder onze eigen verantwoordelijkheid dat de producten die in deze handleiding worden beschreven voldoen aan het CE-keurmerk en aan alle essentiële eisen van de volgende richtlijnen en geharmoniseerde normen:

- LVD 2014/35/EU: EN60335-1/EN60335-2-30/EN60335-2-43/ EN62333
- EMC 2014/30/EU: EN55014-1/EN55014-2-30/EN61000-3-2/ EN61000-3-3
- ERP 2009/125/EC
- RoHS 2011/65/EU: EN50581

en dat de producten werden vervaardigd volgens gecertificeerde processen volgens ISO 9001 V2015.

Dit apparaat voldoet aan de aan de Europese richtlijn ECO Design Directive 2015/1188:

Informatie-eisen voor elektrische toestellen voor lokale ruimteverwarming			
Karakteristiek	Symbool	Waarde	Eenheid
Warmteafgifte			
Nominale warmteafgifte	P nom	0,5 → 1,5	kW
Minimale warmteafgifte	P min	0,5	kW
Maximale continue warmteafgifte	P max,c	1,5	kW
Aanvullend elektrisch verbruik			
Bij nominale warmteafgifte	el max	0,000	kW
Bij minimale warmteafgifte	el min	0,000	kW
In stand-bymodus	el sb	0,0005	kW
Type warmteafgifte/sturing kamertemperatuur			
Elektronische sturing van de kamertemperatuur plus week-tijdschakelaar			
Andere sturingsmogelijkheden			
Sturing van de kamertemperatuur, met openraamdetectie			
Met de optie van afstandsbediening			
RF	Met adaptieve sturing van de start		
Contactgegevens			
Zie kenplaatje op de radiator			

Garantievoorwaarden:

zie
www.vasco-group.eu

MONTAGE VAN DE REGELING

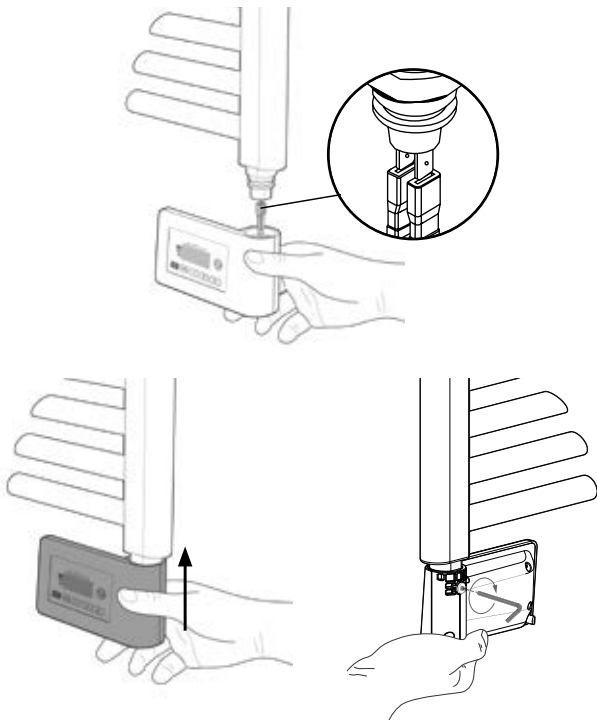

Schroef de regeling vast met de meegeleverde inbusleutel.

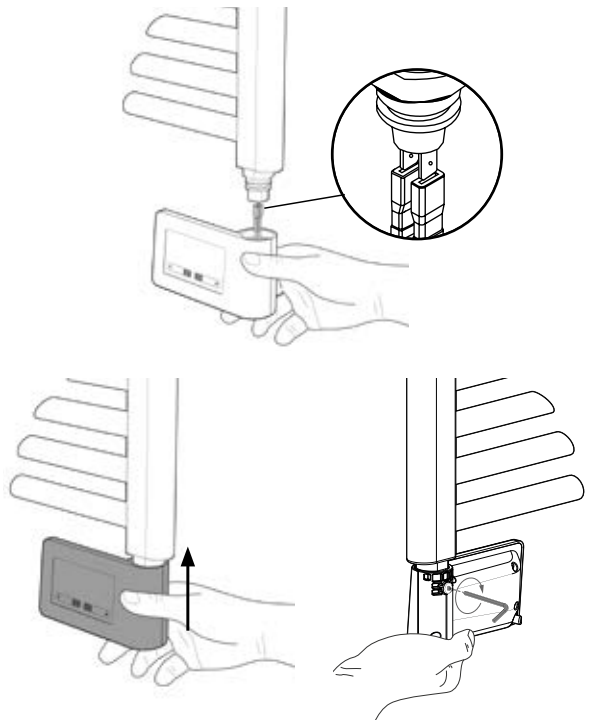

Schroef de regeling vast met de meegeleverde inbusleutel.

BATTERIJEN PLAATSEN

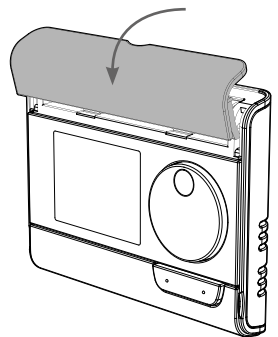

Verwijder het klepje van het batterijenvak op de voorzijde van de RF afstandsbediening.

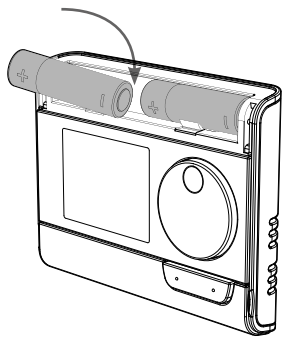

Plaats de 2 meegeleverde AA-batterijen. Let daarbij op de polariteit die staat aangeduid op de RF afstandsbediening.

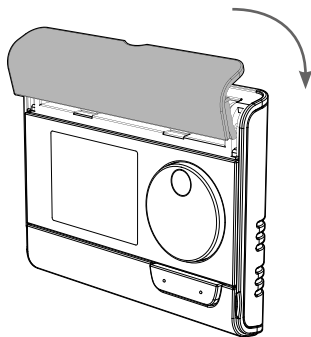

Plaats het klepje weer op zijn plaats.

RF

MONTAGE VAN DE RF AFSTANDSBEDIENING

Aan de muur

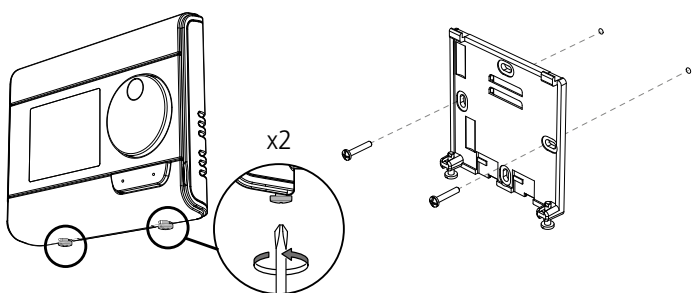

Schroef de 2 schroeven onder de RF afstandsbediening los.

Bevestig het muurplaatje met de 2 meegeleverde schroeven en gebruik hiervoor de horizontale en verticale gaatjes.

Op de standaard

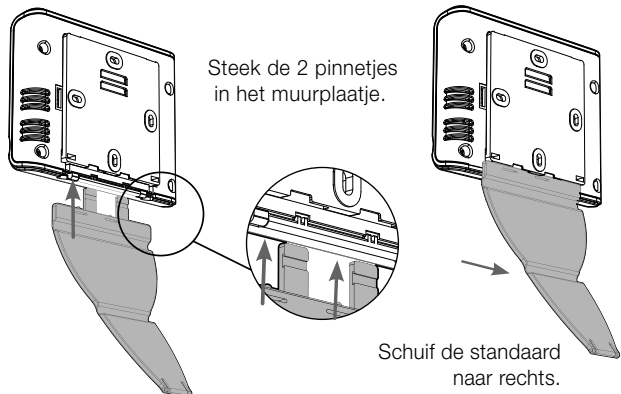

Steek de 2 pinnetjes in het muurplaatje.

Schuif de standaard naar rechts.

RF ONTVANGER EN RF AFSTANDSBEDIENING KOPPELEN

De RF-afstandsbediening en de RF-ontvanger zijn niet gekoppeld.

Opgelet: Er kunnen maximum 5 RF ontvangers aan 1 RF afstandsbediening gekoppeld worden.

Ga als volgt te werk en doe dit per RF ontvanger:

RF koppeling:

1. Zet de RF ontvanger in koppelmodus door 5 seconden op de **memo** knop te drukken. Het **memo** ledje knippert ROOD.

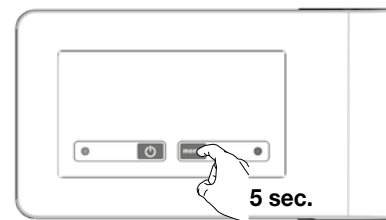

2. Zet de RF afstandsbediening in vorstbeveiligingsmodus: druk 3x op de knop **mode** en druk gedurende 5 seconden op **OK**.

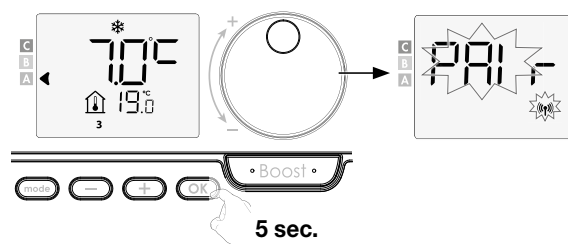

3. Om een correcte werking van de radiator te garanderen, **moet** het vermogen van de radiator ingesteld worden via de RF afstandsbediening. Deze stap komt automatisch aan bod tijdens het koppelen.

Het vermogen staat standaard ingesteld op 500W. Gebruik de toetsen **+** en **-** om het vermogen (zie kenplaatje radiator) in te stellen.

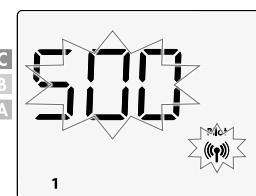

4. Wanneer de RF afstandsbediening en de RF ontvanger gekoppeld zijn, verschijnt het symbool ((P)) en blijft het op het scherm staan.

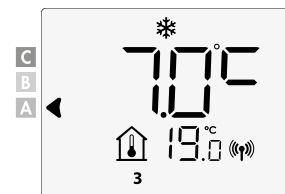

De RF koppeling annuleren:

Druk langer dan 10 seconden op de Memo-knop van de RF ontvanger.

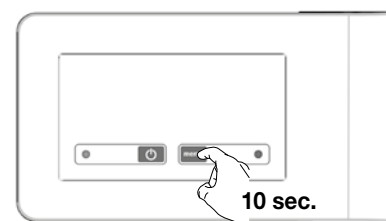

Status bedrijfsmodus



Status bedrijfsmodus	LED status en kleur
Standby	Uit
Ingeschakeld	Groen
Verwarming aan	Rood
Boost	Rood knipperen
Vorstbeveiliging, openraamdetectie	Groen knipperen
Handmatige opheffing (MEMO-knop)	Oranje knipperen

Status RF communicatie



Status RF communicatie	LED status en kleur
Standby	Uit
Geen RF koppeling	Rood
RF koppeling	Rood knipperen
RF ontkoppeling	Snel rood knipperen
RF connectie OK	Groen
RF bericht ontvangen	1 sec snel groen knipperen

! RADIATORVERMOGEN INSTELLEN

Om een correcte werking van de radiator te garanderen, moet het vermogen van de radiator ingesteld worden via de basis regeling. Deze staat standaard ingesteld op 500W.



Volg de onderstaande stappen:

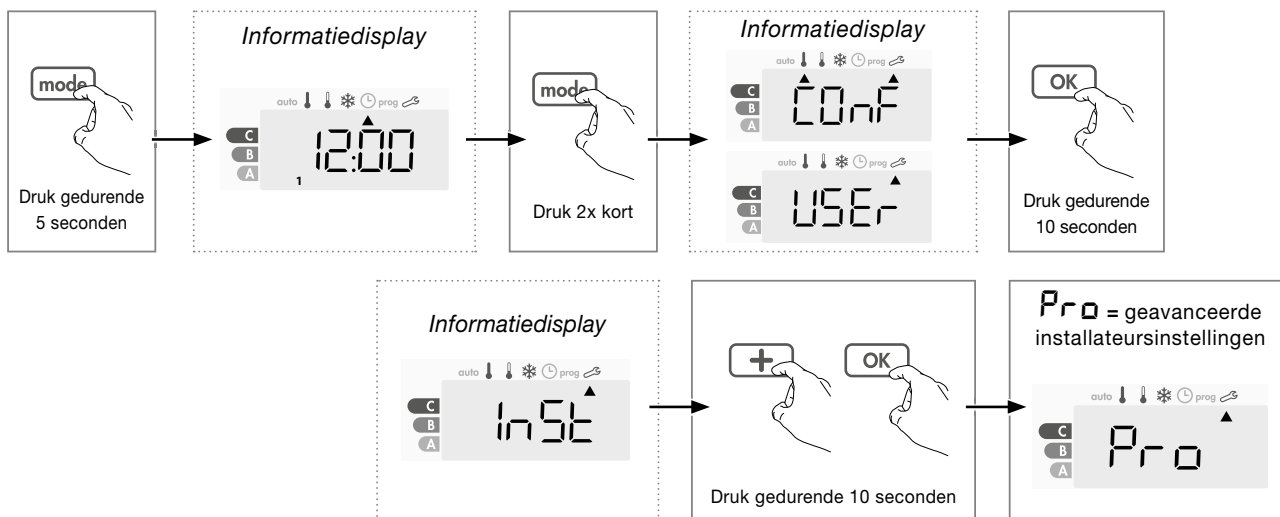

Druk dan 2x op de knop **OK** en wijzig het vermogen door op **-** en **+** te drukken. Verlaat het menu door 3x op de knop **mode** te drukken.

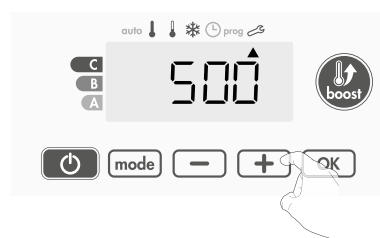

BEDIENING

• Overzicht knoppen

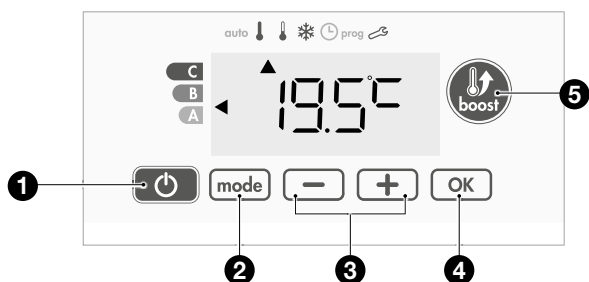

- 1 Aan/stand-by
- 2 Selectie gebruiksmodus
- 3 Plus- en minknop om temperatuur, tijd, datum en weekprogramma in te stellen
- 4 Bewaar instellingen
- 5 Boost

• Overzicht indicatoren

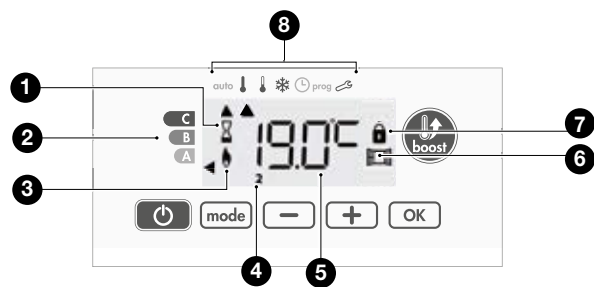

- 1 Boost indicator
- 2 Energieverbruik
- 3 Verwarmingsindicator
- 4 Dagen van de week (1= maandag ... 7= zondag)
- 5 Ingestelde temperatuur
- 6 Indicator openraamdetectie
- 7 Toetsenbord vergrendeld

8 Gebruiksmodi:

- auto** Automodus
- !** Comfortmodus
- !** Ecomodus
- *** Vorstbeveiligingsmodus
- ⌚** Instellingsmodus datum en tijd
- prog** Programmeringsmodus
- 🔧** Instellingen

BEDIENING RF REGELING

• Overzicht knoppen

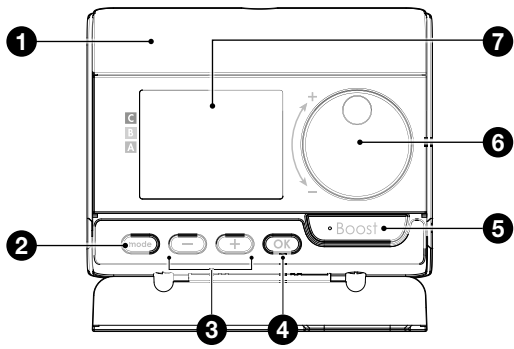

- 1 Batterijenvak
- 2 Selectie gebruiksmodus
- 3 Plus- en minknop om temperatuur, tijd, datum en weekprogramma in te stellen
- 4 Instellingen bewaren
- 5 Boost-knop
- 6 Draaiknop om temperatuur in te stellen
- 7 LCD-scherm

• Overzicht indicatoren

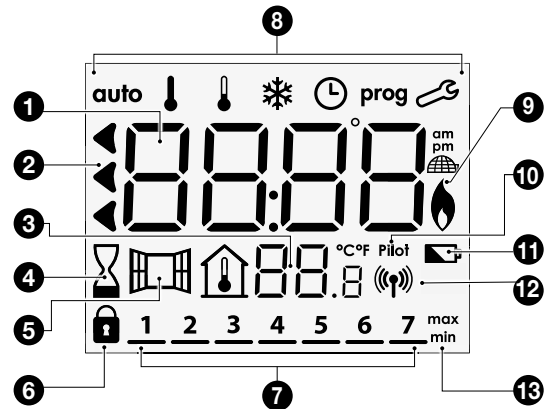

Dagen van de week (1=maandag ... 7=zondag)

- 1 Temperatuur instellingen / Informatie
- 2 Energieverbruik
- 3 Gemeten temperatuur
- 4 Boost indicator
- 5 Indicator openraamdetectie
- 6 Toetsenbord vergrendeld
- 9 Verwarmingsindicator
- 10 File Pilote (enkel voor Frankrijk)
- 11 Indicator batterij
- 12 Indicator radiotransmissie
- 13 Indicator min/max waarde

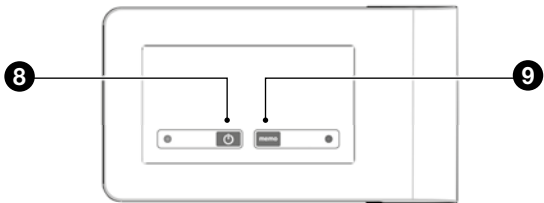

- 8 Aan/standby
- 9 RF koppeling, manuele overschrijving verwarming

8 Gebruiksmodi:

auto Automodus ↓ Comfortmodus ↓ Ecomodus
 * Vorstbeveiligingsmodus ⌚ Instellingsmodus datum en tijd
prog Programmeringsmodus 🔑 Instellingen

AAN/STAND-BY

Druk op de knop om de regeling in te schakelen, in de Automodus. Druk opnieuw op de knop om de regeling in stand-by te schakelen.

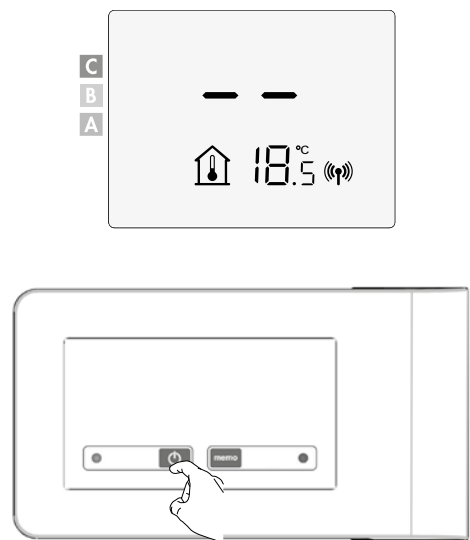
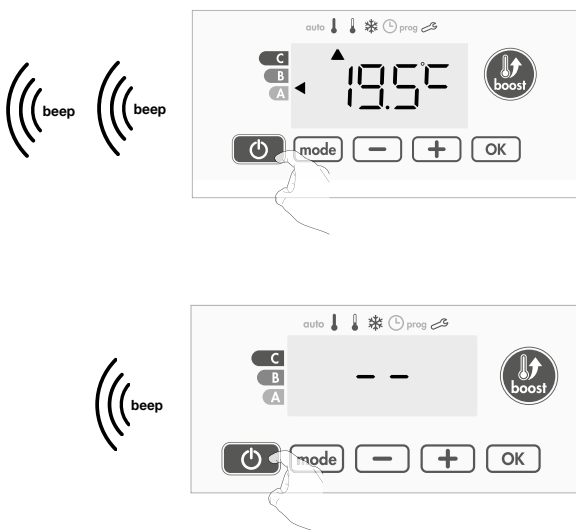

GEBRUIKSMODI

Druk op de knop  om de gewenste modus te selecteren.



Volgorde van de modi

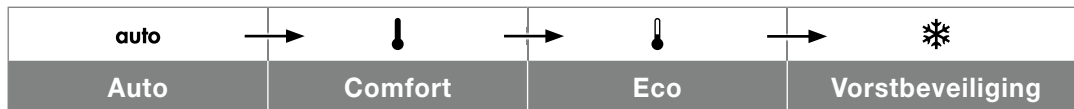

• auto Automodus (3 situaties)

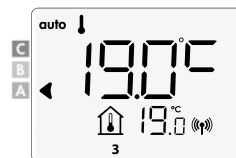
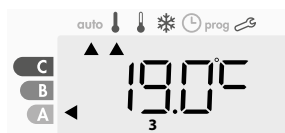

1 Weekprogramma ingesteld

Indien een weekprogramma werd ingesteld zal de radiator automatisch omschakelen tussen Comfort- en Ecomodus.

BASIC

Bij een stroomonderbreking langer dan 3u zal de dag en tijd opnieuw ingesteld moeten worden, het weekprogramma blijft permanent in het geheugen.

2 Aansturing via een communicatiedraad (Fil Pilote, enkel voor Frankrijk)

3 Weekprogramma niet ingesteld

Als het weekprogramma niet is ingesteld werkt de radiator permanent in Comfortmodus.

• ↓ Comfortmodus

Permanente Comfortmodus. De regeling werkt 24 uur per dag om de ingestelde temperatuur te bereiken (bv. 19°C). De temperatuur van de Comfortmodus wordt door de gebruiker ingesteld.



• ↓ Ecomodus

De temperatuur in Ecomodus is 3,5°C lager dan die in Comfortmodus. Daardoor kunt u de temperatuur verlagen zonder de temperatuur van de Comfortmodus te wijzigen. Kies deze modus voor kortstondige afwezigheden (2 tot 24 uur) en voor 's nachts.

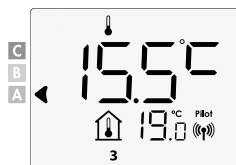

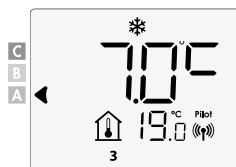

• ❄ Vorstbeveiligingsmodus

Met deze modus kunt u uw huis beschermen tegen de effecten van koud weer (bevroren leidingen, enz.) door te allen tijde een minimumtemperatuur van 7°C aan te houden. Kies deze modus wanneer u voor een langere tijd (meer dan 5 dagen) niet thuis zult zijn.



COMFORTTEMPERATUUR INSTELLEN

In Auto- en Comfortmodus kan de Comforttemperatuur ingesteld worden. Die is standaard 19°C.

Gebruik  en  om de temperatuur aan te passen van 7°C tot 30°C met intervallen van 0,5°C.

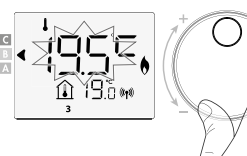
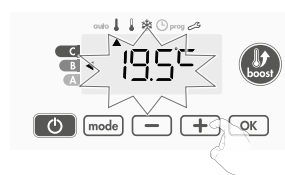

BOOST

De Boostmodus kan op elk moment ingeschakeld worden, in gelijk welke gebruiksmodus (Auto, Comfort, Eco of Vorstbeveiliging).

Eerste druk = Boost.

Tijdens de eerste minuut kunt u de duur van de Boost wijzigen van 0 tot de maximaal toegelaten duur, door op **-** en **+** te drukken. Uw wijziging wordt bewaard en zal toegepast worden tijdens de volgende Boost periode.

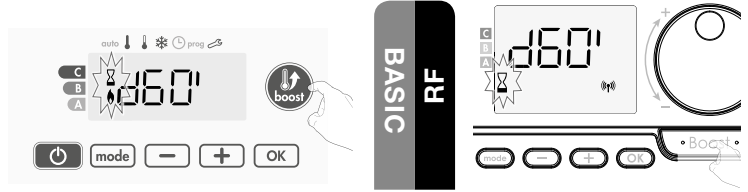

Opmerking: na 1 minuut kunt u de duur tijdelijk wijzigen: enkel geldig tijdens deze Boost periode en bijgevolg niet terugkerend. **De boost-functie kan stoppen als de omgevingstemperatuur de maximale Boost-temperatuur heeft bereikt.**

De regeling schakelt uit maar de Boostmodus is nog steeds actief: de telling wordt nog weergegeven. Als de temperatuur onder de maximaal Boost-temperatuur zakt, zal de Boost opnieuw opstarten tot het einde van de telling.



Tweede druk = stopzetting Boost.

De regeling keert terug naar de vorige gebruiksmodus.

ENERGIEVERBRUIK

Een cursor duidt het niveau van het energieverbruik aan in functie van de ingestelde temperatuur door naast de bijbehorende kleur te staan: rood, oranje of groen.

C - Rood Hoger verbruik	Temperatuur > 22°C		
B - Oranje Gemiddelde verbruik	19°C < Temperatuur ≤ 22°C		
A - Groen Lager verbruik	Temperatuur ≤ 19°C		

- Weergave van het geraamde stroomverbruik in kWh**

Om het verbruik te zien drukt u in Auto-, Comfort-, Eco- of Vorstbeveiligingsmodus op de knop **OK**.

Om het scherm met het stroomverbruik te verlaten drukt u op gelijk welke knop en de regeling keert automatisch terug naar de vorige gebruiksmodus.

- De energiemeter resetten**

Om de energiemeter te resetten gaat u vanuit Auto-, Comfort-, Eco- of Vorstbeveiligingsmodus als volgt te werk:

1- Druk op **OK**.

2- Druk gelijktijdig op **-** en **+** gedurende meer dan 5 seconden. Om de reset van de energiemeter te verlaten drukt u op gelijk welke knop en de regeling keert automatisch terug naar de vorige gebruiksmodus.



TOETSENBORD VERGRENDELEN/ONTGRENDELEN

• Toetsenbord vergrendelen

Om het toetsenbord te vergrendelen houd de en toetsen gedurende 10 seconden ingedrukt. Het hangslotssymbool verschijnt op het scherm en het toetsenbord is vergrendeld.

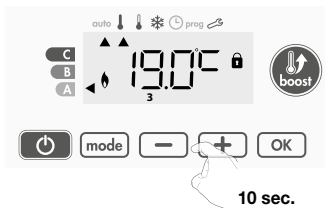

• Toetsenbord ontgrendelen

Om het toetsenbord te ontgrendelen houd opnieuw de en toetsen gedurende 10 seconden ingedrukt. Het hangslotssymbool verdwijnt van het scherm en het toetsenbord is ontgrendeld.

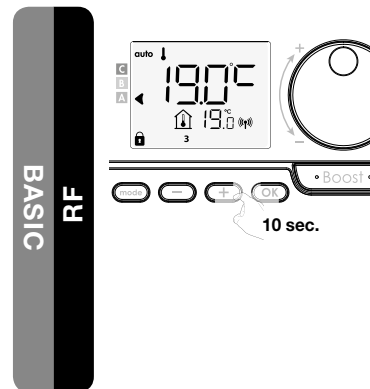

TIJD EN DAG INSTELLEN

1- Vanuit Auto-, Comfort-, Eco- of Vorstbeveiligingsmodus, druk 5 seconden op .



2- De urcijfers knipperen. Druk op of om het uur te wijzigen.

Als u de of knop ingedrukt houdt, lopen de uren snel.

Om te bewaren, druk op .

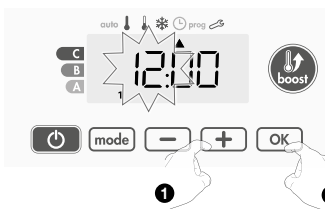

3- De minuscijfers knipperen.

Druk op of om de minuten te wijzigen.

Om te bewaren, druk op .

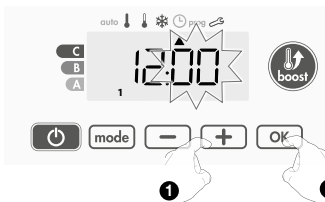

4- Nummer 1 (= maandag) knippert.

Kies de juiste datum door op en te drukken.

Om te bewaren, druk op .



Maandag	1	Vrijdag	5
Dinsdag	2	Zaterdag	6
Woensdag	3	Zondag	7
Donderdag	4		

5- Om het weekprogramma in te stellen, druk op .

Om de instelling van tijd en dag te verlaten, druk 3x op .

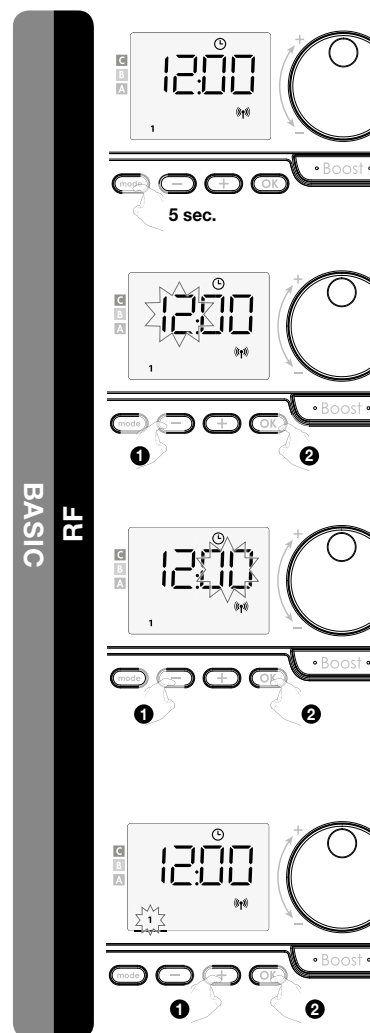

OVERZICHT VAN DE PROGRAMMA'S

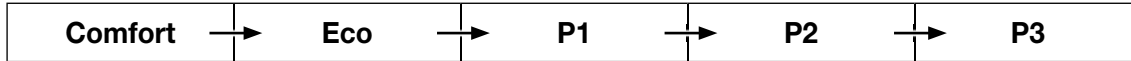

Standaard is de regeling ingesteld in Comfortmodus gedurende de hele week.

- **Comfort:** de regeling werkt in Comfortmodus, 24 uur per dag, voor elke geselecteerde dag.
- **Eco:** de regeling werkt 24 uur per dag in Ecomodus.
- **Opmerking:** u kunt de temperatuurverlagende parameters instellen, zie gebruikersinstellingen
- **P1:** de regeling werkt in Comfortmodus gedurende één tijdsblok bv. van 6 uur tot 22 uur (en in Ecomodus van 22 uur tot 6 uur).
- **P2:** de regeling werkt in Comfortmodus gedurende 2 tijdsblokken bv. van 6 uur tot 9 uur, en van 16 uur tot 22 uur (en in Ecomodus van 9 uur tot 16 uur, en van 22 uur tot 6 uur).
- **P3:** de regeling werkt in Comfortmodus gedurende 3 tijdsblokken bv. van 6 uur tot 8 uur, van 12 uur tot 14 uur, en van 18 uur tot 23 uur (en in Ecomodus van 23 uur tot 6 uur, van 8 uur tot 12 uur, en van 14 uur tot 18 uur).

⚠ Opmerking: wanneer de standaard tijden van P1, P2 en P3 u niet passen, dan kunt u deze wijzigen, maar dan geldt deze tijd voor alle dagen van de week waarop P1, P2 of P3 is ingesteld

WEEKPROGRAMMA INSTELLEN

1- Druk vanuit Auto-, Comfort-, Eco- of Vorst-beveiligingsmodus 5 seconden op **mode**. Wanneer de cursor boven het symbooltje voor de tijdinstelling **🕒** beweegt, drukt u kort op **mode**.

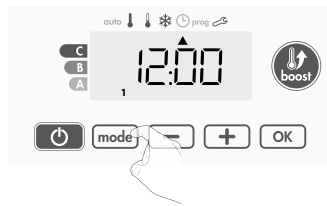

2- Druk op **+** of **-** om het weekprogramma in te stellen.

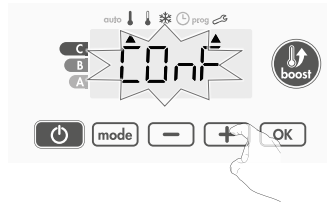

3- Selecteer met **+** of **-** het gewenste programma. Indien gewenst kunnen de standaard tijden aangepast worden: druk hiervoor minstens 5 sec op **OK**.

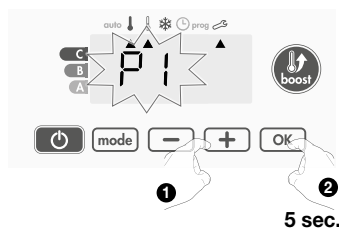

Indien de standaard tijden van toepassing zijn: druk op **OK** om de volgende dag in te stellen (ga naar stap 4)

3.1- De starttijd knippert en met **+** of **-** kan u dit tijdstip met intervallen van telkens 30 min wijzigen.

Druk op **OK** om te bewaren.



3.2- De eindtijd knippert en met **+** of **-** kan u dit tijdstip met intervallen van telkens 30 min wijzigen.

Druk op **OK** om te bewaren.

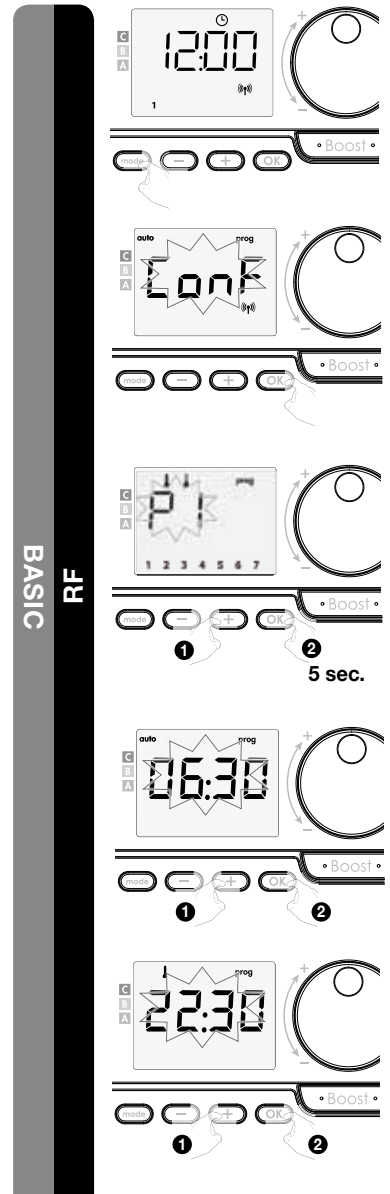
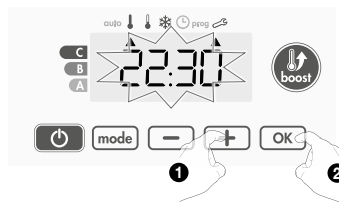

- 4- De tweede dag (dinsdag) knippert.
Herhaal de procedure die hiervoor beschreven werd voor elke dag van de week.

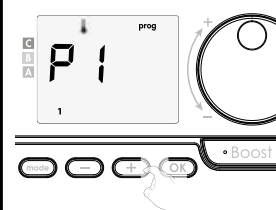
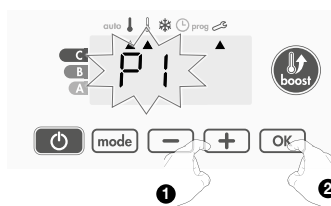

- 5- Zodra u voor elke dag een programma hebt gekozen, bevestigt u uw selectie door op **OK** te drukken. De dagen van de week verschijnen op het scherm met de programma's die u ervoor hebt ingesteld. Druk twee keer op **mode** om de programmeringsmodus te verlaten en terug te keren naar de "Automodus". Als er een paar minuten op geen enkele knop wordt gedrukt, keert de regeling automatisch terug naar de "Automodus".

WEEKPROGRAMMA BEKIJKEN

Vanuit Auto-, Comfort-, Eco- of Vorstbeveiligingsmodus, druk gedurende 5 seconden op **mode**. Druk 2x op **mode** om het programma van elke weekdag (Comfort, Eco, P1, P2 of P3) te zien.

Druk 2x op **mode** om het overzicht te verlaten.

WEEKPROGRAMMA TIJDELIJK OVERSCHRIJVEN

Met deze functie kunt u de ingestelde temperatuur tijdelijk wijzigen tot de volgende geprogrammeerde temperatuurwijziging of de verandering naar de volgende dag.

Bijvoorbeeld:

- 1- De regeling werkt in Automodus, het actieve programma is Eco 15,5°C.
- 2- Door op **-** of **+** te drukken, kunt u tijdelijk de gewenste temperatuur veranderen naar bijvoorbeeld 18°C.
- 3- Deze temperatuursverandering wordt automatisch gewist bij de volgende programawijziging of verandering naar de volgende dag.

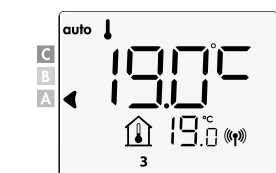
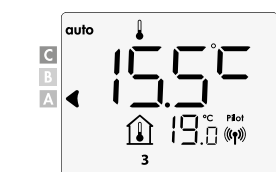
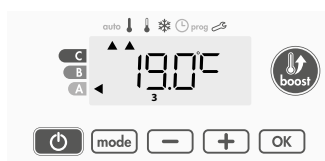
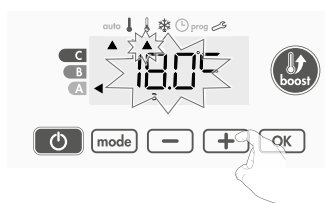
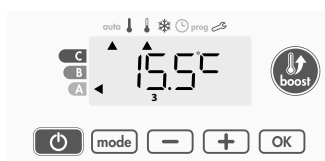

OPENRAAMDTECTIE

De openraamdetectie is gevoelig voor temperatuurschommelingen. De regeling reageert op open ramen volgens diverse parameters: temperatuurinstelling, stijging en daling van de temperatuur in de ruimte, buitentemperatuur, plaats van de regeling, enz. Als de regeling dicht bij een voordeur staat, kan de detectie verstoord worden door de lucht bij het openen van de deur. Als dit een probleem is, raden wij u aan om de openraamdetectie uit te schakelen (zie installateursinstellingen).

Wanneer de regeling overgaat tot een temperatuur-verlagingscyclus door het openen van een raam, verschijnt een vorstbeveiligingsteller in het display om de duur van de cyclus weer te geven. De teller wordt automatisch op nul gezet wanneer de vorstbeveiliging de volgende keer wordt ingeschakeld.

Door op een knop te drukken, wordt de Vorstbeveiligingsmodus gedeactiveerd.

Opmerking: als een temperatuurstijging waargenomen wordt, zal de regeling automatisch terugkeren naar de vorige modus.

GEBRUIKERSINSTELLINGEN

TOEGANG TOT DE INSTELLINGEN

Vanaf de modus Auto, Comfort, Eco of Vorstbeveiliging:

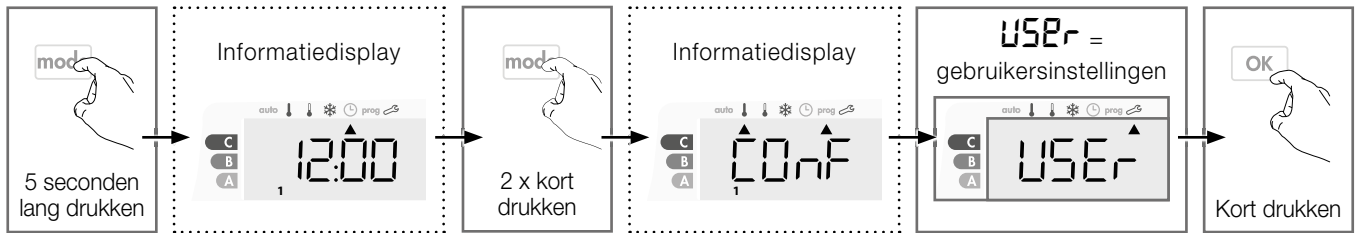

Volgorde van de instellingen:

Achtergrondverlichting → Eco-temperatuursverlaging → Vorstbeveiligingstemperatuur → Boven- en ondergrens Comfort-temperatuur → Maximale Boost-duur → Maximale Boost-temperatuur → Temperatureenheid → Resetten van de fabrieksinstellingen

ACHTERGRONDVERLICHTING

1- Er zijn drie opties beschikbaar:

- L1 = achtergrondverlichting met timer: het display gaat branden met een druk op een knop.
- L2 = permanente achtergrondverlichting: het display blijft branden.
- L3 = idem als modus L1.

Optie L3 is standaard ingesteld.

Druk op **+** of **-** om de gewenste modus te selecteren.

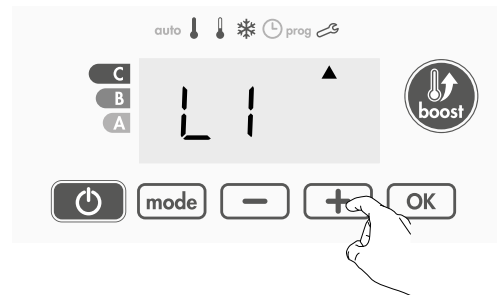

2- Om te bevestigen en over te gaan tot de volgende instelling, druk op **OK**.

Om te bevestigen en de instellingen te verlaten, druk 2x op **mode**.

ECO-TEMPERATUURSVERLAGING

De daling is vooraf ingesteld op 3,5 °C vergeleken met de ingestelde Comfort-temperatuur. U kunt dit wijzigen tussen -1 °C en - 8 °C in stappen van 0,5 °C.

Belangrijk: Ongeacht de ingestelde verlaging zal de Eco-temperatuur nooit 19 °C overschrijden.

1- Druk op **-** of **+** om de gewenste waarde weer te geven.

2- Om te bevestigen en over te gaan tot de volgende instelling, druk op **OK**.

Om te bevestigen en de instellingen te verlaten, druk 2x op **mode**.

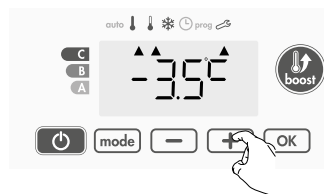

VORSTBEVEILIGINGSTEMPERATUUR

Is vooraf ingesteld op 7 °C, u kunt de Vorstbeveiligings-temperatuur wijzigen van 5 °C tot 15 °C in stappen van 0,5 °C.

1- Druk op **-** of **+** om de gewenste waarde weer te geven.

2- Om te bevestigen en over te gaan tot de volgende instelling, druk op **OK**. Om te bevestigen en de instellingen te verlaten, druk 2x op **mode**.

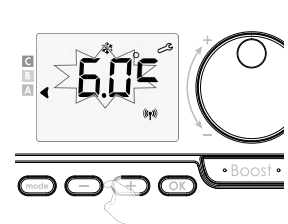
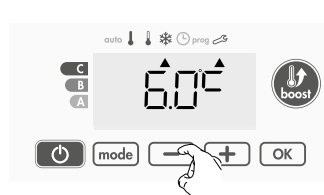

BOVEN- EN ONDERGRENS COMFORT-TEMPERATUUR

• Ondergrens

Het minimum is vooraf ingesteld op 7 °C. U kunt dit wijzigen tussen 7 °C en 15 °C in stappen van 1 °C.

- 1- Om het minimum in te stellen, druk op **-** of **+** en bevestig dan met een druk op **OK**.

Als u geen wijziging wilt uitvoeren, druk op **OK**, de regeling stelt u automatisch voor om een maximum in te stellen. Om te bevestigen en de instellingen te verlaten, druk 2x op **mode**.

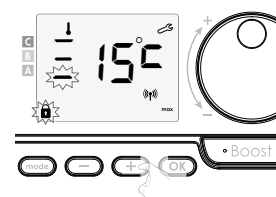
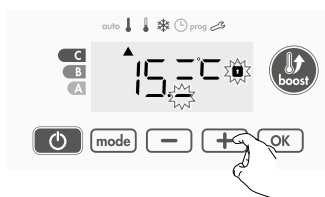

• Bovengrens

Het maximum is vooraf ingesteld op 30 °C. U kunt dit wijzigen tussen 19 °C en 30 °C in stappen van 1 °C.

- 2- Om de ingestelde maximale temperatuur te wijzigen druk op **-** of **+**.

Druk op **OK** om te bevestigen en de volgende instelling uit te voeren. Om te bevestigen en de instellingen te verlaten, druk 2x op **mode**.

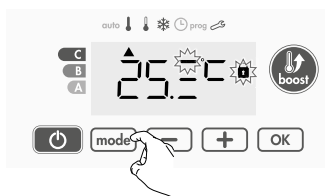

MAXIMALE BOOST-DUUR

De maximale Boost-duur is vooraf ingesteld op 60 minuten. U kunt dit wijzigen tussen 30 en 90 minuten in stappen van 30 minuten.

- 1- Het Boost-symbool en de verwarmingsindicator verschijnen op het display en de ingestelde duur van 60 minuten knippert
- 2- Druk op **-** of **+** om de gewenste duur weer te wijzigen.
- 3- Om te bevestigen en over te gaan tot de volgende instelling, druk op **OK**. Om te bevestigen en de instellingen te verlaten, druk 2x op **mode**.

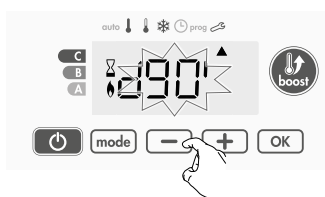
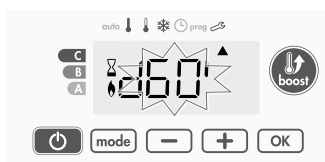

MAXIMALE BOOST-TEMPERATUUR

De Boost stopt indien de maximale Boost-temperatuur bereikt is.

Het maximum is vooraf ingesteld op 35 °C u kunt dit wijzigen tussen 25 °C en 39 °C in stappen van 1 °C.

- 1- Het Boost-symbool en de verwarmingsindicator verschijnen op het display en de maximum-temperatuur knippert
- 2- U kunt de maximale Boost-temperatuur instellen door herhaald te drukken op **-** of **+** met stappen van 1 °C, tot 39 °C.
- 3- Om te bevestigen en over te gaan tot de volgende instelling, druk op **OK**. Om te bevestigen en de instellingen te verlaten, druk 2x op **mode**.

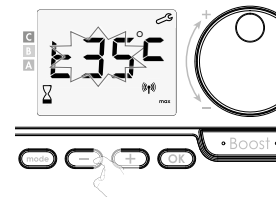
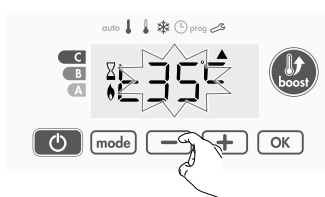

TEMPERATUUREENHEID

De temperatuureenheid is standaard Graden Celsius.

- 1- Druk op **-** of **+** om de temperatuureenheid te wijzigen.
- 2- Om te bevestigen en automatisch over te gaan tot de volgende instelling, druk op **OK**.
Om de instellingen te verlaten, druk 2x op **mode**.

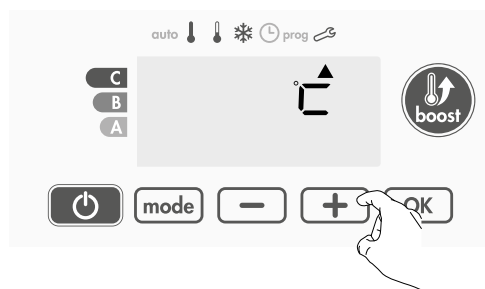

RESETTEN VAN DE FABRIEKINSTELLINGEN

- 1- **rest** verschijnt gedurende 1 seconde.

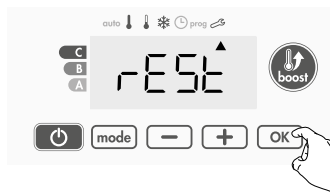

- 2- **no** knippert. Druk op **-** of **+** om **yes** te selecteren.

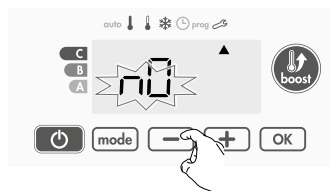

- 3- Druk gedurende 5 seconden op **OK**.
De instellingen worden gereset en de regeling keert automatisch naar de Auto-modus terug.

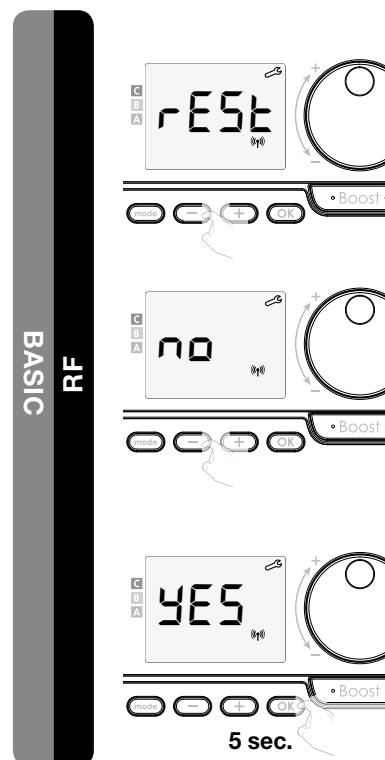
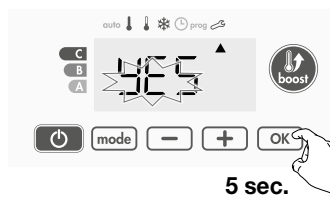

Algemeen

Comfort-temperatuur	19 °C
Maximale Boost-duur	60 min.
Toetsenblokkering	Gedeactiveerd

Gebruikersinstellingen

Achtergrondverlichting	L3	BASIC
Eco-temperatuurverlaging	-3,5 °C	
Vorstbeveiligingstemperatuur	7 °C	
Ondergrens Comfort-temperatuur	7 °C	
Bovengrens Comfort-temperatuur	30 °C	
Maximale Boost-duur	60 min.	
Maximale Boost-temperatuur	35 °C	
Temperatuureenheid	°C	

Druk 2x op **mode** om de instellingen te verlaten

INSTALLATEURSINSTELLINGEN

TOEGANG TOT DE INSTELLINGEN

Vanaf de modus Auto, Comfort, Eco of Vorstbeveiliging:

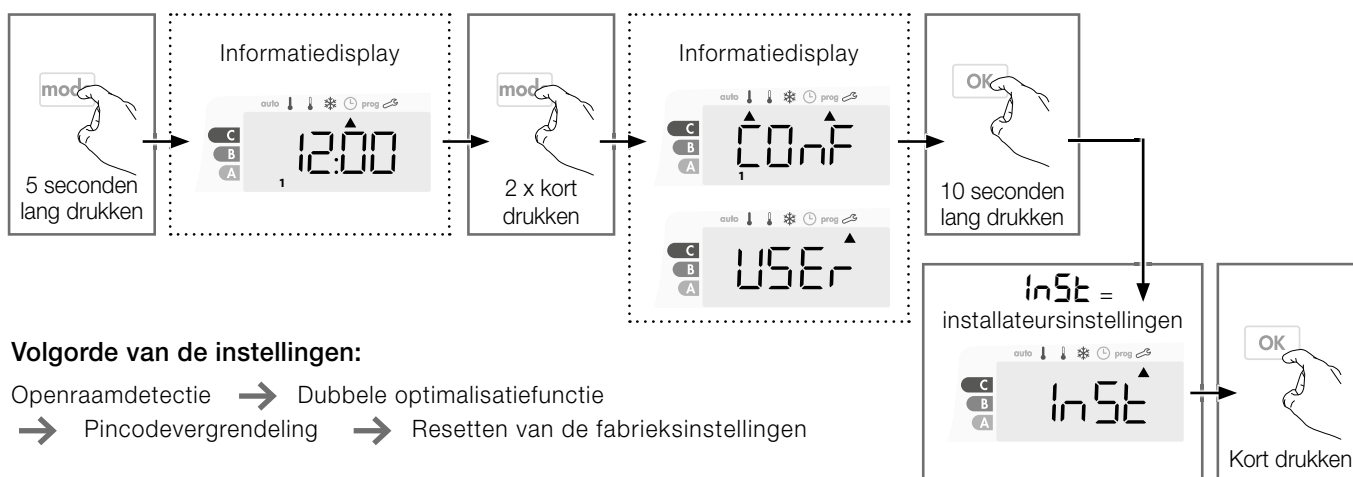

Volgorde van de instellingen:

- Openraamdetectie → Dubbele optimalisatiefunctie
- Pincodevergrendeling → Resetten van de fabrieksinstellingen

OPENRAAMDTECTIE

1- De openraamdetectie is standaard geactiveerd.

2- Druk op **-** of **+**.

- On** = openraamdetectie geactiveerd.
- OFF** = openraamdetectie gedeactiveerd.

3- Druk op **OK** om te bevestigen en de volgende instelling te openen. Om te bevestigen en de instellingen te verlaten, druk 3 keer op **mode**.

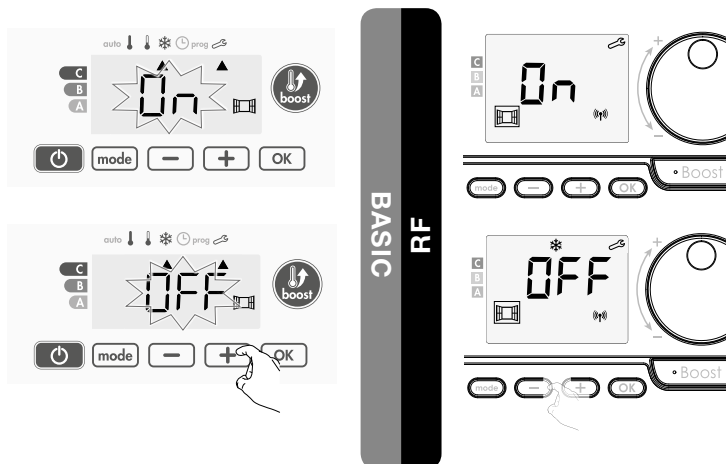

OPTIMALISATIEFUNCTIE

- In de modus **OPTI ECO (energie-efficiëntie)** berekent de regeling het beste compromis om maximale energiebesparing te garanderen tijdens de geprogrammeerde opwarmings- en afkoelingsfasen. Een lichte daling van het temperatuurniveau aan het begin en einde van de comfortperiode is toegestaan om de energiebesparing te maximaliseren.

- In de modus **OPTI COMFORT (comfort efficiëntie)** berekent de regeling het beste compromis om maximaal comfort te garanderen tijdens de geprogrammeerde opwarmings- en afkoelingsfasen. Er wordt voorrang gegeven aan het anticiperen op en het handhaven van de comforttemperatuur tijdens comfortperioden.

De modus **OPTI COMFORT** is standaard geactiveerd. Het woord **OP:/** verschijnt kort op het display en wisselt vervolgens af met de ingestelde modus **ConF**, **ECO** of **OFF**.

1- Druk op **-** of **+**.

- ConF** = optimalisatiefunctie geactiveerd voor de modus **OPTI COMFORT**, prioriteit voor comfort efficiëntie
- ECO** = optimalisatiefunctie geactiveerd voor de modus **OPTI ECO**, prioriteit voor energie-efficiëntie.
- OFF** = optimalisatiefunctie gedeactiveerd.

2- Druk op **OK** om te bewaren en naar de volgende instelling te gaan. Druk drie keer op **mode** om de instellingen te verlaten.

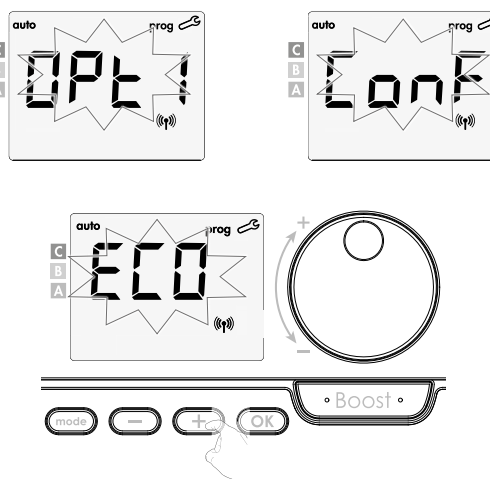

PINCODEVERGREDELING

• Uitleg

De 4 cijferige pincode kan u zelf instellen die, wanneer geactiveerd, de volgende functies onbeschikbaar maakt:

- Selecteren van de Comfort-modus: alleen de modi Auto, Eco en Vorstbeveiliging zijn beschikbaar.
- Instellen van de Comfort-, Eco- en Vorstbeveiligingstemperatuur.
- Wijzigen van het weekprogramma.
- Instellen van de openraamdetectie.

Wanneer de pincodebeveiliging voor de eerste keer wordt gebruikt, moet u volgende stappen volgen:

- 1- Initialiseren van de pincode; de standaardpincode (0000) invoeren om de functie te kunnen gebruiken.
- 2- Activeren van de pincode om de instellingen te blokkeren die met de pincode worden beveiligd.
- 3- Personaliseren van de pincode, (0000) de pincode vervangen door een persoonlijke code van vier cijfers.

• Standaard Pincode instellen = '0000'

Standaard is de pincode niet geactiveerd = OFF

- 1- De pincode is standaard 0000.
Met **-** of **+** selecteert u het getal 0. Het getal knippert, valideer het met een druk op **OK**.

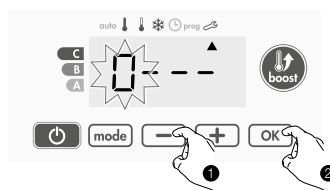

- 2- Selecteer voor de overige cijfers het getal 0 met een druk op **OK**.
Wanneer 0000 verschijnt, druk dan opnieuw op **OK** om te bevestigen.

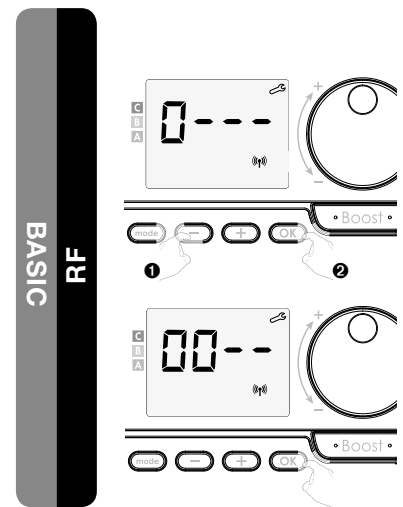
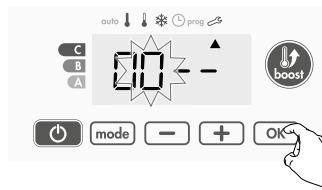

De pincode is geïnitieerd, de regeling stelt automatisch de volgende instelling voor: activering van de pincode.

• Activering/deactivering van de pincode

- 1- **OFF** verschijnt in het display.
Druk op **-** of **+** om de pincode te activeren.
On = pincode geactiveerd
OFF = pincode gedeactiveerd

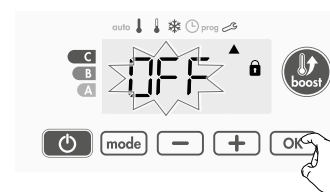

- 2- Druk op **OK** om te bevestigen en de volgende instelling uit te voeren.

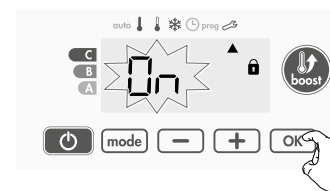

De pincode is nu geactiveerd. U kunt geen van de instellingen uit de lijst 'Uitleg' uitvoeren.

• Pincode personaliseren

- 1- Wanneer **On** verschijnt, druk dan gedurende minstens 5 seconden op **OK**.

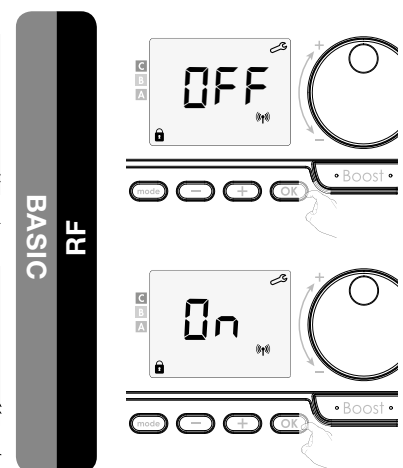
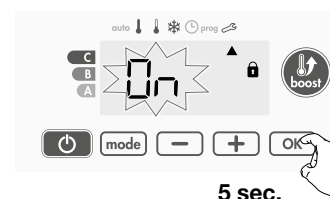

2- De code 0000 verschijnt en het 1ste cijfer knippert. Selecteer met **-** of **+** het gewenste cijfer en druk dan op **OK** om te bevestigen. Doe hetzelfde voor de andere 3 cijfers.

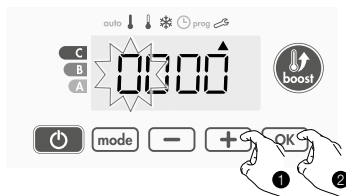

3- Druk op **OK** om te bevestigen. De nieuwe code is nu geregistreerd.

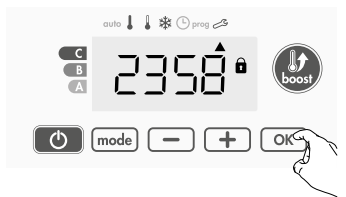

4- Druk andermaal op **OK** om de instelling van de pincode te verlaten en terug te keren naar de start van de installateursinstellingen.

Druk 3x op **mode** om de instellingen te verlaten

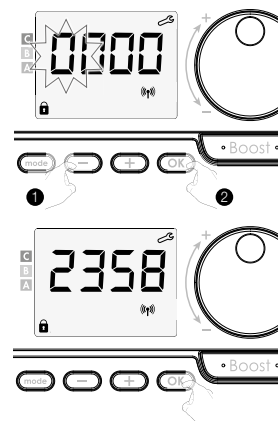

RESETTEN VAN DE FABRIEKINSTELLINGEN

Als de pincodebeveiliging gedeactiveerd is, kunt u de gebruikers- en installateursinstellingen naar hun beginwaarde terugzetten.

1- **reset** verschijnt.



2- **no** knippert.

Druk op **-** of **+** om **yes** te selecteren.

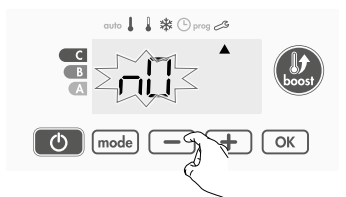

3- Druk gedurende 5 seconden op **OK**.

De instellingen worden gereset en de regeling keert automatisch naar de Auto-modus terug.

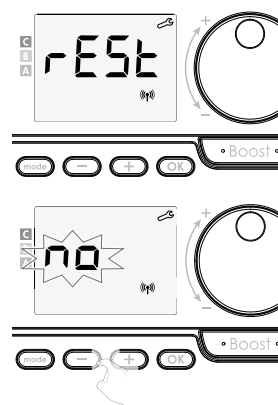

Algemeen

Comfort-temperatuur	19 °C
Maximale Boost-duur	60 min.
Toetsenblokkering	Gedeactiveerd

Gebruikersinstellingen

Achtergrondverlichting	L3	BASIC
Eco-temperatuurverlaging	-3,5 °C	
Vorstbeveiligingstemperatuur	7 °C	
Ondergrens Comfort-temperatuur	7 °C	
Bovengrens Comfort-temperatuur	30 °C	
Maximale Boost-duur	60 min.	
Maximale Boost-temperatuur	35 °C	
Temperatuureenheid	°C	

Installateursinstellingen

Openraamdetectie	Geactiveerd
Optimalisatiefunctie	Optie comfort RF
Pincodevergrendeling	Gedeactiveerd
Pincode	0000

Druk 3x op **mode** om de instellingen te verlaten

GEAVANCEERDE INSTALLATEURSINSTELLINGEN

TOEGANG TOT DE INSTELLINGEN

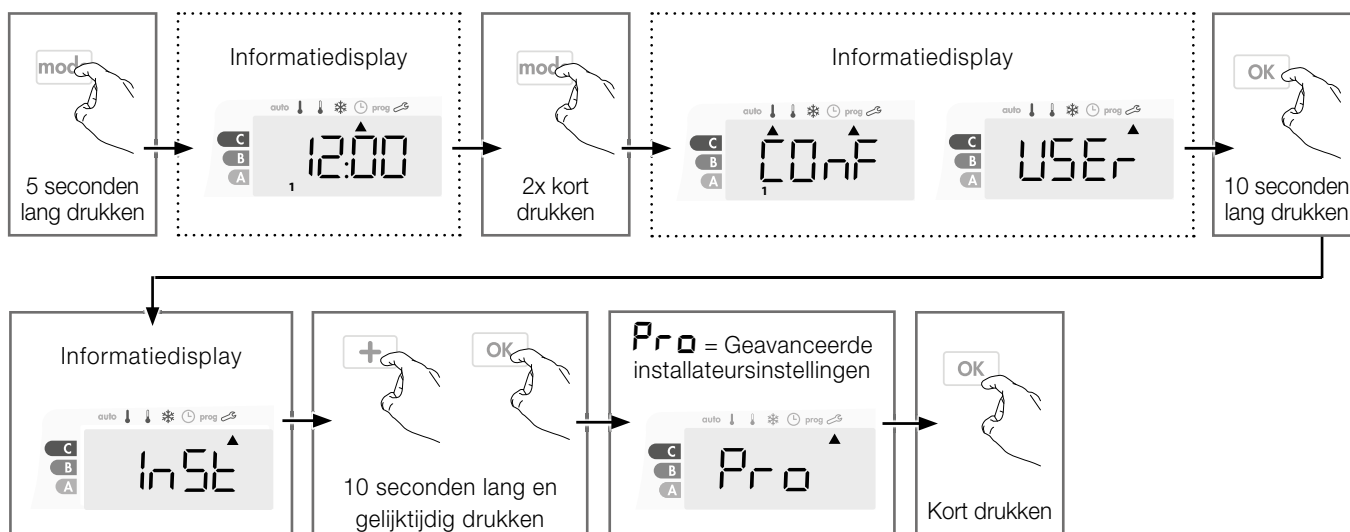

Volgorde van de instellingen:

Kalibratie temperatuursensor → Radiatorvermogen → Resetten van de fabrieksinstellingen

KALIBRATIE TEMPERATUURSENSOR

• Overzicht

! Deze handeling mag alleen door professionele installateurs uitgevoerd worden. Verkeerde wijzigingen kunnen leiden tot storingen in de regeling.

De kalibratie past de temperatuur die door de omgevings-temperatuursensor wordt gemeten aan, om een afwijking van + 5 °C tot - 5 °C met intervallen van 0,1 °C te compenseren.

De kalibratie kan voor elke gekoppelde regeling worden uitgevoerd. Afhankelijk van het aantal regelingen begint u met het instellen van de kalibratie van de eerste regeling, vervolgens voor de tweede, tot de laatste regeling. U kunt het regelingnummer identificeren wanneer u de kalibratie op het display instelt.



• Kalibratie

1- Als het kamertemperatuurverschil negatief is, bijvoorbeeld:

Insteltemperatuur (wat u wilt) = 20 °C.

Omgevingstemperatuur (wat u op een betrouwbare thermometer afleest) = 18 °C.

Gemeten verschil = -2 °C.

! We raden aan om de kalibratie pas uit te voeren 4 uur nadat u de insteltemperatuur hebt gewijzigd, om er zeker van te zijn dat de omgevingstemperatuur gestabiliseerd is.

Om de aanpassing door te voeren, gaat u als volgt te werk: Sensortemperatuur = 24 °C

Verlaag de temperatuur die door de omgevingstemperatuur-sensor gemeten wordt met 2 °C door op te drukken.

Om de nieuwe waarde te bevestigen, druk op , om de instellingen te verlaten drukt u 3 keer op .



2- Als het kamertemperatuurverschil positief is, bijvoorbeeld:

Insteltemperatuur (wat u wilt) = 19 °C.

Omgevingstemperatuur (wat u op een betrouwbare thermometer afleest) = 21 °C.

Gemeten verschil = +2 °C.

Om de aanpassing door te voeren, gaat u als volgt te werk: Sensor temperatuur = 21 °C

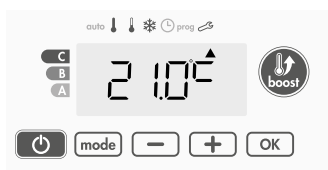

Verhoog de temperatuur die door de omgevings-temperatuur-sensor gemeten wordt met 2 °C door op **+** te drukken.



Om de nieuwe waarde te bevestigen, drukt u op **OK**. Om de instellingen te verlaten, drukt u 3 keer op **mode**.

• Resetten van de sensorkalibratie

1- Wanneer de temperatuur gemeten door de sensor verschijnt, druk **-** of **+** gedurende minstens 3 seconden.

2- Om op te slaan en automatisch naar de volgende instelling te gaan, drukt u op **OK**.

Om de instellingen te verlaten, drukt u 3 keer op **mode**.



RADIATORVERMOGEN

Om een correcte werking van de radiator te garanderen en om het energieverbruik correct te kunnen inschatten, is het essentieel om het vermogen van de radiator in te stellen.

BASIC: bij de eerste ingebruikname dient deze instelling uitgevoerd te worden.

RF: tijdens de RF koppeling komt deze instelling automatisch aan bod.

1- Selecteer het vermogen van de radiator door op **+** of **-** te drukken.

2- Om op te slaan en automatisch naar de volgende instelling te gaan, drukt u op **OK**.

Om de instellingen te verlaten, drukt u 3 keer op **mode**.

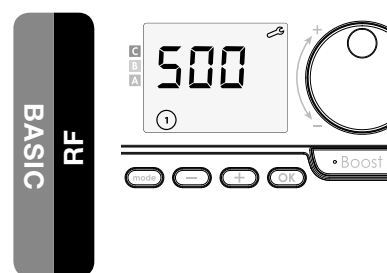

RESETTEN VAN DE FABRIEKINSTELLINGEN

Als de pincodebeveiliging is uitgeschakeld, kunnen de gebruikersinstellingen, de installateursinstellingen en de geavanceerde installateursinstellingen gereset worden:

1- **RESET** verschijnt op het display.

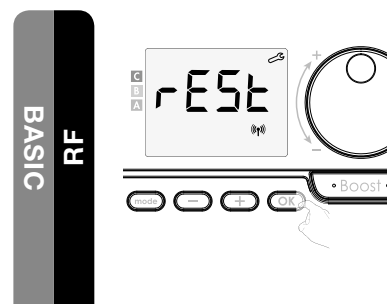
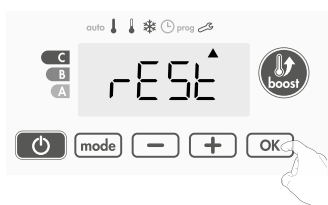

2- **no** verschijnt. Druk op **-** of **+** om **YES** te selecteren.

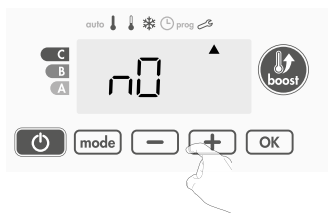

3- Druk 5 seconden lang op de toets **OK** .
De instellingen worden gereset en de regeling keert automatisch naar de Auto-modus terug.

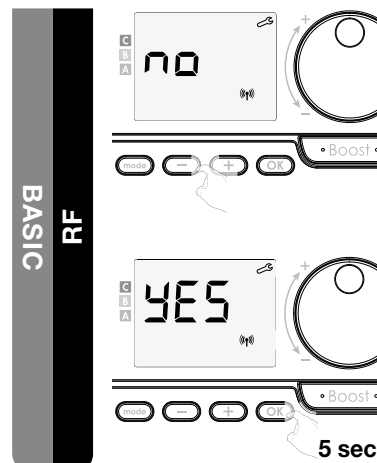
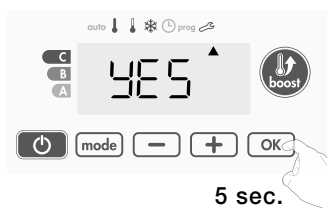

Algemeen

Comforttemperatuur	19°C
Maximale Boost-duur	60 min.
Toetsenblokkering	Gedeactiveerd

Gebruikersinstellingen

Achtergrondverlichting	L3	BASIC
Eco-temperatuurverlaging	-3,5°C	
Vorstbeveiligingstemperatuur	7°C	
Ondergrens Comforttemperatuur	7°C	
Bovengrens Comforttemperatuur	30°C	
Maximale Boost-duur	60 min.	
Maximale Boost-temperatuur	35°C	
Temperatuureenheid	°C	

Installateursinstellingen

Openraamdetectie	Geactiveerd
Optimalisatiefunctie	Optie Comfort RF
Pincode vergrendeling	Gedeactiveerd
Pincode	0000

Geavanceerde installateursinstellingen

Kalibratie temperatuursensor	0,0
Radiatorvermogen	500W

Om de instellingen te verlaten, drukt u 3 keer op **mode** .

CONSIGNES DE SÉCURITÉ



Cet appareil ne peut pas être utilisé par des personnes (dont des enfants) présentant des capacités physiques, sensorielles ou mentales réduites ou un manque d'expérience ou de connaissance, à moins qu'elles soient supervisées ou que des instructions leur aient été fournies.



Interdiction aux enfants de jouer avec l'appareil, même sous surveillance.

Le radiateur ne doit en aucun cas être recouvert et ne doit pas être monté sous une prise de courant.

Le radiateur doit pouvoir être éteint à tout moment. En cas de branchement par fiche, cela doit être possible au moyen d'un interrupteur externe. En cas de connexion fixe filaire, le circuit électrique doit être correctement protégé.

Lors du montage du radiateur, veuillez respecter les règles locales/nationales en matière d'installation électrique ainsi que nos conditions générales.

MISE AU REBUT CONFORMÉMENT À LA DIRECTIVE DEEE (2012/19/EU)



Le symbole figurant sur la plaque signalétique du radiateur indique que le radiateur ne peut pas être considéré comme un déchet ménager, mais qu'il doit être trié. Lorsque le radiateur est arrivé en fin de vie, il doit être amené dans un centre de collecte d'équipements électriques et électroniques. Pour en savoir plus sur les centres de recyclage et de collecte, veuillez contacter les autorités locales/votre commune ou le service de collecte des déchets. Ceci s'applique aux pays dans lesquels ladite directive est entrée en vigueur.

SPÉCIFICATIONS TECHNIQUES

- Tension d'alimentation : 230 VCA 50 Hz
- Puissance maximale de 1500 W, charge résistive
- Câble d'alimentation de classe II, 800 mm, 3 conducteurs.
- Le "Fil Pilote Noir" est protégé par un manchon. Retirez le manchon pour connecter le fil pilote si nécessaire (seulement pour la France).
- Si le câble d'alimentation est endommagé, veuillez contacter votre installateur.
- Consommation en veille : < 0,5 W
- Contrôle PID (Proportional Integral Derivative) électronique, déclenché par un relais-triac
- IPX4
- Classe II, après installation sous la responsabilité de l'installateur (conformément à la norme EN60335-1)

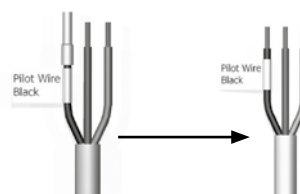

Le "Fil Pilote Noir" est protégé par un manchon. Retirez le manchon pour connecter le fil pilote si nécessaire (seulement pour la France).

Si le câble d'alimentation est endommagé, veuillez contacter votre installateur.



- Classe II, après installation sous la responsabilité de l'installateur (conformément à la norme EN60335-1)

DÉCLARATION DU CONSTRUCTEUR



Nous déclarons entièrement sous notre responsabilité que les produits présentés dans ce dépliant portent le marquage CE et satisfont à toutes les exigences essentielles des directives et normes harmonisées suivantes :

- LVD 2014/35/UE : EN60335-1/EN60335-2-30/EN60335-2-43/EN62333 ;
- CEM 2014/30/UE : EN55014-1/EN55014-2-30/EN61000-3-2/EN61000-3-3 ;
- ErP 2009/125/CE ;
- RoHS 2011/65/UE : EN50581 ;

et qu'ils sont fabriqués selon les processus certifiés ISO 9001 V2015.

Cet appareil est conforme à la directive européenne ECO Design 2015/188.

Exigences en termes d'information pour les appareils électriques destinés au chauffage décentralisé			
Caractéristique	Symbole	Valeur	Unité
Puissance			
Puissance nominale	P nom	0,5 → 1,5	kW
Puissance minimale	P min	0,5	kW
Puissance maximale continue	P max, c	1,5	kW
Consommation électrique supplémentaire			
À puissance nominale	el max	0.000	kW
À puissance minimale	el min	0.000	kW
En veille	el sb	0.0005	kW
Type d'émission calorifique/contrôle de la température de la pièce			
Contrôle électronique de la température de la pièce + temporisateur hebdomadaire			
Autres options de contrôle			
Contrôle de la température de la pièce, avec détection de fenêtre ouverte			
Avec option de télécommande			
RF Contrôle adaptatif de l'activation			
Données de contact			
Cf. plaque signalétique sur le radiateur			

Conditions de garantie:

cf. www.vasco-group.eu

MONTAGE DE LA COMMANDE

FR

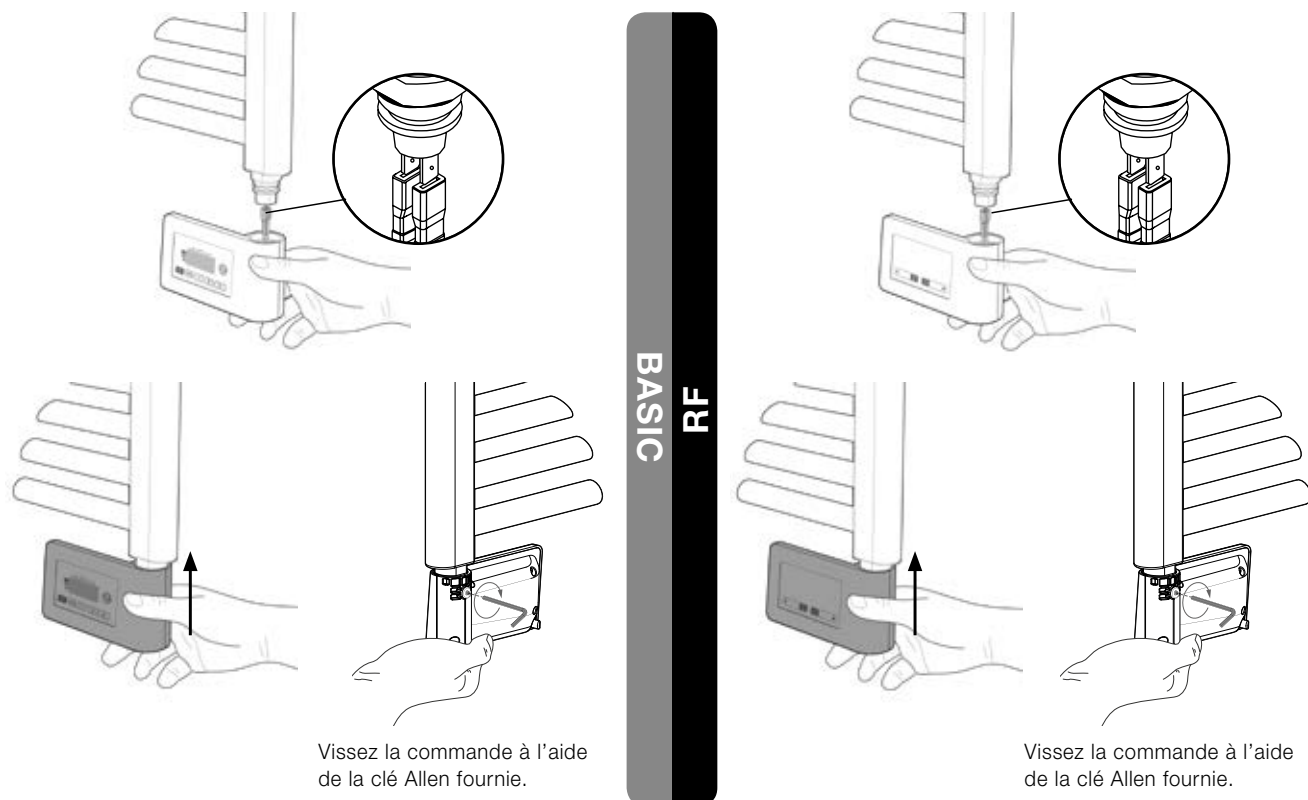

Vissez la commande à l'aide de la clé Allen fournie.

Vissez la commande à l'aide de la clé Allen fournie.

INSTALLATION DES PILES

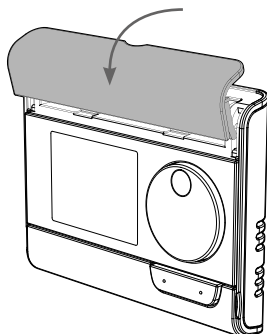

Retirez le cache des piles, situé à l'avant du thermostat.

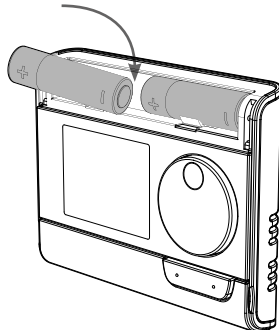

Insérez les deux piles AA fournies avec l'appareil. Lorsque vous insérez les piles, veillez à respecter la polarité indiquée par les signes gravés sur le thermostat.

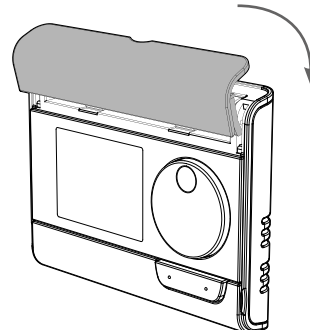

Remplacez le cache des piles.

MONTAGE DE LA TÉLÉCOMMANDE RF

Fixation au mur

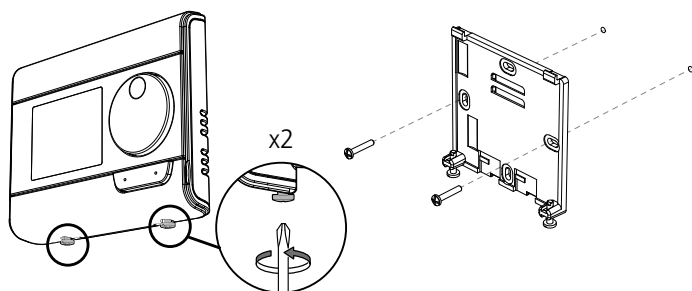

Dévissez les deux vis situées sous le thermostat.

Fixez solidement l'applique murale à l'aide des deux vis fournies avec l'appareil. Utilisez, pour ce faire, les trous horizontaux et verticaux.

Fixation sur pied

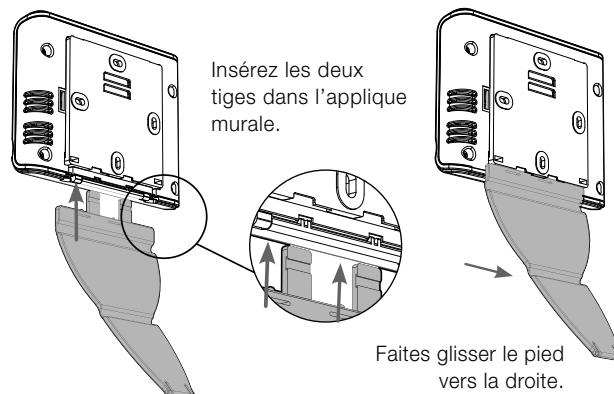

Insérez les deux tiges dans l'applique murale.

Faites glisser le pied vers la droite.



LIAISON ENTRE LE RECEPTEUR RF ET LA TELECOMMANDE RF

La télécommande RF et le récepteur RF ne sont pas couplés à l'usine. Procédez comme suit pour les coupler:



Attention: Un maximum de 5 récepteurs RF peuvent être connectés à une télécommande RF

Procédez comme suit et faites ceci par récepteur RF

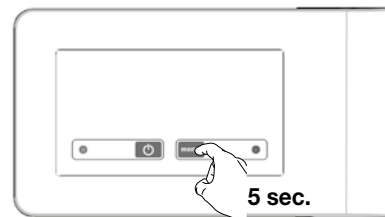

Couplage RF

1. Placez le récepteur RF en mode couplage en enfonçant le bouton  pendant 5 secondes. La LED  deviendra alors ROUGE.

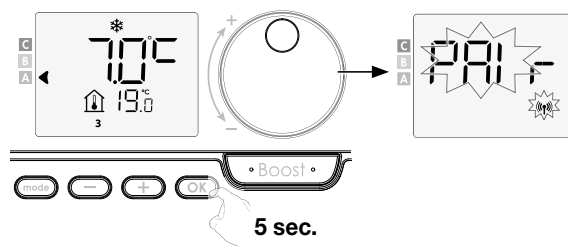

2. Placez la télécommande RF en mode Protection antigel en enfonçant le bouton  3 x et en enfonçant le bouton  pendant 5 secondes.



3. Pour assurer le bon fonctionnement du radiateur, sa puissance doit être réglée via la télécommande RF. Cette étape est automatiquement couverte lors de la liaison. La puissance est réglée à 500W en standard. Utilisez les touches  et  pour régler la puissance (voir la plaque signalétique du radiateur).

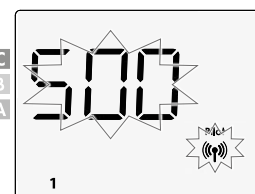

4. Lorsque la télécommande RF et le récepteur RF sont connectés, le symbole  apparaît et reste à l'écran en permanence.

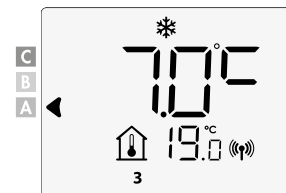

Annulation du couplage RF

Appuyez plus de 10 secondes sur le bouton Memo du récepteur RF.

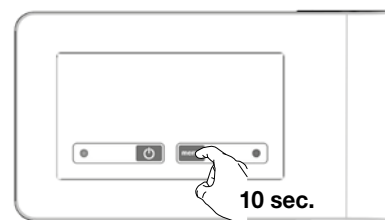

Etat du mode de fonctionnement



Communication RF d'état



Mode de fonctionnement	Statut et couleur de LED
Mode veille	Eteinte
Mode marche	Vert
Chauffage en fonction	Rouge
Boost Rouge clignotant	Rouge clignotant
Mode protection antigel, détection de fenêtre ouverte ou (seulement pour la France) un commande de Fil Pilote: mode veille / protection antigel	Vert clignotant
Commande manuelle (bouton MEMO)	Orange clignotant

Status RF communicatie	LED status en kleur
Mode veille	Eteinte
Pas de connexion RF	Rouge
Couplage RF	Rouge clignotant
Annulation du couplage RF	Clignotement rouge rapide
Connexion RF OK	Vert
Message RF reçu	1 sec clignotant vert rapide

⚠ RÉGLAGE DE LA PUISSANCE DU RADIATEUR

Pour assurer le bon fonctionnement du radiateur, sa puissance doit être réglée sur la commande. Elle est, par défaut, réglée sur 500 W.



Suivez les étapes suivantes:

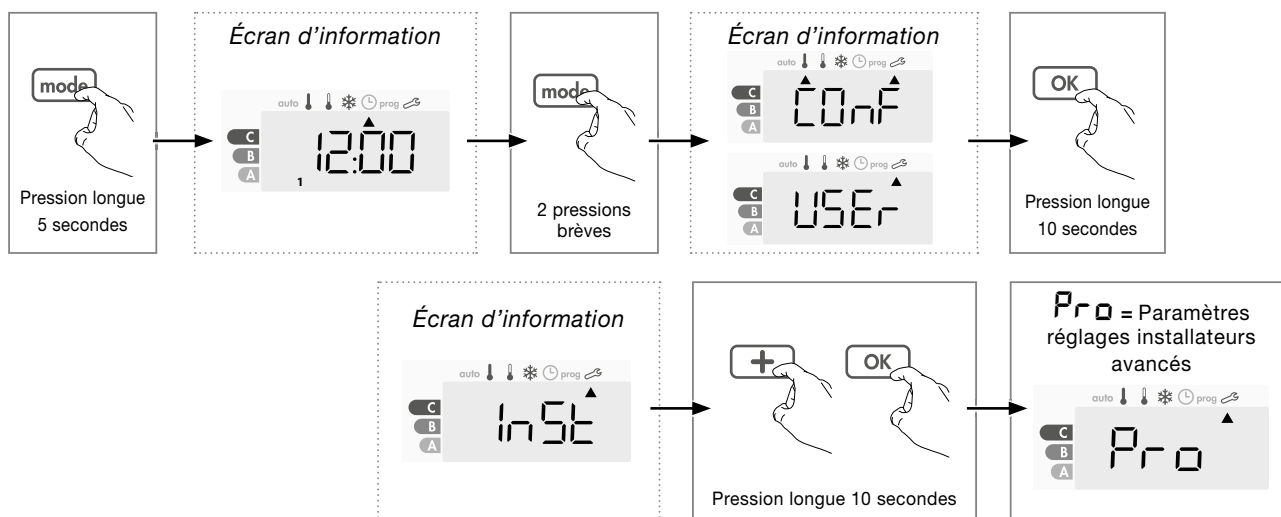

Enfoncez ensuite 2 x le bouton **OK** et réglez la puissance en utilisant les boutons **-** et **+**.

Pour sortir du menu, poussez 3 x sur le bouton **mode**.

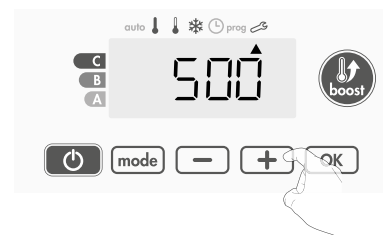

FUNCTIONNEMENT

• Aperçu des boutons

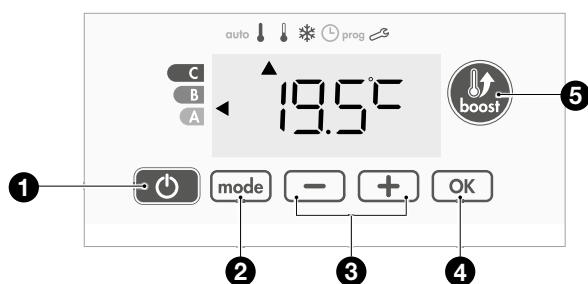

- 1 Marche/veille
- 2 Sélection des modes de fonctionnement
- 3 Bouton «moins» et «plus» servant à régler les températures et le programme hebdomadaire
- 4 Enregistrer les paramètres
- 5 Boost

• Aperçu des indicateurs

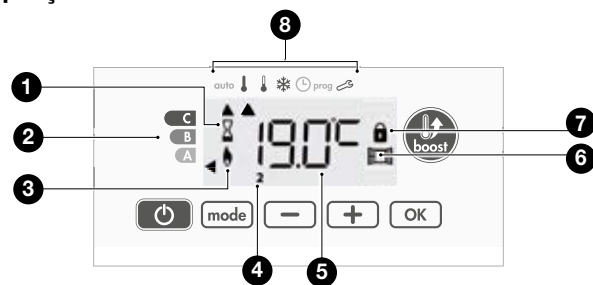

- 1 Témoin indicateur du mode Boost
- 2 Indicateur de consommation
- 3 Indicateur de chauffage
- 4 Jours de la semaine (1= lundi, ..., 7= dimanche)
- 5 Température définie
- 6 Indicateur de détection de fenêtre ouverte
- 7 Pavé numérique verrouillé

8 Modes de fonctionnement

- | | | | |
|-------------|-------------------------|-------------|--|
| auto | Mode Automatique | ⌚ | Mode de Réglage de l'heure et de la date |
| ! | Mode Confort | prog | Mode de Programmation |
| ! | Mode Économique | 🔧 | Paramètres |
| ❄ | Mode Protection Antigél | | |

FUNCTIONNEMENT

• Aperçu des boutons

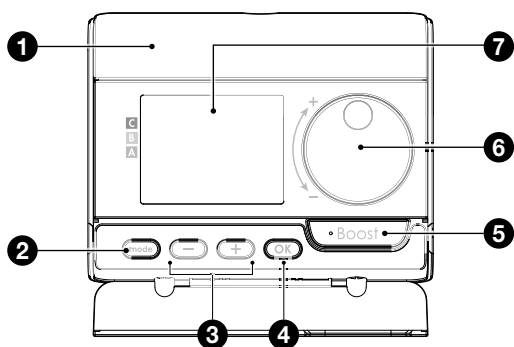

- 1 Compartiment des piles
- 2 Sélection des modes de fonctionnement
- 3 Boutons « moins » et « plus » servant à régler les températures, les heures, les dates et le programme hebdomadaire
- 4 Enregistrer les paramètres
- 5 Bouton du mode Boost
- 6 Sélectionner la température
- 7 Écran LCD

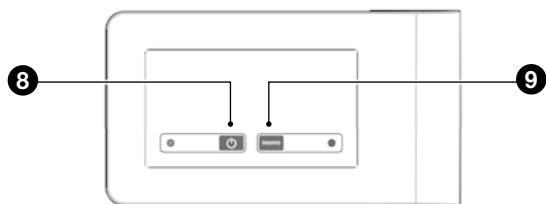

- 8 Marche/veille
- 9 Couplage RF, commande manuelle du chauffage

• Aperçu des indicateurs

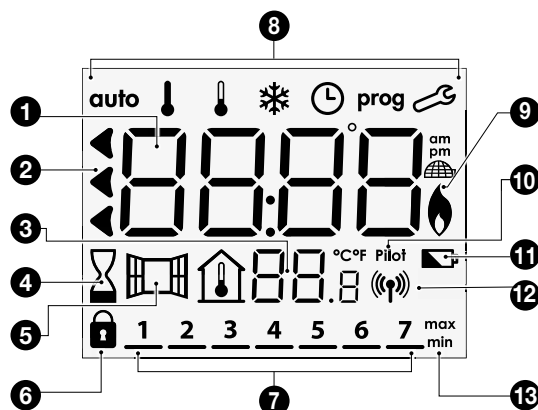

Jours de la semaine (1= lundi, ..., 7= dimanche)

- | | |
|--|--|
| 1 Consigne/informations relatives à la température | 6 Pavé numérique verrouillé |
| 2 Consommation énergétique | 9 Indicateur de chauffage |
| 3 Température ambiante mesurée | 10 Indicateur du Fil Pilote (seulement pour la France) |
| 4 Témoin indicateur du mode Boost | 11 Indicateur de batterie faible |
| 5 Indicateur de détection de fenêtre ouverte | 12 Indicateur de transmission radio |
| | 13 Indicateur de valeur min./max. |

8 Modes de fonctionnement

auto Mode Auto Mode Confort Mode Éco
 Mode Protection antigel Mode de réglage de l'heure et de la date **prog** Mode de programmation Paramètres

MODE MARCHE/VEILLE

Enfoncez le bouton pour mettre la commande en marche, en mode automatique. Appuyez à nouveau sur le bouton pour mettre la commande en veille.

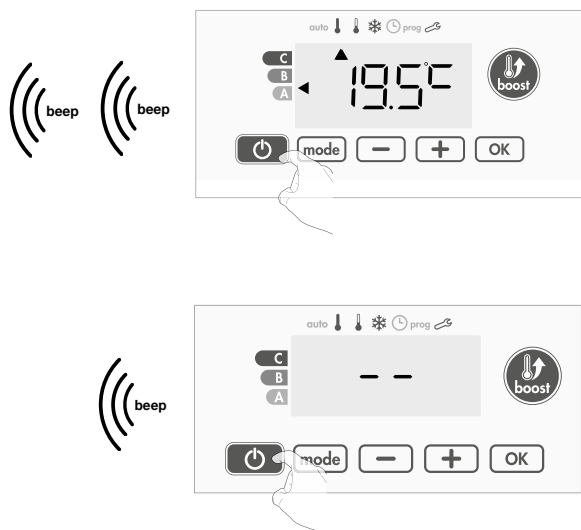

BASIC RF

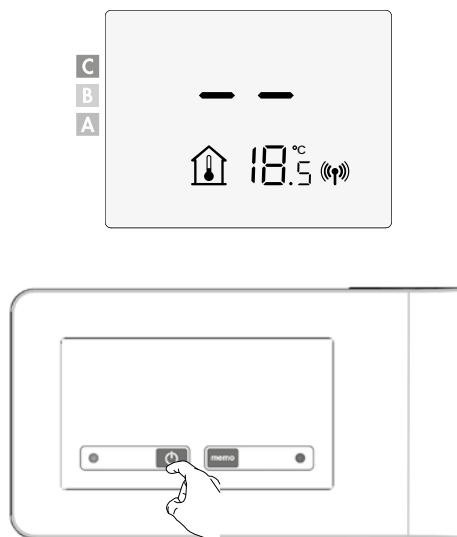

MODE DE FONCTIONNEMENT

Enfoncez le bouton  pour sélectionner le mode requis.



APERÇU DES MODES :

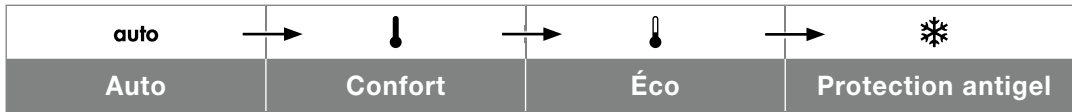

- **auto Mode automatique (3 situations)**

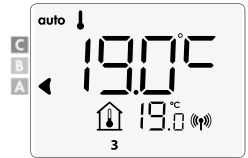

1 Programme hebdomadaire

Si un programme hebdomadaire a été défini, le radiateur basculera automatiquement entre les modes Confort et Eco.

BASIC En cas de coupure de courant de plus de 3 heures, le jour et l'heure devront être réinitialisés, le programme hebdomadaire restera en mémoire en permanence.

2 Programmation via fil pilote, seulement pour la france

Si vous ne souhaitez pas utiliser la fonction de programmation, la configuration par défaut de l'appareil est « Confort en continu, 7 jours sur 7 » et vous ne devez modifier aucun paramètre. Les commandes envoyées par le fil pilote seront uniquement exécutées en **Auto mode**. Votre appareil recevra et exécutera alors automatiquement les commandes programmées envoyées par votre régulateur de puissance ou par vos changements horaires.

3 Programme hebdomadaire non défini

Si le programme hebdomadaire n'est pas défini, le radiateur fonctionne en permanence en mode Confort.

- **Mode Confort**

Mode Confort en continu L'appareil fonctionnera 24 heures sur 24 pour atteindre la température sélectionnée (p.ex. 19 °C). En mode Confort, la température peut être définie par l'utilisateur.

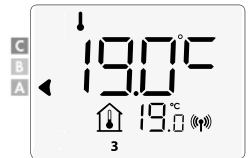

- **Mode Économique**

Éco correspond à la température du mode Confort, moins 3,5 °C. Ce mode vous permet de baisser la température sans devoir réinitialiser la température du mode Confort. Sélectionnez ce mode lorsque vous vous absentez pour une courte période (entre 2 h et 24 h) et pendant la nuit.

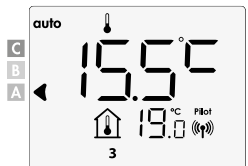

- **Mode Protection antigel**

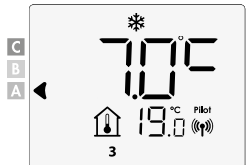

Ce mode vous permet de protéger votre habitation contre les effets du froid (conduites gelées, etc.) en maintenant à tout moment une température ambiante de min. 7 °C.

Sélectionnez ce mode lorsque vous vous absentez pour une longue période (plus de 5 jours).



RÉGLER LA TEMPÉRATURE CONFORT

Vous pouvez régler la température du mode Confort à partir des modes Auto et Confort. Elle est prédéfinie à 19 °C.

Les boutons  et  vous permettent d'ajuster la température entre 7 °C et 30 °C, à intervalles de 0,5 °C.

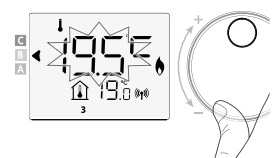
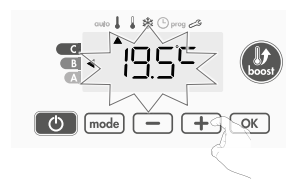

BOOST

Important : le mode Boost peut être activé à tout moment, quel que soit le monde de fonctionnement actif (Auto, Confort ou Protection antigel).

Première pression = Boost

Pendant la première minute, vous pouvez modifier la durée du mode Boost de 0 à la durée maximale autorisée du mode Boost, en utilisant les boutons et . Votre modification sera enregistrée et appliquée lors de la prochaine utilisation de Boost.

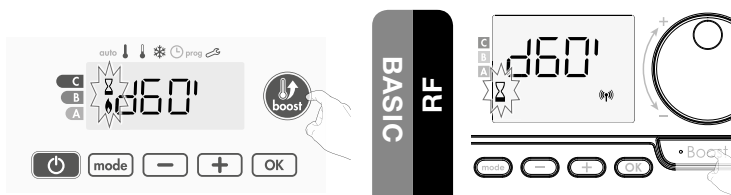

Commentaire : après une minute, vous pouvez modifier la durée de manière temporaire. Votre sélection ne s'appliquera qu'au Boost actif et ne sera, par conséquent, pas récurrente.

Le mode Boost peut s'arrêter pour deux raisons :

- **une commande « Stop » a été envoyée par votre régulateur d'énergie (seulement pour la France) :**

L'appareil s'arrête et le symbole -- apparaît. Le curseur se déplace En dessous auto. Une fois que la commande Confort sera envoyée, le mode Boost redémarrera jusqu'à la fin du compte à rebours ;

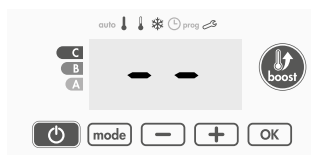

- **la température ambiante atteint la température Boost maximale :**

L'appareil s'éteint, mais le mode Boost est toujours actif : le temps restant reste affiché, le symbole Boost et l'indicateur de chauffage clignotent à l'écran. Lorsque la température repasse sous la barre de la température maximale autorisée, l'appareil redémarrera jusqu'à la fin du compte à rebours.

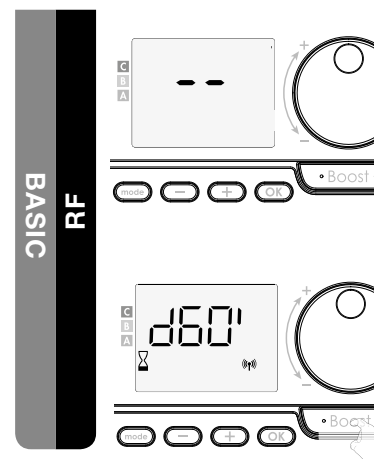

Deuxième pression = annulation du Boost

Le curseur se déplace en dessous du mode actif précédent et la température définie apparaît.

CONSOMMATION ÉNERGÉTIQUE

Un curseur indique le niveau de consommation énergétique en se plaçant face à la couleur correspondante : rouge, orange ou vert.

C - Couleur Rouge Consommation plus élevée	Température définie $> 22 \text{ }^\circ\text{C}$
B - Couleur Orange Consommation moyenne	Température définie $> 19 \text{ }^\circ\text{C} \leq 22 \text{ }^\circ\text{C}$
A - Couleur Vert Consommation inférieure	Température définie $\leq 19 \text{ }^\circ\text{C}$

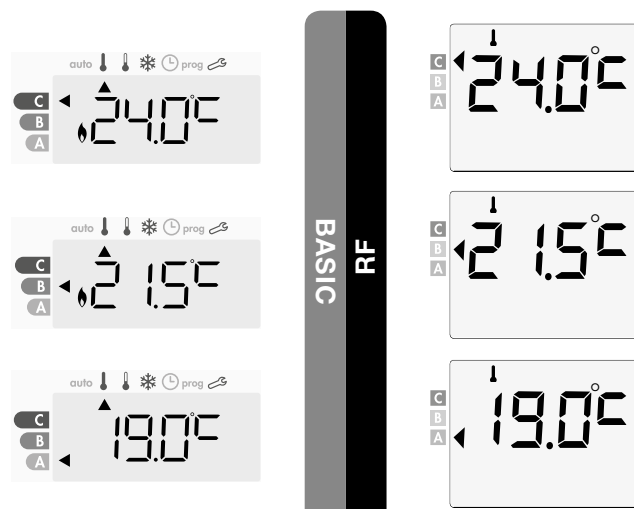

- **Affichage de la consommation énergétique estimée en kWh**

Pour voir cette estimation, placez-vous en mode Auto, Confort, Éco ou Protection antigel, puis appuyez sur .

Pour quitter le mode d'affichage de la consommation, appuyez sur n'importe quel bouton et l'appareil reviendra automatiquement au dernier mode actif.

- **Réinitialiser le compteur énergétique**

Pour réinitialiser le compteur énergétique, placez-vous en mode Auto, Confort, Éco ou Protection antigel, puis procédez comme suit.

- 1- Appuyez sur **OK** .
- 2- Enfoncez simultanément **-** et **+** pendant plus de 5 secondes. Pour quitter la réinitialisation du compteur énergétique, appuyez sur n'importe quel bouton et l'appareil reviendra automatiquement au dernier mode actif.

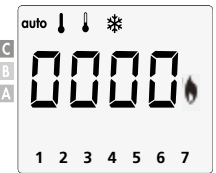

BASIC RF

VERROUILLAGE/DÉVERROUILLAGE DU PAVÉ NUMÉRIQUE

• Verrouillage du pavé numérique

Pour verrouiller le pavé numérique, maintenez les boutons **-** et **+** enfoncés pendant 10 secondes. Le symbole de cadenas **🔒** apparaît à l'écran. Le pavé numérique est verrouillé.

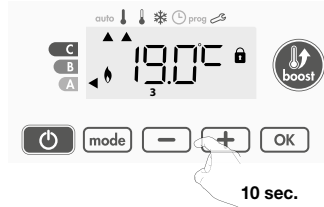

• Déverrouillage du pavé numérique

Pour déverrouiller le pavé numérique, maintenez à nouveau les boutons **-** et **+** enfoncés pendant 10 secondes. Le symbole de cadenas **🔒** disparaît de l'écran. Le pavé numérique est déverrouillé.

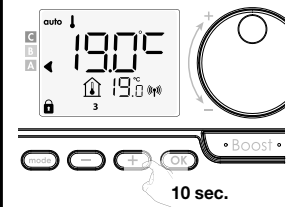

BASIC RF

DÉFINIR L'HEURE ET LE JOUR

- 1- Depuis les modes Auto, Confort, Éco ou Protection antigel, appuyez sur **mode** pendant 5 secondes.

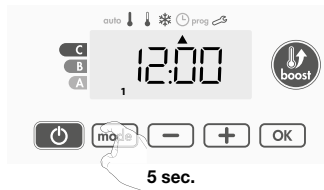

- 2- Les deux chiffres des heures clignotent alors. Si vous maintenez les touches **-** ou **+** enfoncées, les heures défilent rapidement. Pour enregistrer, appuyez sur **OK**.

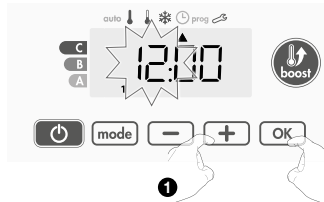

- 3- Les deux chiffres des minutes clignotent ensuite. Appuyez sur **-** ou **+** pour changer les minutes. Pour enregistrer, appuyez sur **OK** .

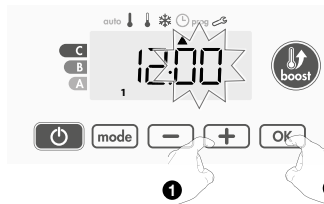

- 4- Le curseur situé au-dessus du numéro 1 (ce qui correspond au lundi) se mettra alors à clignoter. Sélectionnez la date en utilisant **-** ou **+** . Pour enregistrer, appuyez sur **OK** .

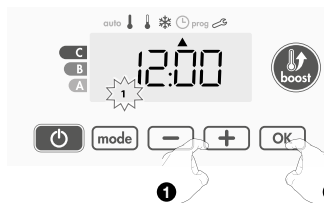

Lundi	1	Vendredi	5
Mardi	2	Samedi	6
Mercredi	3	Dimanche	7
Jeudi	4		

- 5- Pour modifier et/ou définir le programme hebdomadaire, appuyez sur **mode** . Pour quitter le mode de programmation des heures et dates, enfoncez le bouton **mode** à trois reprises.

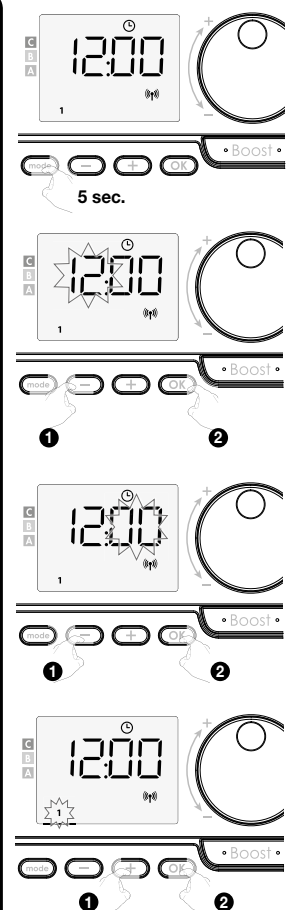

BASIC RF

APERÇU DES PROGRAMMES

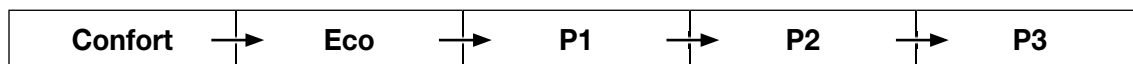

Votre appareil est configuré par défaut en mode Confort en continu, 7 jours sur 7.

- **Confort:** votre appareil fonctionnera en mode Confort, 24 heures sur 24, pour chaque jour sélectionné.
- **Eco :** l'appareil fonctionnera en mode Éco, 24 heures sur 24.
Remarque : vous pouvez définir les paramètres d'abaissement de la température, voir réglages utilisateur.
- **P1:** votre appareil fonctionnera en mode Confort pour 1 bloc de temps p.e. de 6 h à 22 h (et en mode Éco de 22 h à 6 h).
- **P2:** votre appareil fonctionnera en mode Confort pour 2 blocs de temps p.e. de 6 h à 9 h et de 16 h à 22 h (et en mode Éco de 9 h à 16 h et de 22 h à 6 h).
- **P3:** votre appareil fonctionnera en mode Confort pour 3 blocs de temps p.e. de 6 h à 8 h, de 12 h à 14 h et de 18 h à 23 h (et en mode Éco de 23 h à 6 h, de 8 h à 12 h et de 14 h à 18 h).

⚠ Remarque: si les horaires standard de P1, P2 et P3 ne vous conviennent pas, vous pouvez les modifier, mais cette heure s'applique à tous les jours de la semaine pour lesquels P1, P2 ou P3 est défini

DÉFINIR LE PROGRAMME HEBDOMADAIRE

1- Depuis les modes Auto, Confort, Eco ou Protection antigel, appuyez sur **mode** pendant 5 secondes.
 Lorsque le curseur se déplace sur le symbole de réglage de l'heure ⌚, appuyez brièvement sur **mode**.

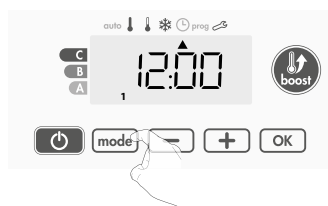

2- Appuyez sur **+** ou **-** pour définir le programme hebdomadaire.

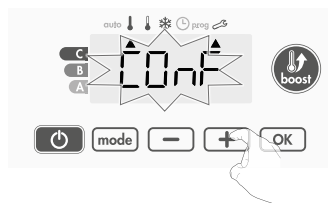

3- Sélectionnez le programme souhaité avec **+** ou **-**.

Si vous le souhaitez, les temps standard peuvent être ajustés: appuyez sur **OK** pendant au moins 5 secondes.

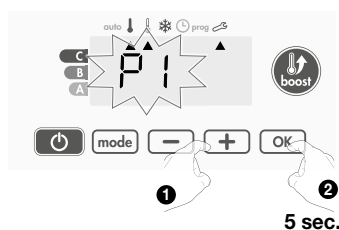

Si les heures standard s'appliquent: appuyez sur **OK** pour définir le jour suivant (passez à l'étape 4)

3.1- L'heure de début clignote et avec **+** ou **-** vous pouvez modifier cette heure toutes les 30 minutes.

Appuyez sur **OK** pour enregistrer.

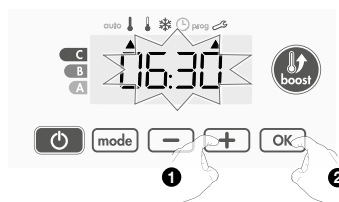

3.2- L'heure de fin clignote et avec **+** ou **-** vous pouvez modifier cette heure toutes les 30 minutes.

Appuyez sur **OK** pour enregistrer.

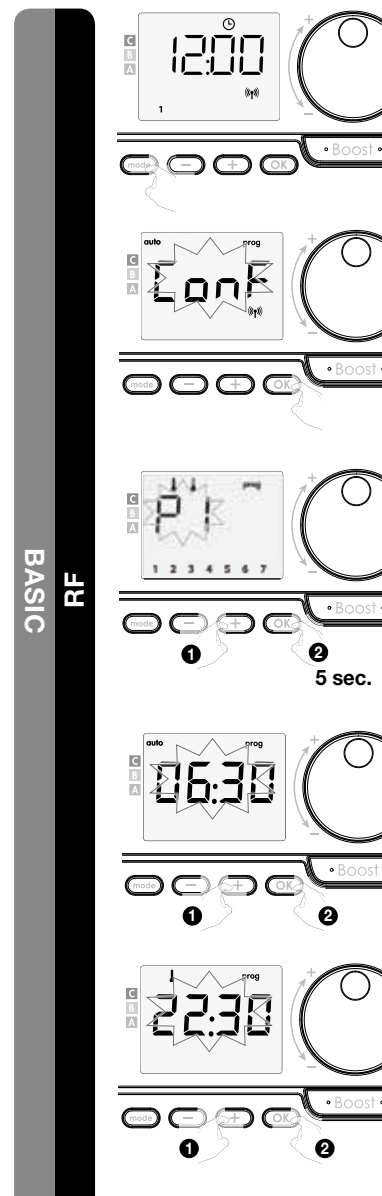
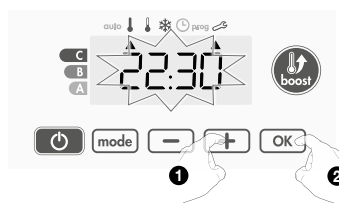

- 4- Le deuxième jour (mardi) clignote. Répétez la procédure décrite ci-dessus pour chaque jour de la semaine.

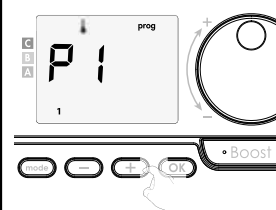
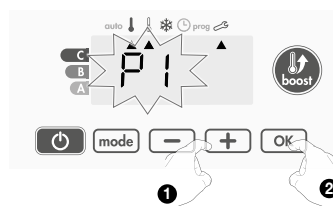

- 5- Une fois que vous avez sélectionné un programme pour chaque jour, confirmez votre sélection en appuyant sur **OK**. Les jours de la semaine apparaissent à l'écran avec les programmes que vous leur avez définis. Appuyez deux fois sur **mode** pour quitter le mode de programmation et revenir au «Mode automatique».
- Si vous n'appuyez sur aucune touche pendant quelques minutes, l'appareil repasse automatiquement en «Mode automatique».

VOIR LE PROGRAMME HEBDOMADAIRE

Depuis les modes Auto, Confort, Éco ou Protection antigel, appuyez sur **mode** pendant 5 secondes. Appuyez deux fois sur **mode**. Les programmes que vous avez sélectionnés pour chaque jour de la semaine (Confort, Éco, P1, P2 ou P3) défilent à l'écran.

Pour quitter l'aperçu de la programmation, appuyez deux fois sur **mode**.

EXCEPTION TEMPORAIRE SUR LE PROGRAMME HEBDOMADAIRE

Cette fonctionnalité vous permet de modifier la température définie jusqu'au prochain changement de température prévu ou jusqu'à la transition à minuit.

Exemple:

- 1- L'appareil est en mode Auto et le programme actif est Éco à 15,5 °C.
- 2- Vous pouvez, par exemple, régler temporairement la température désirée sur 18 °C à l'aide des boutons **-** ou **+**.
- 3- Cette modification sera automatiquement supprimée lors du prochain changement de programme ou de la transition à minuit.

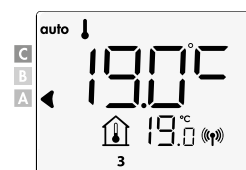
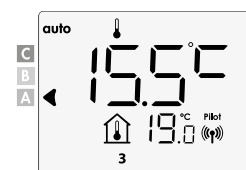
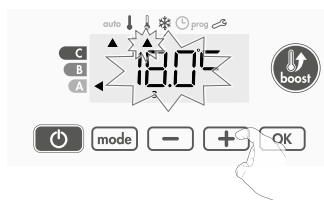
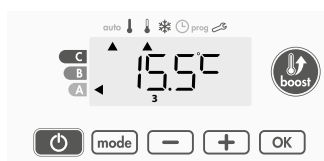

DÉTECTION DE FENÊTRE OUVERTE

La détection de fenêtre ouverte est sensible aux fluctuations de température. La centrale répond aux fenêtres ouvertes en fonction de divers paramètres: réglage de la température, montée et descente de la température ambiante, température extérieure, emplacement de la centrale, etc. Si la centrale se trouve à proximité d'une porte avant, la détection d'air peut être perturbée lorsque on ouvre la porte. En cas de problème, nous vous recommandons de désactiver la détection de fenêtre, voir réglages installateur.

Lorsque la commande passe à un cycle de réduction de la température en ouvrant une fenêtre, un compteur apparaît sur l'affichage pour indiquer la durée du cycle de la Protection antigel. Le compteur est automatiquement remis à zéro lors de la prochaine activation de la protection antigel. En appuyant sur un bouton, le mode Protection antigel est désactivé.

Remarque: si une augmentation de température est détectée, la commande reviendra automatiquement au mode précédent.

LA COMMANDE À DISTANCE PAR FIL PILOTE (SEULEMENT POUR LA FRANCE)

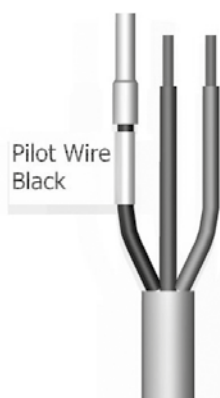

Le fil pilote est protégé par un manchon.
Retirez le manchon pour connecter le fil pilote
si nécessaire. (seulement pour la France)



Aperçu

Votre appareil peut être contrôlé par une unité centrale de commande via un fil pilote, auquel cas les différents modes de fonctionnement seront activés à distance par le programmeur. L'appareil peut uniquement être contrôlé par fil pilote lorsqu'il est en mode Auto. Si un autre mode est actif, les commandes transmises par le fil pilote ne seront pas exécutées.

Fil pilote = Confort

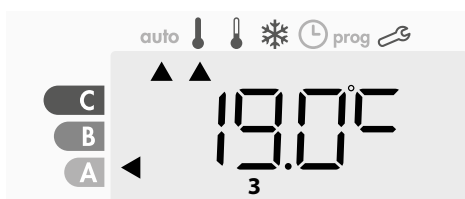

Fil pilote = Éco
Confort - 3,5 °C

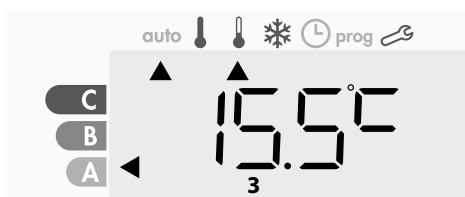

Fil pilote = Éco - 1
Confort - 1 °C

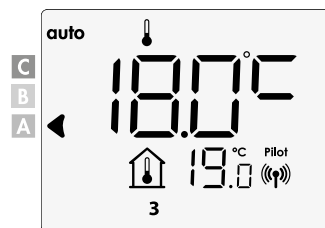
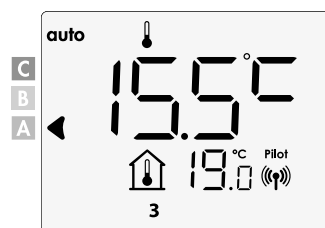
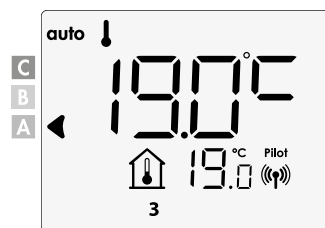
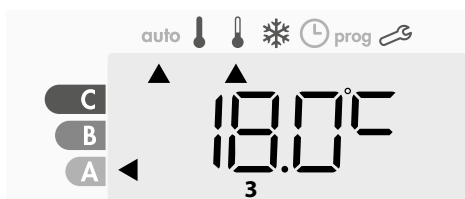

Fil pilote = Éco - 2
Confort - 2 °C

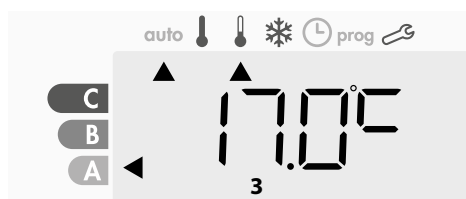

Fil pilote =
Protection antigel



Fil pilote = Stop
(mode veille)

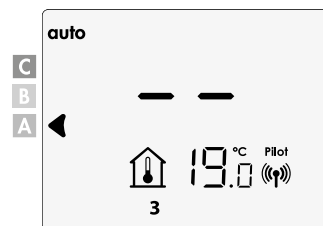
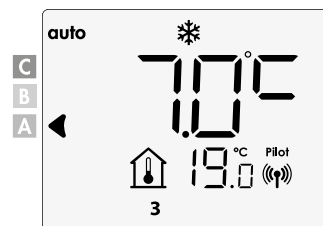
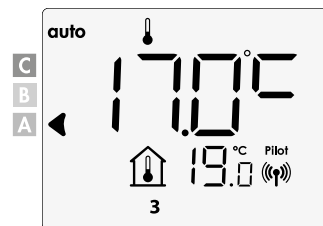
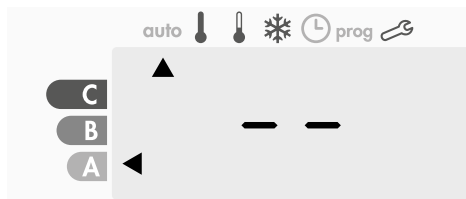

RÉGLAGES UTILISATEUR

ACCÈS

A partir du mode Auto, Confort, Éco ou Protection antigel :



Schéma d'enchaînement des réglages :

Rétro-éclairage → Réduction de la température Eco → Température protection antigel → Limitation de la température confort → Durée max. du Boost → Température max. du Boost → Unité de température → Retour aux réglages usine

RÉTRO-ÉCLAIRAGE

1- il y a 3 options disponibles :

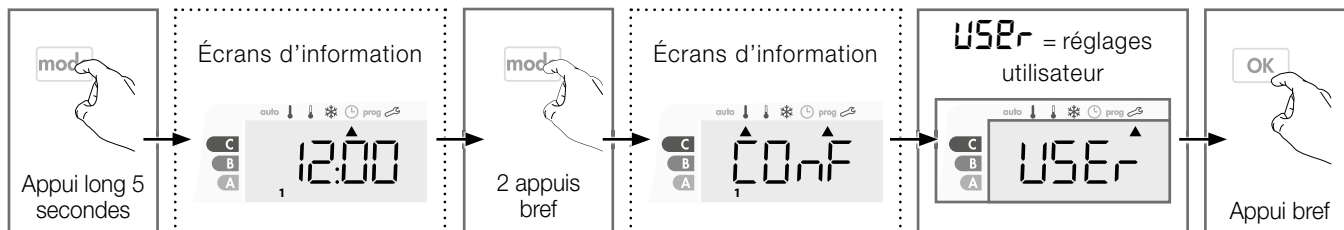
- L1 = rétro-éclairage temporisé : l'écran s'allume lors d'un appui sur une touche.
- L2 = rétro-éclairage permanent : l'écran reste tout le temps allumé.
- L3 = idem option L1

L'option L3 est définie par défaut.

Appuyez sur la touche **+** ou **-** souhaité.

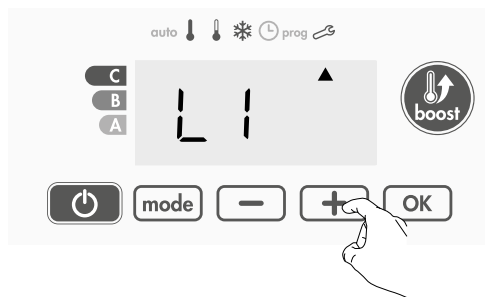

2- Pour valider et passer au réglage suivant, appuyez sur **OK**.

Pour valider et sortir les réglages appuyez 2x sur **mode**.

RÉDUCTION DE LA TEMPÉRATURE ECO

L'abaissement est pré-réglé à -3,5°C par rapport à la température de consigne Confort. Vous pouvez le faire varier de -1°C à -8°C par intervalle de 0,5°C.

Important : quel que soit le niveau d'abaissement réglé, la température de consigne Éco ne dépassera jamais les 19°C.

1- Appuyez sur **-** ou **+** pour afficher la valeur souhaitée.

2- Pour valider et passer au réglage suivant, appuyez sur **OK**.

Pour valider et sortir les réglages appuyez 2x sur **mode**.

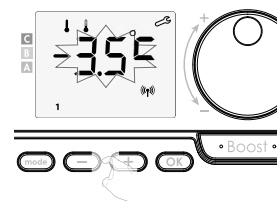
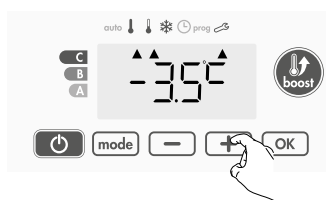

TEMPÉRATURE PROTECTION ANTIGEL

Votre appareil est pré-réglé à 7°C, vous pouvez faire varier la valeur de la consigne Hors-gel de 5°C à 15°C par intervalle de 0,5°C.

1- Appuyez sur **-** ou **+** pour afficher la valeur souhaitée.

2- Pour valider et passer au réglage suivant, appuyez sur **OK**.

Pour valider et sortir les réglages appuyez 2x sur **mode**.

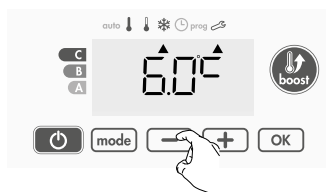

LIMITATION DE LA TEMPÉRATURE CONFORT

• Limite inférieure

La butée minimale est pré-réglée à 7°C. Vous pouvez la faire varier de 7°C à 15°C par intervalle de 1°C.

- 1- Pour modifier la butée minimale, appuyez sur **-** ou **+** puis validez en appuyant sur **OK**.

Si vous ne souhaitez pas la modifier, appuyez sur **OK** : l'appareil vous propose automatiquement de régler la butée maximale. Pour valider et sortir les réglages, appuyez 2x sur **mode**.

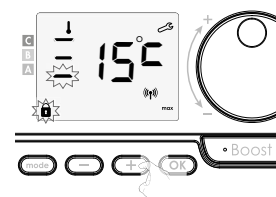
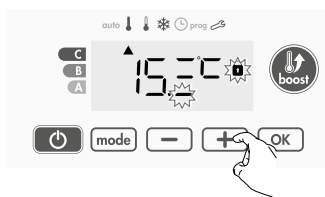

• Limite supérieure

La butée maximale est pré-réglée à 30°C. Vous pouvez la faire varier de 19°C à 30°C par intervalle de 1°C.

- 2- Pour modifier la température de consigne maximale, appuyez sur **-** ou **+**.

Appuyez sur la touche **OK** pour valider et passer au réglage suivant. Pour valider et sortir les réglages, appuyez 2x sur **mode**.

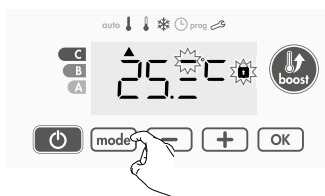

DURÉE MAX. DU BOOST

La durée maximale du Boost est pré-réglée à 60 minutes. Vous pouvez la faire varier de 30 à 90 minutes par intervalle de 30 minutes.

- 1- Le symbole Boost et l'indicateur de chauffage apparaissent à l'écran et la durée réglée de 60 minutes clignote
- 2- Appuyez sur **-** ou **+** pour afficher la durée souhaitée.
- 3- Pour valider et passer automatiquement au réglage suivant, appuyez sur **OK**. Pour valider et sortir les réglages, appuyez 2x sur **mode**.

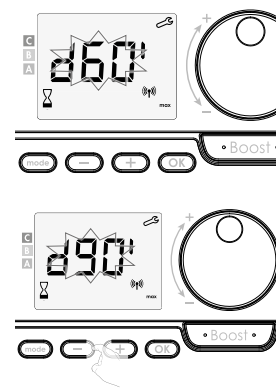
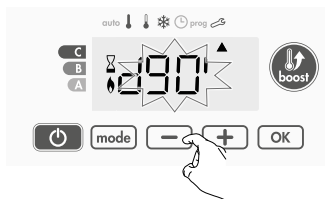
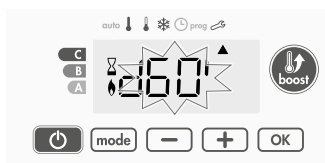

TEMPÉRATURE MAX. DU BOOST

Lorsque le Boost est activé, le radiateur doit chauffer la pièce jusqu'à la limite de température. Lorsqu'elle est atteinte, le Boost s'arrête automatiquement.

Elle est pré-réglée à 35°C, vous pouvez la faire varier de 25°C à 39°C par intervalle de 1°C.

- 1- Le symbole Boost et l'indicateur de chauffage apparaissent à l'écran et la température max. du Boost clignote
- 2- Vous pouvez régler la température par appuis successif sur **-** ou **+** par pas de 1°C, jusqu'à 39°C.
- 3- Pour valider et passer automatiquement au réglage suivant, appuyez sur **OK**. Pour valider et sortir les réglages, appuyez 2x sur **mode**.

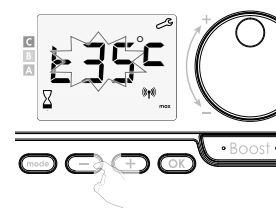

UNITÉ DE TEMPÉRATURE

L'unité de température est le degré Celsius par défaut.

- 1- Appuyez sur **-** ou **+** pour modifier l'unité de température.
- 2- Pour valider et passer automatiquement au réglage suivant, appuyez sur **OK**. Pour valider et sortir les réglages, appuyez 2x sur **mode**.

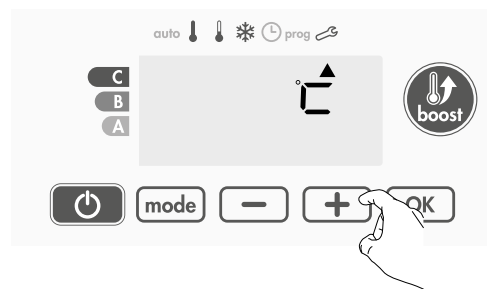

RETOUR AUX RÉGLAGES USINE

- 1- **rest** s'affiche 1 seconde.

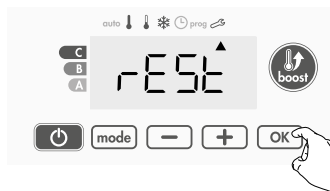

- 2- **no** clignote. Appuyez sur **-** ou **+** pour sélectionner **yes**

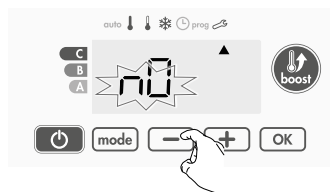

- 3- Appuyez 5 secondes sur **OK**.
L'appareil retourne dans sa configuration d'origine et revient automatiquement en mode Auto.

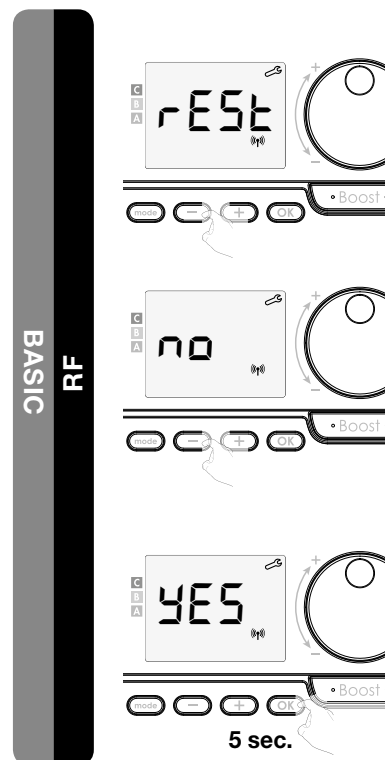
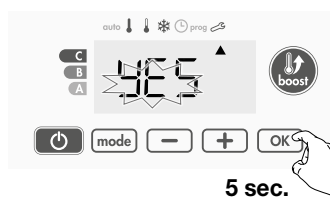

Général

Température Confort	19 °C
Durée max. du Boost	60 min.
Verrouillage clavier	Désactivé

Réglages utilisateur

Rétro-éclairage	L3	BASIC
Réduction de la température Eco	-3,5 °C	
Température protection antigél	7 °C	
Limite inférieure de la température Confort	7 °C	
Limite supérieure de la température Confort	30 °C	
Durée max. du Boost	60 min.	
Température max. du Boost	35 °C	
Unité de température	°C	

Appuyez 2x sur **mode** pour valider et sortir des réglages.

RÉGLAGES INSTALLATEUR

ACCÈS

A partir du mode Auto, Confort, Éco ou Protection antigel :

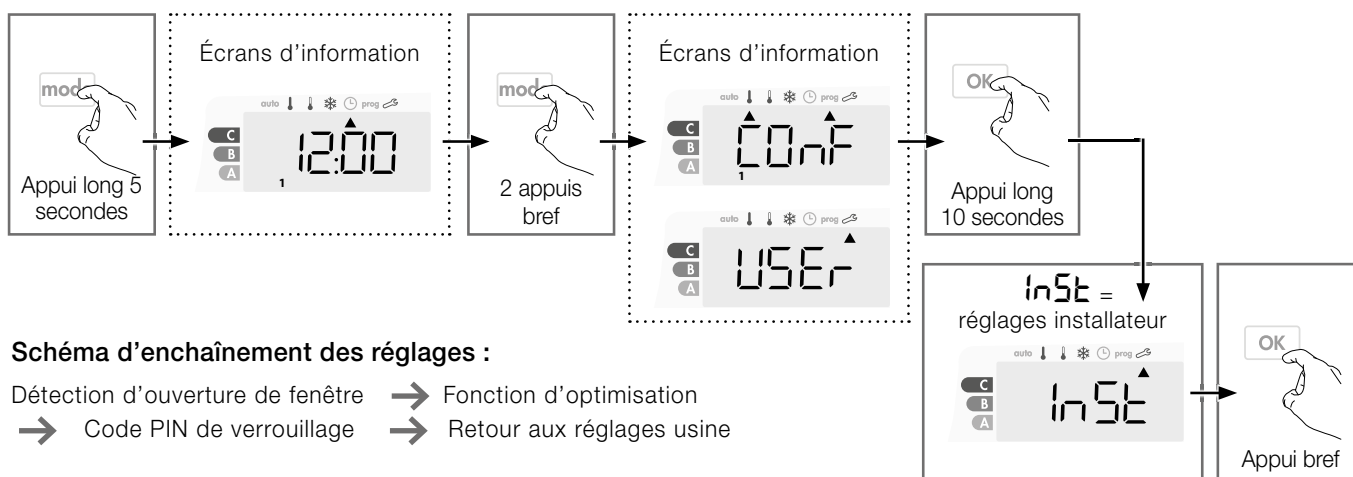

DÉTECTION D'OUVERTURE DE FENÊTRE

1- Le mode est activé par défaut.

2- Appuyez sur **-** ou **+**.

On = mode automatique activé.

OFF = mode automatique désactivé.

3- Appuyez sur **OK** pour valider et passer au réglage suivant. Pour valider et sortir les réglages, appuyez 3x sur **mode**.

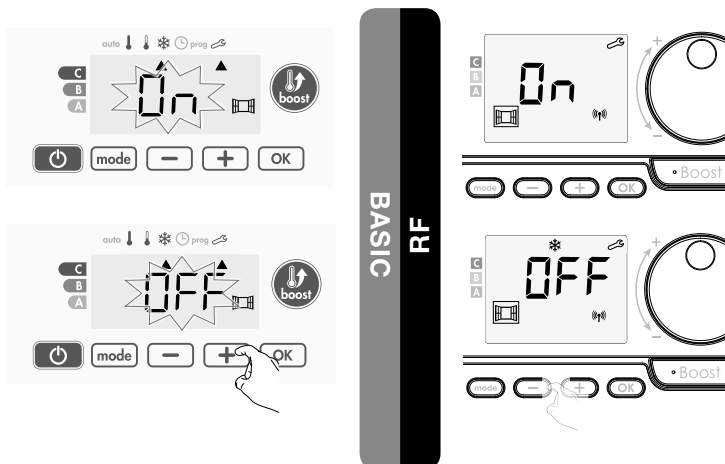

FONCTION D'OPTIMISATION

- **En mode OPTI ÉCO (priorité à l'efficacité)** l'appareil calculera le meilleur compromis afin de garantir des économies d'énergie maximales, tout au long des phases d'augmentation et de diminution programmées. Une légère baisse du niveau de température est permise au début et à la fin de la période de confort pour maximiser les économies d'énergie.

- **En mode OPTI CONFORT (priorité au confort)** l'appareil calcule le meilleur compromis afin de garantir un confort maximal pendant les phases d'augmentation et de diminution programmées. La priorité est accordée à l'anticipation et au maintien de la température du mode Confort pendant les périodes du Confort.

Le mode OPTI CONFORT est active par défaut.

La mention OP/./ apparaitra brièvement à l'écran, puis s'affichera en alternance avec le mode configure : ConF, ECO ou OFF.

1- Appuyez sur **-** ou **+**.

ConF = fonction d'optimisation activée pour le mode OPTI CONFORT, priorité au confort.

ECO = fonction d'optimisation activée pour le mode OPTI ECO, priorité à l'efficacité énergétique.

OFF = fonction d'optimisation désactivée.

2- Appuyez sur **OK** pour enregistrer et passer au réglage suivant. Pour valider et sortir les réglages, appuyez 3x sur **mode**.

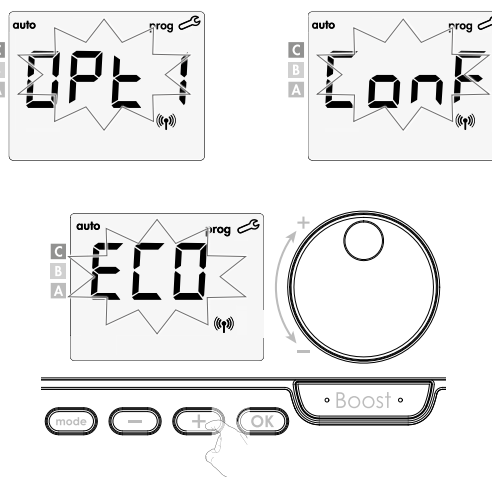

CODE PIN DE VERROUILLAGE

● Présentation

Vous pouvez définir vous-même le code PIN à 4 chiffres qui, lorsqu'il est activé, il rend indisponible les fonctions suivantes:

- Sélection du mode Confort: seuls les modes Auto, Eco et Protection Antigel sont disponibles.
- Réglage de la température de Confort, Eco et Protections Antigel.
- Changer le programme hebdomadaire.
- Réglage de la détection de fenêtre ouverte.

Lors de la première utilisation de la protection "verrouillage par code PIN", 3 étapes importantes sont nécessaires :

- 1- Initialisation du code PIN, saisir le code PIN par défaut (0000) pour accéder à la fonction.
- 2- Activation du code PIN pour verrouiller les réglages qui seront protégés par code PIN.
- 3- Personnalisation du code PIN, remplacer (0000) par son code personnalisé à quatre chiffres.

● Initialisation du code PIN = '0000'

Par défaut, le code PIN n'est pas activé = OFF

- 1- Le code PIN enregistré par défaut est 0000.
A l'aide de **-** ou **+** sélectionnez le chiffre 0.
Celui-ci clignote, validez en appuyant sur **OK**.

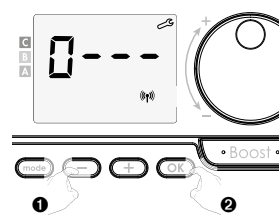
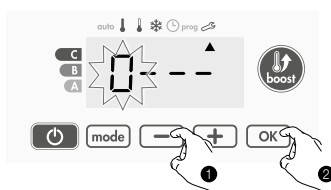

- 2- Pour les chiffres restants, sélectionnez le chiffre 0 par appui sur **OK**.
Lorsque 0000 s'affiche, appuyez une nouvelle fois sur **OK** pour valider.

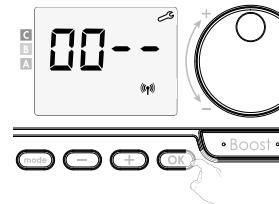
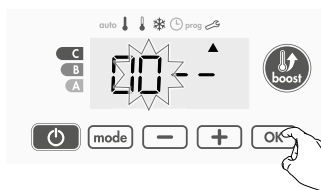

Le code PIN est initialisé, l'appareil vous propose automatiquement le réglage suivant : activation du code PIN.

● Activation/Désactivation du code PIN

- 1- **OFF** apparaît sur l'afficheur.
Appuyez sur **-** ou **+** pour activer le code PIN.
On = code PIN activé
OFF = code PIN désactivé

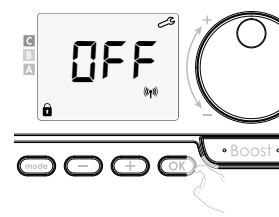
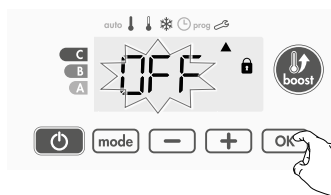

- 2- Appuyez sur **OK** pour valider et passer au réglage suivant.

Le code PIN est désormais activé.
Toute modification des réglages listés dans "Présentation" est impossible.

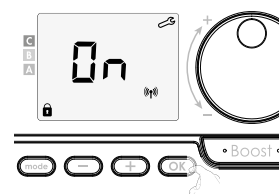
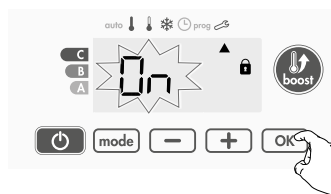

● Personnalisation du code PIN

- 1- Lorsque **On** s'affiche, appuyez sur **OK** pendant au moins 5 secondes.

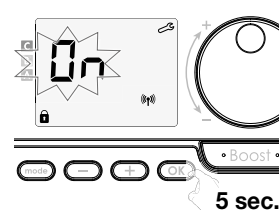
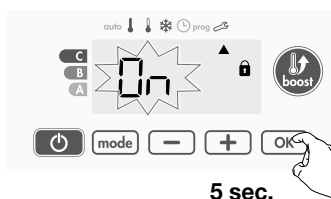

2- Le code 0000 s'affiche et le 1er chiffre clignote. A l'aide de **-** ou **+**, sélectionnez le chiffre souhaité puis appuyez sur **OK** pour le valider. Procédez de la même manière pour les 3 chiffres restants.

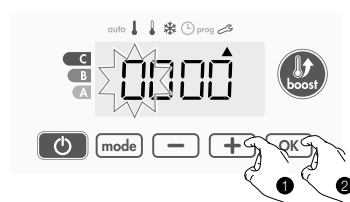

3- Appuyez sur **OK** pour valider. Le nouveau code est désormais enregistré.

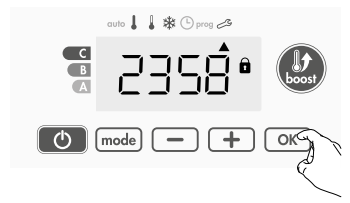

4- Appuyez sur **OK** une nouvelle fois pour sortir du mode de paramétrage du code PIN et revenir au début des réglages installateur.

Appuyez 3x sur **mode** pour valider et sortir les réglages.

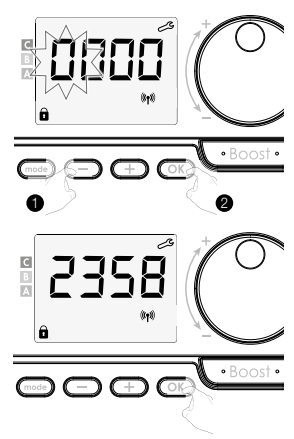

RETOUR AUX RÉGLAGES USINE

Si la protection par Code PIN est désactivée, vous pouvez remettre les paramètres utilisateurs et installateurs à leur valeur d'origine.

1- **REST** s'affiche.



2- **no** clignote.

Appuyez sur **-** ou **+** pour sélectionner **YES**.

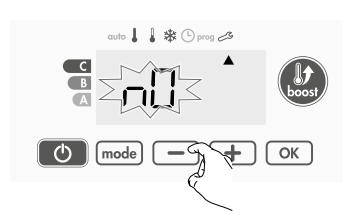

3- Appuyez 5 secondes sur **OK**.

L'appareil retourne dans sa configuration d'origine et revient automatiquement en mode Auto.

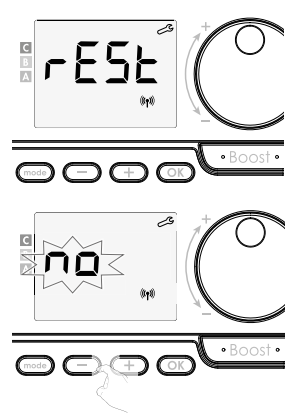

Général

Température Confort	19 °C
Durée max. du Boost	60 min.
Verrouillage clavier	Désactivé

Réglages utilisateur

Rétro-éclairage	L3	BASIC
Réduction de la température Eco	-3,5 °C	
Température protection antigel	7 °C	
Limite inférieure de la température Confort	7 °C	
Limite supérieure de la température Confort	30 °C	
Durée max. du Boost	60 min.	
Température max. du Boost	35 °C	
Unité de température	°C	

Réglages installateur

Détection d'ouverture de fenêtre	Activé
Fonction d'optimisation	Option Confort RF
Protection par code PIN	Désactivé
Valeur code PIN	0000

Appuyez 3x sur **mode** pour valider et sortir des réglages.

RÉGLAGES INSTALLATEUR AVANCÉS

ACCÈS

A partir du mode Auto, Confort, Éco ou Protection antigel :

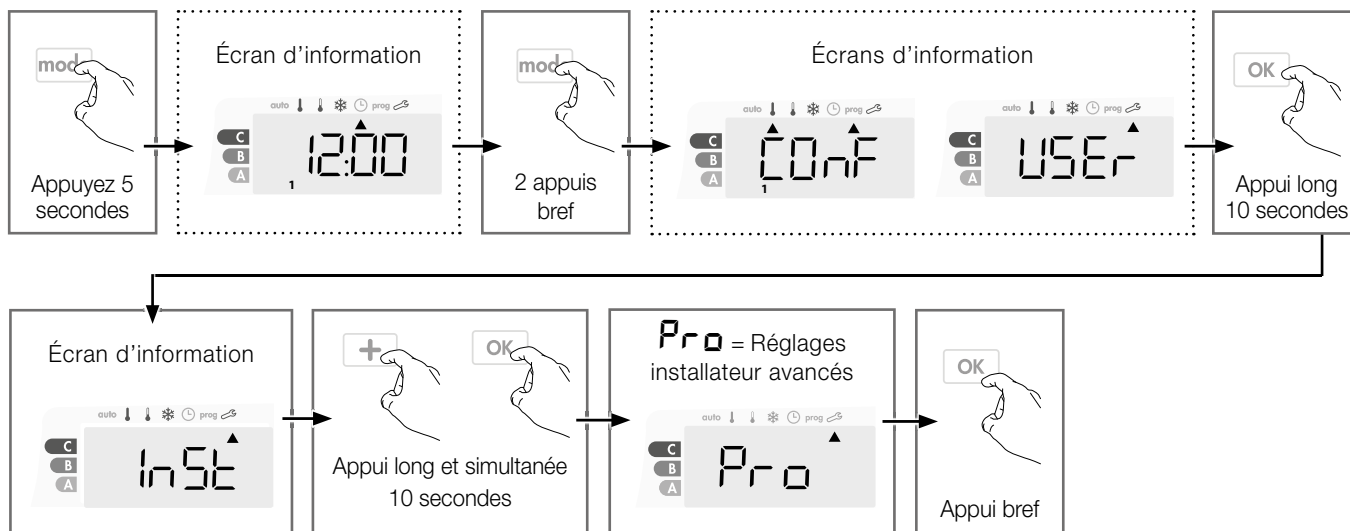

Séquence de paramétrage :

Étalonnage du capteur de température → Puissance du radiateur → Retour aux réglages usine

ÉTALONNAGE DU CAPTEUR DE TEMPÉRATURE

• Aperçu

⚠ Cette opération est uniquement réservée aux installateurs professionnels. Toute modification inadéquate entraînerait des dérèglements de contrôle.

L'étalonnage permet d'ajuster la température mesurée par le capteur de température ambiante pour compenser un écart de +5 °C à -5 °C, par tranche de 0,1 °C.

L'étalonnage peut être effectué pour chaque contrôle lié. En fonction du nombre de contrôles, vous commencez par définir le calibrage du premier contrôle, puis du second contrôle au dernier contrôle. Vous pouvez identifier le numéro de contrôle lorsque vous définissez l'étalonnage à l'écran.

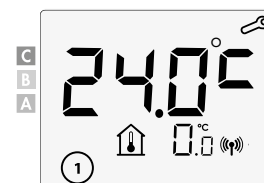

• Étalonnage

1- Si la différence par rapport à la température ambiante est négative, exemple :

Température définie (celle que vous souhaitez) = 20 °C.

Température ambiante (celle que vous lisez sur un thermomètre fiable) = 18 °C.

Différence mesurée : -2 °C.

⚠ Avant d'effectuer l'étalonnage, il est recommandé d'attendre 4 h après la modification de la température définie pour s'assurer que la température ambiante soit stabilisée.

Pour corriger la valeur, procédez comme suit :

Température du capteur = 24 °C.

Abaissez la température mesurée par le capteur de température ambiante de 2 °C en appuyant sur **-**.

Pour valider la nouvelle valeur, appuyez sur **OK**.

Pour sortir les réglages, appuyez 3 fois sur **mode**.



2- Si la différence par rapport à la température ambiante est positive, exemple :

Température définie (celle que vous souhaitez) = 19 °C.

Température ambiante (celle que vous lisez sur un thermomètre fiable) = 21 °C.

Différence mesurée : +2 °C.

Pour corriger la valeur, procédez comme suit :

Température du capteur = 21 °C.

Augmentez la température mesurée par le capteur de température ambiante de 2 °C en appuyant sur **+** .

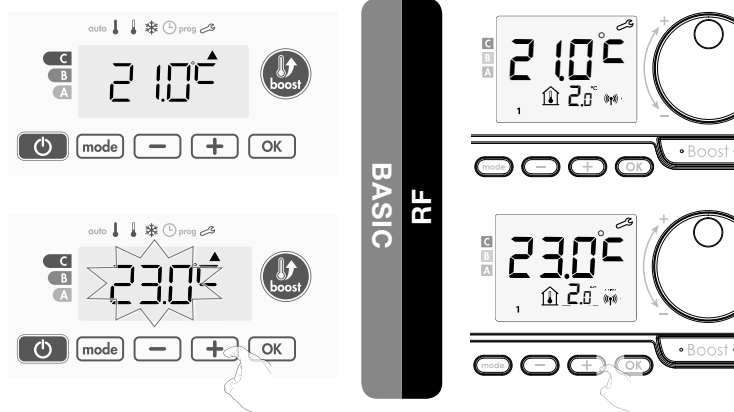

Pour valider la nouvelle valeur, appuyez sur **OK** . Pour sortir les réglages, appuyez 3 fois sur **mode** .

● Réinitialisation de l'étalonnage du capteur

1- Lorsque la température mesurée par le capteur apparaît, appuyez sur **-** ou **+** pendant au moins 3 secondes.

2- Pour valider et passer au réglage suivant, appuyez sur **OK** .

Pour valider et sortir les réglages appuyez 3x sur **mode** .



PUISSANCE DU RADIATEUR

Pour garantir le bon fonctionnement du radiateur et pouvoir estimer correctement la consommation d'énergie, il est indispensable de régler la puissance du radiateur.

BASIC: ce réglage doit être effectué lors de la première mise en service.

RF: lors de la liaison RF, ce paramètre est automatiquement discuté.

1- Sélectionnez une valeur comprise entre 500 W et 1500 W en appuyant sur **+** ou **-** .

2- Appuyez sur **OK** pour enregistrer et passer automatiquement au réglage suivant.

Pour sortir les réglages, appuyez 3 fois sur **mode** .

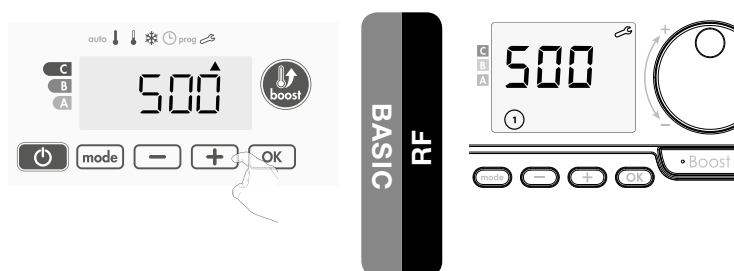

RETOUR AUX RÉGLAGES USINE

Si la protection par code PIN est désactivée, les paramètres d'utilisation, les paramètres d'installation et les paramètres d'installation avancés seront réinitialisés :

1- **RESTE** apparaît à l'écran.

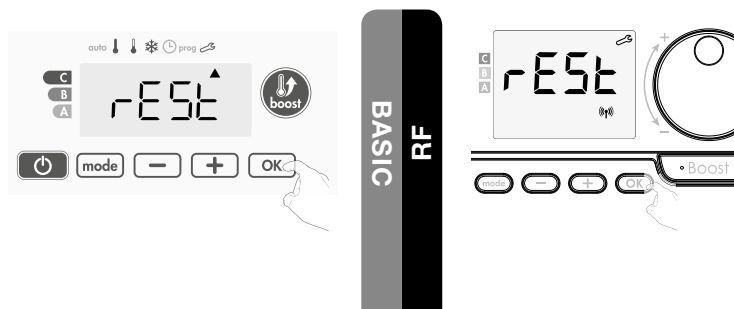

2- **no** s'affiche. Appuyez sur **-** ou **+** pour sélectionner **YES**.

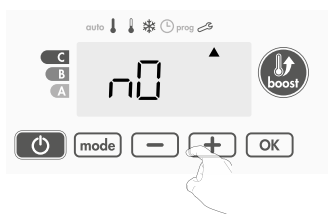

3- Enfoncez la touche **OK** pendant 5 secondes. L'appareil retrouve sa configuration initiale et revient automatiquement au mode Auto.



BASIC RF

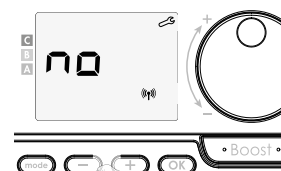

Général

Température Confort	19 °C
Durée max. du Boost	60 min.
Verrouillage clavier	Désactivé

Réglages utilisateur

Rétro-éclairage	L3	BASIC
Réduction de la température Eco	-3,5 °C	
Température protection antigel	7 °C	
Limite inférieure de la température Confort	7 °C	
Limite supérieure de la température Confort	30 °C	
Durée max. du Boost	60 min.	
Température max. du Boost	35 °C	
Unité de température	°C	

Réglages installateur

Détection d'ouverture de fenêtre	Activé	
Fonction d'optimisation	Option Confort	RF
Protection par code PIN	Désactivé	
Valeur code PIN	0000	

Réglages installateur avancés

Étallonnage du capteur de température	0,0
Puissance du radiateur	500W

Pour sortir les réglages, appuyez 3 fois **mode**.

SICHERHEITSHINWEISE



Das Gerät darf weder von Kindern bedient werden noch von Personen, die sich nur im eingeschränkten Besitz ihrer körperlichen, sensorischen oder geistigen Kräfte befinden oder die über keinerlei Erfahrungen bzw. Kenntnisse im Umgang mit Geräten dieser Art verfügen, sofern diese Personen nicht unter Aufsicht arbeiten oder angeleitet werden.



Kinder dürfen grundsätzlich nicht mit diesem Gerät spielen, auch nicht unter Aufsicht.

Der Heizkörper darf niemals abgedeckt und nicht unterhalb einer Steckdose montiert werden.

Der Heizkörper muss jederzeit ausgeschaltet werden können. Bei Anschluss über einen Stecker muss das Ausschalten mittels eines externen Schalters möglich sein. Bei einem festverdrahteten Anschluss muss dieser korrekt abgesichert sein.

Befolgen Sie bei der Installation und Montage des Heizkörpers die örtlich gültigen bzw. nationalen Elektroinstallationsvorschriften und unsere allgemeinen Bedingungen.

ENTSORGUNG DES ALTGERÄTS GEMÄSS WEEE-RICHTLINIE 2012/19/EU



Das auf dem Typenschild des Heizkörpers befindliche Symbol schreibt vor, dass der Heizkörper nicht dem Haushaltsabfall zugeführt werden darf, sondern davon getrennt zu entsorgen ist. Hat der Heizkörper das Ende seiner Lebensdauer überschritten, dann muss dieser einer Sammelstelle für Elektroschrott zugeführt werden. Wenden Sie sich in Ländern, in denen obige Richtlinie gilt, für weitere Informationen zu den entsprechenden Wiederverwertungseinrichtungen und Sammelstellen an Ihre örtlichen Behörden oder Ihr zuständiges Abfallentsorgungsunternehmen.

TECHNISCHE DATEN

- Betriebsspannung: 230 V~, 50 Hz
- max. Leistung: 1500 W (ohmsche Last)
- Versorgungskabel gemäß Schutzklasse II, 800 mm, 3-Leiter.
Beim schwarzen (abgeschirmten) Kabel handelt es sich um ein Kommunikationskabel, das **ausschließlich für Frankreich relevant ist**. Es darf nicht an die Erdung angeschlossen und nicht abisoliert werden. **Informieren Sie bei einem beschädigten Netzkabel Ihren Heizungsmonteur.**



- Standby-Verbrauch: < 0,5 W

- Elektronische PID-Regelung mit Relais+Triac-ansteuerung.



- IPX4

- Schutzklasse II, nach Installation unter der Verantwortung des Einbauers (gemäß EN60335-1)

HERSTELLERERKLÄRUNG



Wir erklären eigenverantwortlich, dass die in diesem Handbuch beschriebenen Produkte die Voraussetzungen für das Tragen des CE-Zeichens und alle wesentlichen Anforderungen der folgenden Richtlinien und harmonisierten Normen erfüllen:

- LVD 2014/35/EU: EN60335-1/EN60335-2-30/EN60335-2-43/ EN62333
- EMC 2014/30/EU: EN55014-1/EN55014-2-30/EN61000-3-2/ EN61000-3-3
- ERP 2009/125/EC
- RoHS 2011/65/EU: EN50581

Darüber hinaus erklären wir, dass die Produkte gemäß den in ISO 9001:2015 festgelegten zertifizierten Prozessen hergestellt wurden.

Dieses Gerät erfüllt die europäische Richtlinie 2015/1188 (Ökodesign-Richtlinie).

Verpflichtende Angaben zu Elektrogeräten für die örtliche Raumheizung			
Merkmal	Symbol	Wert	Einheit
Wärmeabgabe			
Nennwärmeleistung	P nom	0,5 → 1,5	kW
Mindestwärmeleistung	P min	0,5	kW
Max. dauerhafte Wärmeabgabe	P max,c	1,5	kW
Zusätzlicher elektrischer Verbrauch			
Bei Nennwärmeleistung	el max	0,000	kW
Bei Mindestwärmeleistung	el min	0,000	kW
Im Standby-Modus	el sb	0,0005	kW
Heizart / Regelung der Raumtemperatur			
Elektronische Regelung der Raumtemperatur mit Wochenzeitschaltuhr			
Weitere Ansteuerungsmöglichkeiten			
Regelung der Raumtemperatur inkl. Fenster-offen-Erkennung			
Optionale Fernbedienung			
RF	Mit adaptiver Regelung des Heizbeginns		
Kontaktdaten			
Siehe das auf dem Heizkörper angebrachte Typenschild			

Garantiebedingungen:

siehe unter
www.vasco-group.eu

HEIZUNGSREGLER INSTALLIEREN

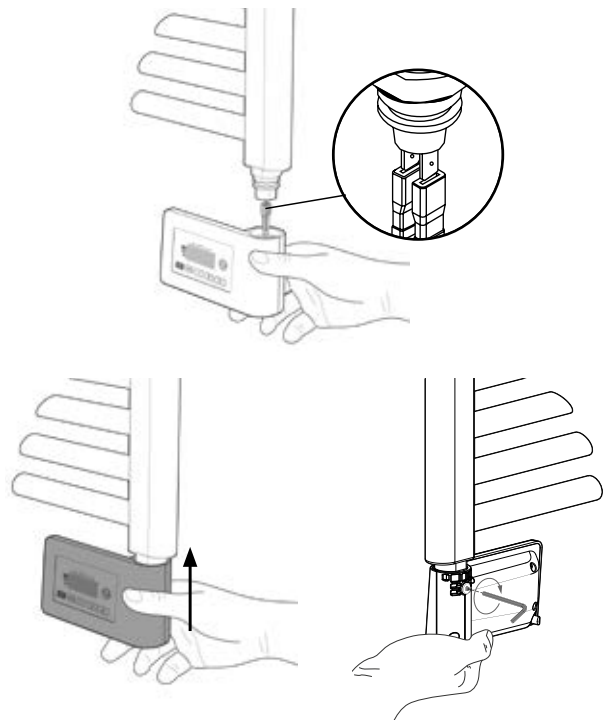

Heizungsregler mit dem mitgelieferten Innensechskantschlüssel anschrauben

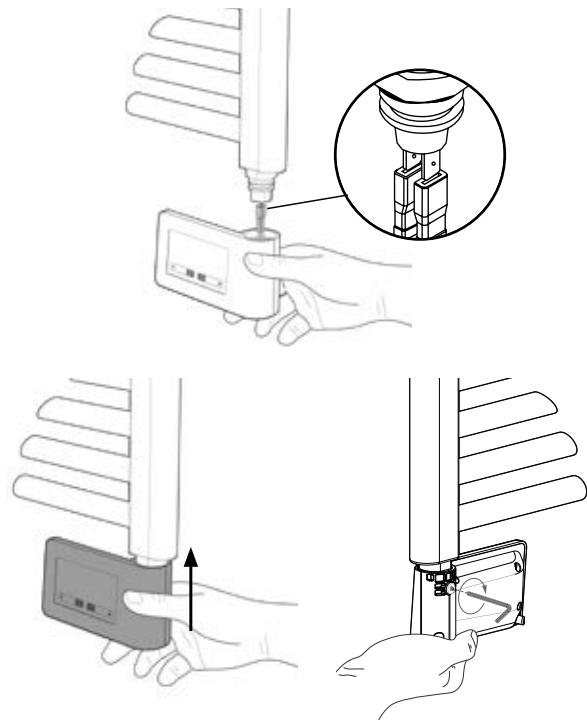

Heizungsregler mit dem mitgelieferten Innensechskantschlüssel anschrauben

BATTERIEN EINSETZEN

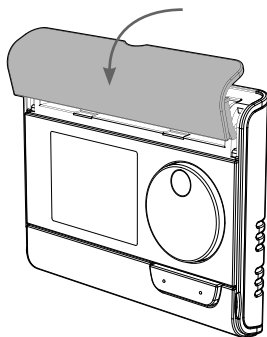

Entfernen Sie die vorne am Thermostat befindliche Batteriefachabdeckung.

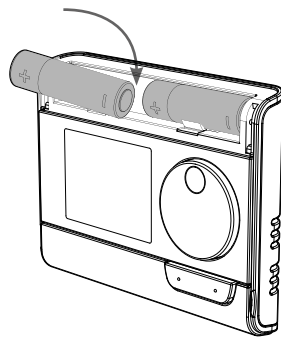

Setzen Sie die beiden mitgelieferten AA-Batterien ein. Achten Sie beim Einsetzen der Batterien auf die richtige Polarität, wie auf dem Thermostat vermerkt.

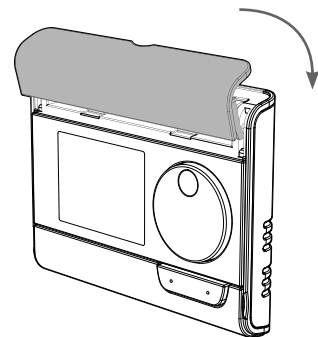

Batteriefachabdeckung wieder aufsetzen.

FUNKFERNBEDIENUNG BEFESTIGEN

Wandmontage

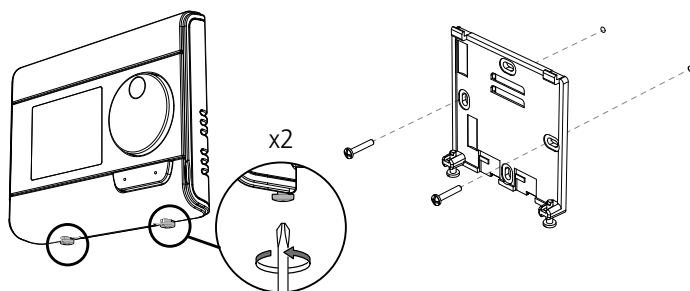

Lösen Sie die beiden unterhalb des Thermostats befindlichen Schrauben

Wandbefestigungsplatte mit den beiden mitgelieferten Schrauben in den horizontalen und vertikalen Öffnungen sichern.

Tischständer

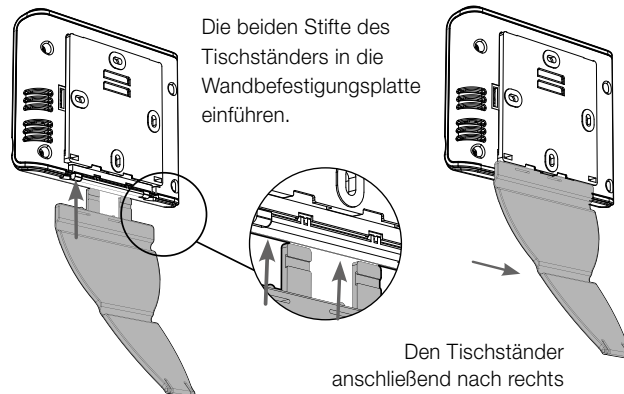

Die beiden Stifte des Tischständers in die Wandbefestigungsplatte einführen.

Den Tischständer anschließend nach rechts schieben.

FUNKEMPFANGER MIT RF FUNKFERNBEDIENUNG KOPPELN

Da die Funkfernbedienung und der Empfänger werkseitig nicht gekoppelt sind muss zunächst eine Kopplung durchgeführt werden.

Achtung: Es können maximal 5 Funkempfänger mit einer Funkfernbedienung verbindet werden.

Für eine erfolgreiche Kopplung führen sie die folgenden Schritte aus.

Funk-Verbindung:

- Die **memo** Taste 5 sek. lang gedrückt halten, um den Funkempfänger in den Verbindung-Modus zu versetzen.
Die **memo** LED beginnt rot zu blinken.

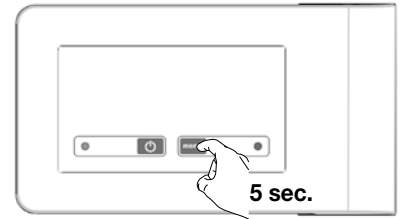

- Mit der Funkfernbedienung die Frostschutzfunktion anwählen (3 x Taste **mode** drücken, anschließend 5 sek. lang Taste **OK** gedrückt halten).

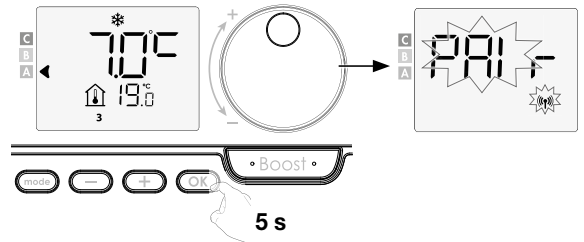

- Um einen ordnungsgemäßen Betrieb des Heizkörper sicherzustellen, muss die Leistung des Heizkörper über die RF-Fernbedienung eingestellt werden. Dieser Schritt wird beim Koppeln automatisch angezeigt.
Benutzen Sie die Taste **+** und **-** um die Leistung einzustellen (siehe Schild des Heizkörpers)

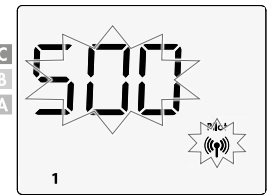

- Wenn Funkfernbedienung und Funkempfänger miteinander gekoppelt sind, wird dauerhaft das Symbol **RF** angezeigt.

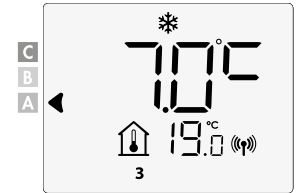

Funk-Verbindung aufheben:

Memo-Taste des Funkempfängers länger als 10 s lang drücken.

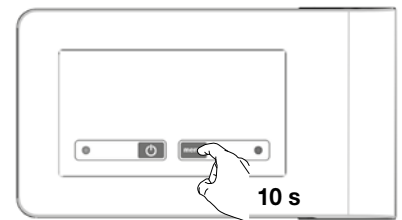

Status Betriebsart



Status Betriebsart	Status LED und Farbe
Standby	Aus
Eingeschaltet	Grün
Erwärmung erfolgt	Rot
Boost	Rot blinken
Frostschutzfunktion, Fenster-offen-Erkennung	Grün blinken
Manuell Aktivierung Heizung (MEMO-Taste)	Orange blinken

Status RF Kommunikation



Status RF Kommunikation	Status LED und Farbe
Standby	Aus
Keine RF Kommunikation	Rot
RF Verbindungsmodus	Rot blinken
RF Entkoppelungsmodus	Schnell rot blinken
RF Verbindung OK	Grün
RF-Nachricht erhalten	1 Sek. grün blinken

! HEIZKÖRPERLEISTUNG VOREINSTELLEN

Um einen korrekten Betrieb der Heizkörper zu gewährleisten, muss die Heizkörperleistung über das Bedienfeld eingestellt werden. Diese ist standardmäßig auf 500 W eingestellt.



Untenstehende Schritte ausführen:

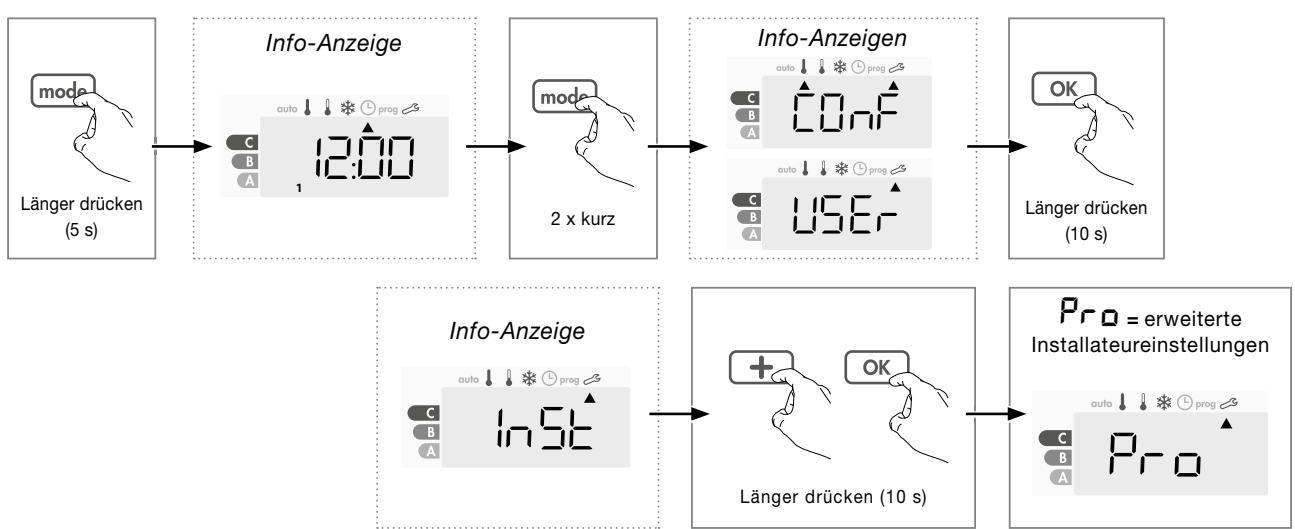

Anschließend 2 x Taste **OK** drücken und mit den Tasten **-** und **+** Nennleistung ändern.
 Menü verlassen: 3 x Taste **mode** drücken.

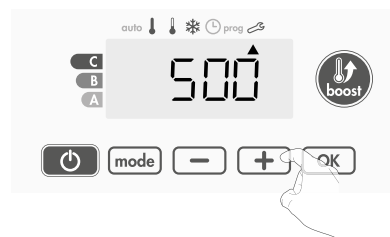

BASIC

GERÄTEBETRIEB

• Übersicht der Tasten

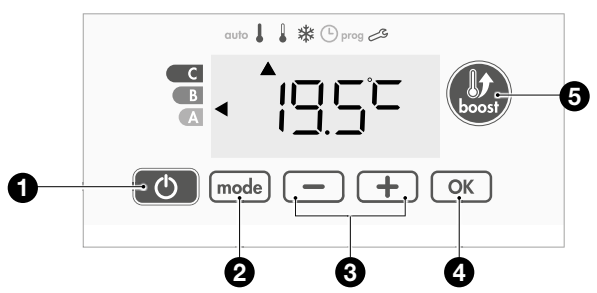

- 1 Einschalten / Standby-Betrieb
- 2 Betriebsmodus auswählen
- 3 Plus- und Minus-Tasten, für die Einstellung von Temperatur, Zeit, Tag und Wochenprogramm
- 4 Einstellungen bestätigen
- 5 Speichern Boostfunktion

• Übersicht über die Anzeigen

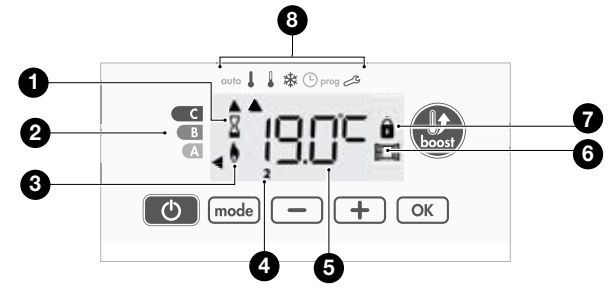

- 1 Boostanzeige
- 2 Verbrauchsanzeige
- 3 Heizbetriebsanzeige
- 4 Wochentage (1=Montag ... 7= Sonntag)
- 5 Solltemperatur
- 6 Fenster-offen-Erkennung
- 7 Tastatursperre aktiv

8 Betriebsmodi:

- auto** Auto (Automatikbetrieb)
- !** Comfort (Komfortbetrieb)
- !** Eco (Eco-Betrieb)
- *** Frostschutzfunktion
- ⌚** Zeit- und Wochentag einstellen
- prog** Programmiermodus
- 🔧** Einstellungen

RF GERÄTEBETRIEB

• Übersicht über die einzelnen Bedientasten

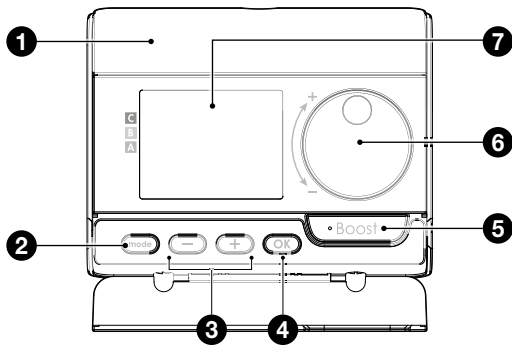

- 1 Batteriefach
- 2 Betriebsmodus auswählen
- 3 Plus- und Minus-Tasten, für die Einstellung von Temperatur, Zeit, Tag und Wochenprogramm
- 4 Einstellungen speichern
- 5 Boostbetrieb
- 6 Stellscheibe für die Temperatúrauswahl
- 7 LCD-Anzeige

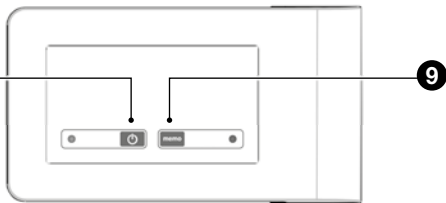

- 8 Einschalten / Standby-Betrieb
- 9 Funk-Verbindung, manuelle Aktivierung Heizung

• Übersicht über die Segmente

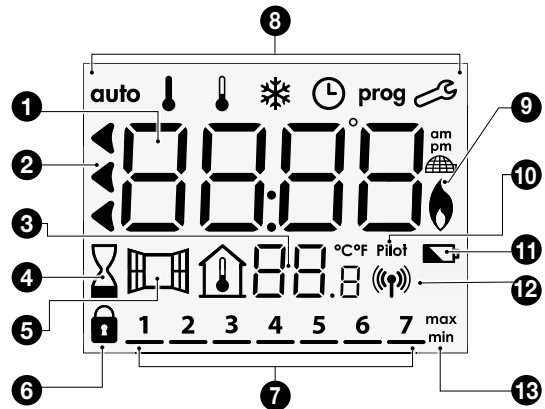

Wochentage (1 = Montag, ... 7 = Sonntag)

- 1 Temperatur-Sollwert / Infos
- 2 Energieverbrauch
- 3 Gemessene Raumtemperatur
- 4 Boostbetriebsanzeige
- 5 Fenster-offen-Erkennung
- 6 Tastatursperre aktiv
- 9 Heizbetrieb
- 10 Fil Pilote Steuerleitung (nur für Frankreich)
- 11 Batterieladung
- 12 Funksignal
- 13 Min.-/Max.-Wert

8 Betriebsmodi:

auto Automatikbetrieb ↓ Komfortbetrieb ↓ Eco-Betrieb
 * Frostschutzfunktion ⌚ Zeit- und Wochentag einstellen
prog Programmiermodus 🔗 Einstellungen

EINSCHALTEN / STANDBY-BETRIEB

Drücken Sie die Taste, um die Reglers im Auto-Modus einzuschalten. Drücken Sie die Taste erneut, um die Regler in den Standby-Betrieb zu schalten.

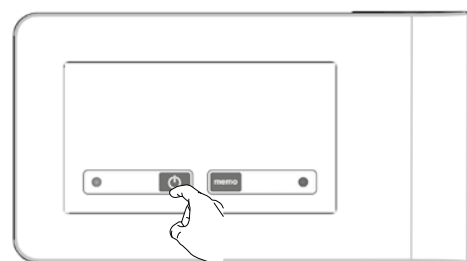
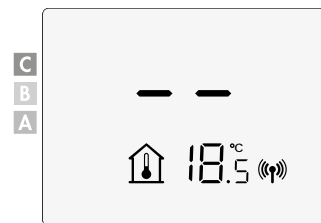
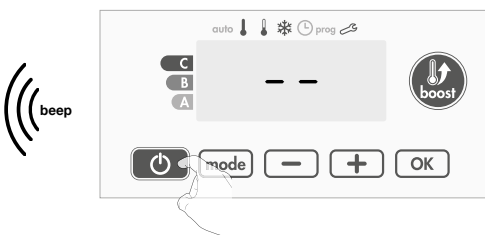
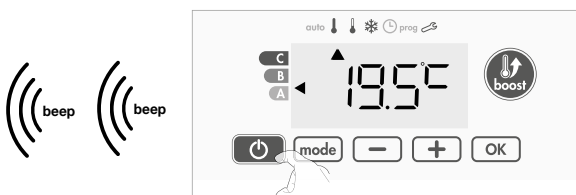

BETRIEBSMODUS

Mit der Taste  Regelgerät auf die eigenen Betriebsmodus einstellen.



Reihenfolge der Betriebsmodi:

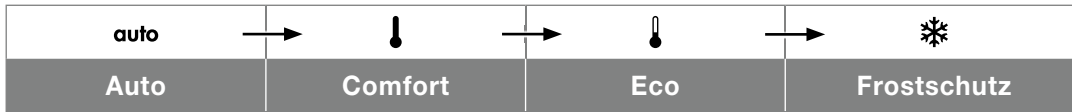

- **auto Automatikbetrieb (3 Situationen)**

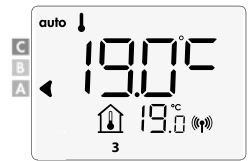

1 Wochenprogramm eingestellt

Wenn ein Wochenprogramm eingestellt wurde, wechselt der Regler automatisch zwischen dem Komfort- und dem Eco-Modus.

BASIC Bei einem Stromausfall von mehr als 3 Stunden müssen Tag und Uhrzeit neu eingestellt werden, das Wochenprogramm bleibt dauerhaft gespeichert.

2 Programmierung über Steuerleitung (nur für Frankreich)

3 Wochenprogramm nicht eingestellt

Wenn das Wochenprogramm nicht eingestellt ist, arbeitet der Heizkörper dauerhaft im Komfortmodus.

- **↓ Comfort (Komfortbetrieb)**

Dauerhafter Komfortbetrieb. Das Regelgerät wird 24 Stunden am Tag betrieben, um dabei die voreingestellte Solltemperatur (z. B. 19 °C) zu halten. Das im Komfortbetrieb zu erreichende Temperaturniveau kann vom Nutzer beeinflusst werden

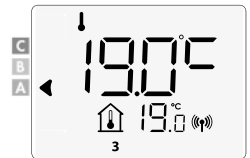

- **↓ Eco (Eco-Betrieb)**

Die Eco-Temperatur richtet sich nach der Solltemperatur im Komfortbetrieb, jedoch abzüglich 3,5 °C. Dadurch können Sie die Solltemperatur senken, ohne hierfür die Einstellungen für den Komfortbetrieb (Comfort) zu ändern. Wählen Sie diese Funktion für die Nachtabsenkung oder eine kurzfristige Abwesenheit (zwischen 2 und 24 Std.) aus.

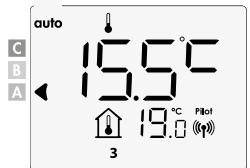

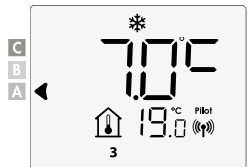

- **❄ Frostschutzfunktion**

Mit dieser Funktion können Sie Ihr Haus gegen Frostauswirkungen (eingefrorene Rohrleitungen etc.) schützen, indem zu allen Zeiten eine Mindesttemperatur von 7 °C eingehalten wird. Aktivieren Sie diese Funktion, wenn Sie Ihr Haus für längere Zeit (über 5 Tage) verlassen.



KOMFORTTEMPERATUR EINSTELLEN

Über den Automatik- und Komfortbetrieb (Auto bzw. Comfort) haben Sie Zugriff auf die im Komfortbetrieb programmierte Solltemperatur. Der voreingestellte Temperaturwert beträgt 19 °C.

Mit  und  können Sie in Schritten zu 0,5 °C eine Solltemperatur zwischen 7 °C und 30 °C einstellen.

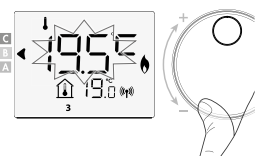
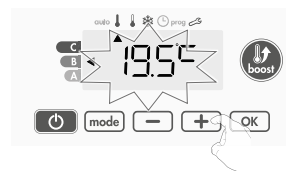

BOOST

Wichtig: Sie können die Boostfunktion zu jeder Zeit und unabhängig vom aktuellen Betriebsmodus (Auto, Comfort, Eco oder Frostschutz) aktivieren.

Erste Betätigung = Boostbetrieb

Innerhalb dieser ersten Minute können Sie die Boostdauer zwischen 0 Minuten und der max. zulässigen Boostzeit über die Tasten **-** und **+** einstellen.

Die Einstellung wird gespeichert und beim nächsten Boostbetrieb wirksam.

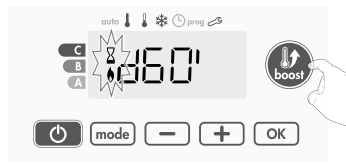

Anmerkung: Nach 1 Minute können Sie die Boostzeit temporär ändern, d. h. die Änderung ist nur für diesen Boostvorgang gültig und wird anschließend gelöscht.

Der Boostbetrieb wird unterbrochen, wenn die Umgebungstemperatur die max. Boosttemperatur erreicht wird.

Das Regelgerät unterbricht den Heizbetrieb, wobei die Boostfunktion weiterhin aktiv ist, d. h. es wird weiterhin der Boosttimer angezeigt. Unterschreitet die Temperatur die max. zulässige Boosttemperatur, wird der Heizbetrieb bis zum Ende der Boostzeit fortgesetzt.



Zweite Betätigung = Boostbetrieb abbrechen

Der Cursor springt zum zuletzt aktiven Betriebsmodus und das Gerät zeigt die Solltemperatur an.

ENERGIEVERBRAUCH

Ein Pfeil zeigt die aktuelle Energieverbrauchsstufe (rot, orange, grün) an.

<p>C - Rot Höherer Verbrauch</p>	<p>Solltemperatur > 22°C</p>
<p>B - Orange Durchschnittliches Verbrauch</p>	<p>Solltemperatur > 19°C ≤ 22°C</p>
<p>A - Grün Geringerer Verbrauch</p>	<p>Solltemperatur ≤ 19°C</p>

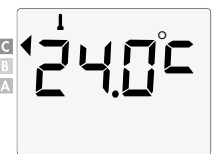

- Anzeige des kumulierten Verbrauchsmenge in kWh**

Drücken Sie für eine Anzeige der kumulierten Verbrauchsmenge in dem Betriebsmodi Auto, Comfort, Eco oder Frostschutz auf **OK**. Drücken Sie eine beliebige Taste, um die Anzeige der Verbrauchsmenge zu beenden. Das Gerät kehrt in den zuletzt aktiven Betriebsmodus zurück.

- Verbrauchsmessung zurücksetzen**

Gehen Sie wie folgt vor, um den Energiezähler im Modus Auto, Comfort, Eco oder Frostschutz zurückzusetzen:

1- Drücken Sie **OK** .

2- Drücken Sie länger als 5 s gleichzeitig die Tasten **-** und **+** . Drücken Sie eine beliebige Taste, um das Zurücksetzen der Verbrauchsmessung zu bestätigen. Das Gerät kehrt in den zuletzt aktiven Betriebsmodus zurück.

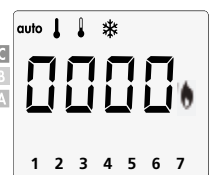
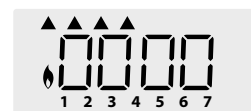

BEDIENFELD SPERREN / ENTPERREN

• Bedienfeld sperren

Halten Sie zum Sperren des Bedienfelds die Tasten und 10 s lang dauerhaft gedrückt. Wenn auf dem Display das Symbol (Vorhängeschloss) erscheint, dann ist das Bedienfeld gesperrt.

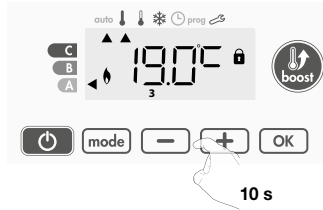

• Bedienfeld entsperren

Halten Sie zum Entsperrern des Bedienfelds erneut die Tasten und 10 s lang dauerhaft gedrückt. Wenn das Vorhängeschloss nicht mehr angezeigt wird, dann ist das Bedienfeld entsperrt.

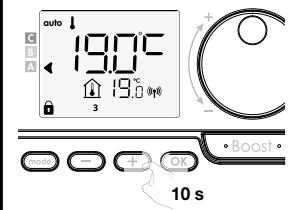

BASIC RF

UHRZEIT UND TAG EINSTELLEN

1- Drücken Sie in den Betriebsmodi Auto, Comfort, Eco oder Frostschutz 5 s lang Taste .

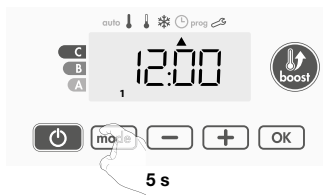

2- Die beiden Stundenziffern beginnen zu blinken. Auswahl mit oder . Um das Scrollen der Stundenziffern zu beschleunigen, müssen Sie oder dauerhaft drücken.

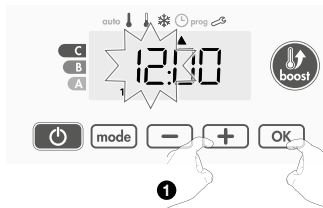

Einstellung mit Taste speichern.

3- Die beiden Minutenziffern beginnen zu blinken. Auswahl mit oder .

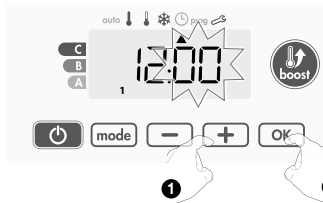

Einstellung mit Taste speichern.

4- Der Cursor über der Ziffer 1 (= Montag) beginnt zu blinken. Stellen Sie den aktuellen Wochentag mit oder ein.

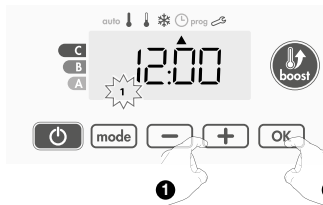

Einstellung mit Taste speichern.

Montag	1	Freitag	5
Dienstag	2	Samstag	6
Mittwoch	3	Sonntag	7
Donnerstag	4		

5- Mit drücken der Taste können Sie Programme ändern und/oder zuweisen.

Zum Verlassen des Einstellmenüs drücken Sie 3 x Taste .

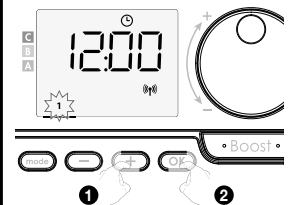
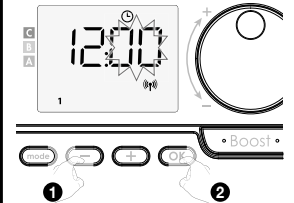
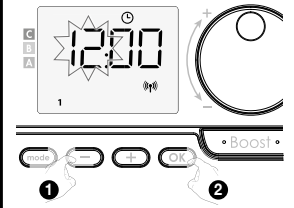

BASIC RF

ÜBERSICHT DER PROGRAMME

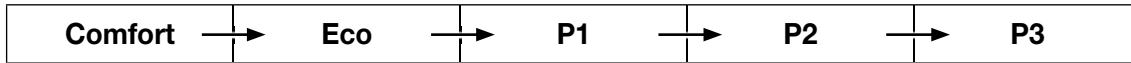

Ihr Regelgerät ist standardmäßig auf einen dauerhaften (7 Tage / Woche) Komfortbetrieb (Comfort) eingestellt.

- **Comfort:** Ihr Regelgerät wird 24 Std. am Tag an den eingestellten Wochentagen im Komfortbetrieb betrieben.
- **Eco:** Das Regelgerät wird 24 Std./Tag im Eco-Betrieb betrieben.
Hinweis: Die Solltemperatur für den Eco-Betrieb ist einstellbar (siehe installateureinstellungen).
- **P1:** Ihr Regelgerät wird für 1 Zeitblock z.B. von 06.00 Uhr bis 22.00 Uhr im Komfortbetrieb betrieben und von 22.00 Uhr bis 06.00 Uhr im Eco-Betrieb (Nachtabenkung).
- **P2:** Ihr Regelgerät wird für 2 Zeitblöcke z.B. von 06.00 Uhr bis 09.00 Uhr sowie von 16.00 Uhr bis 22.00 Uhr im Komfortbetrieb betrieben (von 09.00 Uhr bis 16.00 Uhr sowie von 22.00 Uhr bis 06.00 Uhr im Eco-Betrieb).
- **P3:** Ihr Regelgerät wird für 3 Zeitblöcke z.B. von 06.00 Uhr bis 08.00 Uhr, sowie von 12.00 Uhr bis 14.00 Uhr und von 18.00 Uhr bis 23.00 Uhr im Komfortbetrieb betrieben (von 23.00 Uhr bis 06.00 Uhr, sowie von 08.00 Uhr bis 12.00 Uhr und von 14.00 Uhr bis 18.00 Uhr im Eco-Betrieb).

! Hinweis: Wenn die Standardzeiten von P1, P2 und P3 nicht zu Ihnen passen, können Sie sie ändern. Diese Zeit gilt jedoch für alle Tage der Woche, an denen P1, P2 oder P3 eingestellt ist

WOCHENPROGRAMM EINSTELLEN

1- Drücken Sie im Auto-, Komfort-, Eco- oder Frostschutzmodus 5 Sekunden lang auf **mode** .
 Wenn sich der Cursor über dem Zeiteinstellungs- symbol befindet, drücken Sie kurz die Taste **mode** .

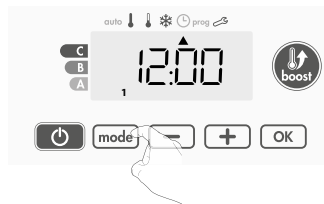

2- Drücken Sie **+** oder **-** , um das Wochenprogramm einzustellen.

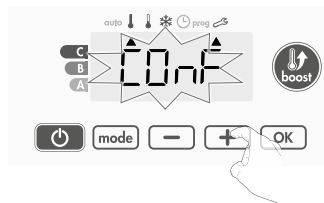

3- Wählen Sie mit **+** oder **-** das gewünschte Programm aus. Falls gewünscht, können die Standardzeiten eingestellt werden: Drücken Sie mindestens 5 Sekunden lang **OK** . Wenn die Standardzeiten gelten, drücken Sie **OK** , um den nächsten Tag einzustellen (fahren Sie mit Schritt 4 fort).

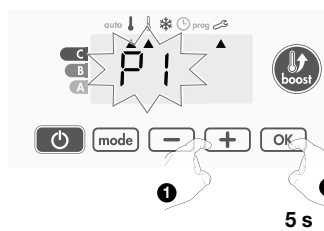

3.1- Die Startzeit blinkt und mit **+** oder **-** können Sie diese Zeit alle 30 Minuten ändern.
 Drücken Sie zum Speichern **OK** .



3.2- Die Endzeit blinkt und mit **+** oder **-** können Sie diese Zeit alle 30 Minuten ändern.
 Drücken Sie zum Speichern **OK** .

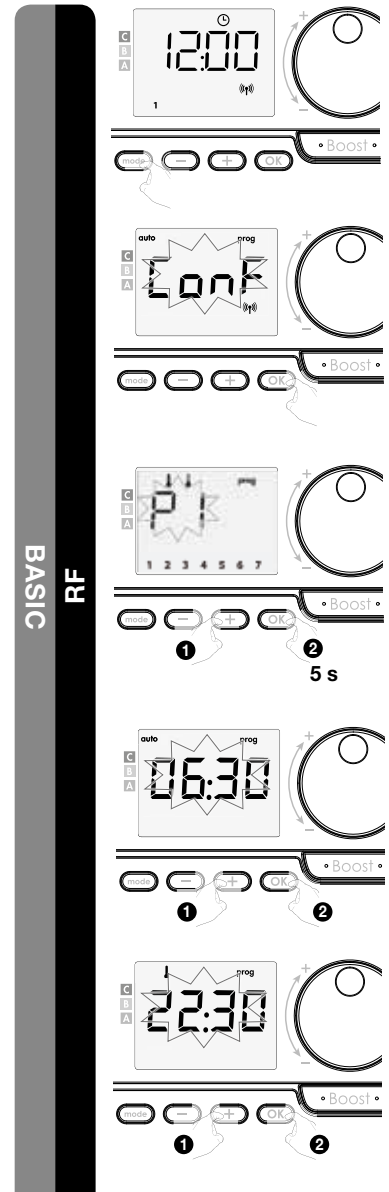
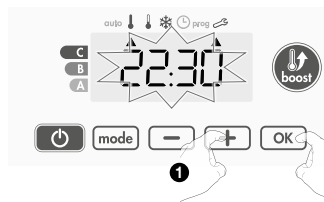

- 4- Der zweite Tag (Dienstag) blinkt.
Wiederholen Sie den oben beschriebenen Vorgang für jeden Tag der Woche.

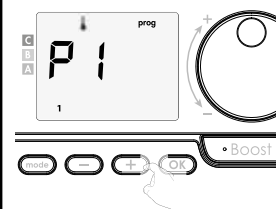
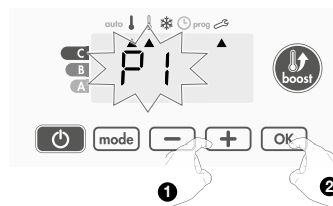

- 5- Wenn Sie für jeden Tag ein Programm ausgewählt haben, bestätigen Sie Ihre Auswahl mit **OK**. Die Wochentage werden mit den Programmen angezeigt, die Sie für sie eingestellt haben. Drücken Sie zweimal **mode**, um den Programmiermodus zu verlassen und zum "Auto - Modus" zurückzukehren. Wenn für einige Minuten keine Taste gedrückt wird, kehrt das Gerät automatisch in den „Auto-Modus“ zurück.

WOCHENPROGRAMM ANZEIGEN

Drücken Sie in den Betriebsmodi Auto, Comfort, Eco oder Frostschutz 5 s lang Taste **mode**. Drücken Sie zwei Mal **mode** um die jedem einzelnen Wochentag zugeordneten Programme (Comfort, Eco, P1, P2 bzw. P3) nacheinander anzeigen zu lassen.

Um den Betrachtungsmodus zu beenden zwei Mal **mode** drücken.

WOCHENPROGRAMM ZEITWEILIGE ÜBERSCHREIBEN

Mit dieser Funktion können Sie vorübergehend die Solltemperatur ändern. Diese Änderung gilt bis zum nächsten programmierten Änderungszeitpunkt bzw. bis 0.00 Uhr.

Beispiel:

- Das Regelgerät befindet sich im Automatikbetrieb und führt das Eco-Programm (Solltemp. 15,5 °C) aus.
- Mit **-** oder **+**, können Sie vorübergehend die Soll-Temperatur auf z. B. 18 °C oder höher, ändern.
- Diese Änderung wird automatisch beim nächsten Programmwechsel oder um 0.00 Uhr zurückgesetzt.

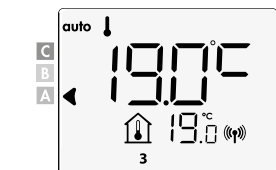
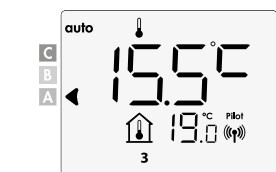
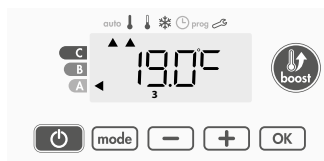
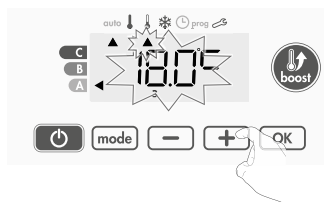
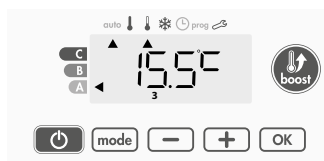

FENSTER-OFFEN-ERKENNUNG

Die Erkennung des offenen Fensters ist empfindlich gegen Temperaturschwankungen. Das Steuergerät reagiert bei geöffneten Fenstern nach verschiedenen Parametern: Temperatureinstellung, Anstieg und Abfall der Raumtemperatur, Außentemperatur, Position des Steuergeräts usw. Befindet sich das Steuergerät in der Nähe einer Vordertür, kann die Erkennungsluft gestört werden die Tür öffnen Wenn dies ein Problem ist, empfehlen wir Ihnen, die Fenstererkennung zu deaktivieren (siehe Einstellungen des Installationsprogramms).

Wenn die Steuerung durch Öffnen eines Fensters zu einem Temperaturreduzierungszyklus übergeht, erscheint auf dem Display ein Frostschutzzähler, der die Zyklusdauer anzeigt. Der Zähler wird beim nächsten Einschalten des Frostschutzes automatisch auf Null zurückgesetzt. Auf Knopfdruck wird der Frostschutzmodus deaktiviert.

Hinweis: Wenn ein Temperaturanstieg festgestellt wird, kehrt die Steuerung automatisch in den vorherigen Modus zurück.

BENUTZEREINSTELLUNGEN

ZUGANG

Wenn Sie in der Betriebsart Auto, Komfort, Eco oder Frostschutz sind:

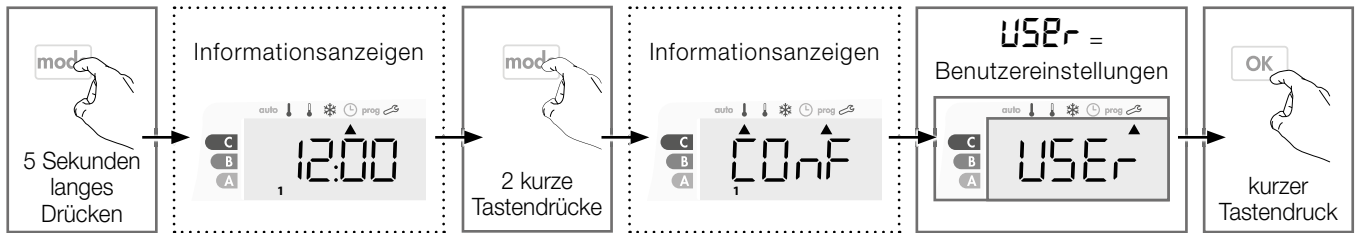

Die folgenden Einstellungen stehen zyklisch nacheinander zur Verfügung:

Hintergrundbeleuchtung → Eco Temperatursenkung → Frostschutz Temperatureinstellung → obere und untere Komforttemperaturgrenze → Maximale Boost-dauer → Maximale Boost-Temperatur → Temperatureinheit → Zurücksetzen der Werkseinstellungen

HINTERGRUNDBELEUCHTUNG

1- Es gibt drei Möglichkeiten zur Verfügung

- L1 = Zeitweilige Hintergrundbeleuchtung: Display leuchtet nur beim Drücken einer Taste.
- L2 = Ständige Hintergrundbeleuchtung: Display leuchtet ständig.
- L3 = L1

Option Die Standardeinstellung ist L3.

Drücken Sie die gewünschte Taste **+** oder **-**.

2- Zur Bestätigung und Erreichung der folgenden Einstellung drücken Sie bitte auf **OK**.

Zur Bestätigung und zum Verlassen der Einstellungen drücken Sie bitte 2x auf **mode**.

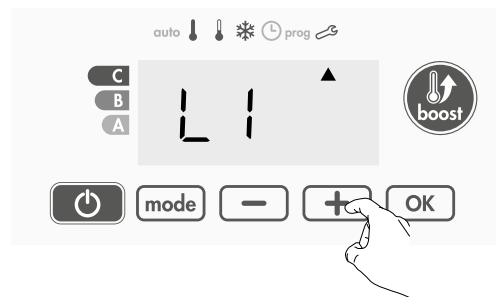

ECO TEMPERATURSENKUNG

Die Temperatursenkung ist auf 3,5°C unter der Komfort-Solltemperatur eingestellt. Sie können diese Temperatursenkung in 0,5°C Schritten von -1°C bis auf - 8°C ändern.

Wichtig: Unabhängig von der Temperatursenkungseinstellung des Benutzers kann die Economy-Solltemperatur nie höher als 19°C sein.

1- Drücken Sie auf **-** oder **+** um den gewünschten Wert anzuzeigen.

2- Zur Bestätigung und Erreichung der folgenden Einstellung drücken Sie bitte auf **OK**.

Zur Bestätigung und zum Verlassen der Einstellungen drücken Sie bitte 2x auf **mode**.

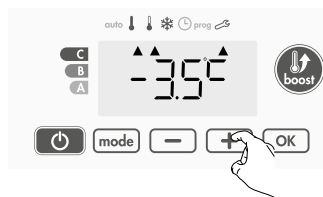

FROSTSCHUTZ TEMPERATUREINSTELLUNG

Der Frostschutz ist auf 7°C voreingestellt, Sie können diese Temperatur in 0,5°C Schritten von 5°C bis 15°C einstellen.

1- Drücken Sie auf **-** oder **+** um den gewünschten Wert anzuzeigen.

2- Zur Bestätigung und Erreichung der folgenden Einstellung drücken Sie bitte auf **OK**.

Zur Bestätigung und zum Verlassen der Einstellungen drücken Sie bitte 2x auf **mode**.

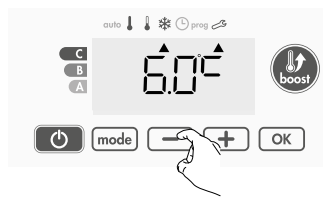

OBERE UND UNTERE KOMFORTTEMPERATURGRENZE

• untere Grenze

Die werksseitig eingestellte untere Grenze beträgt 7°C. Sie können sie in 1°C Schritten bis auf 15°C erhöhen.

- 1- Zur Änderung drücken Sie **-** oder **+** und bestätigen mit **OK**.

Wenn Sie sie nicht ändern wollen, drücken Sie **OK**: das Gerät schlägt Ihnen automatisch die Einstellung der maximalen Solltemperatur vor. Zur Bestätigung und zum Verlassen der Einstellungen drücken Sie bitte 2x auf **mode**.

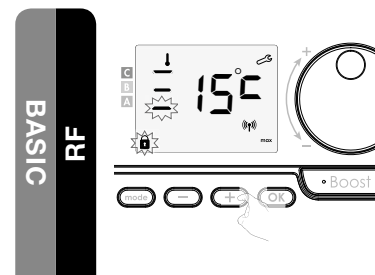
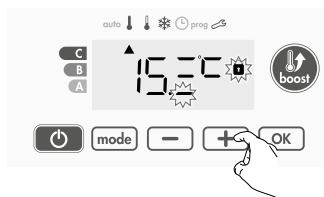

• obere Grenze

Die werksseitig eingestellte obere Grenze beträgt 30°C. Sie können sie in 1°C Schritten bis auf 19°C absenken.

- 2- Zur Änderung drücken Sie bitte auf **-** oder **+**.

Zur Bestätigung und Erreichung der folgenden Einstellung drücken Sie bitte auf **OK**.

Zur Bestätigung und zum Verlassen der Einstellungen drücken Sie bitte 2x auf **mode**.

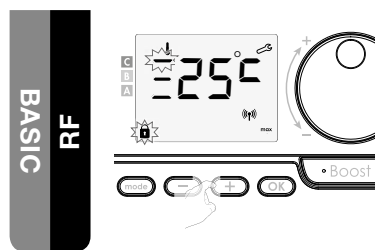
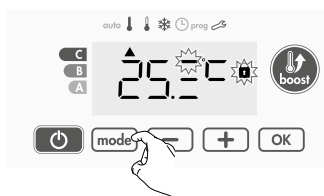

MAXIMALE BOOSTDAUER

Die Boostdauer ist auf 60 Minuten voreingestellt. Sie können die Boostdauer auf 30, 60 oder 90 Minuten einstellen.

- 1- Das Boost-Symbol und die Heizungsanzeige erscheinen im Display und die eingestellte Dauer von 60 Minuten blinkt.

- 2- Drücken Sie auf **-** oder **+** um die gewünschte Dauer anzuzeigen.

- 3- Zur Bestätigung und Erreichung der folgenden Einstellung drücken Sie bitte auf **OK**. Zur Bestätigung und zum Verlassen der Einstellungen drücken Sie bitte 2x auf **mode**.

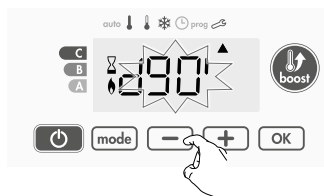
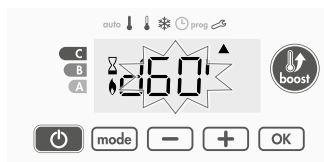

MAXIMALE BOOST-TEMPERATUR

Wenn der Boostmodus eingeschaltet ist, heizt der Heizkörper den Raum bis zur Temperatur-Obergrenze auf.

Wenn sie erreicht ist, schaltet sich der Boostmodus automatisch ab. Die werksseitig eingestellte Temperatur-Obergrenze beträgt 35°C. Sie können sie in 1°C Schritten bis auf 39°C erhöhen oder auf 39°C erhöhen.

- 1- Das Boost-Symbol und die Heizungsanzeige erscheinen im Display und die Maximaltemperatur blinkt.

- 2- Sie können die maximale Boosttemperatur durch mehrmaliges Drücken der Taste **-** oder **+** in 1°C Schritten bis auf 39°C erhöhen.

- 3- Zur Bestätigung und Erreichung der folgenden Einstellung drücken Sie bitte auf **OK**. Zur Bestätigung und zum Verlassen der Einstellungen drücken Sie bitte 2x auf **mode**.

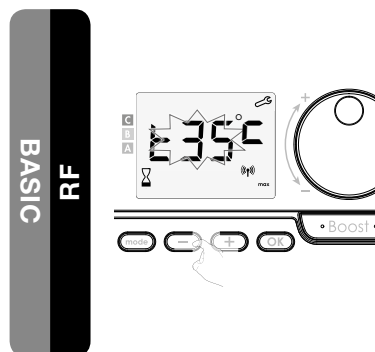
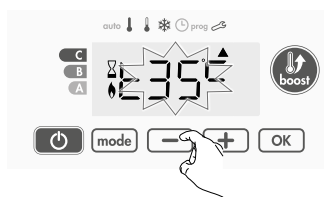

TEMPERATUREINHEIT

Die Temperatureinheit standardmäßig auf Grad Celsius eingestellt.

- 1- Zur Umstellung auf Grad Farenheit drücken Sie bitte auf **-** oder **+**.
- 2- Zur Bestätigung und Erreichung der folgenden Einstellung drücken Sie bitte auf **OK**.
Zur Bestätigung und zum Verlassen der Einstellungen drücken Sie bitte 2x auf **mode**.

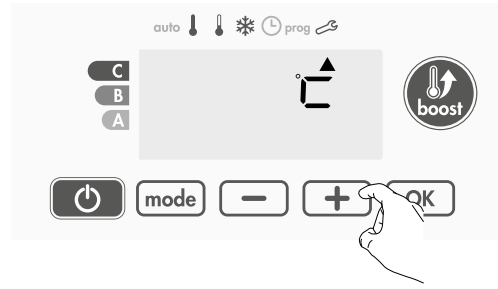

ZURÜCKSETZEN DER WERKSEINSTELLUNGEN

- 1- **rest** erscheint 1 Sekunde lang.
- 2- **no** blinkt. Drücken Sie auf **-** oder **+** zur Auswahl von **yes**.
- 3- Drücken Sie 5 Sekunden lang auf **OK**.
Das Gerät wird auf die Werkseinstellungen und in die Auto Betriebsart zurückgesetzt.

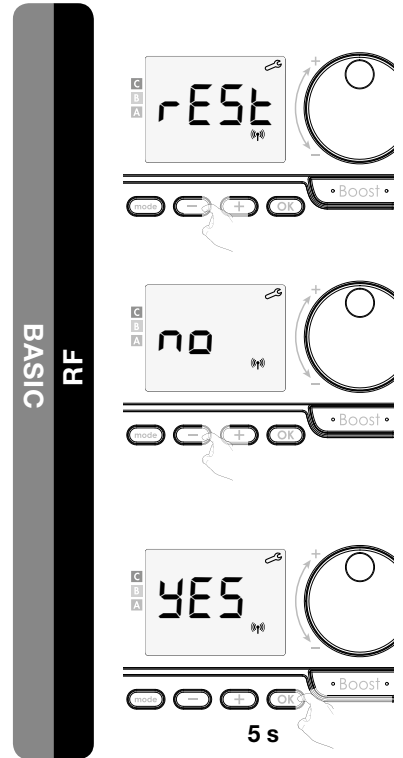
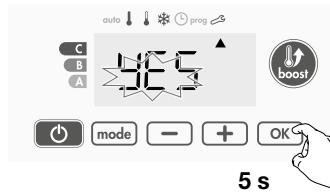
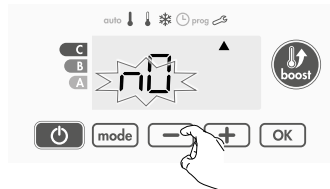
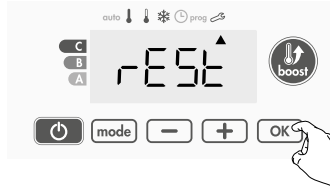

Grundeinstellungen

Komforttemperatur	19 °C
Boostdauer	60 min.
Tastenverriegelung	nicht eingeschaltet

Benutzereinstellungen

Hintergrundbeleuchtung	L3	BASIC
Eco Temperatursenkung	-3,5 °C	
Frostschutztemperatur	7 °C	
Untergrenze Komforttemperatur	7 °C	
Obergrenze Komforttemperatur	30 °C	
Maximale Boostdauer	60 min.	
Maximale Boost-Temperatur	35 °C	
Temperatureinheit	°C	

Drücken Sie 2x auf **mode** zum Verlassen der Einstellungen.

INSTALLATEUREINSTELLUNGEN

ZUGANG

Wenn Sie in der Betriebsart Auto, Komfort, Eco oder Frostschutz sind:

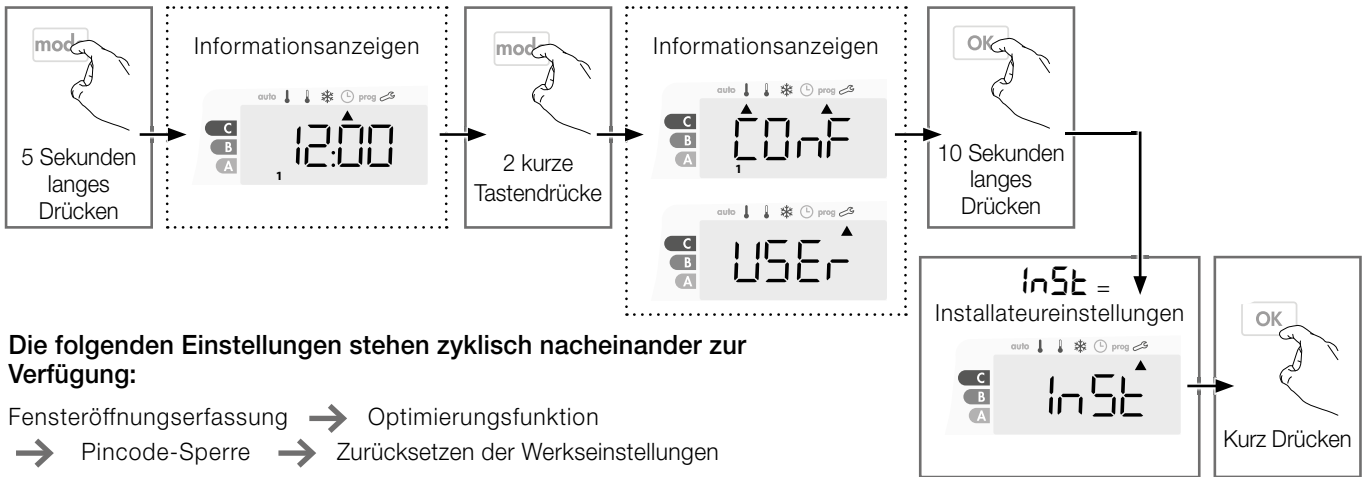

Die folgenden Einstellungen stehen zyklisch nacheinander zur Verfügung:

- Fensteröffnungserfassung → Optimierungsfunktion
- Pincode-Sperre → Zurücksetzen der Werkseinstellungen

FENSTERÖFFNUNGSERFASSUNG

1- Die automatische Fensteröffnungserkennung ist standardmäßig eingeschaltet.

2- Drücken Sie auf **-** oder **+**.

- On** = Automatikbetrieb eingeschaltet.
- OFF** = Automatikbetrieb ausgeschaltet.

3- Zur Bestätigung und Erreichung der folgenden Einstellung drücken Sie bitte auf **OK**. Zur Bestätigung und zum Verlassen der Einstellungen drücken Sie bitte 3x auf **mode**.

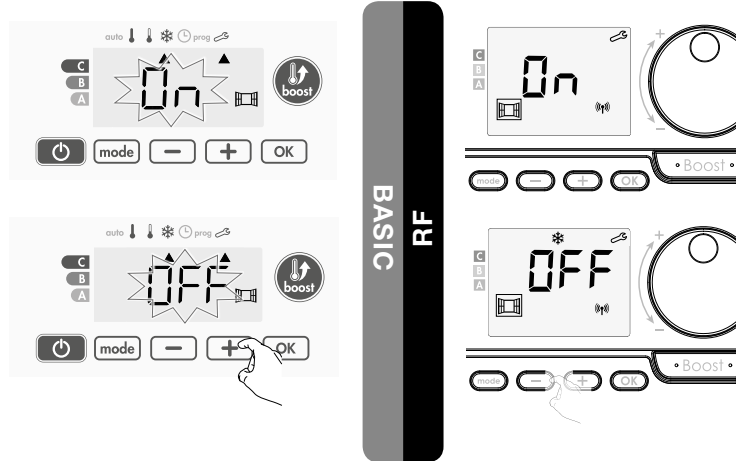

OPTIMIERUNGSFUNKTION

- Im **OPTI ECO-Modus (Energieeffizienz)** berechnet die Steuerung den besten Kompromiss, um maximale Energieeinsparungen während der programmierten Heiz- und Kühlphasen sicherzustellen. Eine leichte Abnahme des Temperaturniveaus zu Beginn und am Ende der Komfortperiode ermöglichte die Maximierung der Energieeinsparung.

- Im **OPTI COMFORT-Modus (Komfort Effizienz)** berechnet die Steuerung den besten Kompromiss, um maximalen Komfort während der programmierten Heiz- und Kühlphasen zu gewährleisten. Vorrang hat die Vorwegnahme und Aufrechterhaltung der Komforttemperatur während der erfassten Anwesenheitsperioden.

Der OPTI COMFORT-Modus ist standardmäßig aktiviert. Das Wort **OP / :** erscheint kurz im Display und wechselt dann mit dem eingestellten **ConF**-, **ECO**- oder **OFF**-Modus. **ConF** = Optimierungsfunktion für den OPTI COMFORT-Modus aktiviert, Priorität für Komfort.

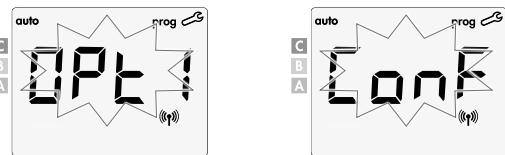

1- Drücken Sie **-** oder **+**.

- ConF** = Optimierungsfunktion für den Modus aktiviert OPTI COMFORT, Priorität für Komfoteffizienz.
- ECO** = Optimierungsfunktion für den Modus aktiviert OPTI ECO, Priorität für Energieeffizienz.
- AUS** = Optimierungsfunktion deaktiviert.



2- Drücken Sie **OK** um zu speichern und mit der nächsten Einstellung fortzufahren. Drücken Sie 3x auf **mode**, um die Einstellungen zu verlassen.

PINCODE-SPERRE

• Beschreibung

Sie können den 4-stelligen PIN-Code selbst einstellen, wodurch bei Aktivierung die folgenden Funktionen nicht verfügbar sind:

- Der Komfortmodus (Nur die Modi Auto, Eco oder Frostschutz sind verfügbar).
- Einstellen der Komfort- und Eco- und Frostschuttemperatur.
- Ändern des Wochenprogramms.
- Einstellen der Fensteröffnungserkennung.

Bei der ersten Benutzung der „PIN Code Verriegelung“ sind 3 wichtige Schritte auszuführen:

- 1- Eingabe des standardmäßigen PIN Codes (0000), der Zugang zur PIN Code Betriebsart gewährt.
- 2- Aktivierung des PIN Codes zur Sperrung der Einstellungen, die durch den PIN Code geschützt werden sollen.
- 3- Personalisierung des Benutzer PIN Codes (siehe weiter unten), d.h. den Standard PIN Code (0000) durch eine frei gewählte, vierstellige Zahl ersetzen.

• Initialisieren des PIN Codes = '0000'

In der Standardeinstellung ist der PIN Code nicht aktiviert = OFF

- 1- Der standardmäßig gespeicherte PIN Code ist 0000. Mit **-** oder **+** wählen Sie die Zahl 0. Die Zahl blinkt, bestätigen Sie mit **OK**.

- 2- Für die ändern Zahlen, wählen Sie die Ziffer 0 durch Drücken von **OK**. Wenn 0000 am Display erscheint, drücken Sie noch mal zur Bestätigung auf **OK**.

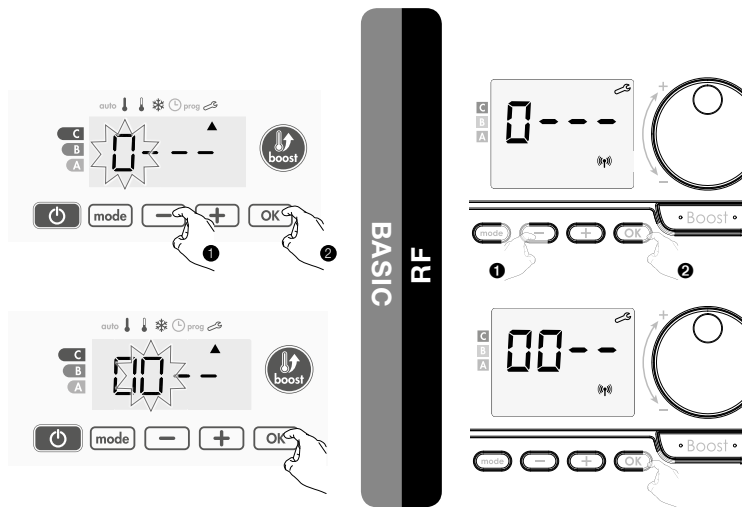

Der PIN Code PIN ist zurückgesetzt. Das Gerät schlägt Ihnen automatisch die Einstellung: PIN Code Aktivierung vor.

• Aktivierung/Deaktivierung des PIN Code

- 1- OFF erscheint im Display.

Drücken Sie auf **-** oder **+** um den PIN Code zu aktivieren.

0n = PIN Code aktiviert
 OFF = PIN CODE deaktiviert

- 2- Zur Bestätigung und Erreichung der folgenden Einstellung drücken Sie bitte auf **OK**.

Der persönliche Benutzer PIN Code ist jetzt aktiv. Personen, die den persönliche Benutzer PIN Code nicht eingeben, können die im Kapitel „Beschreibung“ angeführten Einstellungen nicht mehr verändern.

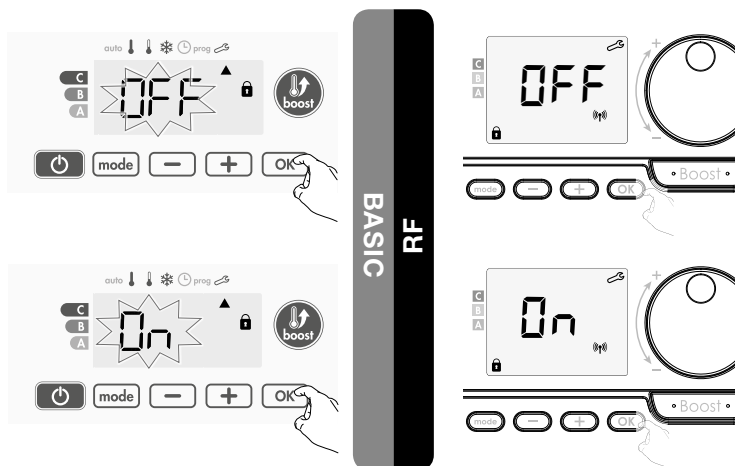

• Personalisierung des PIN Code

- 1- Wenn 0n angezeigt wird, drücken Sie mindestens 5 Sekunden lang auf **OK**.

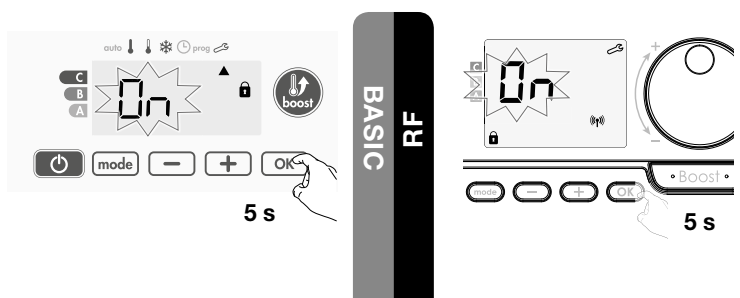

2- Der Code 0000 wird am Display angezeigt und die 1. Zahl blinkt. Mit den Tasten **-** oder **+** wählen Sie die erste Zahl Ihres persönlichen Codes und drücken **OK**, um die Eingabe zu bestätigen. Geben Sie in gleicher Weise die 3 anderen, persönlichen Code-Nummern ein.

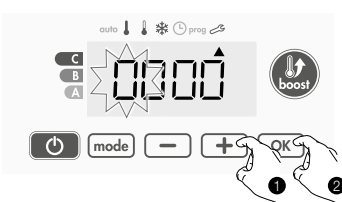

3- Drücken Sie **OK** zur Bestätigung. Ihr persönlicher PIN Code ist nun gespeichert.

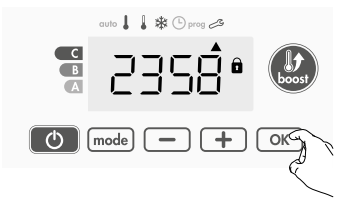

4- Drücken Sie nochmals auf **OK**, um die PIN Code Einstellung zu verlassen und zum Beginn der Installateur-Einstellungen zurück zu kehren.

Drücken Sie 3x auf **mode** zum Verlassen der Einstellungen.

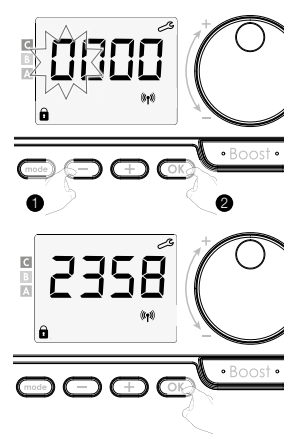

ZURÜCKSETZEN DER WERKSEINSTELLUNGEN

Wenn der PIN Code Schutz nicht aktiviert ist, können Sie die Benutzer und Installateur-Parameterwerte wieder auf deren ursprüngliche Werte zurücksetzen.

1- **rest** erscheint im Display .



2- **no** blinkt.

Drücken Sie auf **-** oder **+** zur Auswahl von **yes**

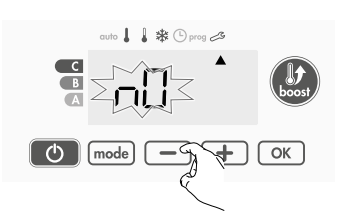

3- Drücken Sie 5 Sekunden lang auf **OK**. Die Einstellungen werden zurückgesetzt und die Steuerung kehrt automatisch in den Auto-Modus zurück.

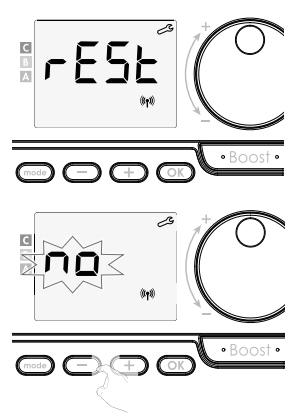

Grundeinstellungen

Komforttemperatur	19 °C
Boostdauer	60 min.
Tastensperriegelung	nicht eingeschaltet

Benutzereinstellungen

Hintergrundbeleuchtung	L3	BASIC
Eco Temperatursenkung	-3,5 °C	
Frostschutztemperatur	7 °C	
Untergrenze Komforttemperatur	7 °C	
Obergrenze Komforttemperatur	30 °C	
Maximale Boostdauer	60 min.	
Maximale Boost-Temperatur	35 °C	
Temperatureinheit	°C	

Einstellungen des Installateurs

Fensteröffnungserkennung	Aktiviert
Optimierungsfunktion	Option Comfort RF
Schutz durch PIN Code	Nicht Aktiviert
Standard PIN Code	0000

Drücken Sie 3x auf **mode** zum Verlassen der Einstellungen.

ERWEITERTE INSTALLATEUREINSTELLUNGEN

ZUGANG

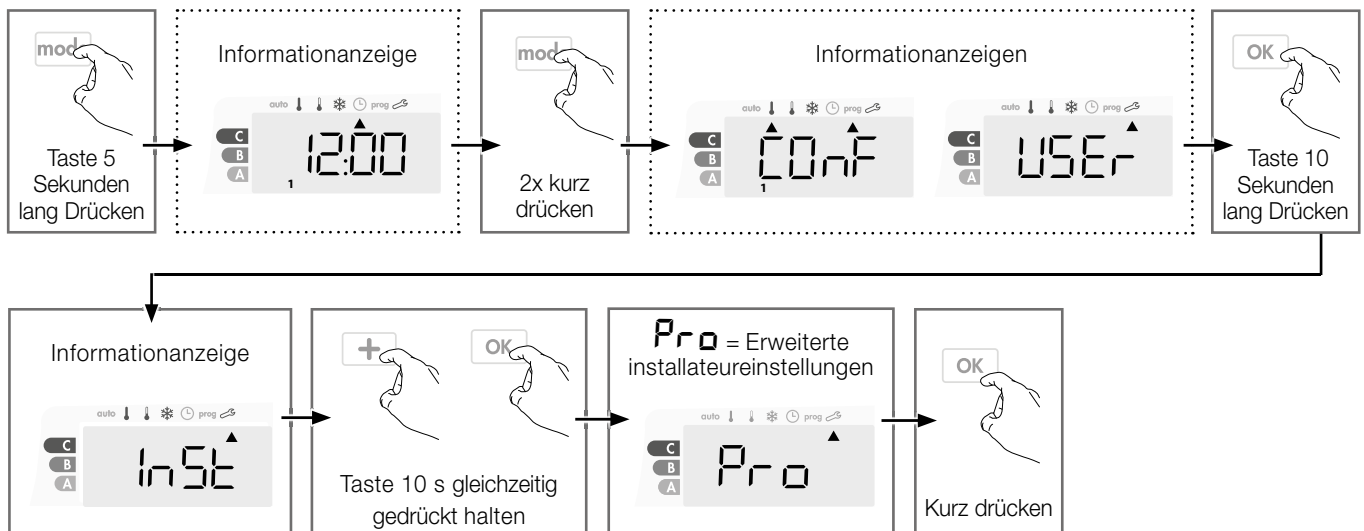

Einstellfolge:

Temperatursensorkalibrierung → Heizkörperleistung → Zurücksetzen der Werkseinstellungen

TEMPERATURSENSORKALIBRIERUNG

• Übersicht

! Dieser Vorgang ist ausschließlich Experten vorbehalten, da Fehleinstellungen zu einem Fehlverhalten des Controllers führen können.

Die Kalibrierung ermöglicht in Schritten von 0,1 Grad (Einstellintervall: zwischen +5 °C und -5 °C) eine Kompensation der Ist-Temperaturdifferenz zwischen Raumtemperatursensor und der tatsächlichen Raumtemperatur.

Die Kalibrierung kann für jede verknüpfte Kontrolle durchgeführt werden. Abhängig von der Anzahl der Kontrollen stellen Sie zunächst die Kalibrierung von der ersten Kontrolle über die zweite bis zur letzten Kontrolle ein. Sie können die Kontrollnummer identifizieren, wenn Sie die Kalibrierung auf dem Display einstellen.

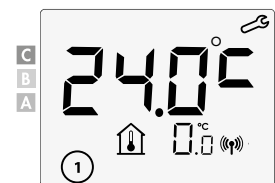

• Kalibrierung

1- Vorgehensweise bei einer negativen Ist-Temperaturdifferenz (Beispiel):

Solltemperatur (gewünscht) = 20 °C

Raumtemperatur (Istwert laut Präzisionsthermometer) = 18 °C

Gemessene Ist-Temperaturdifferenz = -2 °C

! Wir empfehlen, die Kalibrierung erst 4 Stunden nach der letzten Änderung der Solltemperatur vorzunehmen, um eine bereits stabilisierte Raumtemperatur sicherzustellen.

Gehen Sie für den Abgleich wie folgt vor:

Sensortemperatur = 24 °C

Mit Taste **-** die vom Raumtemperatursensor gemessene Temperatur um 2 Grad reduzieren.

Zum Bestätigen des neuen Werts **OK** drücken.

Um den Einstellmodus zu verlassen, 3 x Taste **mode** drücken.



2- Vorgehensweise bei einer positiven Ist-Temperaturdifferenz (Beispiel):

Solltemperatur (gewünscht) = 19 °C

Raumtemperatur (über Präzisionsthermometer gemessener Istwert) = 21 °C

Gemessene Ist-Temperaturdifferenz = +2 °C

Gehen Sie für den Abgleich wie folgt vor:

Sensortemperatur = 21 °C

Mit Taste **+** die vom Raumtemperatursensor gemessene Temperatur um 2 Grad erhöhen.

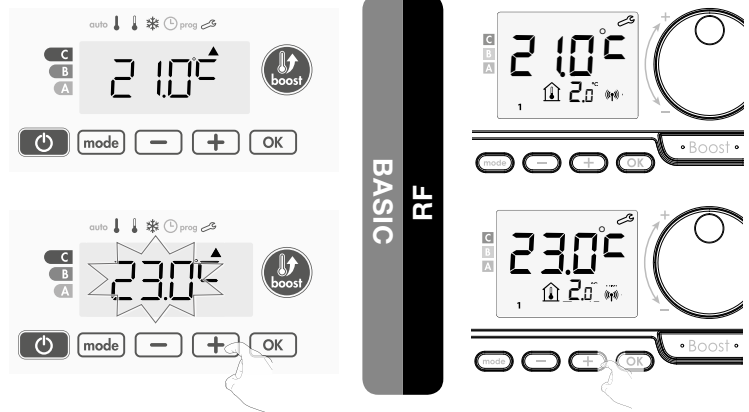

Zum Bestätigen des neuen Werts **OK** drücken. Um den Einstellmodus zu verlassen, 3 x Taste **mode** drücken.

• Zurücksetzen der Sensorkalibrierung

- 1- Wenn die vom Sensor gemessene Temperatur angezeigt wird, drücken Sie mindestens 3 Sekunden lang **-** oder **+**.
- 2- Zur Bestätigung der folgenden Einstellung drücken Sie bitte auf **OK**.
Zum Verlassen der Einstellungen drücken Sie bitte 3x auf **mode**.

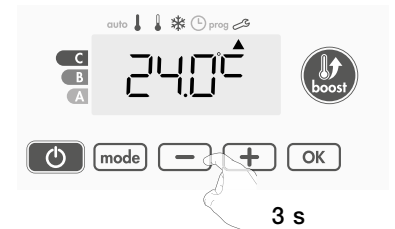

HEIZKÖRPERLEISTUNG EINSTELLEN

Um die ordnungsgemäße Funktion des Heizkörpers zu gewährleisten und den Energieverbrauch richtig einschätzen zu können, ist es wichtig, die Leistung des Heizkörpers anzupassen.

BASIC: Diese Einstellung muss bei der Erstinbetriebnahme vorgenommen werden.

RF: Diese Einstellung wird während der Funkverbindung automatisch angepasst.

- 1- Wählen Sie mit **+** oder **-** einen Wert zwischen 500 W und 1500 W aus.
- 2- Mit **OK** abspeichern und automatisch den nächsten Einstellpunkt aufrufen.
Um den Einstellmodus zu verlassen, 3 x Taste **mode** drücken.

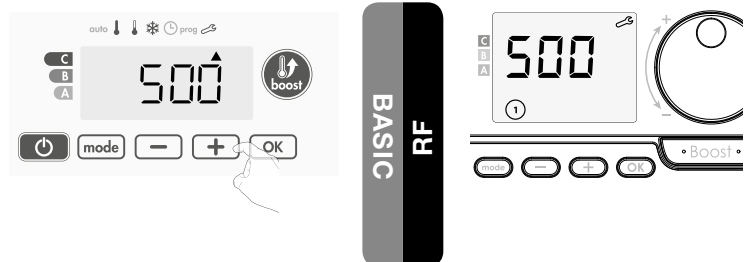

ZURÜCKSETZEN DER WERKSEINSTELLUNGEN

Bei deaktivierter PIN-Sicherung werden die Benutzer-, Installateur- und Erweiterte Installateur-Einstellungen wie folgt neu initialisiert:

- 1- **rEST** erscheint im Display.

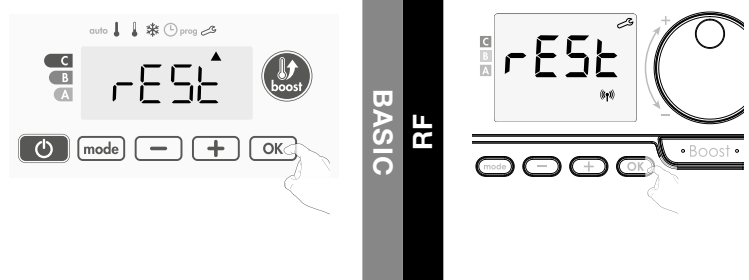

2- **no** erscheint. Drücken Sie auf **-** oder **+** bis **YES** erscheint.

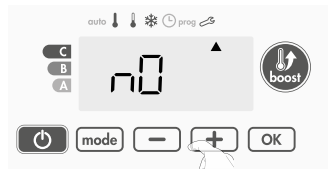

3- Taste **OK** 5 s lang drücken.
Das Gerät setzt sich auf seine Grundeinstellungen zurück und startet im Automatikbetrieb.

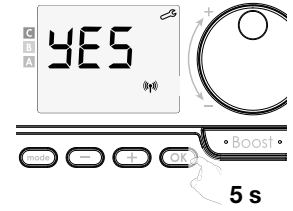
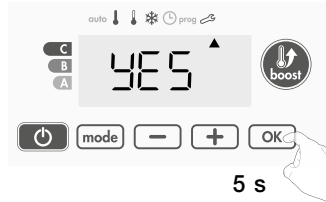

Grundeinstellung

Komforttemperatur	19 °C
Boostdauer	60 min.
Tastenverriegelung	nicht eingeschaltet

Benutzereinstellungen

Hintergrundbeleuchtung	L3	BASIC
Eco Temperatursenkung	-3,5 °C	
Frostschutztemperatur	7 °C	
Untergrenze Komforttemperatur	7 °C	
Obergrenze Komforttemperatur	30 °C	
Maximale Boostdauer	60 min.	
Maximale Boost-Temperatur	35 °C	
Temperatureinheit	°C	

Einstellungen des Installateur

Fensteröffnungserkennung	Aktiviert	
Doppelte Optiemierungsfunktion	Option Comfort	RF
Schutz durch PIN Code	Nicht Aktiviert	
Standard PIN Code	0000	

Erweiterte Installateurseinstellungen

Temperatursensorkalibrierung	0,0
Heizkörperleistung	500W

Um den Einstellmodus zu verlassen, 3 x Taste **mode** drücken.

SAFETY INSTRUCTIONS



The appliance may not be used by people (children, among others) with diminished physical, sensory or mental capacities, or with no know-how or experience, unless those persons are supervised or are given instructions.

Children are not allowed to play with the appliance, not even under supervision..



The radiator may not be covered with another material, nor may it be mounted directly beneath a power socket.

It should be possible, at all times, to turn off the radiator. If it is a plug connector, it should have an external power-off switch. In the case of a corded, fixed connection, the electric circuit should be correctly fused.

When mounting the radiator, please follow the local/national regulations for the cabling installation and adhere to our general terms and conditions.

WASTE DISPOSAL ACCORDING TO THE EUROPEAN UNION (2012/19/EU) DIRECTIVE ON WEEE (WASTE FROM ELECTRICAL AND ELECTRONIC EQUIPMENT)



The symbol on the ID plate of the radiator states that the radiator may not be disposed of as household waste, but should be separated out, to facilitate recycling. Once the radiator is end-of-life, it should be taken to a waste collection point for electrical and electronic goods. For more information about recycling and waste collection points, please contact your local authority/district council or waste collection service in those countries where the directive has been transposed into national law.

TECHNICAL SPECIFICATIONS

- Working voltage: 230 VAC 50 Hz
- Maximum power output of 1500W, resistive load
- Power cable, class II, 800mm, 3 power cables.



The black (hidden and shielded) cable is a communication cable that only applies in **France. On no account may it be connected to the earth and it should be shielded at all times.**

If the power cable is damaged, please contact your installation engineer.

- Power consumption in stand-by mode: <0.5W
- Electronic, relay+triac-controlled PID controller
- IPX4
- Class II, post-installation, for which the installer is liable (to EN60335-1)



WRITTEN DECLARATION FROM THE MANUFACTURER



We hereby declare, at our own risk, that the products described in this instruction manual are CE-certified and meet all the essential requirements of the following directives and harmonised standards:

- LVD 2014/35/EU: EN60335-1/EN60335-2-30/EN60335-2-43/ EN62333
- EMC 2014/30/EU: EN55014-1/EN55014-2-30/EN61000-3-2/ EN61000-3-3
- ERP 2009/125/EC
- RoHS 2011/65/EU: EN50581

and that the products were manufactured according to certified processes, to ISO 9001 V2015.

This appliance complies with the European directive 'ECO Design Directive 2015/1188':

Information requirements for electrical appliances for local space heating			
Parameter	Symbol	Value	Unit
Heat output			
Nominal heat output	P nom	0,5 → 1,5	kW
Minimal heat output	P min	0,5	kW
Maximal continuous heat output	P max,c	1,5	kW
Additional electricity consumption			
At nominal heat output	el max	0,000	kW
At minimal heat output	el min	0,000	kW
In stand-by mode	el sb	0,0005	kW
Type of heat output/control of room temperature			
Electronic control of the room temperature plus a week-time switch			
Other control options			
Control of room temperature, including automatic detection of open windows			
With optional remote control			
RF With adaptive start control			
Contact details			
See ID plate on the radiator			

Warranty conditions:

go to
www.vasco-group.eu

MOUNTING THE CONTROLLER

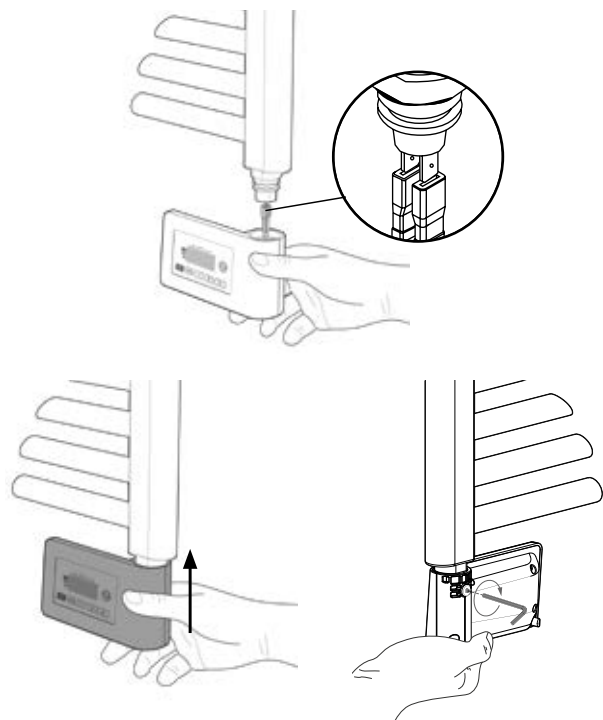

Screw the controller with the included allen key

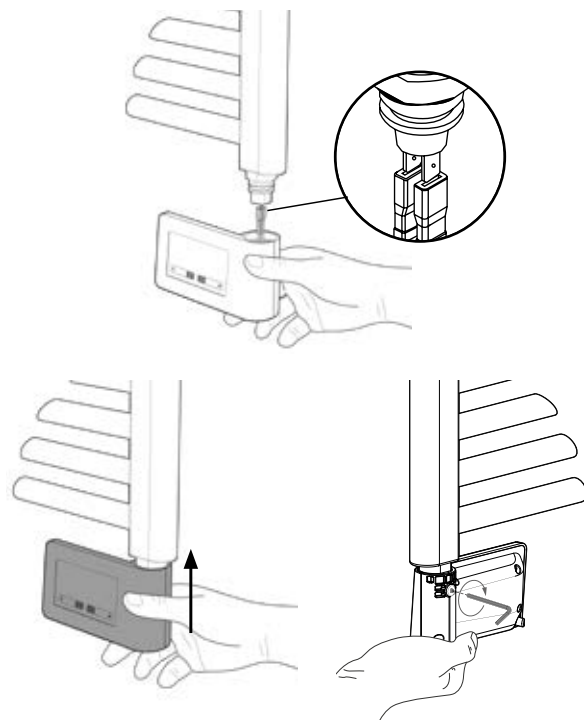

Screw the controller with the included allen key

INSTALLING BATTERIES

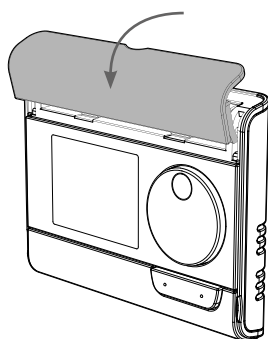

Remove the battery cover which is placed on the front of the RF remote control.

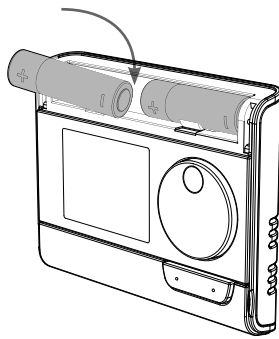

Insert the 2 AA batteries supplied. Note the correct polarity according to the engraving on the RF remote control when inserting the batteries.

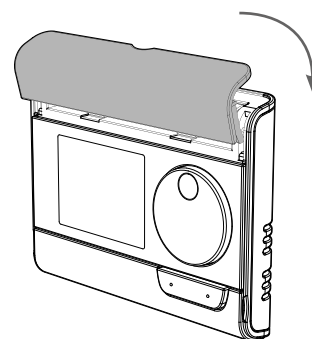

Replace the battery cover.

MOUNTING THE RF REMOTE CONTROL

On the wall

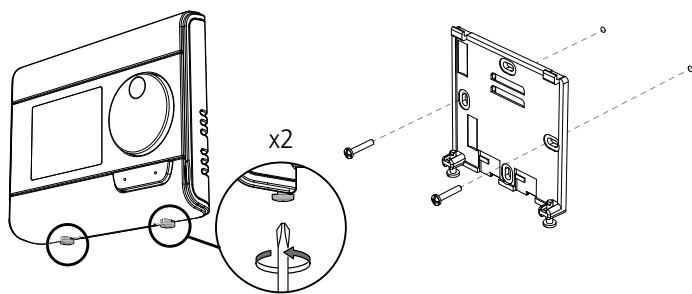

Unscrew the 2 screws under the RF remote control.

Secure the wall plate with the two screws provided using the horizontal and vertical holes.

On the table stand

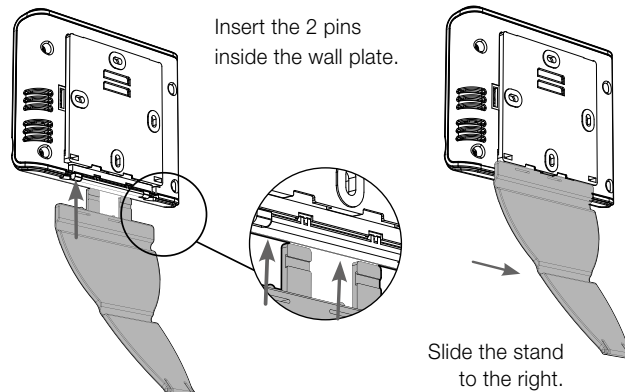

Insert the 2 pins inside the wall plate.

Slide the stand to the right.

BINDING THE RF RECEIVER WITH THE RF REMOTE CONTROL

The RF remote control and the RF receiver are not paired at the factory.

Attention: A maximum of 5 RF receivers can be connected to 1 RF remote control

Proceed as follows and do this for each RF receiver:

RF pairing:

- Put the RF receiver in pairing mode by pressing the **memo** button for 5 sec.
The **memo** LED will start to blink in RED.

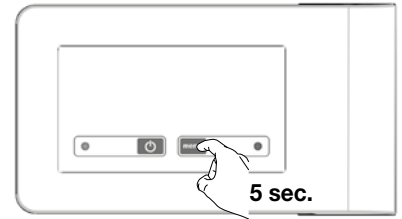

- Put the RF remote control in frost protection mode by pressing the **mode** button 3x and press **OK** for 5 sec.

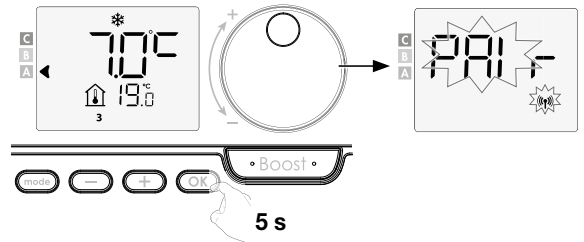

- To ensure correct operation of the radiator, the power of the radiator must be adjusted via the RF remote control. This step is automatically covered during pairing. The power is set to 500W as standard.
Use the **+** and **-** keys to set the power (see rating plate radiator).

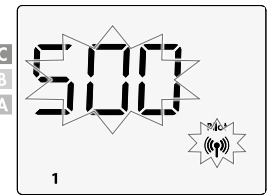

- When the RF remote control and the RF receiver are linked, the **RF** symbol appears and is constantly displayed

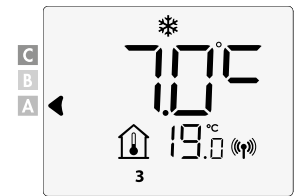

RF pairing cancellation:

Press more than 10 seconds on Memo button of the RF receiver

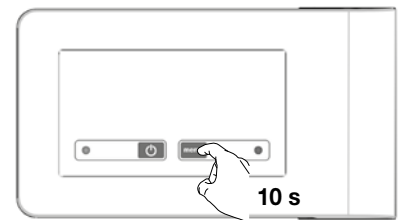

Operating status



Operating status	LED status and colour
Standby	Off
Power on	Green
Heating on	Red
Boost	Blinking red
Frost protection mode, open window detection	Blinking green
Manual override (MEMO-button)	Blinking orange

RF communication status



RF communication status	LED status and colour
Standby	Off
No RF connection	Red
RF pairing mode	Blinking red
RF pairing cancellation	Fast blinking red
RF connection OK	Green
RF message received	1 sec fast blinking green

⚠ RADIATOR POWER

To ensure correct operation of the radiator, the power of the radiator must be adjusted via the controller, by default it is set to 500W.



Follow the steps below:

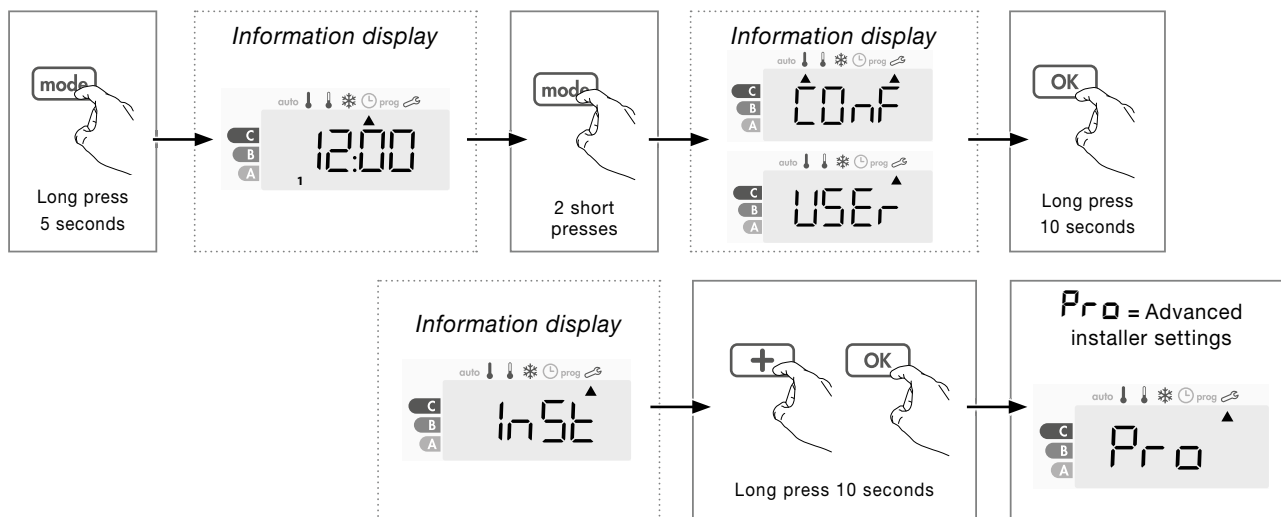

Then press 2x button **OK** and change the power using the buttons **-** and **+**. Exit the menu by pressing 3x button **mode**.

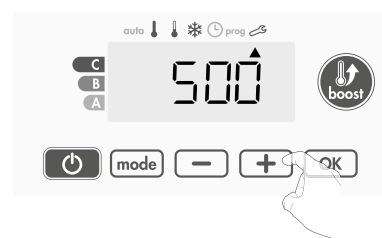

OPERATION

• Buttons overview

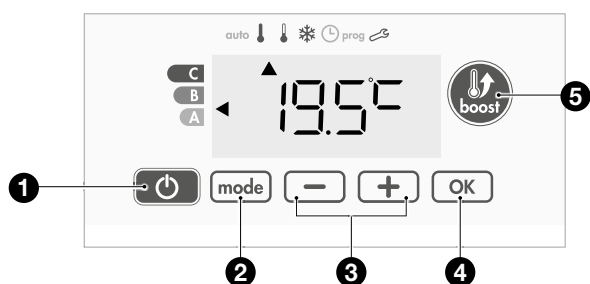

- 1 Power on/standby
- 2 Selecting operating modes
- 3 Plus and minus buttons, used to set temperatures, time, date and weekprogram
- 4 Save settings
- 5 Boost

• Indicators overview

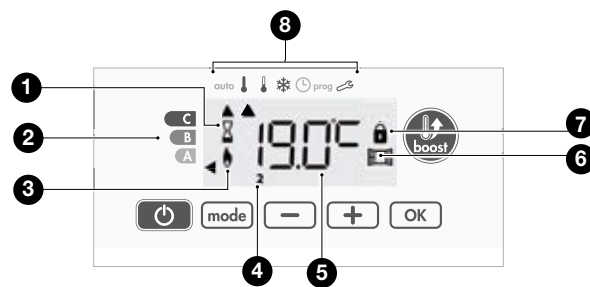

- 1 Boost indicator
- 2 Energy consumption
- 3 Heating indicator
- 4 Days of the week (1=Monday ... 7= Sunday)
- 5 Temperature setpoint
- 6 Open window detection
- 7 Keypad locked

8 Operations modes:

- auto** Auto mode
- !** Comfort mode
- !** Eco mode
- *** Frost protection mode
- ⌚** Time and date setting mode
- prog** Programming mode
- 🔧** Settings

OPERATION

• Thermostat buttons overview

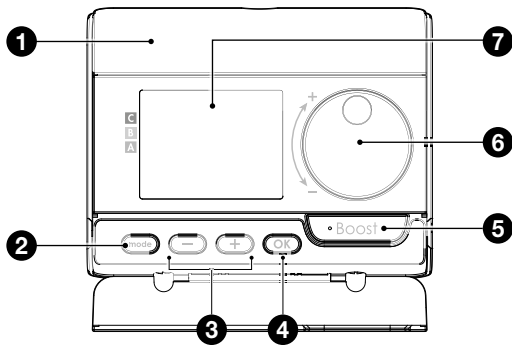

- 1 Batteries compartment
- 2 Selecting operating modes
- 3 Plus and minus buttons, used to set temperatures, time, date and weekprogram
- 4 Save settings
- 5 Boost
- 6 Rotary dial, to select temperature
- 7 LCD display

• Indicators overview

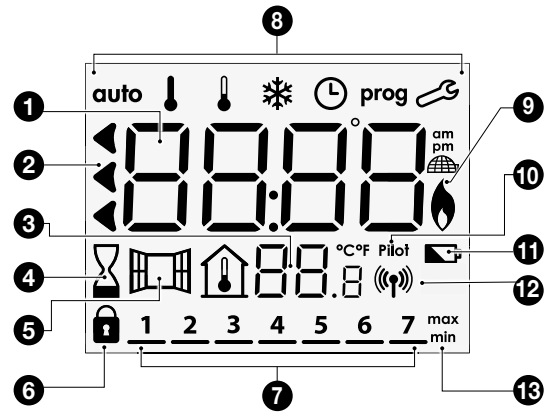

Days of the week (1 = Monday ... 7 = Sunday)

- 1 Temperature setpoint / information
- 2 Energy consumption
- 3 Measured room temperature
- 4 Boost indicator
- 5 Open window detection indicator
- 6 Keypad locked
- 9 Heating indicator
- 10 Fil Pilote wire indicator (only for France)
- 11 Battery indicator
- 12 Radio transmission indicator
- 13 Min/Max value indicator

8 Operation modes:

- auto** Auto mode ↓ Comfort mode ↓ Eco mode
- * Frost protection mode ⌚ Time and date setting mode
- prog** Programming mode ⚙️ Settings

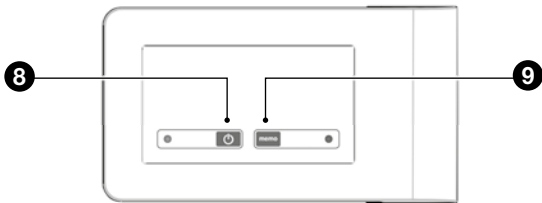

- 8 Power on/standby
- 9 Radio transmission, manual overwrite of heating

POWER ON/STANDBY

Press the button to put the device in operation, in Auto mode. Press the button to put the device in standby mode.

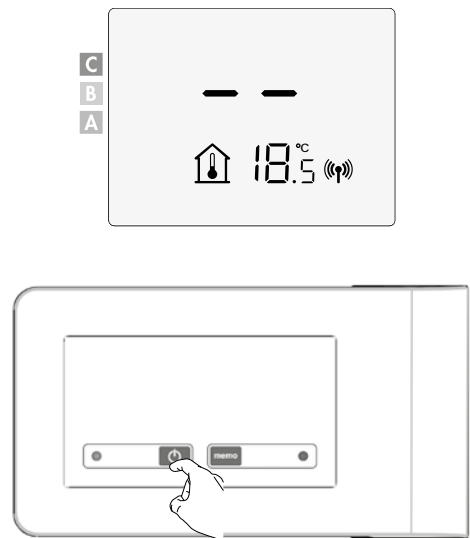
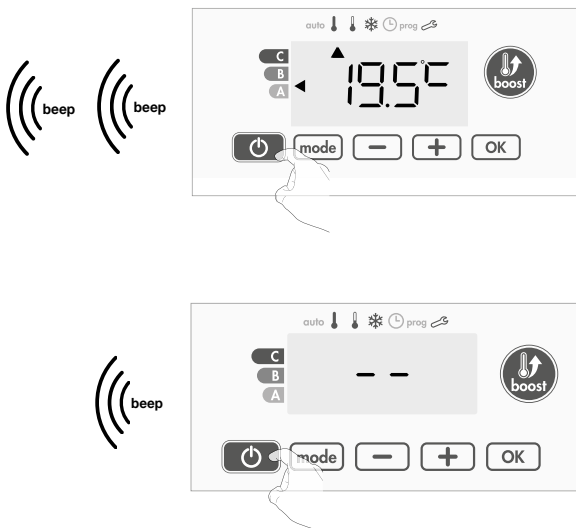

OPERATING MODES

Press the **mode** button to select the required mode.



Overview operating modes:

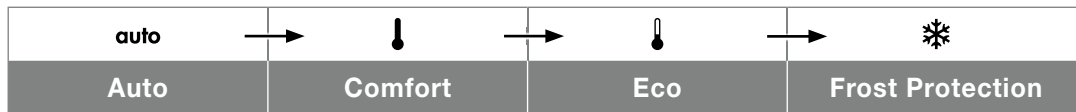

- **auto Auto mode (3 situations)**

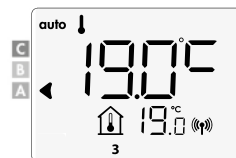
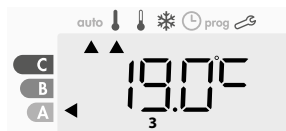

1 Week program has been set

If a week program has been set, the radiator will automatically switch between Comfort and Eco mode.

BASIC

In the event of a power failure of more than 3 hours, the day and time must be reset, the week program remains permanently in memory.

2 Programming by pilot wire (only for France)

3 No week program has been set

If the week program is not set, the radiator works permanently in Comfort mode.

- **Comfort mode**

The device will operate 24 hours a day to achieve the temperature which has been set (e.g. 19°C).

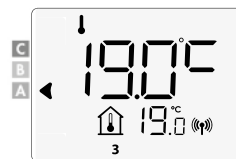

- **Eco mode**

Eco, which means the Comfort Mode temperature minus 3.5°C. This enables you to lower the temperature without having to reset the Comfort Mode temperature. Select this mode for shortterm absences (between 2 and 24h) and during the night.

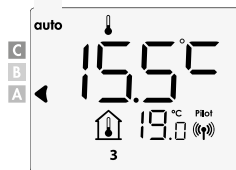

- **Frost protection mode**

This mode enables you to protect your home against the effects of cold weather (frozen pipes, etc.), by maintaining a minimum temperature of 7°C in it at all times. Select this mode when you will be away from your home for a long time (more than 5 days).

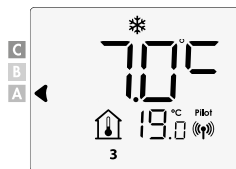

SETTING THE COMFORT TEMPERATURE

You can set the Comfort temperature in Auto and Comfort Mode. It is preset to 19°C.

Using **-** and **+** you can adjust the temperature from 7°C to 30°C by intervals of 0.5° C.

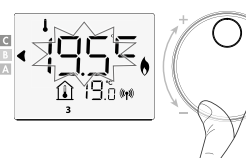
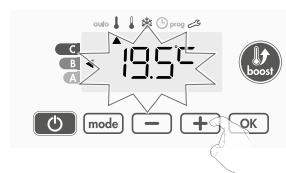

BOOST

Important: the Boost mode can be enabled at any time, whatever the current operating mode (Auto, Comfort, Eco or Frost protection).

First press = Boost.

During the first minute, you can modify the Boost duration from 0 to the maximal Boost duration, by pressing **-** and **+**.

This modification will be saved and effective for the next Boost.

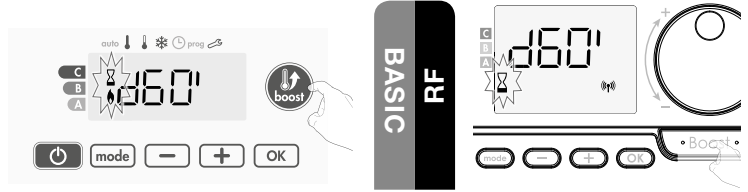

Comment: After 1 minute, you can modify temporarily the duration: it will be valid only for this active Boost and therefore non-recurring.

The boost stops if the ambient temperature reaches the maximal Boost temperature:

The controller switches off but the Boost mode is always active : the count is always displayed, the Boost symbol and the heating indicator flash on the display.

When the temperature drops under the maximal Boost temperature, the Boost will be restarted until the count ends.

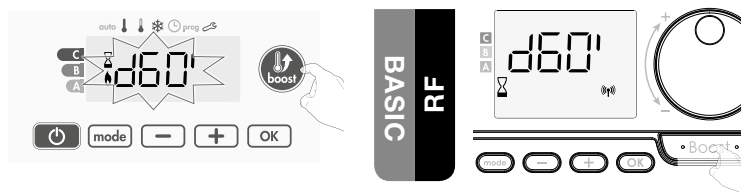

Second press = Boost cancellation.

The cursor moves above the previous active mode and the setting temperature appears.

ENERGY CONSUMPTION

A selector indicates the energy consumption level by positioning it in front of the colour: red, orange or green.

C - Red higher consumption	Setting temperature > 22°C		
B - Orange average consumption	Setting temperature > 19°C ≤ 22°C		
A - Green lower consumption	Setting temperature ≤ 19°C		

• Display of the estimated power consumption in kWh

To see this estimation from Auto, Comfort, Eco or Frost protection mode, then press **OK**. To exit the display mode of consumption: press any button, the device is automatically in the previous active mode.

• Resetting the energy meter

To reset the energy meter from Auto, Comfort, Eco or Frost protection mode, then proceed as follows.

1- Press **OK**.

2- Press simultaneously **-** and **+** for more than 5 seconds.

To exit resetting the energy meter, press any button, the device is automatically in the previous active mode.

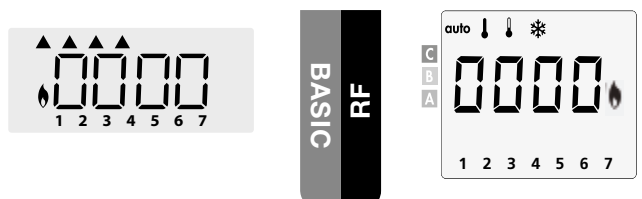

KEYPAD LOCK/UNLOCK

• Keypad lock

To lock the keypad, press the **-** and **+** buttons and hold them down for 10 seconds. The padlock symbol **🔒** appears on the display, the keypad is locked.

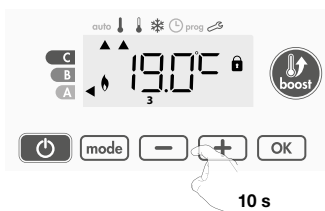

• Keypad unlock

To unlock the keypad, press the **-** and **+** buttons hold them down for 10 seconds again. The padlock symbol **🔒** disappears from the display, keypad is unlocked.

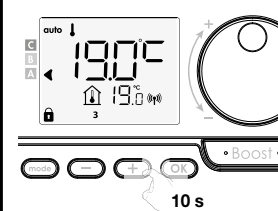

BASIC RF

SETTING TIME AND DAY

1- From Auto, Comfort, Eco or Frost protection mode, press **mode** for 5 seconds. The cursor moves to the setting day and time mode.

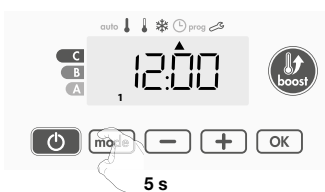

2- Select using **-** or **+**. The two hour figures will flash. The hours will scroll quickly, if you press the **-** or **+** and hold them. Save by pressing **OK**.

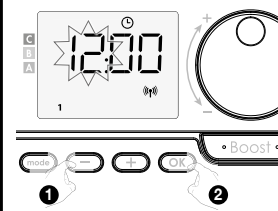
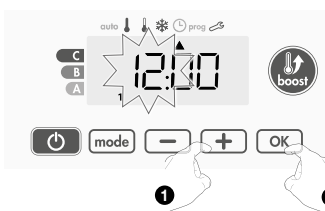

3- The two minute figures will flash. Select using **-** or **+**. Save by pressing **OK**.

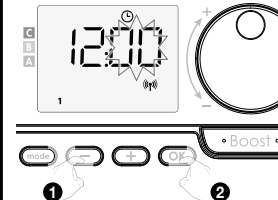
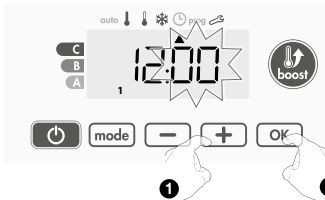

4- The cursor above the number 1 (which represents the Monday) will flash. Select the date using **-** or **+**. Save by pressing **OK**.



BASIC RF

Monday	1	Fryday	5
Tuesday	2	Saturday	6
Wednesday	3	Sunday	7
Thursday	4		

5- To change and/or allocate programmes press **mode**. To exit the setting time and day, press **mode** 3 times.

OVERVIEW OF THE PROGRAMS



Your device's default setting is non-stop Comfort for 7 days a week.

- **Comfort:** the controller will operate in Comfort mode, 24 hours a day, as regards each day selected.
- **Eco:** the controller will operate 24 hours a day in Eco mode.
Note: You can set the temperature-lowering parameters, see user settings
- **P1:** the controller will operate in Comfort mode for 1 time block eg: from 06:00 to 22:00 (and in Eco mode from 22:00 to 06:00).
- **P2:** the controller will operate in Comfort mode for 2 time blocks eg: from 06:00 to 09:00 and from 16:00 to 22:00 (and in Eco mode from 09:00 to 16:00 and from 22:00 to 06:00).
- **P3:** the controller will operate in Comfort mode for 3 time blocks eg: from 06:00 to 08:00, from 12:00 to 14:00 and from 18:00 to 23:00 (and in Eco mode from 23:00 to 06:00, from 08:00 to 12:00 and from 14:00 to 18:00).



Note: If the standard times of P1, P2 and P3 do not suit you, you can change them, but then this time applies to all days of the week on which P1, P2 or P3 is set.

SET A WEEK PROGRAM

- 1- From Auto, Comfort, Eco or Frost protection mode, press **mode** for 5 seconds. When the cursor moves over the time setting symbol , briefly press **mode**.

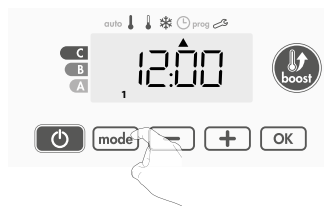

- 2- Press **+** or **-** to set the week program.

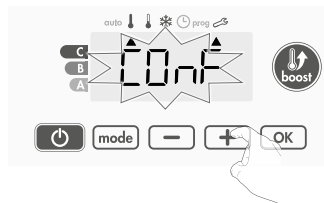

- 3- Select the desired program with **+** or **-**. If desired, the standard times can be adjusted: press **OK** for at least 5 seconds. If the standard times apply: press **OK** to set the next day (go to step 4)

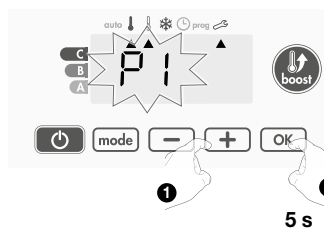

- 3.1- The start time flashes and with **+** or **-** you can change this time at 30 minute intervals. Press **OK** to save.



- 3.2- The end time flashes and with **+** or **-** you can change this time at 30 minute intervals. Press **OK** to save.

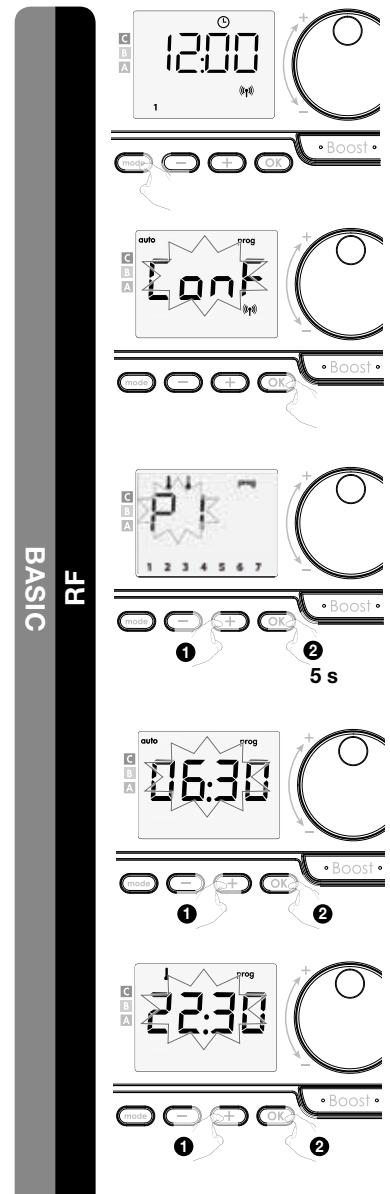
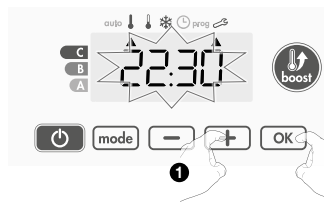

- 4- The second day (Tuesday) flashes.
Repeat the procedure described above for every day of the week.

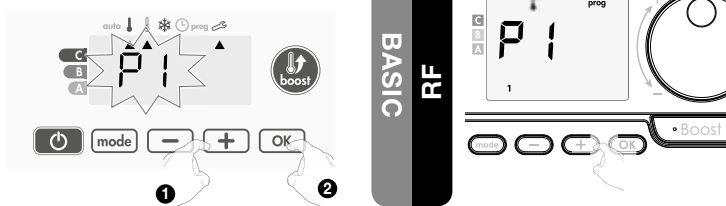

- 5- Once you have selected a program for each day, confirm your selection by pressing **OK**. The days of the week appear on the screen with the programs you have set for them. Press **mode** twice to exit programming mode and return to "Auto mode". If no button is pressed for a few minutes, the controller automatically returns to "Auto Mode".

VIEW OF THE PROGRAMMED WEEK PROGRAM

From Auto, Comfort, Eco or Frost protection mode, press **mode**, for 5 seconds. Press **mode** twice, the programme for each day of the week (Comfort, Eco, P1, P2 or P3) will scroll on display in front of you.

To exit the programme viewing mode, press **mode** twice.

TEMPORARILY OVERWRITE THE WEEK PROGRAM

This function allows you to change the setting temperature temporarily until the next scheduled change in temperature or the transition to 0:00.

Example:

- 1- The controller is in Auto mode, the running programme is Eco 15,5°C.
- 2- By pressing **-** or **+**, you can change temporarily the desired temperature up to 18°C for example.
- 3- This change will be automatically cancelled at the next change of programme or transition to 0:00.

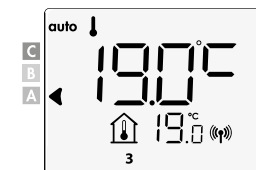
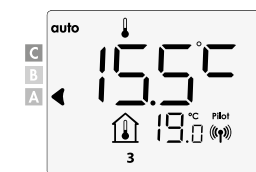
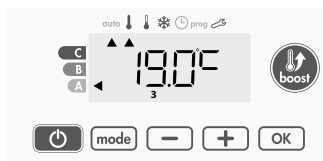
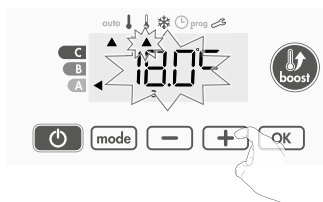
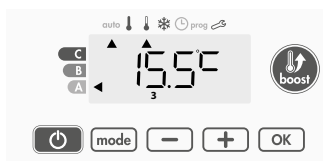

OPEN WINDOW DETECTION

The open window detection is sensitive to temperature fluctuations. The controller responds to open windows according to various parameters: temperature setting, rise and fall of the room temperature, outside temperature, location of the radiator, etc. If the controller is close to a front door, the detection air can be disturbed opening the door. If this is a problem, we recommend you disable the open window detection (see installer settings).

When the controller proceeds to a temperature reduction cycle (frost protection mode) by opening a window, a frost protection counter appears on the display to show the cycle duration. The counter is automatically reset to zero the next time the Frost Protection is switched on. By pressing a button, the frost protection mode is deactivated.

Note: if a temperature rise is detected, the controller will automatically return to the previous mode.

USER SETTINGS

ACCESS

From Auto, Comfort, Eco or Frost protection mode:

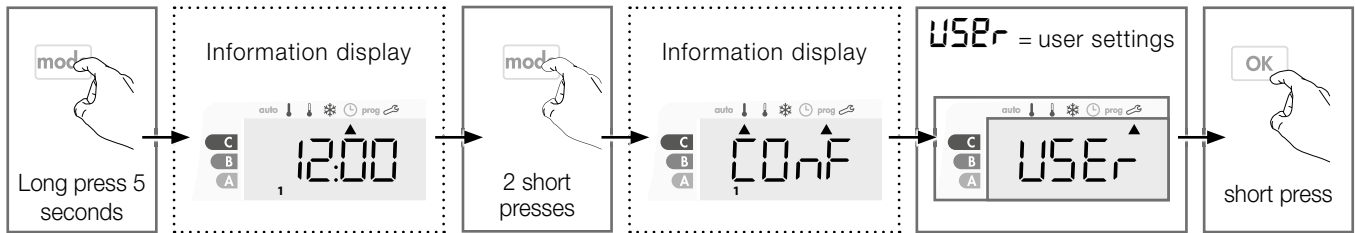

Setting sequence diagram:

Backlight → Eco reduction level → Frost protection → upper and lower comfort temperature limit → Max. Boost duration → Max. Boost Temperature → Temperature unit → Restoring factory settings

BACKLIGHT

1- Three options are available:

- L1 = timed backlight: the screen is illuminated when a button is pressed.
 - L2 = permanent backlight: the screen remains illuminated all the time.
 - L3 = idem as option L1
- Option L3 is set by default.**

Press the or button as appropriate.

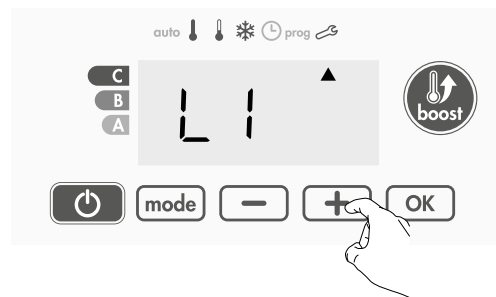

- 2- To confirm and go on to the next setting, press .
- To confirm and exit the settings, press 2x .

ECO REDUCTION LEVEL

The reduction is pre-set to -3.5°C compared to the Comfort setpoint temperature. You can vary it between -1°C and 8°C in increments of 0.5°C.

Note: regardless of the reduction level set, the Eco setpoint temperature will never exceed 19°C.

1- Press or to display the required value.

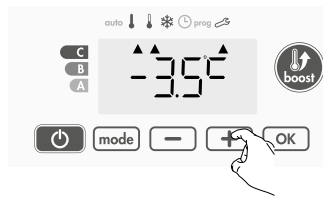

- 2- To confirm and go on to the next setting, press .
- To confirm and exit the settings, press 2x .

FROST PROTECTION

Your device is pre-set to 7°C, you can vary the value of the Frost protection setpoint from 5°C to 15°C in increments of 0.5°C.

1- Press or to display the required value.

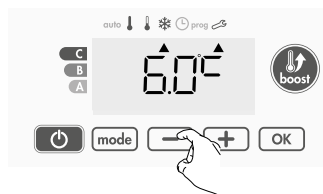

- 2- To confirm and go on to the next setting, press .
- To confirm and exit the settings, press 2x .

UPPER AND LOWER COMFORT TEMPERATURE LIMIT

• Low temperature limit

The minimum stop is preset to 7°C. You can vary it between 7°C and 15°C in increments of 1°C.

- 1- To change the minimum stop, press **-** or **+** then confirm by pressing **OK**.

If you don't want to change it, press **OK**: the controller automatically suggests the maximum stop setting.

To confirm and exit the settings, press 2x **mode**.

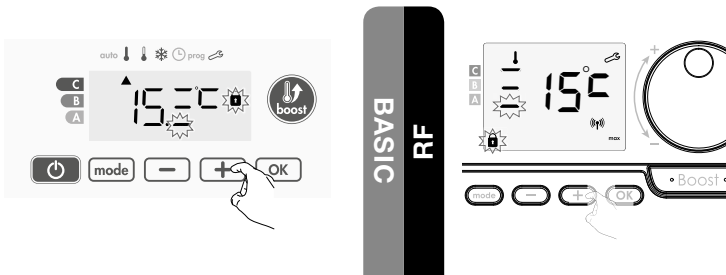

• High temperature limit

The maximum stop is preset to 30°C. You can vary it between 19°C and 30°C in increments of 1°C.

- 2- To change the maximum setpoint temperature, press **-** or **+**.

Press the **OK** button to confirm and go on to the next setting.

To confirm and exit the settings, press 2x **mode**.

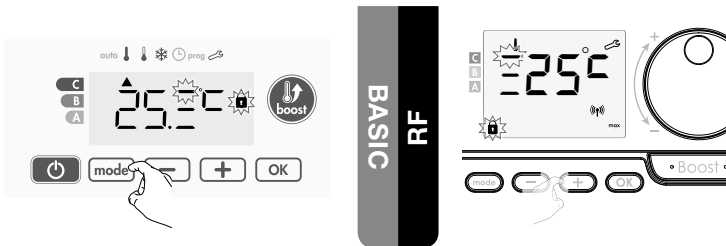

MAX. BOOST DURATION

The maximum Boost duration is preset to 60 minutes. You can vary it between 30 and 90 minutes in increments of 30 minutes.

- 1- The Boost symbol and the heating indicator appear on the display and the duration of 60 minutes flashes
- 2- Press **-** or **+** to display the required duration.
- 3- To confirm and go on to the next setting automatically, press **OK**.
To confirm and exit the settings, press 2x **mode**.

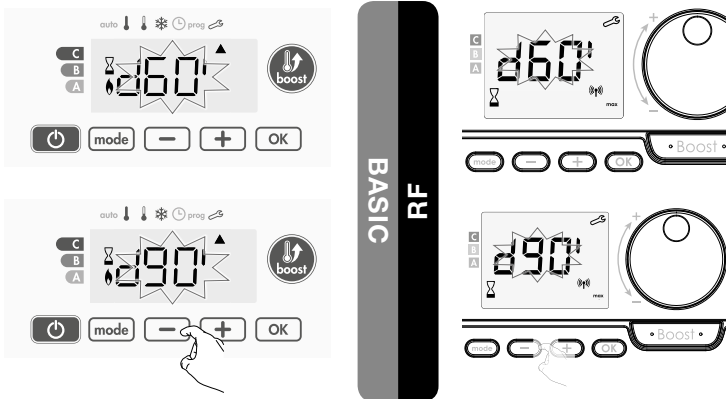

MAX. BOOST TEMPERATURE

When the Boost is activated, the radiator must heat the room up to a temperature limit: the max. boost temperature. When this is reached, the Boost stops automatically. It is preset to 35°C. You can vary it between 25°C and 39°C in increments of 1°C.

- 1- The Boost symbol and the heating indicator appear on the display and the maximum temperature flashes
- 2- You can set the maximum temperature of the Boost by pressing the **-** or **+** repeatedly in 1°C steps, up to 39°C.
- 3- To confirm and go on to the next setting automatically, press **OK**.
To confirm and exit the settings, press 2x **mode**.

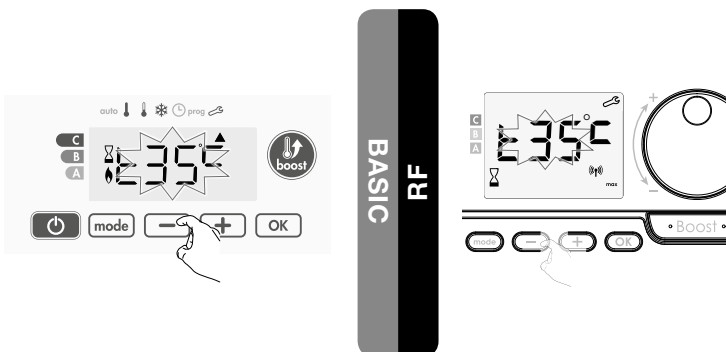

TEMPERATURE UNIT

The default temperature unit is degrees Celsius.

- 1- Press **-** or **+** to change the temperature unit.
- 2- To confirm and go on to the next setting automatically, press **OK**.
To confirm and exit the settings, press 2x **mode**.

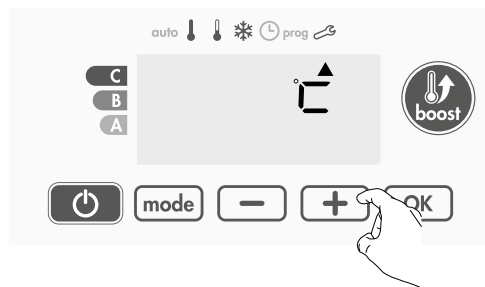

RESTORING FACTORY SETTINGS

- 1- **rest** is displayed for 1 second.
- 2- **no** flashes. Press **-** or **+** to select **yes**.
- 3- Press **OK** for 5 seconds.
The device returns to its original configuration and automatically goes back to Auto mode.

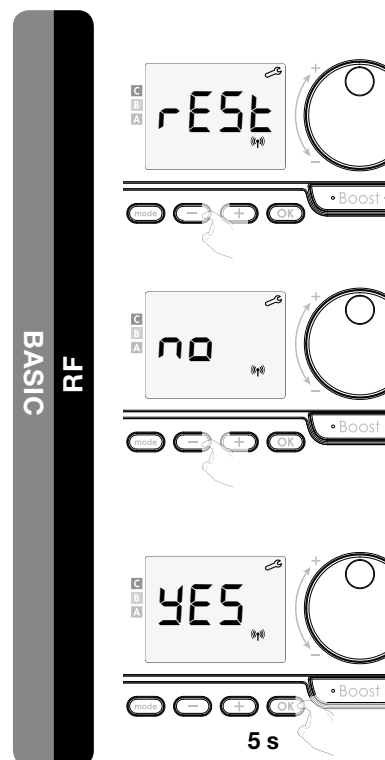
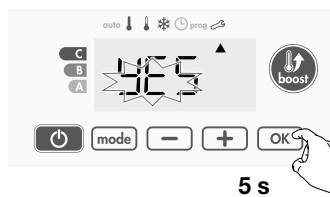
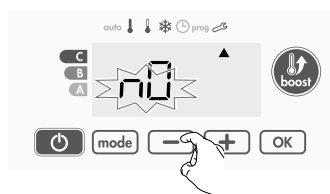
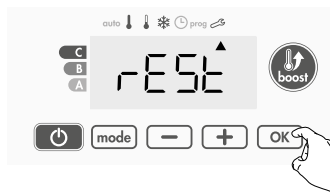

General

Comfort temperature setpoint	19 °C
Duration of Boost	60 min.
Keypad lock	Deactivated

User settings

Backlight	L3	BASIC
Eco reduction level	-3,5 °C	
Frost protection	7 °C	
Comfort low temperature limit	7 °C	
Comfort high temperature limit	30 °C	
Max. Boost duration	60 min.	
Max. Boost temperature	35 °C	
Temperature unit	°C	

Press 2x **mode** to confirm and exit the settings.

INSTALLER SETTINGS

ACCESS

From Auto, Comfort, Eco or Frost protection mode:

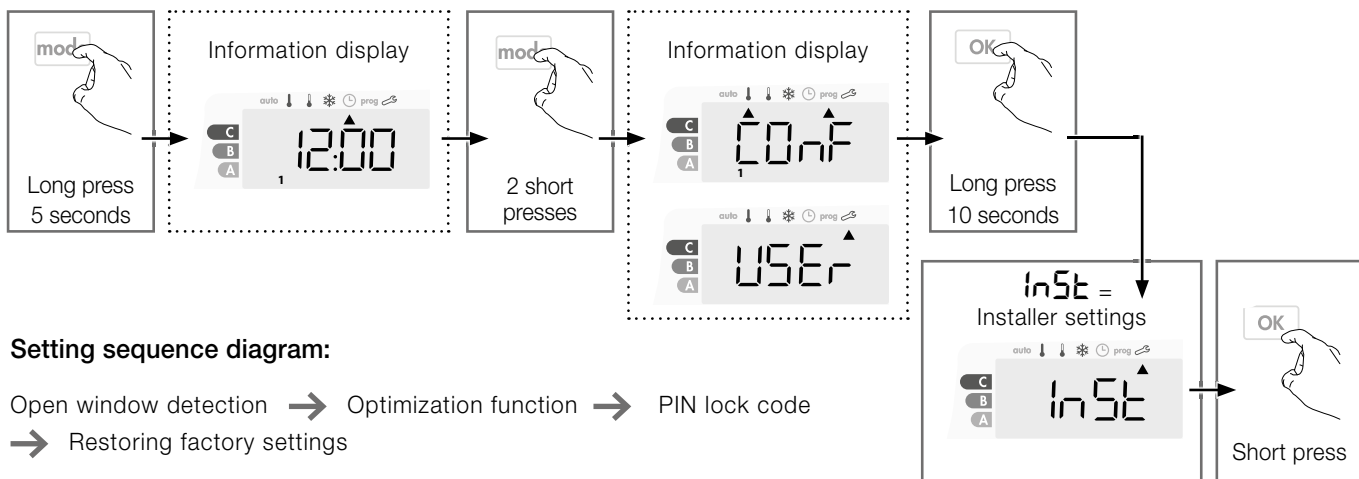

Setting sequence diagram:

Open window detection → Optimization function → PIN lock code → Restoring factory settings

OPEN WINDOW DETECTION

- 1- The open window detection is activated by default.
- 2- Press **-** or **+**.
On = automatic mode activated.
OFF = automatic mode deactivated.
- 3- Press **OK** to confirm and go on to the next setting.
 To confirm and exit the settings, press 3x **mode**.

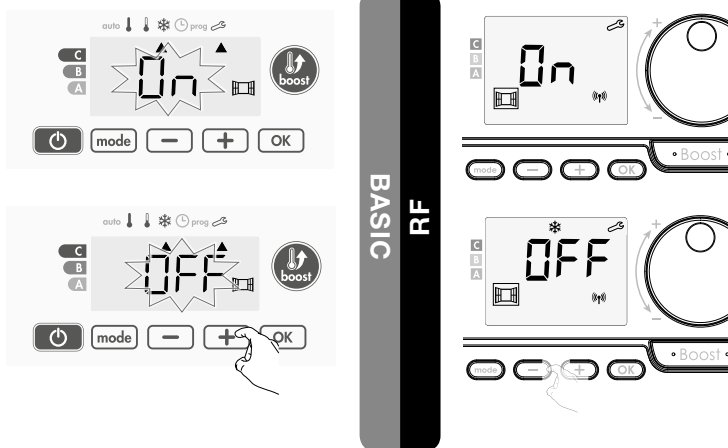

OPTIMIZATION FUNCTION

-In **OPTI ECO (energy efficiency) mode**, the control calculates the best compromise to ensure maximum energy savings during the programmed heating and cooling phases. A slight decrease in the temperature level at the beginning and end of the comfort period allowed to maximize energy savings.

-In **OPTI COMFORT mode (comfort efficiency)**, the control calculates the best compromise to guarantee maximum comfort during the programmed heating and cooling phases. Priority is given to anticipating and maintaining the comfort temperature during comfort periods.

The OPTI COMFORT mode is activated by default. The word **OP / :** appears briefly on the display and then alternates with the set **ConF**, **ECO** or **OFF** mode.

ConF = optimization function activated for the mode OPTI COMFORT, priority for comfort.

- 1- Press **-** or **+**.
ConF = optimization function activated for the mode OPTI COMFORT, priority for comfort efficiency.
ECO = optimization function activated for the mode OPTI ECO, priority for energy efficiency.
OFF = optimization function deactivated.

- 2- Press **OK** to save and go to the next setting.
 Press **mode** 3x to exit the settings.

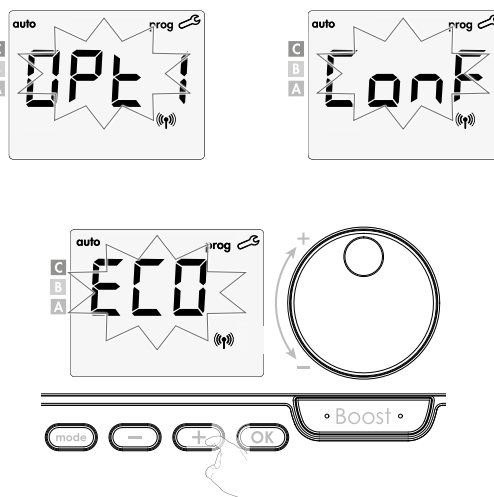

PIN LOCK CODE

● Overview

You can set the 4-digit pin code yourself which, when activated, makes the following functions unavailable:

- Selecting the Comfort mode: only the Auto, Eco and Frost protection modes are available.
- Setting the Comfort and Eco and Frost protection temperature.
- Changing the week program.
- Setting the open window detection.

When using “PIN code locking” protection for the first time, you must take the following 3 important steps:

- 1- Initialise the PIN code, enter the default PIN code (0000) to access the function.
- 2- Activate the PIN code to lock the settings that will be protected by the PIN code.
- 3- Customise the PIN code; replace (0000) by your personal four digit code.

● Initialising the default PIN code = ‘0000’

By default, the PIN code is not activated = OFF

- 1- The PIN code stored by default is 0000.
Using **-** or **+** select the digit 0. It flashes, confirm by pressing **OK**.

- 2- For the remaining digits, select the digit 0 by pressing **OK**.
When 0000 is displayed, press **OK** again to confirm.

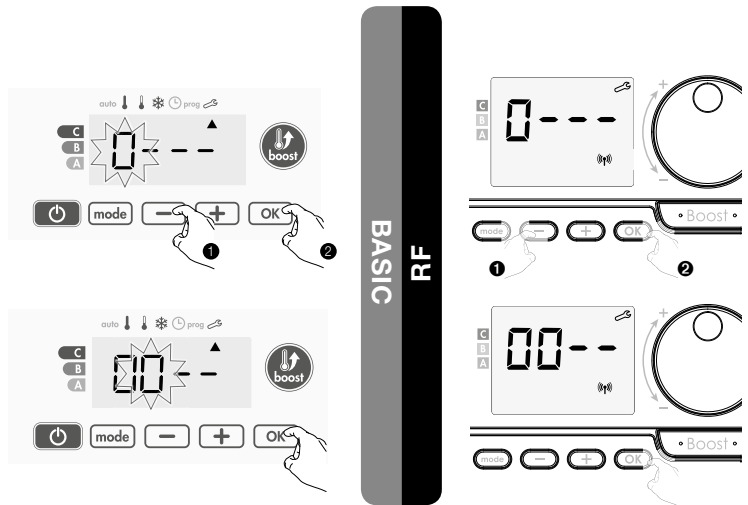

The PIN code is initialised, the controller automatically suggests the following setting: activation of the PIN code.

● Activating/Deactivating the PIN code

- 1- OFF appears in the display.
Press **-** or **+** to activate the PIN code.

On = PIN code activated
OFF = PIN code deactivated

- 2- Press **OK** to confirm and go on to the next setting.

The PIN code is now activated.
No changes to the settings listed in “Overview” are possible.

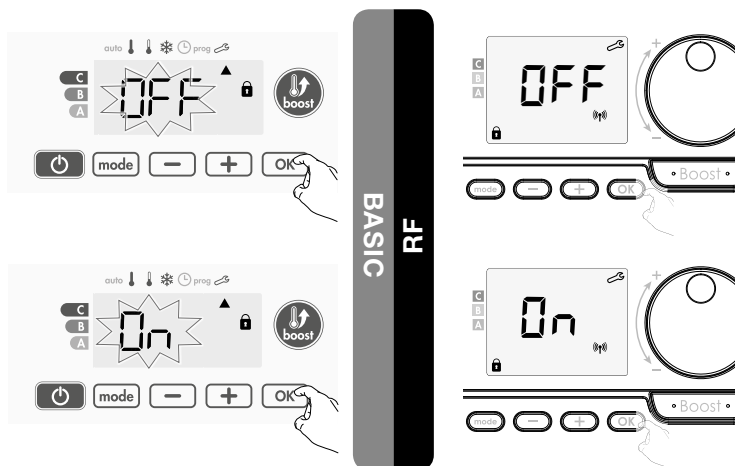

● Customising the PIN code

- 1- When On is displayed, press **OK** for at least 5 seconds.

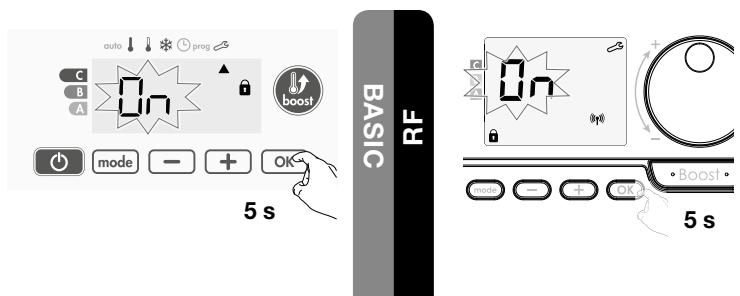

- 2- The code 0000 is displayed and the 1st digit flashes. Using **-** or **+**, select the desired digit and then press **OK** to confirm it.

Continue in the same way for the 3 remaining digits.

- 3- Press **OK** to confirm. The new code is now stored.

- 4- Press **OK** again to confirm and go to the next setting.

To confirm and exit the settings, press 3x **mode**.

Press 3x **mode** to confirm and exit the settings.

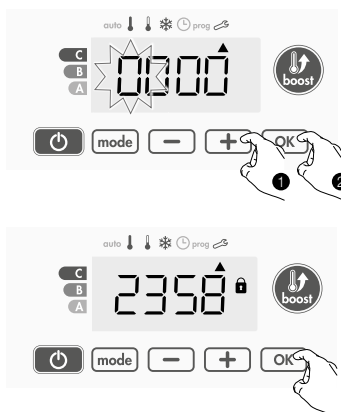

BASIC RF

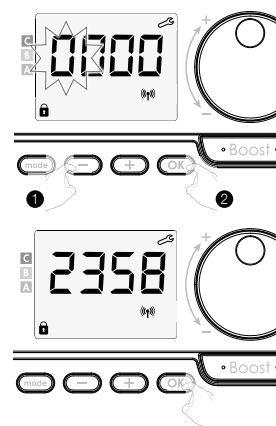

RESTORING FACTORY SETTINGS

If PIN code protection is deactivated, you can reset the user and installer parameters to their original value.

- 1- **rest** is displayed.

- 2- **no** flashes.

Press **-** or **+** to select **yes**

- 3- Press **OK** for 5 seconds.

The device returns to its original configuration and automatically goes back to Auto mode.

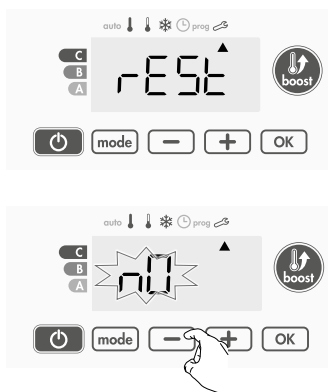

BASIC RF

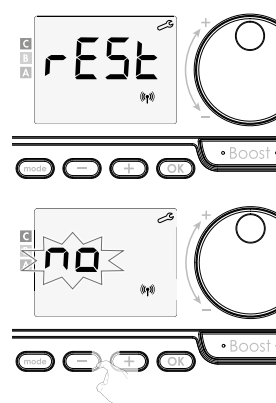

General

Comfort temperature setpoint	19 °C
Duration of Boost	60 min.
Keypad lock	Deactivated

User settings

Backlight	L3	BASIC
Eco reduction level	-3,5 °C	
Frost protection	7 °C	
Comfort low temperature limit	7 °C	
Comfort high temperature limit	30 °C	
Max. Boost duration	60 min.	
Max. Boost temperature	35 °C	
Temperature unit	°C	

Installer settings

Open window detection	Activated
Optimization function	Option Comfort RF
PIN code protection	Deactivated
PIN code value	0000

Press 3x **mode** to confirm and exit the settings.

ADVANCED INSTALLER SETTINGS

ACCES

From Auto, Comfort, Eco or Frost protection mode:

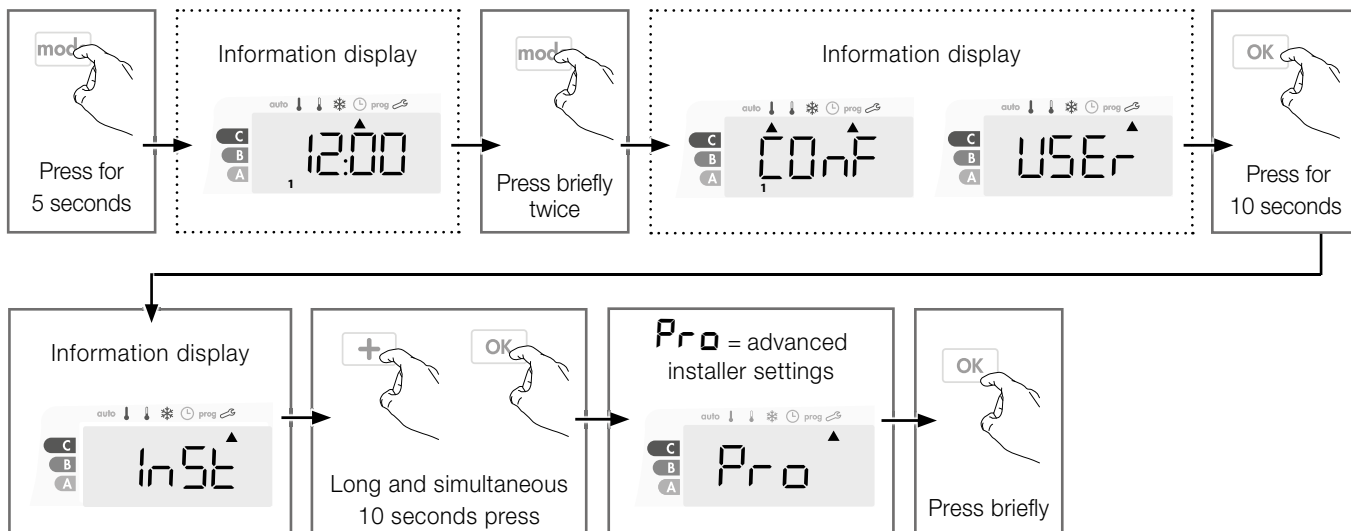

Setting sequence:

Temperature sensor calibration → Radiator power → Restoring factory settings

TEMPERATURE SENSOR CALIBRATION

● Overview

⚠ Important: This operation is reserved for professional installers only; any wrong changes would result in control anomalies.

The calibration adjusts the temperature measured by the ambient temperature sensor to compensate for a deviation from + 5°C to - 5°C by intervals of 0.1°C.

The calibration can be performed for each linked control. Depending on the number of controls, you start by setting the calibration from the first control, then for the second, to the last control. You can identify the control number when you set the calibration on the display.

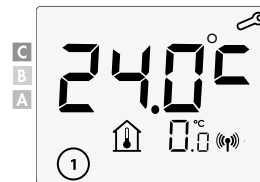

● Calibration

1- If the room temperature difference is negative, example :

Setting temperature (what you want) = 20°C.

Ambient temperature (what you read on a reliable thermometer) = 18°C.

Difference measured = -2°C.

⚠ Before carrying out the calibration it is recommended to wait for 4h after the setting temperature modification to insure that the ambient temperature is stabilized.

To correct, then proceed as follows :

Sensor temperature = 24°C

Decrease the temperature measured by the ambient temperature sensor by 2°C by pressing .

To validate the new value press .

To exit the settings, press 3 times.



2- If the room temperature difference is positive, example :

Setting temperature (what you want) = 19°C.

Ambient temperature (what you read on a reliable thermometer) = 21°C.

Difference measured = +2 °C.

To correct, then proceed as follows :

Sensor temperature = 21°C



Increase the temperature measured by the ambient temperature sensor by 2°C by pressing **+** .



To validate the new value press **OK** . To exit the settings, press **mode** 3 times.

• The reset to zero of the sensor calibration

- 1- When the temperature measured by the sensor appears, press **-** or **+** for at least 3 seconds.
- 2- To save and move automatically to the next setting press **OK** . To exit the settings, press **mode** 3 times.

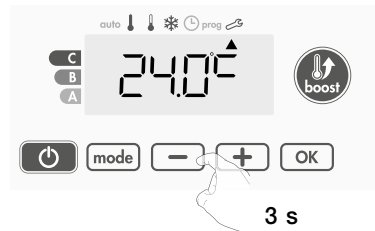

BASIC

RADIATOR POWER

To guarantee the correct functioning of the radiator and to be able to correctly estimate the energy consumption, it is essential to adjust the power of the radiator.

BASIC: this setting must be made upon initial commissioning.

RF: when paired with the RF remote control, this setting is automatically discussed.

- 1- Select a value between 500W and 1500W by pressing **+** or **-** .
- 2- To save and move automatically to the next setting press **OK** . To confirm and exit the settings, press 3x **mode** .

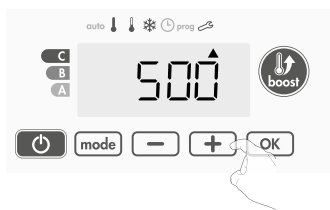

RESTORING FACTORY SETTINGS

If the PIN code protection is disabled, the user, installer and advanced installer settings are re-initialized:

- 1- **reSt** appears on the display.

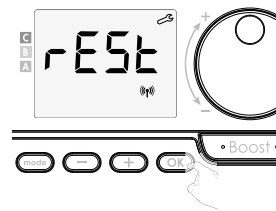
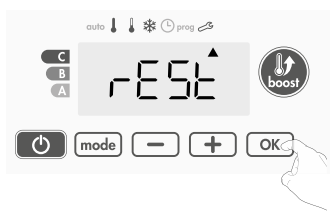

2- **no** appears. Press **-** or **+** to select **YES**.

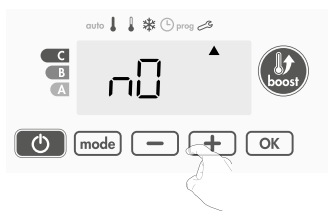

3- Press the key **OK** for 5 seconds.

The device returns to its initial configuration and goes back automatically to the Auto mode.

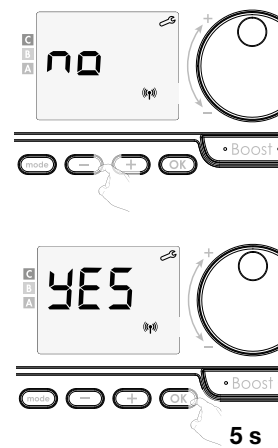
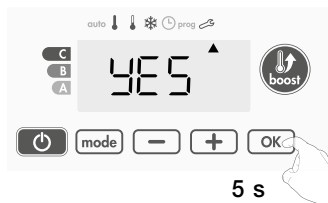

General

Comfort temperature setpoint	19 °C
Duration of Boost	60 min.
Keypad lock	Deactivated

User settings

Backlight	L3	BASIC
Eco reduction level	-3,5 °C	
Frost protection	7 °C	
Comfort low temperature limit	7 °C	
Comfort high temperature limit	30 °C	
Max. Boost duration	60 min.	
Max. Boost temperature	35 °C	
Temperature unit	°C	

Installer settings

Open window detection	Activated	
Optimization function	Option Comfort	RF
PIN code protection	Deactivated	
PIN code value	0000	

Advanced installer settings

Temperature sensor calibration	0,0
Radiatorpower	500W

To exit the settings, press **mode** 3 times.

ISTRUZIONI DI SICUREZZA



L'apparecchio non deve essere utilizzato da persone (inclusi i bambini) con ridotte capacità fisiche, sensoriali o mentali, o mancanza di esperienza o conoscenza, a meno che siano attentamente sorvegliate o istruite riguardo all'uso.

I bambini non devono giocare con l'apparecchio, neppure sotto sorveglianza.



Il radiatore non deve mai essere coperto e non deve essere montato sotto a una presa di corrente.

Deve essere possibile spegnere il radiatore in qualsiasi momento. Nel caso di un collegamento a spina, questo deve essere possibile mediante un interruttore esterno. Nel caso di un collegamento fisso cablato, il circuito elettrico deve essere protetto in modo corretto.

Il montaggio del radiatore comporta il rispetto delle norme locali/nazionali in materia di impianti elettrici e delle nostre condizioni generali.

SMALTIMENTO CONFORMEMENTE ALLA DIRETTIVA RAEE (2012/19/UE)



Il simbolo che compare sulla targhetta segnaletica del radiatore indica che il radiatore non può essere considerato come un rifiuto domestico, ma che deve essere correttamente smaltito. Una volta giunto a fine vita, deve essere portato in un centro di raccolta di apparecchiature elettriche ed elettroniche. Per maggiori informazioni sui centri di riciclaggio e di raccolta, contattare le amministrazioni locali/comunali o il servizio di raccolta rifiuti. Ciò si applica ai paesi dove è in vigore tale direttiva.

SPECIFICHE TECNICHE

- Tensione di alimentazione: 230 VCA 50 Hz
- Potenza massima di 1500 W, carico resistivo
- Cavo di alimentazione di classe II, 800 mm, 3 conduttori.
- Il cavo nero (protetto) è un cavo di comunicazione applicabile solo **in Francia, ma non è collegato a terra. Deve essere sempre protetto;**
- **Se il cavo di alimentazione è danneggiato, contattare l'installatore.**



- Consumo in stand-by: < 0,5 W

- Controllo PID (Proporzionale-Integrale-Derivativo) elettronico, attivato da un relè+triac



- IPX4

- Classe II, dopo l'installazione sotto la responsabilità dell'installatore (conformemente alla norma EN60335-1)

DICHIARAZIONE DEL COSTRUTTORE



Dichiariamo interamente sotto la nostra responsabilità che i prodotti presentati in questo opuscolo presentano la marcatura CE e soddisfano tutti i requisiti fondamentali delle seguenti direttive e norme armonizzate:

- LVD 2014/35/EU: EN60335-1/EN60335-2-30/EN60335-2-43/ EN62333
- EMC 2014/30/EU: EN55014-1/EN55014-2-30/EN61000-3-2/ EN61000-3-3
- ERP 2009/125/EC
- RoHS 2011/65/EU: EN50581

e che sono costruiti secondo processi certificati ISO 9001 V2015.

Questo apparecchio è conforme alla direttiva europea ECO Design 2015/188.

Informazioni obbligatorie per le apparecchiature elettriche destinate al riscaldamento decentrato			
Caratteristiche	Simbolo	Valore	Unità
Potenza termica			
Potenza nominale	P nom	0,5 → 1,5	kW
Potenza minima	P min	0,5	kW
Potenza massima continua	P max,c	1,5	kW
Consumo elettrico supplementare			
Alla potenza nominale	el max	0,000	kW
Alla potenza minima	el min	0,000	kW
In stand-by	el sb	0,0005	kW
Tipo di emissione di calore controllo della temperatura della stanza			
Controllo elettronico della temperatura della stanza + timer settimanale			
Altre opzioni di controllo			
Controllo elettronico della temperatura della stanza, con rilevamento di finestra aperta			
Con opzione telecomando			
RF Con controllo di avviamento adattabile			
Dati di contatto			
V. targhetta identificativa sul radiatore			

Condizioni di garanzia:

cf.

www.vasco-group.eu

INSTALLAZIONE DEL CONTROLLO

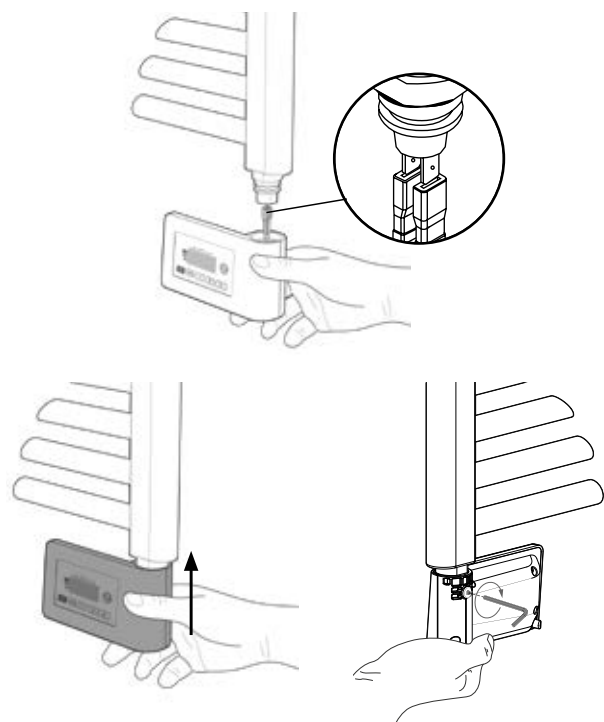

Avvitare il controllo con la chiave a brugola inclusa

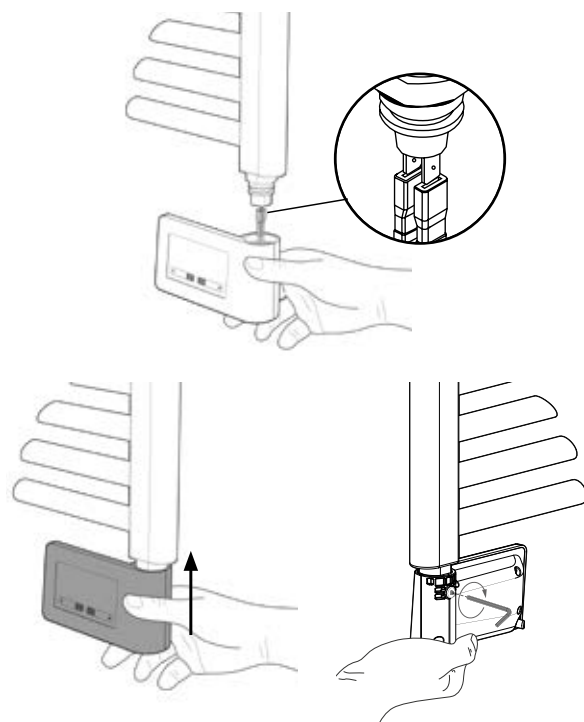

Avvitare il controllo con la chiave a brugola inclusa

INSTALLAZIONE DELLE BATTERIE

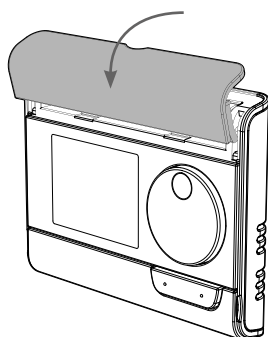

Togliere il coperchio del vano batterie collocato nella parte anteriore del termostato.

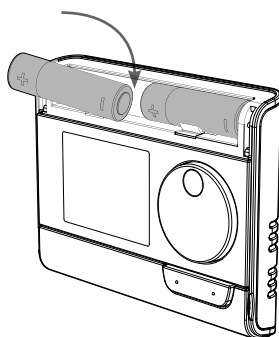

Inserire le 2 batterie AA in dotazione. Quando si inseriscono le batterie, prestare attenzione che la polarità sia corretta, secondo l'indicazione sul termostato.

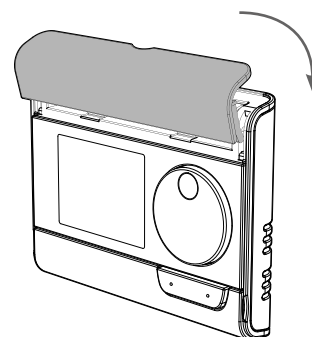

Riposizionare il coperchio del vano batterie.

MONTAGGIO DEL TELECOMANDO RF

Sulla parete

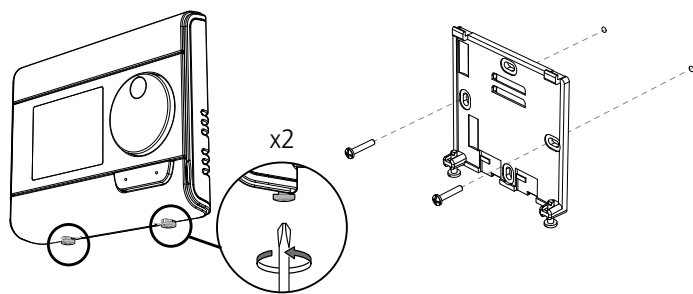

Svitare le 2 viti sotto al termostato.

Fissare il pannello a parete con le due viti in dotazione, avvalendosi dei fori orizzontali e verticali.

Sul supporto da tavolo

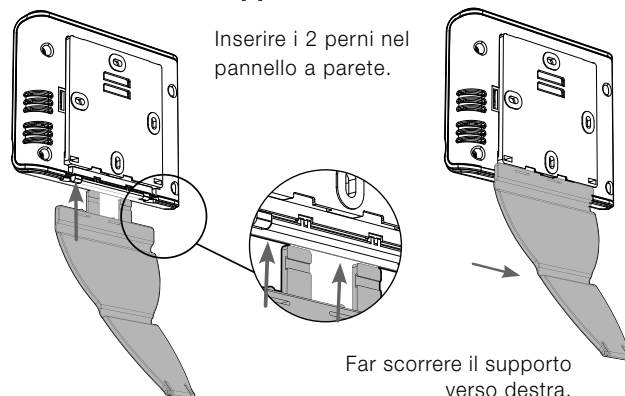

Inserire i 2 perni nel pannello a parete.

Far scorrere il supporto verso destra.



COLLEGAMENTO DEL RICEVITORE RF AL TELECOMANDO RF

Il telecomando e il ricevitore RF non sono collegati di serie.



Attenzione: È possibile collegare un massimo di 5 ricevitori RF a 1 telecomando RF.

Procedere come segue e farlo per ogni ricevitore RF:

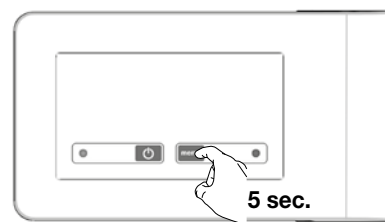

Collegamento RF:

1. Mettere il ricevitore RF in modalità collegamento, premendo il pulsante  per 5 sec. Il LED RF  inizierà a lampeggiare di ROSSO.

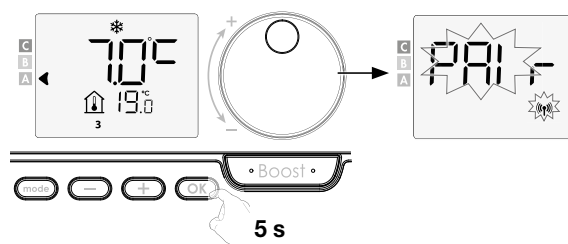

2. Mettere il telecomando RF in modalità di protezione antigelo, premendo  pulsante 3 volte e premere  per 5 sec.



3. Per garantire il corretto funzionamento del radiatore, la potenza del radiatore deve essere regolata tramite il telecomando RF. Questo passaggio viene automaticamente eseguito durante il collegamento. La potenza è impostata su 500 W come standard. Utilizzare i tasti  e  per impostare la potenza (vedere la targhetta del radiatore).

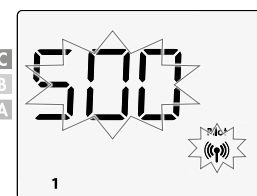

4. Quando il telecomando e il ricevitore RF sono collegati, appare il simbolo  visualizzato costantemente.

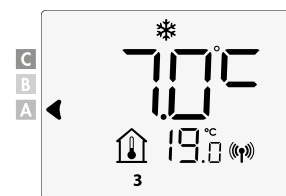

Annullamento del collegamento RF:

Premere per più di 10 secondi il pulsante Memo del ricevitore RF

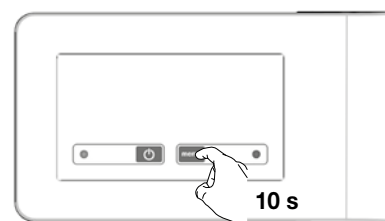

Stato della modalità di funzionamento

Stato della modalità di funzionamento	Stato e colore del LED
Standby	Spento
Accensione	Verde
Riscaldamento acceso	Rosso
Boost	Rosso lampeggiante
Protezione antigelo, rilevamento finestra aperta	Verde lampeggiante
Azionamento manuale (pulsante MEMO)	Arancione lampeggiante

Stato di comunicazione RF

Stato di comunicazione RF	Stato e colore del LED
Standby	Spento
Nessuna connessione RF	Rosso
Collegamento RF	Rosso lampeggiante
Annullamento del collegamento RF	Rosso lampeggiante veloce
Connessione RF OK	Verde
Messaggio RF ricevuto	Lampeggio verde veloce di 1 sec

⚠ IMPOSTAZIONE DELLA POTENZA DEL RADIATORE

Per garantire il corretto funzionamento del radiatore, la potenza del radiatore deve essere impostata tramite il controllo di base. Questo è impostato su 500 W per impostazione predefinita.



Seguire i passi sotto riportati:

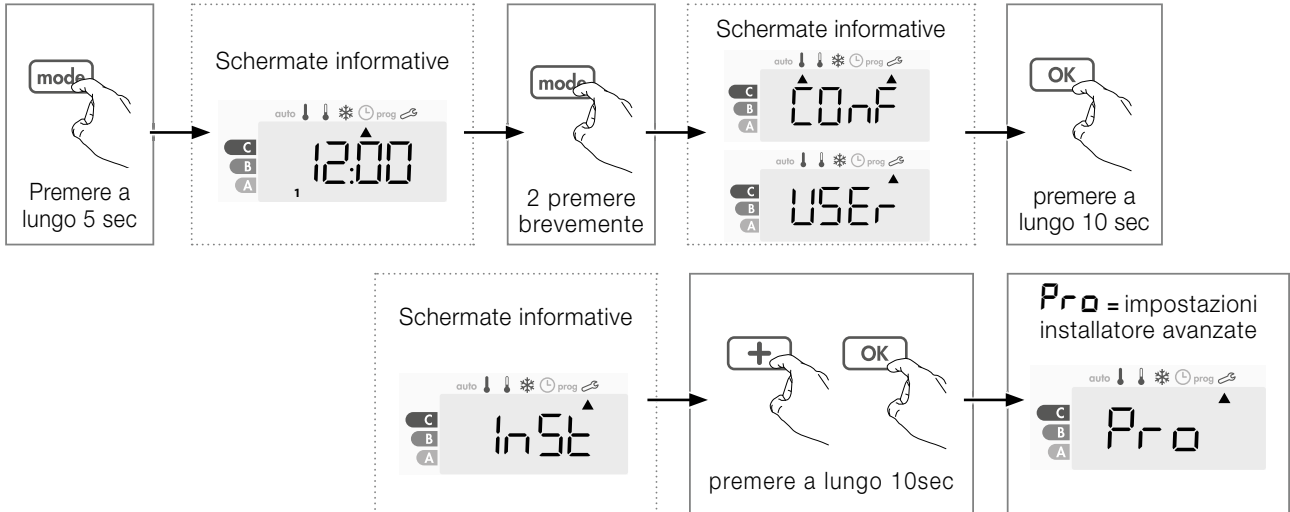

Premere quindi per 3 volte il pulsante **OK** e modificare la potenza utilizzando i pulsanti **-** e **+**. Uscire dal menu premendo per 3 volte il pulsante **mode**.

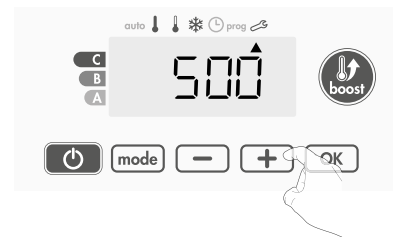

FUNZIONAMENTO

• Panoramica dei pulsanti

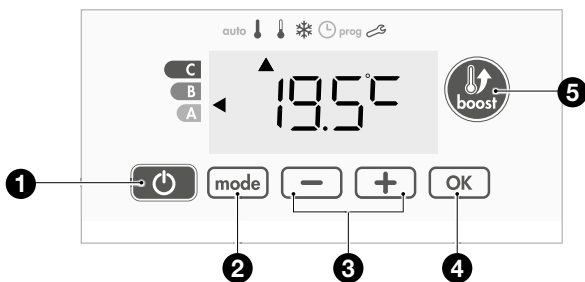

- 1 Accensione/modalità standby
- 2 Selezione delle modalità di funzionamento
- 3 Pulsanti più e meno, utilizzati per impostare le temperature, l'ora, la data e il programma settimanale
- 4 Salvare le impostazioni
- 5 Boost

• Panoramica degli indicatori

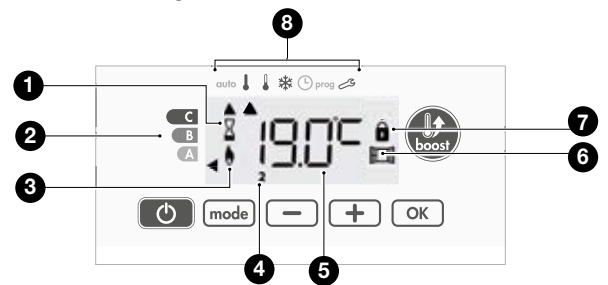

- 1 Indicatore luminoso
- 2 Consumo di energia
- 3 Indicatore di riscaldamento
- 4 Giorni della settimana (1= lunedì ... 7= domenica)
- 5 Impostazione della temperatura
- 6 Indicatore di rilevamento finestra aperta
- 7 Tastierino bloccato

8 Modalità di funzionamento:

- | | | | |
|------|------------------------------|------|--|
| auto | Modalità Auto | 🕒 | Modalità di impostazione di Data e ora |
| ! | Modalità Comfort | prog | Modalità di programmazione |
| ! | Modalità Eco | 🔧 | Impostazioni |
| ❄ | Modalità Protezione antigelo | | |

FUNZIONAMENTO

• Panoramica dei pulsanti del termostato

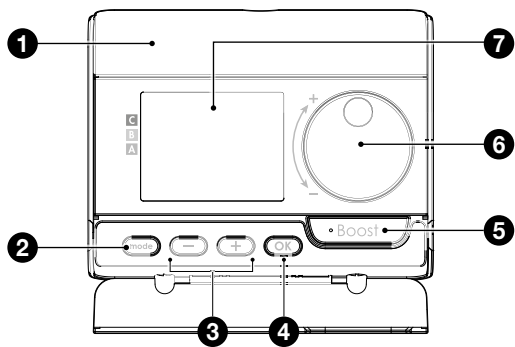

- 1 Vano batterie
- 2 Selezione delle modalità di funzionamento
- 3 Pulsanti + e - utilizzati per impostare le temperature, la data, l'ora e il programma settimanale
- 4 Salvataggio impostazioni
- 5 Pulsante Boost
- 6 Manopola di selezione della temperatura
- 7 Display LCD

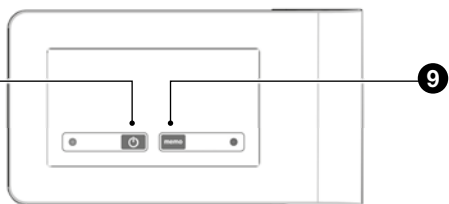

- 8 Accensione/modalità standby
- 9 Radiotrasmissione, sovrascrittura manuale del riscaldamento

• Panoramica degli indicatori

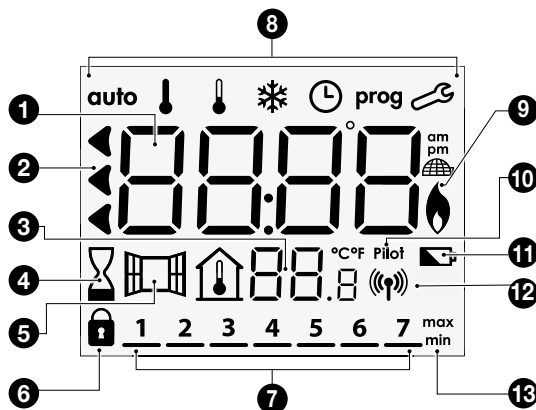

Giorni della settimana (1=lunedì... 7= domenica)

- 1 Setpoint temperatura/ Informazioni
- 2 Consumo di energia
- 3 Temperatura ambiente misurata
- 4 Indicatore luminoso Boost
- 5 Indicatore occupazione di rilevamento finestra aperta
- 6 Tastierino bloccato
- 9 Indicatore riscaldamento
- 10 Indicatore filo pilota (solo per la Francia)
- 11 Indicatore batteria scarica
- 12 Indicatore radiotrasmissione
- 13 Indicatore valore min/max

8 Modalità di funzionamento:

auto modalità Auto ↓ modalità Comfort ↓ modalità Eco
 ❄️ modalità Protezione antigelo ⌚ modalità di impostazione di Data e ora **prog** modalità di programmazione
 🔑 Impostazioni

ACCENSIONE/MODALITÀ STANDBY

Per mettere in funzione il controllo, premere il pulsante in modalità Auto. Per mettere il controllo in modalità standby, premere il pulsante .

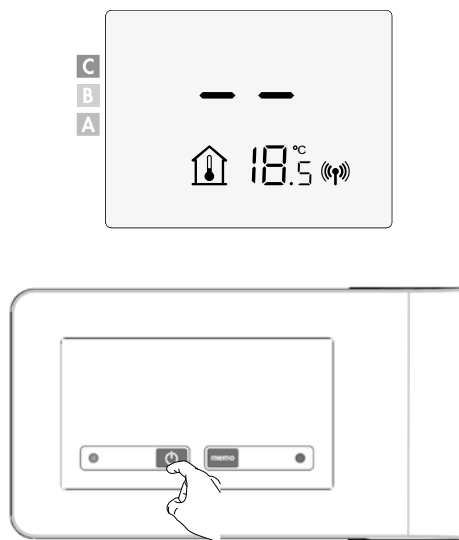
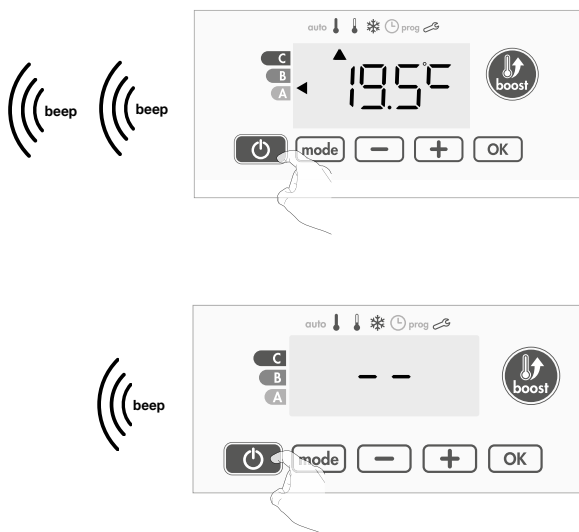

MODALITÀ DI FUNZIONAMENTO

Premere il pulsante  per selezionare la modalità richiesta.



Sequenza modalità:

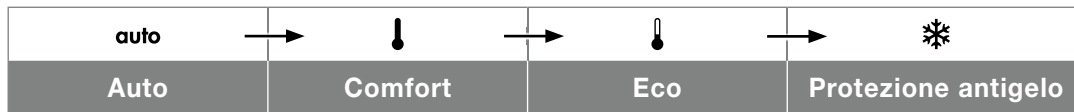

- **auto Modalità automatica (3 situazioni)**

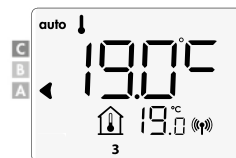
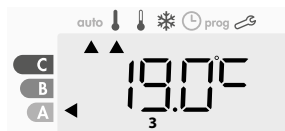

1 Programma settimanale impostato

Se è stato impostato un programma settimanale, il radiatore passa automaticamente dalla modalità Comfort a quella Eco.

BASIC

In caso di interruzione dell'alimentazione per più di 3 ore, il giorno e l'ora dovranno essere ripristinati, il programma settimanale rimarrà permanentemente in memoria.

2 Controllo tramite cavo di comunicazione (Fil Pilote, solo per la Francia)

3 Programma settimanale non impostato

Se il programma settimanale non è impostato, il radiatore funziona in modo permanente in modalità Comfort.

- **Modalità Comfort**

Modalità Comfort non-stop. Il dispositivo funziona 24 ore su 24 per raggiungere la temperatura impostata (ad esempio 19°C). L'utilizzatore può impostare il livello di temperatura della modalità Comfort.



- **Modalità Eco**

In questa modalità la temperatura equivale a quella della modalità Comfort meno 3,5°C. Questo consente di abbassare la temperatura senza dover reimpostare quella della modalità Comfort. Selezionare questa modalità per brevi assenze (comprese tra 2 e 24 ore) e di notte.

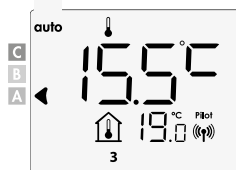

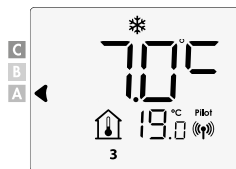

- **Modalità Protezione antigelo**

Questa modalità permette di proteggere la casa dagli effetti del freddo (tubi congelati, ecc.), mantenendo in essa in qualsiasi momento una temperatura minima di 7°C. Selezionare questa modalità quando si sta fuori a lungo (più di 5 giorni).



IMPOSTAZIONE DELLE TEMPERATURA COMFORT

Si può impostare la temperatura Comfort dalla modalità automatica e Comfort. La temperatura predefinita è pari a 19°C.

Utilizzando i tasti  e  si può regolare la temperatura da 7°C a 30°C a intervalli di 0,5°C.

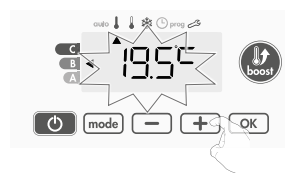

BOOST

Importante: la modalità Boost può essere impostata in qualsiasi momento, a prescindere dalla modalità di funzionamento corrente (Auto, Comfort, Eco o Protezione antigelo).

Prima pressione = Boost.

Nel primo minuto, si può modificare la durata Boost da 0 alla durata massima consentita da tale funzione, premendo **-** e **+**.

Questa modifica verrà salvata ed eseguita al prossimo Boost.



Commento: dopo 1 minuto si può modificare temporaneamente la durata: sarà valida solo per il Boost attivo e, quindi, non ricorrente.

Il Boost può fermarsi se la temperatura ambiente raggiunge la temperatura massima di Boost:

Il dispositivo si spegne, ma la modalità Boost è sempre attiva: il tempo rimanente viene sempre visualizzato, il simbolo Boost e l'indicatore di calore lampeggiano sul display. Quando la temperatura scende al di sotto del valore massimo consentito, la modalità Boost riparte fino all'esaurimento del tempo rimanente.

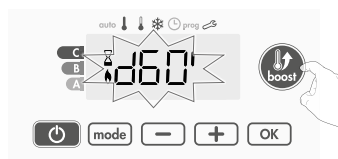

Seconda pressione = Annullamento Boost.

Il cursore si sposta sulla modalità precedentemente attiva e compare la temperatura da impostare.

CONSUMO DI ENERGIA

L'indicatore compare in modalità Auto, Comfort, Eco e Protezione antigelo, a prescindere dal livello di temperatura.

<p>C - Colore rosso maggiore consumo</p>	<p>Temperatura impostata > 22°C</p>		<p>BASIC RF</p>	
<p>B - Colore arancione consumo medio</p>	<p>19°C < Temperatura impostata ≤ 22°C</p>			
<p>A - Colore verde minor consumo</p>	<p>Temperatura impostata ≤ 19°C</p>			

• Visualizzazione del consumo di energia stimato in kWh

Per vedere questa stima dalla modalità Auto, Comfort, Eco o Protezione antigelo, premere **OK**. Per uscire dalla modalità di visualizzazione del consumo: premere qualsiasi pulsante, il dispositivo torna automaticamente alla modalità precedentemente attiva.

• Reset del contatore di energia

Per resettare il contatore di energia dalla modalità Auto, Comfort, Eco o Protezione antigelo, procedere come segue.

1- Premere **OK**.

2- Premere contemporaneamente **-** e **+** per più di 5 secondi.

Per uscire dal reset del contatore di energia, premere qualsiasi pulsante, il dispositivo torna automaticamente alla modalità precedentemente attiva.

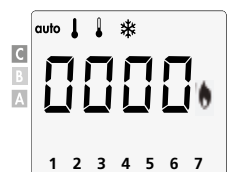
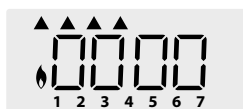

BLOCCO/SBLOCCO

• Blocco del tastierino

Per bloccare il tastierino, premere i pulsanti **-** e **+** tenerli premuti per 10 secondi. Compare il simbolo del lucchetto **🔒** sul display, Il tastierino è bloccato.

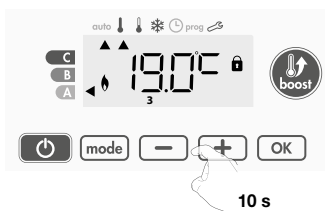

• Sblocco del tastierino

Per sbloccare il tastierino premere i pulsanti **-** e **+** tenerli premuti per 10 secondi. Il simbolo del lucchetto **🔒** scompare dal display, il tastierino è sbloccato.

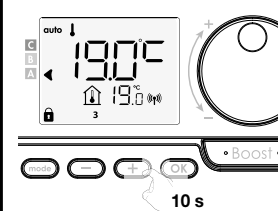

BASIC RF

IMPOSTAZIONE DEL GIORNO E ORA

1- Dalla modalità Auto, Comfort, Eco o Protezione antigelo, premere **mode** per 5 secondi. Il cursore si sposta al giorno da impostare e modalità Ora.



2- Selezionare utilizzando **-** o **+**. Le due cifre dell'ora lampeggiano. Le ore scorrono rapidamente, premendo **-** o **+** e tenendo premuto. Salvare premendo **OK**.

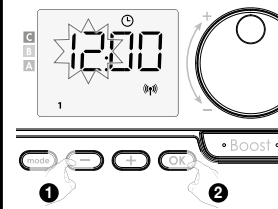
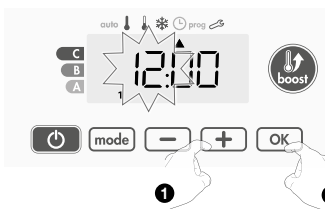

3- Le due cifre dei minuti lampeggiano. Selezionare utilizzando **-** o **+**. Salvare premendo **OK**.

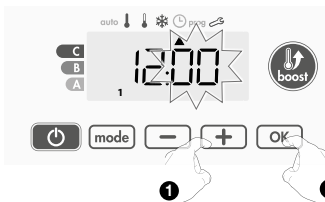

4- Il cursore lampeggia sul numero 1 (che rappresenta lunedì). Selezionare la data utilizzando **-** o **+**. Salvare premendo **OK**.



BASIC RF

Lunedì	1	Venerdì	5
Martedì	2	Sabato	6
Mercoledì	3	Domenica	7
Giovedì	4		

5- Per cambiare e/o assegnare un programma, premere **mode**. Per uscire dalla modalità di impostazione del giorno e dell'ora, premere per 3 volte **mode**.

PANORAMICA DEI PROGRAMMI

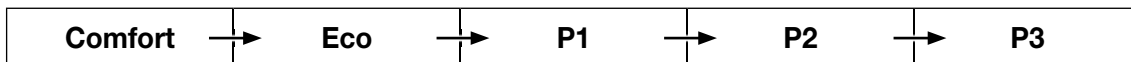

L'impostazione predefinita del controllo è Comfort non-stop per 7 giorni alla settimana.

- **Comfort:** il dispositivo funzionerà in modalità Comfort 24 ore su 24 per ogni giorno selezionato.
- **Eco:** il dispositivo funzionerà 24 ore su 24 in modalità Eco.
- Nota:** si possono impostare i parametri di abbassamento della temperatura, guarda le impostazioni dell'utente
- **P1:** il dispositivo funzionerà in modalità Comfort per 1 intervallo di tempo es dalle 06:00 alle 22:00 (e in modalità Eco dalle 22:00 alle 06:00).
- **P2:** il dispositivo funzionerà in modalità Comfort per 2 intervallo di tempo es dalle 06:00 alle 09:00 e dalle 16:00 alle 22:00 (e in modalità Eco dalle 09:00 alle 16:00 e dalle 22:00 alle 06:00).
- **P3:** il dispositivo funzionerà in modalità Comfort per 3 intervallo di tempo es dalle 06:00 alle 08:00, dalle 12:00 alle 14:00 e dalle 18:00 alle 23:00 (e in modalità Eco dalle 23:00 alle 06:00, dalle 08:00 alle 12:00 e dalle 14:00 alle 18:00).

Nota: se i tempi standard di P1, P2 e P3 non ti si addicono, puoi cambiarli, ma questa volta si applica a tutti i giorni della settimana in cui P1, P2 o P3 sono impostati

IMPOSTAZIONE DEL PROGRAMMA SETTIMANALE

1- Dalla modalità di protezione Auto, Comfort, Eco o Frost, premere **mode** per 5 secondi. Quando il cursore si sposta sul simbolo di impostazione dell'ora , premere brevemente **mode**.

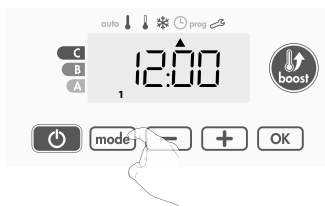

2- Premere **+** o **-** per impostare il programma settimanale.

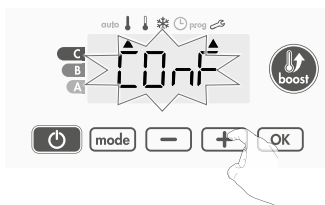

3- Selezionare il programma desiderato con **+** o **-**. Se lo si desidera, è possibile regolare i tempi standard: premere **OK** per almeno 5 secondi. Se si applicano i tempi standard: premere **OK** per impostare il giorno successivo (passare al punto 4)

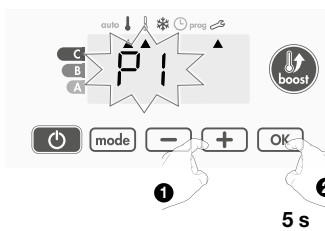

3.1- L'ora di inizio lampeggia e con **+** o **-**, è possibile modificare questo orario a intervalli di 30 minuti. Premere **OK** per salvare.

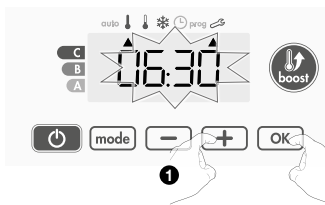

3.2- L'ora di fine lampeggia e con **+** o **-**, è possibile modificare questo orario a intervalli di 30 minuti. Premere **OK** per salvare.

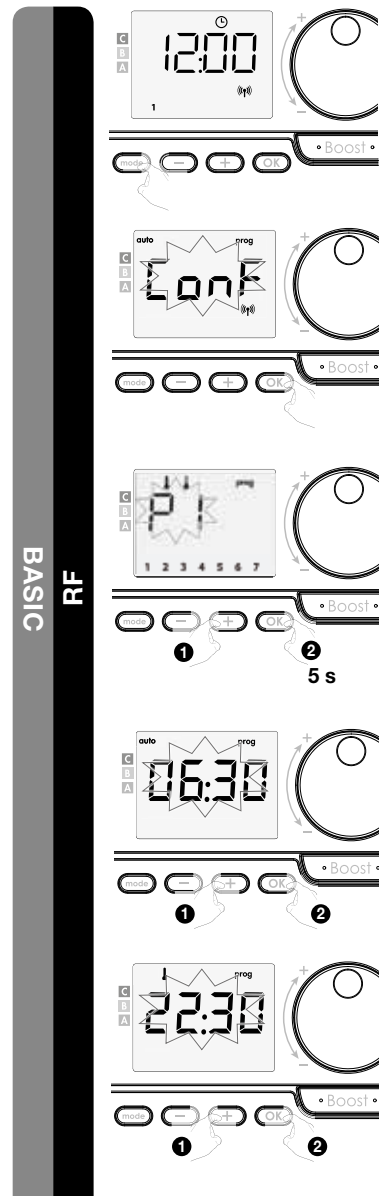
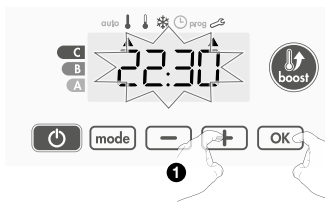

- 4- Il secondo giorno (martedì) lampeggia. Ripeti la procedura sopra descritta per ogni giorno della settimana.

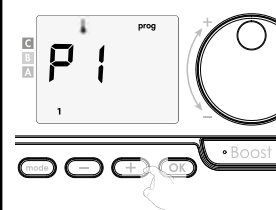
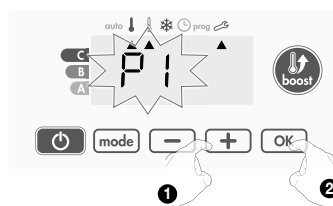

- 5- Una volta selezionato un programma per ogni giorno, confermare la selezione premendo **OK**. I giorni della settimana appaiono sullo schermo con i programmi che hai impostato per loro. Premere **mode** due volte per uscire dalla modalità di programmazione e tornare a "Modalità automatica". Se non viene premuto alcun pulsante per alcuni minuti, l'unità ritorna automaticamente su "Modalità automatica".

VISUALIZZAZIONE DEL PROGRAMMA SETTIMANALE IMPOSTATO

Dalla modalità Auto, Comfort, Eco o Protezione antigelo, premere **mode** per 5 secondi. Premere due volte **mode** (Comfort, Eco, P1, P2 o P3) sul display davanti all'utilizzatore scorrerà il programma per ogni giorno della settimana (Comfort, Eco, P1, P2 o P3).

Per uscire dalla modalità di visualizzazione del programma, premere due volte **mode**.

MODIFICA TEMPORANEA DEL PROGRAMMA SETTIMANALE

Questa funzione permette di modificare temporaneamente la temperatura da impostare fino alla modifica successiva programmata per la temperatura o la transizione al giorno successivo.

Esempio:

- 1- Il controllo è in modalità Auto, il programma corrente è Eco 15,5°C.

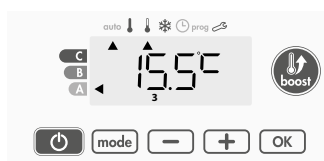

- 2- Premendo **-** o **+**, si può modificare temporaneamente la temperatura desiderata fino a 18°C, ad esempio.

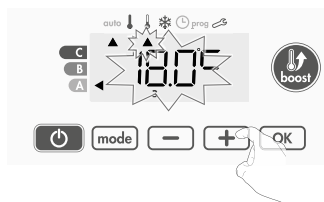

- 3- Questa modifica viene annullata automaticamente al prossimo cambio di programma o transizione al giorno successivo.

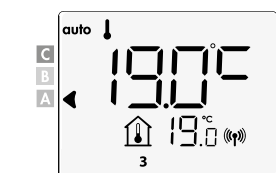
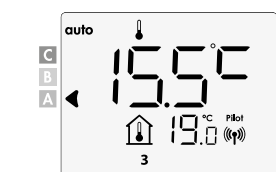
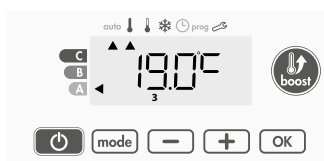

RILEVAMENTO FINESTRA APERTA

Il rilevamento della finestra aperta è sensibile alle fluttuazioni della temperatura. L'unità di controllo risponde alle finestre aperte in base a vari parametri: impostazione della temperatura, aumento e diminuzione della temperatura ambiente, temperatura esterna, posizione dell'unità di controllo, ecc. Se l'unità di controllo è vicina a una porta di ingresso, l'aria di rilevamento può essere disturbata aprendo la porta. Se questo è un problema, ti consigliamo di disabilitare il rilevamento della finestra (vedi le impostazioni dell'installatore).

Quando, aprendo una finestra, il controllo procede a un ciclo di riduzione della temperatura, sul display viene visualizzato un contatore di protezione antigelo per mostrare la durata del ciclo. Il contatore viene automaticamente azzerato la volta successiva che viene attivata la protezione antigelo. Premendo un pulsante, la modalità di protezione antigelo è disattivata.

Nota: se viene rilevato un aumento di temperatura, il controllo tornerà automaticamente alla modalità precedente.

IMPOSTAZIONI UTENTE

ACCESSO

Dalla modalità Auto, Comfort, Eco o Antigelo:

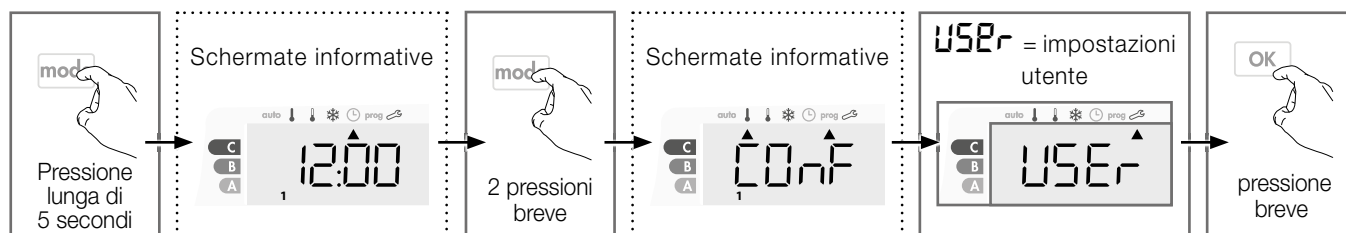

Schema di successione delle impostazioni:

Retro-illuminazione → Riduzione della temperatura Eco → Protezione dal gelo → Limiti di temperatura Comfort superiore e inferiore → Durata massima del Boost → Temperatura massima del Boost → Unità di temperatura → Ripristino delle impostazioni di fabbrica

RETRO-ILLUMINAZIONE

1- Ci sono 3 opzioni disponibili

- L1 = retro-illuminazione a tempo: lo schermo s'illumina quando viene premuto un pulsante.
- L2 = retro-illuminazione costante: lo schermo resta sempre illuminato.
- L3 = uguale all'opzione L1

l'opzione L3 è attivata di default

Premere il pulsante **+** o **-** come si desidera.

2- Per confermare e passare all'impostazione successiva, premere **OK**.

Per confermare e chiudere le impostazioni, premere 2x **mode**.

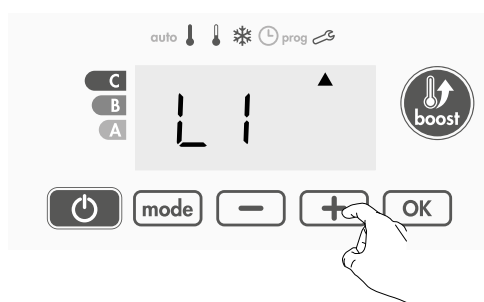

RIDUZIONE DELLA TEMPERATURA ECO

La riduzione è preimpostata su -3,5°C in base alla temperatura di riferimento Comfort. È possibile variarla da -1°C a -8°C, per intervalli di 0,5°C.

Importante: a prescindere dal livello di riduzione impostato, la temperatura di riferimento Eco non supera mai i 19°C.

1- Premere **-** o **+** per visualizzare il valore desiderato.

2- Per confermare e passare all'impostazione successiva, premere **OK**.

Per confermare e chiudere le impostazioni, premere 2x **mode**.

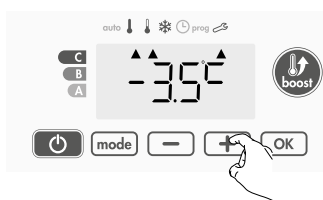

PROTEZIONE ANTIGELO

Il dispositivo è preimpostato su 7°C; il valore di impostazione Antigelo può essere modificato da 5°C a 15°C, per intervalli di 0,5°C.

1- Premere **-** o **+** per visualizzare il valore desiderato.

2- Per confermare e passare all'impostazione successiva, premere **OK**.

Per confermare e chiudere le impostazioni, premere 2x **mode**.

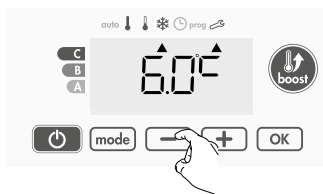

LIMITI DI TEMPERATURA COMFORT SUPERIORE E INFERIORE

• Limitazione della temperatura minima

La soglia minima è preimpostata su 7°C; può essere modificata da -7°C a 15°C, per intervalli di 1°C.

- 1- Per modificare la soglia minima, premere **-** o **+** e confermare premendo **OK**.

Se non si desidera apportare variazioni, premere **OK**: il dispositivo propone automaticamente di impostare la soglia massima.

Per confermare e chiudere le impostazioni, premere 2x **mode**.

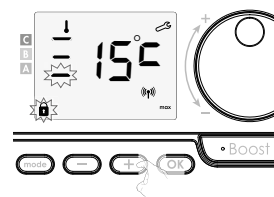
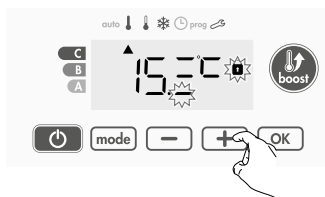

• Limitazione della temperatura alta

La soglia massima è preimpostata su 30°C; può essere modificata da -19°C a 30°C, per intervalli di 1°C.

- 2- Per modificare la temperatura di riferimento massima, premere **-** o **+**.

Premere il pulsante **OK** per confermare e passare all'impostazione successiva.

Per confermare e chiudere le impostazioni, premere 2x **mode**.

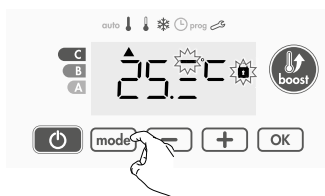

DURATA MASSIMA DEL BOOST

La durata massima del Boost è preimpostata su 60 minuti. È possibile variarla da 30 a 90 minuti, per intervalli di 30 minuti.

- 1- Il simbolo Boost e l'indicatore di riscaldamento appaiono sul display e la durata impostata di 60 minuti lampeggia.

- 2- Premere **-** o **+** per visualizzare la durata desiderata.

- 3- Per confermare e passare all'impostazione successiva, premere **OK**.

Per confermare e chiudere le impostazioni, premere 2x **mode**.

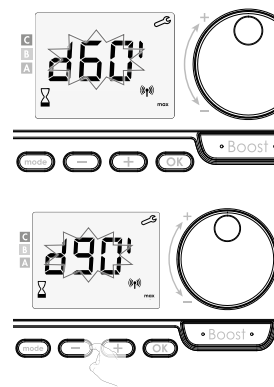
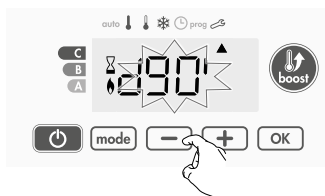
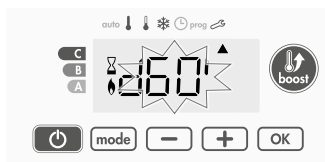

TEMPERATURA MASSIMA DEL BOOST

Quando è attivo il Boost, il radiatore deve riscaldare l'ambiente fino a un limite di temperatura: la massima temperatura del Boost. Quando viene raggiunto questo valore, il Boost si arresta automaticamente. La soglia massima è preimpostata su 35°C; può essere modificata da -25°C a 39°C, per intervalli di 1°C.

- 1- Il simbolo Boost e l'indicatore di riscaldamento appaiono sul display e la temperatura massima lampeggia

- 2- È possibile impostare la temperatura massima del Boost premendo più volte **-** o **+** per intervalli di 1°C, fino a raggiungere 39°C.

- 3- Per confermare e passare all'impostazione successiva automaticamente, premere **OK**.

Per confermare e chiudere le impostazioni, premere 2x **mode**.

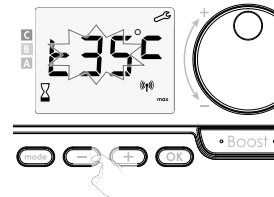
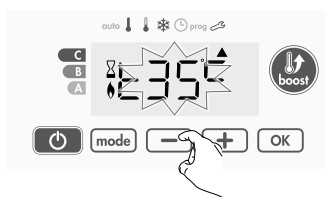

UNITÀ DI TEMPERATURA

L'unità di temperatura predefinita è il grado Celsius.

- 1- Premere **-** o **+** per modificare l'unità di temperatura.
- 2- Per confermare e passare automaticamente all'impostazione successiva, premere **OK**.
Per confermare e chiudere le impostazioni, premere 2x **mode**.

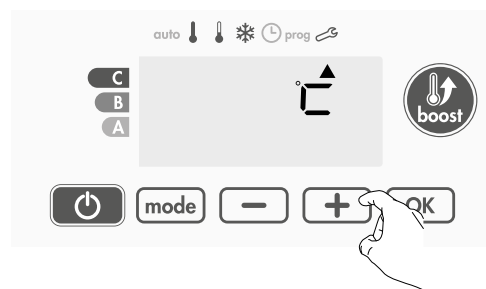

RIPRISTINO DELLE IMPOSTAZIONI DI FABBRICA

- 1- **rest** viene visualizzato per 1 secondo.

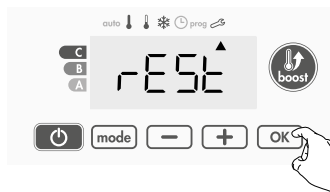

- 2- **no** lampeggia.
Premere **-** o **+** per selezionare **yes**.

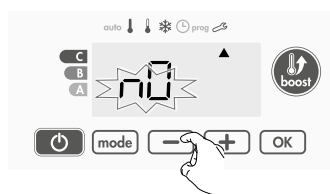

- 3- Premere **OK** per 5 secondi.
Il dispositivo ritorna alla configurazione originale, attivando automaticamente la modalità Auto.

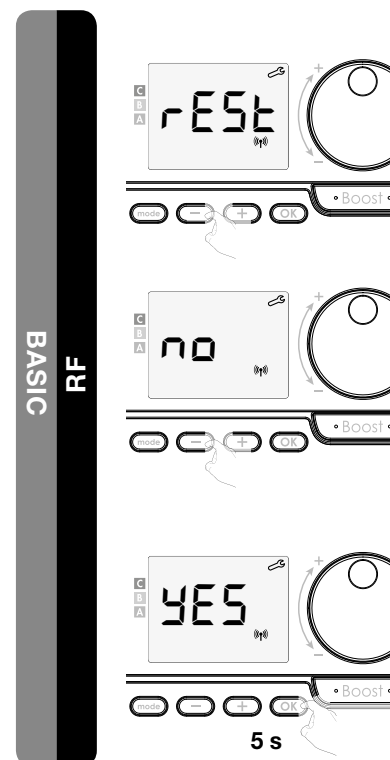
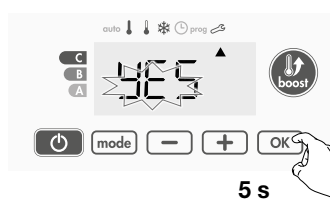

Generale

Riferimento temperatura Comfort	19 °C
Durata del Boost	60 min.
Blocco tastiera	Disattivato

Impostazioni utente

Retro-illuminazione	L3	BASIC
Livello di riduzione Eco	-3,5 °C	
Protezione antigelo	7 °C	
Limitazione minima della temperatura Comfort	7 °C	
Limitazione massima della temperatura Comfort	30 °C	
Durata massima del Boost	60 min.	
Temperatura massima del Boost	35 °C	
Unità di temperatura	°C	

Premere 2x **mode** per confermare e chiudere le impostazioni.

IMPOSTAZIONI INSTALLATORE

ACCESSO

Dalla modalità Auto, Comfort, Eco o Antigelo:

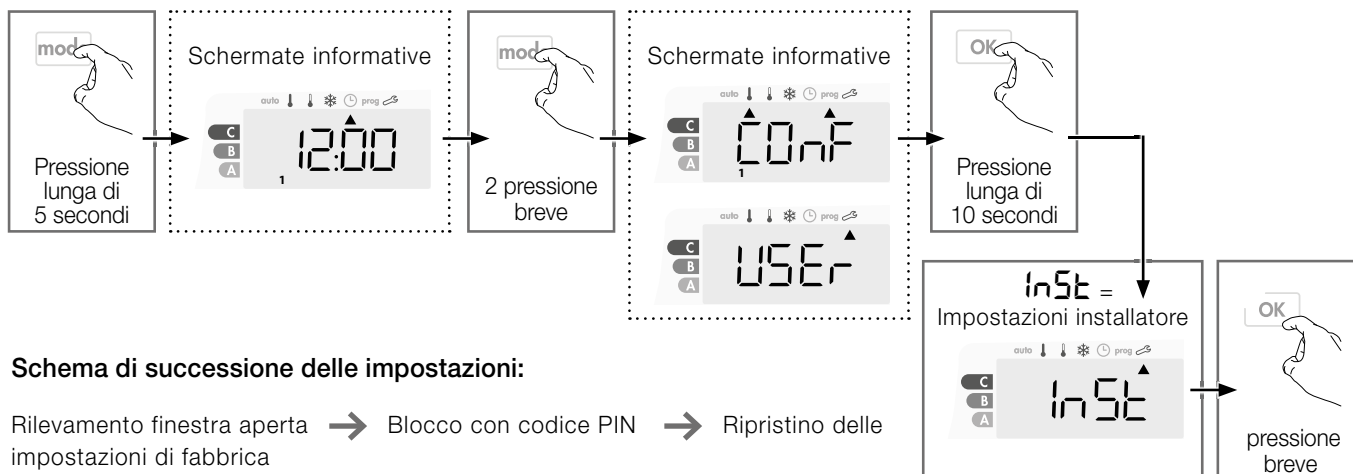

RILEVAMENTO FINESTRA APERTA

1- La modalità automatica di rilevamento apertura finestra è attiva per default.

2- Premere **-** o **+**.

On = modalità automatica attivata.

OFF = modalità automatica disattivata.

3- Premere **OK** per confermare e passare all'impostazione successiva.

Per confermare e chiudere le impostazioni, premere 3x **mode**.

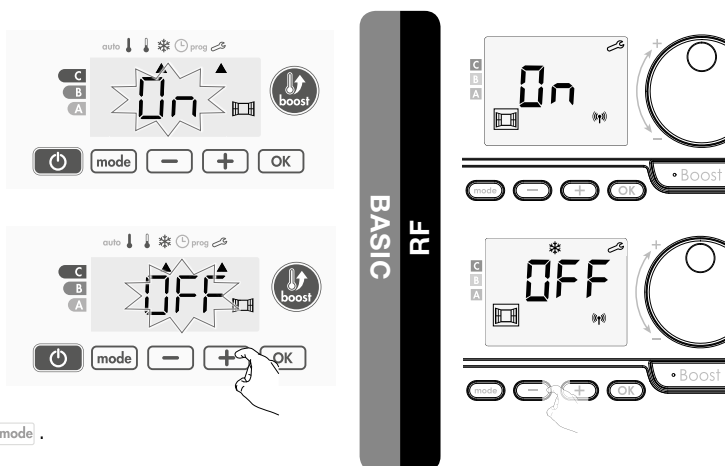

FUNZIONE DI OTTIMIZZAZIONE

-In modalità **OPTI ECO (efficienza energetica)**, il controllo calcola il miglior compromesso per garantire il massimo risparmio energetico durante le fasi di riscaldamento e raffreddamento programmate. Una leggera diminuzione del livello di temperatura all'inizio e alla fine del periodo di comfort ha permesso di massimizzare il risparmio energetico.

-In modalità **OPTI COMFORT (efficienza di comfort)**, il controllo calcola il miglior compromesso per garantire il massimo comfort durante le fasi di riscaldamento e raffreddamento programmate. Viene data priorità all'anticipazione e al mantenimento della temperatura di comfort durante i periodi di Comfort.

La modalità OPTI COMFORT è attivata di default.

La parola **OP / :** appare brevemente sul display e poi alternato con la modalità **ConF**, **ECO** o **OFF** impostata.

ConF = funzione di ottimizzazione attivata per la modalità OPTI COMFORT, priorità per il comfort.

1- Premere **-** o **+**.

ConF = unzione di ottimizzazione attivata per la modalità OPTI COMFORT, priorità per l'efficienza del comfort.

ECO = funzione di ottimizzazione attivata per la modalità OPTI ECO, priorità per l'efficienza energetica.

OFF = funzione di ottimizzazione disattivata.

2- Premere **OK** per confermare e passare all'impostazione successiva.

Per confermare e chiudere le impostazioni, premere 3x **mode**.

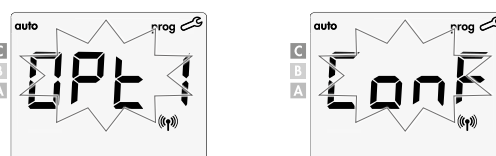

BLOCCO CON CODICE PIN

● Panoramica

È possibile impostare da soli il codice pin a 4 cifre che, una volta attivato, rende le seguenti funzioni non disponibili:

- Selezione della modalità Comfort: sono disponibili solo le modalità Auto, Eco e protezione dal gelo.
- Impostazione della temperatura di Comfort, Eco e protezione antigelo.
- Modifica del programma settimanale.
- Impostazione del rilevamento finestra aperta..

Durante il primo utilizzo della protezione “tastiera tramite codice PIN”, sono necessari tre passaggi importanti:

- 1- Inizializzazione del codice PIN, inserimento del codice PIN predefinito (0000) per accedere alla funzione.
- 2- Attivazione del codice PIN per bloccare le impostazioni da proteggere.
- 3- Personalizzazione del codice PIN, cioè sostituzione delle cifre (0000) con un codice personalizzato a quattro cifre.

● Inizializzazione del codice PIN = ‘0000’

Per default il codice PIN non è attivo. = OFF

- 1- Il codice PIN predefinito è 0000.

Utilizzare **-** o **+** per selezionare la cifra 0.
Lo 0 lampeggia; confermarlo premendo **OK**.

- 2- Per le cifre rimanenti, selezionare la cifra 0 premendo **OK**.

Quando è visualizzato 0000, premere di nuovo **OK** per confermare.

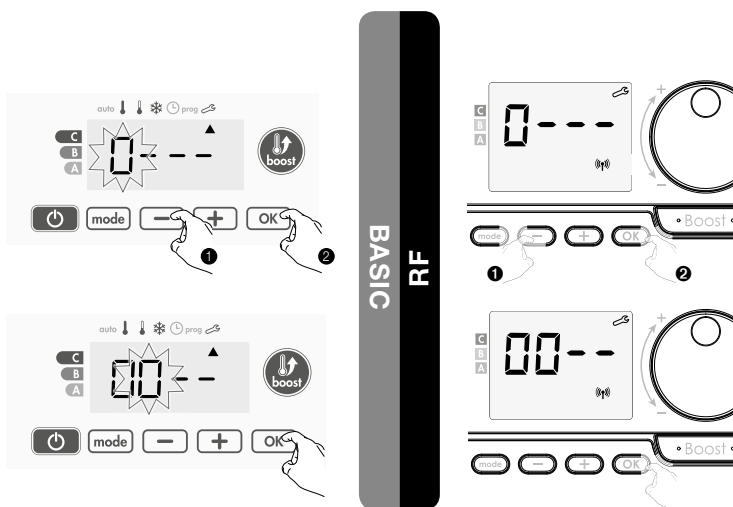

Il codice PIN è inizializzato e il dispositivo propone automaticamente la seguente impostazione: attivazione del codice PIN.

● Attivazione/disattivazione del codice PIN

- 1- Sullo schermo compare OFF

Premere **-** o **+** per attivare il codice PIN.

On = codice PIN attivato
OFF = codice PIN disattivato

- 2- Premere **OK** per confermare e passare all'impostazione successiva.

Ora il codice PIN è stato attivato.

Le impostazioni elencate in “Panoramica” non sono modificabili.

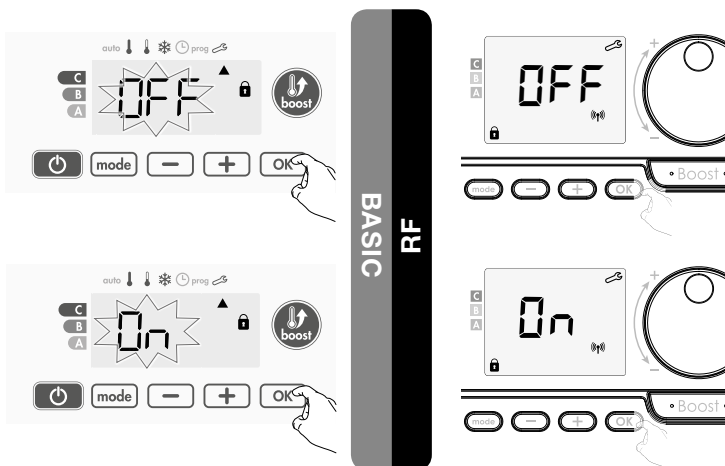

● Personalizzazione del codice PIN

- 1- Quando viene visualizzato **On**, premere **OK** per 5 secondi almeno.

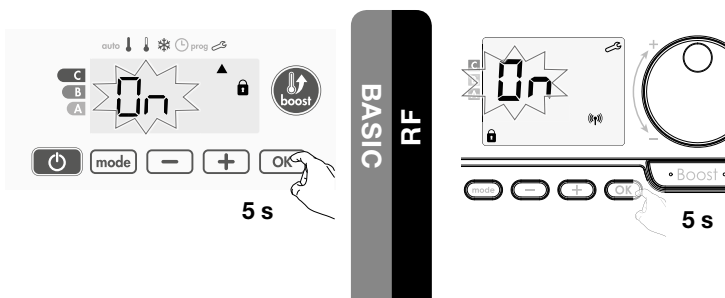

2- Viene visualizzato il codice 0000 e la 1^a cifra lampeggia.
 Con **-** o **+**, selezionare la cifra desiderata e poi premere **OK** per confermarla.
 Procedere nello stesso modo per le tre cifre restanti.

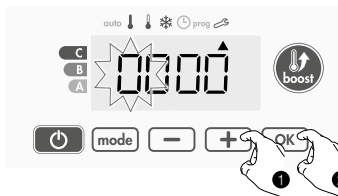

3- Premere **OK** per confermare. Ora il nuovo codice è stato registrato.

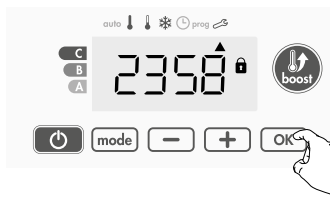

4- Premere di nuovo **OK** per chiudere la modalità di configurazione del codice PIN e ritornare all'inizio delle impostazioni installatore.

Premere 3x **mode** per confermare e chiudere le impostazioni installatore



RIPRISTINO DELLE IMPOSTAZIONI DI FABBRICA

Se la protezione con codice PIN è disattivata, è possibile riportare le impostazioni utente e installatore ai valori di origine.

1- **rest** viene visualizzato.



2- **no** lampeggia.

Premere **-** o **+** per selezionare **yes**

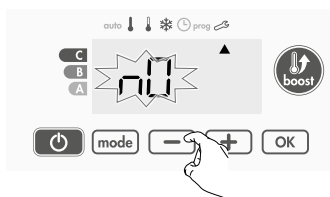

3- Premere **OK** per 5 secondi.

Il dispositivo ritorna alla configurazione originale, attivando automaticamente la modalità Auto.

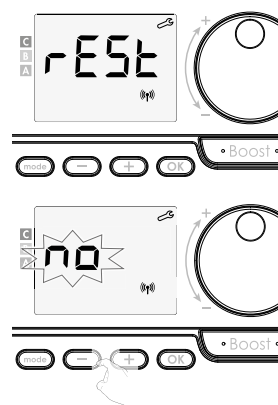

Generale

Riferimento temperatura Comfort	19 °C
Durata del Boost	60 min.
Blocco tastiera	Disattivato

Impostazioni utente

Retro-illuminazione	L3	BASIC
Livello di riduzione Eco	-3,5 °C	
Protezione antigelo	7 °C	
Limitazione minima della temperatura Comfort	7 °C	
Limitazione massima della temperatura Comfort	30 °C	
Durata massima del Boost	60 min.	
Temperatura massima del Boost	35 °C	
Unità di temperatura	°C	

Impostazioni installatore

Rilevamento di apertura finestra	Attivato
Funzione di ottimizzazione	Opzione comfort RF
Protezione dal codice PIN	Disattivato
Valore dal codice PIN	0000

Premere 3x **mode** per confermare e chiudere le impostazioni installatore

IMPOSTAZIONI INSTALLATORE AVANZATE

ACCESSO

Dalla modalità Auto, Comfort, Eco o Antigelo:

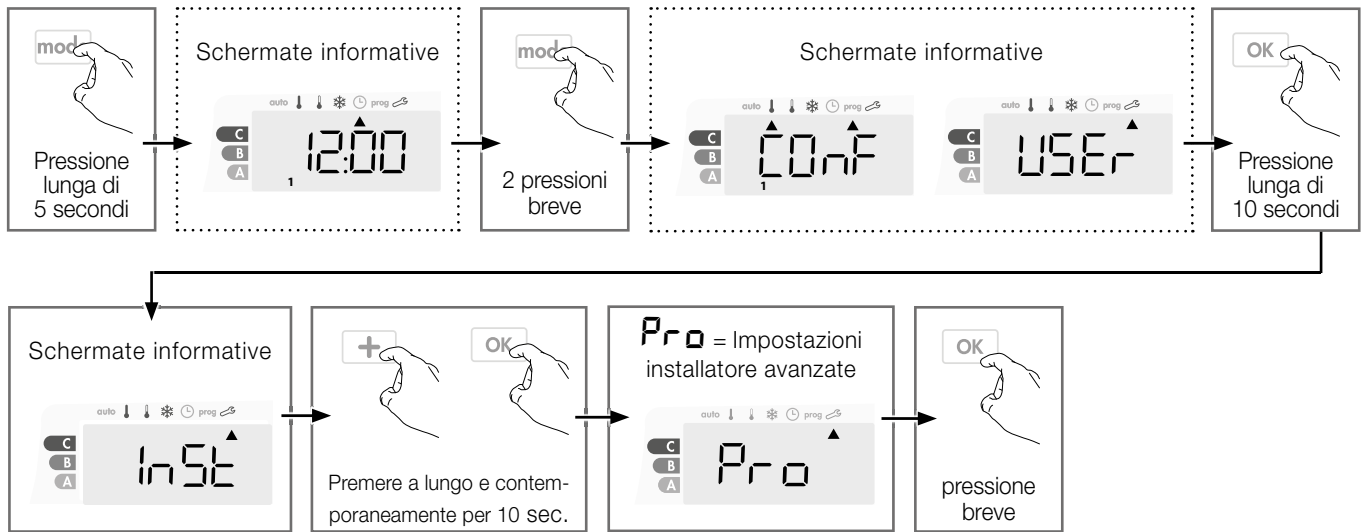

Sequenza di impostazione:

Calibrazione del sensore di temperatura → Potenza del radiatore → Ripristino delle impostazioni di fabbrica

CALIBRAZIONE DEL SENSORE DI TEMPERATURA

● Panoramica



Importante: Questa operazione è riservata soltanto agli installatori professionali; eventuali modifiche errate comportano anomalie nel controllo.

La calibrazione adegua la temperatura misurata dal sensore della temperatura ambiente per compensare deviazioni da + 5°C a - 5°C in intervalli di 0,1°C.

La calibrazione può essere eseguita per ciascun controllo collegato. A seconda del numero di controlli, si avvia impostando la calibrazione dal primo controllo, quindi dal secondo all'ultimo controllo. È possibile identificare il numero di controllo quando si imposta la calibrazione sul display.

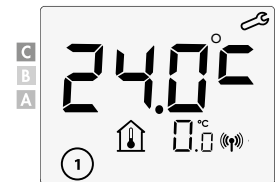

● Calibrazione

1- Se la differenza della temperatura ambiente è negativa, ad esempio:

Temperatura impostata (quella desiderata) = 20°C.

Temperatura ambiente (quella che si legge su un termometro attendibile) = 18°C.

Differenza misurata = -2°C.



Prima di eseguire la calibrazione, si raccomanda di attendere 4 ore dalla modifica della temperatura impostata per assicurarsi che la temperatura ambiente si sia stabilizzata.

Per correggere il valore, procedere come segue:

Temperatura sensore = 24°C

Ridurre la temperatura misurata dal sensore della temperatura ambiente di 2°C premendo **-**.

Per confermare il nuovo valore, premere **OK**.

Per uscire dalle impostazioni, premere 3 volte **mode**.



2- Se la differenza della temperatura ambiente è positiva, ad esempio:

Temperatura impostata (quella desiderata) = 19°C.

Temperatura ambiente (quella che si legge su un termometro attendibile) = 21°C.

Differenza misurata = +2°C.

Per correggere il valore, procedere come segue:

Temperatura sensore = 21°C

Aumentare la temperatura misurata dal sensore della temperatura ambiente di 2°C premendo **+** .

Per convalidare il nuovo valore, premere **OK** .

Per uscire dalle impostazioni, premere 3 volte **mode** .

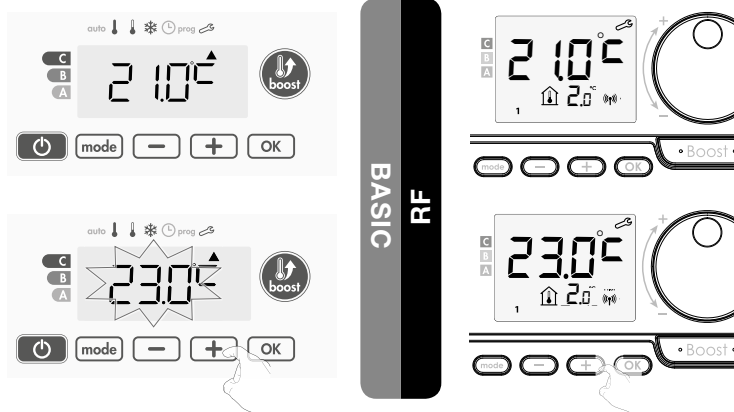

● Resettare la calibrazione del sensore

1- Quando appare la temperatura misurata dal sensore, premere **-** o **+** per almeno 3 secondi.

2- Per confermare e passare all'impostazione successiva, premere **OK** .

Per uscire dalle impostazioni, premere 3 volte **mode** .

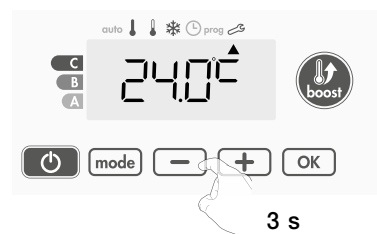

POTENZA DEL RADIATORE

Per garantire il corretto funzionamento del radiatore e per poter stimare correttamente il consumo di energia, è fondamentale regolare la potenza del radiatore.

BASIC: questa impostazione deve essere effettuata alla prima messa in servizio.

RF: durante il collegamento RF, questa impostazione viene automaticamente discussa.

1- Selezionare un valore compreso tra 500W e 1500W premendo **+** o **-** .

2- Per confermare e passare all'impostazione successiva, premere **OK** .

Per uscire dalle impostazioni, premere 3 volte **mode** .

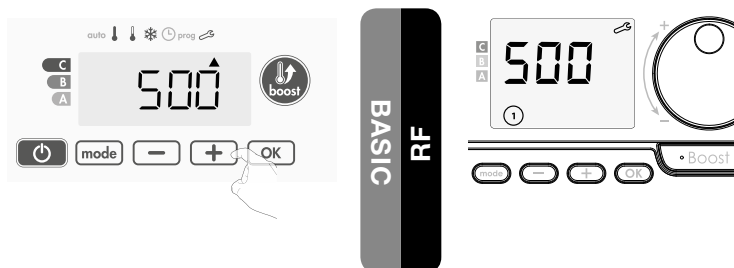

RIPRISTINO DELLE IMPOSTAZIONI DI FABBRICA

Se la protezione con codice PIN è disattiva, vengono reinizializzate le impostazioni dell'utilizzatore e dell'installatore (anche quelle avanzate):

1- **REST** viene visualizzato.

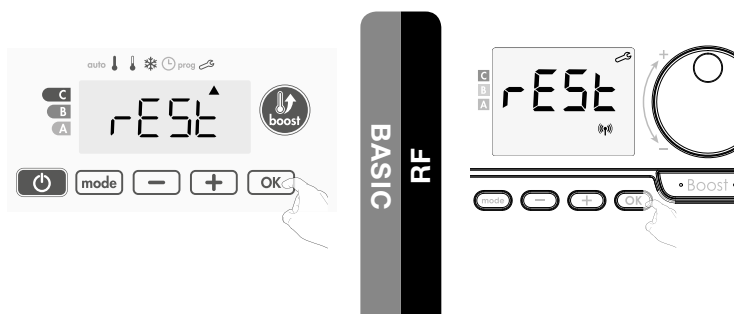

2- Appare **n0**. Premere **-** o **+** per selezionare **YES**.

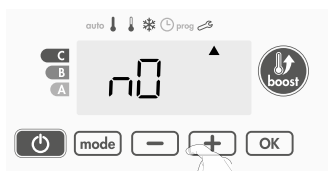

3- Premere il tasto **OK** per 5 secondi.
Il dispositivo ritorna alla configurazione iniziale e, automaticamente, alla modalità Auto.

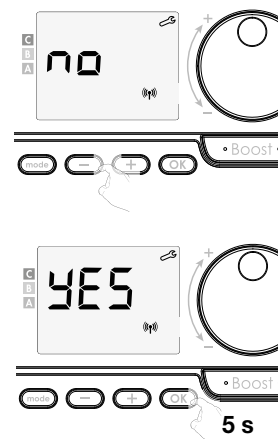
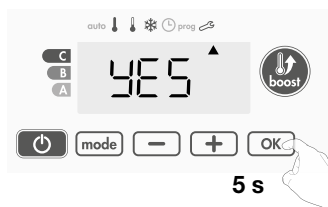

Generale

Riferimento temperatura Comfort	19 °C
Durata del Boost	60 min.
Blocco tastiera	Disattivato

Impostazioni utente

Retro-illuminazione	L3	BASIC
Livello di riduzione Eco	-3,5 °C	
Protezione antigelo	7 °C	
Limitazione minima della temperatura Comfort	7 °C	
Limitazione massima della temperatura Comfort	30 °C	
Durata massima del Boost	60 min.	
Max. temperatura del Boost	35 °C	
Unità di temperatura	°C	

Impostazioni installatore

Rilevamento di apertura finestra	Attivato	
Funzione di ottimizzazione	Opzione comfort	RF
Protezione dal codice PIN	Disattivato	
Valore dal codice PIN	0000	

Impostazioni installatore avanzate

Calibrazione del sensore di temperatura	0,0
Potenza del radiatore	500W

Per uscire dalle impostazioni, premere 3 volte **mode**.

INSTRUKCJE BEZPIECZEŃSTWA



Urządzenie nie może być używane przez osoby (między innymi dzieci) z ograniczoną sprawnością fizyczną, czuciową lub psychiczną, jak również osoby niedoświadczone i nieposiadające wystarczającej wiedzy, chyba że osoby te będą nadzorowane przez osobę odpowiedzialną lub otrzymają stosowne instrukcje.

Dzieciom nie wolno bawić się urządzeniem, nawet jeżeli są nadzorowane.



Nie wolno zakrywać grzejnika żadnymi materiałami ani nie wolno go montować bezpośrednio pod gniazdem zasilania. Zawsze powinna istnieć możliwość łatwego wyłączenia grzejnika. Jeżeli grzejnik jest podłączony przy użyciu wtyczki, powinna ona mieć zewnętrzny wyłącznik. W przypadku stałego połączenia przewodowego obwód elektryczny powinien być zabezpieczony bezpiecznikiem.

Podczas montażu należy przestrzegać lokalnych/krajowych przepisów dotyczących instalacji elektrycznych i stosować się do naszych ogólnych warunków użytkowania.



UTYLIZACJA ZGODNIE Z DYREKTYWĄ UNII EUROPEJSKIEJ (2012/19/UE) W SPRAWIE ZUŻYTEGO SPRZĘTU ELEKTRYCZNEGO I ELEKTRONICZNEGO (WEEE)

Symbol umieszczony na tabliczce identyfikacyjnej grzejnika oznacza, że nie można go wyrzucać wraz z odpadami z gospodarstwa domowego, ale należy utylizować go osobno, aby umożliwić jego recykling. Po upływie okresu eksploatacji grzejnika należy oddać go do punktu zbiórki odpadów elektrycznych i elektronicznych. Aby uzyskać więcej informacji o recyklingu i punktach zbiórki odpadów, należy skontaktować się z władzami lokalnymi/radą miasta albo zakładem gospodarki odpadami w tych krajach, w których dyrektywa została przeniesiona do prawa krajowego.

DANE TECHNICZNE

- Napięcie robocze: 230 V, AC 50 Hz
- Moc maksymalna 1500 W, obciążenie rezystancyjne
- Przewód zasilający, klasa II, długość 800 mm, 3-żyłowy.



Czarna, ekranowana żyła służy do komunikacji i jest stosowana wyłącznie we Francji. Nie wolno jej podłączać do uziemienia. Nie używana żyła powinna być zaizolowana.

Jeżeli przewód zasilający jest uszkodzony, należy skontaktować się z instalatorem.

- Pobór mocy w trybie gotowości: < 0,5 W
- Elektroniczny PID, obwód przekaźnika + triak



- IPX4
- Klasa II w przypadku montażu przeprowadzonego przez instalatora (zgodnie z normą EN60335-1)



PISEMNA DEKLARACJA PRODUCENTA



Niniejszym deklarujemy na własną odpowiedzialność, że produkty opisane w tej instrukcji obsługi mają certyfikat CE i spełniają wszystkie podstawowe wymagania określone w następujących dyrektywach i normach zharmonizowanych:

- LVD 2014/35/EU: EN60335-1/EN60335-2-30/EN60335-2-43/ EN62333
- EMC 2014/30/EU: EN55014-1/EN55014-2-30/EN61000-3-2/ EN61000-3-3
- ERP 2009/125/CE
- RoHS 2011/65/EU: EN50581

a produkty zostały wyprodukowane zgodnie z certyfikowanymi procesami określonymi w normie ISO 9001 V2015.

Urządzenie jest zgodne z wymaganiami określonymi w dyrektywie europejskiej dotyczącej ekoprojektu dla miejscowych ogrzewaczy pomieszczeń 2015/1188:

Wymagane informacje dotyczące urządzeń elektrycznych do miejscowego ogrzewania pomieszczeń			
Parametr	Symbol	Wartość	Jednostka
Moc grzewcza			
Znamionowa moc grzewcza	P nom	0,5 → 1,5	kW
Minimalna moc grzewcza	P min	0,5	kW
Maksymalna ciągła moc grzewcza	P max,c	1,5	kW
Dodatkowe zużycie elektryczności			
Przy znamionowej mocy grzewczej	el max	0,000	kW
Przy minimalnej mocy grzewczej	el min	0,000	kW
W trybie gotowości	el sb	0,0005	kW
Typ mocy grzewczej/regulacji temperatury w pomieszczeniu			
Elektroniczna regulacja temperatury w pomieszczeniu i sterownik tygodniowy			
Inne opcje sterowania			
Regulacja temperatury w pomieszczeniu, w tym automatyczne wykrywanie otwartych okien			
Opcjonalny pilot zdalnego sterowania			
RF	Z adaptacyjną regulacją startu		
Szczegóły kontaktowe			
Zapoznać się z tabliczką identyfikacyjną grzejnika			

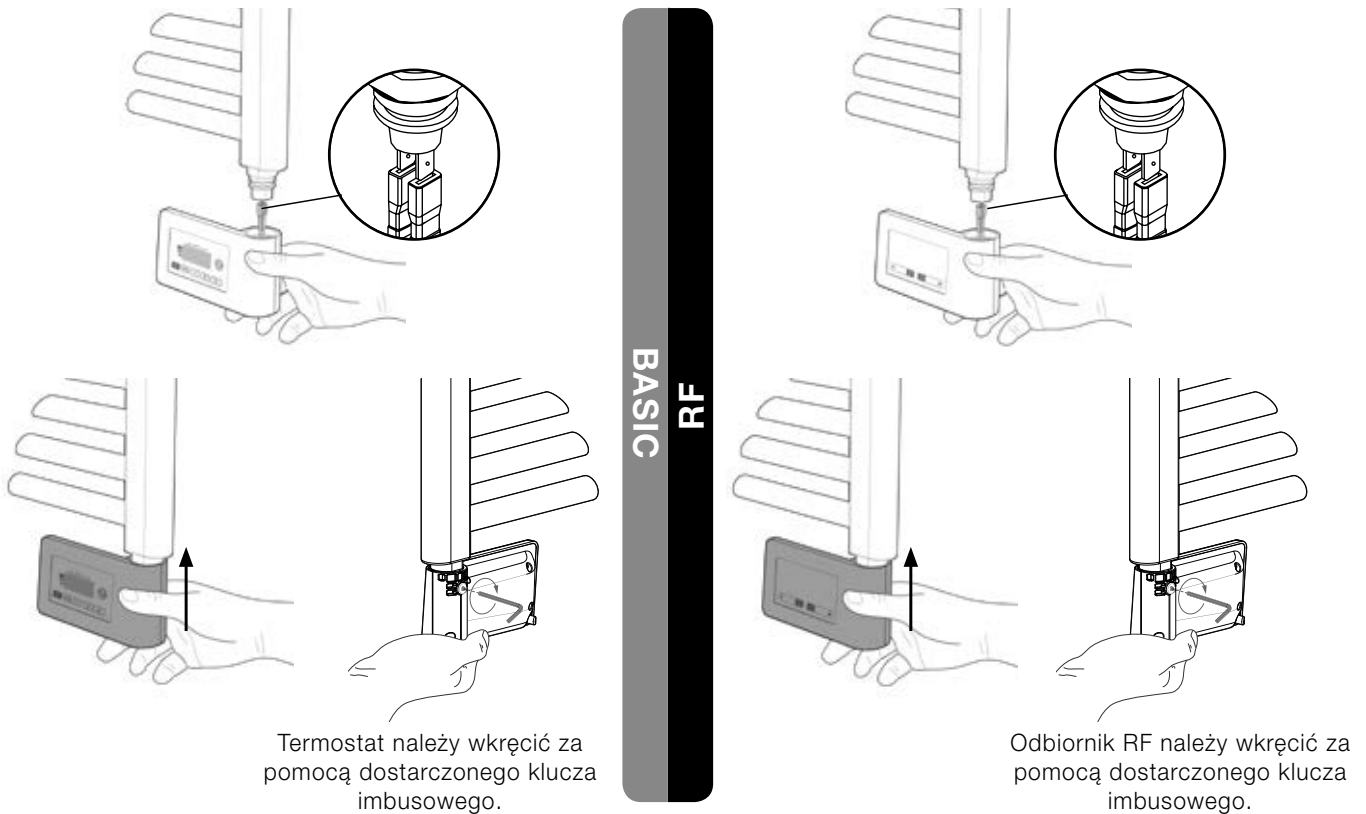

WKŁADANIE BATERII

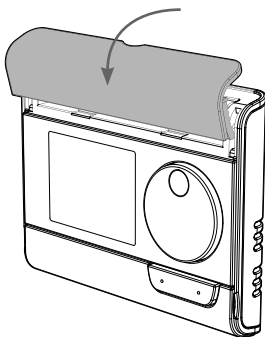

Usuń pokrywę komory na baterie znajdującą się na froncie urządzenia.

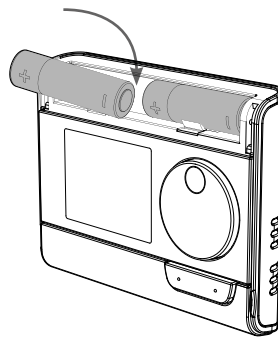

Włóż do komory 2 załączone baterie AA. Uważaj przy tym, aby je właściwie ułożyć zgodnie z biegunami podanymi na urządzeniu.

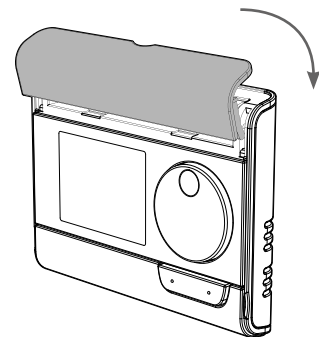

Zamknij pokrywę komory na baterie.

INSTALACJA URZĄDZENIA DO ZDALNEGO STEROWANIA RF

Do ściany

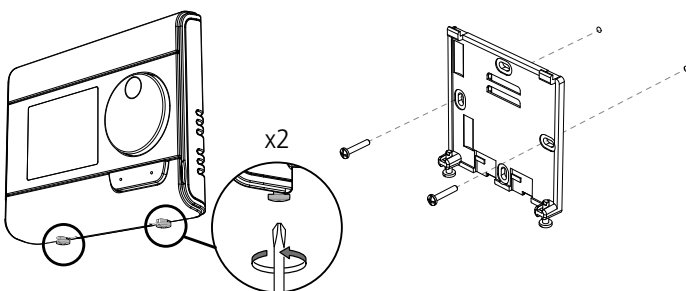

Odkręć 2 śruby znajdujące się pod urządzeniem.

Przykręć płytkę do instalacji na ścianie za pomocą 2 załączonych śrub, korzystając w tym celu z jej poziomych i pionowych otworów.

Na uchwycie

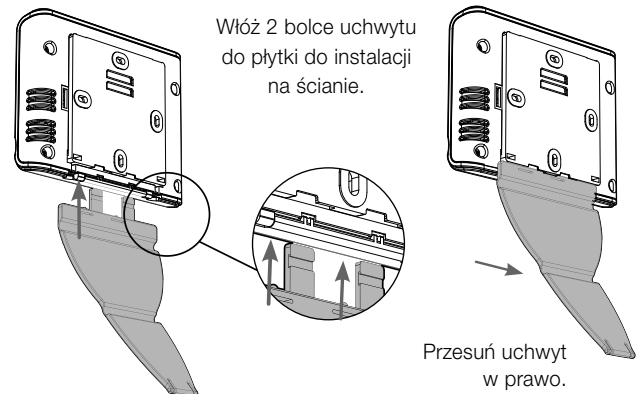

Włóż 2 bolce uchwytu do płytki do instalacji na ścianie.

Przesuń uchwyt w prawo.

SPAROWANIE ODBIORNIKA RF Z URZĄDZENIEM DO ZDALNEGO STEROWANIA RF

Urządzenie do obsługi zdalnej RF (radiowej) i odbiornik RF nie są ze sobą fabrycznie sparowane.

Uwaga: z jednym urządzeniem do zdalnego sterowania RF może być powiązanych do 5 odbiorników RF.

Dla każdego odbiornika RF należy wykonać wyszczególnione poniżej kroki.

Parowanie RF:

1. Przesław odbiornik RF w tryb parowania naciskając przycisk  przez 5 sekund.

Lampka  LED zacznie migać na CZERWONO.



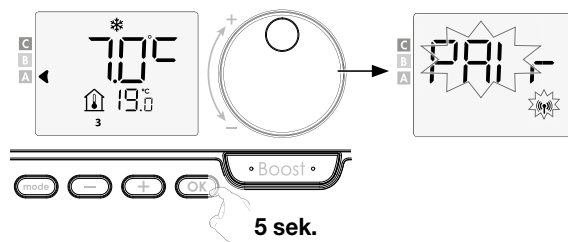

2. Przesław urządzenie do zdalnego sterowania RF w tryb Ochrony przed mrozem naciskając 3 razy przycisk .

Następnie naciśnij  przez 5 sekund.



3. Aby grzejnik pracował prawidłowo, jego moc musi być ustawiona za pomocą urządzenia do zdalnego sterowania RF. Ustawienie to pojawia się automatycznie podczas parowania RF. Moc jest fabrycznie ustawiona na 500W.

Przy pomocy przycisków  i  ustaw moc grzejnika (zobacz na tabliczce znamionowej grzejnika).

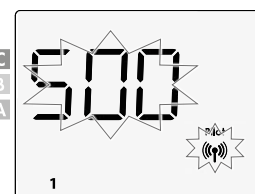

4. Po powiązaniu urządzenia do zdalnego sterowania RF z odbiornikiem RF pojawi się symbol  który pozostanie wyświetlony.

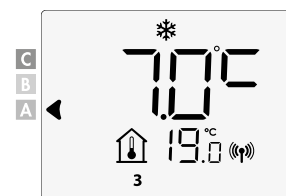

Anulowanie sparowania RF:

Naciśnij i przytrzymaj przycisk Memo na odbiorniku RF przez ponad 10 sekund.

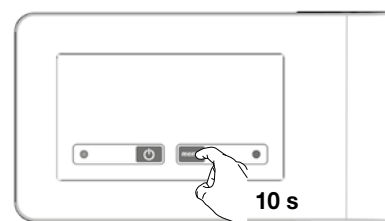

Status trybu pracy



Status komunikacji radiowej (RF)



Status trybu pracy	Status i kolor diody LED
Tryb gotowości	Wyłączony
Włączony	Zielony
Ogrzewanie	Czerwony
Boost	Miga na czerwono
Ochrony przed mrozem, wykrywanie otwartego okna	Miga na zielono
Ręczne usunięcie (przycisk MEMO)	Miga na pomarańczowo

Status komunikacji radiowej (RF)	Status i kolor diody LED
Tryb gotowości	Wyłączony
Brak połączenia RF	Czerwony
Parowanie RF	Miga na czerwono
Anulowanie sparowania RF	Miga szybko na czerwono
Połączenie RF OK	Zielony
Otrzymał komunikat RF	Miga bardzo szybko na zielono przez 1 sek.

⚠ USTAWIANIE MOCY GRZEJNIKA

Aby grzejnik pracował prawidłowo, jego moc musi być ustawiona za pomocą ustawień podstawowych. Moc jest fabrycznie ustawiona na 500 W.



Należy wykonać następujące kroki:

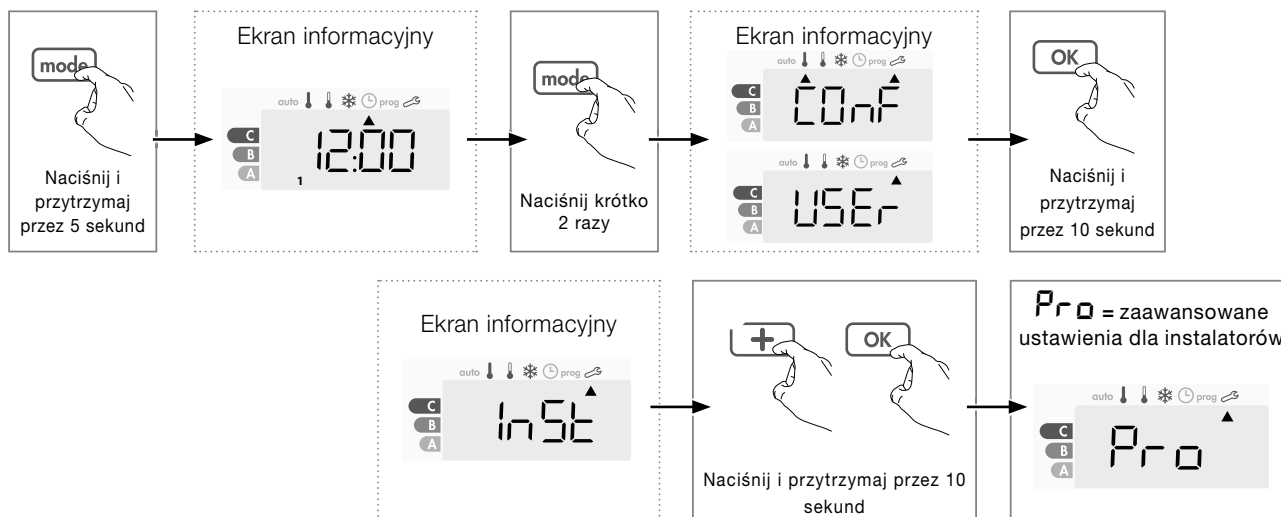

Naciśnij 2 razy przycisk **OK** i zmień wartość mocy używając **-** i **+**.
Wyjdź z menu naciskając 3 razy **mode**.

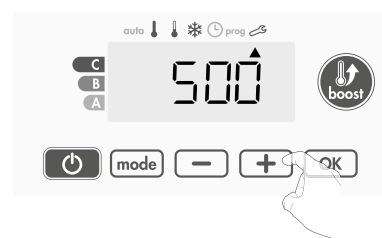

OBSŁUGA

• Opis przycisków

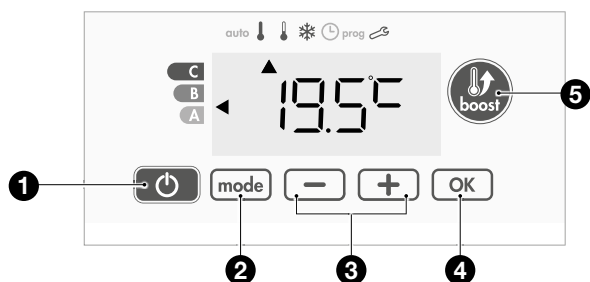

- 1 Przycisk włączania/trybu czuwania
- 2 Wybór trybów pracy urządzenia
- 3 Przyciski plus i minus – do ustawiania wartości temperatury, godziny, daty i program tygodniowy
- 4 Zapisywanie ustawień
- 5 Funkcja Boost

• Opis wskaźników

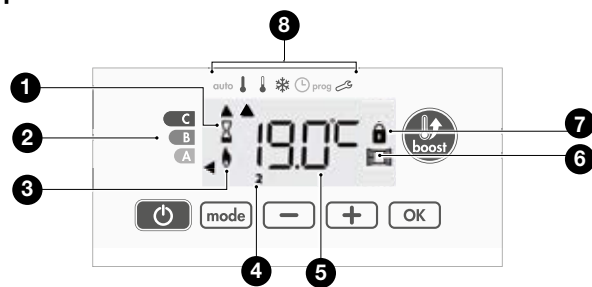

- 1 Lampka/wskaźnik funkcji Boost
- 2 Licznik zużycia energii
- 3 Wskaźnik ogrzewania
- 4 Dni tygodnia (1=poniedziałek ... 7= niedziela)
- 5 Ustawianie temperatury
- 6 Wykrywanie otwartego okna
- 7 Blokada przycisków

8 Tryb pracy:

- auto Tryb Automatyczny
- ! Tryb Komfort
- ! Tryb Eco
- * Tryb Ochrony przed mrozem
- 🕒 Tryb ustawiania daty i godziny
- prog Tryb programowania
- 🔗 Ustawienia

OBSŁUGA

• Opis przycisków

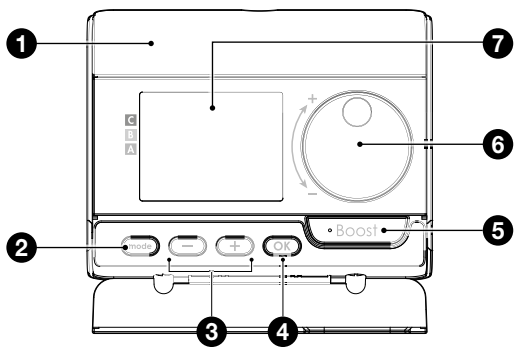

- 1 Komora na baterie
- 2 Wybór trybu pracy
- 3 Przyciski plus i minus – do ustawiania wartości temperatury, godziny, daty i program tygodniowy
- 4 Zapisywanie ustawień
- 5 Przycisk Boost
- 6 Pokrętko do ustawiania temperatury
- 7 Ekran LCD

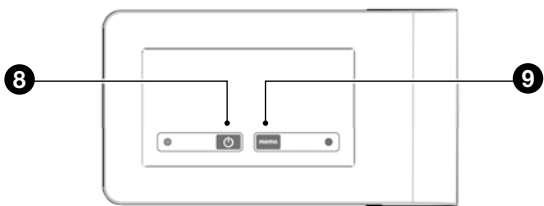

- 8 Włączanie/tryb czuwania
- 9 Blokada przycisków, Wskaźnik transmisji radiowej

• Opis wskaźników

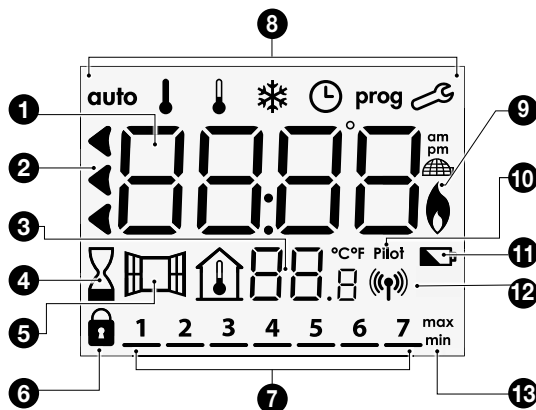



Dni tygodnia (1=poniedziałek ... 7=niedziela)

- 1 Ustawienia / Informacje dot. temperatury
- 2 Zużycie energii
- 3 Zmierzona temperatura w pomieszczeniu
- 4 Wskaźnik funkcji Boost
- 5 Wskaźnik wykrywania otwartego okna
- 6 Blokada przycisków
- 9 Wskaźnik ogrzewania
- 10 Komunikacja kablowa (tylko dla Francji)
- 11 Wskaźnik niskiego stanu baterii
- 12 Wskaźnik transmisji radiowej
- 13 Wskaźnik wartości min/max

8 Tryby pracy:

auto Tryb Automatyczny ↓ Tryb Komfort ↓ Tryb Eco
 * Tryb Ochrony przed mrozem ⌚ Tryb ustawiania daty i godziny **prog** Tryb programowania ⚙ Ustawienia

WŁĄCZANIE/TRYB CZUWANIA

Naciśnij , aby włączyć termostat w trybie Automatycznym. Ponownie naciśnij przycisk  aby przełączyć termostat w tryb czuwania.

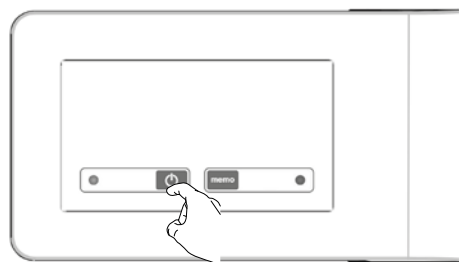
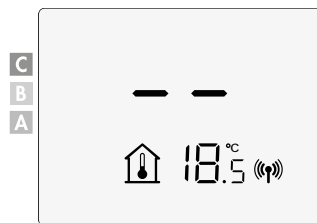
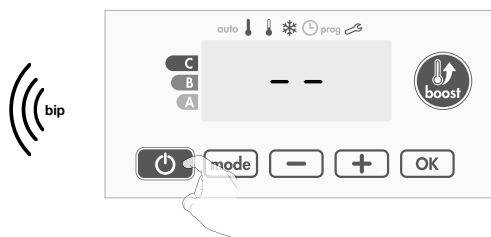
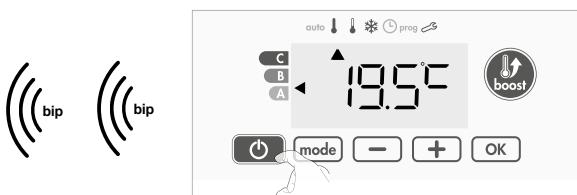

TRYBY PRACY

Naciśnij **mode**, aby wybrać żądany tryb pracy termostatu.



Kolejność trybów pracy:

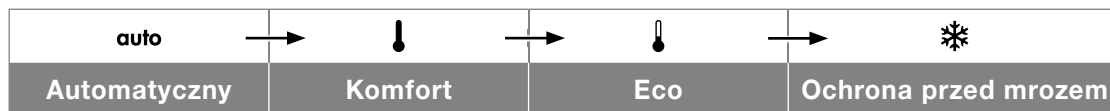

• auto Tryb Automatyczny (trzy sytuacje)

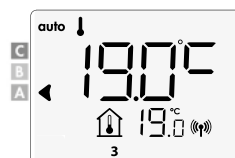
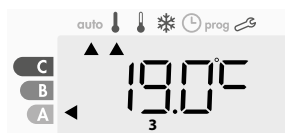

1 Gdy ustawiony jest harmonogram tygodniowy

Jeśli urządzenie zostało zaprogramowane na tydzień, grzejnik będzie się automatycznie przełączał z trybu Komfort na Eco i odwrotnie.

BASIC

W razie wystąpienia przerwy w zasilaniu powyżej 3 godzin, konieczne będzie ponowne ustawienie daty i godziny. Harmonogram tygodniowy pozostanie jednak zapisany w pamięci urządzenia.

2 Sterowanie za pomocą przewodu komunikacyjnego (wykorzystywanie czarnej żyły komunikacyjnej jest możliwe tylko we Francji)

3 Gdy harmonogram tygodniowy nie jest ustawiony

Jeśli urządzenie nie zostało zaprogramowane na tydzień, grzejnik będzie pracował stale w trybie Komfort.

• ↓ Tryb Komfort

W tym trybie termostat pracuje przez 24 godz. na dobę, aby utrzymać ustawioną temperaturę (np. 19°C). Temperaturę dla trybu Komfort ustawia użytkownik.



• ↓ Tryb Eco

Temperatura w trybie Eco jest o 3,5°C niższa niż gdy termostat pracuje w trybie Komfort. Dzięki temu można obniżyć temperaturę bez konieczności jej zmiany w trybie Komfort. Tryb Eco można włączyć na czas krótkich nieobecności w domu (od 2 do 24 godzin) i na noc.

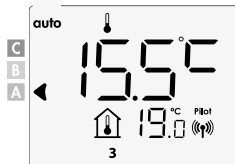

• ❄️ Tryb Ochrony przed mrozem

Tryb ten pozwala chronić dom przed skutkami niskich temperatur (zamarzaniem rur itp.), poprzez utrzymanie w nim przez cały czas temperatury nie niższej niż 7°C. Można ustawić ten tryb na czas dłuższych nieobecności w domu (ponad 5 dni).

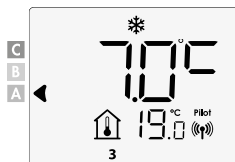

USTAWIANIE TEMPERATURY KOMFORTOWEJ

W trybie Automatycznym i Komfortu można ustawić temperaturę komfortową. Jest ona wstępnie ustawiona na 19°C.

Przy pomocy **-** i **+** można wybrać temperaturę od 7°C do 30°C. Po każdym naciśnięciu wartość jest przestawiana o 0,5°C.

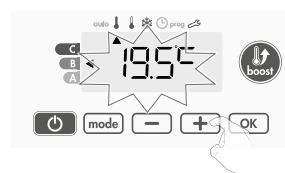

BOOST

Funkcję Boost (maksymalnego nagrzewania) można włączyć w dowolnej chwili, niezależnie od aktualnego trybu pracy (Automatycznego, Komfortu, Eco lub Ochrony przed mrozem).

Pierwsze naciśnięcie = włączenie funkcji Boost

Przez minutę po naciśnięciu można zmienić czas działania funkcji Boost od 0 do maksymalnego dozwolonego czasu trwania tej funkcji za pomocą przycisków \ominus i \oplus .

Wprowadzona zmiana zostanie zapisana i zastosowana przy kolejnym włączeniu funkcji Boost.

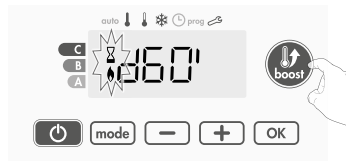

Wskazówka: po minucie można tymczasowo zmienić czas działania funkcji Boost. Zmiana ta zostanie zastosowana tylko jednorazowo, do aktualnej pracy w trybie Boost i nie pojawi się przy kolejnym włączeniu tej funkcji.

Praca w trybie Boost może zostać zakończona, gdy temperatura otoczenia osiągnie maksymalną wartość ustawioną dla funkcji Boost.

Termostat się wyłączy, ale tryb Boost pozostanie aktywny: licznik pozostanie wyświetlony na ekranie. Gdy temperatura spadnie poniżej maksymalnej temperatury ustawionej dla funkcji Boost, znowu rozpocznie pracę do zakończenia odliczania czasu.



Drugie naciśnięcie = wyłączenie funkcji Boost.

Termostat powróci do poprzedniego trybu pracy.

ZUŻYCIE ENERGII

Kursor wyboru wskazuje poziom zużycia energii przy ustawionej temperaturze, gdy jest ustawiony przy jednym z kolorów: czerwonym, pomarańczowym lub zielonym.

C – Czerwony Wyższe zużycie	Temperatura > 22°C
B – Pomarańczowy Średnie zużycie	19°C < Temperatura ≤ 22°C
A – Zielony Niższe zużycie	Temperatura ≤ 19°C

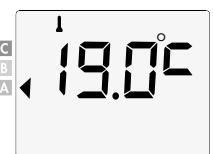
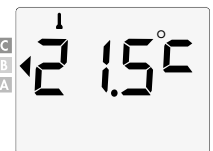

• Wskaźnik szacowanego zużycia energii elektrycznej w kWh

Aby sprawdzić zużycie energii delate, w trybach pracy Automatycznym, Komfort, Eco i Ochrony przed mrozem naciśnij OK . Aby wyjść z ekranu pokazującego zużycie energii: naciśnij dowolny przycisk, a termostat automatycznie powróci do poprzedniego trybu pracy.

• Reset licznika energii

Aby zresetować licznik energii, należy w trybie Automatycznym, Komfort, Eco lub Ochrony przed mrozem wykonać następujące kroki:

- 1- Naciśnij OK .
- 2- Naciśnij równocześnie przyciski \ominus i \oplus i przytrzymaj je przez ponad 5 sekund.
Aby wyjść z opcji resetu licznika energii, naciśnij dowolny przycisk, a urządzenie automatycznie powróci do poprzedniego trybu pracy.

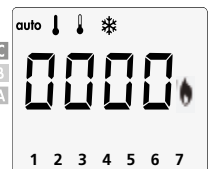
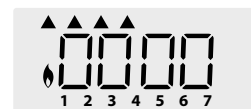

WŁĄCZANIE I WYŁĄCZANIE BLOKADY PRZYCISKÓW

• Blokowanie przycisków

Aby zablokować przyciski, naciśnij i i przytrzymaj je przez 10 sekund. Na wyświetlaczu pojawi się ikona kłódki informująca o zablokowaniu przycisków.

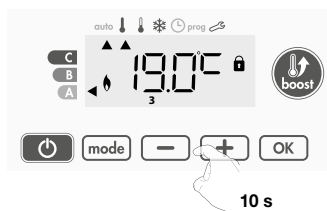

• Odblokowanie przycisków

Aby odblokować przyciski, ponownie naciśnij i i przytrzymaj je przez 10 sekund. Z wyświetlacza zniknie ikona kłódki i przyciski będą odblokowane.

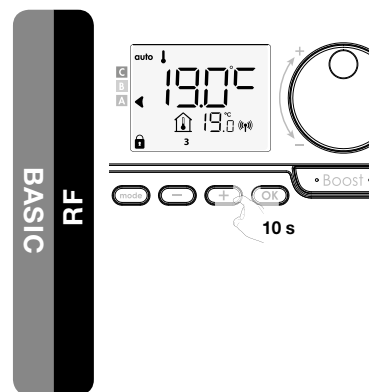

USTAWIANIE GODZINY I DATY

1- Będąc w trybie Automatycznym, Komfort, Eco lub Ochrony przed mrozem naciśnij i przytrzymaj przez 5 sekund przycisk .



2- Cyfry oznaczające godzinę zamigają. Przy pomocy lub ustaw godzinę. Godziny zmieniają się po naciśnięciu i przytrzymaniu lub .

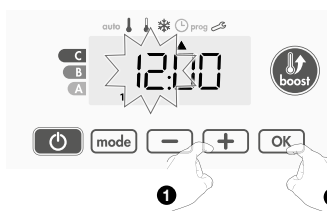

Zapisz godzinę naciskając .

3- Cyfry oznaczające minuty zamigają. Przy pomocy lub ustaw minuty.

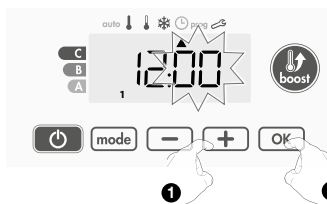

Zapisz godzinę naciskając .

4- Cursor nad liczbą 1 (= poniedziałek) zamiga. Wybierz datę przy pomocy i .

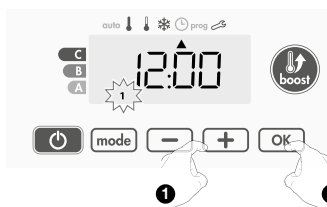

Zapisz datę naciskając .

Poniedziałek	1	Piątek	5
Wtorek	2	Sobota	6
Środa	3	Niedziela	7
Czwartek	4		

5- Aby ustawić harmonogram tygodniowy trybów pracy, naciśnij .

Aby wyjść z trybu ustawień godziny i dnia, naciśnij 3 razy.

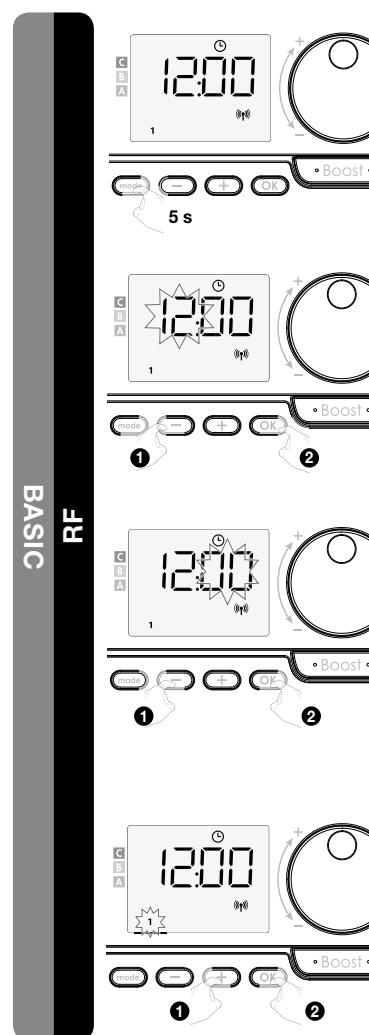

PRZEGLĄD PROGRAMÓW

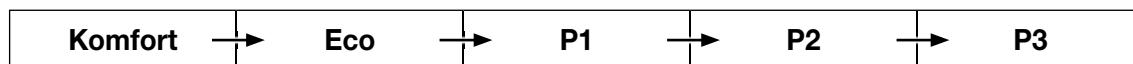

Termostat jest ustawiony domyślnie na pracę w trybie Komfort przez cały tydzień.

- **Komfort:** termostat pracuje w trybie Komfort przez całą dobę, w każdym wybranym dniu.
- **Eco:** termostat pracuje w trybie Eco przez całą dobę
Uwaga: można ustawić parametry dotyczące obniżania temperatury (zobacz ustawienia użytkownika).
- **P1:** termostat będzie działał w trybie Komfort w jednym przedziale czasowym, np. od godz. 6 do 22 (a w trybie Eco od godz. 22 do 6).
- **P2:** termostat będzie działał w trybie Komfort w dwóch przedziałach czasowych, np. od godz. 6 do 9 i od godz. 16 do 22 (a w trybie Eco od godz. 9 do 16 i od godz. 22 do 6).
- **P3:** termostat będzie działał w trybie Komfort w trzech przedziałach czasowych, np. od godz. 6 do 8, od godz. 12 do 14 i od godz. 18 do 23 (a w trybie Eco od godz. 23 do 6, od godz. 8 do 12 i od godz. 14 do 18).

Uwaga! Jeśli ustawione domyślnie godziny w programach P1, P2 i P3 nie odpowiadają użytkownikowi, może je zmienić. Godziny te będą wówczas zastosowane dla wszystkich dni tygodnia, dla których ustawiono program P1, P2 lub P3.

USTAWIANIE PROGRAMU NA TYDZIEŃ

1- Będąc w trybie Automatycznym, Komfort, Eco lub Ochrony przed mrozem naciśnij i przytrzymaj przez 5 sekund przycisk **mode**.

Gdy kursor znajdzie się pod ikoną ustawiania godziny , ponownie naciśnij krótko **mode**.

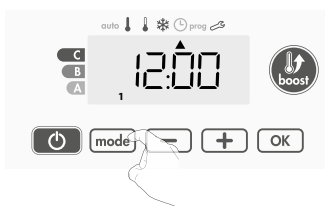

2- Naciskając **+** lub **-** ustaw program dla poszczególnych dni tygodnia.

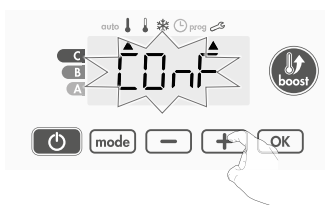

3- Przy pomocy **+** lub **-** wybierz żądany program. W razie potrzeby można zmienić ustawione domyślnie godziny. Aby to zrobić, naciśnij i przez co najmniej 5 sekund przytrzymaj **OK**.

Jeśli użytkownikowi odpowiadają godziny ustawione domyślnie: naciśnij **OK**, aby wprowadzić ustawienia dla kolejnego dnia (przejdź do kroku 4).

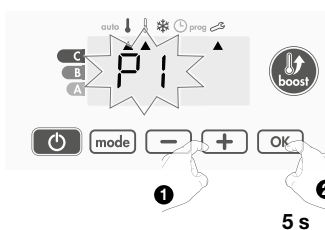

3.1- Gdy godzina rozpoczęcia miga można ją zmienić za pomocą **+** lub **-**.

Każde naciśnięcie powoduje przestawienie godziny o 30 min.

Zapisz ustawienie naciskając **OK**.

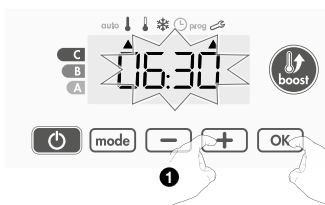

3.2- Gdy godzina zakończenia miga można ją zmienić za pomocą **+** lub **-**.

Każde naciśnięcie powoduje przestawienie godziny o 30 min.

Zapisz ustawienie naciskając **OK**.

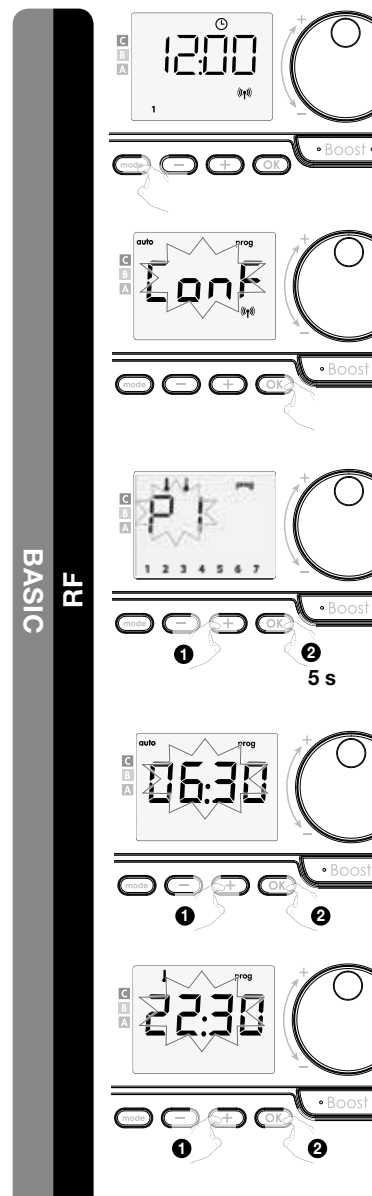
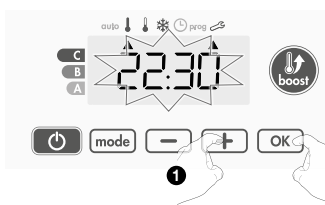

- 4- Zacznie migać drugi dzień (wtorek).
Powtórz opisane wcześniej kroki dla każdego z dni tygodnia.

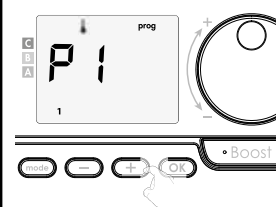
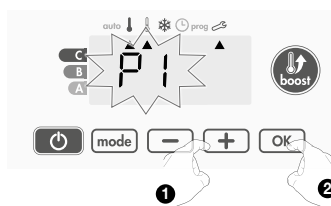

- 5- Po ustawieniu programu dla każdego dnia tygodnia, potwierdź swój wybór naciskając **OK**. Dni tygodnia będą się kolejno pojawiać na wyświetlaczu wraz z programami, które dla nich ustawiono. Dwa razy naciśnij **mode**, aby wyjść z trybu programowania i powrócić do trybu Automatycznego.
Gdy przez kilka minut nie zostanie naciśnięty żaden przycisk, termostat sam powróci do trybu Automatycznego.

PRZEGLĄDANIE HARMONOGRAMU TYGODNIOWEGO

Będąc w trybie Automatycznym, Komfort, Eco lub Ochrony przed mrozem naciśnij **mode**, i przytrzymaj przez 5 sekund przycisk. Po dwukrotnym naciśnięciu **mode** na wyświetlaczu pojawią się programy dla każdego dnia tygodnia (Komfort, Eco, P1, P2 lub P3). Aby wyjść z trybu przeglądu programowania, 2 razy naciśnij **mode**.

TYMCZASOWE ODSTĘPSTWA OD HARMONOGRAMU TYGODNIOWEGO

Ta funkcja pozwala na tymczasową zmianę ustawień temperatury do czasu następczej zaprogramowanej zmiany temperatury lub rozpoczęcia się następczej doby.

Na przykład:

- 1- Urządzenie pracuje w trybie Automatycznym, a aktualny program to Eco 15,5°C.
- 2- Za pomocą **-** lub **+** można tymczasowo zmienić żadaną temperaturę, przestawiając ją np. na 18°C.
- 3- Zmiana ta zostanie automatycznie anulowana przy następczej zmianie programu lub w chwili rozpoczęcia się następczej doby.

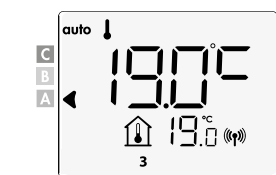
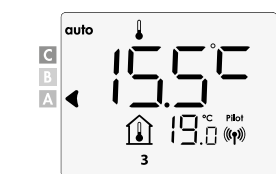
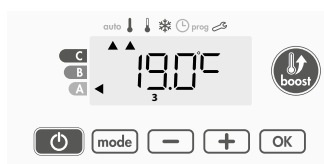
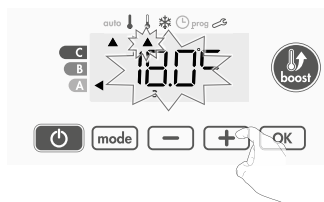
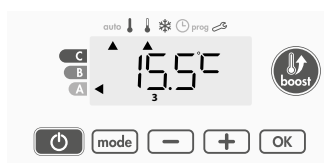

WYKRYWANIE OTWARTEGO OKNA

Czujnik wykrywania otwartego okna reaguje na zmiany w temperaturze. Termostat zareaguje na otwarcie okna w oparciu o różne parametry: ustawienia temperatury, wzrost i spadek temperatury w pomieszczeniu, temperaturę panującą na zewnątrz, umiejscowienie termostatu itp. Jeśli urządzenie jest zamontowane blisko drzwi wejściowych, funkcję wykrywania może zakłócić podmuch powietrza podczas otwierania drzwi. W takiej sytuacji zaleca się wyłączenie trybu wykrywania otwartego okna (zobacz ustawienia dla instalatorów).

Gdy termostat przełącza się na cykl niższej temperatury z powodu otwartego okna, na wyświetlaczu pojawia się licznik trybu Ochrony przed mrozem ukazujący czas trwania cyklu. Licznik automatycznie resetuje się na zero przy kolejnym uruchomieniu trybu Ochrony przed mrozem. Pracę w trybie Ochrony przed mrozem można zatrzymać, naciskając dowolny przycisk.

Uwaga! W razie wykrycia wzrostu temperatury w otoczeniu, urządzenie może samo powrócić do poprzedniego trybu pracy.

USTAWIENIA UŻYTKOWNIKA

DOSTĘP DO USTAWIEŃ

Będąc w trybie Automatycznym, Komfort, Eco lub Ochrony przed mrozem:

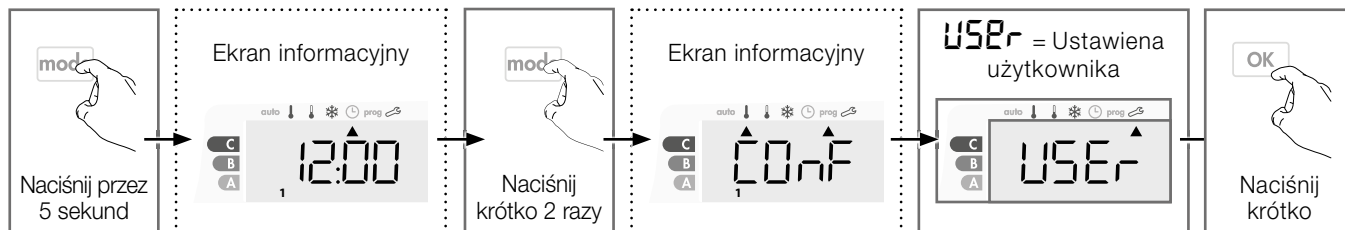

Kolejność ustawień:

Oświetlenie tła → Obniżenie temperatury trybu Eco → Temperatura trybu Ochrony przed mrozem → Górna i dolna granica temperatury trybu Komfort → Maksymalny czas trybu Boost → Maksymalna temperatura trybu Boost → Jednostka temperatury → Przywrócenie ustawień fabrycznych

OŚWIETLENIE TŁA

1- Dostępne są trzy opcje:

L1 = oświetlenie tła z timerem: wyświetlacz zaświeci się po naciśnięciu dowolnego przycisku

L2 = stałe oświetlenie tła: wyświetlacz świeci się przez cały czas.

L3 = tak samo, jak w przypadku opcji L1

Opcja L3 jest ustawiona domyślnie.

Aby wybrać żądaną opcję oświetlenia tła, naciśnij przycisk lub .

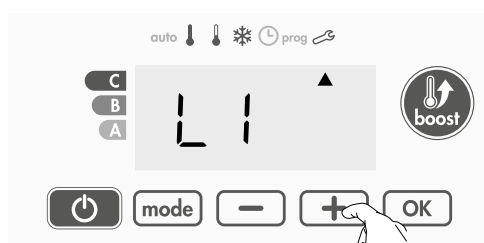

2- Aby potwierdzić wybór i przejść do następnego ustawienia naciśnij .

Aby potwierdzić wybór i wyjść z trybu ustawień, 2 razy naciśnij .

OBNIŻENIE TEMPERATURY TRYBU ECO

Wartość obniżenia jest ustawiona fabrycznie na 3,5°C w stosunku do ustawionej temperatury dla trybu Komfort. Można zmienić wartość obniżenia w przedziale od -1°C do -8°C, w kroku co 0,5°C.

Uwaga: bez względu na ustawioną wartość obniżenia, temperatura trybu Eco nie może przekroczyć 19°C.

1- Naciskając lub ustaw żądaną wartość obniżenia temperatury.

2- Aby potwierdzić wybór i przejść do następnego ustawienia, naciśnij .

Aby potwierdzić wybór i wyjść z trybu ustawień, 2 razy naciśnij .

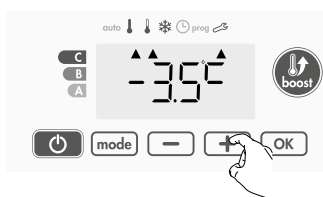

TEMPERATURA TRYBU OCHRONY PRZED MROZEM

Temperatura ta jest ustawiona fabrycznie na 7°C. Można zmienić jej wartość w przedziale od 5°C do 15°C, w kroku co 0,5°C.

1- Naciskając lub ustaw żądaną wartość temperatury.

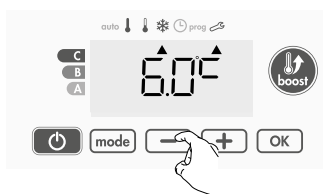

2- Aby potwierdzić wybór i przejść do następnego ustawienia, naciśnij . Aby potwierdzić wybór i wyjść z trybu ustawień, 2 razy naciśnij .





GÓRNA I DOLNA GRANICA TEMPERATURY TRYBU KOMFORT

• Dolna granica

Najniższa temperatura dla tego trybu jest ustawiona fabrycznie na 7°C. Można ją zmienić na wartość z przedziału od 7°C do 15°C, zwiększając ją lub zmniejszając o 1°C.

- 1- Aby ustawić minimalną temperaturę, użyj  lub  i potwierdź wybór naciskając .

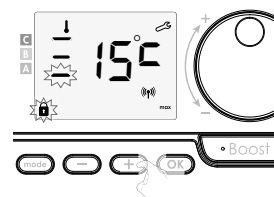
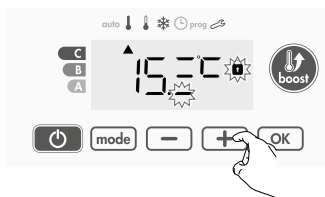

Jeśli nie chcesz wprowadzać zmian, naciśnij . Termostat automatycznie zaproponuje przejście do ustawień maksymalnej temperatury.

Aby potwierdzić wybór i wyjść z trybu ustawień, 2 razy naciśnij .



• Górna granica

Najwyższa temperatura dla tego trybu jest ustawiona fabrycznie na 30°C. Można ją zmienić na wartość z przedziału od 19°C do 30°C, w kroku co 1°C.

- 2- Aby zmienić ustawioną maksymalną temperaturę, użyj  lub .

Naciśnij , aby potwierdzić wybór i wprowadzić następane ustawienia.

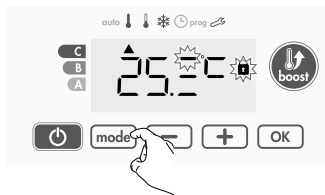

Aby potwierdzić wybór i wyjść z trybu ustawień, 2 razy naciśnij .





MAKSYMALNY CZAS TRYBU BOOST

Maksymalny czas pracy trybu Boost jest ustawiony fabrycznie na 60 minut. Można go zmienić na wartość w przedziale od 30 do 90 minut, w kroku co 30 minut.

- 1- Na wyświetlaczu pojawia się symbol Boost i wskaźnik ogrzewania. Czas pracy ustawiony na 60 minut miga.

- 2- Naciskając  lub  na nowo ustaw żądany czas pracy.

- 3- Aby potwierdzić wybór i przejść do następnego ustawienia, naciśnij .

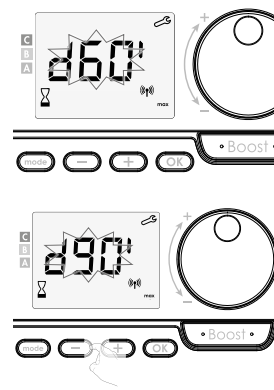
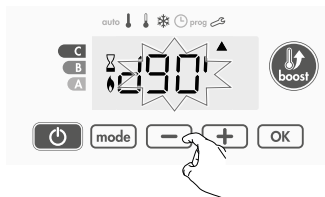
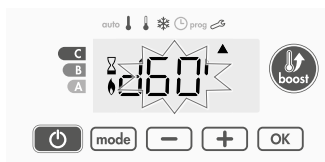

Aby potwierdzić wybór i wyjść z trybu ustawień, 2 razy naciśnij .





MAKSYMALNA TEMPERATURA TRYBU BOOST

Tryb pracy Boost wyłącza się, gdy osiągnięta zostanie maksymalna temperatura ustawiona dla funkcji Boost.

Najwyższa temperatura dla tego trybu jest ustawiona fabrycznie na 35°C. Można ją zmienić na wartość z przedziału od 25°C do 39°C, w kroku co 1°C.

- 1- Na wyświetlaczu pojawia się symbol Boost i wskaźnik ogrzewania. Maksymalna temperatura miga.
- 2- Można ustawić maksymalną temperaturę trybu Boost naciskając  lub , w kroku co 1°C, do maksymalnie 39°C.

- 3- Aby potwierdzić wybór i przejść do następnego ustawienia, naciśnij .

Aby potwierdzić wybór i wyjść z trybu ustawień, 2 razy naciśnij .

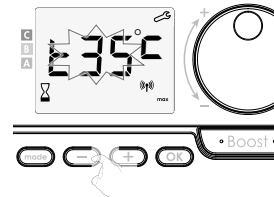
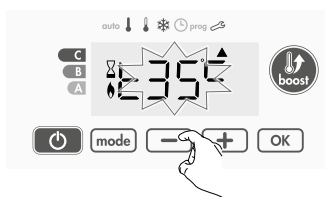

JEDNOSTKA TEMPERATURY

Ustawioną fabrycznie jednostką temperatury są stopnie Celsjusza.

- 1- Przy pomocy lub zmień jednostkę temperatury.
- 2- Aby potwierdzić wybór i automatycznie przejść do następnego ustawienia, naciśnij .

Aby potwierdzić wybór i wyjść z trybu ustawień, 2 razy naciśnij .

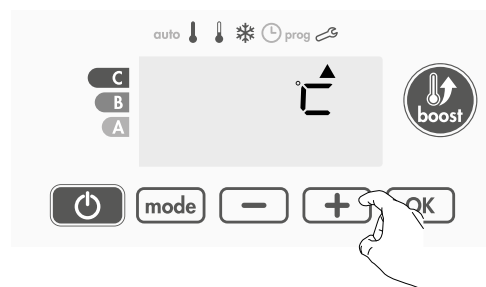

PRZYWRÓCENIE USTAWIENÍ FABRYCZNYCH

- 1- Przez 1 sekundę pojawi się napis **rest**

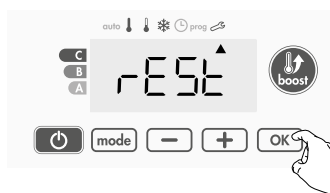

- 2- Miga napis **no** (Nie). Użyj lub aby wybrać **yes** (Tak).

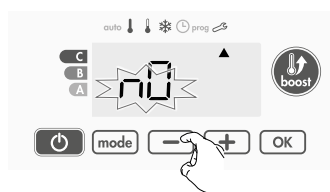

- 3- Naciśnij i przytrzymaj przez 5 sekund .
Ustawienia zostaną zresetowane i termostat sam powróci do Automatemycznego trybu pracy.

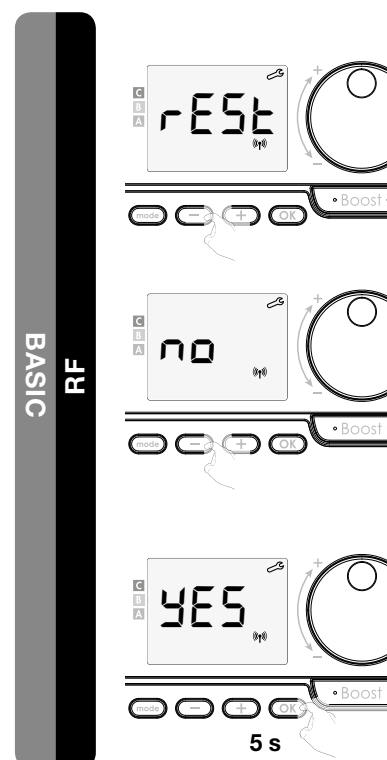
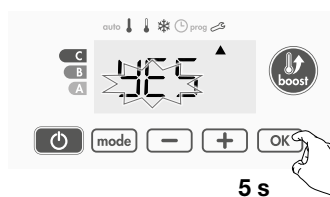

Ustawienia ogólne

Temperatura dla trybu Komfort	19°C
Maksymalny czas trybu Boost	60 min.
Blokada przycisków	Wyłączona

Ustawienia użytkownika

Oświetlenie tła	L3	BASIC
Obniżenie temp. w trybie Eco	-3,5°C	
Temp. trybu Ochrony przed mrozem	7°C	
Dolna granica temperatury trybu Komfort	7°C	
Górna granica temperatury trybu Komfort	30°C	
Maksymalny czas trybu Boost	60 min.	
Maksymalna temperatura trybu Boost	35°C	
Jednostka temperatury	°C	

Aby wyjść z trybu ustawień, 2 razy naciśnij .

USTAWIENIA DLA INSTALATORÓW

DOSTĘP DO USTAWIEŃ

Z trybu Automatycznego, Komfortu, Eco lub Ochrony przed mrozem:

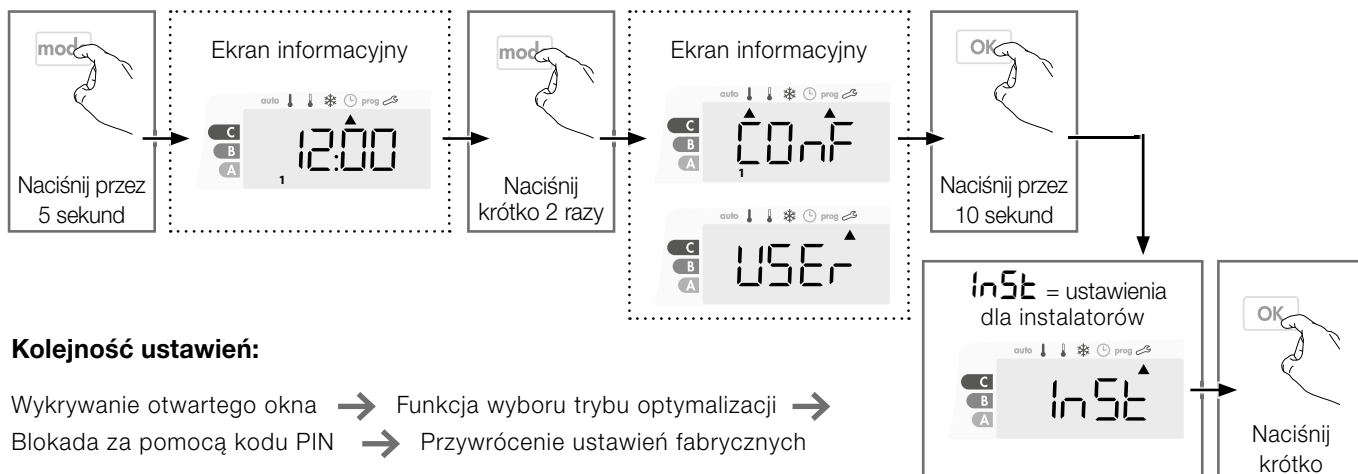

Kolejność ustawień:

- Wykrywanie otwartego okna → Funkcja wyboru trybu optymalizacji →
- Blokada za pomocą kodu PIN → Przywrócenie ustawień fabrycznych

WYKRYWANIE OTWARTEGO OKNA

- 1- Funkcja wykrywania otwartego okna jest włączona standardowo.
- 2- Użyj **-** lub **+**.
On = wykrywanie otwartego okna jest włączone.
OFF = wykrywanie otwartego okna jest wyłączone.
- 3- Naciśnij **OK**, aby potwierdzić wybór i przejść do kolejnych ustawień.
 Aby potwierdzić wybór i wyjść z trybu ustawień, 3 razy naciśnij **mode**.

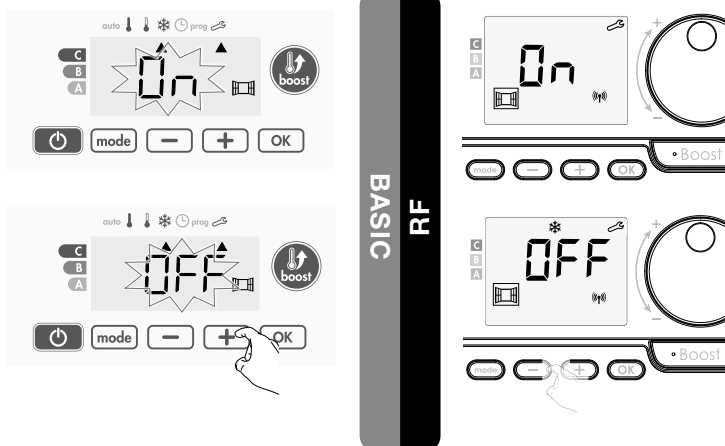

FUNKCJA WYBORU TRYBU OPTIMALIZACJI

- W trybie **OPTI ECO (energooszczędny)** termostat określa, jak zapewnić maksymalną oszczędność energii podczas zaprogramowanych okresów podgrzewania i obniżania temperatury. Pozwala na niewielkie obniżenie poziomu temperatury na początku i przy końcu okresu utrzymania komfortowej temperatury, aby uzyskać maksymalną oszczędność energii.
- W trybie **OPTI COMFORT (wygodna praca)** termostat określa, jak zapewnić maksymalny komfort podczas zaprogramowanych okresów podgrzewania i obniżania temperatury. Najważniejsze jest przy tym wcześniejsze przewidzenie i utrzymanie komfortowej temperatury w okresach wykrytej obecności w domu.

Funkcja OPTI COMFORT jest włączona standardowo. Na wyświetlaczu pojawia się na chwilę komunikat OP!:/, który zmienia się następnie w ustawiony tryb: ConF, ECO lub OFF.

ConF = włączona funkcja optymalizacji dla trybu **OPTI COMFORT**, najważniejszy jest komfort.

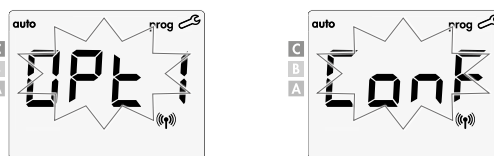

- 1- Naciśnij **-** lub **+**.

- ConF** = funkcja optymalizacji aktywowana dla trybu OPTI COMFORT, priorytet dla wydajności komfortu.
- ECO** = funkcja optymalizacji aktywowana dla trybu OPTI ECO, priorytet dla efektywności energetycznej.
- OFF** = funkcja optymalizacji jest wyłączona.

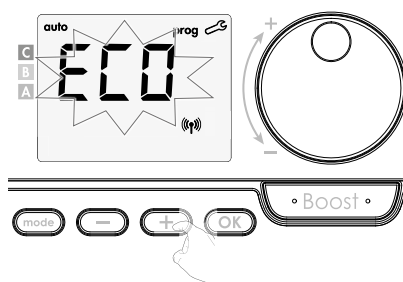

- 2- Naciśnij **OK**, aby zapisać wybór i przejść do kolejnych ustawień.
 Aby wyjść z trybu ustawień dla instalatorów, 3 razy naciśnij **mode**.

BLOKADA ZA POMOCĄ KODU PIN

• Informacje

Można samodzielnie ustawić 4-cyfrowy kod PIN, który po jego aktywacji uniemożliwi dostęp do następujących funkcji:

- Wybór trybu Komfort: dostępne będą tylko tryby Automatyczny, Eco i Ochrony przed mrozem.
- Ustawianie temperatury dla trybów Komfort, Eco i Ochrony przed mrozem.
- Zmiana harmonogramu tygodniowego.
- Ustawienie funkcji wykrywania otwartego okna.

Używając zabezpieczenia kodem PIN po raz pierwszy, należy wykonać następujące kroki:

- 1- Inicjalizacja użycia kodu PIN – wprowadź fabrycznie ustawiony kod PIN (0000), aby móc skorzystać z funkcji blokady.
- 2- Aktywacja kodu PIN do zablokowania ustawień, które będą zabezpieczone kodem PIN.
- 3- Ustawienie własnego kodu PIN – zastąpienie kodu (0000) własnym kodem złożonym z czterech cyfr.

• Użycie ustawionego fabrycznie kodu PIN = '0000'

Standardowo kod PIN jest wyłączony = OFF

- 1- Kod PIN jest ustawiony fabrycznie na 0000.

Za pomocą **-** lub **+** wybierz cyfrę 0.

Gdy cyfra zacznie migać, zatwierdź ją naciskając **OK**.

- 2- Jako pozostałe trzy cyfry wybierz również 0, naciskając **OK**.

Gdy pojawi się 0000, ponownie naciśnij **OK**, aby potwierdzić wybór.

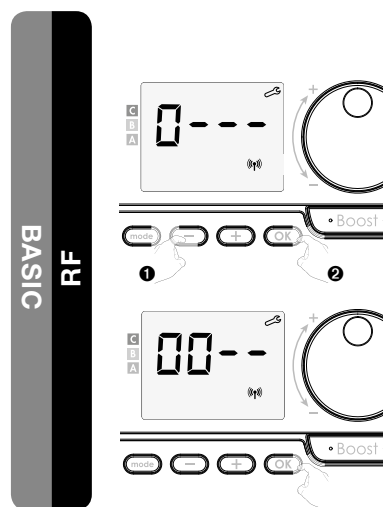
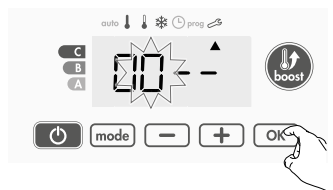
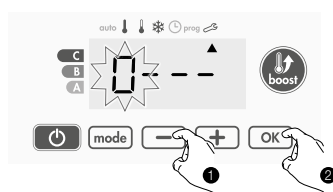

Użycie kodu PIN zostało zainicjalizowane. Termostat przejdzie teraz automatycznie do następnego kroku, czyli aktywacji kodu PIN.

• Aktywacja/wyłączenie kodu PIN

- 1- Na wyświetlaczu pojawi się OFF.

Przy pomocy **-** lub **+** **aktywuj kod PIN**.

On = kod PIN aktywowany

OFF = kod PIN wyłączony

- 2- Naciśnij **OK**, aby potwierdzić wybór i wprowadzić następane ustawienia.

Kod PIN został aktywowany.

Nie można teraz wprowadzić żadnych ustawień z wymienionych w punkcie „Informacje”.

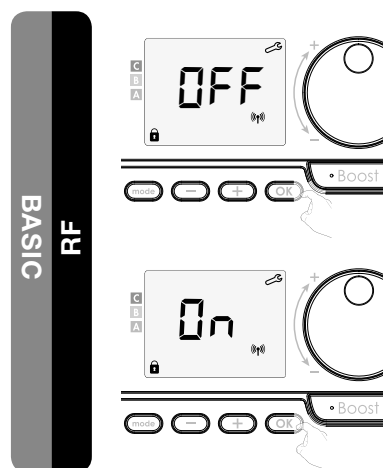
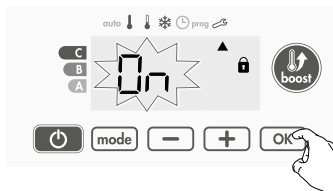
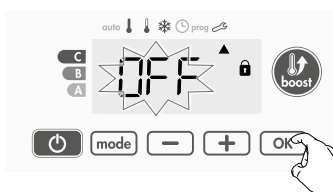

• Ustawienie własnego kodu PIN

- 1- Gdy wyświetli się **On**, naciśnij i przez co najmniej 5 sekund przytrzymaj **OK**.

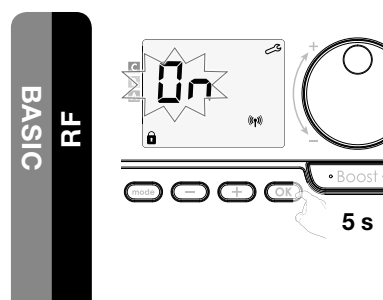
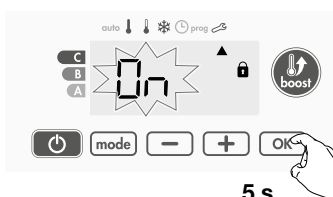

- 2- Pojawi się kod 0000. Pierwsza cyfra zacznie migać.
 Za pomocą **-** lub **+** wybierz żadaną cyfrę i naciśnij **OK**, aby potwierdzić.
 Tak samo wybierz trzy pozostałe cyfry.

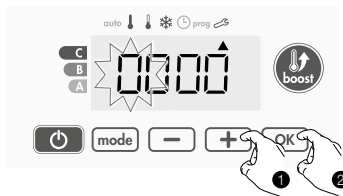

- 3- Naciśnij **OK**, aby potwierdzić.
 Nowy kod PIN został zapisany.

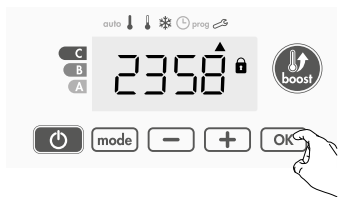

- 4- Ponownie naciśnij **OK**, aby wyjść z ustawień kodu PIN i powrócić do ekranu początkowego ustawień dla instalatorów.
 Aby wyjść z trybu ustawień, 2 razy naciśnij **mode**.



PRZYWRÓCENIE USTAWIEŃ FABRYCZNYCH

Gdy zabezpieczenie przy pomocy kodu PIN jest wyłączone, można przywrócić ustawienia użytkownika i instalatora do ich wartości ustawionych fabrycznie.

- 1- Pojawi się napis **rest**.



- 2- Miga napis **no** (Nie).

Użyj **-** lub **+**, aby wybrać **yes** (Tak).

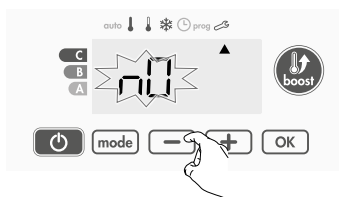

- 3- Naciśnij i przytrzymaj przez 5 sekund **OK**.

Ustawienia zostaną zresetowane i termostat automatycznie powróci do Automatemycznego trybu pracy.

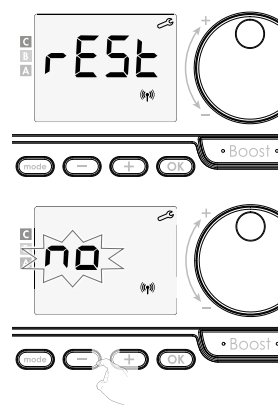

Ustawienia ogólne

Temperatura dla trybu Komfort	19°C
Maksymalny czas trybu Boost	60 min.
Blokada przycisków	Wyłączona

Ustawienia użytkownika

Oświetlenie tła	L3	BASIC
Obniżenie temp. w trybie Eco	-3,5°C	
Temp. trybu Ochrony przed mrozem	7°C	
Dolna granica temperatury trybu Komfort	7°C	
Górna granica temperatury trybu Komfort	30°C	
Maksymalny czas trybu Boost	60 min.	
Maksymalna temperatura trybu Boost	35°C	
Jednostka temperatury	°C	

Ustawienia dla instalatorów

Wykrywanie otwartego okna	Włączone
Funkcja wyboru trybu optymalizacji	Opti comfort RF
Blokada za pomocą kodu PIN	Włączona
Kod PIN	0000

Aby wyjść z trybu ustawień, 3 razy naciśnij **mode**.

ZAAWANSOWANE USTAWIENIA DLA INSTALATORÓW

DOSTĘP DO USTAWIEŃ

Z trybu Automatycznego, Komfortu, Eco lub Ochrony przed mrozem:

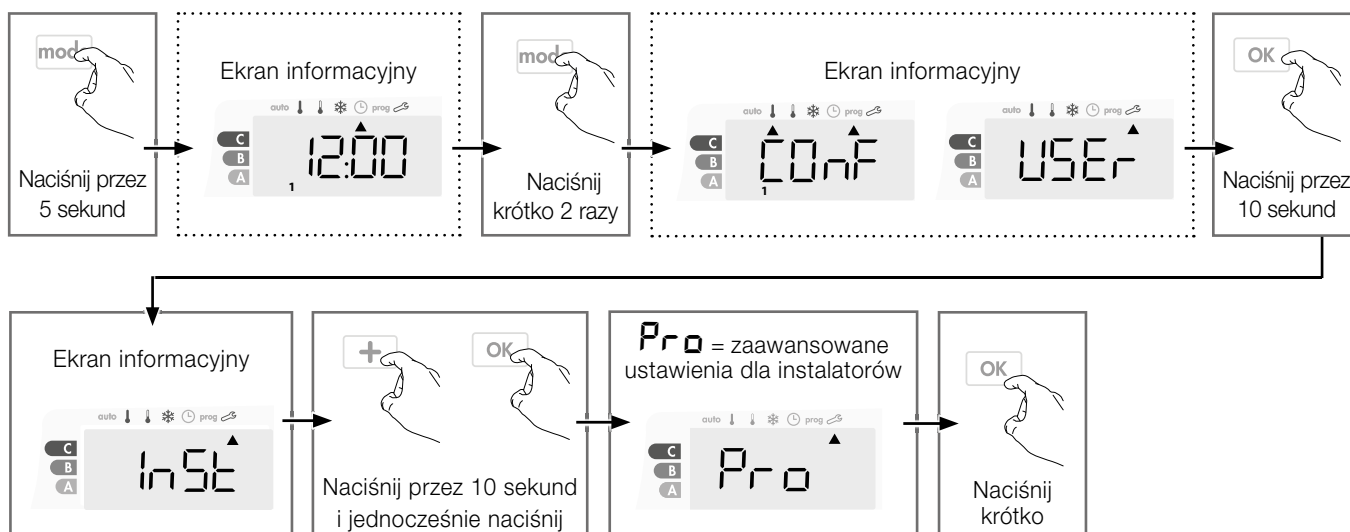

Kolejność ustawień:

Kalibracja czujnika temperatury → Moc grzejnika → Przywrócenie ustawień fabrycznych

KALIBRACJA CZUJNIKA TEMPERATURY

• Informacje

! Niższe czynności mogą wykonywać wyłącznie zawodowi instalatorzy. Nieprawidłowo wprowadzone zmiany mogą doprowadzić do awarii termostatu.

Poprzez wykonanie kalibracji temperaturę mierzoną przez czujnik temperatury otoczenia można zmienić w kroku co 0,1°C, aby skompensować odstępstwo wielkości w zakresie od +5°C do -5°C.

Kalibrację można wykonać dla każdego powiązanego termostatu. Zależnie od liczby termostatów należy zacząć od ustawień kalibracji dla pierwszego termostatu, a następnie drugiego itd. Numer termostatu jest podany podczas ustawiania kalibracji na ekranie.



• Kalibracja

1- Gdy odstępstwo od temperatury pomieszczenia jest ujemne, np.:

Ustawiona temperatura (jaką chcemy mieć) = 20°C.

Temperatura otoczenia (odczytana na sprawnym termometrze) = 18°C.

Zmierzone odstępstwo = -2°C.

! Zaleca się przeprowadzenie kalibracji dopiero w 4 godziny po wprowadzeniu zmiany do ustawionej temperatury, aby mieć pewność, że temperatura otoczenia jest ustabilizowana.

Aby wprowadzić poprawkę, należy wykonać następujące kroki:

Temperatura mierzona przez czujnik = 24°C

Obniż wartość temperatury mierzonej przez czujnik temperatury otoczenia o 2°C naciskając **-**.

Aby potwierdzić zmienioną wartość naciśnij **OK**.

Aby wyjść z trybu ustawień, 3 razy naciśnij **mode**.



2- Gdy odstępstwo od temperatury pomieszczenia jest dodatnie, np.

Ustawiona temperatura (jaką chcemy mieć) = 19°C.

Temperatura otoczenia (odczytana na sprawnym termometrze) = 21°C.

Zmierzone odstępstwo = +2°C.

Aby wprowadzić poprawkę, należy wykonać następujące kroki:

Temperatura mierzona przez czujnik = 21°C

Zwiększ wartość temperatury mierzonej przez czujnik temperatury otoczenia o 2°C naciskając **+**.

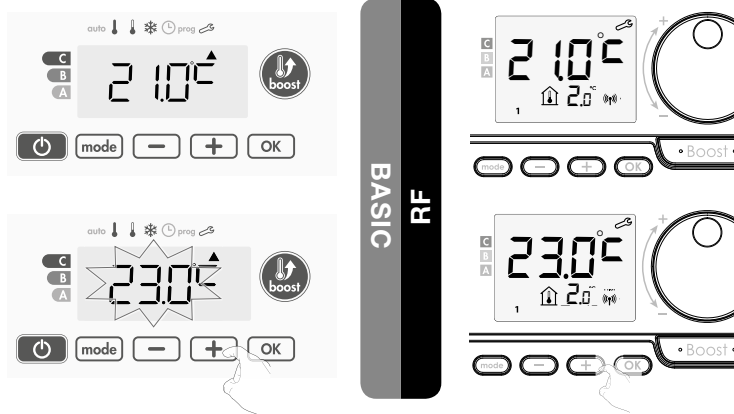

Aby potwierdzić zmienioną wartość naciśnij **OK**. Aby wyjść z trybu ustawień, 3 razy naciśnij **mode**.

• Reset do zera kalibracji czujnika

- 1- Gdy pojawi się temperatura zmierzona przez czujnik, naciśnij **-** lub **+** przez co najmniej 3 sekundy.
- 2- Aby zapisać i przejść automatycznie do następnego ustawienia, naciśnij **OK**.
Aby wyjść z ustawień, naciśnij **mode** 3 razy.

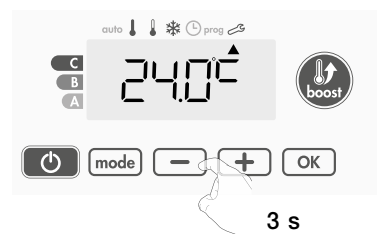

MOC GRZEJNIKA

Aby zagwarantować sprawne działanie grzejnika i móc poprawnie oszacować zużycie energii, niezbędne jest ustawienie mocy grzejnika.

BASIC: Ustawienia tego należy dokonać przy pierwszym uruchomieniu.

RF: to ustawienie jest automatycznie omawiane podczas połączenia RF.

- 1- Wybierz żadaną moc grzejnika za pomocą **+** lub **-**.
- 2- Naciśnij **OK**, aby zapisać wybór i automatycznie przejść do kolejnych ustawień.
Aby wyjść z trybu ustawień, 3 razy naciśnij **mode**.

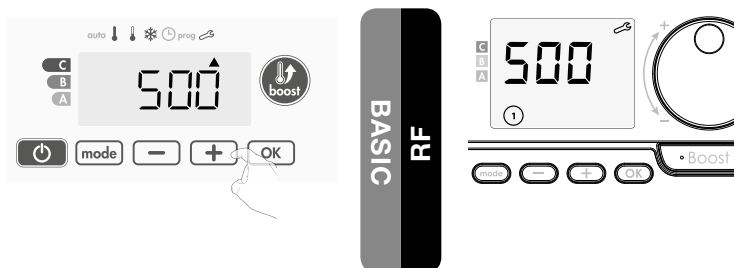

PRZYWRÓCENIE USTAWIENÍ FABRYCZNYCH

Gdy zabezpieczenie przy pomocy kodu PIN jest wyłączone, można przywrócić ustawienia użytkownika, instalatora i zaawansowane ustawienia dla instalatora do wartości ustawionych fabrycznie:

- 1- Na ekranie pojawi się napis **RESET**.

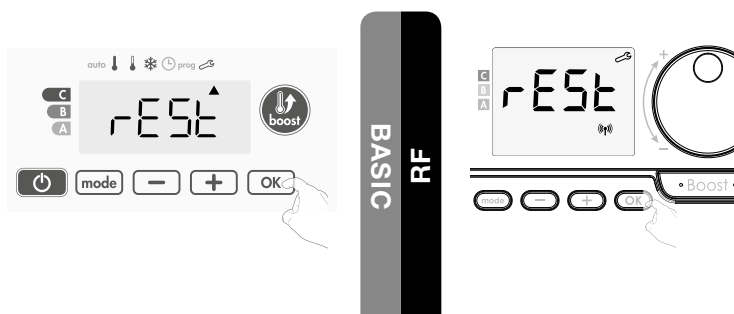

- 2- Wyświetli się napis **no** (Nie).
Użyj **-** lub **+** aby wybrać **YES** (Tak).

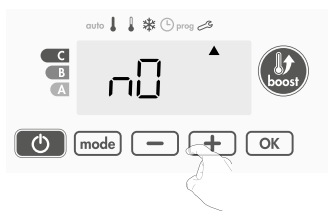

- 3- Naciśnij i przytrzymaj przez 5 sekund **OK**.
Ustawienia zostaną zresetowane i termostat sam powróci do Automatycznego trybu pracy.

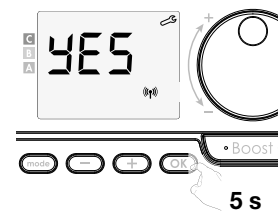
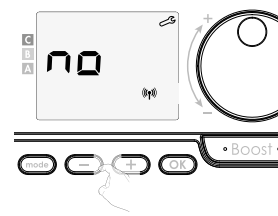
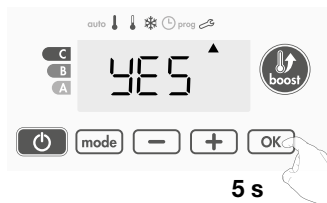

Ustawienia ogólne

Temperatura dla trybu Komfort	19°C
Maksymalny czas trybu Boost	60 min.
Blokada przycisków	Wyłączona

Ustawienia użytkownika

Oświetlenie tła	L3	BASIC
Obniżenie temp. w trybie Eco	-3,5°C	
Temp. trybu Ochrony przed mrozem	7°C	
Dolna granica temperatury trybu Komfort	7°C	
Górna granica temperatury trybu Komfort	30°C	
Maksymalny czas trybu Boost	60 min.	
Maksymalna temperatura trybu Boost	35°C	
Jednostka temperatury	°C	

Ustawienia dla instalatorów

Wykrywanie otwartego okna	Włączone
Funkcja wyboru trybu optymalizacji	Opti comfort RF
Blokada za pomocą kodu PIN	Włączona
Kod PIN	0000

Zaawansowane ustawienia dla instalatorów

Kalibracja czujnika temperatury	0,0
Moc grzejnika	500W

Aby wyjść z trybu ustawień, 3 razy naciśnij **mode**.

VASCOGROUP



DR017099

Kruishoefstraat 50
B-3650 Dilsen
T. +32 (0)89 79 04 11
F. +32 (0)89 79 05 00
info@vasco.be
www.vasco.eu

90DR017099.C