

RITMO

GRZEJNIKI
DEKORACYJNE



VASCOGROUP



jest kompleksowym dostawcą systemów ogrzewania i wentylacji działającym na rynku europejskim, ale także na odległych rynkach eksportowych takich jak Japonia, USA, Chiny i Nowa Zelandia. Marki należące do Vasco Group to Vasco, Brugman i Superia.

Vasco to wiodący producent grzejników dekoracyjnych, systemów wentylacyjnych, ogrzewania podłogowego oraz klimakonwektorów, a także lider w sprzedaży grzejników łazienkowych. Brugman i Superia są symbolami jakości w branży grzejników panelowych i należą do ścisłej czołówki w swoim segmencie. Vasco Group proponuje rozwiązania zapewniające komfort cieplny pomieszczeń, bazując na indywidualnych potrzebach klienta końcowego. Za sprawą poszukiwań materiałów alternatywnych, innowacyjnego designu i unowocześnionych procesów produkcji, firma Vasco zdobyła już wiele międzynarodowych nagród za design.

Główna siedziba firmy Vasco Group usytuowana jest w miejscowości Dilsen w Belgii. Zakłady produkcyjne znajdują się w Dilsen (Belgia), Tubbergen (Holandia) i Legnicy (Polska). Firma Vasco Group zatrudnia około 600 pracowników i stanowi część szwajcarskiej Grupy Arbonia.

ARBONIA 

www.arbonia.com



RITMO

KOMFORT OGRZEWANIA W STYLU RETRO

Ponadczasowa forma grzejnika kolumnowego

Ritmo to dla wielbicieli designu wyjątkowa zaleta.

Projektanci firmy Vasco wiedzą, że dekoracyjny

design i komfort ogrzewania można zamknąć

w pięknym, klasycznym kształcie.

Grzejniki dekoracyjne w stylu retro gwarantują

optymalny klimat Twojego wnętrza.

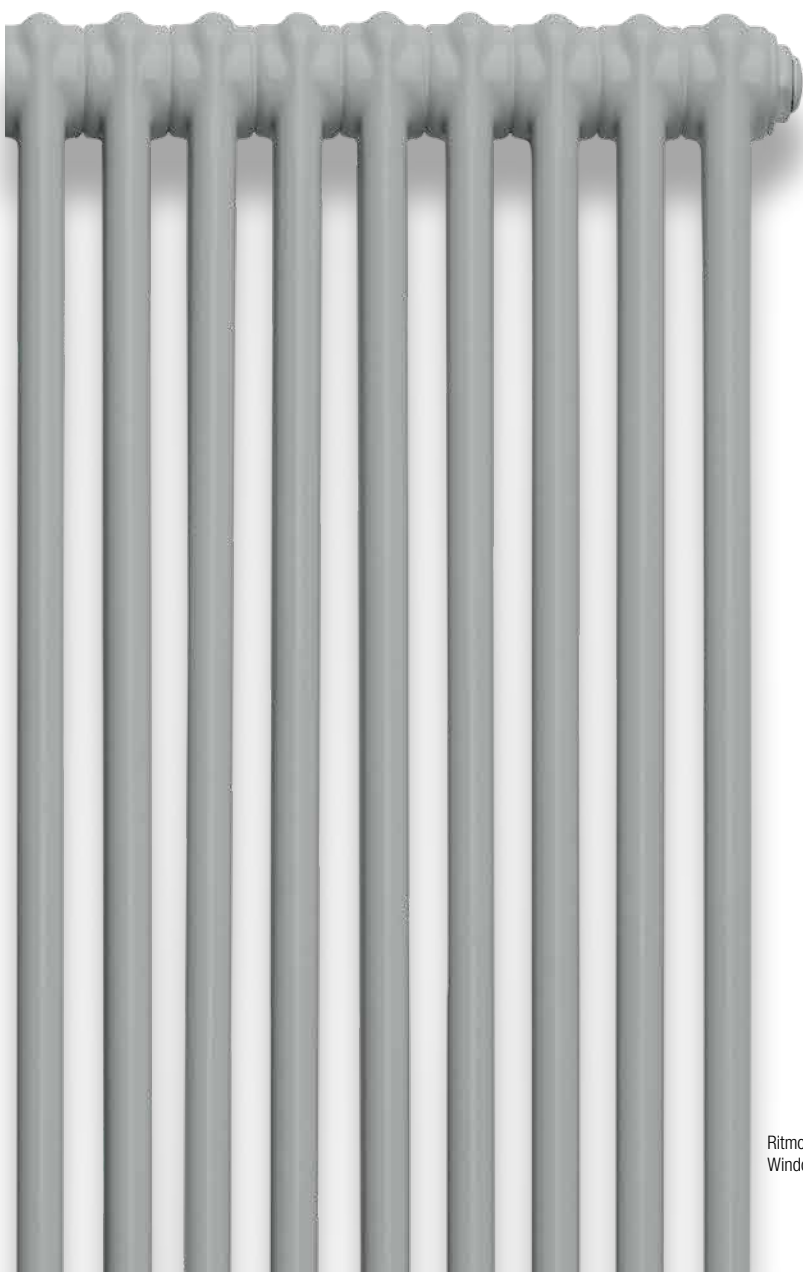

Ritmo pionowy
Window Grey RAL 7040

 **VASCO**



RITMO PIONOWY

OD KLASYCZNYCH
KAMIENIC
DO
NOWOCZESNYCH
LOFTÓW

Wysokie, pionowe grzejniki kolumnowe idealnie nadają się do dużych i otwartych pomieszczeń. Od klasycznych kamienic do nowoczesnych loftów o przemysłowym charakterze: wysoki grzejnik kolumnowy w stylu retro. Ten grzejnik firmy Vasco osiąga także bardzo dobre parametry w połączeniu z systemami niskotemperaturowymi, na przykład z pompami ciepła. Grzejnik kolumnowy Ritmo w najdrobniejszym szczególe został zaprojektowany do oszczędnego i zrównoważonego zużycia energii. Wyposażono go w inteligentne systemy podłączenia i mocowania oraz innowacyjne rozwiązania technologiczne.



RITMO V-2K/65 (2-KOLUMNOWY)



RITMO V-3K/105 (3-KOLUMNOWY)



RITMO V-4K/145 (4-KOLUMNOWY)

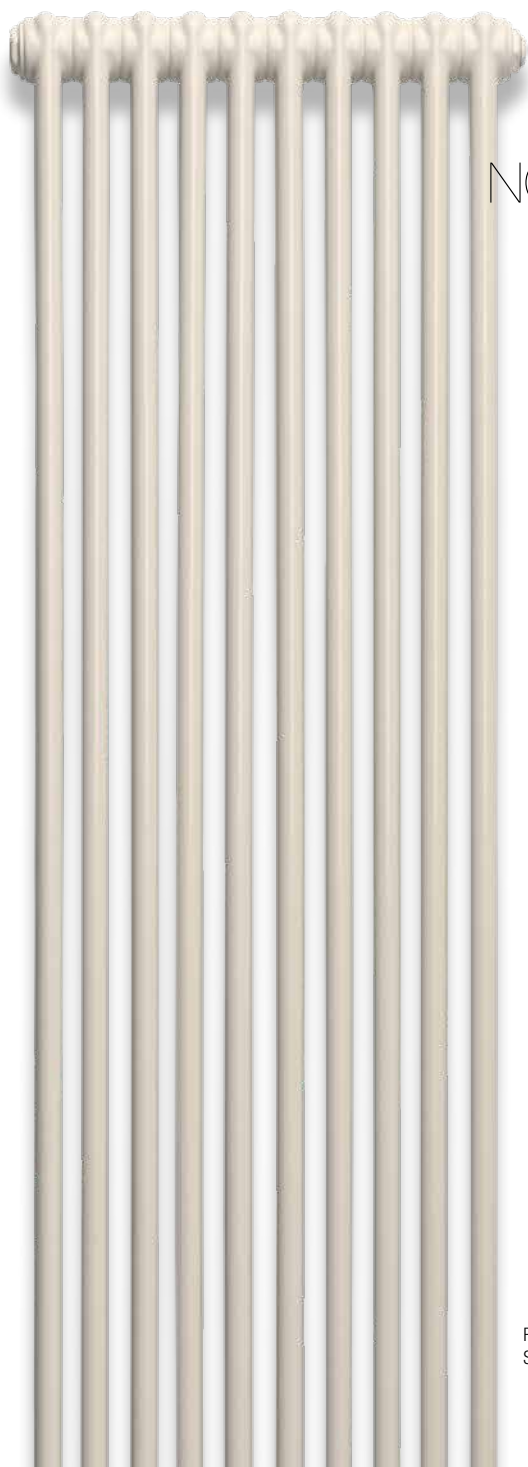

Ritmo pionowy
Sand N503

 **VASCO**

PIONOWY (V-2K/65, V-3K/105, V-4K/145)

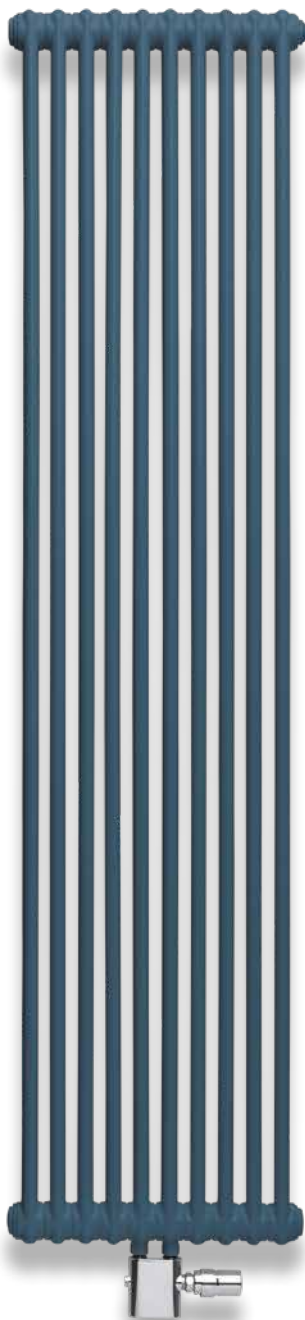

Ritmo pionowy Mid Blue RAL 9802

TYPY

- 2 / 3 / 4 kolumny
- Głębokość: 65 / 105 / 145 mm
- Wysokość: od 1500 do 2200 mm
- Długość: od 270 do 720 mm

RURKI

- Pionowe, $\phi 25$ mm

KOLORY

- Kolor standardowy biały RAL 9016
- Pozostałe kolory wg palety na str. 23

PODŁĄCZENIE

- Podłączenie dolne środkowe 1/2" GW. Rozstaw przyłączy 50 mm
- Punkty zasilania i powrotu dowolne – zależą od zastosowanego zaworu

DANE TECHNICZNE

- Okrągłe rury stalowe w układzie 2, 3, 4 kolumn
- Powłoka ATL, farba proszkowa
- Standardowe ciśnienie robocze: 10 bar
- Maksymalna temperatura robocza: 110°C

ZAWIESIA

- Zawiesia ściennie w kolorze grzejnika dostarczane w komplecie z grzejnikiem. Opis zestawów zawiesi ściennych oraz wykaz opcjonalnych konsoli podłogowych na str. 19 – 20

PRZYŁĄCZA

Odpowietrznik w punkcie 3 lub 6

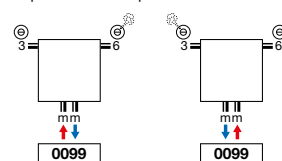

PORĘCZ NA RĘCZNIKI; CHROM



Nr kat. 118326500000099
Cena netto PLN: 632

ZAWÓR Z OSŁONKĄ PROSTĄ W KOLORZE BIAŁYM, CZARNYM LUB CHROM
LUB W KOLORZE GRZEJNIKA (11820010000xxxx)



Nr kat. 118200100009005
Cena netto PLN: 810



Nr kat. 118200100009016
Cena netto PLN: 706



Nr kat. 118200100000099
Cena netto PLN: 810



Nr kat. 11911630102
Cena netto PLN: 240



Nr kat. 11911631102
Cena netto PLN: 318



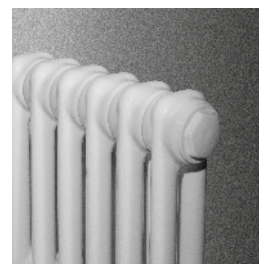
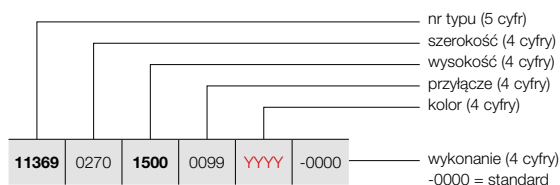

RITMO V-2K/65
(2-KOLUMNOWY)

Wykaz zawiesi i konsol na str. 19 – 20

GRUPA PRODUKTÓW: KOLUMNOWE

KOD PRODUKTU NA ZAMÓWIENIE RITMO PIONOWY	DANE TECHNICZNE								KOLOR STANDARD BIAŁY RAL 9016	KOLORY					
	Liczba rurek	Szerokość L mm	Wysokość H mm	75/65/20 Wat φ50K	55/45/20 Wat φ30K	Wykładnik n	Ciężar kg	Pojemność l	Cena netto PLN	Cena netto PLN					
V-2K/65 : 11369															
11369	0270	1500	0099	YYYY	-0000	6	270	1500	654	333	1,32	11,58	7,92	1 563	1 797
		1800				6	270	1800	780	397	1,32	13,74	9,36	1 714	1 971
		2000				6	270	2000	864	440	1,32	15,18	10,32	1 875	2 156
		2200				6	270	2200	948	483	1,32	16,68	11,28	2 077	2 389
11369	0360	1500	0099	YYYY	-0000	8	360	1500	872	444	1,32	15,44	10,56	1 931	2 221
		1800				8	360	1800	1040	530	1,32	18,32	12,48	2 132	2 452
		2000				8	360	2000	1152	587	1,32	20,24	13,76	2 348	2 700
		2200				8	360	2200	1264	644	1,32	22,24	15,04	2 616	3 008
11369	0450	1500	0099	YYYY	-0000	10	450	1500	1090	555	1,32	19,30	13,20	2 299	2 644
		1800				10	450	1800	1300	662	1,32	22,90	15,60	2 551	2 934
		2000				10	450	2000	1440	734	1,32	25,30	17,20	2 821	3 244
		2200				10	450	2200	1580	805	1,32	27,80	18,80	3 156	3 629
11369	0540	1500	0099	YYYY	-0000	12	540	1500	1308	666	1,32	23,16	15,84	2 668	3 068
		1800				12	540	1800	1560	795	1,32	27,48	18,72	3 029	3 483
		2000				12	540	2000	1728	880	1,32	30,36	20,64	3 353	3 856
		2200				12	540	2200	1896	966	1,32	33,36	22,56	3 755	4 318
11369	0630	1500	0099	YYYY	-0000	14	630	1500	1526	778	1,32	27,02	18,48	3 036	3 491
		1800				14	630	1800	1820	927	1,32	32,06	21,84	3 448	3 965
		2000				14	630	2000	2016	1027	1,32	35,42	24,08	3 825	4 399
		2200				14	630	2200	2212	1127	1,32	38,92	26,32	4 295	4 939
11369	0720	1500	0099	YYYY	-0000	16	720	1500	1744	889	1,32	30,88	21,12	3 464	3 984
		1800				16	720	1800	2080	1060	1,32	36,64	24,96	3 866	4 446
		2000				16	720	2000	2304	1174	1,32	40,48	27,52	4 298	4 943
		2200				16	720	2200	2528	1288	1,32	44,48	30,08	4 835	5 560

Zgodne z normą EN442-1: 2014:grzejniki i konwektory

PIONOWY (3-KOLUMNOWY)

JAK ZAMAWIAĆ GRZEJNIK RITMO PIONOWY

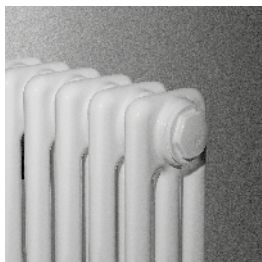

RITMO V-3K/105
(3-KOLUMNOWY)

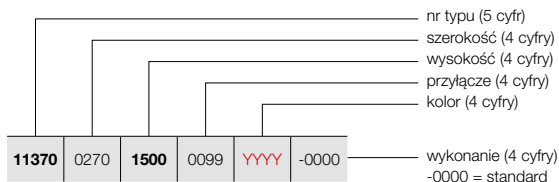

Wykaz zawiesi i konsol na str. 19 – 20

GRUPA PRODUKTÓW: KOLUMNOWE

KOD PRODUKTU NA ZAMÓWIENIE RITMO PIONOWY	DANE TECHNICZNE								KOLOR STANDARD BIAŁY RAL 9016	KOLORY	
	Liczba rurek	Szerokość L mm	Wysokość H mm	75/65/20 Wat φ50K	55/45/20 Wat φ30K	Wyładnik n	Ciężar kg	Pojemność l	Cena netto PLN	Cena netto PLN	
V-3K/105 : 11370											
11370 0270 1500 0099 YYY -0000	1800	6	270	1500	882	443	1,35	17,34	11,76	2 034	2 339
	2000	6	270	1800	1038	521	1,35	20,58	13,92	2 329	2 678
	2200	6	270	2000	1140	575	1,34	22,80	15,36	2 478	2 850
		6	270	2200	1242	626	1,34	24,96	16,80	2 792	3 211
11370 0360 1500 0099 YYY -0000	1800	8	360	1500	1176	590	1,35	23,12	15,68	2 559	2 943
	2000	8	360	1800	1384	694	1,35	27,44	18,56	2 953	3 396
	2200	8	360	2000	1520	767	1,34	30,40	20,48	3 152	3 625
		8	360	2200	1656	835	1,34	33,28	22,40	3 570	4 106
11370 0450 1500 0099 YYY -0000	1800	10	450	1500	1470	738	1,35	28,90	19,60	3 085	3 548
	2000	10	450	1800	1730	868	1,35	34,30	23,20	3 577	4 114
	2200	10	450	2000	1900	958	1,34	38,00	25,60	3 825	4 399
		10	450	2200	2070	1044	1,34	41,60	28,00	4 349	5 001
11370 0540 1500 0099 YYY -0000	1800	12	540	1500	1764	885	1,35	34,68	23,52	3 611	4 153
	2000	12	540	1800	2076	1042	1,35	41,16	27,84	4 260	4 899
	2200	12	540	2000	2280	1150	1,34	45,60	30,72	4 558	5 242
		12	540	2200	2484	1253	1,34	49,92	33,60	5 186	5 964
11370 0630 1500 0099 YYY -0000	1800	14	630	1500	2058	1033	1,35	40,46	27,44	4 136	4 756
	2000	14	630	1800	2422	1215	1,35	48,02	32,48	4 884	5 617
	2200	14	630	2000	2660	1342	1,34	53,20	35,84	5 231	6 016
		14	630	2200	2898	1462	1,34	58,24	39,20	5 964	6 859
11370 0720 1500 0099 YYY -0000	1800	16	720	1500	2352	1180	1,35	46,24	31,36	4 721	5 429
	2000	16	720	1800	2768	1389	1,35	54,88	37,12	5 536	6 366
	2200	16	720	2000	3040	1533	1,34	60,80	40,96	5 905	6 791
		16	720	2200	3312	1670	1,34	66,56	44,80	6 742	7 753

Zgodne z normą EN442-1: 2014:grzejniki i konwektory

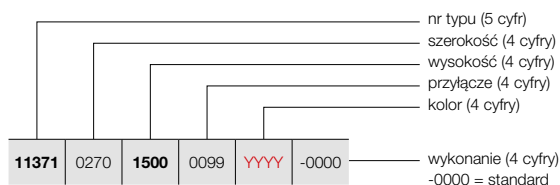

RITMO V-4K/145
(4-KOLUMNOWY)

Wykaz zawiesi i konsol na str. 19 – 20

GRUPA PRODUKTÓW: KOLUMNOWE

KOD PRODUKTU NA ZAMÓWIENIE RITMO PIONOWY	DANE TECHNICZNE								KOLOR STANDARD BIAŁY RAL 9016	KOLORY					
	Liczba rurek	Szerokość L mm	Wysokość H mm	75/65/20 Wat φ50K	55/45/20 Wat φ30K	Wykładnik n	Ciężar kg	Pojemność l	Cena netto PLN	Cena netto PLN					
V-4K/145 : 11371															
11371	0270	1500	0099	YYYY	-0000	6	270	1500	1116	560	1,35	23,10	15,60	2 519	2 897
		1800				6	270	1800	1314	663	1,34	27,48	18,48	2 933	3 373
		2000				6	270	2000	1446	729	1,34	30,36	20,40	3 220	3 703
		2200				6	270	2200	1572	793	1,34	33,30	22,32	3 493	4 017
11371	0360	1500	0099	YYYY	-0000	8	360	1500	1488	747	1,35	30,80	20,80	3 206	3 687
		1800				8	360	1800	1752	884	1,34	36,64	24,64	3 758	4 322
		2000				8	360	2000	1928	972	1,34	40,48	27,20	4 141	4 762
		2200				8	360	2200	2096	1057	1,34	44,40	29,76	4 504	5 180
11371	0450	1500	0099	YYYY	-0000	10	450	1500	1860	933	1,35	38,50	26,00	3 893	4 477
		1800				10	450	1800	2190	1105	1,34	45,80	30,80	4 583	5 270
		2000				10	450	2000	2410	1215	1,34	50,60	34,00	5 062	5 821
		2200				10	450	2200	2620	1321	1,34	55,50	37,20	5 516	6 343
11371	0540	1500	0099	YYYY	-0000	12	540	1500	2232	1120	1,35	46,20	31,20	4 581	5 268
		1800				12	540	1800	2628	1325	1,34	54,96	36,96	5 467	6 287
		2000				12	540	2000	2892	1459	1,34	60,72	40,80	6 042	6 948
		2200				12	540	2200	3144	1586	1,34	66,60	44,64	6 587	7 575
11371	0630	1500	0099	YYYY	-0000	14	630	1500	2604	1307	1,35	53,90	36,40	5 268	6 058
		1800				14	630	1800	3066	1546	1,34	64,12	43,12	6 292	7 236
		2000				14	630	2000	3374	1702	1,34	70,84	47,60	6 963	8 007
		2200				14	630	2200	3668	1850	1,34	77,70	52,08	7 598	8 738
11371	0720	1500	0099	YYYY	-0000	16	720	1500	2976	1493	1,35	61,60	41,60	6 014	6 916
		1800				16	720	1800	3504	1767	1,34	73,28	49,28	7 118	8 186
		2000				16	720	2000	3856	1945	1,34	80,96	54,40	7 884	9 067
		2200				16	720	2200	4192	2114	1,34	88,80	59,52	8 610	9 902

Zgodne z normą EN442-1: 2014:grzejniki i konwektory

BŁYSKAWICZNE OGRZEWANIE



Poziome grzejniki Ritmo są doskonałą propozycją do klasycznych i nowoczesnych pomieszczeń w typowych miejscach, np. pod oknami, parapetami lub w ciągach komunikacyjnych. Niezależnie od wielkości pomieszczenia i jego przeznaczenia z kolekcji Vasco Ritmo z pewnością dobierzesz grzejnik, który zaspokoi Twoje potrzeby.



RITMO H-2K/65 (2-KOLUMNOWY)



RITMO H-3K/105 (3-KOLUMNOWY)



RITMO H-4K/145 (4-KOLUMNOWY)

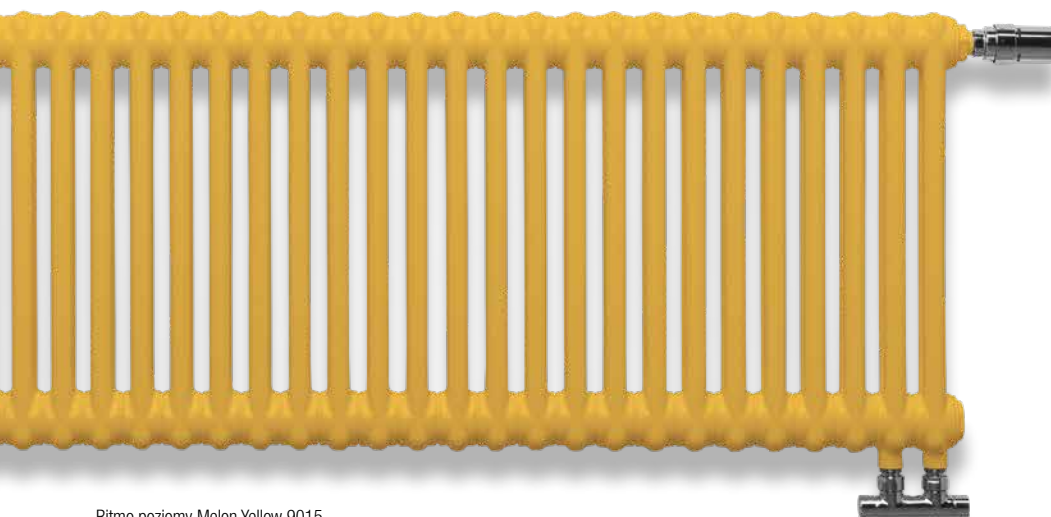

Ritmo poziomy Melon Yellow 9015

RITMO

POZIOMY

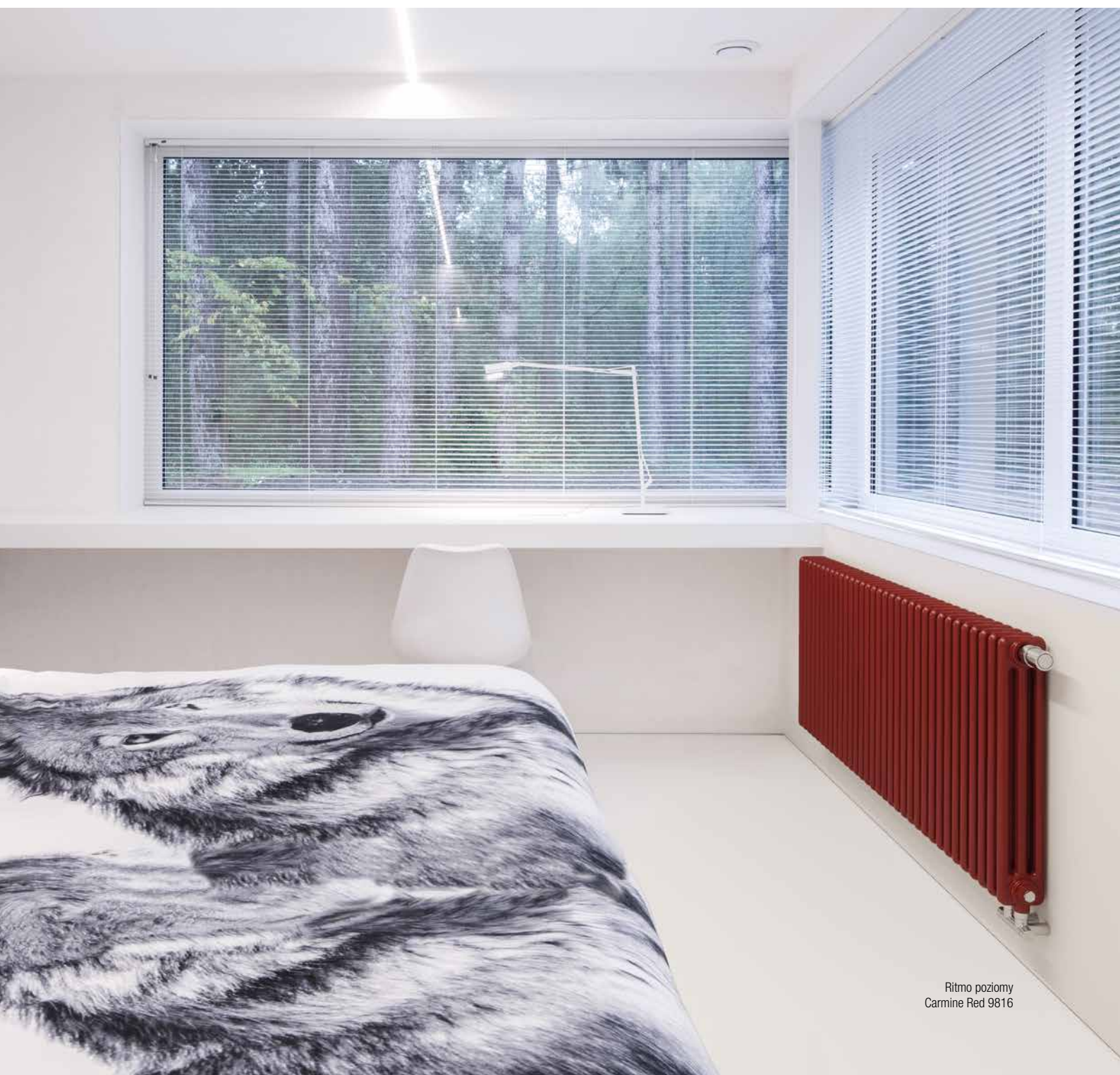

POZIOMY (H-2K/65, H-3K/105, H-4K/145)

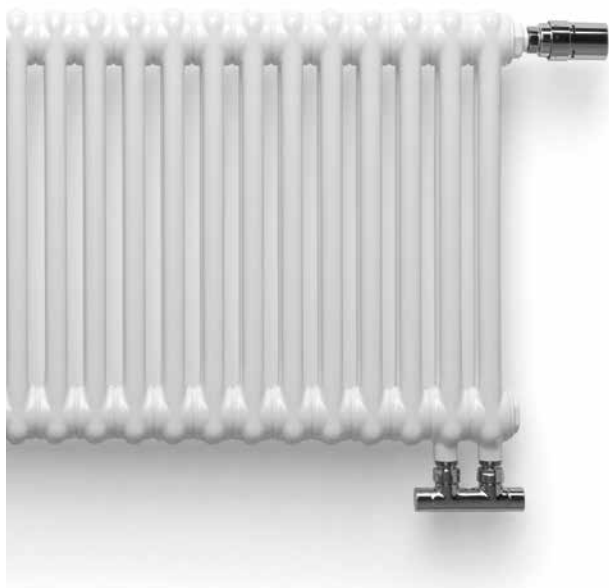

TYPY

- 2 / 3 / 4 kolumny
- Głębokość: 65 / 105 / 145 mm
- Wysokość: od 300 do 900 mm
- Długość: od 450 do 1800 mm

RURKI

- Pionowe, $\phi 25$ mm

KOLORY

- Kolor standardowy biały RAL 9016
- Pozostałe kolory wg palety na str. 23

MOCOWANIE

- Montaż na podłodze lub na ścianie
- System do montażu na ścianie zamawiany osobno

DANE TECHNICZNE

- Okrągłe rury stalowe w układzie 2, 3, 4 kolumn
- Powłoka ATL, farba proszkowa
- Standardowe ciśnienie robocze: 10 bar
- Maksymalna temperatura robocza: 110°C

PODŁĄCZENIE

- Zasilanie 2-rurowe
- 4 podłączenia boczne, bez zaworu. Symbol podłączenia: 2367 lub
- Podłączenie zaworowe dolne – lewe/prawe – zamiennie. Wbudowana wkładka zaworowa M30 x 1,5. Symbol podłączenia: 0098. Dopłata za przyłącze zaworowe: 378 netto PLN

ZAWIESIA

- Zawiesia ścienne w kolorze grzejnika dostarczane w komplecie z grzejnikiem.
- Opis zestawów zawiesi ściennych oraz wykaz opcjonalnych konsoli podłogowych na str. 19 – 20

PODŁĄCZENIE ZAWOROWE

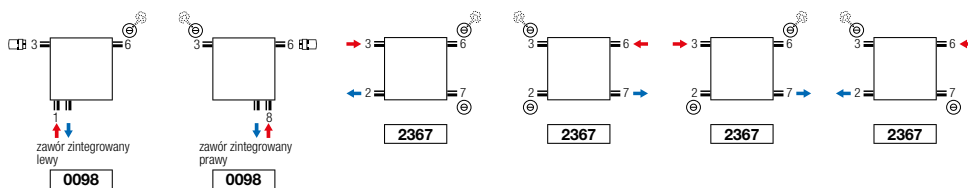

PORĘCZ NA RĘCZNIKI; CHROM



Nr kat. 11832650000099
Cena netto PLN: 632

BŁOK PRZYŁĄCZENIOWY KĄTOWY 1/2" GZ / 3/4" GZ; CHROM



Nr kat. 11823010000099
Cena netto PLN: 637

GŁOWICA TERMOSTATYCZNA, BIAŁA LUB CHROMOWANA



Nr kat. 11911630102
Cena netto PLN: 229

Nr kat. 11911631102
Cena netto PLN: 303



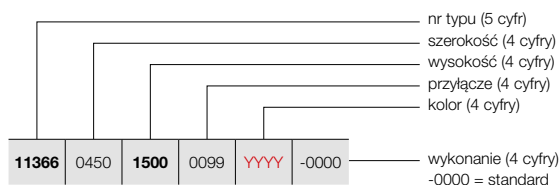

Wykaz zawiesi i konsol na str. 19 – 20

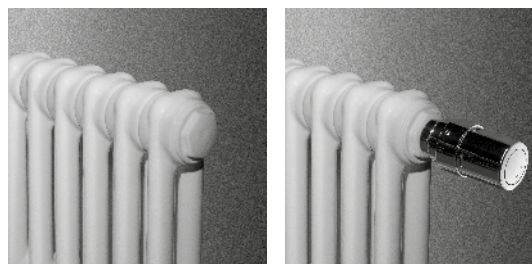

RITMO H-2K/65
(2-KOLUMNOWY)

RITMO H-2K/65
(2-KOLUMNOWY)
ZINTEGROWANY ZAWÓR

GRUPA PRODUKTÓW: KOLUMNOWE

KOD PRODUKTU NA ZAMÓWIENIE RITMO POZIOMY	DANE TECHNICZNE								KOLOR STANDARD BIAŁY RAL 9016	KOLORY					
	Liczba rurek	Szerokość L mm	Wysokość H mm	75/65/20 Wat φ50K	55/45/20 Wat φ30K	Wykładnik n	Ciężar kg	Pojemność l	Cena netto PLN	Cena netto PLN					
H-2K/65 : 11366															
11366	0450	0300	XXXX	YYYY	-0000	10	450	300	240	126	1,26	4,70	3,70	1 103	1 268
		0400				10	450	400	310	159	1,31	5,90	4,50	1 146	1 318
		0500				10	450	500	390	200	1,31	7,10	5,30	1 152	1 325
		0600				10	450	600	460	236	1,31	8,30	6,10	1 195	1 374
		0900				10	450	900	670	343	1,31	12,00	8,40	1 378	1 585
11366	0540	0300	XXXX	YYYY	-0000	12	540	300	288	151	1,26	5,64	4,44	1 299	1 494
		0400				12	540	400	372	191	1,31	7,08	5,40	1 350	1 553
		0500				12	540	500	468	240	1,31	8,52	6,36	1 357	1 561
		0600				12	540	600	552	283	1,31	9,96	7,32	1 408	1 619
		0900				12	540	900	804	412	1,31	14,40	10,08	1 628	1 872
11366	0630	0300	XXXX	YYYY	-0000	14	630	300	336	177	1,26	6,58	5,18	1 495	1 719
		0400				14	630	400	434	222	1,31	8,26	6,30	1 555	1 788
		0500				14	630	500	546	280	1,31	9,94	7,42	1 563	1 797
		0600				14	630	600	644	330	1,31	11,62	8,54	1 622	1 865
		0900				14	630	900	938	480	1,31	16,80	11,76	1 879	2 161
11366	0720	0300	XXXX	YYYY	-0000	16	720	300	384	202	1,26	7,52	5,92	1 690	1 944
		0400				16	720	400	496	254	1,31	9,44	7,20	1 759	2 023
		0500				16	720	500	624	320	1,31	11,36	8,48	1 768	2 033
		0600				16	720	600	736	377	1,31	13,28	9,76	1 836	2 111
		0900				16	720	900	1072	549	1,31	19,20	13,44	2 130	2 450
11366	0810	0300	XXXX	YYYY	-0000	18	810	300	432	227	1,26	8,46	6,66	1 886	2 169
		0400				18	810	400	558	286	1,31	10,62	8,10	1 963	2 257
		0500				18	810	500	702	360	1,31	12,78	9,54	1 973	2 269
		0600				18	810	600	828	425	1,31	14,94	10,98	2 050	2 358
		0900				18	810	900	1206	618	1,31	21,60	15,12	2 380	2 737
11366	0900	0300	XXXX	YYYY	-0000	20	900	300	480	252	1,26	9,40	7,40	2 082	2 394
		0400				20	900	400	620	318	1,31	11,80	9,00	2 167	2 492
		0500				20	900	500	780	399	1,31	14,20	10,60	2 179	2 506
		0600				20	900	600	920	472	1,31	16,60	12,20	2 264	2 604
		0900				20	900	900	1340	686	1,31	24,00	16,80	2 631	3 026
11366	0990	0300	XXXX	YYYY	-0000	22	990	300	528	277	1,26	10,34	8,14	2 278	2 620
		0400				22	990	400	682	349	1,31	12,98	9,90	2 372	2 728
		0500				22	990	500	858	439	1,31	15,62	11,66	2 384	2 742
		0600				22	990	600	1012	519	1,31	18,26	13,42	2 478	2 850
		0900				22	990	900	1474	755	1,31	26,40	18,48	2 882	3 314
11366	1080	0300	XXXX	YYYY	-0000	24	1080	300	576	303	1,26	11,28	8,88	2 532	2 912
		0400				24	1080	400	744	381	1,31	14,16	10,80	2 635	3 030
		0500				24	1080	500	936	479	1,31	17,04	12,72	2 648	3 045
		0600				24	1080	600	1104	566	1,31	19,92	14,64	2 751	3 164
		0900				24	1080	900	1608	824	1,31	28,80	20,16	3 191	3 670

Zgodne z normą EN442-1: 2014:grzejniki i konwektory

POZIOMY (2-KOLUMNOWY)

JAK ZAMAWIAĆ GRZEJNIK RITMO POZIOMY

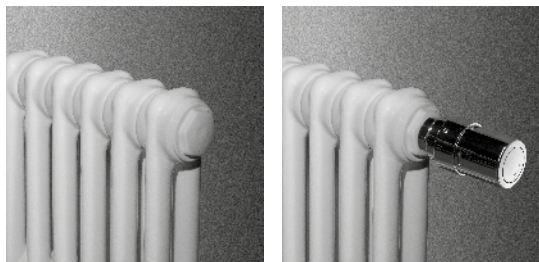

RITMO H-2K/65
(2-KOLUMNOWY)

RITMO H-2K/65
(2-KOLUMNOWY)
ZINTEGROWANY ZAWÓR

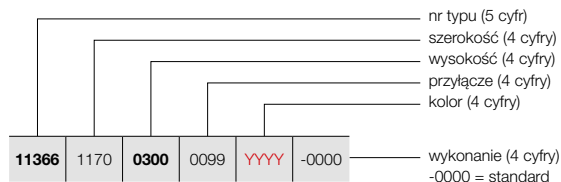

Wykaz zawiesi i konsol na str. 19 – 20

GRUPA PRODUKTÓW: KOLUMNOWE

KOD PRODUKTU NA ZAMÓWIENIE RITMO POZIOMY						DANE TECHNICZNE				KOLOR STANDARD BIAŁY RAL 9016		KOLORY			
						Liczba rurek	Szerokość L mm	Wysokość H mm	75/65/20 Wat φ50K	55/45/20 Wat φ30K	Wykładnik n	Ciężar kg	Pojemność l	Cena netto PLN	Cena netto PLN
H-2K/65 : 11366															
11366	1170	0300	XXXX	YYYY	-0000	26	1170	300	624	328	1,26	12,22	9,62	2 728	3 137
		0400				26	1170	400	806	413	1,31	15,34	11,70	2 839	3 265
		0500				26	1170	500	1014	519	1,31	18,46	13,78	2 854	3 282
		0600				26	1170	600	1196	613	1,31	21,58	15,86	2 965	3 410
		0900				26	1170	900	1742	892	1,31	31,20	21,84	3 442	3 958
11366	1260	0300	XXXX	YYYY	-0000	28	1260	300	672	353	1,26	13,16	10,36	2 924	3 363
		0400				28	1260	400	868	445	1,31	16,52	12,60	3 043	3 499
		0500				28	1260	500	1092	559	1,31	19,88	14,84	3 059	3 518
		0600				28	1260	600	1288	661	1,31	23,21	17,08	3 179	3 656
		0900				28	1260	900	1876	961	1,31	33,60	23,52	3 692	4 246
11366	1350	0300	XXXX	YYYY	-0000	30	1350	300	720	378	1,26	14,10	11,10	3 119	3 587
		0400				30	1350	400	930	476	1,31	17,70	13,50	3 247	3 734
		0500				30	1350	500	1170	599	1,31	21,30	15,90	3 265	3 755
		0600				30	1350	600	1380	708	1,31	24,90	18,30	3 393	3 902
		0900				30	1350	900	2010	1029	1,31	36,00	25,20	3 943	4 534
11366	1440	0300	XXXX	YYYY	-0000	32	1440	300	768	403	1,26	15,04	11,84	3 315	3 812
		0400				32	1440	400	992	508	1,31	18,88	14,40	3 452	3 970
		0500				32	1440	500	1248	639	1,31	22,72	16,96	3 470	3 991
		0600				32	1440	600	1472	755	1,31	26,56	19,52	3 607	4 148
		0900				32	1440	900	2144	1098	1,31	38,40	26,88	4 193	4 822
11366	1530	0300	XXXX	YYYY	-0000	34	1530	300	816	429	1,26	15,98	12,58	3 511	4 038
		0400				34	1530	400	1054	540	1,31	20,06	15,30	3 656	4 204
		0500				34	1530	500	1326	679	1,31	24,14	18,02	3 675	4 226
		0600				34	1530	600	1564	802	1,31	28,22	20,74	3 821	4 394
		0900				34	1530	900	2278	1167	1,31	40,80	28,56	4 444	5 111
11366	1620	0300	XXXX	YYYY	-0000	36	1620	300	864	454	1,26	16,92	13,32	3 706	4 262
		0400				36	1620	400	1116	572	1,31	21,24	16,20	3 860	4 439
		0500				36	1620	500	1404	719	1,31	25,56	19,08	3 881	4 463
		0600				36	1620	600	1656	849	1,31	29,88	21,96	4 035	4 640
		0900				36	1620	900	2412	1235	1,31	43,20	30,24	4 695	5 399
11366	1710	0300	XXXX	YYYY	-0000	38	1710	300	912	479	1,26	17,86	14,06	3 902	4 487
		0400				38	1710	400	1178	603	1,31	22,42	17,10	4 064	4 674
		0500				38	1710	500	1482	759	1,31	26,98	20,14	4 086	4 699
		0600				38	1710	600	1748	896	1,31	31,54	23,18	4 249	4 886
		0900				38	1710	900	2546	1304	1,31	45,60	31,92	4 945	5 687
11366	1800	0300	XXXX	YYYY	-0000	40	1800	300	960	504	1,26	18,80	14,80	4 145	4 767
		0400				40	1800	400	1240	635	1,31	23,60	18,00	4 316	4 963
		0500				40	1800	500	1560	799	1,31	28,40	21,20	4 339	4 990
		0600				40	1800	600	1840	944	1,31	33,20	24,40	4 510	5 187
		0900				40	1800	900	2680	1373	1,31	48,00	33,60	5 243	6 029

Zgodne z normą EN442-1: 2014:grzejniki i konwektory

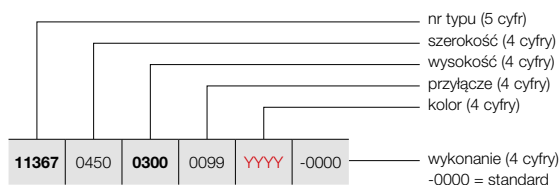

Wykaz zawiesi i konsol na str. 19 – 20

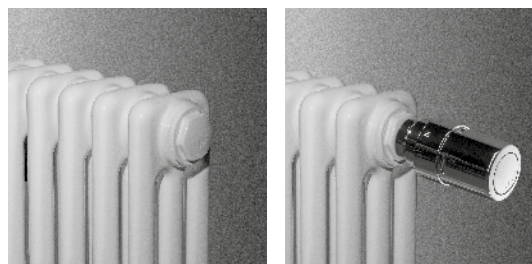

RITMO H-3K/105
(3-KOLUMNOWY)

RITMO H-3K/105
(3-KOLUMNOWY)
ZINTEGROWANY ZAWÓR

GRUPA PRODUKTÓW: KOLUMNOWE

KOD PRODUKTU NA ZAMÓWIENIE RITMO POZIOMY	DANE TECHNICZNE								KOLOR STANDARD BIAŁY RAL 9016	KOLORY					
	Liczba rurek	Szerokość L mm	Wysokość H mm	75/65/20 Wat φ50K	55/45/20 Wat φ30K	Wykładnik n	Ciężar kg	Pojemność l	Cena netto PLN	Cena netto PLN					
H-3K/105 : 11367															
11367	0450	0300	XXXX	YYYY	-0000	10	450	300	330	167	1,33	7,00	5,30	1 188	1 366
		0400				10	450	400	430	215	1,36	8,80	6,50	1 261	1 450
		0500				10	450	500	530	265	1,36	10,60	7,70	1 282	1 474
		0600				10	450	600	630	315	1,36	12,50	8,90	1 343	1 544
		0900				10	450	900	920	459	1,36	17,90	12,50	1 597	1 837
11367	0540	0300	XXXX	YYYY	-0000	12	540	300	396	201	1,33	8,40	6,36	1 400	1 610
		0400				12	540	400	516	258	1,36	10,56	7,80	1 488	1 711
		0500				12	540	500	636	258	1,36	12,72	9,24	1 513	1 740
		0600				12	540	600	756	377	1,36	15,00	10,68	1 586	1 824
		0900				12	540	900	1104	551	1,36	21,48	15,00	1 892	2 176
11367	0630	0300	XXXX	YYYY	-0000	14	630	300	462	234	1,33	9,80	7,42	1 613	1 855
		0400				14	630	400	602	301	1,36	12,32	9,10	1 716	1 973
		0500				14	630	500	742	301	1,36	14,84	10,78	1 745	2 007
		0600				14	630	600	882	440	1,36	17,50	12,46	1 830	2 105
		0900				14	630	900	1288	643	1,36	25,06	17,50	2 186	2 514
11367	0720	0300	XXXX	YYYY	-0000	16	720	300	528	268	1,33	11,20	8,48	1 826	2 100
		0400				16	720	400	688	343	1,36	14,08	10,40	1 943	2 234
		0500				16	720	500	848	343	1,36	16,96	12,32	1 976	2 272
		0600				16	720	600	1008	503	1,36	20,00	14,24	2 073	2 384
		0900				16	720	900	1472	735	1,36	28,64	20,00	2 481	2 853
11367	0810	0300	XXXX	YYYY	-0000	18	810	300	594	301	1,33	12,60	9,54	2 038	2 344
		0400				18	810	400	774	386	1,36	15,84	11,70	2 170	2 496
		0500				18	810	500	954	386	1,36	19,08	13,86	2 208	2 539
		0600				18	810	600	1134	566	1,36	22,50	16,02	2 317	2 665
		0900				18	810	900	1656	827	1,36	32,22	22,50	2 775	3 191
11367	0900	0300	XXXX	YYYY	-0000	20	900	300	660	335	1,33	14,00	10,60	2 251	2 589
		0400				20	900	400	860	429	1,36	17,60	13,00	2 397	2 757
		0500				20	900	500	1060	429	1,36	21,20	15,40	2 439	2 805
		0600				20	900	600	1260	629	1,36	25,00	17,80	2 561	2 945
		0900				20	900	900	1840	919	1,36	35,80	25,00	3 070	3 531
11367	0990	0300	XXXX	YYYY	-0000	22	990	300	726	368	1,33	15,40	11,66	2 464	2 834
		0400				22	990	400	946	472	1,36	19,36	14,30	2 624	3 018
		0500				22	990	500	1166	472	1,36	23,32	16,94	2 670	3 071
		0600				22	990	600	1386	692	1,36	27,50	19,58	2 804	3 225
		0900				22	990	900	2024	1010	1,36	39,38	27,50	3 364	3 869
11367	1080	0300	XXXX	YYYY	-0000	24	1080	300	792	401	1,33	16,80	12,72	2 735	3 145
		0400				24	1080	400	1032	515	1,36	21,12	15,60	2 911	3 348
		0500				24	1080	500	1272	515	1,36	25,44	18,48	2 961	3 405
		0600				24	1080	600	1512	755	1,36	30,00	21,36	3 107	3 573
		0900				24	1080	900	2208	1102	1,36	42,96	30,00	3 718	4 276

Zgodne z normą EN442-1: 2014:grzejniki i konwektory

POZIOMY (3-KOLUMNOWY)

JAK ZAMAWIĄĆ GRZEJNIK RITMO POZIOMY

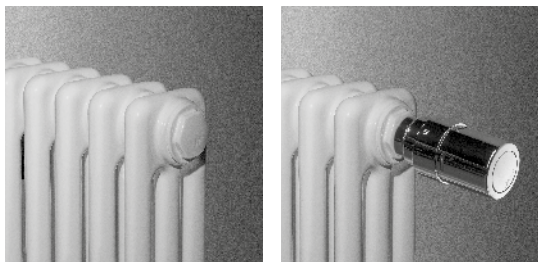

RITMO H-3K/105
(3-KOLUMNOWY)

RITMO H-3K/105
(3-KOLUMNOWY)
ZINTEGROWANY ZAWÓR

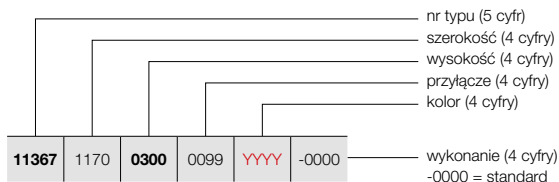

Wykaz zawiesi i konsol na str. 19 – 20

GRUPA PRODUKTÓW: KOLUMNOWE

KOD PRODUKTU NA ZAMÓWIENIE RITMO POZIOMY	DANE TECHNICZNE								KOLOR STANDARD BIAŁY RAL 9016	KOLORY					
	Liczba rurek	Szerokość L mm	Wysokość H mm	75/65/20 Wat φ50K	55/45/20 Wat φ30K	Wyładnik n	Ciężar kg	Pojemność l	Cena netto PLN	Cena netto PLN					
H-3K/105 : 11367															
11367	1170	0300	XXXX	YYYY	-0000	26	1170	300	858	435	1,33	18,20	13,78	2 948	3 390
		0400				26	1170	400	1118	558	1,36	22,88	16,90	3 138	3 609
		0500				26	1170	500	1378	558	1,36	27,56	20,02	3 192	3 671
		0600				26	1170	600	1638	818	1,36	32,50	23,14	3 350	3 853
		0900				26	1170	900	2392	1194	1,36	46,54	32,50	4 012	4 614
11367	1260	0300	XXXX	YYYY	-0000	28	1260	300	924	468	1,33	19,60	14,84	3 160	3 634
		0400				28	1260	400	1204	601	1,36	24,64	18,20	3 365	3 870
		0500				28	1260	500	1484	601	1,36	29,68	21,56	3 424	3 938
		0600				28	1260	600	1764	881	1,36	35,00	24,92	3 594	4 133
		0900				28	1260	900	2576	1286	1,36	50,12	35,00	4 307	4 953
11367	1350	0300	XXXX	YYYY	-0000	30	1350	300	990	502	1,33	21,00	15,90	3 373	3 879
		0400				30	1350	400	1290	644	1,36	26,40	19,50	3 592	4 131
		0500				30	1350	500	1590	644	1,36	31,80	23,10	3 655	4 203
		0600				30	1350	600	1890	944	1,36	37,50	26,70	3 837	4 413
		0900				30	1350	900	2760	1378	1,36	53,70	37,50	4 601	5 291
11367	1440	0300	XXXX	YYYY	-0000	32	1440	300	1056	535	1,33	22,40	16,96	3 585	4 123
		0400				32	1440	400	1376	687	1,36	28,16	20,80	3 820	4 393
		0500				32	1440	500	1696	687	1,36	33,92	24,64	3 886	4 469
		0600				32	1440	600	2016	1006	1,36	40,00	28,48	4 081	4 693
		0900				32	1440	900	2944	1470	1,36	57,28	40,00	4 896	5 630
11367	1530	0300	XXXX	YYYY	-0000	34	1530	300	1122	569	1,33	23,80	18,02	3 798	4 368
		0400				34	1530	400	1462	730	1,36	29,92	22,10	4 047	4 654
		0500				34	1530	500	1802	730	1,36	36,04	26,18	4 118	4 736
		0600				34	1530	600	2142	1069	1,36	42,50	30,26	4 325	4 974
		0900				34	1530	900	3128	1562	1,36	60,86	42,50	5 190	5 969
11367	1620	0300	XXXX	YYYY	-0000	36	1620	300	1188	602	1,33	25,20	19,08	4 011	4 613
		0400				36	1620	400	1548	773	1,36	31,68	23,40	4 274	4 915
		0500				36	1620	500	1908	773	1,36	38,16	27,72	4 349	5 001
		0600				36	1620	600	2268	1132	1,36	45,00	32,04	4 568	5 253
		0900				36	1620	900	3312	1653	1,36	64,44	45,00	5 485	6 308
11367	1710	0300	XXXX	YYYY	-0000	38	1710	300	1254	636	1,33	26,60	20,14	4 223	4 856
		0400				38	1710	400	1634	816	1,36	33,44	24,70	4 501	5 176
		0500				38	1710	500	2014	816	1,36	40,28	29,26	4 581	5 268
		0600				38	1710	600	2394	1195	1,36	47,50	33,82	4 812	5 534
		0900				38	1710	900	3496	1745	1,36	68,02	47,50	5 779	6 646
11367	1800	0300	XXXX	YYYY	-0000	40	1800	300	1320	669	1,33	28,00	21,20	4 483	5 155
		0400				40	1800	400	1720	859	1,36	35,20	26,00	4 776	5 492
		0500				40	1800	500	2120	859	1,36	42,40	30,80	4 860	5 589
		0600				40	1800	600	2520	1258	1,36	50,00	35,60	5 103	5 868
		0900				40	1800	900	3680	1837	1,36	71,60	50,00	6 121	7 039

Zgodne z normą EN442-1: 2014:grzejniki i konwektory

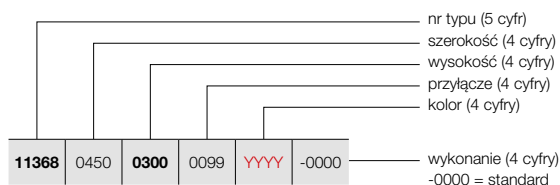

Wykaz zawiesi i konsol na str. 19 – 20

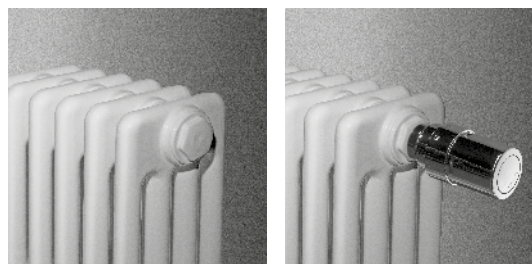

RITMO H-4K/145
(4-KOLUMNOWY)

RITMO H-4K/145
(4-KOLUMNOWY)
ZINTEGROWANY ZAWÓR

GRUPA PRODUKTÓW: KOLUMNOWE

KOD PRODUKTU NA ZAMÓWIENIE RITMO POZIOMY	DANE TECHNICZNE								KOLOR STANDARD BIAŁY RAL 9016	KOLORY					
	Liczba rurek	Szerokość L mm	Wysokość H mm	75/65/20 Wat φ50K	55/45/20 Wat φ30K	Wykładnik n	Ciężar kg	Pojemność l	Cena netto PLN	Cena netto PLN					
H-4K/145 : 11368															
11368	0450	0300	XXXX	YYYY	-0000	10	450	300	430	218	1,33	9,30	6,90	1 310	1 507
		0400				10	450	400	560	281	1,35	11,80	8,50	1 376	1 582
		0500				10	450	500	690	346	1,35	14,20	10,10	1 417	1 630
		0600				10	450	600	810	406	1,35	16,60	11,70	1 528	1 757
		0900				10	450	900	1170	587	1,35	23,90	16,50	2 016	2 318
11368	0540	0300	XXXX	YYYY	-0000	12	540	300	516	262	1,33	11,16	8,28	1 548	1 780
		0400				12	540	400	672	337	1,35	14,16	10,20	1 626	1 870
		0500				12	540	500	828	415	1,35	17,04	12,12	1 675	1 926
		0600				12	540	600	972	488	1,35	19,92	14,04	1 809	2 080
		0900				12	540	900	1404	704	1,35	28,68	19,80	2 395	2 754
11368	0630	0300	XXXX	YYYY	-0000	14	630	300	602	305	1,33	13,02	9,66	1 785	2 053
		0400				14	630	400	784	393	1,35	16,52	11,90	1 876	2 157
		0500				14	630	500	966	485	1,35	19,88	14,14	1 934	2 224
		0600				14	630	600	1134	569	1,35	23,24	16,38	2 089	2 402
		0900				14	630	900	1638	822	1,35	33,46	23,10	2 773	3 189
11368	0720	0300	XXXX	YYYY	-0000	16	720	300	688	349	1,33	14,88	11,04	2 022	2 325
		0400				16	720	400	896	450	1,35	18,88	13,60	2 127	2 446
		0500				16	720	500	1104	554	1,35	22,72	16,16	2 192	2 521
		0600				16	720	600	1296	650	1,35	26,56	18,72	2 370	2 726
		0900				16	720	900	1872	939	1,35	38,24	26,40	3 151	3 624
11368	0810	0300	XXXX	YYYY	-0000	18	810	300	774	392	1,33	16,74	12,42	2 259	2 598
		0400				18	810	400	1008	506	1,35	21,24	15,30	2 377	2 734
		0500				18	810	500	1242	623	1,35	25,56	18,18	2 450	2 818
		0600				18	810	600	1458	732	1,35	29,88	21,06	2 651	3 049
		0900				18	810	900	2106	1057	1,35	43,02	29,70	3 529	4 058
11368	0900	0300	XXXX	YYYY	-0000	20	900	300	860	436	1,33	18,60	13,80	2 496	2 870
		0400				20	900	400	1120	562	1,35	23,60	17,00	2 627	3 021
		0500				20	900	500	1380	692	1,35	28,40	20,20	2 709	3 115
		0600				20	900	600	1620	813	1,35	33,20	23,40	2 931	3 371
		0900				20	900	900	2340	1174	1,35	47,80	33,00	3 908	4 494
11368	0990	0300	XXXX	YYYY	-0000	22	990	300	946	480	1,33	20,46	15,18	2 733	3 143
		0400				22	990	400	1232	618	1,35	25,96	18,70	2 877	3 309
		0500				22	990	500	1518	762	1,35	31,24	22,22	2 967	3 412
		0600				22	990	600	1782	894	1,35	36,52	25,74	3 212	3 694
		0900				22	990	900	2574	1292	1,35	52,58	36,30	4 286	4 929
11368	1080	0300	XXXX	YYYY	-0000	24	1080	300	1032	523	1,33	22,32	16,56	3 029	3 483
		0400				24	1080	400	1344	674	1,35	28,32	20,40	3 186	3 664
		0500				24	1080	500	1656	831	1,35	34,08	24,24	3 285	3 778
		0600				24	1080	600	1944	975	1,35	39,84	28,08	3 551	4 084
		0900				24	1080	900	2808	1409	1,35	57,36	39,60	4 723	5 431

Zgodne z normą EN442-1: 2014:grzejniki i konwektory

POZIOMY (4-KOLUMNOWY)

JAK ZAMAWIAĆ GRZEJNIK RITMO POZIOMY

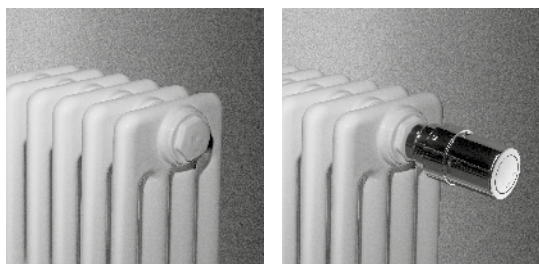

RITMO H-4K/145
(4-KOLUMNOWY)

RITMO H-4K/145
(4-KOLUMNOWY)
ZINTEGROWANY ZAWÓR

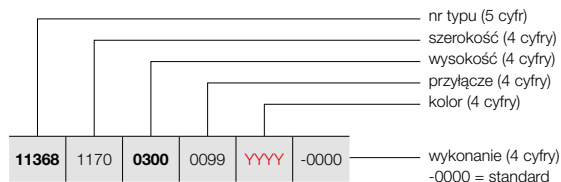

Wykaz zawiesi i konsol na str. 19 – 20

GRUPA PRODUKTÓW: KOLUMNOWE

KOD PRODUKTU NA ZAMÓWIENIE RITMO POZIOMY						DANE TECHNICZNE						KOLOR STANDARD	KOLORY		
						Liczba rurek	Szerokość L mm	Wysokość H mm	75/65/20 Wat φ50K	55/45/20 Wat φ30K	Wykładnik n	Ciężar kg	Pojemność l	Cena netto PLN	Cena netto PLN
H-4K/145 : 11368															
11368	1170	0300	XXXX	YYYY	-0000	26	1170	300	1118	567	1,33	24,18	17,94	3 266	3 756
		0400				26	1170	400	1456	731	1,35	30,68	22,10	3 437	3 953
		0500				26	1170	500	1794	900	1,35	36,92	26,26	3 543	4 074
		0600				26	1170	600	2106	1057	1,35	43,16	30,42	3 832	4 407
		0900				26	1170	900	3042	1526	1,35	62,14	42,90	5 102	5 867
11368	1260	0300	XXXX	YYYY	-0000	28	1260	300	1204	610	1,33	26,04	19,32	3 503	4 028
		0400				28	1260	400	1568	787	1,35	33,04	23,80	3 687	4 240
		0500				28	1260	500	1932	969	1,35	39,76	28,28	3 801	4 371
		0600				28	1260	600	2268	1138	1,35	46,48	32,76	4 113	4 730
		0900				28	1260	900	3276	1644	1,35	66,92	46,20	5 480	6 302
11368	1350	0300	XXXX	YYYY	-0000	30	1350	300	1290	654	1,33	27,90	20,70	3 741	4 302
		0400				30	1350	400	1680	843	1,35	35,40	25,50	3 937	4 528
		0500				30	1350	500	2070	1039	1,35	42,60	30,30	4 060	4 669
		0600				30	1350	600	2430	1219	1,35	49,80	35,10	4 393	5 052
		0900				30	1350	900	3510	1761	1,35	71,70	49,50	5 858	6 737
11368	1440	0300	XXXX	YYYY	-0000	32	1440	300	1376	698	1,33	29,76	22,08	3 978	4 575
		0400				32	1440	400	1792	899	1,35	37,76	27,20	4 187	4 815
		0500				32	1440	500	2208	1108	1,35	45,44	32,32	4 318	4 966
		0600				32	1440	600	2592	1301	1,35	53,12	37,44	4 674	5 375
		0900				32	1440	900	3744	1879	1,35	76,48	52,80	6 236	7 171
11368	1530	0300	XXXX	YYYY	-0000	34	1530	300	1462	741	1,33	31,62	23,46	4 215	4 847
		0400				34	1530	400	1904	955	1,35	40,12	28,90	4 438	5 104
		0500				34	1530	500	2346	1177	1,35	48,28	34,34	4 577	5 264
		0600				34	1530	600	2754	1382	1,35	56,44	39,78	4 954	5 697
		0900				34	1530	900	3978	1996	1,35	81,26	56,10	6 615	7 607
11368	1620	0300	XXXX	YYYY	-0000	36	1620	300	1548	785	1,33	33,48	24,84	4 452	5 120
		0400				36	1620	400	2016	1012	1,35	42,48	30,60	4 688	5 391
		0500				36	1620	500	2484	1246	1,35	51,12	36,36	4 835	5 560
		0600				36	1620	600	2916	1463	1,35	59,76	42,12	5 235	6 020
		0900				36	1620	900	4212	2113	1,35	86,04	59,40	6 993	8 042
11368	1710	0300	XXXX	YYYY	-0000	38	1710	300	1634	828	1,33	35,34	26,22	4 689	5 392
		0400				38	1710	400	2128	1068	1,35	44,84	32,30	4 938	5 679
		0500				38	1710	500	2622	1316	1,35	53,96	38,38	5 093	5 857
		0600				38	1710	600	3078	1544	1,35	63,08	44,46	5 516	6 343
		0900				38	1710	900	4446	2231	1,35	90,82	62,70	7 371	8 477
11368	1800	0300	XXXX	YYYY	-0000	40	1800	300	1720	872	1,33	37,20	27,60	4 974	5 720
		0400				40	1800	400	2240	1124	1,35	47,20	34,00	5 236	6 021
		0500				40	1800	500	2760	1385	1,35	56,80	40,40	5 399	6 209
		0600				40	1800	600	3240	1626	1,35	66,40	46,80	5 844	6 721
		0900				40	1800	900	4680	2348	1,35	95,60	66,00	7 797	8 967

Zgodne z normą EN442-1: 2014:grzejniki i konwektory

ZAWIESIA ŚCIENNE WRAZ Z KORKIEM I ODPOWIETRZNIKIEM DOSTARCZANE SĄ W KOMPLECIE Z GRZEJNIKIEM

1. Konsolle zaciskowe dodawane są w kolorze grzejnika.
2. Uchwyty dystansowe dodawane są w korze w zależności od koloru grzejnika:
 - Białe RAL 9016 do grzejników w jasnych kolorach
 - Grafitowe RAL 7024 dla grzejników w ciemnych kolorach.

ZAWIESIA ŚCIENNE / KONSOLE PODŁOGOWE

OPCJONALNE



KONSOLA ZACISKOWA (nieregulowana) 30 mm



UCHWYT DYSTANSOWY

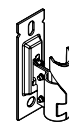

Odległość od ściany: 30 mm

wysokość (H mm)	2-kolumnowy / 3-kolumnowy / 4-kolumnowy		
	300 – 900		1500 – 2200
liczba rurek (n)	10 – 28	30 – 40	6 – 16
uchwyt dystansowy	2x	3x	2x

GRUPA PRODUKTÓW: ACC

KONSOLA STOJĄCA	WYSOKOŚĆ KONSOLI	KOLOR	NUMER KATALOGOWY	PLN
 <p>KONSOLA STOJĄCA</p> <ul style="list-style-type: none"> • Podłoga wykończona: wysokość konsoli = wysokość grzejnika kolumnowego + 150 mm • Podłoga surowa: wysokość konsoli = wysokość grzejnika kolumnowego + 300 mm • Konsolle można skrócić zgodnie z potrzebą 	RITMO POZIOMY			
	H = 450 mm	RAL 9016	118102000009016	177
		RAL 9005	118102000009005	232
	H = 550 mm	RAL 9016	1181021000009016	177
		RAL 9005	1181021000009005	232
	H = 600 mm	RAL 9016	1181022000009016	177
		RAL 9005	1181022000009005	232
	H = 650 mm	RAL 9016	1181023000009016	177
		RAL 9005	1181023000009005	232
	H = 750 mm	RAL 9016	1181024000009016	177
		RAL 9005	1181024000009005	232
	H = 850 mm	RAL 9016	1181025000009016	217
		RAL 9005	1181025000009005	285
	H = 900 mm	RAL 9016	1181026000009016	217
		RAL 9005	1181026000009005	285
	H = 1050 mm	RAL 9016	1181027000009016	217
	RAL 9005	1181027000009005	285	
H = 1200 mm	RAL 9016	1181028000009016	217	
	RAL 9005	1181028000009005	285	

ZESTAW NOŚNY DO KONSOLI STOJĄCEJ 60X10 mm



RITMO POZIOMY			
RAL 9016	1181029000009016		337
RAL 9005	1181029000009005		435

OSŁONA MASKUJĄCA KONSOLI PODŁOGOWEJ REGULOWANEJ – DO MONTAŻU NA PODŁODZE SUROWEJ

- 100 x 40 mm



RITMO POZIOMY			
RAL 9016	1181033000009016		11

OSŁONA MASKUJĄCA DO KONSOLI WOLNISTOJĄCEJ – DO MONTAŻU NA GOTOWYM PODŁOŻU

- 115 x 110 mm



RITMO POZIOMY			
RAL 9016	1181034000009016		21

Ceny netto PLN

wysokość (H mm)	2- / 3- / 4- kolumnowy	
	300 – 900	
liczba rurek (n)	10 – 26	28 – 40
ilość konsol	2x	3x

GRUPA PRODUKTÓW: ACC

KONSOLA PODŁOGOWA REGULOWANA H 200-230 mm	KOLOR	NUMER KATALOGOWY	PLN
<ul style="list-style-type: none"> • Wysokość: min. 200 mm, max. 230 mm • Teleskopowa konsola zalecana jest do montażu jako dodatkowe wzmocnienie grzejników pionowych w połączeniu z zawieszami ściennymi 	RAL 9016	1181030000009016	194
	RAL 9005	1181030000009005	254

OSŁONA MASKUJĄCA KONSOLI PODŁOGOWEJ REGULOWANEJ – DO MONTAŻU NA PODŁODZE SUROWEJ

- 70 x 40 mm



RITMO PIONOWY / RITMO POZIOMY			
RAL 9016	1181032000009016		11

OSŁONA MASKUJĄCA DO KONSOLI PODŁOGOWEJ REGULOWANEJ – DO MONTAŻU NA GOTOWYM PODŁOŻU

- 130 x 110 mm



RITMO PIONOWY / RITMO POZIOMY			
RAL 9016	1181031000009016		21

wysokość (H mm)	2-kolumnowy / 3-kolumnowy					4-kolumnowy				
	300 – 600		900 – 2000		2200	300 – 600		900 – 2000		2200
liczba rurek (n)	10 – 24	26 – 40	6 – 24	26 – 40	6 – 16	10 – 24	26 – 40	6 – 24	26 – 40	6 – 16
ilość konsol	2x	3x	2x	3x	2x	2x	3x	2x	3x	3x

AKCESORIA OPCJONALNE

GRUPA PRODUKTÓW: ACC

AKCESORIA	KOLOR	NUMER KATALOGOWY	PLN
GŁOWICA TERMOSTATYCZNA 	RITMO PIONOWY / RITMO POZIOMY		
	BIAŁY	11911630102	240
	CHROM	11911631102	318
ZAWÓR Z OSŁONKĄ PROSTĄ 	RITMO PIONOWY		
	BIAŁY	118200100009016	706
	INNE KOLORY	11820010000xxxx	810
	CHROM	118200100000099	810
	W KOLORZE GRZEJNIKA	11820010000xxxx	810
BŁOK PRZYŁĄCZENIOWY KĄTOWY 1/2" GZ / 3/4" GZ 	RITMO POZIOMY		
	CHROM	118230100000099	669

GRUPA PRODUKTÓW: LUXE ACC

AKCESORIA	KOLOR	NUMER KATALOGOWY	PLN
PORĘCZ NA RĘCZNIKI CHROM – 1000 mm 	RITMO PIONOWY / RITMO POZIOMY		
	CHROM	118326500000099	632

- b = 1000 mm (poręcz można przyciąć zgodnie z potrzebą inwestora)

Ceny netto PLN

PRZYŁĄCZA

RITMO: PIONOWY

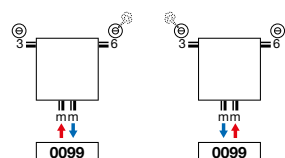

- Odpowietrznik w punkcie 3 lub 6.

RITMO: POZIOMY

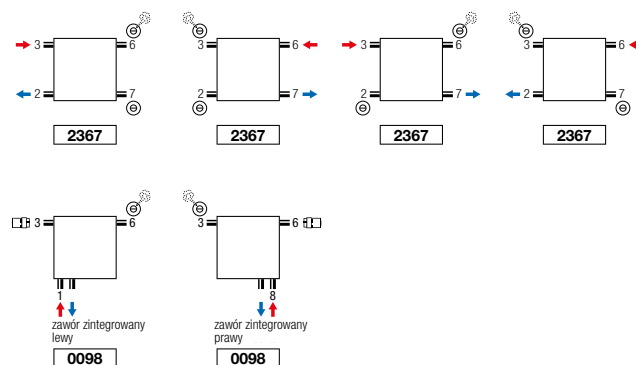

- Odpowietrznik w punkcie 3 lub 6.
- **PODŁĄCZENIE ZAWOROWE (0098) dopłata 378 zł**

RITMO PIONOWY

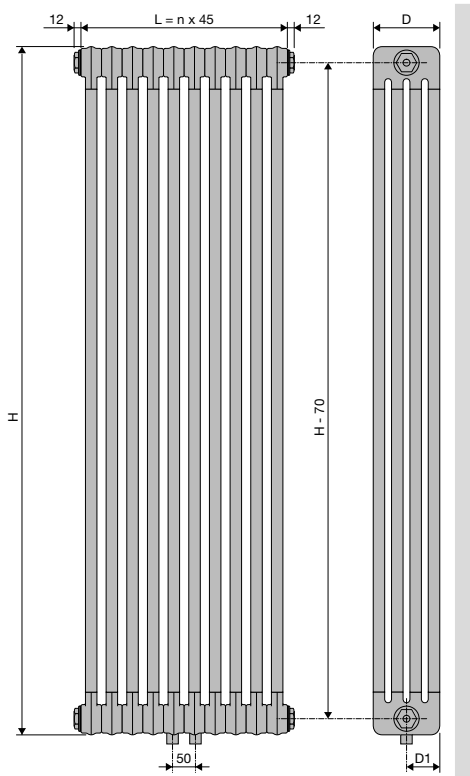

V-2K/65 / V-3K/105 / V-4K/145						
H	1500	1800	2000	2200		
Głębokość (D)	65	105	145			
D1	32,5	52,5	72,5			
Liczba rurek (n)	6	8	10	12	14	16



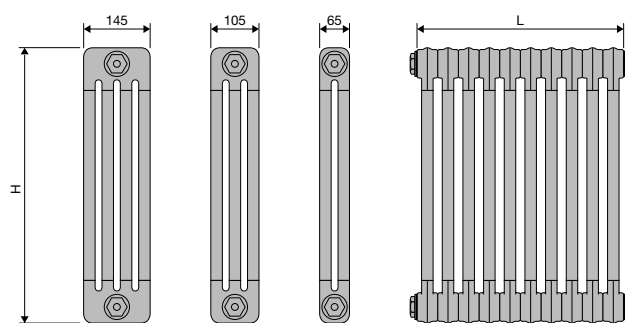
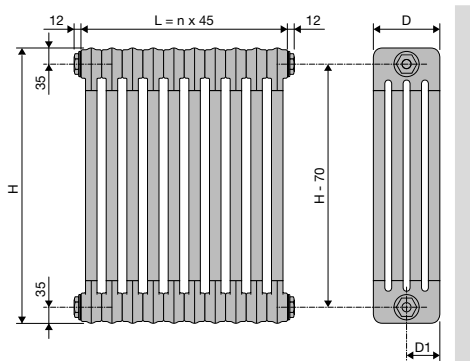
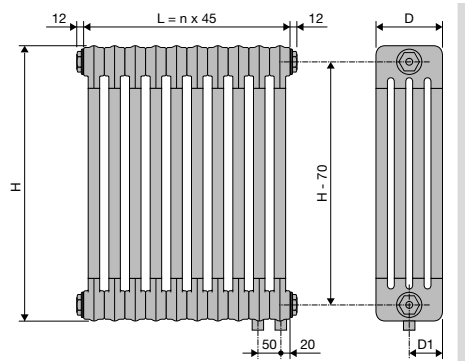
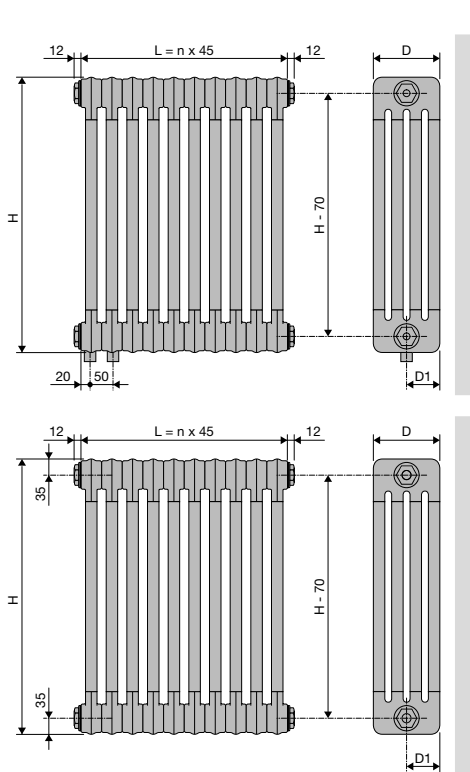





RITMO POZIOMY

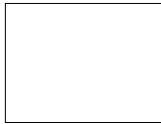

H-2K/65 / H-3K/105 / H-4K/145

H	300	400	500	600	900												
Głębokość (D)	65	105	145														
D1	32,5	52,5	72,5														
Liczba rurek (n)	10	12	14	16	18	20	22	24	26	28	30	32	34	36	38	40	



NOBLE	NEW	WHITE BLACK	NATURAL GREY MATT	PURE GREY MATT	METALLIC GREY STRUCTURE	BLUE GREEN MINERAL	TERRA COTTA MINERAL	UNI COLOURS FINE TEXTURE
								
Pergamon SAN 0019	Cream White RAL 9001	Sand Light N502	Signal White RAL 9003	Grey Aluminium M307	Mid Blue 9802	Dark Brown 9808	Melon Yellow 9815	
								
Pink 3012	Traffic White RAL 9016	Sand N503	Tele Grey 4 RAL 7047	Aluminium Grey January M302	Grey Blue 9803	Quarts Brown 9810	Carmine Red 9816	
								
Gold 9899	Pure White RAL 9010		Window Grey RAL 7040	Anthracite January M301	Forest Green 9804	Light Beige 9811		
								
	Jet Black RAL 9005		Tele Grey 2 RAL 7046			Orange Brown 9812		
								
			Blue Grey RAL 7031					
								
			Slate Grey RAL 7015					
								
			Anthracite Grey RAL 7016					

KOLOR STANDARDOWY

Kolorem standardowym, dostępnym w podstawowej cenie jest **BIAŁY RAL 9016** z gładkim wykończeniem.

KOLORY

Grzejniki dekoracyjne malowane są farbą proszkową na wybrany kolor według palety.

Cena za grzejniki malowane w innych kolorach niż standardowy jest wyższa o 15%.

Firma VASCO zastrzega możliwość wprowadzania zmian w dostępności kolorów.
Ze względu na technikę druku zaprezentowane kolory mogą różnić się od rzeczywistych.



9990

Lakier proszkowy
bezbardwy



VASCO Group Sp. z o.o.
ul. Jaworzyńska 295
59-220 Legnica, PL
tel. +48 536 906 059
e-mail: sprzedaz@vasco.eu
www.vasco.eu

Kruishoefstraat 50
B-3650 Dilsen, BELGIA
tel. +32 89 79 04 11
e-mail: info@vasco.eu
www.vasco.eu

www.arbonia.com
Grupa Arbonia
ARBONIA