

A woman with her hair in a bun, wearing a light blue jacket and dark pants, is sitting on a green sofa. She is reading a book. The room has large windows with sheer curtains, and a tray with a water bottle and glasses is on a table in front of her. The floor is light-colored wood.

Radiators

TECHNICAL PRICE GUIDE Export (BX) | April 2024



HOME OF SMART
CLIMATE SOLUTIONS

WWW.VASCO.EU

A smart indoor climate, that is what VASCO strives for. As a system brand within ARBONIA climate we actively develop future-proof **total solutions** to achieve the most energy-efficient and sustainable indoor climate with a combination of systems. From ventilation to cooling and heating, for all types of spaces and buildings. More than ever, VASCO marries comfortable and energy-efficient living.



VASCO Group nv (Head Office)

Kruishoefstraat 50, 3650 Dilsen | +32 (0)89 79 04 11 | info@vasco.eu | vasco.eu



Subtle, sleek, stylish: discover the Spike

VASCO Spike

Elegant design element and handy towel warmer in one? Especially for your bathroom or toilet, VASCO developed the Spike: an electric towel warmer from a single tube. Its discreet and clever design saves space but offers a wealth of comfort and appearance. A typical VASCO innovation, Spike provides that wonderfully dry and warm towel or bathrobe: an upgrade for your bathroom and your well-being.

Available soon.

vasco.eu

VASCO combines heating, ventilation & cooling to create your perfect indoor climate

More time than ever before is spent indoors and if the interior temperature is wrong, it can significantly affect your health and wellbeing. VASCO's high quality products help to create the perfect ambient temperature for your home or workplace whether it requires heating, ventilation or cooling.

VASCO commits to providing the user with the best possible heating comfort, in every environment and at any time. It wants to give the fitter optimal installation ease and offer the architect the most beautiful designs to work with. The result is a range of designer radiators that have been leaders in the market for forty years and is ready for the next forty years.



Thanks to VASCO Climate Control, you never overheat your home, but exactly enough for optimal indoor comfort. The new Climate Control system of VASCO lets you enter a world of unrivalled user comfort. From now on, your radiators, ventilation and underfloor heating will be connected to the Internet via a single interface. Thanks to the user-friendly app, you can always log in from anywhere for setting your optimal indoor comfort: room by room.



Content price guide

Bathroom radiators	
Oni	14
Iris-A	16
Agave-A	19
Aster-A	21
Bano	23
Carré Bathroom	27
Arche Bathroom	29
Zana Bathroom	31
Toilet radiators	106



Oni P. 14



Iris-A P. 16



Agave-A P. 19



Aster-A P. 21



Bano P. 23



Carré Bathroom P. 27



Arche Bathroom P. 29



Zana Bathroom P. 31

Electric radiators			
Pure electrical radiators			
Beams Mono-EL	54	E-Bano	70
Oni-EL	56	E-Panel	72
Niva-EL	58	Iris-A BL	77
Iris-A	60	Agave-A BL	78
Agave-A	62	Aster-A BL	79
Aster-A	64	Carré CB-EL-BL	80
Carré CB-EL	66	Niva-A BL	0
Zana ZBD-EL	68		
Mixed radiators			
Niva Mixed	90	Aster-A Mixed	93
Iris-A Mixed	92		



E-Volve P. 49



E-Bano P. 70



E-Panel P. 72



Blower P. 76

Aluminium radiators	
Beams	110
Bryce	115
Alu-Zen	120
Zaros	123



Beams P. 110



Bryce P. 115



Alu-Zen P. 120



Zaros P. 123

Steel radiators	
Niva	132
Niva Fan Coil Unit	144
Carré	154
Arche	172
Zana	179
Viola-A	192
Tulipa-A	226



Niva P. 132



Niva Fan Coil Unit P. 144



Carré P. 154



Arche P. 172



Zana P. 179



Viola-A P. 192



Tulipa-A P. 226

Panel radiators	
FlatLine	246
Flat-V-Line	252
Flat-Plint-Line	254



FlatLine P. 246



Flat-V-Line P. 252



Flat-Plint-Line P. 254

Plinth radiators	
Primula	264
Flat-Plint-Line	254



Primula P. 264



Flat-Plint-Line P. 254

Column radiators	
Vintage	292



Vintage P. 292

Technical	
Summary accessories	322
Summary valve sets	327
Summary stock radiators	330
Summary colours	321



**INNOVATION
DESIGN
SUSTAINABILITY
TECHNIQUE**

The technical standard that VASCO imposes when designing and developing designer radiators are exceptionally high as are the styling requirements. This has led to products and solutions that are unique and trendsetting on the market today.

VASCO was the first to use laser technology on a large scale in order to produce radiators without visible weld seams and as a result was at the birth of generations of successful designer radiators, some of which have evolved into real style icons.

Another patented technique by VASCO is that of smart centre connection. An application where the unique designer valve set is literally set up in no time and thanks to its central position and special design, forms a seamless connection with the radiator.

Design does not derive its value from itself but rather the degree in which it responds to the final objective: an optimal functionality, something VASCO also firmly believes in. Authenticity is the norm, even in the design of a radiator. It needs to be a credible, functional product with character. Stylish, beautiful and pure to look at, touch and experience.

Sustainability is also part of VASCO's ethos; the production of long term heating comfort with sustainable, eco-friendly systems, resources and materials is and continues to be the starting point.

With its aluminium radiators VASCO was the first to move towards a 100% sustainable product with the guarantee of optimum recycling without the loss of quality.

WARRANTY

VASCO offers a factory warranty of **10 years for water resistance and 10 years for the varnish**, where the radiators are used in normal conditions and with a hot water heating system. General sales conditions: www.vasco.eu.

For the VASCO accessories and electrical components in combination with VASCO radiators a **warranty is valid for 2 years**.

VASCO is also ISO 9001 and ISO 14001 certified and as such guarantees a constant care system for quality and the environment.

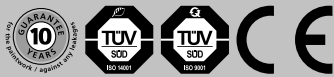

Finally, all our products comply with the new stricter European building regulation that came into force on 1 July 2013. All our radiators are therefore CE marked. A Declaration of Performance (DoP) is available for all individual products at www.vasco.eu.

EURONORM **EN 442**

75/65/20°C (ϕ 50K) =
75°C supply
65°C return
20°C room temperature

90/70/20°C (ϕ 60K) =
90°C supply
70°C return
20°C room temperature

55/45/20°C (ϕ 30K) =
55°C supply
45°C return
20°C room temperature



Consult the online digital price list at vasco.eu for the most up-to-date information at all times.

Prices in Euro (excl. VAT)

General sales conditions: www.vasco.eu. VASCO cannot be held responsible for possible printing errors and modifications of the programme.

DESIGN AWARDS

VASCO radiators are always designed by top designers, so you can be sure to get a unique, creative and exceptional product. The design is based on a long life span independent of fleeting trends or fashions.

Radiators are converted into the essence and passion of every interior; the reason why VASCO radiators have been awarded various renowned international prizes:



reddot design award



DOBRY WZÓR



DESIGN PLUS



DESIGNPREIS



EUROPEAN ALUMINIUM AWARD

FNAS D'OR



HENRY VAN DE VELDE

German Design Award



OVAM ECODESIGN



VASCO Group ETIM certified:
<http://www.etim-international.com>



not available outside the EU



5 year warranty on the radiator



10 year warranty on the radiator



2 year warranty on accessories



2 year warranty on valves



2 year warranty on electrical components



aluminium finish



100% recyclable



steel finish



free towel rail



free-standing installation



electric version



available in colour



new in 2024



the ideal 2-in-1 solution



ideal combined with a heat pump



for low water temperature systems



superbly quiet operation



with fan-regulation



with modulating fan-regulation



includes a copper/aluminium heat exchanger



energy-efficient operation



touch display with intuitive control



recoatible



manual control



VCC App control



domotics control



NOBLE

WHITE BLACK

NATURAL GREY
MATT

PURE GREY
MATT

METALLIC GREY
STRUCTURE



Pergamon
SAN 0019

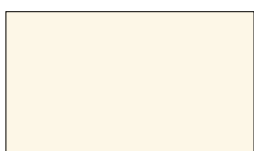

Cream White
RAL 9001



Mist White
N500



Signal White
RAL 9003



Grey Aluminium
M307

0019

9001

0500

9003

0307

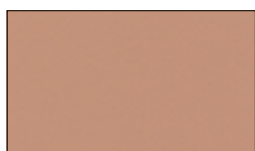

Pink
3012

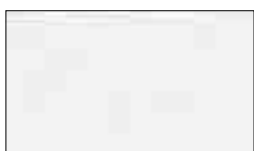

White Fine Texture
S600

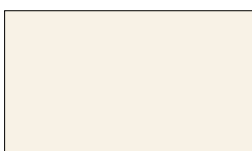

Sand Light
N502

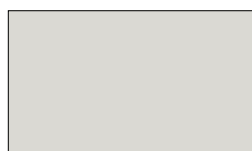

Tele Grey 4
RAL 7047

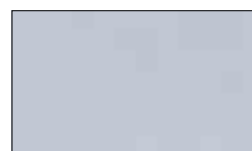

White Aluminium
M306

3012

0600

0502

7047

0306



Silver
9898

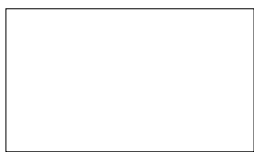

Traffic White
RAL 9016



Sand
N503

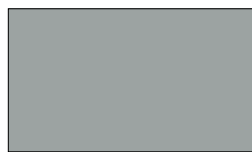

Window Grey
RAL 7040

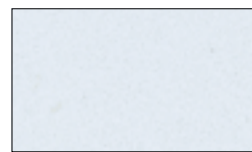

Grey White January
M303

9898

9016

0503

7040

0303

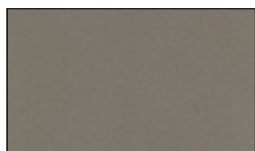

Pearl Beige
1035



Pure White
RAL 9010



Platina Grey
N504



Tele Grey 2
RAL 7046

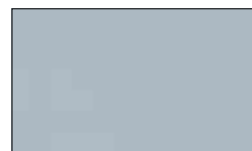

Aluminium Grey January
M302

1035

9010

0504

7046

0302



Gold
9899



Brown Black
9826



Dust Grey
N505



Blue Grey
RAL 7031



Anthracite January
M301

9899

9826

0505

7031

0301

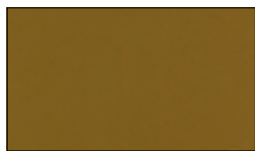

Curry
9894

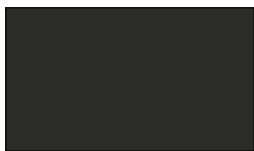

Grey Anthracite
9827

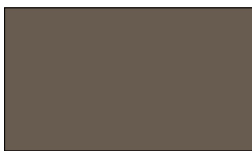

Warm Grey
N506

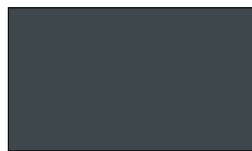

Slate Grey
RAL 7015

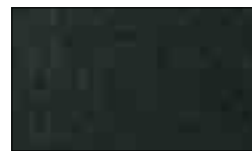

Black January
M300

9894

9827

0506

7015

0300

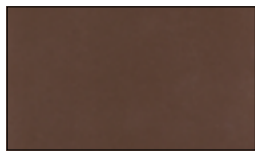

Bronze
9893



Jet Black (structure)
RAL 9005



Brown Grey
N507

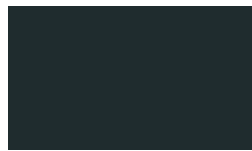

Anthracite Grey
RAL 7016



Brown January
M304

9893

9005

0507

7016

0304

BLUE GREEN
MINERAL

TERRA COTTA
MINERAL

UNI COLOURS
FINE TEXTURE



Dark Blue
9801

9801



Dark Brown
9808

9808

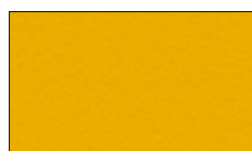

Melon Yellow
9815

9815



Mid Blue
9802

9802



Rust Brown
9809

9809



Carmine Red
9816

9816



Grey Blue
9803

9803



Quarts Brown
9810

9810



Claret Violet
9817

9817



Forest Green
9804

9804

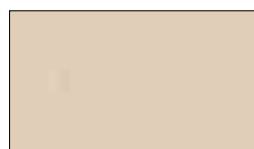

Light Beige
9811

9811



Night Blue
9818

9818



Jade Green
9805

9805



Orange Brown
9812

9812

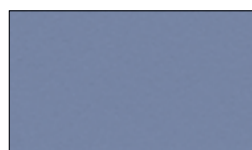

Pigeon Blue
S601

0601

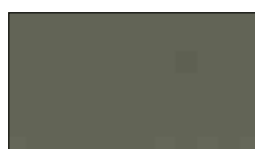

Grey Green
9806

9806



Blood Red
9813

9813



Yellow Green
9820

9820



Warm Green
9807

9807



Purple Red
9814

9814



Moss Green
9821

9821

COLOURS

A cataphoretic primer (as in the car industry) and a final finish of electrostatic applied epoxy polyester coating guarantee a perfect finish in various **contemporary colours and textures**.

VASCO radiators are standard available in RAL 9016 (Traffic white) and/or S600 (traffic white with structure). **S600** is offered as standard for all aluminium radiators, FlatLine collection, Vintage and for Niva. **RAL 9016** is offered as standard for all other radiators. **FlatLine collection** only available in S600.

The price for colour = standard price + 15% (also supplement of + 15% for S600 with the exception of the radiators mentioned above). To select the right order code, enter colour code (YYYY) when placing the order.

CUSTOM COLOURS

We are able to manufacture products in any colour on request. If you have any specific project needs or would like to enquire about availability, please contact: www.vasco.eu.

The colours shown are indicative. Subsequent changes to the colour range are possible. Please contact www.vasco.eu for an exact update.

Bathroom radiators



For years VASCO has paid particular attention to **heating of 'the intimate space'**, with radiators that tangibly and visibly contribute to a pleasant atmosphere. From practical ladder models in all designs and sizes to slim space saving designer radiators that make you feel warm just by looking at them.

VASCO bathroom radiators increase the feeling of wellness in the bathroom with smart targeted solutions and accessories. Even the smallest details are dedicated to optimal comfort and a beautiful timeless look. Connection and fastening systems are well thought out and efficiently integrated into the design. Drying and stacking shelves, towel rails and operating buttons also form a homogenous whole in the design.

Bathroom radiators

Oni	14
Iris-A	16
Agave-A	19
Aster-A	21
Bano	23
Carré Bathroom	27
Arche Bathroom	29
Zana Bathroom	31

ONI (O-P, O-NP)



VASCO

TYPES

- O-P: with one (1400 mm) or two (1800/2000 mm) cut-outs for hanging towels
- O-NP: without cut-outs

COLOURS

- Standard colour S600 (fine texture white) (RAL 9016: no extra charge 15%)
- Extensive colour chart see p. 10

SPECIAL

- A copper heating tube is integrated into the ultra-thin aluminium front plate.

BRACKETS

- Wall brackets standard

TECHNICAL

- The pathway for the heating tube is milled out to 2 mm below the surface. The tube is then pressed into the aluminium plate.
- KTL priming coat, powder coating
- Standard operating pressure: 6 bar
- Maximum operating temperature: 110°C

ELECTRICAL (available versions: see chapter electrical radiators)

- ✓ Pure electrical radiator prefilled (see p. 56)
- ✗ Mixed radiator

TECHNICAL DRAWINGS

- See p. 37

CONNECTION

- ✗ One-point connection for one-pipe system
- ✗ One-point connection for two-pipe system
- ✓ Two-point connection for one-pipe system (connection by way of the central connection) (see p. 312)
- ✓ Two-point connection for two-pipe system (standard) (see p. 312)
- ✗ Integrated valve
- Connections: ½" (inner thread)

ONI

Simplicity and efficiency combined in the absolute essence, free of any superfluity

The timeless Oni combines clean and sober design with unsurpassed user-friendliness. With its gently rounded corners and slender heating surface, it elicits admiration in every interior. The Oni is available in virtually all VASCO colours and thus easily matches every setting.

RECOMMENDED CONNECTION (0066)

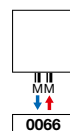

Other connection methods, see p. 36

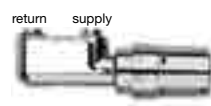

ref. nr. 1182 103 0000 0099

price € 218

Fittings, see p. 327

RECOMMENDED FOR BATHROOM AND KITCHEN (O-NP) IN OPTION



towel rail MULTI+ right (S600)

ref. nr. see p. 34

price €204

towel rail MULTI+ right (RAL 9005)

ref. nr. see p. 34

price €204

Other accessories, see p. 34



HOW TO ORDER ONI

Delivery time 15 - 30 working days
(transport duration not included)

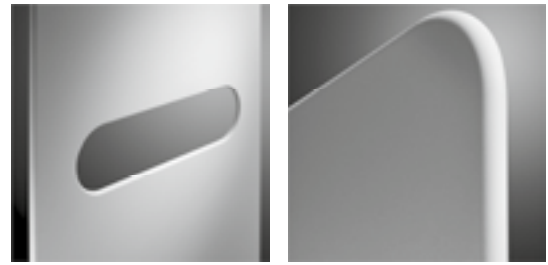
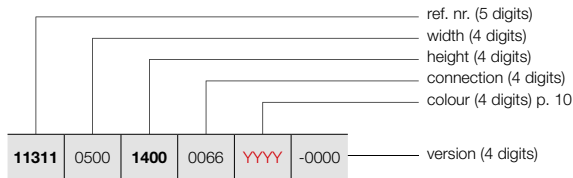

O-P

O-NP

HOW TO ORDER STOCK RADIATOR ONI

Delivery time 5 working days
(transport duration not included)

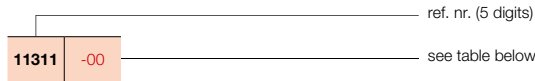

PRICE GROUP: VPG1 - BATHROOM RADIATORS

REFERENCE CODE CUSTOM MADE ONI	TECHNICAL DATA										STANDARD COLOUR		OTHER COLOURS				
	tubes	width (L mm)	height (H mm)	75/65/20 (Watt) (φ50K)	55/45/20 (Watt) (φ30K)	n-exp.	weight (kg)	water content (l)	electr. resistance (Watt)	price S600* (€)	short ref. nr. S600 stock	price colour (€)					
REF. NR. ONI O-P : 11311																	
11311	0500	1400	0066	YYYY	-0000	-	500	1400	573	307	1,22	16,30	0,35	-	1203	11311-01	1383
		1800				-	500	1800	795	420	1,25	20,85	0,45	-	1360	11311-02	1564
		2000				-	500	2000	815	430	1,25	22,95	0,60	-	1436	11311-03	1651
REF. NR. ONI O-NP : 11312																	
11312	0500	1400	0066	YYYY	-0000	-	500	1400	573	307	1,22	16,30	0,35	-	1112	11312-01	1279
		1800				-	500	1800	795	420	1,25	20,85	0,45	-	1267	11312-02	1457
		2000				-	500	2000	815	430	1,25	22,95	0,60	-	1344	11312-03	1546

In conformity with EN442-1: 2014: radiators and convectors

* RAL 9016: no extra charge 15%

For heat outputs in other regimes, see p. 320 (correction factors)

EXPORT. Prices in Euro (excl. VAT)

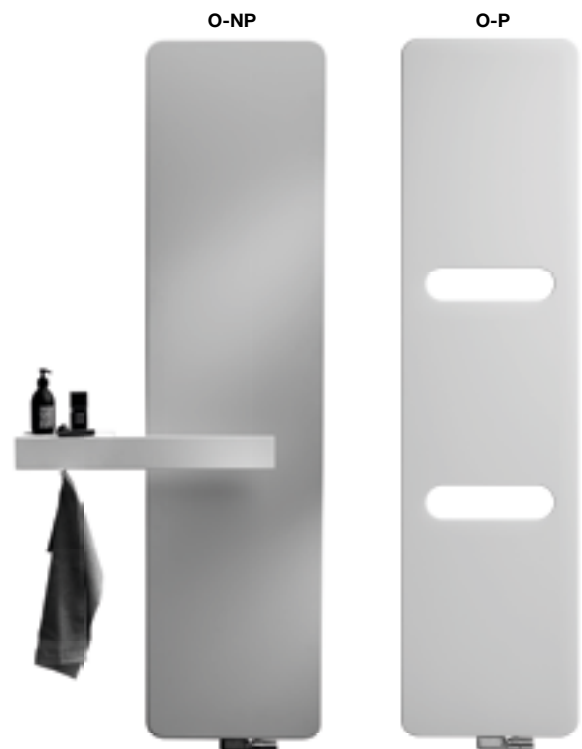

IRIS-A (HDM-A, HDRM-A)

NEW

TYPES

- Straight (HDM-A) and curved (HDRM-A)

TUBES

- Horizontal, round Ø 20 mm

COLLECTORS

- Vertical, D-profile 40 x 32 mm

COLOURS

- Standard colour white RAL 9016
- Extensive colour chart see p. 10

SPECIAL

- The horizontal tubes of type HDRM-A are slightly bent (10°).

BRACKETS

- Wall brackets in the colour of the radiator standard (included in packaging of radiator)
- Mounting set available for HDM-A free-standing installation (see p. 33), not suitable for connection 45 and 54

TECHNICAL

- Soldered (invisible soldered seams)
- ATL priming coat, powder coating
- Standard operating pressure: 10 bar
- Maximum operating temperature: 110°C

ELECTRICAL (available versions: see chapter electrical radiators)

- ✓ Pure electrical radiator prefilled (see p. 60)
- ✓ Mixed radiator (see p. 92)

TECHNICAL DRAWINGS

- See p. 38

CONNECTION

- ✗ One-point connection for one-pipe system
- ✗ One-point connection for two-pipe system
- ✓ Two-point connection for one-pipe system (connection by way of the central connection) (see p. 312)
- ✓ Two-point connection for two-pipe system (standard) (see p. 312)
- ✗ Integrated valve
- Connections: ½" (inner thread)
- For connection from above, a special flow tube is pre-assembled in the right-hand collector pipe - for return on the right.
- For return on the left, the flow tube must be manually changed to the left side.
- Connection from above must be ordered as a separate radiator.



IRIS-A

Design, power and sustainability in one compact model

The basic model for bathroom radiators for many years. The seamless connection between the vertical D profile and horizontal tubes ensures a homogenous structure wherein everything is correct. The Iris-A also guarantees a trouble-free assembly thanks to the smart centre connection. A radiator that is perfectly finished with a superior comfort for many years.

CONNECTION (1188)

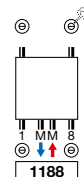

Other connection methods, see p. 36



ref. nr. 1182 103 0000 9016

price €195

Fittings, see p. 327

INCLUDED FREE OF CHARGE



standard, folding chrome plated drying and stacking rack



HDM-A

HOW TO ORDER IRIS-A

Delivery time 15 - 30 working days
(transport duration not included)

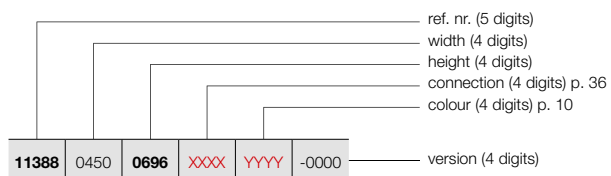

FREE-STANDING INSTALLATION (HDM-A)

See p. 33 for additional accessories.

HOW TO ORDER STOCK RADIATOR IRIS-A

Delivery time 5 working days
(transport duration not included)

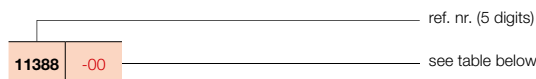

IRIS-A (HDM-A)



HDM-A

PRICE GROUP VPG1 - BATHROOM RADIATORS

REFERENCE CODE CUSTOM MADE IRIS-A	TECHNICAL DATA									STANDARD COLOUR		OTHER COLOURS price colour (€)					
	tubes	width (L mm)	height (H mm)	75/65/20 (Watt) (φ50K)	55/45/20 (Watt) (φ30K)	n-exp.	weight (kg)	water content (l)	electr. resistance (Watt)	price RAL 9016 (€)	short ref. nr. RAL 9016 stock						
REF. NR. IRIS-A HDM-A : 11388																	
11388	0450	0696	XXXX	YYYY	-0000	18	450	696	335	177	1,23	5,14	3,14	300	435	-	500
		1104				28	450	1104	511	268	1,25	7,84	4,87	500	544	11388-01	626
		1308				34	450	1308	600	314	1,25	9,40	5,90	500	658	11388-02	757
		1682				43	450	1682	764	400	1,25	11,82	7,55	750	724	11388-03	833
11388	0500	0696	XXXX	YYYY	-0000	18	500	696	369	195	1,23	5,52	3,38	300	446	11388-04	513
		1104				28	500	1104	563	296	1,25	8,40	5,24	500	564	11388-05	649
		1308				34	500	1308	661	346	1,25	10,11	6,36	750	676	11388-06	777
		1682				43	500	1682	842	440	1,25	12,72	8,13	750	747	11388-07	859
11388	0600	0696	XXXX	YYYY	-0000	18	600	696	436	230	1,23	6,27	3,85	500	467	11388-08	537
		1104				28	600	1104	666	349	1,25	9,52	5,99	750	596	11388-09	685
		1308				34	600	1308	782	409	1,26	11,52	7,29	750	711	11388-10	818
		1682				43	600	1682	996	521	1,25	14,51	9,29	1000	788	11388-11	906
		1954				51	600	1954	1154	606	1,25	17,25	10,90	1250	899	11388-12	1034
11388	0750	0696	XXXX	YYYY	-0000	18	750	696	535	282	1,24	7,41	4,57	500	499	-	574
		1104				28	750	1104	818	429	1,25	11,20	7,08	750	636	-	731
		1308				34	750	1308	960	501	1,26	13,64	8,67	1000	764	11388-13	879
		1682				43	750	1682	1222	639	1,26	17,19	11,02	1250	856	11388-14	984
		1954				51	750	1954	1417	743	1,25	20,35	12,90	1500	976	11388-15	1122
11388	0900	0696	XXXX	YYYY	-0000	18	900	696	633	334	1,24	8,54	5,28	500	534	-	614
		1104				28	900	1104	967	506	1,25	13,20	8,20	1000	680	-	782
		1308				34	900	1308	1135	592	1,26	15,76	10,06	1250	816	-	938
		1682				43	900	1682	1445	755	1,26	19,88	12,76	1500	923	11388-16	1061
		1954				51	900	1954	1675	878	1,25	23,44	14,90	1500	1053	11388-17	1211

In conformity with EN442-1: 2014: radiators and convectors

For heat outputs in other regimes, see p. 320 (correction factors)
EXPORT. Prices in Euro (excl. VAT)

IRIS-A (HDRM-A)

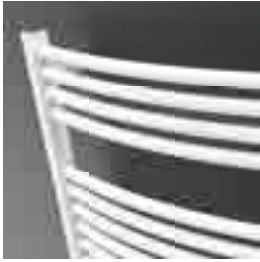

HDRM-A

HOW TO ORDER IRIS-A

Delivery time 15 - 30 working days
(transport duration not included)

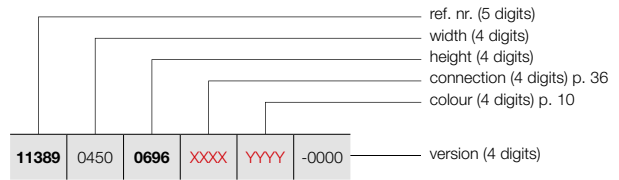

HOW TO ORDER STOCK RADIATOR IRIS-A

Delivery time 5 working days
(transport duration not included)

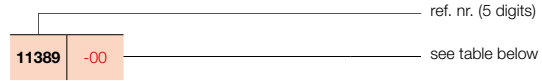

PRICE GROUP VPG1 - BATHROOM RADIATORS

REFERENCE CODE CUSTOM MADE IRIS-A	TECHNICAL DATA										STANDARD COLOUR		OTHER COLOURS price colour (€)				
	tubes	width (L mm)	height (H mm)	75/65/20 (Watt) (Φ50K)	55/45/20 (Watt) (Φ30K)	n-exp.	weight (kg)	water content (l)	electr. resistance (Watt)	price RAL 9016 (€)	short ref. nr. RAL 9016 stock						
REF. NR. IRIS-A HDRM-A : 11389																	
11389	0450	0696	XXXX	YYYY	-0000	18	450	696	335	177	1,23	5,14	3,14	300	475	-	546
		1104				28	450	1104	511	268	1,25	7,84	4,87	500	602	-	692
		1308				34	450	1308	600	314	1,25	9,40	5,90	500	720	-	828
		1682				43	450	1682	764	400	1,25	11,82	7,55	750	794	-	913
11389	0500	0696	XXXX	YYYY	-0000	18	500	696	369	195	1,23	5,52	3,38	300	490	-	564
		1104				28	500	1104	563	296	1,25	8,40	5,24	500	619	-	712
		1308				34	500	1308	661	346	1,25	10,11	6,36	750	745	-	857
		1682				43	500	1682	842	440	1,25	12,72	8,13	750	822	-	945
11389	0600	0696	XXXX	YYYY	-0000	18	600	696	436	230	1,23	6,27	3,85	500	514	-	591
		1104				28	600	1104	666	349	1,25	9,52	5,99	750	656	-	754
		1308				34	600	1308	782	409	1,26	11,52	7,29	750	784	-	902
		1682				43	600	1682	996	521	1,25	14,51	9,29	1000	866	11389-01	996
		1954				51	600	1954	1154	606	1,25	17,25	10,90	1250	989	-	1137
11389	0750	0696	XXXX	YYYY	-0000	18	750	696	535	282	1,24	7,41	4,57	500	550	-	633
		1104				28	750	1104	818	429	1,25	11,20	7,08	750	701	-	806
		1308				34	750	1308	960	501	1,26	13,64	8,67	1000	839	-	965
		1682				43	750	1682	1222	639	1,26	17,19	11,02	1250	940	-	1081
		1954				51	750	1954	1417	743	1,25	20,35	12,90	1500	1074	-	1235
11389	0900	0696	XXXX	YYYY	-0000	18	900	696	633	334	1,24	8,54	5,28	500	586	-	674
		1104				28	900	1104	967	506	1,25	13,20	8,20	1000	750	-	863
		1308				34	900	1308	1135	592	1,26	15,76	10,06	1250	897	-	1032
		1682				43	900	1682	1445	755	1,26	19,88	12,76	1500	1015	-	1167
		1954				51	900	1954	1675	878	1,25	23,44	14,90	1500	1157	-	1331

In conformity with EN442-1: 2014: radiators and convectors

For heat outputs in other regimes, see p. 320 (correction factors)
EXPORT. Prices in Euro (excl. VAT)



TYPES

- Straight (HRM-A)

TUBES

- Horizontal, round Ø 20 mm

COLLECTORS

- Vertical, rear, round Ø 28 mm

COLOURS

- Standard colour white RAL 9016
- Extensive colour chart see p. 10

BRACKETS

- Wall brackets in the colour of the radiator standard (included in packaging of radiator)

TECHNICAL

- Welded by means of resistance welding (invisible weld seams)
- ATL priming coat, powder coating
- Standard operating pressure: 10 bar
- Maximum operating temperature: 110°C

ELECTRICAL (available versions: see chapter electrical radiators)

- ✓ Pure electrical radiator prefilled (see p. 62)
- ✓ Mixed radiator (see p. 86)

TECHNICAL DRAWINGS

- See p. 38

CONNECTION

- ✗ One-point connection for one-pipe system
- ✗ One-point connection for two-pipe system
- ✓ Two-point connection for one-pipe system (connection by way of the central connection) (see p. 312)
- ✓ Two-point connection for two-pipe system (standard) (see p. 312)
- ✗ Integrated valve
- Connections: 1/2" (inner thread)
- For connection from above, a special flow tube is pre-assembled in the right-hand collector pipe - for return on the right.
- For return on the left, the flow tube must be manually changed to the left side.
- Connection from above must be ordered as a separate radiator.



VASCO

CONNECTION (1188)

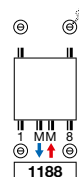

Other connection methods, see p. 36



ref. nr. 1182 103 0000 0099

price €218

Fittings, see p. 327

INCLUDED FREE OF CHARGE



standard, folding chrome plated drying and stacking rack

AGAVE-A

Sleek, sophisticated and graceful heat

Exceptionally slender tubes, combined to an elegant structure that continues to fascinate and charm because of its soft, rounded shapes. Accentuated by the horizontal tubes that lie above the vertical collectors. If bathroom comfort is synonymous with intimacy, then intimacy is synonymous with Agave-A. An absolute eye catcher, that contributes to the comfortable atmosphere that you expect from a contemporary bathroom.



AGAVE-A (HRM-A)

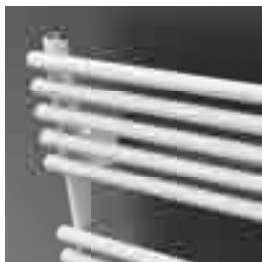

HRM-A

HOW TO ORDER AGAVE-A

Delivery time 15 - 30 working days
(transport duration not included)

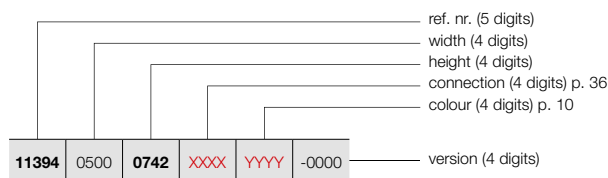

HOW TO ORDER STOCK RADIATOR AGAVE-A

Delivery time 5 working days
(transport duration not included)

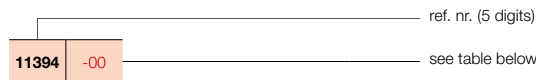

PRICE GROUP VPG1 - BATHROOM RADIATORS

REFERENCE CODE CUSTOM MADE AGAVE-A	TECHNICAL DATA										STANDARD COLOUR		OTHER COLOURS price colour (€)				
	tubes	width (L mm)	height (H mm)	75/65/20 (Watt) (Φ50K)	55/45/20 (Watt) (Φ30K)	n-exp.	weight (kg)	water content (l)	electr. resistance (Watt)	price RAL 9016 (€)	short ref. nr. RAL 9016 stock						
REF. NR. AGAVE-A HRM-A : 11394																	
11394	0500	0742	XXXX	YYYY	-0000												
		1171				20	500	742	434	235	1,19	7,40	3,10	500	537	-	618
		1501				29	500	1171	638	345	1,19	11,50	4,90	500	657	11394-01	756
		1798				37	500	1501	789	426	1,19	15,10	6,40	750	873	-	1004
						44	500	1798	921	493	1,21	17,80	7,50	1000	1034	11394-02	1189
11394	0600	0742	XXXX	YYYY	-0000												
		1171				20	600	742	519	279	1,20	8,60	3,60	500	566	-	651
		1501				29	600	1171	763	411	1,20	13,30	5,60	750	700	11394-03	805
		1798				37	600	1501	943	508	1,20	17,50	7,40	1000	932	-	1072
						44	600	1798	1102	591	1,21	20,60	8,70	1250	1108	11394-04	1274
11394	0750	0742	XXXX	YYYY	-0000												
		1171				20	750	742	646	344	1,22	10,30	4,30	500	608	-	699
		1501				29	750	1171	950	508	1,21	16,00	6,70	1000	756	-	869
		1798				37	750	1501	1175	630	1,21	21,00	8,90	1250	1022	-	1175
						44	750	1798	1372	738	1,20	24,70	10,40	1250	1191	11394-05	1370
11394	0900	0742	XXXX	YYYY	-0000												
		1171				20	900	742	773	408	1,24	12,00	5,10	500	618	-	711
		1501				29	900	1171	1137	604	1,23	18,70	7,90	1250	773	-	889
		1798				37	900	1501	1405	749	1,22	24,60	10,30	1500	1053	-	1211
						44	900	1798	1641	886	1,19	28,80	12,10	1500	1228	-	1412

In conformity with EN442-1: 2014: radiators and convectors

For heat outputs in other regimes, see p. 320 (correction factors)
EXPORT. Prices in Euro (excl. VAT)



TYPES

- HF-A: 1 row of tubes

TUBES

- Horizontal, flat-oval 57,5 x 10 mm

COLLECTORS

- Vertical, rear, round Ø 28 mm

COLOURS

- Standard colour white RAL 9016
- Extensive colour chart see p. 10

BRACKETS

- Wall brackets in the colour of the radiator standard (included in packaging of radiator)

TECHNICAL

- Welded by means of resistance welding (invisible weld seams)
- ATL priming coat, powder coating
- Standard operating pressure: 4 bar
- Maximum operating temperature: 110°C

ELECTRICAL (available versions: see chapter electrical radiators)

- ✓ Pure electrical radiator prefilled (see p. 64)
- ✓ Mixed radiator (see p. 93)

TECHNICAL DRAWINGS

- See p. 39

CONNECTION

- ✗ One-point connection for one-pipe system
- ✗ One-point connection for two-pipe system
- ✓ Two-point connection for one-pipe system (connection by way of the central connection) (see p. 312)
- ✓ Two-point connection for two-pipe system (standard) (see p. 312)
- ✗ Integrated valve
- Connections: 1/2" (inner thread)
- For connection from above, a special flow tube is pre-assembled in the right-hand collector pipe - for return on the right.
- For return on the left, the flow tube must be manually changed to the left side.
- Connection from above must be ordered as a separate radiator.



VASCO

CONNECTION (1188)

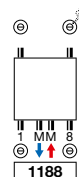

Other connection methods, see p. 36



ref. nr. 1182 103 0000 0099

price €218

Fittings, see p. 327

ASTER-A

Minimalism in service of a maximum comfort

The Aster-A gives minimalism a new dimension with its sleek, contemporary look and its quick, controlled heat output which immerses you in an atmosphere of tranquillity and well-being in no time.



ASTER-A (HF-A)

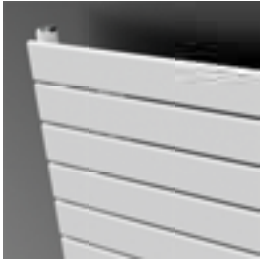

HF-A

HOW TO ORDER ASTER-A

Delivery time 15 - 30 working days
(transport duration not included)

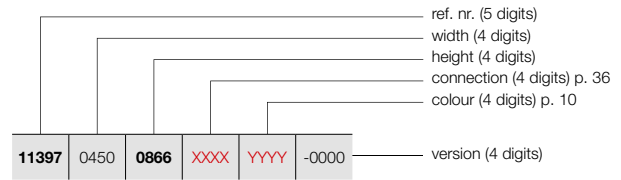

HOW TO ORDER STOCK RADIATOR ASTER-A

Delivery time 5 working days
(transport duration not included)

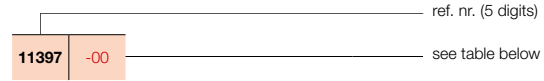

PRICE GROUP VPG1 - BATHROOM RADIATORS

REFERENCE CODE CUSTOM MADE ASTER-A	TECHNICAL DATA									STANDARD COLOUR		OTHER COLOURS price colour (€)					
	tubes	width (L mm)	height (H mm)	75/65/20 (Watt) (Φ50K)	55/45/20 (Watt) (Φ30K)	n-exp.	weight (kg)	water content (l)	electr. resistance (Watt)	price RAL 9016 (€)	short ref. nr. RAL 9016 stock						
REF. NR. ASTER-A HF-A : 11397																	
11397	0450	0866	XXXX	YYYY	-0000	12	450	866	390	209	1,20	10,20	3,00	300	579	-	666
		1169				16	450	1169	513	274	1,22	13,40	4,00	500	702	-	807
		1471				21	450	1471	634	336	1,23	17,60	5,30	500	785	11397-01	903
		1834				27	450	1834	780	410	1,24	21,80	6,50	750	865	11397-02	995
11397	0600	1169	XXXX	YYYY	-0000	16	600	1169	667	357	1,21	17,00	4,90	500	765	11397-03	880
		1471				21	600	1471	825	441	1,21	22,30	6,40	750	881	11397-04	1013
		1834				27	600	1834	1014	541	1,21	27,70	8,00	1000	994	11397-05	1143
11397	0700	1834	XXXX	YYYY	-0000	27	700	1834	1167	629	1,20	31,70	9,00	1250	1080	-	1242
11397	0800	1834	XXXX	YYYY	-0000	27	800	1834	1318	717	1,18	35,60	10,00	1250	1156	-	1329
		2137				31	800	2137	1523	832	1,17	41,00	11,40	1500	1356	-	1559

In conformity with EN442-1: 2014: radiators and convectors

For heat outputs in other regimes, see p. 320 (correction factors)
EXPORT. Prices in Euro (excl. VAT)

TYPES

- Straight (BM) and curved (BMR)

TUBES

- Horizontal, round Ø 22 mm

COLLECTORS

- Vertical, D-profile 34 x 34 mm

COLOURS

- Standard colour white RAL 9016
- Not available in other colours

SPECIAL

- The horizontal tubes of type BMR are slightly bent (10°).

BRACKETS

- Wall brackets standard

TECHNICAL

- Electrically laser welded (invisible weld seams)
- KTL priming coat, powder coating
- Standard operating pressure: 10 bar
- Maximum operating temperature: 110°C

ELECTRICAL (available versions: see chapter electrical radiators)

- ✓ Pure electrical radiator prefilled (see p. 70)
- ✓ Mixed radiator (see p. 86)

TECHNICAL DRAWINGS

- See p. 39

CONNECTION

- ✗ One-point connection for one-pipe system
- ✗ One-point connection for two-pipe system
- ✗ Two-point connection for one-pipe system (connection by way of the central connection)
- ✓ Two-point connection for two-pipe system (standard) (see p. 312)
- ✗ Integrated valve
- Connections: ½" (inner thread)



VASCO

RECOMMENDED CONNECTION (0018)

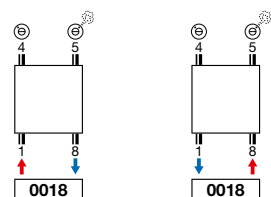

Other connection methods, see p. 36



ref. nr. 1182 101 0000 0099
price € 218
 Fittings, see p. 327

BANO

Stylish enjoyment in the warmest room

Are you looking for inspiring radiators for your new construction or renovation, which will make your home stand out without running over your building budget? Bano is the solution.



BANO (BM, BMR)



BM



BMR

HOW TO ORDER BANO

Delivery time 15 - 30 working days
(transport duration not included)

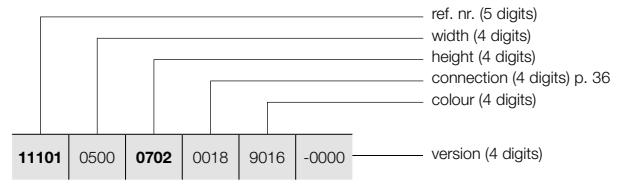

HOW TO ORDER STOCK RADIATOR BANO

Delivery time 5 working days
(transport duration not included)

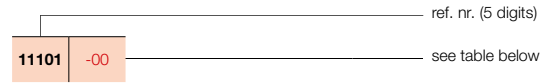

PRICE GROUP: VPG1 - BATHROOM RADIATORS

REFERENCE CODE CUSTOM MADE BANO	TECHNICAL DATA									STANDARD COLOUR
	tubes	width (L mm)	height (H mm)	75/65/20 (Watt) (φ50K)	55/45/20 (Watt) (φ30K)	n-exp.	weight (kg)	water content (l)	electr. resistance (Watt)	short ref. nr. RAL 9016 stock
REF. NR. BANO BM : 11101										
11101	0500	0702	0018	9016	-0000					
		1186								11101-13
		1714								11101-04
										11101-07
11101	0600	0702	0018	9016	-0000					
		1186								-
		1714								11101-08
										11101-09
REF. NR. BANO BMR : 11104										
11104	0500	0702	0018	9016	-0000					
		1186								-
		1714								-
										-
11104	0600	0702	0018	9016	-0000					
		1186								-
		1714								-
										11104-09

In conformity with EN442-1: 2014: radiators and convectors

For heat outputs in other regimes, see p. 320 (correction factors)
Prices on demand

TYPES

- Straight (BMmm) and curved (BMRmm)
- With central connection

TUBES

- Horizontal, round Ø 22 mm

COLLECTORS

- Vertical, D-profile 34 x 34 mm

COLOURS

- Standard colour white RAL 9016
- Not available in other colours

SPECIAL

- The horizontal tubes of type BMRmm are slightly bent (10°).

BRACKETS

- Wall brackets standard

TECHNICAL

- Electrically laser welded (invisible weld seams)
- KTL priming coat, powder coating
- Standard operating pressure: 10 bar
- Maximum operating temperature: 110°C

ELECTRICAL (available versions: see chapter electrical radiators)

- ✓ Pure electrical radiator prefilled (see p. 49)
- ✓ Mixed radiator (see p. 86)

TECHNICAL DRAWINGS

- See p. 40

CONNECTION

- ✗ One-point connection for one-pipe system
- ✗ One-point connection for two-pipe system
- ✓ Two-point connection for one-pipe system (connection by way of the central connection) (see p. 312)
- ✓ Two-point connection for two-pipe system (standard) (see p. 312)
- ✗ Integrated valve
- Connections: ½" (inner thread)



RECOMMENDED CONNECTION (1008)

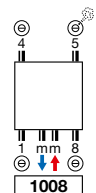

Other connection methods, see p. 36



ref. nr. 1182001 0000 9016
price € 129
 Fittings, see p. 327



ref. nr. 11911630102
price € 44

BANO WITH CENTRAL CONNECTION

Powerful eyecatcher

Bano offers the perfect solution for every room in the house, from bathroom to kitchen. Not standard heating elements, but stylish interior objects.



BANO WITH CENTRAL CONNECTION (BMmm, BMRmm)



BMmm



BMRmm

HOW TO ORDER BANO WITH CENTRAL CONNECTION

Delivery time 15 - 30 working days
(transport duration not included)

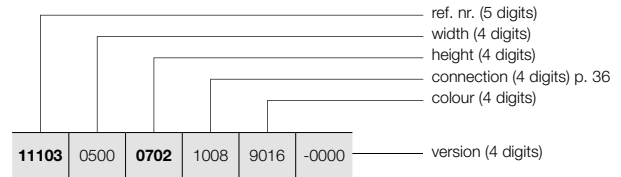

HOW TO ORDER STOCK RADIATOR BANO WITH CENTRAL CONNECTION

Delivery time 5 working days
(transport duration not included)

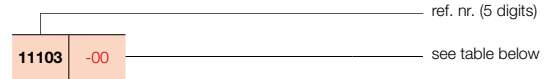

PRICE GROUP: VPG1 - BATHROOM RADIATORS

REFERENCE CODE CUSTOM MADE BANO WITH CENTRAL CONNECTION	TECHNICAL DATA									STANDARD COLOUR					
	tubes	width (L mm)	height (H mm)	75/65/20 (Watt) (ϕ 50K)	55/45/20 (Watt) (ϕ 30K)	n-exp.	weight (kg)	water content (l)	electr. resistance (Watt)	short ref. nr. RAL 9016 stock					
REF. NR. BANO WITH CENTRAL CONNECTION BMmm : 11103															
11103	0500	0702 1186 1714	1008	9016	-0000	15	500	702	347	185	1,22	4,90	3,43	300	11103-02
						25	500	1186	574	311	1,20	7,80	5,27	500	11103-03
						35	500	1714	823	439	1,23	11,10	7,51	750	11103-05
11103	0600	0702 1186 1714	1008	9016	-0000	15	600	702	409	218	1,22	5,50	3,89	300	11103-08
						25	600	1186	676	366	1,20	8,90	6,03	750	11103-04
						35	600	1714	970	520	1,22	12,60	8,59	1000	11103-06
REF. NR. BANO WITH CENTRAL CONNECTION BMRmm : 11105															
11105	0500	0702 1186 1714	1008	9016	-0000	15	500	702	347	185	1,22	6,45	3,43	300	-
						25	500	1186	574	311	1,20	10,72	5,27	500	-
						35	500	1714	823	439	1,23	15,33	7,51	750	-
11105	0600	0702 1186 1714	1008	9016	-0000	15	600	702	409	218	1,22	7,30	3,89	300	-
						25	600	1186	676	366	1,20	12,10	6,03	750	-
						35	600	1714	970	520	1,22	17,24	8,59	1000	11105-07

In conformity with EN442-1: 2014: radiators and convectors

For heat outputs in other regimes, see p. 320 (correction factors)
Prices on demand

TUBES

- Horizontal, square 25 x 25 mm

COLLECTORS

- Vertical, round Ø 35 mm

COLOURS

- Standard colour white RAL 9016
- Extensive colour chart see p. 10

BRACKETS

- Wall brackets in the colour RAL 9016 standard. Also in option available in the colour RAL 7016 (see p. 33).

TECHNICAL

- Welded by means of resistance welding robots (invisible weld seams)
- KTL priming coat, powder coating
- Standard operating pressure: 10 bar
- Maximum operating temperature: 110°C

ELECTRICAL (available versions: see chapter electrical radiators)

- ✓ Pure electrical radiator prefilled (see p. 66)
- ✓ Mixed radiator (see p. 86)

TECHNICAL DRAWINGS

- See p. 40

CONNECTION

- ✗ One-point connection for one-pipe system
- ✗ One-point connection for two-pipe system
- ✓ Two-point connection for one-pipe system (connection by way of the central connection) (see p. 312)
- ✓ Two-point connection for two-pipe system (standard) (see p. 312)
- ✗ Integrated valve
- Connections: ½" (inner thread)
- For connection at the top a special flow tube has to be ordered separately, which needs to be mounted in the return, see p. 314.



VASCO

RECOMMENDED CONNECTION (1188)

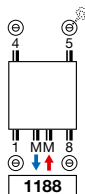

Other connection methods, see p. 36

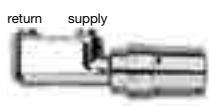

ref. nr. 1182 103 0000 0099

price € 218

Fittings, see p. 327

**RECOMMENDED FOR BATHROOM AND KITCHEN
IN OPTION**



towel rail straight (chrome)

ref. nr. see p. 34

price € 187

Other accessories, see p. 34

CARRÉ BATHROOM

A one piece bathroom radiator

The Carré Bathroom, now also with centre connection, continues to charm us by its pure, architectural design and its striking simplicity. Everything about this bathroom radiator is unique and unsurpassed: the perfect uniformity, the surprisingly high heat output and superior technicality. Because behind the automatic design hides a lot of technological ingenuity that is passed down to the smallest details.



CARRÉ BATHROOM (CB)



CB

HOW TO ORDER CARRÉ BATHROOM

Delivery time 15 - 30 working days
(transport duration not included)

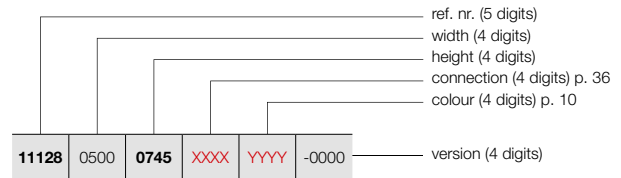

HOW TO ORDER STOCK RADIATOR CARRÉ BATHROOM

Delivery time 5 working days
(transport duration not included)

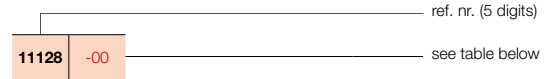

PRICE GROUP: VPG1 - BATHROOM RADIATORS

REFERENCE CODE CUSTOM MADE CARRÉ BATHROOM							TECHNICAL DATA					STANDARD COLOUR		OTHER COLOURS			
tubes	width (L mm)	height (H mm)	75/65/20 (Watt) (φ50K)	55/45/20 (Watt) (φ30K)	n-exp.	weight (kg)	water content (l)	electr. resistance (Watt)	price RAL 9016 (€)	short ref. nr. RAL 9016 stock	price colour (€)						
REF. NR. CARRÉ BATHROOM CB : 11128																	
11128	0500	0745	XXXX	YYYY	-0000	21	500	745	438	235	1,22	12,80	6,20	500	657	-	756
		1375				40	500	1375	747	399	1,23	22,95	11,80	750	998	11128-12	1148
		1735				50	500	1735	925	493	1,23	29,00	14,80	1000	1183	-	1360
11128	0600	0745	XXXX	YYYY	-0000	21	600	745	521	278	1,23	14,35	7,30	500	690	-	794
		1375				40	600	1375	886	473	1,23	27,35	13,90	1000	1051	-	1209
		1735				50	600	1735	1089	581	1,23	33,35	17,20	1250	1241	11128-24	1427

In conformity with EN442-1: 2014: radiators and convectors

For heat outputs in other regimes, see p. 320 (correction factors)
EXPORT. Prices in Euro (excl. VAT)

TUBES

- AB: Horizontal, rectangular 45 x 20 mm

COLOURS

- Standard colour white RAL 9016
- Extensive colour chart see p. 10

SPECIAL

- The Arche is awarded with the Design Plus Award 2005, Reddot Design Award 2006, Silver Award Designpreis Deutschland 2006 and nominated for the Henry van de Velde prize 2005.
- Radiator with spaces

BRACKETS

- Wall brackets standard (telescopic)

TECHNICAL

- KTL priming coat, powder coating
- Standard operating pressure: 4 bar
- Maximum operating temperature: 110°C

ELECTRICAL

- ✗ Pure electrical radiator prefilled
- ✗ Mixed radiator

TECHNICAL DRAWINGS

- See p. 41

CONNECTION

- ✗ One-point connection for one-pipe system
- ✗ One-point connection for two-pipe system
- ✓ Two-point connection for one-pipe system (connection by way of the central connection) (see p. 312)
- ✓ Two-point connection for two-pipe system (standard) (see p. 312)
- ✗ Integrated valve
- Connections: ½" (inner thread)



VASCO

RECOMMENDED CONNECTION (1188)

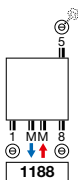

Other connection methods, see p. 36

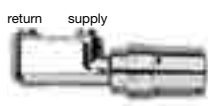

ref. nr. 1182 103 0000 0099
price € 218
 Fittings, see p. 327

**RECOMMENDED FOR BATHROOM AND KITCHEN
 IN OPTION**



hook (chrome)
 ref. nr. see p. 34
price € 87
Other accessories, see p. 34

ARCHE BATHROOM

Square, the most beautiful and most practical

A classic example of smart applied design, practical and easy to assemble thanks to the intelligent centre connection that connects the form and efficiency in a unique way. The sleek, soothing character enhances the wellness feeling. The customized heat release, the thoughtful accessories and the good relations with the low temperature system are all guarantees for a sustainable invention with a lasting return.



ARCHE BATHROOM (AB)



AB

HOW TO ORDER ARCHE BATHROOM

Delivery time 15 - 30 working days
(transport duration not included)

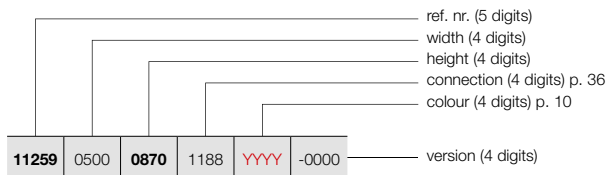

HOW TO ORDER STOCK RADIATOR ARCHE BATHROOM

Delivery time 5 working days
(transport duration not included)

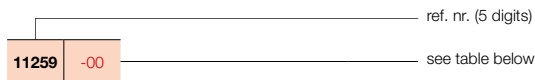

PRICE GROUP: VPG1 - BATHROOM RADIATORS

REFERENCE CODE CUSTOM MADE ARCHE BATHROOM							TECHNICAL DATA						STANDARD COLOUR		OTHER COLOURS		
tubes	width (L mm)	height (H mm)	75/65/20 (Watt (φ50K))	55/45/20 (Watt (φ30K))	n-exp.	weight (kg)	water content (l)	electr. resistance (Watt)	price RAL 9016 (€)	short ref. nr. RAL 9016 stock	price colour (€)						
REF. NR. ARCHE BATHROOM AB : 11259																	
11259	0500	0870	1188	YYY	-0000	16	500	870	502	264	1,26	12,20	6,55	-	738	-	849
		1470				28	500	1470	805	419	1,28	20,65	11,45	-	1048	11259-04	1205
		1870				36	500	1870	1022	531	1,28	25,65	14,15	-	1216	11259-02	1398
11259	0600	0870	1188	YYY	-0000	16	600	870	588	311	1,25	14,10	7,58	-	768	-	883
		1470				28	600	1470	942	487	1,29	24,03	13,35	-	1094	11259-05	1258
		1870				36	600	1870	1197	622	1,28	29,93	17,05	-	1269	11259-03	1459
11259	0700	0870	1188	YYY	-0000	16	700	870	672	357	1,24	16,00	8,60	-	786	-	904
		1470				28	700	1470	1077	557	1,29	27,40	15,25	-	1118	-	1286
		1870				36	700	1870	1368	711	1,28	34,20	19,95	-	1295	-	1489

In conformity with EN442-1: 2014: radiators and convectors

For heat outputs in other regimes, see p. 320 (correction factors)
EXPORT. Prices in Euro (excl. VAT)

TUBES

- Horizontal, rectangular 45 x 20 mm

COLLECTORS

- Vertical, rear, round Ø 35 mm

COLOURS

- Standard colour white RAL 9016
- Extensive colour chart see p. 10

BRACKETS

- Wall brackets in the colour RAL 9016 standard. Also in option available in the colour RAL 7016 (see p. 33).

TECHNICAL

- Electrically laser welded (invisible weld seams)
- KTL priming coat, powder coating
- Standard operating pressure: 4 bar
- Maximum operating temperature: 110°C

ELECTRICAL (available versions: see chapter electrical radiators)

- ✓ Pure electrical radiator prefilled (see p. 68)
- ✓ Mixed radiator (see p. 86)

TECHNICAL DRAWINGS

- See p. 41

CONNECTION

- ✗ One-point connection for one-pipe system
- ✗ One-point connection for two-pipe system
- ✓ Two-point connection for one-pipe system (connection by way of the central connection) (see p. 312)
- ✓ Two-point connection for two-pipe system (standard) (see p. 312)
- ✗ Integrated valve
- Connections: ½" (inner thread)
- For connection at the top a special flow tube has to be ordered separately, which needs to be mounted in the return, see p. 314.



VASCO

RECOMMENDED CONNECTION (1188)

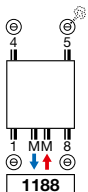

Other connection methods, see p. 36

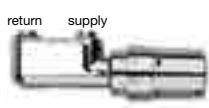

ref. nr. 1182 103 0000 0099
price € 218
 Fittings, see p. 327

RECOMMENDED FOR BATHROOM AND KITCHEN IN OPTION



towel rail straight (chrome)
 ref. nr. see p. 34
price € 187

Other accessories, see p. 34

ZANA BATHROOM

Heat in its purest form

The Zana Bathroom is a radiator concept that combines tradition and trends in an extremely pure design. A comfort solution that perfectly comes to its right in all respects thanks to the practical, integrated centre connection. The timeless, transparent structure and the refined design make the Zana Bathroom a desired object, also in smaller bathrooms.



ZANA BATHROOM (ZBD)



ZBD

HOW TO ORDER ZANA BATHROOM

Delivery time 15 - 30 working days
(transport duration not included)

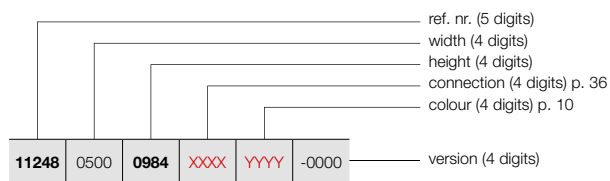

11248	0500	0984	XXXX	YYYY	-0000
-------	------	------	------	------	-------

PRICE GROUP: VPG1 - BATHROOM RADIATORS

REFERENCE CODE CUSTOM MADE ZANA BATHROOM							TECHNICAL DATA						STANDARD COLOUR	OTHER COLOURS		
tubes	width (L mm)	height (H mm)	75/65/20 (Watt) (φ50K)	55/45/20 (Watt) (φ30K)	n-exp.	weight (kg)	water content (l)	electr. resistance (Watt)	price RAL 9016 (€)	price colour (€)						
REF. NR. ZANA BATHROOM ZBD : 11248																
11248	0500	0984	XXXX	YYYY	-0000	21	500	984	658	360	1,18	19,35	8,80	500	859	988
		1504				32	500	1504	976	531	1,19	29,45	12,35	1000	1254	1442
		1824				40	500	1824	1189	647	1,19	35,67	14,53	1250	1548	1780
11248	0600	0984	XXXX	YYYY	-0000	21	600	984	788	436	1,16	22,10	10,40	750	902	1037
		1504				32	600	1504	1151	633	1,17	33,70	15,80	1250	1318	1516
		1824				40	600	1824	1383	757	1,18	40,84	19,12	1500	1637	1883

In conformity with EN442-1: 2014: radiators and convectors

For heat outputs in other regimes, see p. 320 (correction factors)
EXPORT. Prices in Euro (excl. VAT)

BATHROOM RADIATORS BRACKETS / FREE-STANDING INSTALLATION
IN OPTION

PRICE GROUP: VPG10 - ACC.







BRACKETS		COLOUR	REF. NR.	€
CB / ZBD				
WALL SETUP	4 brackets	RAL 7016	1187 007 0000 7016	41
FREE-STANDING INSTALLATION		COLOUR	REF. NR.	€
HDM-A				
MOUNTING SET		RAL 9016	11810410000	86
		COLOUR	11810410000C	99

EXPORT. Prices in Euro (excl. VAT)

BATHROOM RADIATORS ACCESSORIES

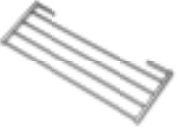
IN OPTION

PRICE GROUP: VPG10B - TOWEL RAILS

ACCESSORIES	WIDTH TOWEL RAIL	COLOUR	REF. NR.	€
O-NP				
TOWEL RAIL MULTI+ RIGHT 	600 mm	S600	1183 734 0000 0600	204
	600 mm	RAL 9005 ^S	1183 734 0000 9005	204
<ul style="list-style-type: none"> • h = 70 mm; b = 600 mm (b tablet = 194 mm); e = 176 mm; c = 170 mm; • Mounting on the wall, to the right of the radiator. 				
O-NP				
TOWEL RAIL MULTI+ LEFT 	600 mm	S600	1183 735 0000 0600	204
	600 mm	RAL 9005 ^S	1183 735 0000 9005	204
<ul style="list-style-type: none"> • h = 70 mm; b = 600 mm (b tablet = 194 mm); e = 176 mm; c = 170 mm; • Mounting on the wall, to the left of the radiator. 				
O-P / O-NP				
TOWEL RAIL 	372 mm	CHROME	1183 274 0000 0099	160
	372 mm	S600	1183 274 0000 0600	160
	372 mm	RAL 9005 ^M	1183 274 0000 9005	160
<ul style="list-style-type: none"> • h = 55 mm; b = 372 mm; d = 56 mm; a = 50 mm; 				
HDM-A / HDRM-A / HRM-A				
FOLDING DRYING AND STACKING RACK 		CHROME	1183 002 0000 0099	135
<ul style="list-style-type: none"> • Standard included with Iris-A, Agave-A. • 380 x 158 mm 				
CB				
SQUARE HOOK 		CHROME	1183 500 0000 0099	68
<ul style="list-style-type: none"> • h = 24 mm; b = 24 mm; d = 65 mm 				
CB				
TOWEL RAIL STRAIGHT 		CHROME	1183 207 0000 0099	187
<ul style="list-style-type: none"> • h = 24 mm; b = 720 mm (easy adjustable); d = 66 mm; a = 48 mm 				
AB / ZBD				
HOOK 		CHROME	1183 410 0000 0099	87
<ul style="list-style-type: none"> • h = 70 mm; b = 70 mm; d = 59 mm; a = 51 mm; 				
ZBD				
TOWEL RAIL STRAIGHT 		CHROME	1183 228 0000 0099	187
<ul style="list-style-type: none"> • h = 22 mm; b = 720 mm (easy adjustable); d = 75 mm; a = 56 mm 				



 structure black
 matt black

Mounting instructions accessories: see www.vasco.eu
 EXPORT. Prices in Euro (excl. VAT)

e = distance front of the accessory up to the wall
 d = distance front of the accessory up to front of the radiator
 c = distance between wall to back towel bar
 a = distance accessory up to the radiator
available from stock

BATHROOM RADIATORS ACCESSORIES
IN OPTION

PRICE GROUP: VPG10 - ACC.

ACCESSORIES		COLOUR	REF. NR.	€
THERMOSTATIC HEAD		BMmm / BMRmm		
		WHITE	11911630102	44
THERMOSTATIC HEAD		BMmm / BMRmm		
		CHROME	11911631102	63

Mounting instructions accessories: see www.vasco.eu
EXPORT. Prices in Euro (excl. VAT)

BATHROOM RADIATORS CONNECTIONS

ONI: O-P / O-NP

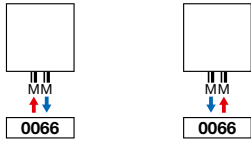

IRIS-A: HDM-A / HDRM-A / HDM-BL-MIX-A

AGAVE-A: HRM-A

ASTER-A: HF-A / HF-BL-MIX-A

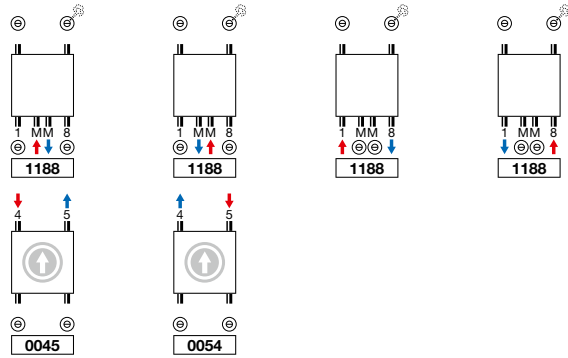

Ⓜ Connection from above must be ordered as a separate radiator (radiator height = height + 9 mm)

BANO: BM / BMR

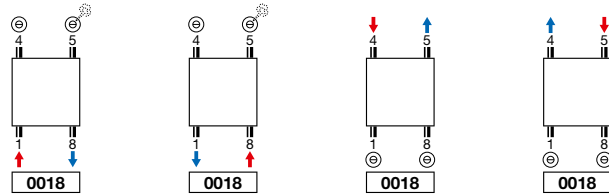

BANO with central connection: BMmm / BMRmm

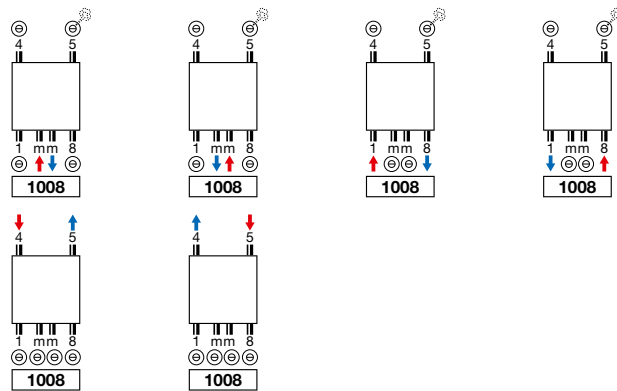

CARRÉ BATHROOM: CB (STOCK) / CB (NON STOCK)

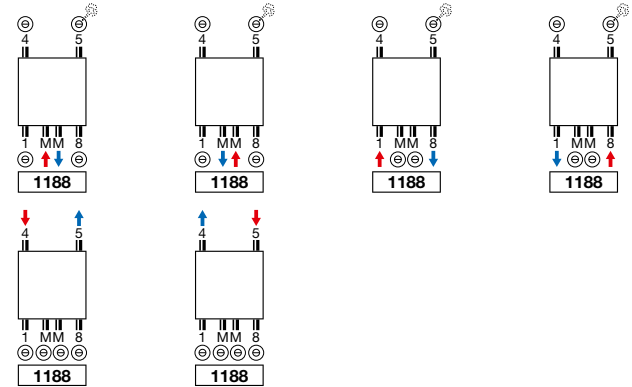

CARRÉ BATHROOM: CB (NON STOCK)

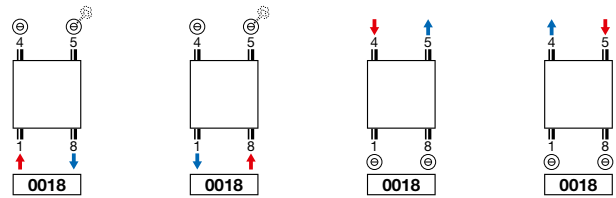

ARCHE BATHROOM: AB

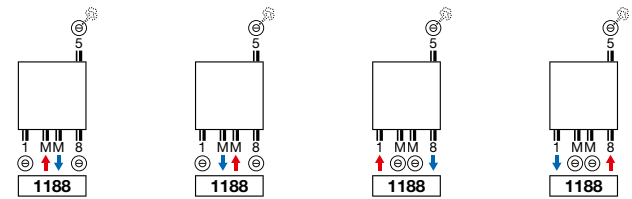

ZANA BATHROOM: ZBD

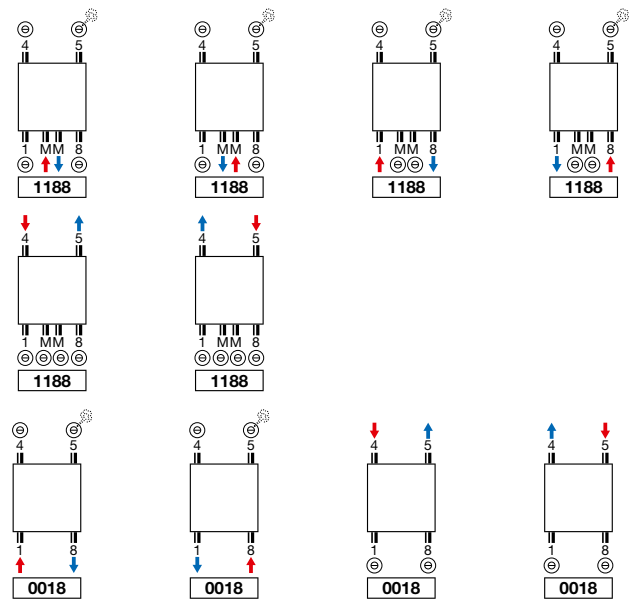

Attention: connecting the radiator can only be as shown by the connecting icons. For any other connection method, we take no responsibility.



ONI (O-P)

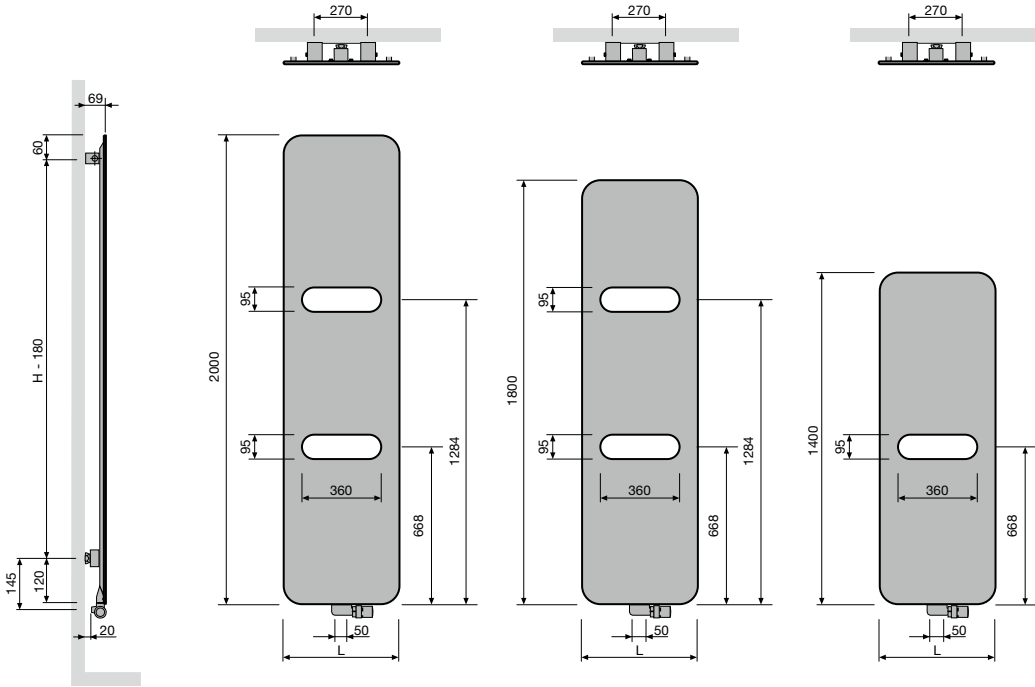

O-P
Centre between the connections 50
Centre between the brackets L-270

ONI (O-NP)

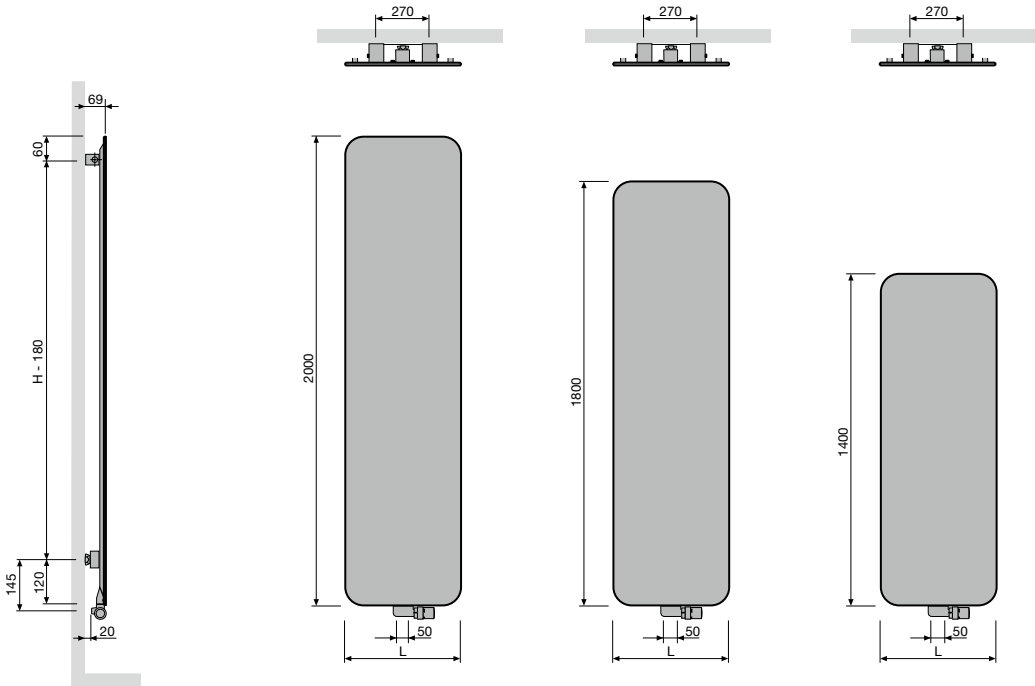

O-NP
Centre between the connections 50
Centre between the brackets L-270

IRIS-A (HDM-A, HDRM-A)

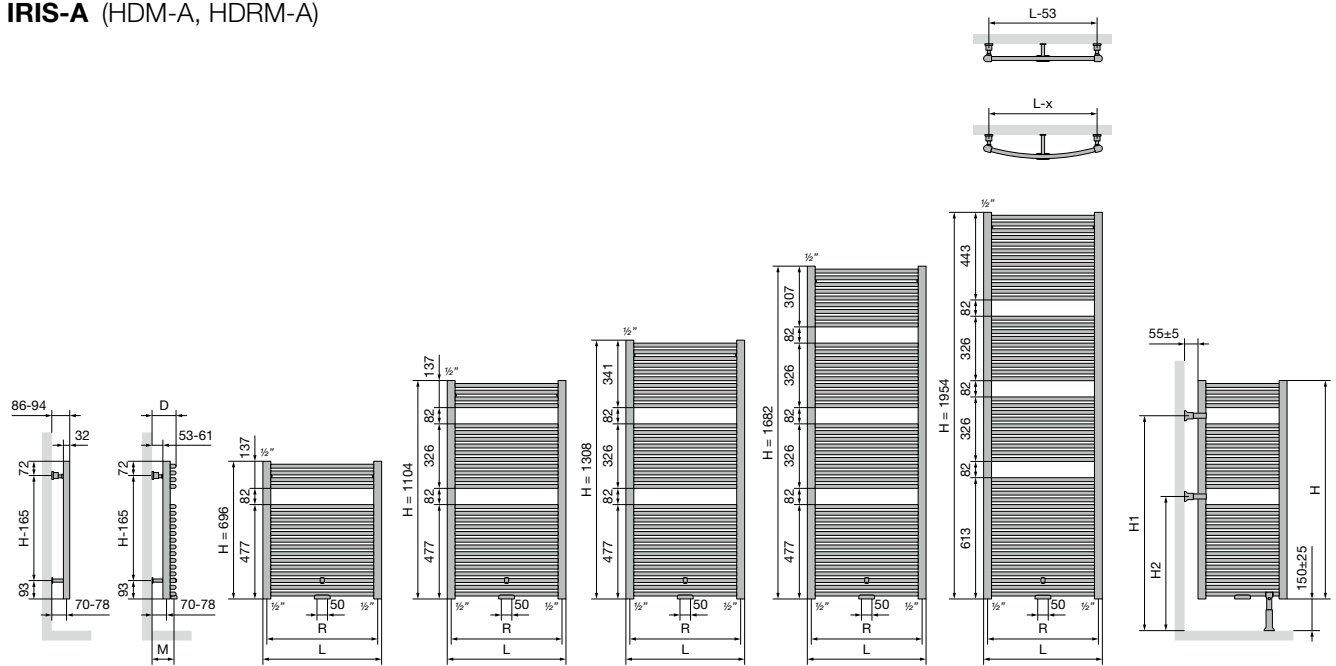

	HDM-A				
Width (L)	450	500	600	750	900
Centre between the connections at the bottom (R)	410	460	560	710	860
Centre between the brackets	L-53	H-165			

	FREE-STANDING HDM-A				
height (H)	696	1104	1308	1682	1954
H1	668	1076	1076	1484	1620
H2	396	668	668	668	804

	HDRM-A				
Width (L)	447	498	598	747	897
Centre between the connections at the bottom (R)	407	458	558	707	857
Distance between wall and middle of MM valve (M)	92-100	91-99	94-102	100-108	107-115
Distance between wall and front of the radiator (D)	102-110	101-109	104-112	110-118	117-125
Centre horizontal between the brackets	400	452	552	702	852
Centre vertical between the brackets	H-165				

AGAVE-A (HRM-A)

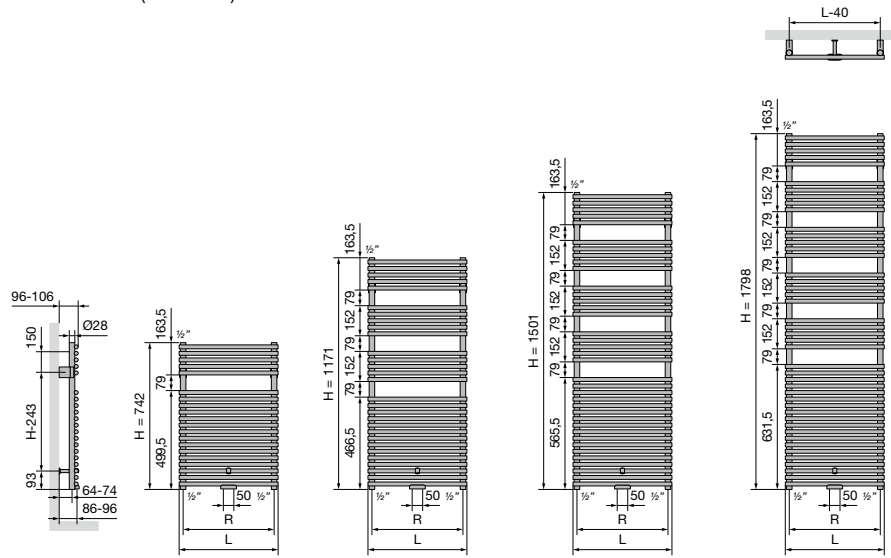

	HRM-A			
Width (L)	500	600	750	900
Centre between the connections at the bottom (R)	460	560	710	860
Centre between the brackets	L-40	H-243		



ASTER-A (HF-A)

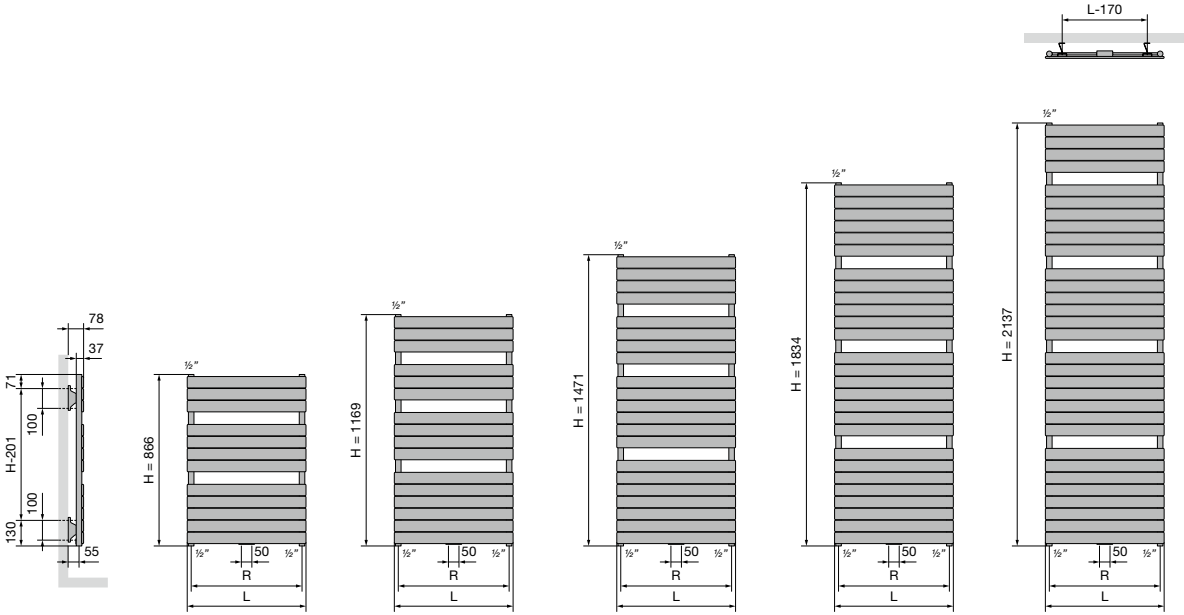

		HF-A			
	Width (L)	450	600	700	800
	Centre between the connections at the bottom 18 (R)	410	560	660	760
	Centre between the brackets	L-170	H-201		

BANO (BM, BMR)

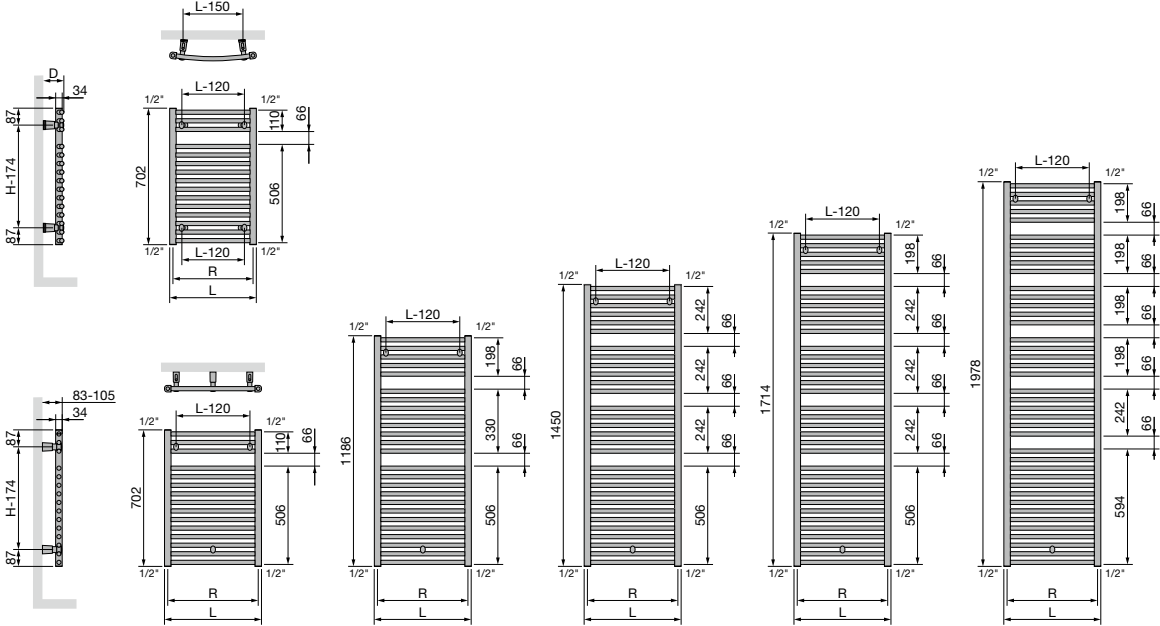

		BM				BMR				
	Width (L)	450	500	600	750	Width (L)	446	495	595	744
	Centre between the connections at the bottom 18 (R)	416	466	566	716	Centre between the connections at the bottom 18 (R)	412	461	561	710
	Centre between the brackets	L-120	H-174			Distance between wall and front of the radiator (D)	88-108	89-109	95-115	105-125
						Centre between the brackets	L-150	H-174		

BANO with central connection (BMmm, BMRmm)

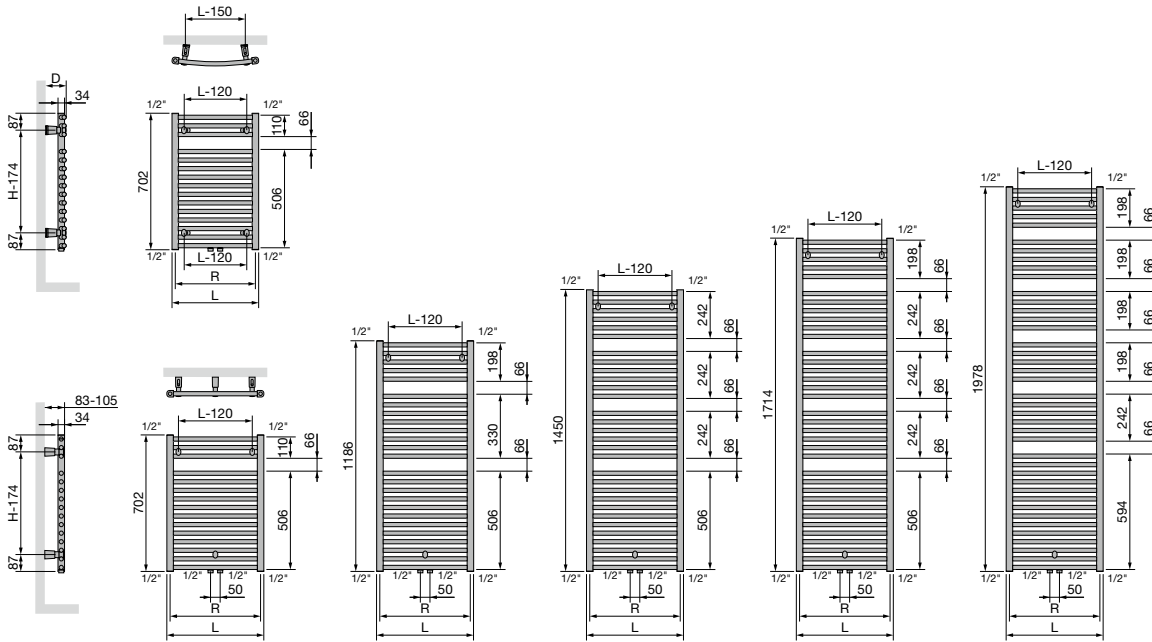

		BMmm				
Width (L)		450	500	600	750	
Centre between the connections at the bottom (R)		416	466	566	716	
Centre between the brackets		L-120	H-174			

		BMRmm				
Width (L)		446	495	595	744	
Centre between the connections at the bottom (R)		412	461	561	710	
Distance between wall and front of the radiator (D)		88-108	89-109	95-115	105-125	
Centre between the brackets		L-150	H-174			

CARRÉ BATHROOM (CB)

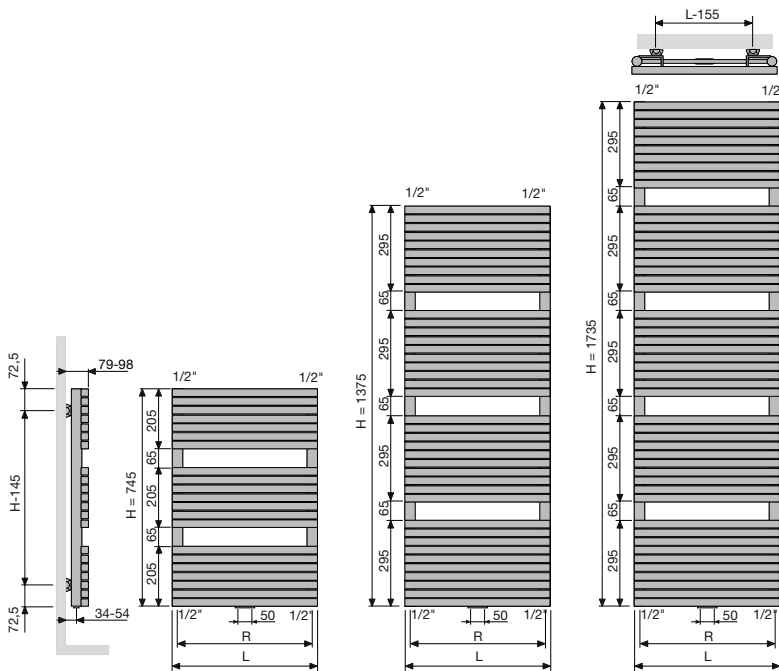

		CB	
Width (L)		500	600
Centre between the connections at the bottom (R)		465	565
Centre between the brackets		L-155	H-145



ARCHE BATHROOM (AB)

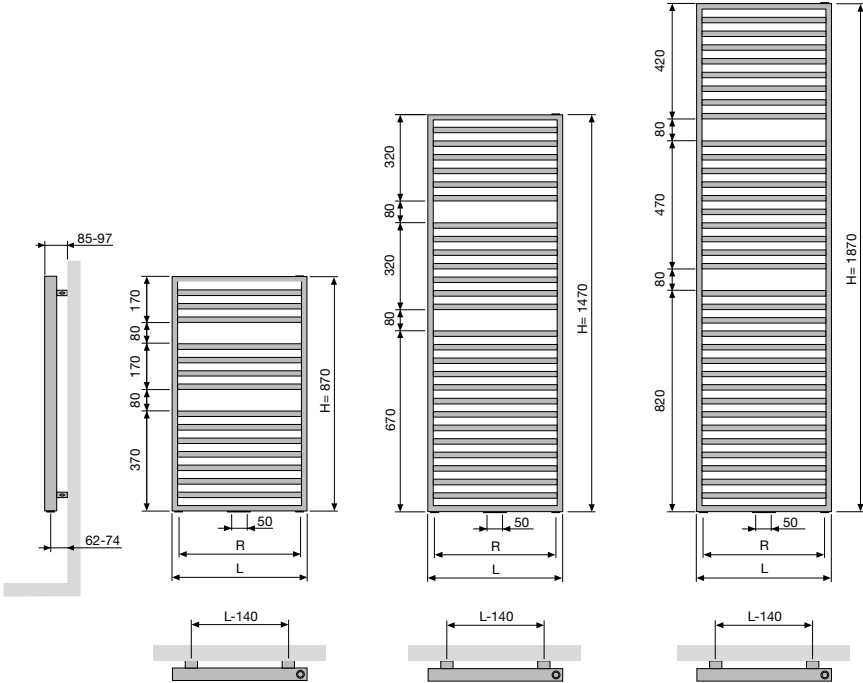

	AB		
Width (L)	500	600	700
Centre between the connections at the bottom (R)	400	500	600
Centre between the brackets	L-140	H-120	

ZANA BATHROOM (ZBD)

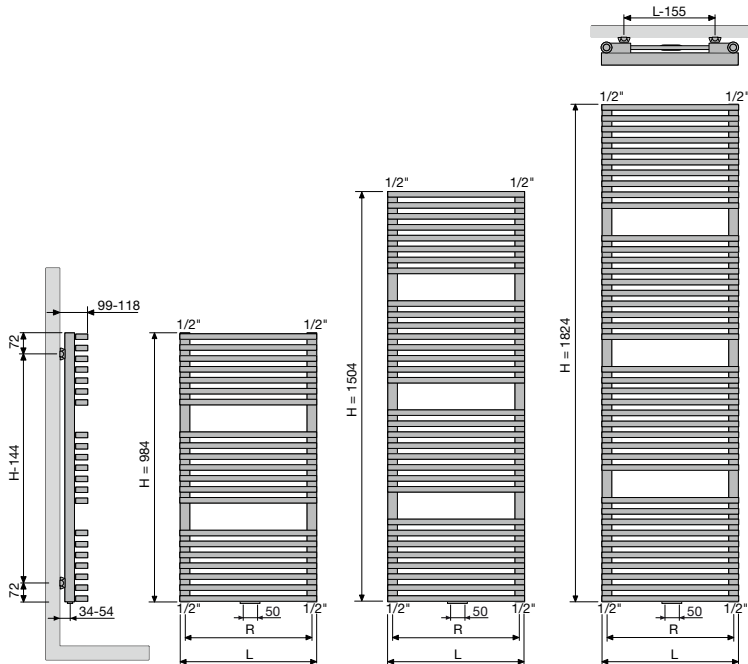

	ZBD		
Width (L)	500	600	
Centre between the connections at the bottom (R)	465	565	
Centre between the brackets	L-155	H-144	

Electric radiators

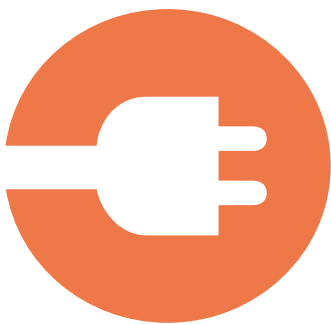

VASCO electric radiators are tailored towards a **fast, efficient and economical heat control**. Individual thermostats ensure an equal distribution of heat. The heat can be modified as desired while respecting your energy bill. VASCO electric radiators come with handy wall fixings for a trouble-free installation.

**VASCO COMPLETES
ITS ELECTRICAL RANGE
OF PRODUCTS
ACCORDING TO THE
ECODESIGN 2018 NORMS**



EcoDesign is a European directive that sets minimum requirements for energy performance of electrical products. As of January 1, 2018, stricter European EcoDesign norms apply to reduce the energy consumption of electrical devices. For example, electrical radiators should have a number of energy-saving functions from now on.

Electric radiators

Pure electrical radiators			
Beams Mono-EL	54	E-Bano	70
Oni-EL	56	E-Panel	72
Niva-EL	58	Iris-A BL	77
Iris-A	60	Agave-A BL	78
Agave-A	62	Aster-A BL	79
Aster-A	64	Carré CB-EL-BL	80
Carré CB-EL	66	Niva-A BL	81
Zana ZBD-EL	68		
Mixed radiators			
Niva Mixed	90	Aster-A Mixed	93
Iris-A Mixed	92		

ELECTRIC RADIATORS OVERVIEW AVAILABLE VERSIONS



NOT AVAILABLE
OUTSIDE THE
EU

ELECTRIC HEATING A SUSTAINABLE ALTERNATIVE

In modern, well-insulated homes, which are often fitted with PV solar panels, electric heating provides a cost-efficient and user-friendly solution.

Specific rooms such as the bathroom require a higher comfort temperature and here an electric blower can bring the room up to the desired temperature in no time. Thanks to their fast response time, electric radiators marry all the benefits of electric heating comfort with purity of design.

The electric radiators can be operated in 3 different ways:

- Manually
- Via Wi-Fi via the VASCO Climate Control App
- Via home automation control

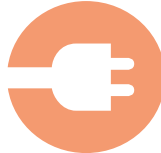

BEAMS MONO-EL (BEAMS MONO-EL)	ONI-EL (O-P-EL, O-NP-EL)	NIVA-EL (NIVA-EL)	IRIS-A (HD-EL-A, HDR-EL-A)	AGAVE-A (HR-EL-A)	ASTER-A (HF-EL-A)	CARRÉ BATHROOM (CB-EL)	ZANA BATHROOM (ZBD-EL)	E-BANO (BM-EL)	E-PANEL HORIZONTAL (EP-H-FL, EP-H-RIB)	E-PANEL VERTICAL (EP-V-FL)	IRIS-A BLOWER (HD-EL-BL-A)	AGAVE-A BLOWER (HR-EL-BL-A)	ASTER-A BLOWER (HF-EL-BL-A)	CARRÉ BATHROOM BLOWER (CB-EL-BL)	NIVA-A BLOWER (NIVA-EL-BL-A)	NIVA MIXED (N1L1-EL-MIX)	IRIS-A BLOWER MIXED (HDM-BL-MIX-A)	ASTER-A BLOWER MIXED (HF-BL-MIX-A)
-------------------------------	--------------------------	-------------------	----------------------------	-------------------	-------------------	------------------------	------------------------	----------------	--	----------------------------	----------------------------	-----------------------------	-----------------------------	----------------------------------	------------------------------	--------------------------	------------------------------------	------------------------------------

MANUAL CONTROL

Radiator + RF thermostat (included in the price) The radiator can only be operated via the included RF thermostat (white)		•	•	•													•	
Radiator without RF thermostat If you wish to operate several radiators with a single RF thermostat, it's enough to order just one radiator in the version -0000 and the other(s) in the version -0014.		•	•	•													•	
Radiator + E-Volve E-V-Basic (white or grey) (E-Volve E-V-Basic to be ordered separately) (Connection with RF thermostat not possible)				•	•	•	•	•										
Radiator + E-Volve E-V-RF (white or grey) (E-Volve E-V-RF to be ordered separately)				•	•	•	•	•										
Radiator with built-in control (included in the price)								•										
Radiator with built-in control (included in the price)									•	•								
Radiator with Blower (white or grey) + RF thermostat (in option) (RF thermostat to be ordered separately)											•	•	•	•				
CH radiator with Blower (white or grey) + RF thermostat (in option) (RF thermostat to be ordered separately)																	•	•

VIA WI-FI VIA THE VASCO CLIMATE CONTROL APP

The radiator (with cable and schuko plug 90°) can only be operated via the optional E-Volve E-V-WIFI (white or grey) (E-Volve E-V-WIFI to be ordered separately)		•	•	•						•	•						•	
The radiator can only be operated via the E-Volve E-V-WIFI (white or grey) (E-Volve E-V-WIFI to be ordered separately) (including provided BAS connector)				•	•	•	•	•										

VIA HOME AUTOMATION CONTROL

Radiator without control, with cable and schuko plug 90°		•	•	•						•	•						•	
Radiator without regulation + BAS connector (white or grey) (BAS connector to be ordered separately)				•	•	•	•	•										



NOT AVAILABLE
OUTSIDE THE
EU

ELECTRIC RADIATORS

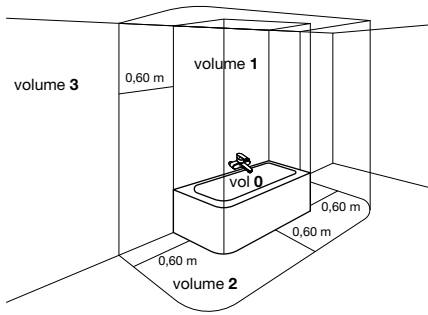

USE ENVIRONMENT FOR ELECTRICAL RADIATORS

The electrical radiators are Class II devices (double insulation). This means that the radiators do not have earthing, because they do not need this. Electrical radiators can be used in bathrooms of Volume 2 and 3 (see diagram of the baths). If there is a shower head, the distance between the radiator and the shower head should be at least 1.5 metres. For mounting the radiator: please follow the rules for electrical installations and VASCO's general conditions. To calculate the consumption of an electrical radiator, all you need to know is the radiator's wattage.

Example:

1000 Watt radiator. This has an electrical capacity of 1kW. The radiator therefore consumes 1kWh an hour. This applies, of course, if the radiator is working at full capacity throughout the whole hour. This is seldom the case in practice. After all, the radiator switches itself off once it has reached the required temperature. If you know the price of 1kWh, you can now calculate what the radiator costs in electrical energy.



10 YEAR WARRANTY on the radiator.



2 year warranty on electrical components.

This only applies when combined with a VASCO radiator.

The guarantee is null and void in the event of wrong usage.

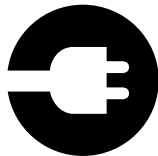

PURELY ELECTRIC AND MIXED RADIATORS

It is important to know that you can choose between purely electric radiators and mixed electric radiators.

Pure electric radiators are mainly filled with a heat-conductive liquid, and electric resistance is used to heat up the liquid. It is a closed circuit.

- CH radiator converted by a professional into a purely electric radiator (accessories to be ordered separately)
- Purely electric radiators pre-filled in the factory (any accessories to be ordered separately)

Mixed electric radiators are radiators that can be used to heat alternately either via a central heating (CH) installation or electrically.

- CH radiator equipped by a professional with an electric element and regulation
- CH radiator with Blower pre-assembled in the factory

Note: For safety reasons we advise against free-standing electrical or mixed radiators.



NOT AVAILABLE
OUTSIDE THE
EU

Pure electric radiators are mainly filled with a heat-conductive liquid, and electric resistance is used to heat up the liquid. It is a closed circuit.

- CH radiator converted by a professional into a purely electric radiator (accessories to be ordered separately)
- Purely electric radiators pre-filled in the factory (any accessories to be ordered separately)

With purely electric radiators we differentiate between 3 different control systems:



Manual



With the VASCO Climate Control App (WIFI)



Domotics control



BEAMS
MONO-EL



ONI-EL



E-VOLVE



NOT AVAILABLE
OUTSIDE THE
EU

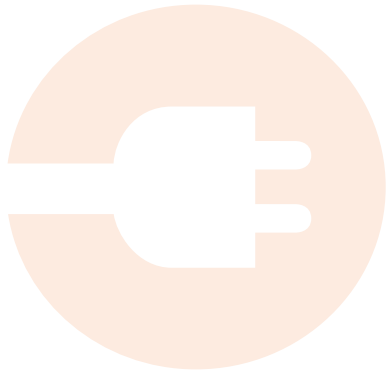

Pure electrical radiators



E-BANO



E-PANEL



BLOWER





NOT AVAILABLE
OUTSIDE THE
EU

ELECTRIC RADIATORS PURE ELECTRICAL RADIATORS

1. ELECTRIC ACCESSORIES FOR A CH RADIATOR TO BE CONVERTED BY A PROFESSIONAL INTO A PURELY ELECTRIC RADIATOR



E-VOLVE E-V-BASIC REGULATION

Height: 75 mm
Width: 140 mm
Depth: 35 mm

1.1. E-VOLVE E-V-BASIC REGULATION

- Operating voltage: 230V AC, 50 Hz
- Weekly and daily programming
- Control of room temperature from 7°C to 30°C
- Boost command: standard 60 minutes
- Auto, Comfort, Eco or frost protection mode
- Set programmes P1, P2 and P3 can be changed
- IPX4 Class II
- Cable length: 0.8 m (preferably use a direct fixed wall outlet)
- Energy-consumption indication
- Indicator of open window detection
- Control can be mounted onto the radiator at the bottom right-hand side

Remember:

- Connecting the E-V-Basic control: brown = live, blue = neutral and black = command wire (to be used only in France; should be shielded in case of non-use)
- Double insulated devices have no earthing.
- Connection with RF thermostat not possible

PRICE GROUP: VPG7 - ELECTRIC RADIATORS

type	emission (Watt)	ref. nr. (white)	price € (white)	ref. nr. (grey)	price € (grey)
E-V-Basic	300	1184 224 0000 9016	343	1184 224 0000 9006	394
E-V-Basic	500	1184 225 0000 9016	364	1184 225 0000 9006	420
E-V-Basic	750	1184 226 0000 9016	388	1184 226 0000 9006	444
E-V-Basic	1000	1184 227 0000 9016	409	1184 227 0000 9006	471
E-V-Basic	1250	1184 228 0000 9016	433	1184 228 0000 9006	497
E-V-Basic	1500	1184 229 0000 9016	455	1184 229 0000 9006	523



E-VOLVE E-V-RF RF RECEIVER

Height: 75 mm
Width: 140 mm
Depth: 35 mm

E-VOLVE E-V-RF RF THERMOSTAT

Height: 95 mm
Width: 120 mm
Depth: 25 mm

1.2. E-VOLVE E-V-RF REGULATION

- Operating voltage of the receiver: 230V AC, 50 Hz
- Thermostat: 2x Alkaline 1.5V
- Weekly and daily programming
- Control of room temperature from 7°C to 30°C
- Boost command: standard 60 minutes
- Auto, Comfort, Eco or frost protection mode
- Set programmes P1, P2 and P3 can be changed
- Receiver: IPX4 Class II
- Thermostat: IP30
- Cable length: 0.8 m (preferably use a direct fixed wall outlet)
- Energy-consumption indication
- Indicator of open window detection
- Receiver can be mounted onto the radiator at the bottom right-hand side
- RF communication between the receiver and the thermostat (to be connected)

Remember:

- Connecting the E-V-RF RF receiver: brown = live, blue = neutral and black = command wire (to be used only in France; should be shielded in case of non-use)
- Double insulated devices have no earthing
- The thermostat should be connected with the receiver according to the instructions in the manual of the RF thermostat.

Remember:

Number of electrical radiators on 1 RF thermostat:

- E-Volve E-V-RF: up to 5 radiators per RF thermostat
- Mixed (Blower or E-Volve E-V-RF): not possible

PRICE GROUP: VPG7 - ELECTRIC RADIATORS

type	emission (Watt)	ref. nr. (white)	price € (white)	ref. nr. (grey)	price € (grey)
E-V-RF	300	1184 230 0000 9016	566	1184 230 0000 9006	650
E-V-RF	500	1184 231 0000 9016	588	1184 231 0000 9006	676
E-V-RF	750	1184 232 0000 9016	609	1184 232 0000 9006	703
E-V-RF	1000	1184 233 0000 9016	633	1184 233 0000 9006	729
E-V-RF	1250	1184 234 0000 9016	657	1184 234 0000 9006	754
E-V-RF	1500	1184 235 0000 9016	676	1184 235 0000 9006	782

For the E-V-Basic and E-V-RF controllers we use the same resistance. Only the controllers from the VASCO range can be mounted on this resistance.

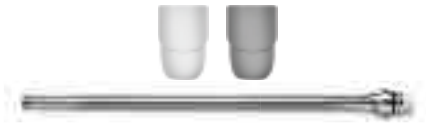

BAS CONNECTOR

Height: 65 mm
Width: 35 mm
Depth: 50 mm

1.3. RESISTANCE (CLASS II) + BAS CONNECTOR

- Sleek design: white or grey
- Use environment: volume 2 or 3 of the bathroom (drawing p. 45)
- To be mounted in the radiator on the underside
- Regulator or plug not provided
- Class IPX4
- **Control of the room temperature should be ensured by an external control system, in accordance with the Eco Design Directive 2015/1188!**

PRICE GROUP: VPG7 - ELECTRIC RADIATORS

type	emission (Watt)	ref. nr. (white)	price € (white)	ref. nr. (grey)	price € (grey)
Resistance + BAS connector	300	1184 100 0000 9016	131	1184 100 0000 7047	150
Resistance + BAS connector	500	1184 101 0000 9016	137	1184 101 0000 7047	158
Resistance + BAS connector	750	1184 102 0000 9016	172	1184 102 0000 7047	199
Resistance + BAS connector	1000	1184 103 0000 9016	205	1184 103 0000 7047	238
Resistance + BAS connector	1250	1184 104 0000 9016	242	1184 104 0000 7047	276
Resistance + BAS connector	1500	1184 105 0000 9016	275	1184 105 0000 7047	318

Lengths electrical resistances:

- Resistance 300 W : 365 mm
- Resistance 500 W : 520 mm
- Resistance 750 W : 700 mm
- Resistance 1000 W : 890 mm
- Resistance 1250 W : 1080 mm
- Resistance 1500 W : 1270 mm



NOT AVAILABLE
OUTSIDE THE
EU

ELECTRIC RADIATORS PURE ELECTRICAL RADIATORS



PURELY ELECTRIC RADIATORS PRE-FILLED IN THE FACTORY (ANY ACCESSORIES TO BE ORDERED SEPARATELY)

In the factory, VASCO's purely electrical radiators are equipped with a heat-conductive liquid and an electrical resistance. The resistance is mounted in the right-hand collector, causing the control to be located at the right-hand bottom side (exception is the E-Panel).

Oni-EL, Beams Mono-EL and Niva-EL are dry electric radiators and are therefore not equipped with a heat-conductive liquid (rapid preheating time). The electric receiver module is integrated almost invisibly into the back of these electric designer radiators.

Choose the model of radiator:

- Beams Mono-EL (BEAMS MONO-EL)
- Oni-EL (O-P-EL, O-NP-EL)
- Niva-EL (NIVA-EL)
- Iris-A (HDM-A/HDRM-A)
- Agave-A (HRM-A)
- Aster-A (HF-A)
- Carré Bathroom (CB-EL)
- Zana Bathroom (ZBD-EL)
- E-Bano (BM-EL)
- E-Panel (EP-H-FL, EP-H-RIB, EP-V-FL)
- Iris-A Blower (HD-EL-BL-A)
- Agave-A Blower (HR-EL-BL-A)
- Aster-A Blower (HF-EL-BL-A)
- Carré Bathroom Blower (CB-EL-BL)
- Niva-A Blower (NIVA-EL-BL-A)

2. ELECTRICAL ACCESSORIES FOR PURELY ELECTRICAL RADIATORS



Lengths electrical resistances (mounted as standard in the radiator):

- Resistance 300 W : 365 mm
- Resistance 500 W : 520 mm
- Resistance 750 W : 700 mm
- Resistance 1000 W : 890 mm
- Resistance 1250 W : 1080 mm
- Resistance 1500 W : 1270 mm

We distinguish these possibilities:

- 2.1. ONI-EL (O-P-EL / O-NP-EL) / BEAMS MONO-EL / NIVA-EL regulation
- 2.2. E-Volve E-V-Basic regulation
- 2.3. E-Volve E-V-RF regulation
- 2.4. E-Volve E-V-WIFI Regulation
- 2.5. BAS connector



RF THERMOSTAT

Height: 95 mm
Width: 120 mm
Depth: 25 mm

2.1. ONI-EL (O-P-EL / O-NP-EL) / BEAMS MONO-EL / NIVA-EL REGULATION

- Operating voltage of the RF receiver: 230V AC, 50 Hz
- RF thermostat: 2x Alkaline 1.5V
- Weekly and daily programming
- Control of room temperature from 7°C to 30°C
- Control of surface temperature from 20°C to 80°C
- Boost command: standard 60 minutes
- Auto, Comfort, Eco or frost protection mode
- Set programmes P1, P2 and P3 can be changed
- RF-receiver: IPX4 Class II (invisible at the back of the radiator)
- Thermostat: IP30
- Cable length: 0.8 m (preferably use a direct fixed wall outlet)
- Energy-consumption indication
- Indicator of open window detection
- RF communication between the receiver and the thermostat (to be connected)



Remember:

- Connecting the RF receiver: brown = live, blue = neutral and black = command wire (to be used only in France; should be shielded in case of non-use)
- Double insulated devices have no earthing
- The thermostat should be connected with the receiver according to the instructions in the manual of the RF thermostat.

Remember:

Number of electrical radiators on 1 RF thermostat:

- Beams Mono-EL / Oni-EL / Niva-EL: up to 5 radiators per RF thermostat (radiators in the same working modes)
- Mixed (Blower or E-Volve E-V-RF): not possible



E-VOLVE E-V-BASIC REGULATION

Height: 75 mm
Width: 140 mm
Depth: 35 mm

2.2. E-VOLVE E-V-BASIC REGULATION

- Operating voltage: 230V AC, 50 Hz
- Weekly and daily programming
- Control of room temperature from 7°C to 30°C
- Boost command: standard 60 minutes
- Auto, Comfort, Eco or frost protection mode
- Set programmes P1, P2 and P3 can be changed
- IPX4 Class II
- Cable length: 0.8 m (preferably use a direct fixed wall outlet)
- Energy-consumption indication
- Indicator of open window detection
- Control can be mounted onto the radiator at the bottom right-hand side

Remember:

- Connecting the E-V-Basic control: brown = live, blue = neutral and black = command wire (to be used only in France; should be shielded in case of non-use)
- Double insulated devices have no earthing.
- Connection with RF thermostat not possible

PRICE GROUP: VPG7 - ELECTRIC RADIATORS

colour	ref. nr.	price €
white	1184 005 0000 9016	238
grey	1184 005 0000 9006	274



E-VOLVE E-V-RF RF RECEIVER

Height: 75 mm
Width: 140 mm
Depth: 35 mm

E-VOLVE E-V-RF RF THERMOSTAT

Height: 95 mm
Width: 120 mm
Depth: 25 mm

2.3. E-VOLVE E-V-RF REGULATION

- Operating voltage of the receiver: 230V AC, 50 Hz
- Thermostat: 2x Alkaline 1.5V
- Weekly and daily programming
- Control of room temperature from 7°C to 30°C
- Boost command: standard 60 minutes
- Auto, Comfort, Eco or frost protection mode
- Set programmes P1, P2 and P3 can be changed
- Receiver: IPX4 Class II
- Thermostat: IP30
- Cable length: 0.8 m (preferably use a direct fixed wall outlet)
- Energy-consumption indication
- Indicator of open window detection
- Receiver can be mounted onto the radiator at the bottom right-hand side
- RF communication between the receiver and the thermostat (to be connected)

Remember:

- Connecting the E-V-RF RF receiver: brown = live, blue = neutral and black = command wire (to be used only in France; should be shielded in case of non-use)
- Double insulated devices have no earthing
- The thermostat should be connected with the receiver according to the instructions in the manual of the RF thermostat.



NOT AVAILABLE
OUTSIDE THE
EU

ELECTRIC RADIATORS PURE ELECTRICAL RADIATORS

Remember:

Number of electrical radiators on 1 RF thermostat:

- E-Volve E-V-RF: up to 5 radiators per RF thermostat
- Mixed (Blower or E-Volve E-V-RF): not possible

PRICE GROUP: VPG7 - ELECTRIC RADIATORS

colour	ref. nr.	price €
white	1184 006 0000 9016	402
grey	1184 006 0000 9006	426



E-VOLVE E-V-WIFI RECEIVER

Height: 73 mm
Width: 73 mm
Depth: 25 mm

E-VOLVE E-V-WIFI SENSOR

Height: 33,5 mm
Width: 33,5 mm
Depth: 9 mm

2.4. E-VOLVE E-V-WIFI REGULATION

- Receiver:
 - Operating voltage 230V AC, 50 Hz
 - Mounting on a standard electric outlet is recommended
 - IPX4 Class II
- Temperature sensor:
 - Battery provided: 1x CR2032
 - Wireless 2.4GHz (Bluetooth) connection with the receiver (to be linked up via the instructions in the VASCO Climate Control App)
 - IPX4
- Operation of the E-V-WIFI regulation via the VASCO Climate Control App
- Individual weekly and daily programming on the basis of living habits
- Control of room temperature from 5°C to 35°C
- Smart temperature control ensures that the temperature is reached automatically at the set time in the day schedule
- Boost command
- LED feedback via the receiver
- Indicator of open window detection

PRICE GROUP: VPG7 - ELECTRIC RADIATORS

colour	ref. nr.	price €
white	1184 007 0000 9016	OD
grey	1184 007 0000 7047	OD

OD = Prices on demand



BAS CONNECTOR

Height: 65 mm
Width: 35 mm
Depth: 50 mm

2.5. BAS CONNECTOR

Ideal for control via domotics!

These models of purely electrical radiators are already equipped with a heat-conductive liquid and an electrical resistance in the factory. The electrical resistance is mounted in the right-hand collector.

PRICE GROUP: VPG7 - ELECTRIC RADIATORS

colour	ref. nr.	price €
BAS connector white	1184 248 0000 9016	39
BAS connector grey	1184 248 0000 7047	43

Control of the room temperature should be ensured by an external control system, in accordance with the Eco Design Directive 2015/1188!

VASCO



NOT AVAILABLE
OUTSIDE THE
EU

BEAMS MONO-EL (BEAMS MONO-EL)

RECOMMENDED FOR
BATHROOM AND KITCHEN
IN OPTION



short towel rail (S600)
ref. nr. see p. 104

price €135

Other accessories, see p. 104

REGULATION (RF THERMOSTAT)



Included in the price!



RF receiver
at the back

COLOURS

- Standard colour S600 (fine texture white) (RAL 9016: no extra charge 15%)
- Not available in collection Pure Grey
- Extensive colour chart see p. 10

SPECIAL

- Standard radiator in combination with RF thermostat (RF thermostat included in the price)
- Low weight: so it can be placed quickly and easily by a single installer
- Dry aluminium radiator
- Pleasant radiant heat through innovative infrared technology
- Connection possible up to 5 radiators

BRACKETS

- Wall brackets standard (discretely eliminated)
- Only vertical mounting is possible

TECHNICAL

- KTL priming coat, powder coating
- Control of the room temperature
- **Surface temperature regulation**
- IPX4 Class II

ACCESSORIES

- See p. 104

TECHNICAL DRAWINGS

- See p. 94

AVAILABLE VERSIONS

PRICE GROUP: VPG7 - ELECTRIC RADIATORS



MANUAL CONTROL

-0000 = radiator + RF thermostat (included in the price). The radiator can only be operated via the included RF thermostat (white).



RF THERMOSTAT

Standard version.

-0014 = radiator without RF thermostat

If you wish to operate several radiators with a single RF thermostat, it's enough to order just one radiator in the version -0000 and the other(s) in the version -0014.



VCC APP* CONTROL

-0015 = the radiator (with cable and schuko plug 90°) can only be operated via the optional E-Volve E-V-WIFI (white or grey) (E-Volve E-V-WIFI to be ordered separately)



E-VOLVE E-V-WIFI

colour	ref. nr.	price €
white	1184 007 0000 9016	OD
grey	1184 007 0000 7047	OD

One E-Volve E-V-WIFI per radiator. The radiator is operated via the E-Volve E-V-WIFI module to be ordered separately (and NOT via the RF thermostat).

OD = Prices on demand

* **VASCO Climate Control (VCC App).** Thanks to the VASCO Climate Control (VCC App) you can log in anywhere and at any time and set your optimal indoor comfort. For more information see p. 5.



DOMOTICS CONTROL

-0015 = radiator without control, with cable and schuko plug 90°

This radiator (with cable and schuko plug 90°) may only be used in combination with a **building management system** (domotics) or **external thermostat** equipped with: a weekly programme + open window detection or adaptive start control or remote control, in order to satisfy the European ECO Design Directive 2015/1188.

HOW TO ORDER BEAMS MONO-EL

HOW TO ORDER

1. Choose the desired model of the radiator in the following table.
2. Select the desired control (see explanation bottom left) - depending on the desired control, extra accessories will have to be ordered as well.
3. **The total price is determined by the type of device chosen and any accessories.**

HOW TO FORM A CORRECT ORDER CODE

Delivery time 15 - 30 working days (transport duration not included)

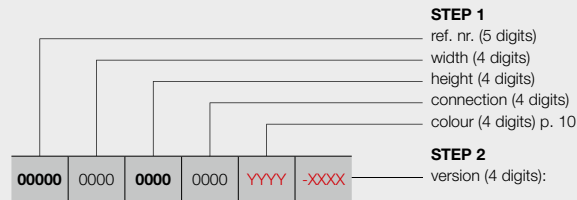

manual control

- 0000 = with RF thermostat **(included in the price)**
- 0014 = without RF thermostat

VCC App* control

- 0015 = the radiator (with cable and schuko plug 90°) can only be operated via the optional E-Volve E-V-WIFI (white or grey) **(to be ordered separately)**

domotics control

- 0015 = radiator without control, with cable and schuko plug 90°

ORDER CODE STOCK RADIATOR

Delivery time 5 working days (transport duration not included)

Stock radiators only possible in version with RF thermostat!

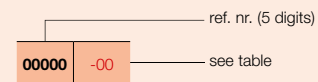

STEP 1 Choose the model of radiator



PRICE GROUP: VPG7 - ELECTRIC RADIATORS

REFERENCE CODE CUSTOM MADE BEAMS MONO-EL	TECHNICAL DATA				STANDARD COLOUR		OTHER COLOURS
	width (L mm)	height (H mm)	weight (kg)	electr. resistance (Watt)	price S600* (€)	short ref. nr. S600 stock	price colour (€)
REF. NR. BEAMS MONO-EL : 11349							
11349	0150	1800	0000	YYY	-0000		
					-0014		
					-0015		
					1057	11349-01	1216
					OD	11349-02	OD
					OD	11349-03	OD

Please indicate colour when ordering (YYY)

* RAL 9016: no extra charge 15%
EXPORT. Prices in Euro (excl. VAT)
OD = Prices on demand

STEP 2 You choose the accessories

Depending on the desired control you may have to order extra accessories. See page to the left.

STEP 3 Total price = price of electric radiator + price of accessories



RECOMMENDED FOR
BATHROOM AND KITCHEN
(O-NP-EL)
IN OPTION



towel rail MULTI+ right (S600)
ref. nr. see p. 104
price €204

towel rail MULTI+ right (RAL 9005)
ref. nr. see p. 104
price €204

Other accessories, see p. 104

REGULATION (RF THERMOSTAT)



Included in the price!

TYPES

- O-P-EL: with one (1400 mm) or two (1800/2000 mm) cut-outs for hanging towels
- O-NP-EL: without cut-outs

COLOURS

- Standard colour S600 (fine texture white) (RAL 9016: no extra charge 15%)
- Extensive colour chart see p. 10

SPECIAL

- Standard radiator in combination with RF thermostat (RF thermostat included in the price)
- Low weight: so it can be placed quickly and easily by a single installer
- Dry aluminium radiator
- Pleasant radiant heat through innovative infrared technology

BRACKETS

- Wall brackets standard
- Only vertical mounting is possible

TECHNICAL

- KTL priming coat, powder coating
- Control of the room temperature
- **Surface temperature regulation**
- IPX4 Class II

ACCESSORIES

- See p. 104

TECHNICAL DRAWINGS

- See p. 94



RF receiver at the back

AVAILABLE VERSIONS



MANUAL CONTROL

-0000 = radiator + RF thermostat (included in the price). The radiator can only be operated via the included RF thermostat (white).



RF THERMOSTAT

Standard version.

-0014 = radiator without RF thermostat

If you wish to operate several radiators with a single RF thermostat, it's enough to order just one radiator in the version -0000 and the other(s) in the version -0014.



VCC APP* CONTROL

-0015 = the radiator (with cable and schuko plug 90°) can only be operated via the optional E-Volve E-V-WIFI (white or grey) (E-Volve E-V-WIFI to be ordered separately)



E-VOLVE E-V-WIFI

colour	ref. nr.	price €
white	1184 007 0000 9016	OD
grey	1184 007 0000 7047	OD

One E-Volve E-V-WIFI per radiator. The radiator is operated via the E-Volve E-V-WIFI module to be ordered separately (and NOT via the RF thermostat).

OD = Prices on demand

* **VASCO Climate Control (VCC App).** Thanks to the VASCO Climate Control (VCC App) you can log in anywhere and at any time and set your optimal indoor comfort. For more information see p. 5.



DOMOTICS CONTROL

-0015 = radiator without control, with cable and schuko plug 90°

This radiator (with cable and schuko plug 90°) may only be used in combination with a **building management system** (domotics) or **external thermostat** equipped with: a weekly programme + open window detection or adaptive start control or remote control, in order to satisfy the European ECO Design Directive 2015/1188.

PRICE GROUP: VPG7 - ELECTRIC RADIATORS

HOW TO ORDER

1. Choose the desired model of the radiator in the following table.
2. Select the desired control (see explanation bottom left) - depending on the desired control, extra accessories will have to be ordered as well.
3. **The total price is determined by the type of device chosen and any accessories.**

HOW TO FORM A CORRECT ORDER CODE

Delivery time 15 - 30 working days (transport duration not included)

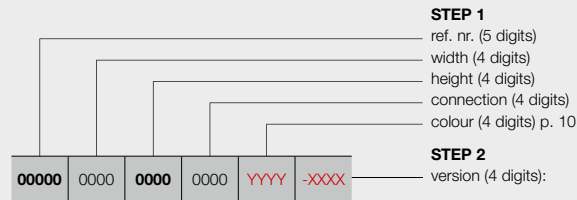

O-P O-NP

manual control

- 0000 = with RF thermostat **(included in the price)**
- 0014 = without RF thermostat

VCC App* control

- 0015 = the radiator (with cable and schuko plug 90°) can only be operated via the optional E-Volve E-V-WIFI (white or grey) **(to be ordered separately)**

domotics control

- 0015 = radiator without control, with cable and schuko plug 90°

ORDER CODE STOCK RADIATOR

Delivery time 5 working days (transport duration not included)

Stock radiators only possible in version with RF thermostat!

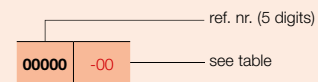

STEP 1 Choose the model of radiator



PRICE GROUP: VPG7 - ELECTRIC RADIATORS

REFERENCE CODE CUSTOM MADE ONI-EL	TECHNICAL DATA				STANDARD COLOUR		OTHER COLOURS
	width (L mm)	height (H mm)	weight (kg)	electr. resistance (Watt)	price S600* (€)	short ref. nr. S600 stock	price colour (€)
REF. NR. O-P-EL : 11348							
11348	0500	1400	0000	YYYY	-0000 -0014 -0015	500 1400 17,80 750	1249 11348-01 1436 OD - OD OD - OD
11348	0500	1800	0000	YYYY	-0000 -0014 -0015	500 1800 22,00 1000	1378 11348-02 1585 OD - OD OD - OD
REF. NR. O-NP-EL : 11356							
11356	0500	1400	0000	YYYY	-0000 -0014 -0015	500 1400 17,80 750	1177 - 1354 OD - OD OD - OD
11356	0500	1800	0000	YYYY	-0000 -0014 -0015	500 1800 22,00 1000	1306 11356-01 1502 OD - OD OD - OD

Please indicate colour when ordering (YYYY)

* RAL 9016: no extra charge 15%
EXPORT. Prices in Euro (excl. VAT)
OD = Prices on demand

STEP 2 You choose the accessories

Depending on the desired control you may have to order extra accessories. See page to the left.

STEP 3 Total price = price of electric radiator + price of accessories



**RECOMMENDED FOR
BATHROOM AND KITCHEN
IN OPTION**



towel rail (aluminium)
ref. nr. see p. 104
price € 187

Other accessories, see p. 104

REGULATION (RF THERMOSTAT)



Included in the price!

COLOURS

- Standard colour S600 (fine texture white) (RAL 9016: no extra charge 15%)
- Extensive colour chart see p. 10

SPECIAL

- Lacquered front plate
- Standard radiator in combination with RF thermostat (RF thermostat included in the price)
- Low weight: so it can be placed quickly and easily by a single installer
- Dry steel radiator
- Pleasant radiant heat through innovative infrared technology

BRACKETS

- Wall brackets in the colour RAL 7016 (anthracite grey) standard.

TECHNICAL

- Electrically welded by means of resistance welding robots (invisible weld seams)
- KTL priming coat, powder coating
- Control of the room temperature
- IPX4 Class II

ACCESSORIES

- See p. 104

TECHNICAL DRAWINGS

- See p. 95

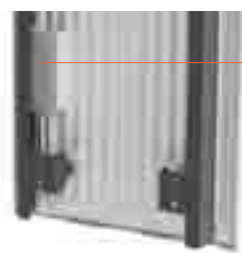

RF receiver
at the back

AVAILABLE VERSIONS

PRICE GROUP: VPG7 - ELECTRIC RADIATORS



MANUAL CONTROL

-0000 = radiator + RF thermostat (included in the price).
The radiator can only be operated via the included RF thermostat (white).



RF THERMOSTAT

Standard version.

-0014 = radiator without RF thermostat

If you wish to operate several radiators with a single RF thermostat, it's enough to order just one radiator in the version -0000 and the other(s) in the version -0014.



VCC APP* CONTROL

-0015 = the radiator (with cable and schuko plug 90°) can only be operated via the optional E-Volve E-V-WIFI (white or grey) (E-Volve E-V-WIFI to be ordered separately)



E-VOLVE E-V-WIFI

colour	ref. nr.	price €
white	1184 007 0000 9016	OD
grey	1184 007 0000 7047	OD

One E-Volve E-V-WIFI per radiator. The radiator is operated via the E-Volve E-V-WIFI module to be ordered separately (and NOT via the RF thermostat).

OD = Prices on demand

* **VASCO Climate Control (VCC App).** Thanks to the VASCO Climate Control (VCC App) you can log in anywhere and at any time and set your optimal indoor comfort. For more information see p. 5.



DOMOTICS CONTROL

-0015 = radiator without control, with cable and schuko plug 90°

This radiator (with cable and schuko plug 90°) may only be used in combination with a **building management system** (domotics) or **external thermostat** equipped with: a weekly programme + open window detection or adaptive start control or remote control, in order to satisfy the European ECO Design Directive 2015/1188.

HOW TO ORDER

1. Choose the desired model of the radiator in the following table.
2. Select the desired control (see explanation bottom left) - depending on the desired control, extra accessories will have to be ordered as well.
3. **The total price is determined by the type of device chosen and any accessories.**

HOW TO FORM A CORRECT ORDER CODE

Delivery time 15 - 30 working days (transport duration not included)

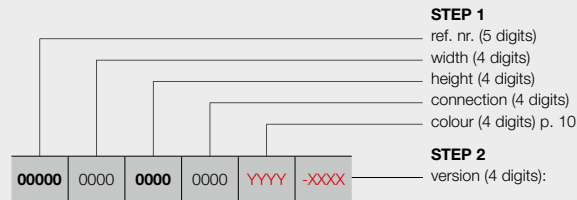

manual control

- 0000 = with RF thermostat **(included in the price)**
- 0014 = without RF thermostat

VCC App* control

- 0015 = the radiator (with cable and schuko plug 90°) can only be operated via the optional E-Volve E-V-WIFI (white or grey) **(to be ordered separately)**

domotics control

- 0015 = radiator without control, with cable and schuko plug 90°

ORDER CODE STOCK RADIATOR

Delivery time 5 working days (transport duration not included)

Stock radiators only possible in version with RF thermostat!

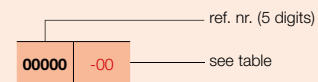

STEP 1 Choose the model of radiator



PRICE GROUP: VPG7 - ELECTRIC RADIATORS

REFERENCE CODE CUSTOM MADE NIVA-EL	TECHNICAL DATA				STANDARD COLOUR		OTHER COLOURS					
	width (L mm)	height (H mm)	weight (kg)	electr. resistance (Watt)	price S600* (€)	short ref. nr. S600 stock	price colour (€)					
REF. NR. NIVA-EL : 11361												
11361	0420	1820	0000	YYYY	-0000	420	1820	27,80	900	900	11361-01	1035
					-0014					OD	-	OD
					-0015					OD	-	OD
11361	0520	0920	0000	YYYY	-0000	520	920	13,80	500	788	11361-02	906
					-0014					OD	-	OD
					-0015					OD	-	OD
11361	0520	1420	0000	YYYY	-0000	520	1420	20,80	900	860	11361-03	989
					-0014					OD	-	OD
					-0015					OD	-	OD
11361	0520	1820	0000	YYYY	-0000	520	1820	26,40	1100	940	11361-04	1081
					-0014					OD	-	OD
					-0015					OD	-	OD
11361	0620	1820	0000	YYYY	-0000	620	1820	31,30	1300	974	11361-05	1120
					-0014					OD	-	OD
					-0015					OD	-	OD
11361	0620	2020	0000	YYYY	-0000	620	2020	34,70	1500	1083	11361-06	1245
					-0014					OD	-	OD
					-0015					OD	-	OD

Please indicate colour when ordering (YYYY)

* RAL 9016: no extra charge 15%
EXPORT. Prices in Euro (excl. VAT)
OD = Prices on demand

STEP 2 You choose the accessories

Depending on the desired control you may have to order extra accessories. See page to the left.

STEP 3 Total price = price of electric radiator + price of accessories

IRIS-A (HD-EL-A, HDR-EL-A)



RECOMMENDED FOR
BATHROOM AND KITCHEN
IN OPTION



folding drying and stacking rack
(chrome)
ref. nr. see p. 104
price €135

Other accessories, see p. 104

TYPES

- Straight (HD-EL-A) and curved (HDR-EL-A)

TUBES

- Horizontal, round Ø 20 mm

COLLECTORS

- Vertical, D-profile 40 x 32 mm

COLOURS

- Standard colour white RAL 9016
- Extensive colour chart see p. 10

SPECIAL

- The horizontal tubes of type HDR-EL-A are slightly bent (10°).

BRACKETS

- Wall brackets in the colour of the radiator standard (included in packaging of radiator)

TECHNICAL

- Soldered (invisible soldered seams)
- ATL priming coat, powder coating
- Regulation: accessories to be ordered separately (choose from the following versions)
- IPX4 Class II

ACCESSORIES

- See p. 104

TECHNICAL DRAWINGS

- See p. 95

Attention: radiator with resistance as standard, control to be ordered separately

AVAILABLE VERSIONS

PRICE GROUP: VPG7 - ELECTRIC RADIATORS

MANUAL CONTROL

Radiator + E-Volve E-V-Basic (white or grey) **(E-Volve E-V-Basic to be ordered separately)**



E-VOLVE E-V-BASIC

colour	ref. nr.	price €
white	1184 005 0000 9016	238
grey	1184 005 0000 9006	274

Connection with RF thermostat not possible

Radiator + E-Volve E-V-RF (white or grey) **(E-Volve E-V-RF to be ordered separately)**



E-VOLVE E-V-RF

colour	ref. nr.	price €
white	1184 006 0000 9016	402
grey	1184 006 0000 9006	426

RF thermostat only available in white

VCC APP* CONTROL

The radiator can only be operated via the E-Volve E-V-WIFI (white or grey) **(E-Volve E-V-WIFI to be ordered separately)** (including provided BAS connector)



E-VOLVE E-V-WIFI

colour	ref. nr.	price €
white	1184 007 0000 9016	OD
grey	1184 007 0000 7047	OD

One E-Volve E-V-WIFI per radiator. It is not possible to operate the radiator via the E-Volve E-V-Basic or E-Volve E-V-RF.

OD = Prices on demand

* VASCO Climate Control (VCC App). Thanks to the VASCO Climate Control (VCC App) you can log in anywhere and at any time and set your optimal indoor comfort. For more information see p. 5.

DOMOTICS CONTROL

Radiator without regulation + BAS connector (white or grey) **(BAS connector to be ordered separately)**



BAS CONNECTOR

colour	ref. nr.	price €
white	1184 248 0000 9016	39
grey	1184 248 0000 7047	43

The radiator (with BAS connector) may only be used in combination with a **building management system** (domotics) or **external thermostat** equipped with: a weekly programme + open window detection or adaptive start control or remote control, in order to satisfy the European ECO Design Directive 2015/1188.

HOW TO ORDER IRIS-A ELECTRIC

HOW TO ORDER

1. Choose the desired model of the radiator in the following table.
2. Select the desired control (see explanation bottom left) - depending on the desired control, extra accessories will have to be ordered as well.
3. **The total price is determined by the type of device chosen and the accessories.**

HOW TO FORM A CORRECT ORDER CODE

Delivery time 15 - 30 working days (transport duration not included)

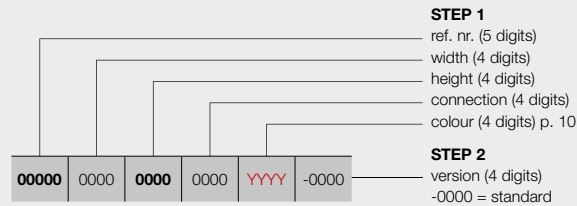

manual control

With E-Volve E-V-Basic (white or grey) **(to be ordered separately)**

With E-Volve E-V-RF (white or grey) **(to be ordered separately)**

VCC App* control

The radiator can only be operated via the E-Volve E-V-WIFI (white or grey) **(to be ordered separately)** (including provided BAS connector)

domotics control

radiator without regulation + BAS connector (white or grey) **(to be ordered separately)**

ORDER CODE STOCK RADIATOR

Delivery time 5 working days (transport duration not included)

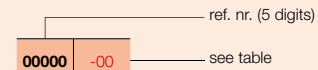

VASCO

STEP 1 Choose the model of radiator



PRICE GROUP: VPG7 - ELECTRIC RADIATORS

REFERENCE CODE CUSTOM MADE IRIS-A	TECHNICAL DATA					STANDARD COLOUR		OTHER COLOURS	
	tubes	width (L mm)	height (H mm)	weight (kg)	electr. resistance (Watt)	price RAL 9016 (€)	short ref. nr. RAL 9016 stock		price colour (€)
REF. NR. IRIS-A HD-EL-A : 11390									
11390	0500	1104 1308	0000	YYYY	-0000	28 500 1104 13,68 500 34 500 1308 16,53 750	552 618	11390-01 11390-02	635 711
11390	0600	1682 1954	0000	YYYY	-0000	43 600 1682 23,80 1000 51 600 1954 28,15 1250	730 804	11390-05 11390-03	840 925
11390	0750	1954	0000	YYYY	-0000	51 750 1954 33,23 1500	850	11390-04	978
REF. NR. IRIS-A HDR-EL-A : 11391									
11391	0500	1308	0000	YYYY	-0000	34 500 1308 16,53 750	680	-	782
11391	0600	1682 1954	0000	YYYY	-0000	43 600 1682 23,80 1000 51 600 1954 28,15 1250	802 886	- -	922 1019

Please indicate colour when ordering (YYYY)

EXPORT. Prices in Euro (excl. VAT)

STEP 2 You choose the accessories

Depending on the desired control you have to order extra accessories. See page to the left.

STEP 3 Total price = price of electric radiator + price of accessories

AGAVE-A (HR-EL-A)



RECOMMENDED FOR BATHROOM AND KITCHEN IN OPTION



folding drying and stacking rack (chrome)
ref. nr. see p. 104
price €135

Other accessories, see p. 104

TYPES

- Straight (HR-EL-A)

TUBES

- Horizontal, round Ø 20 mm

COLLECTORS

- Vertical, rear, round Ø 28 mm

COLOURS

- Standard colour white RAL 9016
- Extensive colour chart see p. 10

BRACKETS

- Wall brackets in the colour of the radiator standard (included in packaging of radiator)

TECHNICAL

- Welded by means of resistance welding (invisible weld seams)
- ATL priming coat, powder coating
- Regulation: accessories to be ordered separately (choose from the following versions)
- IPX4 Class II

ACCESSORIES

- See p. 104

TECHNICAL DRAWINGS

- See p. 96

Attention: radiator with resistance as standard, control to be ordered separately

AVAILABLE VERSIONS



MANUAL CONTROL

Radiator + E-Volve E-V-Basic (white or grey) **(E-Volve E-V-Basic to be ordered separately)**



E-VOLVE E-V-BASIC

colour	ref. nr.	price €
white	1184 005 0000 9016	238
grey	1184 005 0000 9006	274

Connection with RF thermostat not possible

Radiator + E-Volve E-V-RF (white or grey) **(E-Volve E-V-RF to be ordered separately)**



E-VOLVE E-V-RF

colour	ref. nr.	price €
white	1184 006 0000 9016	402
grey	1184 006 0000 9006	426

RF thermostat only available in white



VCC APP* CONTROL

The radiator can only be operated via the E-Volve E-V-WIFI (white or grey) **(E-Volve E-V-WIFI to be ordered separately)** (including provided BAS connector)



E-VOLVE E-V-WIFI

colour	ref. nr.	price €
white	1184 007 0000 9016	OD
grey	1184 007 0000 7047	OD

One E-Volve E-V-WIFI per radiator. It is not possible to operate the radiator via the E-Volve E-V-Basic or E-Volve E-V-RF.

OD = Prices on demand

* VASCO Climate Control (VCC App). Thanks to the VASCO Climate Control (VCC App) you can log in anywhere and at any time and set your optimal indoor comfort. For more information see p. 5.



DOMOTICS CONTROL

Radiator without regulation + BAS connector (white or grey) **(BAS connector to be ordered separately)**



BAS CONNECTOR

colour	ref. nr.	price €
white	1184 248 0000 9016	39
grey	1184 248 0000 7047	43

The radiator (with BAS connector) may only be used in combination with a **building management system** (domotics) or **external thermostat** equipped with: a weekly programme + open window detection or adaptive start control or remote control, in order to satisfy the European ECO Design Directive 2015/1188.

PRICE GROUP: VPG7 - ELECTRIC RADIATORS

HOW TO ORDER

1. Choose the desired model of the radiator in the following table.
2. Select the desired control (see explanation bottom left) - depending on the desired control, extra accessories will have to be ordered as well.
3. **The total price is determined by the type of device chosen and the accessories.**

HOW TO FORM A CORRECT ORDER CODE

Delivery time 15 - 30 working days (transport duration not included)

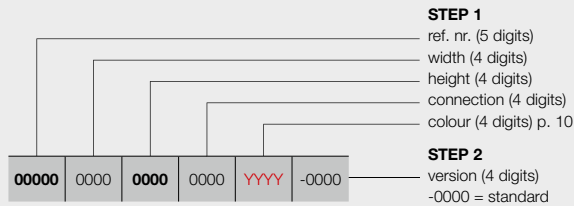

manual control

With E-Volve E-V-Basic (white or grey) **(to be ordered separately)**
 With E-Volve E-V-RF (white or grey) **(to be ordered separately)**

VCC App* control

The radiator can only be operated via the E-Volve E-V-WIFI (white or grey)
(to be ordered separately) (including provided BAS connector)

domotics control

radiator without regulation + BAS connector (white or grey)
(to be ordered separately)

STEP 1 Choose the model of radiator



PRICE GROUP: VPG7 - ELECTRIC RADIATORS

REFERENCE CODE CUSTOM MADE AGAVE-A	TECHNICAL DATA					STANDARD COLOUR	OTHER COLOURS
	tubes	width (L mm)	height (H mm)	weight (kg)	electr. resistance (Watt)	price RAL 9016 (€)	price colour (€)
REF. NR. AGAVE-A HR-EL-A : 11395							
11395 0500 1501 0000 YYYY -0000	37	500	1501	21,80	750	758	872
	44	500	1798	25,50	1000	936	1076
11395 0600 1798 0000 YYYY -0000	44	600	1798	29,70	1250	1085	1248

Please indicate colour when ordering (YYYY)

EXPORT. Prices in Euro (excl. VAT)

STEP 2 You choose the accessories

Depending on the desired control you have to order extra accessories. See page to the left.

STEP 3 Total price = price of electric radiator + price of accessories

ASTER-A (HF-EL-A)



VASCO

TUBES

- Horizontal, flat-oval 57,5 x 10 mm

COLLECTORS

- Vertical, round Ø 28 mm

COLOURS

- Standard colour white RAL 9016
- Extensive colour chart see p. 10

BRACKETS

- Wall brackets in the colour of the radiator standard (included in packaging of radiator)

TECHNICAL

- Welded by means of resistance welding (invisible weld seams)
- ATL priming coat, powder coating
- Regulation: accessories to be ordered separately (choose from the following versions)
- IPX4 Class II

TECHNICAL DRAWINGS

- See p. 96

Attention: radiator with resistance as standard, control to be ordered separately

AVAILABLE VERSIONS



MANUAL CONTROL

Radiator + E-Volve E-V-Basic (white or grey) **(E-Volve E-V-Basic to be ordered separately)**

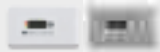

E-VOLVE E-V-BASIC

colour	ref. nr.	price €
white	1184 005 0000 9016	238
grey	1184 005 0000 9006	274

Connection with RF thermostat not possible

Radiator + E-Volve E-V-RF (white or grey) **(E-Volve E-V-RF to be ordered separately)**



E-VOLVE E-V-RF

colour	ref. nr.	price €
white	1184 006 0000 9016	402
grey	1184 006 0000 9006	426

RF thermostat only available in white



VCC APP* CONTROL

The radiator can only be operated via the E-Volve E-V-WIFI (white or grey) **(E-Volve E-V-WIFI to be ordered separately)** (including provided BAS connector)



E-VOLVE E-V-WIFI

colour	ref. nr.	price €
white	1184 007 0000 9016	OD
grey	1184 007 0000 7047	OD

One E-Volve E-V-WIFI per radiator. It is not possible to operate the radiator via the E-Volve E-V-Basic or E-Volve E-V-RF.

OD = Prices on demand

* VASCO Climate Control (VCC App). Thanks to the VASCO Climate Control (VCC App) you can log in anywhere and at any time and set your optimal indoor comfort. For more information see p. 5.



DOMOTICS CONTROL

Radiator without regulation + BAS connector (white or grey) **(BAS connector to be ordered separately)**



BAS CONNECTOR

colour	ref. nr.	price €
white	1184 248 0000 9016	39
grey	1184 248 0000 7047	43

The radiator (with BAS connector) may only be used in combination with a **building management system** (domotics) or **external thermostat** equipped with: a weekly programme + open window detection or adaptive start control or remote control, in order to satisfy the European ECO Design Directive 2015/1188.

PRICE GROUP: VPG7 - ELECTRIC RADIATORS

HOW TO ORDER

1. Choose the desired model of the radiator in the following table.
2. Select the desired control (see explanation bottom left) - depending on the desired control, extra accessories will have to be ordered as well.
3. **The total price is determined by the type of device chosen and the accessories.**

HOW TO FORM A CORRECT ORDER CODE

Delivery time 15 - 30 working days (transport duration not included)

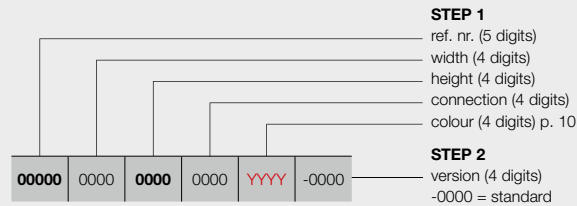

manual control

With E-Volve E-V-Basic (white or grey) **(to be ordered separately)**

With E-Volve E-V-RF (white or grey) **(to be ordered separately)**

VCC App* control

The radiator can only be operated via the E-Volve E-V-WIFI (white or grey) **(to be ordered separately)** (including provided BAS connector)

domotics control

radiator without regulation + BAS connector (white or grey) **(to be ordered separately)**

ORDER CODE STOCK RADIATOR

Delivery time 5 working days (transport duration not included)

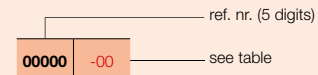

STEP 1 Choose the model of radiator



PRICE GROUP: VPG7 - ELECTRIC RADIATORS

REFERENCE CODE CUSTOM MADE ASTER-A	TECHNICAL DATA					STANDARD COLOUR		OTHER COLOURS
	tubes	width (L mm)	height (H mm)	weight (kg)	electr. resistance (Watt)	price RAL 9016 (€)	short ref. nr. RAL 9016 stock	
REF. NR. ASTER-A HF-EL-A : 11398								
11398 0500 1169 0000 YYYY -0000 1834	16	500	1169	19,00	500	774	11398-01	890
	27	500	1834	30,80	750	923	11398-02	1061
11398 0600 1834 0000 YYYY -0000	27	600	1834	35,80	1000	1085	11398-03	1248
11398 0700 2137 0000 YYYY -0000	31	700	2137	49,00	1250	1266	-	1456

Please indicate colour when ordering (YYYY)

EXPORT. Prices in Euro (excl. VAT)

STEP 2 You choose the accessories

Depending on the desired control you have to order extra accessories. See page to the left.

STEP 3 Total price = price of electric radiator + price of accessories



NOT AVAILABLE
OUTSIDE THE
EU

CARRÉ BATHROOM (CB-EL)



RECOMMENDED FOR
BATHROOM AND KITCHEN
IN OPTION



towel rail straight (chrome)
ref. nr. see p. 104

price € 187

Other accessories, see p. 104

TUBES

- Horizontal, square 25 x 25 mm

COLLECTORS

- Vertical, round Ø 35 mm

COLOURS

- Standard colour white RAL 9016
- Extensive colour chart see p. 10

BRACKETS

- Wall brackets in the colour RAL 9016 standard. Also in option available in the colour RAL 7016 (see p. 103).

TECHNICAL

- Welded by means of resistance welding robots (invisible weld seams)
- KTL priming coat, powder coating
- Regulation: accessories to be ordered separately (choose from the following versions)
- IPX4 Class II

ACCESSORIES

- See p. 104

TECHNICAL DRAWINGS

- See p. 97

Attention: radiator with resistance as standard, control to be ordered separately   

VASCO

AVAILABLE VERSIONS



MANUAL CONTROL

Radiator + E-Volve E-V-Basic (white or grey) **(E-Volve E-V-Basic to be ordered separately)**



E-VOLVE E-V-BASIC

colour	ref. nr.	price €
white	1184 005 0000 9016	238
grey	1184 005 0000 9006	274

Connection with RF thermostat not possible

Radiator + E-Volve E-V-RF (white or grey) **(E-Volve E-V-RF to be ordered separately)**



E-VOLVE E-V-RF

colour	ref. nr.	price €
white	1184 006 0000 9016	402
grey	1184 006 0000 9006	426

RF thermostat only available in white



VCC APP* CONTROL

The radiator can only be operated via the E-Volve E-V-WIFI (white or grey) **(E-Volve E-V-WIFI to be ordered separately)** (including provided BAS connector)



E-VOLVE E-V-WIFI

colour	ref. nr.	price €
white	1184 007 0000 9016	OD
grey	1184 007 0000 7047	OD

One E-Volve E-V-WIFI per radiator. It is not possible to operate the radiator via the E-Volve E-V-Basic or E-Volve E-V-RF.

OD = Prices on demand

* VASCO Climate Control (VCC App). Thanks to the VASCO Climate Control (VCC App) you can log in anywhere and at any time and set your optimal indoor comfort. For more information see p. 5.



DOMOTICS CONTROL

Radiator without regulation + BAS connector (white or grey) **(BAS connector to be ordered separately)**



BAS CONNECTOR

colour	ref. nr.	price €
white	1184 248 0000 9016	39
grey	1184 248 0000 7047	43

The radiator (with BAS connector) may only be used in combination with a **building management system** (domotics) or **external thermostat** equipped with: a weekly programme + open window detection or adaptive start control or remote control, in order to satisfy the European ECO Design Directive 2015/1188.

PRICE GROUP: VPG7 - ELECTRIC RADIATORS

HOW TO ORDER CARRÉ BATHROOM ELECTRIC

HOW TO ORDER

1. Choose the desired model of the radiator in the following table.
2. Select the desired control (see explanation bottom left) - depending on the desired control, extra accessories will have to be ordered as well.
3. **The total price is determined by the type of device chosen and the accessories.**

HOW TO FORM A CORRECT ORDER CODE

Delivery time 15 - 30 working days (transport duration not included)

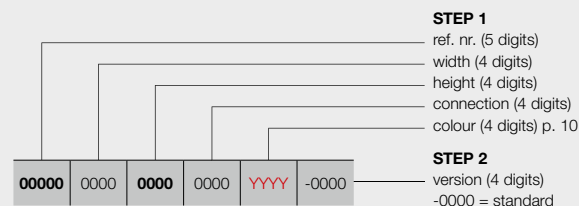

manual control

With E-Volve E-V-Basic (white or grey) **(to be ordered separately)**

With E-Volve E-V-RF (white or grey) **(to be ordered separately)**

VCC App* control

The radiator can only be operated via the E-Volve E-V-WIFI (white or grey) **(to be ordered separately)** (including provided BAS connector)

domotics control

radiator without regulation + BAS connector (white or grey) **(to be ordered separately)**

ORDER CODE STOCK RADIATOR

Delivery time 5 working days (transport duration not included)

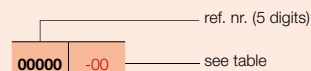

VASCO

STEP 1 Choose the model of radiator



PRICE GROUP: VPG7 - ELECTRIC RADIATORS

REFERENCE CODE CUSTOM MADE CARRÉ BATHROOM	TECHNICAL DATA					STANDARD COLOUR		OTHER COLOURS
	tubes	width (L mm)	height (H mm)	weight (kg)	electr. resistance (Watt)	price RAL 9016 (€)	short ref. nr. RAL 9016 stock	price colour (€)
REF. NR. CARRÉ BATHROOM CB-EL : 11335								
11335 0500 0747 0000 YYYY -0000	21	500	747	18,90	500	1004	-	1155
1137	32	500	1137	28,50	750	1103	-	1268
11335 0600 1377 0000 YYYY -0000	40	600	1377	41,65	1000	1236	-	1421
1737	50	600	1737	49,80	1250	1400	11335-01	1610

Please indicate colour when ordering (YYYY)

EXPORT. Prices in Euro (excl. VAT)

STEP 2 You choose the accessories

Depending on the desired control you have to order extra accessories. See page to the left.

STEP 3 Total price = price of electric radiator + price of accessories



NOT AVAILABLE
OUTSIDE THE
EU

ZANA BATHROOM (ZBD-EL)



RECOMMENDED FOR
BATHROOM AND KITCHEN
IN OPTION



towel rail straight (chrome)
ref. nr. see p. 104

price € 187

Other accessories, see p. 104

TUBES

- Horizontal, rectangular 45 x 20 mm

COLLECTORS

- Vertical, round Ø 35 mm

COLOURS

- Standard colour white RAL 9016
- Extensive colour chart see p. 10

BRACKETS

- Wall brackets in the colour RAL 9016 standard. Also in option available in the colour RAL 7016 (see p. 103).

TECHNICAL

- Welded by means of resistance welding robots (invisible weld seams)
- KTL priming coat, powder coating
- Regulation: accessories to be ordered separately (choose from the following versions)
- IPX4 Class II

ACCESSORIES

- See p. 104

TECHNICAL DRAWINGS

- See p. 97

Attention: radiator with resistance as standard, control to be ordered separately   

VASCO

AVAILABLE VERSIONS



MANUAL CONTROL

Radiator + E-Volve E-V-Basic (white or grey) **(E-Volve E-V-Basic to be ordered separately)**



E-VOLVE E-V-BASIC

colour	ref. nr.	price €
white	1184 005 0000 9016	238
grey	1184 005 0000 9006	274

Connection with RF thermostat not possible

Radiator + E-Volve E-V-RF (white or grey) **(E-Volve E-V-RF to be ordered separately)**



E-VOLVE E-V-RF

colour	ref. nr.	price €
white	1184 006 0000 9016	402
grey	1184 006 0000 9006	426

RF thermostat only available in white



VCC APP* CONTROL

The radiator can only be operated via the E-Volve E-V-WIFI (white or grey) **(E-Volve E-V-WIFI to be ordered separately)** (including provided BAS connector)



E-VOLVE E-V-WIFI

colour	ref. nr.	price €
white	1184 007 0000 9016	OD
grey	1184 007 0000 7047	OD

One E-Volve E-V-WIFI per radiator. It is not possible to operate the radiator via the E-Volve E-V-Basic or E-Volve E-V-RF.

OD = Prices on demand

* VASCO Climate Control (VCC App). Thanks to the VASCO Climate Control (VCC App) you can log in anywhere and at any time and set your optimal indoor comfort. For more information see p. 5.



DOMOTICS CONTROL

Radiator without regulation + BAS connector (white or grey) **(BAS connector to be ordered separately)**



BAS CONNECTOR

colour	ref. nr.	price €
white	1184 248 0000 9016	39
grey	1184 248 0000 7047	43

The radiator (with BAS connector) may only be used in combination with a **building management system** (domotics) or **external thermostat** equipped with: a weekly programme + open window detection or adaptive start control or remote control, in order to satisfy the European ECO Design Directive 2015/1188.

PRICE GROUP: VPG7 - ELECTRIC RADIATORS

HOW TO ORDER ZANA BATHROOM ELECTRIC

HOW TO ORDER

1. Choose the desired model of the radiator in the following table.
2. Select the desired control (see explanation bottom left) - depending on the desired control, extra accessories will have to be ordered as well.
3. **The total price is determined by the type of device chosen and the accessories.**

HOW TO FORM A CORRECT ORDER CODE

Delivery time 15 - 30 working days (transport duration not included)

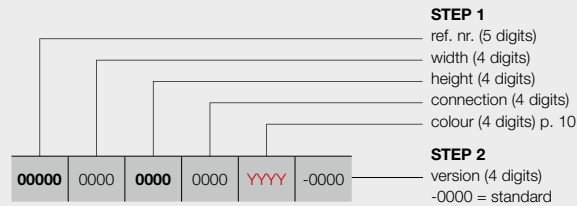

manual control

With E-Volve E-V-Basic (white or grey) **(to be ordered separately)**
 With E-Volve E-V-RF (white or grey) **(to be ordered separately)**

VCC App* control

The radiator can only be operated via the E-Volve E-V-WIFI (white or grey) **(to be ordered separately)** (including provided BAS connector)

domotics control

radiator without regulation + BAS connector (white or grey) **(to be ordered separately)**

VASCO

STEP 1 Choose the model of radiator



PRICE GROUP: VPG7 - ELECTRIC RADIATORS

REFERENCE CODE CUSTOM MADE ZANA BATHROOM	TECHNICAL DATA					STANDARD COLOUR	OTHER COLOURS
	tubes	width (L mm)	height (H mm)	weight (kg)	electr. resistance (Watt)	price RAL 9016 (€)	price colour (€)
REF. NR. ZANA BATHROOM ZBD-EL : 11336							
11336	0500	0984 1344 1824	0000	YYYY	-0000	1080	1242 1396 1549

Please indicate colour when ordering (YYYY)

EXPORT. Prices in Euro (excl. VAT)

STEP 2 You choose the accessories

Depending on the desired control you have to order extra accessories. See page to the left.

STEP 3 Total price = price of electric radiator + price of accessories

E-BANO (BM-EL)



NOT AVAILABLE
OUTSIDE THE
EU



Height: 75 mm
Width: 155 mm
Depth: 40 mm

TYPES

- Straight (BM-EL)

TUBES

- Horizontal, round \varnothing 22 mm

COLLECTORS

- Vertical, D-profile 34 x 34 mm

COLOURS

- Standard colour white RAL 9016
- Not available in other colours

BRACKETS

- Wall brackets standard

SPECIAL

- Controller included in the price
- Setting temperature in the right collector, pre-mounted
- Prefilled radiator with special fluid (anti-freeze up to -10°C)

TECHNICAL

- Electrically laser welded (invisible weld seams)
- KTL priming coat, powder coating
- Operating voltage: 230V AC, 50 Hz
- Control of room temperature from 5°C to 30°
- Control of the room temperature according different modes: auto / comfort / eco / frost protection
- Mode auto: 9 preprogrammed weekly programs and 4 that you can set yourself
- BOOST cycle duration: 2 hours
- IPX4 Class II
- Power cable: 1,2 m: brown = phase, blue = neutral, black = command wire (to be used only in France; should be shielded in case of non-use). Preferably use a direct fixed wall outlet.
- Indicator of open window detection and self-adjusting temperature control
- Control can be mounted onto the radiator at the bottom right-hand side (included in the price).
- Double insulated devices do not have earthing.
- Dimension control: H = 75mm, W = 155mm, D = 40mm

AVAILABLE VERSIONS



MANUAL CONTROL

**-0000 = radiator with built-in control
(included in the price)**



HOW TO ORDER

HOW TO FORM A CORRECT ORDER CODE

Delivery time 15 - 30 working days (transport duration not included)

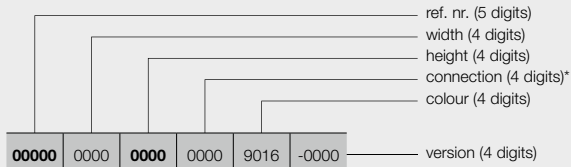

ref. nr. (5 digits)
width (4 digits)
height (4 digits)
connection (4 digits)*
colour (4 digits)

version (4 digits)

manual control

-0000 = radiator with built-in control
(included in the price)

* always connection 0000 for pure electrical radiators

ORDER CODE STOCK RADIATOR

Delivery time 5 working days
(transport duration not included)

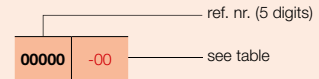

ref. nr. (5 digits)

see table

Choose the model of radiator



PRICE GROUP: VPG7 - ELECTRIC RADIATORS

REFERENCE CODE CUSTOM MADE E-BANO	TECHNICAL DATA					STANDARD COLOUR
	tubes	width (L mm)	height (H mm)	weight (kg)	electr. resistance (Watt)	short ref. nr. RAL 9016 stock
REF. NR. E-BANO BM-EL : 11342						
11342	0500	0878 1274 1714	0000	9016	-0000	18 500 878 13,60 500 11342-05
						26 500 1274 19,50 750 11342-06
						35 500 1714 26,00 1000 11342-07
11342	0600	1802	0000	9016	-0000	37 600 1802 30,90 1250 11342-08

Prices on demand
Controller included in the price!



NOT AVAILABLE
OUTSIDE THE
EU

ELECTRIC PANEL RADIATORS **E-PANEL** (EP-H-FL, EP-H-RIB, EP-V-FL)

VASCO



EP-V-FL

RECOMMENDED FOR
BATHROOM AND KITCHEN
IN OPTION



towel rail (400 mm)
ref. nr. see p. 104
price €94

Other accessories, see p. 104

ASSORTMENT

- A wide range of E-Panels is available, with capacities suited to each home. There are 7 horizontal models, ranging from 500 W to 2000 W. Their height is always 600 mm, their length varies from 500 mm to 1200 mm. There is also a vertical model from 750-1750 W. The radiators are available in white (RAL 9016) or colour, and you can choose between a ribbed horizontal version (EP-H-RIB) and a flat horizontal version (EP-H-FL). A flat vertical version (EP-V-FL) is also available.

COLOURS

- Standard colour white RAL 9016
- Not available in S600 (fine texture white)
- Extensive colour chart see p. 10

OPERATION

- Operating voltage: 230V AC, 50 Hz
- Weekly and daily programming
- Control of room temperature from 7°C to 30°C
- Auto, Comfort, Eco or frost protection mode
- Set programmes P1, P2 and P3 can be changed
- Cable length: 0.8 m (preferably use a direct fixed wall outlet)
- Energy-consumption indication
- Indicator of open window detection
- Control mounted: right side (-0000) or left side (-8A00) of the radiator (included in the price).
- Connecting the receiver: brown = live, blue = neutral and black = command wire (to be used only in France; should be shielded in case of non-use)
- Double insulated devices do not have earthing.

TECHNICAL

- IPX4 Class II

ACCESSORIES

- See p. 104

TECHNICAL DRAWINGS

- See p. 99

AVAILABLE VERSIONS

PRICE GROUP: VPG7 - ELECTRIC RADIATORS

MANUAL CONTROL

-0000 = radiator with built-in control right (included in the price)



-8A00 = radiator with built-in control left (included in the price)

VCC APP* CONTROL

-0018 = the radiator (with cable and schuko plug 90°) can only be operated via the optional E-Volve E-V-WIFI (white or grey) (E-Volve E-V-WIFI to be ordered separately)



E-VOLVE E-V-WIFI

colour	ref. nr.	price €
white	1184 007 0000 9016	OD
grey	1184 007 0000 7047	OD

One E-Volve E-V-WIFI per radiator.

OD = Prices on demand

* **VASCO Climate Control (VCC App)**. Thanks to the VASCO Climate Control (VCC App) you can log in anywhere and at any time and set your optimal indoor comfort. For more information see p. 5.

DOMOTICS CONTROL

-0018 = radiator without control, with cable and schuko plug 90°

This radiator (with cable and schuko plug 90°) may only be used in combination with a **building management system** (domotics) or **external thermostat** equipped with: a weekly programme + open window detection or adaptive start control or remote control, in order to satisfy the European ECO Design Directive 2015/1188.

HOW TO ORDER E-PANEL HORIZONTAL (EP-H-FL)

HOW TO ORDER

1. Choose the desired model of the radiator in the following table.
2. Select the desired control (see explanation bottom left) - depending on the desired control, extra accessories will have to be ordered as well.
3. **The total price is determined by the type of device chosen and any accessories.**

HOW TO FORM A CORRECT ORDER CODE

Delivery time 15 - 30 working days (transport duration not included)

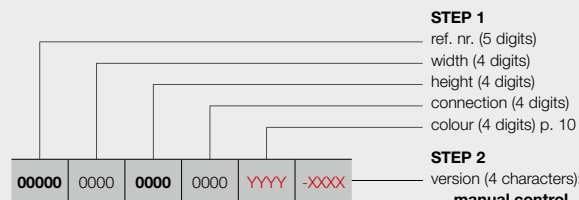

STEP 1

ref. nr. (5 digits)
width (4 digits)
height (4 digits)
connection (4 digits)
colour (4 digits) p. 10

STEP 2

version (4 characters):

manual control

- 0000 = radiator with built-in control **right** (included in the price)
- 8A00 = radiator with built-in control **left** (included in the price)
- (price -0000 = price -8A00)

VCC App* control

- 0018 = the radiator (with cable and schuko plug 90°) can only be operated via the optional E-Volve E-V-WIFI (white or grey) (to be ordered separately)

domotics control

- 0018 = radiator without control, with cable and schuko plug 90°



EP-H-FL

ORDER CODE STOCK RADIATOR

Delivery time 5 working days (transport duration not included)

Stock radiators only possible in version with built-in control right (-0000)!

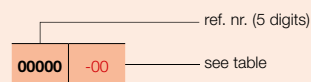

STEP 1 Choose the model of radiator



PRICE GROUP: VPG7 - ELECTRIC RADIATORS

REFERENCE CODE CUSTOM MADE E-PANEL	TECHNICAL DATA				STANDARD COLOUR		OTHER COLOURS
	width (L mm)	height (H mm)	weight (kg)	electr. resistance (Watt)	price RAL 9016 (€)	short ref. nr. RAL 9016 stock	price colour (€)
REF. NR. E-PANEL HORIZONTAL EP-H-FL : 11339							
11339 0500 0600 0000 YYY Y -0000	500	600	20,00	500	714	11339-01	821
11339 0600 0600 0000 YYY Y -0000	600	600	24,00	750	774	-	890
11339 0800 0600 0000 YYY Y -0000 -0018	800	600	31,00	1000	833	11339-02	958
					OD	-	OD
11339 1000 0600 0000 YYY Y -0000	1000	600	38,10	1250	892	-	1026
11339 1001* 0600 0000 YYY Y -0000 -0018	1001*	600	38,10	1500	966	11339-03	1111
					OD	-	OD
11339 1200 0600 0000 YYY Y -0000	1200	600	46,00	1750	1043	-	1199
11339 1201** 0600 0000 YYY Y -0000 -0018	1201**	600	46,00	2000	1118	11339-04	1286
					OD	-	OD

Please indicate colour when ordering (YYYY)

* Actual width = 1000 mm

** Actual width = 1200 mm

EXPORT. Prices in Euro (excl. VAT)

OD = Prices on demand

STEP 2 You choose the accessories

Depending on the desired control you may have to order extra accessories. See page to the left.

STEP 3 Total price = price of electric radiator + price of accessories



NOT AVAILABLE
OUTSIDE THE
EU

HOW TO ORDER E-PANEL HORIZONTAL (EP-H-RIB)

HOW TO ORDER

1. Choose the desired model of the radiator in the following table.
2. Select the desired control (see explanation p. 72) - depending on the desired control, extra accessories will have to be ordered as well.
3. **The total price is determined by the type of device chosen and any accessories.**

HOW TO FORM A CORRECT ORDER CODE

Delivery time 15 - 30 working days (transport duration not included)

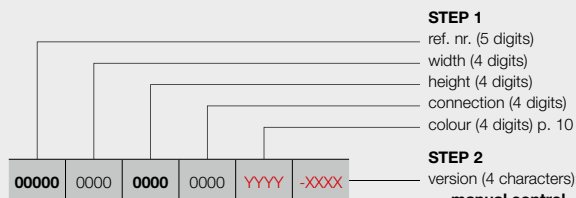

EP-H-RIB

manual control

-0000 = radiator with built-in control **right**
(included in the price)

-8A00 = radiator with built-in control **left**
(included in the price)
(price -0000 = price -8A00)

VCC App* control

-0018 = the radiator (with cable and schuko plug 90°) can only be operated via the optional E-Volve E-V-WIFI (white or grey) **(to be ordered separately)**

domotics control

-0018 = radiator without control, with cable and schuko plug 90°

ORDER CODE STOCK RADIATOR

Delivery time 5 working days (transport duration not included)

Stock radiators only possible in version with built-in control right (-0000)!

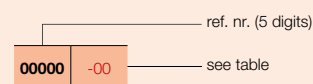

STEP 1 Choose the model of radiator



PRICE GROUP: VPG7 - ELECTRIC RADIATORS

REFERENCE CODE CUSTOM MADE E-PANEL	TECHNICAL DATA				STANDARD COLOUR		OTHER COLOURS		
	width (L mm)	height (H mm)	weight (kg)	electr. resistance (Watt)	price RAL 9016 (€)	short ref. nr. RAL 9016 stock	price colour (€)		
REF. NR. E-PANEL HORIZONTAL EP-H-RIB : 11340									
11340	0500	0600	0000	YYY	-0000	500	607	11340-01	698
11340	0600	0600	0000	YYY	-0000	600	659	-	758
11340	0800	0600	0000	YYY	-0000	800	708	11340-02	814
					-0018	OD	-	OD	
11340	1000	0600	0000	YYY	-0000	1000	758	-	872
11340	1001*	0600	0000	YYY	-0000	1001*	823	11340-03	946
					-0018	OD	-	OD	
11340	1200	0600	0000	YYY	-0000	1200	887	-	1020
11340	1201**	0600	0000	YYY	-0000	1201**	951	11340-04	1094
					-0018	OD	-	OD	

Please indicate colour when ordering (YYY)

* Actual width = 1000 mm

** Actual width = 1200 mm

EXPORT. Prices in Euro (excl. VAT)

OD = Prices on demand

STEP 2 You choose the accessories

Depending on the desired control you may have to order extra accessories. See p. 72.

STEP 3 Total price = price of electric radiator + price of accessories



NOT AVAILABLE
OUTSIDE THE
EU

HOW TO ORDER E-PANEL VERTICAL (EP-V-FL)

HOW TO ORDER

1. Choose the desired model of the radiator in the following table.
2. Select the desired control (see explanation p. 72) - depending on the desired control, extra accessories will have to be ordered as well.
3. **The total price is determined by the type of device chosen and any accessories.**

HOW TO FORM A CORRECT ORDER CODE

Delivery time 15 - 30 working days (transport duration not included)



EP-V-FL

- manual control**
-0000 = radiator with built-in control right
(included in the price)
-8A00 = radiator with built-in control left
(included in the price)
(price -0000 = price -8A00)
- VCC App* control**
-0018 = the radiator (with cable and schuko plug 90°) can only be operated via the optional E-Volve E-V-WIFI (white or grey) **(to be ordered separately)**
- domotics control**
-0018 = radiator without control, with cable and schuko plug 90°

ORDER CODE STOCK RADIATOR

Delivery time 5 working days (transport duration not included)

Stock radiators only possible in version with built-in control right (-0000)!

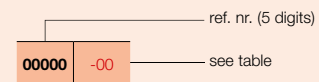

STEP 1 Choose the model of radiator



PRICE GROUP: VPG7 - ELECTRIC RADIATORS

REFERENCE CODE CUSTOM MADE E-PANEL	TECHNICAL DATA				STANDARD COLOUR		OTHER COLOURS	
	width (L mm)	height (H mm)	weight (kg)	electr. resistance (Watt)	price RAL 9016 (€)	short ref. nr. RAL 9016 stock	price colour (€)	
REF. NR. E-PANEL VERTICAL EP-V-FL : 11341								
11341	0400	1800	0000	YYY	-0000 -0018	400 1800 35,00 750	783 - OD	900 - OD
11341	0400	1801*	0000	YYY	-0000 -0018	400 1801* 35,00 1000	856 - OD	11341-01 - OD
11341	0500	1800	0000	YYY	-0000 -0018	500 1800 38,00 1250	930 - OD	11341-02 - OD
11341	0500	2000	0000	YYY	-0000 -0018	500 2000 41,50 1500	1004 - OD	11341-03 - OD
11341	0600	2000	0000	YYY	-0000 -0018	600 2000 51,00 1750	1080 - OD	11341-04 - OD

Please indicate colour when ordering (YY)
* Actual height = 1800 mm

EXPORT. Prices in Euro (excl. VAT)
OD = Prices on demand

STEP 2 You choose the accessories

Depending on the desired control you may have to order extra accessories. See p. 72.

STEP 3 Total price = price of electric radiator + price of accessories



BLOWER

Technical specifications

- Thanks to the built-in motion sensor the Blower can set its own week program according to your living habits.
- Preset week programs P1, P2, P3 (can also be adjusted by the user).
- Open window detection: the radiator goes into antifreeze mode when the temperature drops suddenly, which saves money on your energy bill.
- Energy consumption indication is continuously displayed on the control screen.
- Comfort, ECO and antifreeze temperature settings.
- The Blower is pre-assembled in the factory.
- The filter can be moved to the left or the right for easy cleaning.
- Built-in electric PTC heating element of 1000 W.
- Class II device.
- LCD display with backlight.
- The control screen has an intuitive design with 5 large buttons including the manual boost button.
- Manual boost function for fast heating (duration can be programmed).
- There is a separate ON/OFF button at the bottom
- 2 versions: white and grey
- IPX4.
- Power cable (0,8 m): brown = phase, blue = neutral, black = command wire (to be used only in France; should be shielded in case of non-use)
- Certification: CE
- Optional RF thermostat available.
- **Blower not sold separately!**

BLOWER

Height: 239 mm
Width: 400 mm
Depth: 95 mm

Remember:

Number of electrical radiators on 1 RF thermostat:

- Blower: 1 RF thermostat per Blower
- Mixed (Blower or E-Volve E-V-RF): not possible

Built-in RF receiver for control via optional RF thermostat



Ref. nr. 118424100009016 **Price: € 238**

HOW TO ORDER

This is how to order a pure electrical radiator: **with Blower**

Choose the model of radiator (see pages 77-81).

Blower is available in 2 colours: white and grey.

- radiator in white: Blower white
- radiator in colour: Blower grey

RF thermostat to be ordered separately

HOW TO FORM A CORRECT ORDER CODE

Delivery time 15 - 30 working days (transport duration not included)

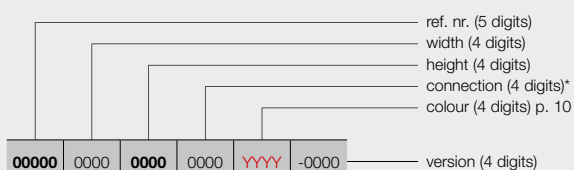

manual control

-0000 = with Blower (white or grey) + RF thermostat (in option)
(RF thermostat to be ordered separately)

* always connection 0000 for pure electrical radiators

ORDER CODE STOCK RADIATOR

Delivery time 5 working days (transport duration not included)

Stock radiators only possible in version with Blower (white or grey)!

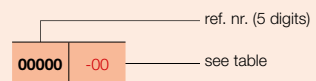



NOT AVAILABLE
OUTSIDE THE
EU

IRIS-A (HD-EL-BL-A) & BLOWER

TYPES

- Straight (HD-EL-BL-A)

TUBES

- Horizontal, round Ø 20 mm

COLLECTORS

- Vertical, D-profile 40 x 32 mm

COLOURS

- Standard colour white RAL 9016
- Extensive colour chart see p. 10

SPECIAL

- Radiator in combination with Blower (Blower included in the price), this may NOT be used in combination with a building management system (domotics) or external thermostat
- Thanks to the built-in motion sensor the Blower can set its own week program according to your living habits.
- Optional RF thermostat available
- Blower is available in 2 colours: white and grey.
 - Radiator in white: Blower white
 - Radiator in colour: Blower grey

BRACKETS

- Wall brackets in the colour of the radiator standard (included in packaging of radiator)

TECHNICAL

- Soldered (invisible soldered seams)
- ATL priming coat, powder coating
- Control of the room temperature
- IPX4 Class II

ACCESSORIES

- See p. 104

TECHNICAL DRAWINGS

- See p. 99



RECOMMENDED FOR
BATHROOM AND KITCHEN
IN OPTION



folding drying and stacking rack
(chrome)
ref. nr. see p. 104
price €135

Other accessories, see p. 104



VASCO

AVAILABLE VERSIONS



MANUAL CONTROL

Radiator with Blower (white or grey) + RF thermostat (in option) **(RF thermostat to be ordered separately)**



RF THERMOSTAT

colour	ref. nr.	price €
white	1184 241 0000 9016	238

RF thermostat only available in white



PRICE GROUP: VPG7 - ELECTRIC RADIATORS

REFERENCE CODE CUSTOM MADE IRIS-A BLOWER							TECHNICAL DATA				STANDARD COLOUR		OTHER COLOURS	
tubes	width (L mm)	height (H mm)	weight (kg)	electr. resistance (Watt)	output Blower (Watt)	price RAL 9016 (€)	short ref. nr. RAL 9016 stock	price (€)	colour	price (€)	colour			
REF. NR. IRIS-A BLOWER HD-EL-BL-A : 11392														
11392	0500	1104	0000	YYYY	-0000	28	500	1104	16,10	500	+1000	932	11392-01	1072
		1308				34	500	1308	19,00	750	+1000	986	11392-02	1134
11392	0600	1682	0000	YYYY	-0000	43	600	1682	26,20	1000	+1000	1118	11392-03	1286
		1954				51	600	1954	30,60	1250	+1000	1250	11392-04	1438
11392	0750	1954	0000	YYYY	-0000	51	750	1954	35,70	1500	+1000	1399	11392-05	1609

Please indicate colour when ordering (YYYY)

EXPORT. Prices in Euro (excl. VAT)
Blower included in the price!



NOT AVAILABLE
OUTSIDE THE
EU

AGAVE-A (HR-EL-BL-A) & BLOWER



RECOMMENDED FOR
BATHROOM AND KITCHEN
IN OPTION



folding drying and stacking rack
(chrome)
ref. nr. see p. 104
price €135

Other accessories, see p. 104

TYPES

- Straight (HR-EL-BL-A)

TUBES

- Horizontal, round Ø 20 mm

COLLECTORS

- Vertical, rear, round Ø 28 mm

COLOURS

- Standard colour white RAL 9016
- Extensive colour chart see p. 10

SPECIAL

- Radiator in combination with Blower (Blower included in the price), this may NOT be used in combination with a building management system (domotics) or external thermostat
- Thanks to the built-in motion sensor the Blower can set its own week program according to your living habits.
- Optional RF thermostat available
- Blower is available in 2 colours: white and grey.
 - Radiator in white: Blower white
 - Radiator in colour: Blower grey

BRACKETS

- Wall brackets in the colour of the radiator standard (included in packaging of radiator)

TECHNICAL

- Welded by means of resistance welding (invisible weld seams)
- ATL priming coat, powder coating
- Control of the room temperature
- IPX4 Class II

ACCESSORIES

- See p. 104

TECHNICAL DRAWINGS

- See p. 100

AVAILABLE VERSIONS

MANUAL CONTROL

Radiator with Blower (white or grey) + RF thermostat (in option) **(RF thermostat to be ordered separately)**



RF THERMOSTAT

colour	ref. nr.	price €
white	1184 241 0000 9016	238

RF thermostat only available in white



PRICE GROUP: VPG7 - ELECTRIC RADIATORS

REFERENCE CODE CUSTOM MADE AGAVE-A BLOWER	TECHNICAL DATA						STANDARD COLOUR	OTHER COLOURS
	tubes	width (L mm)	height (H mm)	weight (kg)	electr. resistance (Watt)	output Blower (Watt)	price RAL 9016 (€)	price colour (€)
REF. NR. AGAVE-A BLOWER HR-EL-BL-A : 11396								
11396	0500	1501	0000	YYYY	-0000	37 500 1501 24,30 750 +1000	1150	1323
		1798				44 500 1798 28,00 1000 +1000	1375	1581
11396	0600	1798	0000	YYYY	-0000	44 600 1798 32,20 1250 +1000	1542	1773

Please indicate colour when ordering (YYYY)

**EXPORT. Prices in Euro (excl. VAT)
Blower included in the price!**



NOT AVAILABLE
OUTSIDE THE
EU

ASTER-A (HF-EL-BL-A) & BLOWER

TUBES

- Horizontal, flat-oval 57,5 x 10 mm

COLLECTORS

- Vertical, round Ø 28 mm

COLOURS

- Standard colour white RAL 9016
- Extensive colour chart see p. 10

SPECIAL

- Thanks to the built-in motion sensor the Blower can set its own week program according to your living habits.
- Optional RF thermostat available
- Blower is available in 2 colours: white and grey.
 - Radiator in white: Blower white
 - Radiator in colour: Blower grey

BRACKETS

- Wall brackets in the colour of the radiator standard (included in packaging of radiator)

TECHNICAL

- Welded by means of resistance welding (invisible weld seams)
- ATL priming coat, powder coating
- Control of the room temperature
- IPX4 Class II

TECHNICAL DRAWINGS

- See p. 100



VASCO

AVAILABLE VERSIONS



MANUAL CONTROL

Radiator with Blower (white or grey) + RF thermostat (in option) **(RF thermostat to be ordered separately)**



RF THERMOSTAT

colour	ref. nr.	price €
white	1184 241 0000 9016	238

RF thermostat only available in white



PRICE GROUP: VPG7 - ELECTRIC RADIATORS

REFERENCE CODE CUSTOM MADE ASTER-A BLOWER							TECHNICAL DATA				STANDARD COLOUR		OTHER COLOURS	
tubes	width (L mm)	height (H mm)	weight (kg)	electr. resistance (Watt)	output Blower (Watt)	price RAL 9016 (€)	short ref. nr. RAL 9016 stock	price colour (€)			price colour (€)			
REF. NR. ASTER-A BLOWER HF-EL-BL-A : 11399														
11399	0500	1169	0000	YYYY	-0000	16	500	1169	21,40	500	+1000	1220	11399-01	1403
		1834				27	500	1834	33,20	750	+1000	1413	11399-02	1625
11399	0600	1834	0000	YYYY	-0000	27	600	1834	38,20	1000	+1000	1664	11399-03	1914
11399	0700	2137	0000	YYYY	-0000	31	700	2137	51,40	1250	+1000	1812	-	2084

Please indicate colour when ordering (YYYY)

EXPORT. Prices in Euro (excl. VAT)
Blower included in the price!



NOT AVAILABLE
OUTSIDE THE
EU

CARRÉ BATHROOM (CB-EL-BL) & BLOWER



RECOMMENDED FOR
BATHROOM AND KITCHEN
IN OPTION



towel rail straight (chrome)
ref. nr. see p. 104

price € 187

Other accessories, see p. 104

TUBES

- Horizontal, square 25 x 25 mm

COLLECTORS

- Vertical, round Ø 35 mm

COLOURS

- Standard colour white RAL 9016
- Extensive colour chart see p. 10

SPECIAL

- Radiator in combination with Blower (Blower included in the price), this may NOT be used in combination with a building management system (domotics) or external thermostat
- Thanks to the built-in motion sensor the Blower can set its own week program according to your living habits.
- Optional RF thermostat available
- Blower is available in 2 colours: white and grey.
 - Radiator in white: Blower white
 - Radiator in colour: Blower grey

BRACKETS

- Wall brackets in the colour RAL 9016 standard. Also in option available in the colour RAL 7016 (see p. 103).

TECHNICAL

- Welded by means of resistance welding robots (invisible weld seams)
- KTL priming coat, powder coating
- Control of the room temperature
- IPX4 Class II

ACCESSORIES

- See p. 104

TECHNICAL DRAWINGS

- See p. 101

AVAILABLE VERSIONS

MANUAL CONTROL

Radiator with Blower (white or grey) + RF thermostat
(in option) **(RF thermostat to be ordered separately)**



RF THERMOSTAT

colour	ref. nr.	price €
white	1184 241 0000 9016	238

RF thermostat only available in white



PRICE GROUP: VPG7 - ELECTRIC RADIATORS

REFERENCE CODE CUSTOM MADE CARRÉ	TECHNICAL DATA						STANDARD COLOUR		OTHER COLOURS					
	tubes	width (L mm)	height (H mm)	weight (kg)	electr. resistance (Watt)	output Blower (Watt)	price RAL 9016 (€)	short ref. nr. RAL 9016 stock	price colour (€)					
REF. NR. CARRÉ CB-EL-BL : 11319														
11319	0500	0747	0000	YYYY	-0000	21	500	747	21,30	500	+1000	1252	-	1440
		1137				32	500	1137	30,90	750	+1000	1454	11319-01	1672
11319	0600	1377	0000	YYYY	-0000	40	600	1377	44,05	1000	+1000	1646	-	1893
		1737				50	600	1737	52,20	1250	+1000	1840	11319-02	2116

Please indicate colour when ordering (YYYY)

EXPORT. Prices in Euro (excl. VAT)
Blower included in the price!



NOT AVAILABLE
OUTSIDE THE
EU

NIVA-A (NIVA-EL-BL-A) & BLOWER

COLOURS

- Standard colour S600 (fine texture white) (RAL 9016: no extra charge 15%)
- Extensive colour chart see p. 10



RECOMMENDED FOR
BATHROOM AND KITCHEN
IN OPTION



towel rail MULTI+ right (S600)
ref. nr. see p. 104
price €204

towel rail MULTI+ right (RAL 9005)
ref. nr. see p. 104
price €204

Other accessories, see p. 104

SPECIAL

- Radiator in combination with Blower (Blower included in the price), this may NOT be used in combination with a building management system (domotics) or external thermostat
- Thanks to the built-in motion sensor the Blower can set its own week program according to your living habits.
- Optional RF thermostat available
- Blower is available in 2 colours: white and grey.
 - Radiator in white: Blower white
 - Radiator in colour: Blower grey
- Lacquered front plate

BRACKETS

- Wall brackets standard

TECHNICAL

- KTL priming coat, powder coating
- Control of the room temperature
- IPX4 Class II

ACCESSORIES

- See p. 104

TECHNICAL DRAWINGS

- See p. 101

VASCO

AVAILABLE VERSIONS



MANUAL CONTROL

Radiator with Blower (white or grey) + RF thermostat
(in option) **(RF thermostat to be ordered separately)**



RF THERMOSTAT

colour	ref. nr.	price €
white	1184 241 0000 9016	238

RF thermostat only available in white



PRICE GROUP: VPG7 - ELECTRIC RADIATORS

REFERENCE CODE CUSTOM MADE NIVA-A BLOWER	TECHNICAL DATA						STANDARD COLOUR		OTHER COLOURS						
	tubes	width (L mm)	height (H mm)	weight (kg)	electr. resistance (Watt)	output Blower (Watt)	price S600* (€)	short ref. nr. S600 stock	price colour (€)						
REF. NR. NIVA-A BLOWER NIVA-EL-BL-A : 11402															
11402	0520	0753	0000	YYYY	-0000	-	520	753	20,10	300	+1000	1119	-	1287	
		1116					-	520	1116	28,90	500	+1000	1250	-	1438
11402	0620	1298	0000	YYYY	-0000	-	620	1298	37,80	750	+1000	1368	11402-02	1573	
		1842				-	620	1842	52,90	1000	+1000	1485	11402-01	1708	
11402	0720	1842	0000	YYYY	-0000	-	720	1842	59,50	1250	+1000	1622	-	1865	

Please indicate colour when ordering (YYYY)

* RAL 9016: no extra charge 15%
EXPORT. Prices in Euro (excl. VAT)
Blower included in the price!



NOT AVAILABLE
OUTSIDE THE
EU

Mixed electric radiators are radiators that can be used to heat alternately either via a central heating (CH) installation or electrically.

- CH radiator equipped by a professional with an electric element and regulation
- CH radiator with Blower pre-assembled in the factory



Carré Bathroom CV, Traffic White, E-Volve White



NOT AVAILABLE
OUTSIDE THE
EU

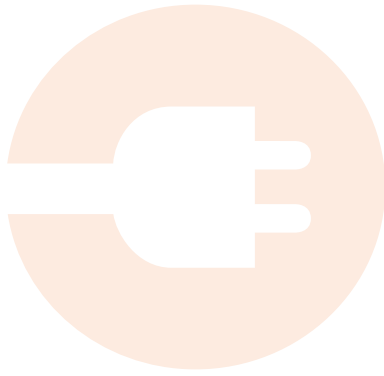

Mixed radiators



Niva Mixed



Mixed radiators are radiators that you can use alternately to heat via the Central Heating installation or to heat electrically. These radiators are highly suitable in spring and autumn when the central heating boiler is usually not working. You can then choose to heat electrically. Ideal for use in the bathroom.

The radiators listed below can be used as mixed radiators:

- Iris-A (HDM-A/HDRM-A)
- Agave-A (HRM-A)
- Aster-A (HF-A)
- Carré Bathroom (CB)
- Zana Bathroom (ZBD)
- Bano (BM/BMR/BMmm/BMRmm)

If you choose to heat via the central heating system then the electrical controller has to be switched off. If the electrical resistance is still heating when the central heating system is working, this can damage the electrical resistance. If you choose to heat electrically (without using the central heating system) then the thermostatic head must be closed. With a closed radiator valve, however, free expansion to the central heating system's expansion tank via the return pipe must be ensured. The connection possibility depends on the connection system and the width of the radiator.

We differentiate between the following:

For a two-pipe system with connection:

- 1-8: possible for all widths
- mm: the width of the radiator must be greater than 600 mm
- MM: the width of the radiator must be greater than 600 mm

For a one-pipe system with connection:

- mm: the width of the radiator must be greater than 600 mm



BLOWER MIXED RADIATORS

These CH radiators are equipped with a Blower, which can quickly furnish (extra) heat during the transitional seasons.

The electrical features of the mixed radiator are the same as the features of the purely electrical radiator and therefore, should comply with the same regulations.



Built-in RF receiver for control via optional RF thermostat



Ref. nr. 1184 241 0000 9016 **Price: € 238**

Technical specifications Blower see p. 76



NOT AVAILABLE
OUTSIDE THE
EU

HOW TO ORDER MIXED RADIATORS

MIXED RADIATORS & E-VOLVE / BAS CONNECTOR

HOW TO ORDER

Please proceed as follows to order a mixed radiator:

Step 1: Choose the model of radiator. The radiators listed below can be used as mixed radiators:

- Iris-A (HDM-A/HDRM-A)
- Agave-A (HRM-A)
- Aster-A (HF-A)
- Carré Bathroom (CB)
- Zana Bathroom (ZBD)
- Bano (BM/BMR/BMmm/BMRmm)



Step 2: Choose the accessory you would like for the radiator, taken the Watt into account. You can choose between the E-V-Basic and E-V-RF controllers or the BAS connector in the colours white or grey (see p. 87).

Total price mixed radiator = price radiator + price accessory.

HOW TO FORM A CORRECT ORDER CODE

Delivery time 15 - 30 working days (transport duration not included)

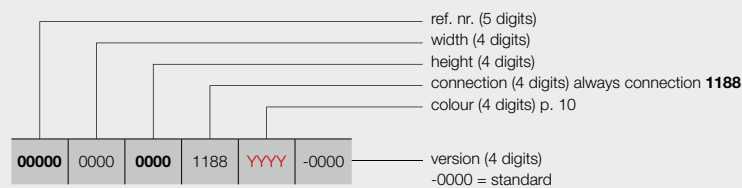

CORRESPONDING CONTROLLER

See p. 87: specify reference number

ORDER CODE STOCK RADIATOR

Delivery time 5 working days (transport duration not included)

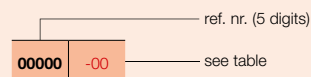

CORRESPONDING CONTROLLER

See p. 87: specify reference number

BLOWER MIXED RADIATORS

HOW TO ORDER

This is how to order a CH radiator **with Blower**:

Choose the model of CH radiator, Blower included (see pages 92 - 93).

Blower is available in 2 colours: white and grey.

- radiator in white: Blower white
- radiator in colour: Blower grey

RF thermostat to be ordered separately



HOW TO FORM A CORRECT ORDER CODE

Delivery time 15 - 30 working days (transport duration not included)

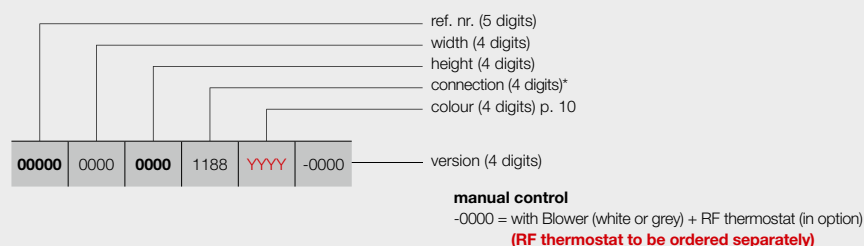

* always connection 1188 for CH radiators with Blower

ORDER CODE STOCK RADIATOR

Delivery time 5 working days (transport duration not included)

Stock radiators only possible in version with Blower (white or grey)!

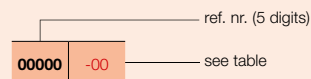

1. POSSIBLE CONNECTIONS FOR MIXED RADIATORS

1.1. CONNECTING THE CH SYSTEM TO THE **CENTRAL CONNECTION** (TWO-PIPE SYSTEM)

The radiators listed below can be connected to the central connection:

- Iris-A (HDM-A/HDRM-A)
- Agave-A (HRM-A)
- Aster-A (HF-A)
- Carré Bathroom (CB)
- Zana Bathroom (ZBD)
- Bano (BMmm/BMRmm)



Connection with standard stop valves

The width of the radiator is ≤ 600 mm:

Note: The VASCO range does not include stop valves and thermostatic heads.

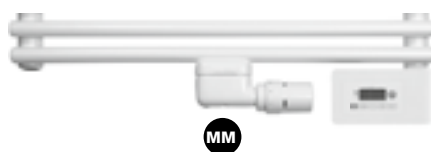

The width of the radiator is greater than 600 mm:

Note: If you use the mm valve, then the radiator can also be connected to a one-pipe system.

Note: With a closed radiator valve, however, free expansion to the central heating system's expansion tank via the return pipe must be ensured (in the summer).

VASCO



Connection with 1-8 designer valve set

1.2. CONNECTING THE CH SYSTEM TO THE **1-8 CONNECTION** (TWO-PIPE SYSTEM)

The radiators listed below can be connected via 1-8:

- Iris-A (HDM-A/HDRM-A)
- Agave-A (HRM-A)
- Carré Bathroom (CB)
- Zana Bathroom (ZBD)
- Bano (BM/BMR)

Note: The VASCO range does not include valves.



Supply right and return left

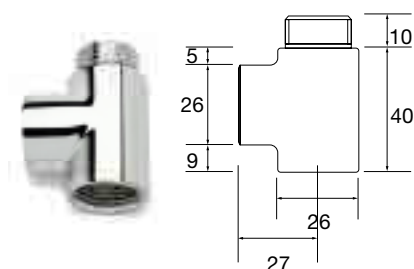

T-piece

When using a T-piece, the connection dimensions are different.

Remember: if there is a flow tube, it has to be removed.

Note: If you make the connection with the 1-8 connection, the radiator can only be connected to a two-pipe system.

Note: With a closed radiator valve, however, free expansion to the central heating system's expansion tank via the return pipe must be ensured (in the summer).

Ref. nr. 11DV00002 Price: € 28



NOT AVAILABLE
OUTSIDE THE
EU

2. ELECTRICAL ACCESSORIES FOR MIXED RADIATORS

2.1. E-VOLVE E-V-BASIC REGULATION



E-VOLVE E-V-BASIC REGULATION

Height: 75 mm
Width: 140 mm
Depth: 35 mm

- Operating voltage: 230V AC, 50 Hz
- Weekly and daily programming
- Control of room temperature from 7°C to 30°C
- Boost command: standard 60 minutes
- Auto, Comfort, Eco or frost protection mode
- Set programmes P1, P2 and P3 can be changed
- IPX4 Class II
- Cable length: 0.8 m (preferably use a direct fixed wall outlet)
- Energy-consumption indication
- Indicator of open window detection
- Control can be mounted onto the radiator at the bottom right-hand side

Remember:

- Connecting the E-V-Basic control: brown = live, blue = neutral and black = command wire (to be used only in France; should be shielded in case of non-use)
- Double insulated devices have no earthing.
- Connection with RF thermostat not possible

PRICE GROUP: VPG7 - ELECTRIC RADIATORS

type	emission (Watt)	ref. nr. (white)	price € (white)	ref. nr. (grey)	price € (grey)
E-V-Basic	300	1184 224 0000 9016	343	1184 224 0000 9006	394
E-V-Basic	500	1184 225 0000 9016	364	1184 225 0000 9006	420
E-V-Basic	750	1184 226 0000 9016	388	1184 226 0000 9006	444
E-V-Basic	1000	1184 227 0000 9016	409	1184 227 0000 9006	471
E-V-Basic	1250	1184 228 0000 9016	433	1184 228 0000 9006	497
E-V-Basic	1500	1184 229 0000 9016	455	1184 229 0000 9006	523

2.2. E-VOLVE E-V-RF REGULATION



E-VOLVE E-V-RF RF RECEIVER

Height: 75 mm
Width: 140 mm
Depth: 35 mm

E-VOLVE E-V-RF RF THERMOSTAT

Height: 95 mm
Width: 120 mm
Depth: 25 mm

- Operating voltage of the receiver: 230V AC, 50 Hz
- Thermostat: 2x Alkaline 1.5V
- Weekly and daily programming
- Control of room temperature from 7°C to 30°C
- Boost command: standard 60 minutes
- Auto, Comfort, Eco or frost protection mode
- Set programmes P1, P2 and P3 can be changed
- Receiver: IPX4 Class II
- Thermostat: IP30
- Cable length: 0.8 m (preferably use a direct fixed wall outlet)
- Energy-consumption indication
- Indicator of open window detection
- Receiver can be mounted onto the radiator at the bottom right-hand side
- RF communication between the receiver and the thermostat (to be connected)

Remember:

- Connecting the E-V-RF RF receiver: brown = live, blue = neutral and black = command wire (to be used only in France; should be shielded in case of non-use)
- Double insulated devices have no earthing
- The thermostat should be connected with the receiver according to the instructions in the manual of the RF thermostat.

Remember:

Number of electrical radiators on 1 RF thermostat:

- Blower: 1 RF thermostat per Blower
- E-Volve E-V-RF: up to 5 radiators per RF thermostat
- Mixed (Blower or E-Volve E-V-RF): not possible

PRICE GROUP: VPG7 - ELECTRIC RADIATORS

type	emission (Watt)	ref. nr. (white)	price € (white)	ref. nr. (grey)	price € (grey)
E-V-RF	300	1184 230 0000 9016	566	1184 230 0000 9006	650
E-V-RF	500	1184 231 0000 9016	588	1184 231 0000 9006	676
E-V-RF	750	1184 232 0000 9016	609	1184 232 0000 9006	703
E-V-RF	1000	1184 233 0000 9016	633	1184 233 0000 9006	729
E-V-RF	1250	1184 234 0000 9016	657	1184 234 0000 9006	754
E-V-RF	1500	1184 235 0000 9016	676	1184 235 0000 9006	782

For the E-V-Basic and E-V-RF controllers we use the same resistance. Only the controllers from the VASCO range can be mounted on this resistance.



BAS CONNECTOR

Height: 65 mm
Width: 35 mm
Depth: 50 mm

2.3. RESISTANCE (CLASS II) + BAS CONNECTOR

- Sleek design: white or grey
- Use environment: volume 2 or 3 of the bathroom (drawing p. 45)
- To be mounted in the radiator on the underside
- Regulator or plug not provided
- Class IPX4
- **Control of the room temperature should be ensured by an external control system, in accordance with the Eco Design Directive 2015/1188!**

PRICE GROUP: VPG7 - ELECTRIC RADIATORS

type	emission (Watt)	ref. nr. (white)	price € (white)	ref. nr. (grey)	price € (grey)
Resistance + BAS connector	300	1184 100 0000 9016	131	1184 100 0000 7047	150
Resistance + BAS connector	500	1184 101 0000 9016	137	1184 101 0000 7047	158
Resistance + BAS connector	750	1184 102 0000 9016	172	1184 102 0000 7047	199
Resistance + BAS connector	1000	1184 103 0000 9016	205	1184 103 0000 7047	238
Resistance + BAS connector	1250	1184 104 0000 9016	242	1184 104 0000 7047	276
Resistance + BAS connector	1500	1184 105 0000 9016	275	1184 105 0000 7047	318

Lengths electrical resistances:

- Resistance 300 W : 365 mm
- Resistance 500 W : 520 mm
- Resistance 750 W : 700 mm
- Resistance 1000 W : 890 mm
- Resistance 1250 W : 1080 mm
- Resistance 1500 W : 1270 mm



VASCO



VASCO

RECOMMENDED FOR
BATHROOM AND KITCHEN
IN OPTION



towel rail (aluminium)
ref. nr. see p. 104
price € 187

Other accessories, see p. 104

RECOMMENDED CONNECTION (1188)

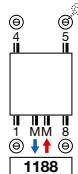

Other connection methods,
see p. 149



ref. nr. 1182 103 0000 0099
price € 218
Fittings, see p. 327

COLOURS

- Standard colour S600 (fine texture white) (RAL 9016: no extra charge 15%)
- Extensive colour chart see p. 10

SPECIAL

- CH radiator with integrated electrical resistance
- Lacquered front plate in aluminium

BRACKETS

- Wall brackets in the colour RAL 7016 (anthracite grey) standard. Also in option available in the colour S600 (see p. 146).

TECHNICAL

- Electrically welded by means of resistance welding robots (invisible weld seams)
- KTL priming coat, powder coating
- Standard operating pressure: 10 bar
- Maximum operating temperature: 110°C
- Control of the room temperature
- IPX4 Class II

ACCESSORIES

- See p. 104

TECHNICAL DRAWINGS

- See p. 102



RF receiver
at the back

AVAILABLE VERSIONS

PRICE GROUP: VPG7 - ELECTRIC RADIATORS



MANUAL CONTROL

-0000 = radiator + RF thermostat (included in the price).
The radiator can only be operated via the included RF thermostat (white).



RF THERMOSTAT

Standard version.

-0014 = radiator without RF thermostat

If you wish to operate several radiators with a single RF thermostat, it's enough to order just one radiator in the version -0000 and the other(s) in the version -0014.



VCC APP* CONTROL

-0015 = the radiator (with cable and schuko plug 90°) can only be operated via the optional E-Volve E-V-WIFI (white or grey) (E-Volve E-V-WIFI to be ordered separately)



E-VOLVE E-V-WIFI

colour	ref. nr.	price €
white	1184 007 0000 9016	OD
grey	1184 007 0000 7047	OD

One E-Volve E-V-WIFI per radiator. The radiator is operated via the E-Volve E-V-WIFI module to be ordered separately (and NOT via the RF thermostat).

OD = Prices on demand

* VASCO Climate Control (VCC App). Thanks to the VASCO Climate Control (VCC App) you can log in anywhere and at any time and set your optimal indoor comfort. For more information see p. 5.



DOMOTICS CONTROL

-0015 = radiator without control, with cable and schuko plug 90°

This radiator (with cable and schuko plug 90°) may only be used in combination with a **building management system** (domotics) or **external thermostat** equipped with: a weekly programme + open window detection or adaptive start control or remote control, in order to satisfy the European ECO Design Directive 2015/1188.

HOW TO ORDER

1. Choose the desired model of the radiator in the following table.
2. Select the desired control (see explanation bottom left) - depending on the desired control, extra accessories will have to be ordered as well.
3. **The total price is determined by the type of device chosen and any accessories.**

HOW TO FORM A CORRECT ORDER CODE

Delivery time 15 - 30 working days (transport duration not included)

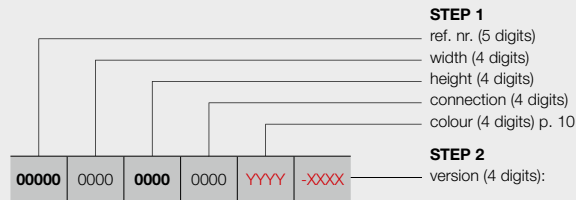

manual control

- 0000 = with RF thermostat **(included in the price)**
- 0014 = without RF thermostat

VCC App* control

- 0015 = the radiator (with cable and schuko plug 90°) can only be operated via the optional E-Volve E-V-WIFI (white or grey) **(to be ordered separately)**

domotics control

- 0015 = radiator without control, with cable and schuko plug 90°

STEP 1 Choose the model of radiator



PRICE GROUP: VPG7 - ELECTRIC RADIATORS

REFERENCE CODE CUSTOM MADE NIVA MIXED	TECHNICAL DATA									STANDARD COLOUR	OTHER COLOURS					
	tubes	width (L mm)	height (H mm)	75/65/20 (Watt) (Φ50K)	55/45/20 (Watt) (Φ30K)	n-exp.	weight (kg)	water content (l)	electr. resistance (Watt)	price S600* (€)	price colour (€)					
REF. NR. NIVA MIXED N1L1-EL-MIX : 11362																
11362	0420	1820	1188	YYYY	-0000	-	420	1820	794	413	1,28	23,40	3,70	900	964	1109
					-0014										OD	OD
					-0015										OD	OD
11362	0620	1820	1188	YYYY	-0000	-	620	1820	1124	584	1,28	34,40	5,52	1300	1066	1226
					-0014										OD	OD
					-0015										OD	OD

In conformity with EN442-1: 2014: radiators and convectors

* RAL 9016: no extra charge 15%
EXPORT. Prices in Euro (excl. VAT)
OD = Prices on demand

STEP 2 You choose the accessories

Depending on the desired control you may have to order extra accessories. See page to the left.

STEP 3 Total price = price of electric radiator + price of accessories



NOT AVAILABLE
OUTSIDE THE
EU

IRIS-A (HDM-BL-MIX-A) BLOWER MIXED



RECOMMENDED FOR
BATHROOM AND KITCHEN
IN OPTION



folding drying and stacking rack
(chrome)

ref. nr. see p. 104

price €135

Other accessories, see p. 104

RECOMMENDED CONNECTION
(1188)

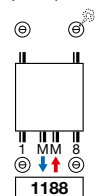

Other connection methods,
see p. 36



ref. nr. 1182 103 0000 9016

price €195

Fittings, see p. 327

TYPES

- Straight (HDM-BL-MIX-A)

TUBES

- Horizontal, round Ø 20 mm

COLLECTORS

- Vertical, D-profile 40 x 32 mm

COLOURS

- Standard colour white RAL 9016
- Extensive colour chart see p. 10

SPECIAL

- CH radiator in combination with Blower (Blower included in the price), this may NOT be used in combination with a building management system (domotics) or external thermostat
- Thanks to the built-in motion sensor the Blower can set its own week program according to your living habits.
- Optional RF thermostat available
- Blower is available in 2 colours: white and grey.
 - Radiator in white: Blower white
 - Radiator in colour: Blower grey

BRACKETS

- Wall brackets in the colour of the radiator standard (included in packaging of radiator)

TECHNICAL

- Soldered (invisible soldered seams)
- ATL priming coat, powder coating
- Control of the room temperature
- Standard operating pressure: 10 bar
- Maximum operating temperature: 110°C
- IPX4 Class II

ACCESSORIES

- See p. 104

TECHNICAL DRAWINGS

- See p. 102

AVAILABLE VERSIONS



MANUAL CONTROL

CH radiator with Blower (white or grey) + RF thermostat (in option) (RF thermostat to be ordered separately)



RF THERMOSTAT

RF thermostat only available in white

colour	ref. nr.	price €
white	1184 241 0000 9016	238



PRICE GROUP: VPG7 - ELECTRIC RADIATORS

REFERENCE CODE CUSTOM MADE IRIS-A BLOWER MIXED	TECHNICAL DATA										STANDARD COLOUR		OTHER COLOURS
	tubes	width (L mm)	height (H mm)	75/65/20 (Watt) (Ø50K)	55/45/20 (Watt) (Ø30K)	n-exp.	weight (kg)	water content (l)	output Blower (Watt)	price RAL 9016 (€)	short ref. nr. RAL 9016 stock	price colour (€)	
11393 050 130 1188 YYYYY -0000	33	500	1308	661	346	1,25	12,40	6,36	+1000	OD	-	OD	
11393 060 168 1188 YYYYY -0000	42	600	1682	996	521	1,25	16,70	9,29	+1000	OD	11393-01	OD	

REF. NR. IRIS-A BLOWER MIXED HDM-BL-MIX-A : 11393

In conformity with EN442-1: 2014: radiators and convectors
Please indicate colour when ordering (YYYY)

Blower included in the price!
OD = Prices on demand



NOT AVAILABLE
OUTSIDE THE
EU

ASTER-A (HF-BL-MIX-A) BLOWER MIXED

TUBES

- Horizontal, flat-oval 57,5 x 10 mm

COLLECTORS

- Vertical, round Ø 28 mm

COLOURS

- Standard colour white RAL 9016
- Extensive colour chart see p. 10

SPECIAL

- CH radiator in combination with Blower (Blower included in the price), this may NOT be used in combination with a building management system (domotics) or external thermostat
- Thanks to the built-in motion sensor the Blower can set its own week program according to your living habits.
- Optional RF thermostat available
- Blower is available in 2 colours: white and grey.
 - Radiator in white: Blower white
 - Radiator in colour: Blower grey

BRACKETS

- Wall brackets in the colour of the radiator standard (included in packaging of radiator)

TECHNICAL

- Welded by means of resistance welding (invisible weld seams)
- ATL priming coat, powder coating
- Control of the room temperature
- Standard operating pressure: 4 bar
- Maximum operating temperature: 110°C
- IPX4 Class II

TECHNICAL DRAWINGS

- See p. 102



RECOMMENDED CONNECTION (1188)

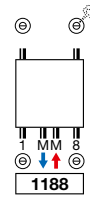

Other connection methods, see p. 36



ref. nr. 1182 103 0000 0099

price €218

Fittings, see p. 327



VASCO

AVAILABLE VERSIONS



MANUAL CONTROL

CH radiator with Blower (white or grey) + RF thermostat (in option) **(RF thermostat to be ordered separately)**



RF THERMOSTAT

RF thermostat only available in white

colour	ref. nr.	price €
white	1184 241 0000 9016	238



PRICE GROUP: VPG7 - ELECTRIC RADIATORS

REFERENCE CODE CUSTOM MADE ASTER-A BLOWER MIXED	TECHNICAL DATA									STANDARD COLOUR		OTHER COLOURS
	tubes	width (L mm)	height (H mm)	75/65/20 (Watt) (Φ50K)	55/45/20 (Watt) (Φ30K)	n-exp.	weight (kg)	water content (l)	output Blower (Watt)	price RAL 9016 (€)	short ref. nr. RAL 9016 stock	price colour (€)
	16	500	1169	564	301	1,21	16,40	4,10	+1000	OD	-	OD
	27	600	1834	1014	541	1,21	29,30	7,75	+1000	OD	11400-01	OD

REF. NR. ASTER-A BLOWER MIXED HF-BL-MIX-A : 11400

11400	050	116	1188	YYYY	-0000	16	500	1169	564	301	1,21	16,40	4,10	+1000	OD	-	OD
11400	060	183	1188	YYYY	-0000	27	600	1834	1014	541	1,21	29,30	7,75	+1000	OD	11400-01	OD

In conformity with EN442-1: 2014: radiators and convectors
Please indicate colour when ordering (YYYY)

Blower included in the price!
OD = Prices on demand

BEAMS MONO-EL (BEAMS MONO-EL)

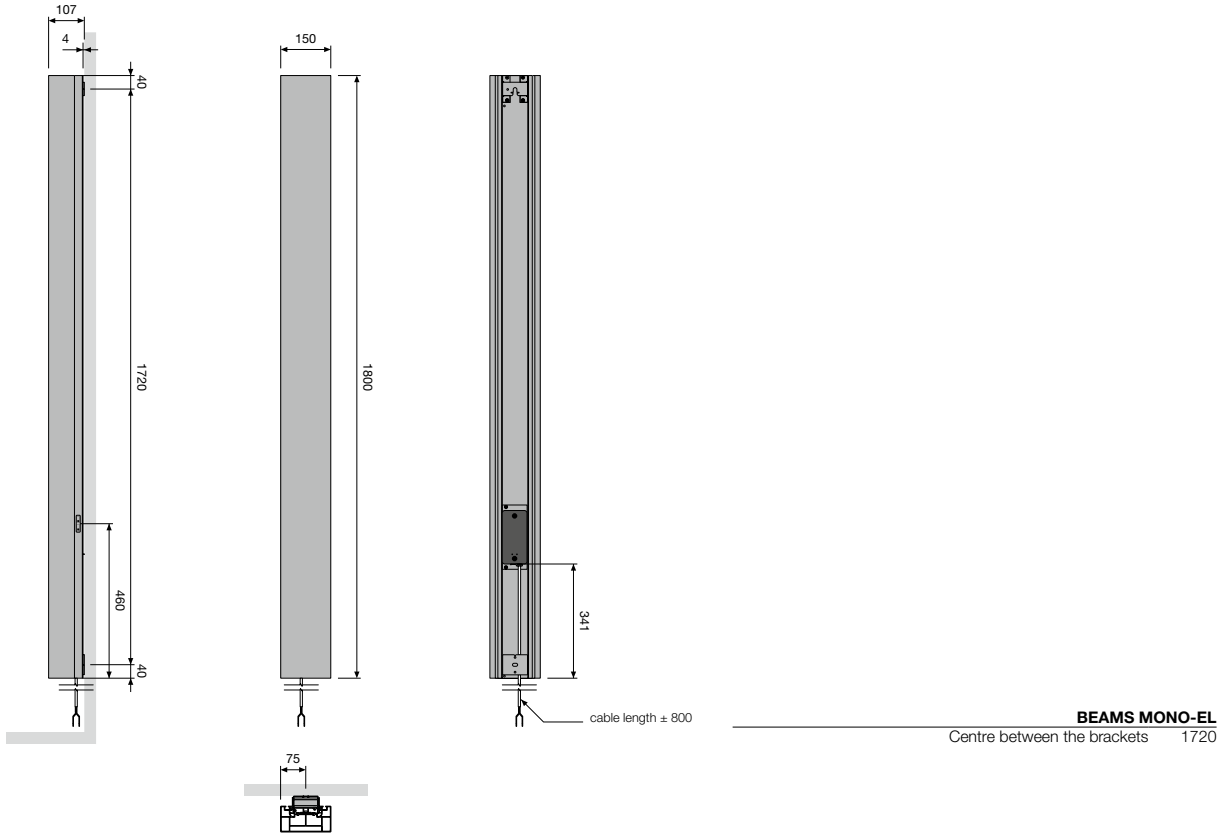

ONI-EL (O-P-EL, O-NP-EL)

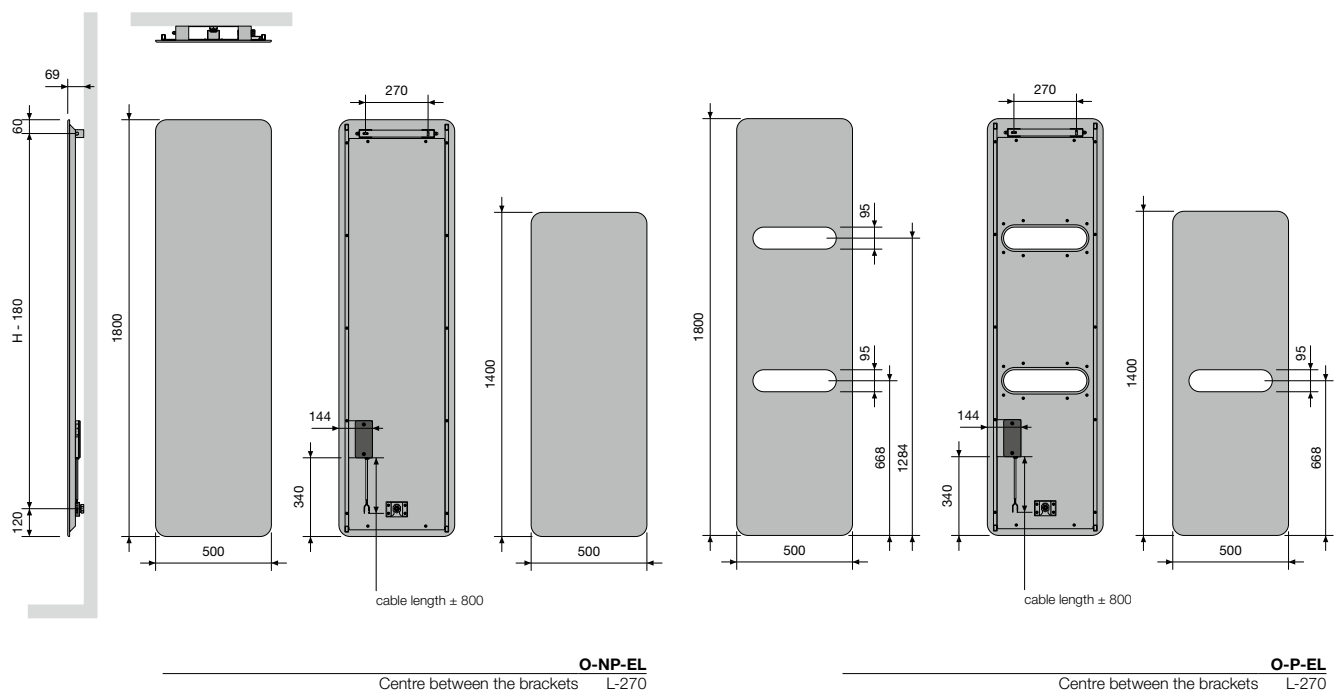

VASCO



NOT AVAILABLE
OUTSIDE THE
EU

NIVA-EL (NIVA-EL)

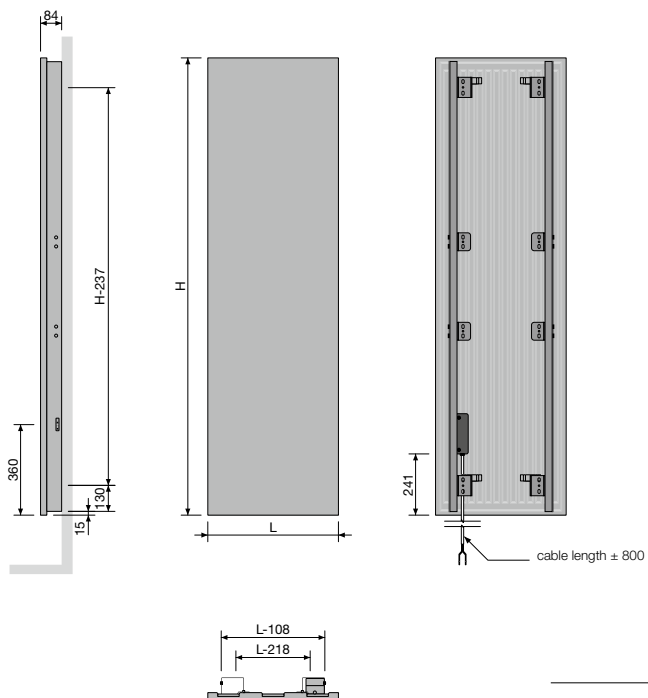

NIVA-EL
Centre between the brackets L-218 H-237

IRIS-A (HD-EL-A, HDR-EL-A)

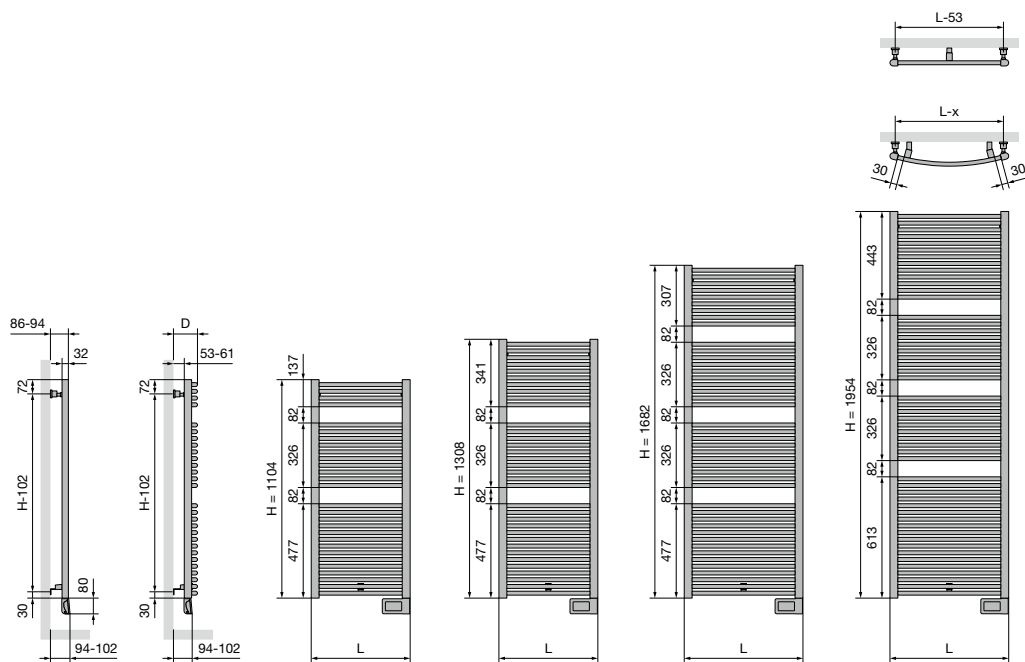

HD-EL-A
Width (L) 500 600 750
Centre between the brackets L-53 H-102

HDR-EL-A
Width (L) 498 598
Distance between wall and front of the radiator (D) 101-109 104-112
Centre horizontal between the brackets 452 552
Centre vertical between the brackets H-102





NOT AVAILABLE
OUTSIDE THE
EU

PURE ELECTRICAL RADIATORS TECHNICAL DRAWINGS

AGAVE-A (HR-EL-A)

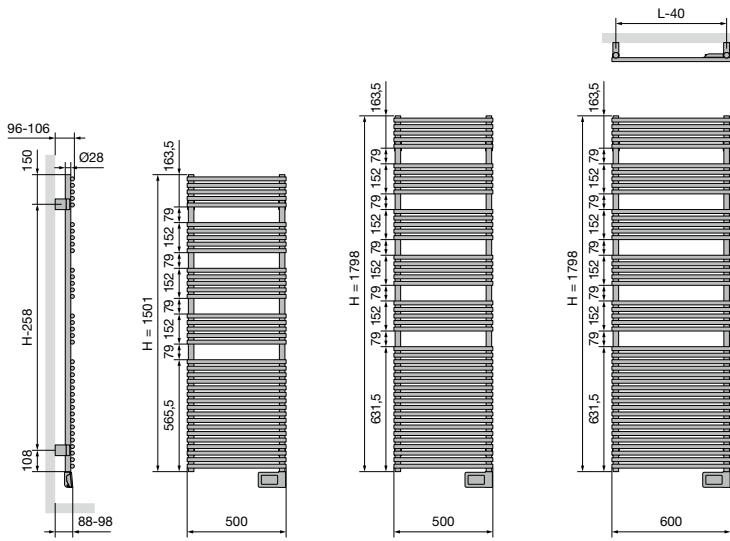

HR-EL-A

Centre between the brackets L-40 H-258

ASTER-A (HF-EL-A)

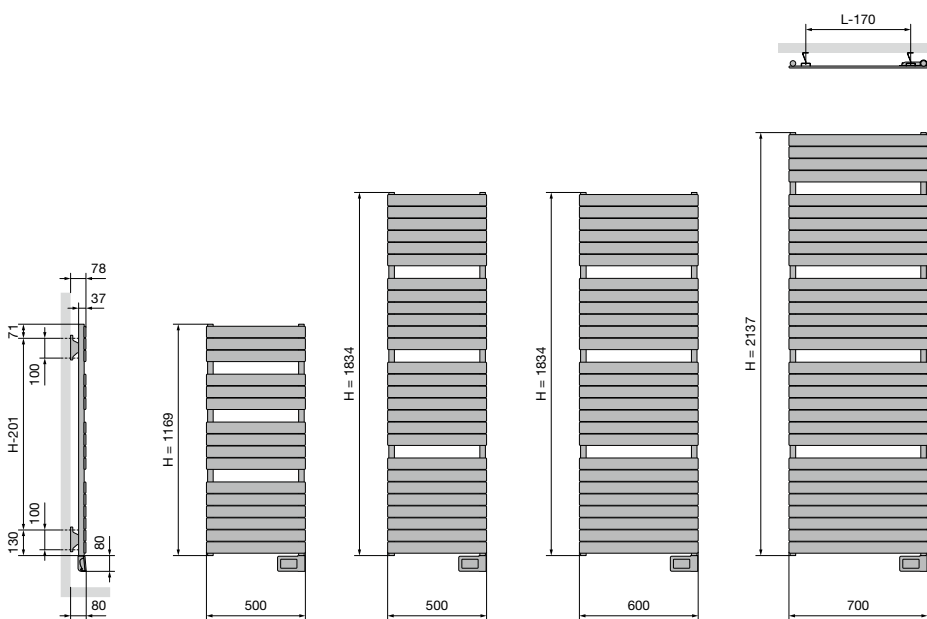

HF-EL-A

Centre between the brackets L-170 H-201

VASCO



NOT AVAILABLE
OUTSIDE THE
EU

PURE ELECTRICAL RADIATORS TECHNICAL DRAWINGS

CARRÉ BATHROOM (CB-EL)

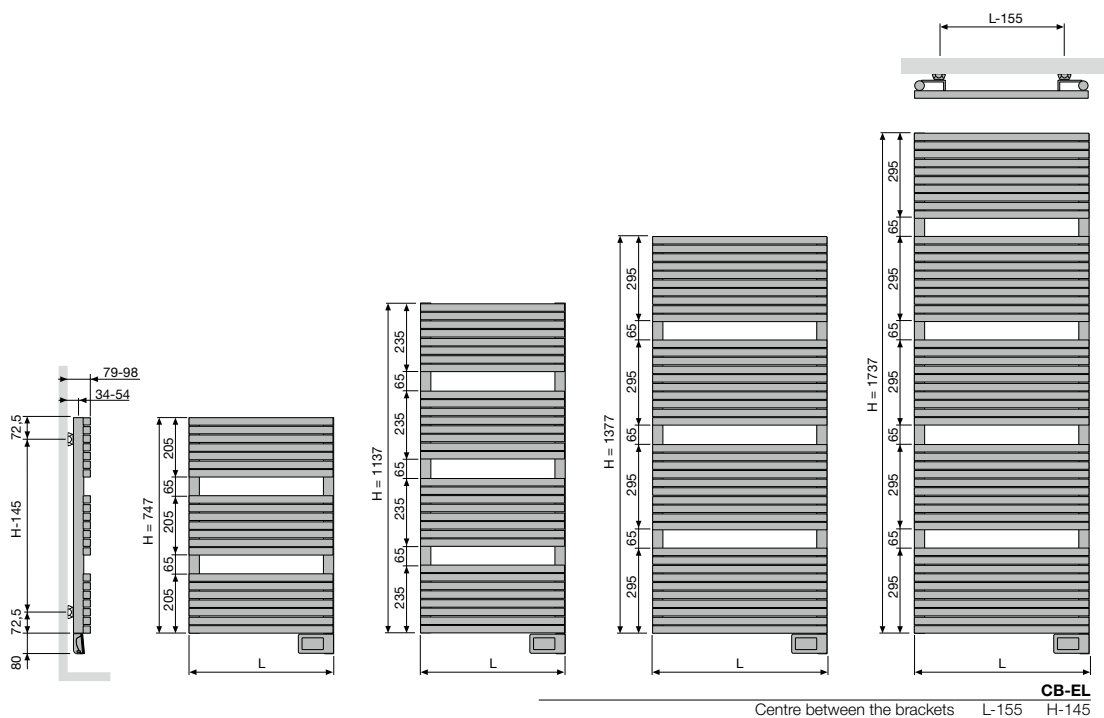

ZANA BATHROOM (ZBD-EL)

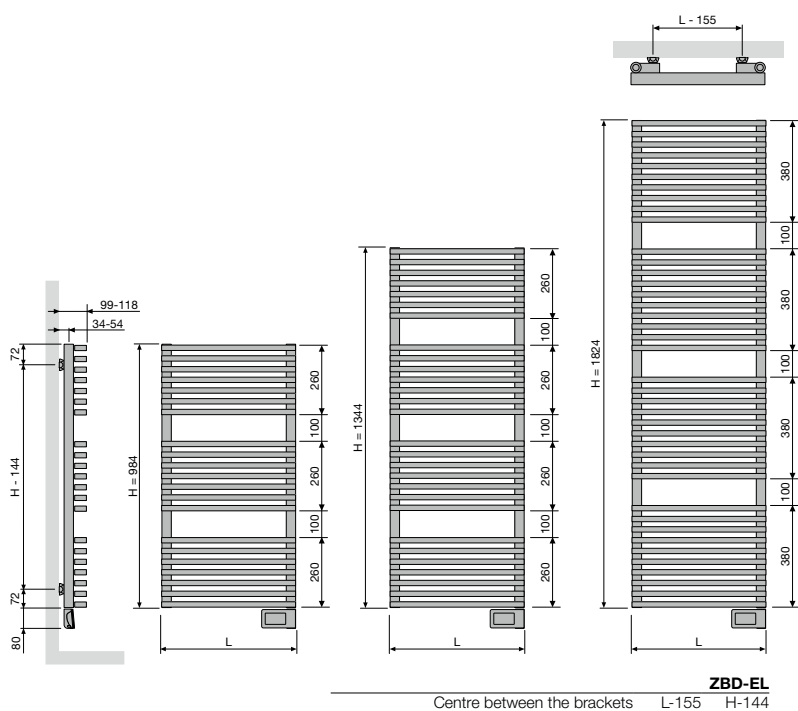

VASCO



NOT AVAILABLE
OUTSIDE THE
EU

PURE ELECTRICAL RADIATORS TECHNICAL DRAWINGS

E-BANO (BM-EL)

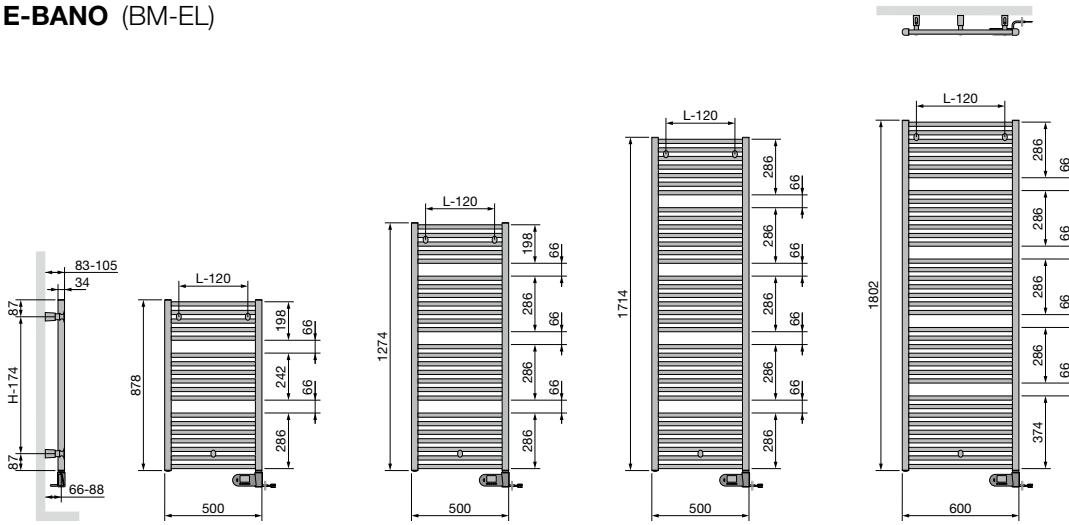

BM-EL

Centre between the brackets L-120 H-174

E-PANEL HORIZONTAL (EP-H-FL, EP-H-RIB)

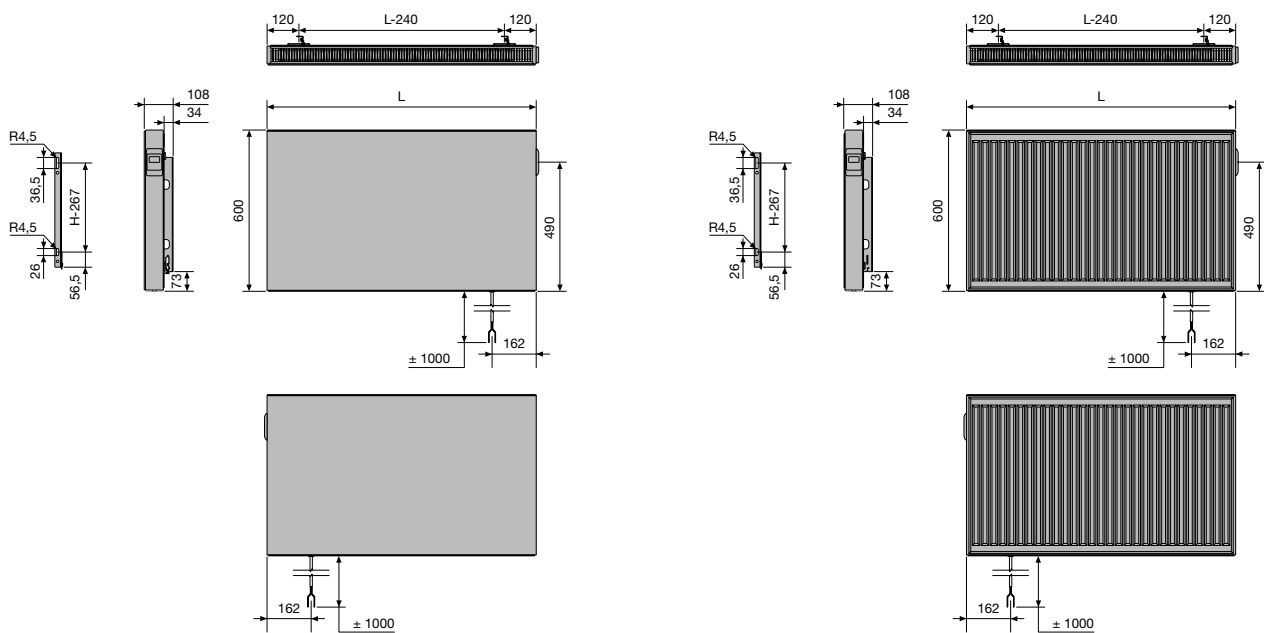

EP-H-FL / EP-H-RIB

Centre between the brackets L-240 H-460



NOT AVAILABLE
OUTSIDE THE
EU

E-PANEL VERTICAL (EP-V-FL)

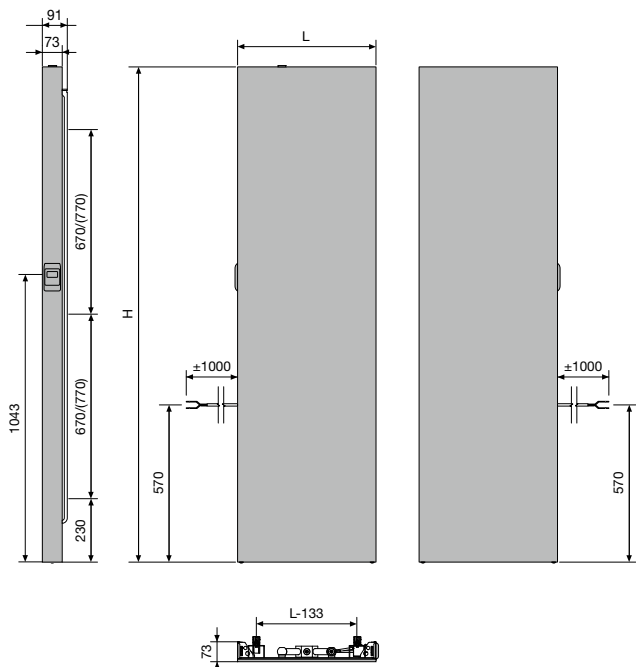

IRIS-A (HD-EL-BL-A) & BLOWER

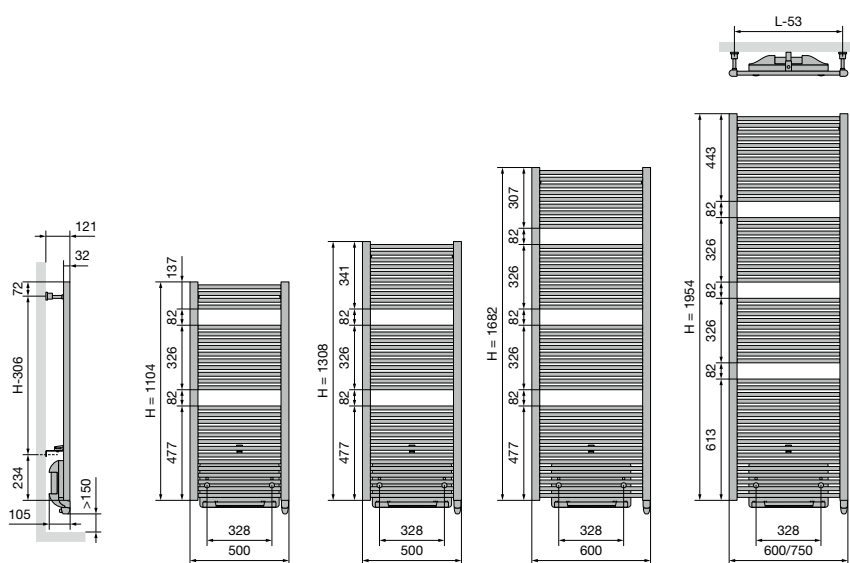

HD-EL-BL-A

Centre between the brackets L-53 H-306



NOT AVAILABLE
OUTSIDE THE
EU

PURE ELECTRICAL RADIATORS TECHNICAL DRAWINGS

AGAVE-A (HR-EL-BL-A) & BLOWER

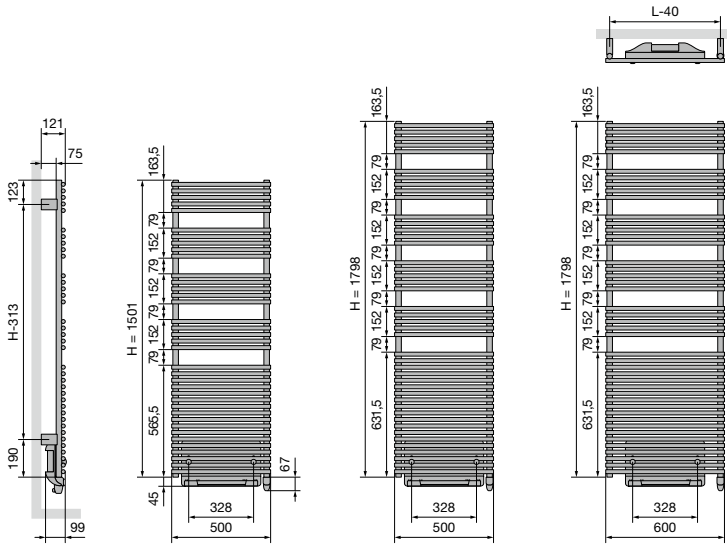

HR-EL-BL-A

Centre between the brackets L-40 H-313

ASTER-A (HF-EL-BL-A) & BLOWER

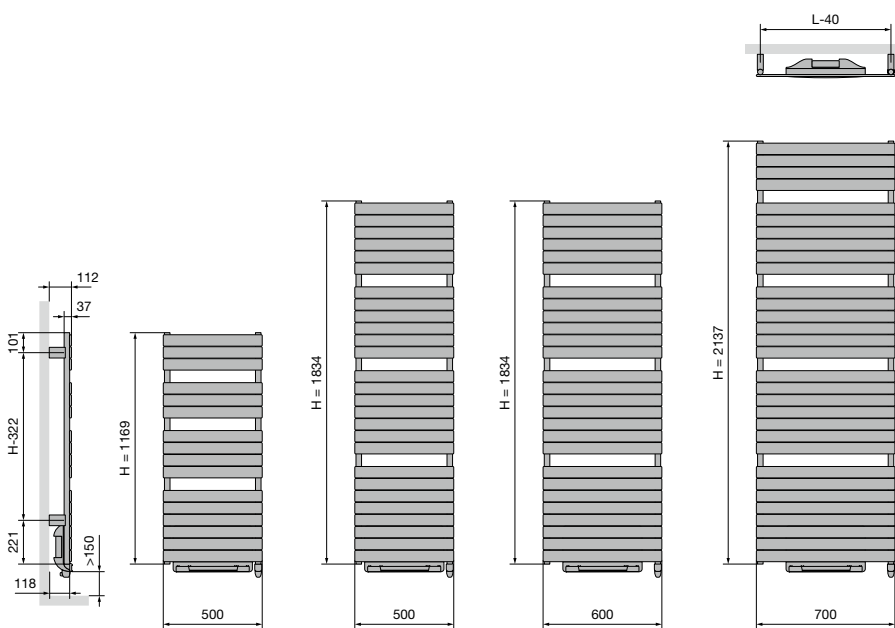

HF-EL-BL-A

Centre between the brackets L-40 H-322

VASCO



NOT AVAILABLE
OUTSIDE THE
EU

PURE ELECTRICAL RADIATORS TECHNICAL DRAWINGS

CARRÉ BATHROOM (CB-EL-BL) & BLOWER

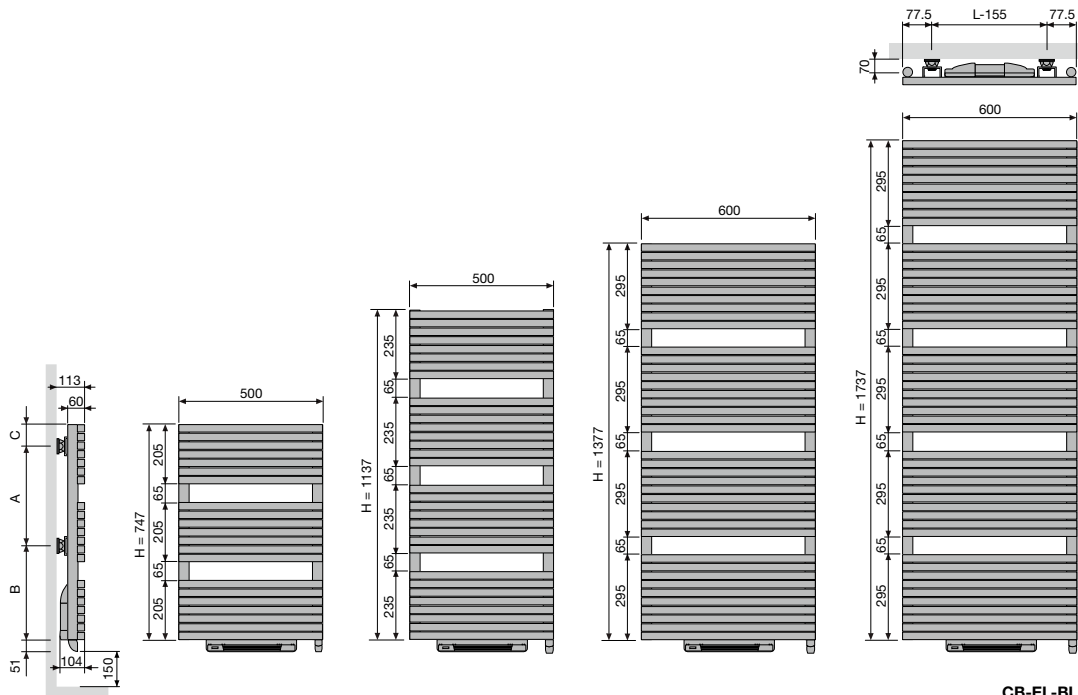

CB-EL-BL

Centre between the brackets	L-155			
height (H)	747	1137	1377	1737
A	360	720	1080	1440
B	338	364	246	248
C	49	53	51	49

VASCO

NIVA-A (NIVA-EL-BL-A) & BLOWER

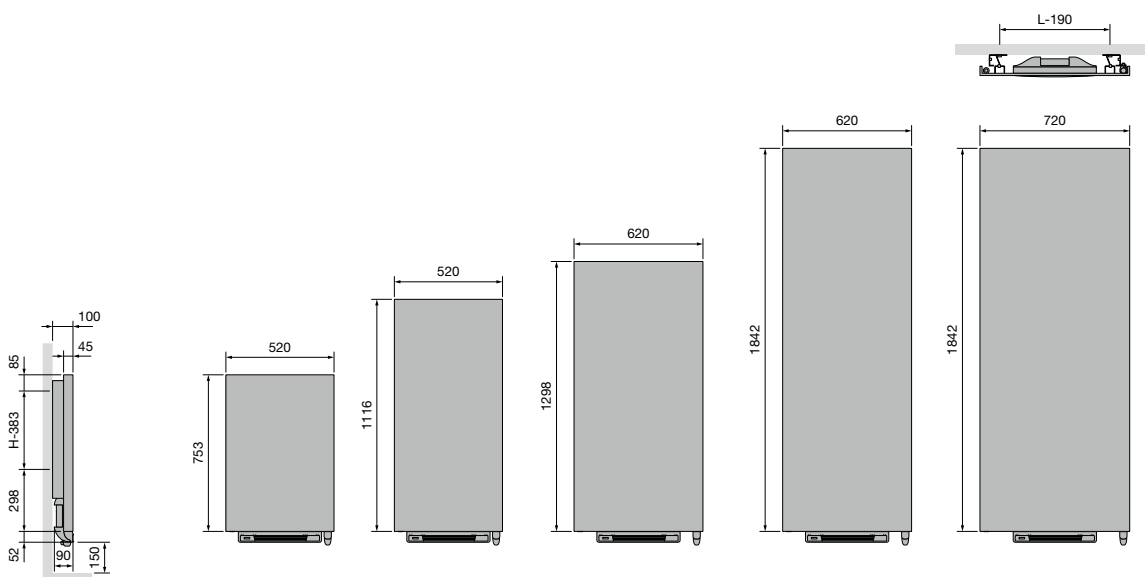

NIVA-EL-BL-A

Centre between the brackets	L-190	H-383
-----------------------------	-------	-------



NOT AVAILABLE
OUTSIDE THE
EU

MIXED RADIATORS TECHNICAL DRAWINGS

NIVA (N1L1-EL-MIX) MIXED

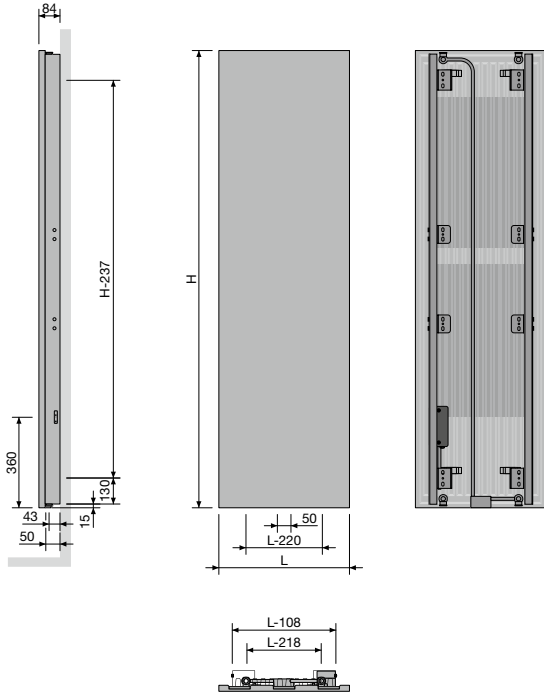

N1L1-EL-MIX

Centre between the brackets L-218 H-237

IRIS-A (HDM-BL-MIX-A) BLOWER MIXED

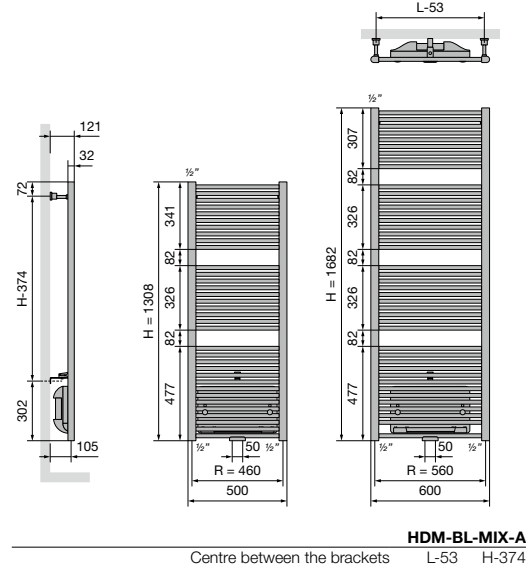

HDM-BL-MIX-A

Centre between the brackets L-53 H-374

ASTER-A (HF-BL-MIX-A) BLOWER MIXED

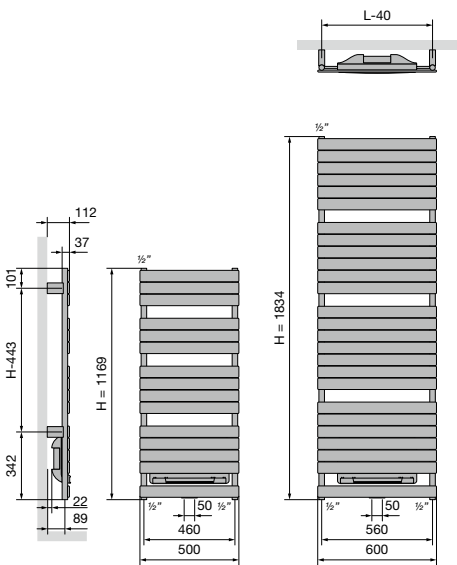

HF-BL-MIX-A

Centre between the brackets L-40 H-443



NOT AVAILABLE
OUTSIDE THE
EU

ELECTRIC RADIATORS **BRACKETS** IN OPTION

PRICE GROUP: VPG10 - ACC.

BRACKETS		COLOUR	REF. NR.	€
		CB-EL / CB-EL-BL / ZBD-EL		
WALL SETUP	4 brackets	RAL 7016	1187 007 0000 7016	41







EXPORT. Prices in Euro (excl. VAT)

ELECTRIC RADIATORS ACCESSORIES IN OPTION



NOT AVAILABLE
OUTSIDE THE
EU

PRICE GROUP: VPG10B - TOWEL RAILS

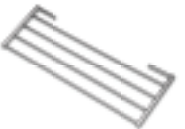
ACCESSORIES	WIDTH TOWEL RAIL	COLOUR	REF. NR.	€
O-NP-EL / NIVA-EL / NIVA-EL-BL-A / N1L1-EL-MIX				
TOWEL RAIL MULTI+ RIGHT 	600 mm	S600	1183 734 0000 0600	204
	600 mm	RAL 9005 ^S	1183 734 0000 9005	204
<ul style="list-style-type: none"> h = 70 mm; b = 600 mm (b tablet = 194 mm); e = 176 mm; c = 170 mm; Mounting on the wall, to the right of the radiator. 				
O-NP-EL / NIVA-EL / NIVA-EL-BL-A / N1L1-EL-MIX				
TOWEL RAIL MULTI+ LEFT 	600 mm	S600	1183 735 0000 0600	204
	600 mm	RAL 9005 ^S	1183 735 0000 9005	204
<ul style="list-style-type: none"> h = 70 mm; b = 600 mm (b tablet = 194 mm); e = 176 mm; c = 170 mm; Mounting on the wall, to the left of the radiator. 				
CB-EL / CB-EL-BL				
TOWEL RAIL 		CHROME	1183 207 0000 0099	187
<ul style="list-style-type: none"> h = 22 mm; b = 720 mm (easy adjustable); d = 75 mm; a = 56 mm 				
ZBD-EL				
TOWEL RAIL 		CHROME	1183 228 0000 0099	187
<ul style="list-style-type: none"> h = 22 mm; b = 720 mm (easy adjustable); d = 75 mm; a = 56 mm 				
EP-V-FL				
TOWEL RAIL 	400 mm	RAL 9016	1191 197 2040	94
	500 mm	RAL 9016	1191 197 2050	101
	600 mm	RAL 9016	1191 197 2060	108
<ul style="list-style-type: none"> b = 400, 500, 600 mm; d = 64 mm 				
BEAMS MONO-EL				
TOWEL RAIL 	240 mm	CHROME	1183 273 0000 0099	107
	240 mm	S600	1183 273 0000 0600	107
	240 mm	RAL 9005 ^M	1183 273 0000 9005	107
<ul style="list-style-type: none"> h = 55 mm; b = 240 mm; d = 67 mm; a = 61 mm; 				
O-P-EL / O-NP-EL				
TOWEL RAIL 	372 mm	CHROME	1183 274 0000 0099	160
	372 mm	S600	1183 274 0000 0600	160
	372 mm	RAL 9005 ^M	1183 274 0000 9005	160
<ul style="list-style-type: none"> h = 55 mm; b = 372 mm; d = 56 mm; a = 50 mm; 				
HD-EL-A / HDR-EL-A / HR-EL-A / HD-EL-BL-A / HF-EL-BL-A				
FOLDING DRYING AND STACKING RACK 		CHROME	1183 004 0000 0099	135
	HDM-BL-MIX-A			
		CHROME	1183 002 0000 0099	135
<ul style="list-style-type: none"> 380 x 158 mm 				

^S structure black
^M matt black

Mounting instructions accessories: see www.vasco.eu
EXPORT. Prices in Euro (excl. VAT)







e = distance front of the accessory up to the wall
d = distance front of the accessory up to front of the radiator
c = distance between wall to back towel bar
a = distance accessory up to the radiator
available from stock



NOT AVAILABLE
OUTSIDE THE
EU

ELECTRIC RADIATORS ACCESSORIES IN OPTION

PRICE GROUP: VPG10B - TOWEL RAILS

ACCESSORIES	WIDTH TOWEL RAIL	COLOUR	REF. NR.	€	
CB-EL / CB-EL-BL					
SQUARE HOOK 		CHROME	1183 500 0000 0099	68	
• h = 24 mm; b = 24 mm; d = 65 mm					
ZBD-EL					
HOOK 		CHROME	1183 410 0000 0099	87	
• h = 70 mm; b = 70 mm; d = 59 mm; a = 51 mm;					
BEAMS MONO-EL					
SHORT TOWEL RAIL 	240 mm	S600	1183 700 0000 0600	135	
	240 mm	RAL 9005 ^S	1183 700 0000 9005	135	
• d = 49,35 mm; a = 39,35 mm					
BEAMS MONO-EL					
RECTANGULAR TOWEL RAIL 	286 x 110 mm	S600	1183 702 0000 0600	164	
	286 x 110 mm	RAL 9005 ^S	1183 702 0000 9005	164	
• d = 49,35 mm; a = 39,35 mm					
NIVA-EL / NIVA-EL-BL-A / N1L1-EL-MIX					
SHORT TOWEL RAIL* 	240 mm	S600	1183 710 0000 0600	135	
	240 mm	RAL 9005 ^S	1183 710 0000 9005	135	
• d = 66,5 mm; a = 56,5 mm					
NIVA-EL / NIVA-EL-BL-A / N1L1-EL-MIX					
LONG TOWEL RAIL* 	440 mm	S600	1183 711 0000 0600	135	
	440 mm	RAL 9005 ^S	1183 711 0000 9005	135	
• d = 66,5 mm; a = 56,5 mm					
NIVA-EL / NIVA-EL-BL-A / N1L1-EL-MIX					
TOWEL RAIL* 	372 mm	ALUMINIUM	1183 239 0000 0000	187	
	372 mm	CHROME	1183 239 0000 0099	187	
	372 mm	S600	1183 239 0000 0600	187	
	372 mm	RAL 9005 ^M	1183 239 0000 9005	187	
	526 mm	CHROME	1183 271 0000 0099	187	
	526 mm	S600	1183 271 0000 0600	187	
	526 mm	RAL 9005 ^M	1183 271 0000 9005	187	
	• Towel rail in aluminium				
	• h = 55 mm; b = 372, 526 mm; d = 56 mm; a = 50 mm;				

^M matt black
^S structure black

* Attention: towel rail only possible for NIVA-EL(-BL)(-MIX) from version 2021!

Mounting instructions accessories: see www.vasco.eu
EXPORT. Prices in Euro (excl. VAT)

d = distance front of the accessory up to front of the radiator
a = distance accessory up to the radiator
available from stock

VASCO

Toilet radiators



Viola-A Horizontal, Gold

REFERENCE CODE CUSTOM MADE	TECHNICAL DATA										STANDARD COLOUR		OTHER COLOURS
	tubes	width (L mm)	height (H mm)	75/65/20 (Watt) (φ50K)	55/45/20 (Watt) (φ30K)	n-exp.	weight (kg)	water content (l)	electr. resistance (Watt)	price RAL 9016 (€)	short ref. nr. RAL 9016 stock	price colour (€)	

REF. NR. NIVA HORIZONTAL LACQUERED NH1L1 : 11193

PRICE GROUP: VPG2 - STEEL DESIGN RADIATORS



11193	0520	0450	0098	YYYY	-0000	-	520	450	301	158	1,26	7,50	1,19	-	469*	11193-01	539
--------------	------	-------------	------	------	-------	---	-----	-----	-----	-----	------	------	------	---	-------------	-----------------	------------

REF. NR. CARRÉ HORIZONTAL CPHN1-R0 : 11133

PRICE GROUP: VPG2 - STEEL DESIGN RADIATORS



11133	0600	0415	XXXX	YYYY	-0000	14	600	415	296	156	1,25	8,63	4,35	-	324	-	373
--------------	------	-------------	------	------	-------	----	-----	-----	-----	-----	------	------	------	---	------------	---	------------

REF. NR. ZANA HORIZONTAL ZH-1 : 11252

PRICE GROUP: VPG2 - STEEL DESIGN RADIATORS



11252	0384	0500	XXXX	YYYY	-0000	10	384	500	347	183	1,25	9,00	4,10	-	322	-	370
--------------	------	-------------	------	------	-------	----	-----	-----	-----	-----	------	------	------	---	------------	---	------------

REF. NR. VIOLA-A HORIZONTAL H1L1-R0-A** : 11380

PRICE GROUP: VPG2 - STEEL DESIGN RADIATORS



11380	0500	0400	XXXX	YYYY	-0000	5	500	400	399	204	1,27	9,10	1,70	-	367	-	422
--------------	------	-------------	------	------	-------	---	-----	-----	-----	-----	------	------	------	---	------------	---	------------

REF. NR. TULIPA-A HORIZONTAL TH1-A : 11376

PRICE GROUP: VPG2 - STEEL DESIGN RADIATORS



11376	0540	0500	XXXX	YYYY	-0000	12	540	500	420	216	1,23	10,80	3,00	-	322	-	370
--------------	------	-------------	------	------	-------	----	-----	-----	-----	-----	------	-------	------	---	------------	---	------------

In conformity with EN442-1: 2014: radiators and convectors

* Standard colour S600 (fine texture white).

** Integrated valve in option. Price supplement see p. 313.

For heat outputs in other regimes, see p. 320 (correction factors)
For more information see extended separate chapters of these collections.

EXPORT. Prices in Euro (excl. VAT)

Aluminium radiators



An aluminium radiator conserves a lot of energy. It conducts heat up to four times more efficiently than other radiators. It brings a room to temperature with up to five times less water than other radiators. It works excellently in **low temperature systems** such as solar water heaters and condensation boilers.

It also scores well in terms of its sustainability because aluminium is **100% recyclable** and can be endlessly reused, while preserving its specific properties.

Aluminium is particularly practical. It is **three times lighter than steel**.

VASCO aluminium radiators can therefore be easily fixed to any wall, require little space and are easy to install. Furthermore aluminium is rust free. Ideal for a humid environment such as the bathroom and is easy to maintain.

Aluminium radiators

Beams	110
Bryce	115
Alu-Zen	120
Zaros	123



VASCO

COLOURS

- Standard colour S600 (fine texture white) (RAL 9016: no extra charge 15%)
- Not available in collection Pure Grey
- Extensive colour chart see p. 10

SPECIAL

- Composed out of 1 vertical aluminium profile (width 150 mm)
- Protection against internal corrosion: protecting product Protect X100

BRACKETS

- Wall brackets standard (discretely eliminated)

TECHNICAL

- Aluminium radiators are manufactured by way of a patented press process that goes into making a world class radiator.
- KTL priming coat, powder coating
- Standard operating pressure: 10 bar
- Maximum operating temperature: 110°C
- **Integrated connection (valve set) (lockable) (the central heating pipes should be connected directly to this)**

ELECTRICAL (available versions: see chapter electrical radiators)

- ✓ Pure electrical radiator prefilled (see p. 54)
- ✗ Mixed radiator

TECHNICAL DRAWINGS

- See p. 126

CONNECTION

- ✗ One-point connection for one-pipe system
- ✗ One-point connection for two-pipe system
- ✗ Two-point connection for one-pipe system
- ✓ Two-point connection for two-pipe system (standard) (built-in thermostat box, see p. 329)
- ✗ Integrated valve

- Connections: 3/4" Euro cones
- A standard automatic air vent is fitted on the top left hand side of the radiator
- **Attention: The water should be PH neutral. Protect X100 or a similar product should be added to the circuit.**
- **Attention: must be used in combination with the built-in thermostat box.**

PROTECT X100*

Ref. nr. 11FH55064

price € 89

* 1 bottle (1 litre) per 100 litres installation water

BEAMS MONO

Architectural freedom with aluminium

VASCO have a tradition for technical excellence, enabling them to continually develop new and exciting products. These designer radiators are characterised by their vertical aluminium sections (150 mm wide), and are the most minimalistic design ever developed by VASCO. The design completely conceals the collector, making the valve set invisible and also integrates the suspensions.

RECOMMENDED CONNECTION (0066)



Other connection methods, see p. 114

RECOMMENDED FOR BATHROOM AND KITCHEN IN OPTION



short towel rail (S600)
ref. nr. see p. 114
price €135

Other accessories, see p. 114

BUILT-IN THERMOSTAT BOX



ref. nr. 11823060000099
price € 409
Fittings, see p. 329

INTEGRATED CONNECTION (VALVE SET) (SQUARE)



Fittings, see p. 329



HOW TO ORDER BEAMS MONO

Delivery time 15 - 30 working days
(transport duration not included)

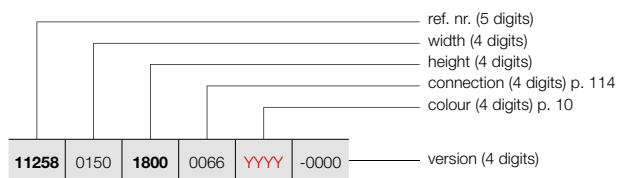

BEAMS (BEAMS MONO)



BEAMS MONO

HOW TO ORDER STOCK RADIATOR BEAMS MONO

Delivery time 5 working days
(transport duration not included)

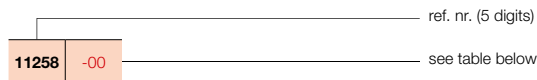

PRICE GROUP: VPG6 - ALUMINIUM DESIGN RADIATORS

REFERENCE CODE CUSTOM MADE BEAMS MONO	TECHNICAL DATA							STANDARD COLOUR		OTHER COLOURS		
	tubes	width (L mm)	height (H mm)	75/65/20 (Watt (Φ50K))	55/45/20 (Watt (Φ30K))	n-exp.	weight (kg)	water content (l)	electr. resistance (Watt)	price S600* (€)	short ref. nr. S600 stock	price colour (€)
REF. NR. BEAMS MONO : 11258												
11258 0150 1800 0066 YYY -0000	-	150	1800	671	351	1,27	8,60	0,47	-	843	11258-09	969
	-	150	2000	734	384	1,27	9,55	0,52	-	888	11258-10	1021
	-	150	2200	795	413	1,28	10,50	0,57	-	951	-	1094

In conformity with EN442-1: 2014: radiators and convectors

* RAL 9016: no extra charge 15%

For heat outputs in other regimes, see p. 320 (correction factors)

EXPORT. Prices in Euro (excl. VAT)

BEAMS (BEAMS)



COLOURS

- Standard colour S600 (fine texture white) (RAL 9016: no extra charge 15%)
- Not available in collection Pure Grey
- Extensive colour chart see p. 10

SPECIAL

- Composed out of vertical aluminium profiles
- Protection against internal corrosion: protecting product Protect X100

BRACKETS

- Wall brackets standard

TECHNICAL

- Aluminium radiators are manufactured by way of a patented press process that goes into making a world class radiator.
- KTL priming coat, powder coating
- Standard operating pressure: 10 bar
- Maximum operating temperature: 110°C

ELECTRICAL

- ✗ Pure electrical radiator prefilled
- ✗ Mixed radiator

TECHNICAL DRAWINGS

- See p. 126

CONNECTION

- ✗ One-point connection for one-pipe system
- ✗ One-point connection for two-pipe system
- ✓ Two-point connection for one-pipe system (connection by way of the central connection) (see p. 312)
- ✓ Two-point connection for two-pipe system (standard) (see p. 312)
- ✗ Integrated valve
- Connections: ½" (inner thread)
- A standard automatic air vent is fitted on the top left hand side of the radiator
- **Attention: The water should be PH neutral. Protect X100 or a similar product should be added to the circuit.**

PROTECT X100*

Ref. nr. 11FH55064

price € 89

* 1 bottle (1 litre) per 100 litres installation water

BEAMS

Functionality at its best

Architectural space was the inspiration for this innovative, multiple design awards acclaimed radiator concept. Three beam-shaped volumes form a robust whole, nicely balanced with the geometric architecture in the living space. The geometric accessories provide you the option of making the desired accents yourself. Two water channels per element guarantee excellent efficiency, with optimal energy savings as a bonus.

RECOMMENDED CONNECTION (0066)



Other connection methods, see p. 114

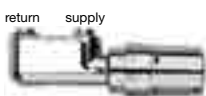

ref. nr. 1182 103 0000 0099

price € 218

Fittings, see p. 327

RECOMMENDED FOR BATHROOM AND KITCHEN IN OPTION



DISCONTINUED ITEM

towel rail (aluminium)
ref. nr. see p. 114

price €164



rectangular towel rail (S600)

ref. nr. see p. 114

price €164

Other accessories, see p. 114



HOW TO ORDER BEAMS

Delivery time 15 - 30 working days
(transport duration not included)

11258	0320	1600	0066	YYYY	-0000
-------	------	------	------	------	-------

ref. nr. (5 digits)
width (4 digits)
height (4 digits)
connection (4 digits) p. 114
colour (4 digits) p. 10
version (4 digits)

BEAMS (BEAMS)



BEAMS

HOW TO ORDER STOCK RADIATOR BEAMS

Delivery time 5 working days
(transport duration not included)

11258	-00
-------	-----

ref. nr. (5 digits)
see table below

PRICE GROUP: VPG6 - ALUMINIUM DESIGN RADIATORS

REFERENCE CODE CUSTOM MADE BEAMS	TECHNICAL DATA									STANDARD COLOUR		OTHER COLOURS					
	tubes	width (L mm)	height (H mm)	75/65/20 (Watt) (φ50K)	55/45/20 (Watt) (φ30K)	n-exp.	weight (kg)	water content (l)	electr. resistance (Watt)	price S600* (€)	short ref. nr. S600 stock	price colour (€)					
REF. NR. BEAMS : 11258																	
11258	0320	1600	0066	YYYY	-0000	2	320	1600	1127	583	1,29	15,50	1,00	-	881	11258-04	1013
		1800				2	320	1800	1237	643	1,28	17,28	1,08	-	934	11258-01	1074
		2000				2	320	2000	1348	701	1,28	19,05	1,15	-	959	11258-05	1103
		2200				2	320	2200	1459	755	1,29	20,90	1,30	-	1018	-	1171
11258	0490	1600	0066	YYYY	-0000	3	490	1600	1658	867	1,27	23,20	1,53	-	1284	11258-06	1477
		1800				3	490	1800	1821	947	1,28	25,88	1,64	-	1361	11258-02	1565
		2000				3	490	2000	1983	1026	1,29	28,55	1,75	-	1400	11258-03	1610
		2200				3	490	2200	2147	1111	1,29	31,25	2,00	-	1496	-	1720
11258	0660	1600	0066	YYYY	-0000	4	660	1600	2172	1147	1,25	30,90	2,05	-	1645	-	1892
		1800				4	660	1800	2385	1247	1,27	34,48	2,20	-	1752	11258-07	2015
		2000				4	660	2000	2598	1337	1,30	38,05	2,35	-	1805	11258-08	2076
		2200				4	660	2200	2812	1455	1,29	41,60	2,70	-	1933	-	2223

In conformity with EN442-1: 2014: radiators and convectors

* RAL 9016: no extra charge 15%

For heat outputs in other regimes, see p. 320 (correction factors)
EXPORT. Prices in Euro (excl. VAT)

BEAMS ACCESSORIES

IN OPTION

PRICE GROUP: VPG10B - TOWEL RAILS

ACCESSORIES		WIDTH RADIATOR	COLOUR	REF. NR.	€
TOWEL RAIL  <p>DISCONTINUED ITEM</p> <ul style="list-style-type: none"> Towel rail in aluminium h = 50 mm; b = 380, 550, 720 mm; d = 50 mm; a = 46 mm 	BEAMS				
	320 mm	ALUMINIUM	1183 262 0000 0000	164	
	490 mm	ALUMINIUM	1183 263 0000 0000	164	
	660 mm	ALUMINIUM	1183 264 0000 0000	164	
SHORT TOWEL RAIL  <ul style="list-style-type: none"> d = 49,35 mm; a = 39,35 mm 	BEAMS / BEAMS MONO				
	240 mm	S600	1183 700 0000 0600	135	
	240 mm	RAL 9005 ^S	1183 700 0000 9005	135	
LONG TOWEL RAIL  <ul style="list-style-type: none"> d = 49,35 mm; a = 39,35 mm 	BEAMS				
	440 mm	S600	1183 701 0000 0600	135	
	440 mm	RAL 9005 ^S	1183 701 0000 9005	135	
RECTANGULAR TOWEL RAIL  <ul style="list-style-type: none"> d = 49,35 mm; a = 39,35 mm 	BEAMS / BEAMS MONO				
	286 x 110 mm	S600	1183 702 0000 0600	164	
	286 x 110 mm	RAL 9005 ^S	1183 702 0000 9005	164	
TOWEL RAIL MULTI+ RIGHT  <ul style="list-style-type: none"> h = 70 mm; b = 600 mm (b tablet = 194 mm); e = 176 mm; c = 170 mm; Mounting on the wall, to the right of the radiator. 	BEAMS				
	600 mm	S600	1183 734 0000 0600	204	
	600 mm	RAL 9005 ^S	1183 734 0000 9005	204	
TOWEL RAIL MULTI+ LEFT  <ul style="list-style-type: none"> h = 70 mm; b = 600 mm (b tablet = 194 mm); e = 176 mm; c = 170 mm; Mounting on the wall, to the left of the radiator. 	BEAMS				
	600 mm	S600	1183 735 0000 0600	204	
	600 mm	RAL 9005 ^S	1183 735 0000 9005	204	
TOWEL RAIL  <ul style="list-style-type: none"> h = 55 mm; b = 240 mm; d = 67 mm; a = 61 mm; 	BEAMS / BEAMS MONO				
	240 mm	CHROME	1183 273 0000 0099	107	
	240 mm	S600	1183 273 0000 0600	107	
	240 mm	RAL 9005 ^M	1183 273 0000 9005	107	

- structure black
- ▣ matt black

Mounting instructions accessories: see www.vasco.eu
 EXPORT. Prices in Euro (excl. VAT)

e = distance front of the accessory up to the wall
 d = distance front of the accessory up to front of the radiator
 c = distance between wall to back towel bar
 a = distance accessory up to the radiator
available from stock

BEAMS CONNECTIONS

BEAMS: BEAMS / BEAMS MONO

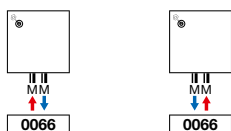

Attention: connecting the radiator can only be as shown by the connecting icons. For any other connection method, we take no responsibility.

COLOURS

- Standard colour S600 (fine texture white) (RAL 9016: no extra charge 15%)
- Not available in colour Jet Black
- Extensive colour chart see p. 10

SPECIAL

- Composed out of 1 vertical aluminium profile (width 150 mm)
- Protection against internal corrosion: protecting product Protect X100
- The Bryce is awarded with the Henry van de Velde label 2007, the Product Design Award Hannover 2008, Design Plus Award - Material Vision, Frankfurt 2007, the Red Dot Product Design Award 2008 and nominated for the Designpreis 2009 and the European Aluminium Award 2008.

BRACKETS

- Wall brackets standard

TECHNICAL

- Aluminium radiators are manufactured by way of a patented press process that goes into making a world class radiator.
- KTL priming coat, powder coating
- Standard operating pressure: 10 bar
- Maximum operating temperature: 110°C
- **Integrated connection (valve set) (lockable) (the central heating pipes should be connected directly to this)**

ELECTRICAL

- ✗ Pure electrical radiator prefilled
- ✗ Mixed radiator

TECHNICAL DRAWINGS

- See p. 126

CONNECTION

- ✗ One-point connection for one-pipe system
- ✗ One-point connection for two-pipe system
- ✗ Two-point connection for one-pipe system
- ✓ Two-point connection for two-pipe system (standard) (built-in thermostat box, see p. 329)
- ✗ Integrated valve
- Connections: 3/4" Euro cones
- A standard automatic air vent is fitted on the top left hand side of the radiator
- **Attention: The water should be PH neutral. Protect X100 or a similar product should be added to the circuit.**
- **Attention: must be used in combination with the built-in thermostat box.**

PROTECT X100*

Ref. nr. 11FH55064
price € 89

* 1 bottle (1 litre) per 100 litres installation water

RECOMMENDED CONNECTION (0066)

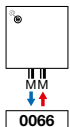

Other connection methods, see p. 119

RECOMMENDED FOR BATHROOM AND KITCHEN IN OPTION



short towel rail (S600)
 ref. nr. see p. 119
price €135

Other accessories, see p. 119

BUILT-IN THERMOSTAT BOX



ref. nr. 11823060000099
price € 409
 Fittings, see p. 329

INTEGRATED CONNECTION (VALVE SET) (SQUARE)



Fittings, see p. 329



BRYCE MONO

Minimalism in aluminium

The sections (150 mm) of the Bryce Mono can be mounted separately; you can have one, two, three or more sections in the same colour or in different shades. Bryce Mono allows for great flexibility and creativity when it comes to interior decor. The temperature is regulated via a single thermostat that can control the sections in series or separately.



BRYCE (BRYCE MONO)



BRYCE MONO

HOW TO ORDER BRYCE MONO

Delivery time 15 - 30 working days
(transport duration not included)

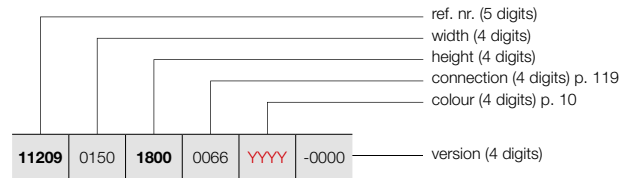

HOW TO ORDER STOCK RADIATOR BRYCE MONO

Delivery time 5 working days
(transport duration not included)

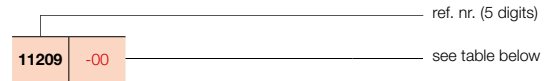

PRICE GROUP: VPG6 - ALUMINIUM DESIGN RADIATORS

REFERENCE CODE CUSTOM MADE BRYCE MONO	TECHNICAL DATA									STANDARD COLOUR		OTHER COLOURS					
	tubes	width (L mm)	height (H mm)	75/65/20 (Watt) (φ50K)	55/45/20 (Watt) (φ30K)	n-exp.	weight (kg)	water content (l)	electr. resistance (Watt)	price S600* (€)	short ref. nr. S600 stock	price colour (€)					
REF. NR. BRYCE MONO : 11209																	
11209	0150	1800	0066	YYY	-0000	-	150	1800	586	306	1,27	8,60	0,47	-	843	11209-10	969
		2000				-	150	2000	642	336	1,27	9,55	0,52	-	888	-	1021
		2200				-	150	2200	696	364	1,27	10,50	0,57	-	951	-	1094

In conformity with EN442-1: 2014: radiators and convectors

* RAL 9016: no extra charge 15%

For heat outputs in other regimes, see p. 320 (correction factors)
EXPORT. Prices in Euro (excl. VAT)

TYPES

- Vertical: Bryce V75 and Bryce V100 (depth)

COLOURS

- Standard colour S600 (fine texture white) (RAL 9016: no extra charge 15%)
- Not available in colour Jet Black
- Extensive colour chart see p. 10

SPECIAL

- Composed out of vertical aluminium profiles
- Protection against internal corrosion: protecting product Protect X100
- The Bryce is awarded with the Henry van de Velde label 2007, the Product Design Award Hannover 2008, Design Plus Award - Material Vision, Frankfurt 2007, the Red Dot Product Design Award 2008 and nominated for the Designpreis 2009 and the European Aluminium Award 2008.

BRACKETS

- Wall brackets standard

TECHNICAL

- Aluminium radiators are manufactured by way of a patented press process that goes into making a world class radiator.
- KTL priming coat, powder coating
- Standard operating pressure: 10 bar
- Maximum operating temperature: 110°C

ELECTRICAL

- ✗ Pure electrical radiator prefilled
- ✗ Mixed radiator

TECHNICAL DRAWINGS

- See p. 127

CONNECTION

- ✗ One-point connection for one-pipe system
- ✗ One-point connection for two-pipe system
- ✓ Two-point connection for one-pipe system (connection by way of the central connection) (see p. 312)
- ✓ Two-point connection for two-pipe system (standard) (see p. 312)
- ✗ Integrated valve
- Connections: ½" (inner thread)
- A standard automatic air vent is fitted on the top left hand side of the radiator
- **Attention: The water should be PH neutral. Protect X100 or a similar product should be added to the circuit.**

PROTECT X100*

Ref. nr. 11FH55064

price € 89

* 1 bottle (1 litre) per 100 litres installation water

RECOMMENDED CONNECTION (0066)

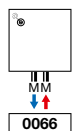

Other connection methods, see p. 119

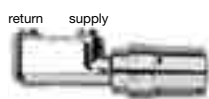

ref. nr. 1182 103 0000 0099

price € 218

Fittings, see p. 327

RECOMMENDED FOR BATHROOM AND KITCHEN IN OPTION



DISCONTINUED ITEM

towel rail (aluminium)

ref. nr. see p. 119

price €164



rectangular towel rail (S600)

ref. nr. see p. 114

price €164

Other accessories, see p. 114



VASCO

BRYCE VERTICAL

Heat in a new light

A designer radiator that constantly evokes new light shades and contrasts due to the fine, irregular structure of the front, and in this way contributes to a pleasant, natural ambience in the intimate space. A perfect example of applied design and a valuable asset in any contemporary interior.



BRYCE VERTICAL (BRYCE V75, BRYCE V100)

HOW TO ORDER BRYCE VERTICAL
 Delivery time 15 - 30 working days
 (transport duration not included)

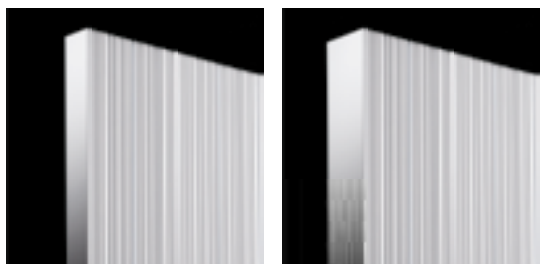

BRYCE V75

BRYCE V100

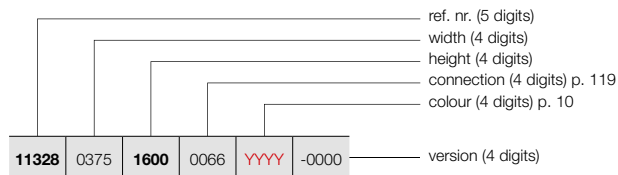

HOW TO ORDER STOCK RADIATOR BRYCE VERTICAL

Delivery time 5 working days
 (transport duration not included)

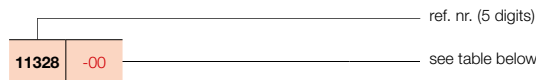

PRICE GROUP: VPG6 - ALUMINIUM DESIGN RADIATORS

REFERENCE CODE CUSTOM MADE BRYCE VERTICAL	TECHNICAL DATA									STANDARD COLOUR		OTHER COLOURS
	tubes	width (L mm)	height (H mm)	75/65/20 (Watt) (φ50K)	55/45/20 (Watt) (φ30K)	n-exp.	weight (kg)	water content (l)	electr. resistance (Watt)	price S600* (€)	short ref. nr. S600 stock	price colour (€)
REF. NR. BRYCE VERTICAL BRYCE V75 : 11328												
11328	0375	1600	1600	1189	609	1,31	19,75	1,35	-	913	-	1050
		1800								970	-	1116
		2000								993	-	1142
		2200								1064	-	1224
11328	0450	1600	1600	1408	710	1,34	23,72	1,57	-	1071	-	1232
		1800								1136	11328-01	1306
		2000								1174	-	1350
		2200								1260	-	1449
11328	0525	1600	1600	1623	802	1,38	27,68	1,78	-	1228	-	1412
		1800								1310	11328-02	1507
		2000								1348	-	1550
		2200								1452	-	1670
11328	0600	1600	1600	1836	893	1,41	31,65	2,00	-	1389	-	1597
		1800								1481	11328-03	1703
		2000								1530	11328-04	1760
		2200								1644	-	1891
REF. NR. BRYCE VERTICAL BRYCE V100 : 11209												
11209	0375	1600	1600	1238	624	1,34	19,65	1,35	-	1099	-	1264
		1800								1166	-	1341
		2000								1197	-	1377
		2200								1275	-	1466
11209	0450	1600	1600	1482	751	1,33	23,73	1,60	-	1284	-	1477
		1800								1361	11209-01	1565
		2000								1400	-	1610
		2200								1496	-	1720
11209	0525	1600	1600	1726	875	1,33	27,82	1,85	-	1464	-	1684
		1800								1556	11209-03	1789
		2000								1600	-	1840
		2200								1711	-	1968
11209	0600	1600	1600	1969	998	1,33	31,90	2,10	-	1645	-	1892
		1800								1752	11209-08	2015
		2000								1805	11209-05	2076
		2200								1933	-	2223

In conformity with EN442-1: 2014: radiators and convectors

* RAL 9016: no extra charge 15%

For heat outputs in other regimes, see p. 320 (correction factors)
 EXPORT. Prices in Euro (excl. VAT)

VASCO

PRICE GROUP: VPG10B - TOWEL RAILS

ACCESSORIES		WIDTH RADIATOR	COLOUR	REF. NR.	€
TOWEL RAIL  DISCONTINUED ITEM	BRYCE V75 / BRYCE V100				
	375 mm	ALUMINIUM	1183244 0000 0000	164	
	450 mm	ALUMINIUM	1183245 0000 0000	164	
	525 mm	ALUMINIUM	1183246 0000 0000	164	
	600 mm	ALUMINIUM	1183247 0000 0000	164	
<ul style="list-style-type: none"> Towel rail in aluminium h = 50 mm; b = 435, 510, 585, 660 mm; d = 47 mm; a = 43 mm 					
SHORT TOWEL RAIL 	BRYCE V75 / BRYCE V100 / BRYCE MONO				
	240 mm	S600	1183700 0000 0600	135	
	240 mm	RAL 9005 ^S	1183700 0000 9005	135	
<ul style="list-style-type: none"> d = 49,35 mm; a = 39,35 mm 					
LONG TOWEL RAIL 	BRYCE V75 / BRYCE V100				
	440 mm	S600	1183701 0000 0600	135	
	440 mm	RAL 9005 ^S	1183701 0000 9005	135	
<ul style="list-style-type: none"> d = 49,35 mm; a = 39,35 mm 					
RECTANGULAR TOWEL RAIL 	BRYCE V75 / BRYCE V100 / BRYCE MONO				
	286 x 110 mm	S600	1183702 0000 0600	164	
	286 x 110 mm	RAL 9005 ^S	1183702 0000 9005	164	
<ul style="list-style-type: none"> d = 49,35 mm; a = 39,35 mm 					
TOWEL RAIL MULTI+ RIGHT 	BRYCE V75 / BRYCE V100				
	600 mm	S600	1183734 0000 0600	204	
	600 mm	RAL 9005 ^S	1183734 0000 9005	204	
<ul style="list-style-type: none"> h = 70 mm; b = 600 mm (b tablet = 194 mm); e = 176 mm; c = 170 mm; Mounting on the wall, to the right of the radiator. 					
TOWEL RAIL MULTI+ LEFT 	BRYCE V75 / BRYCE V100				
	600 mm	S600	1183735 0000 0600	204	
	600 mm	RAL 9005 ^S	1183735 0000 9005	204	
<ul style="list-style-type: none"> h = 70 mm; b = 600 mm (b tablet = 194 mm); e = 176 mm; c = 170 mm; Mounting on the wall, to the left of the radiator. 					
TOWEL RAIL 	BRYCE V75 / BRYCE V100 / BRYCE MONO				
	240 mm	CHROME	1183273 0000 0099	107	
	240 mm	S600	1183273 0000 0600	107	
	240 mm	RAL 9005 ^M	1183273 0000 9005	107	
<ul style="list-style-type: none"> h = 55 mm; b = 240 mm; d = 67 mm; a = 61 mm; 					

^S structure black
^M matt black

Mounting instructions accessories: see www.vasco.eu
EXPORT. Prices in Euro (excl. VAT)

e = distance front of the accessory up to the wall
d = distance front of the accessory up to front of the radiator
c = distance between wall to back towel bar
a = distance accessory up to the radiator
available from stock

BRYCE CONNECTIONS

BRYCE VERTICAL: BRYCE V75 / BRYCE V100 / BRYCE MONO

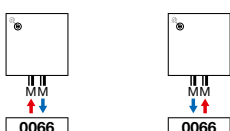

Attention: connecting the radiator can only be as shown by the connecting icons. For any other connection method, we take no responsibility.

ALU-ZEN VERTICAL (ALU-ZEN)



VASCO

COLOURS

- Standard colour S600 (fine texture white) (RAL 9016: no extra charge 15%)
- Not available in colour Jet Black
- Extensive colour chart see p. 10

SPECIAL

- Composed out of vertical aluminium profiles
- Protection against internal corrosion: protecting product Protect X100

BRACKETS

- Wall brackets standard

TECHNICAL

- Aluminium radiators are manufactured by way of a patented press process that goes into making a world class radiator.
- KTL priming coat, powder coating
- Standard operating pressure: 10 bar
- Maximum operating temperature: 110°C

ELECTRICAL

- ✗ Pure electrical radiator prefilled
- ✗ Mixed radiator

TECHNICAL DRAWINGS

- See p. 128

CONNECTION

- ✗ One-point connection for one-pipe system
- ✗ One-point connection for two-pipe system
- ✓ Two-point connection for one-pipe system (connection by way of the central connection) (see p. 312)
- ✓ Two-point connection for two-pipe system (standard) (see p. 312)
- ✗ Integrated valve
- Connections: ½" (inner thread)
- A standard automatic air vent is fitted on the top left hand side of the radiator
- **Attention: The water should be PH neutral. Protect X100 or a similar product should be added to the circuit.**

ALU-ZEN VERTICAL

When heating is visible

A designer radiator, inspired by the elegance and tranquillity of natural curves. A design which is enhanced by the floating towel rails. All this combined with a fast, convenient installation due to the handy centre connection and optimum heat output. A radiator that guarantees a real wellness atmosphere.

PROTECT X100*

Ref. nr. 11FH55064

price € 89

* 1 bottle (1 litre) per 100 litres installation water

RECOMMENDED CONNECTION (0066)



Other connection methods, see p. 122

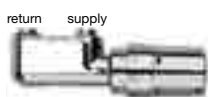

ref. nr. 1182 103 0000 0099

price € 218

Fittings, see p. 327

RECOMMENDED FOR BATHROOM AND KITCHEN IN OPTION



towel rail (aluminium)

ref. nr. see p. 122

price € 164

Other accessories, see p. 122



HOW TO ORDER ALU-ZEN VERTICAL

Delivery time 15 - 30 working days
(transport duration not included)

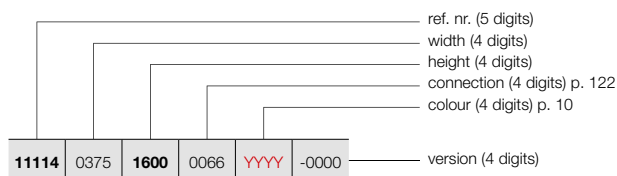

ALU-ZEN VERTICAL (ALU-ZEN)



ALU-ZEN

HOW TO ORDER STOCK RADIATOR ALU-ZEN VERTICAL

Delivery time 5 working days
(transport duration not included)

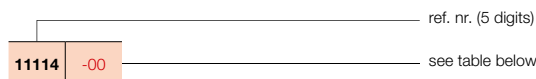

PRICE GROUP: VPG6 - ALUMINIUM DESIGN RADIATORS

REFERENCE CODE CUSTOM MADE ALU-ZEN VERTICAL	TECHNICAL DATA									STANDARD COLOUR		OTHER COLOURS					
	tubes	width (L mm)	height (H mm)	75/65/20 (Watt) (φ50K)	55/45/20 (Watt) (φ30K)	n-exp.	weight (kg)	water content (l)	electr. resistance (Watt)	price S600* (€)	short ref. nr. S600 stock	price colour (€)					
REF. NR. ALU-ZEN VERTICAL : 11114																	
11114	0375	1600	0066	YYY	-0000	-	375	1600	1196	616	1,30	17,40	1,30	-	1101	-	1266
		1800				-	375	1800	1319	675	1,31	19,40	1,40	-	1167	-	1342
		2000				-	375	2000	1440	737	1,31	21,40	1,50	-	1197	-	1377
		2200				-	375	2200	1557	797	1,31	23,25	1,75	-	1275	-	1466
11114	0450	1600	0066	YYY	-0000	-	450	1600	1446	741	1,31	21,07	1,53	-	1284	-	1477
		1800				-	450	1800	1596	817	1,31	23,49	1,68	-	1361	11114-06	1565
		2000				-	450	2000	1742	892	1,31	25,92	1,83	-	1400	-	1610
		2200				-	450	2200	1884	965	1,31	28,20	2,07	-	1496	-	1720
11114	0525	1600	0066	YYY	-0000	-	525	1600	1699	870	1,31	24,73	1,77	-	1464	-	1684
		1800				-	525	1800	1874	960	1,31	27,58	1,97	-	1553	11114-01	1786
		2000				-	525	2000	2046	1048	1,31	30,43	2,17	-	1600	-	1840
		2200				-	525	2200	2212	1133	1,31	33,15	2,38	-	1711	-	1968
11114	0600	1600	0066	YYY	-0000	-	600	1600	1953	1000	1,31	28,40	2,00	-	1645	-	1892
		1800				-	600	1800	2155	1104	1,31	31,68	2,25	-	1752	11114-03	2015
		2000				-	600	2000	2351	1204	1,31	34,95	2,50	-	1805	11114-02	2076
		2200				-	600	2200	2543	1302	1,31	38,10	2,70	-	1933	-	2223

In conformity with EN442-1: 2014: radiators and convectors

* RAL 9016: no extra charge 15%

For heat outputs in other regimes, see p. 320 (correction factors)
EXPORT. Prices in Euro (excl. VAT)

ACCESSORIES		WIDTH RADIATOR	COLOUR	REF. NR.	€
TOWEL RAIL  <ul style="list-style-type: none"> Towel rail in aluminium h = 50 mm; b = 435, 510, 585, 660 mm; d = 46 mm; a = 42 mm 	ALU-ZEN				
	375 mm	ALUMINIUM	1183 234 0000 0000	164	
	450 mm	ALUMINIUM	1183 235 0000 0000	164	
	525 mm	ALUMINIUM	1183 236 0000 0000	164	
	600 mm	ALUMINIUM	1183 237 0000 0000	164	
SHORT TOWEL RAIL  <ul style="list-style-type: none"> d = 67 mm; a = 57 mm 	ALU-ZEN				
	240 mm	S600	1183 700 0000 0600	135	
	240 mm	RAL 9005 ^S	1183 700 0000 9005	135	
LONG TOWEL RAIL  <ul style="list-style-type: none"> d = 67 mm; a = 57 mm 	ALU-ZEN				
	440 mm	S600	1183 701 0000 0600	135	
	440 mm	RAL 9005 ^S	1183 701 0000 9005	135	
RECTANGULAR TOWEL RAIL  <ul style="list-style-type: none"> d = 67 mm; a = 57 mm 	ALU-ZEN				
	286 x 110 mm	S600	1183 702 0000 0600	164	
	286 x 110 mm	RAL 9005 ^S	1183 702 0000 9005	164	
TOWEL RAIL MULTI+ RIGHT  <ul style="list-style-type: none"> h = 70 mm; b = 600 mm (b tablet = 194 mm); e = 176 mm; c = 170 mm; Mounting on the wall, to the right of the radiator. 	ALU-ZEN				
	600 mm	S600	1183 734 0000 0600	204	
	600 mm	RAL 9005 ^S	1183 734 0000 9005	204	
TOWEL RAIL MULTI+ LEFT  <ul style="list-style-type: none"> h = 70 mm; b = 600 mm (b tablet = 194 mm); e = 176 mm; c = 170 mm; Mounting on the wall, to the left of the radiator. 	ALU-ZEN				
	600 mm	S600	1183 735 0000 0600	204	
	600 mm	RAL 9005 ^S	1183 735 0000 9005	204	

^S structure black

Mounting instructions accessories: see www.vasco.eu
EXPORT. Prices in Euro (excl. VAT)

e = distance front of the accessory up to the wall
d = distance front of the accessory up to front of the radiator
c = distance between wall to back towel bar
a = distance accessory up to the radiator
available from stock

ALU-ZEN CONNECTIONS

ALU-ZEN VERTICAL: ALU-ZEN

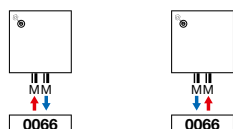

Attention: connecting the radiator can only be as shown by the connecting icons. For any other connection method, we take no responsibility.

TYPES

- Vertical: Zaros V75 and Zaros V100 (depth)

COLOURS

- Standard colour S600 (fine texture white) (RAL 9016: no extra charge 15%)
- Extensive colour chart see p. 10

SPECIAL

- Composed out of vertical aluminium profiles
- Protection against internal corrosion: protecting product Protect X100

BRACKETS

- Wall brackets standard

TECHNICAL

- Aluminium radiators are manufactured by way of a patented press process that goes into making a world class radiator.
- KTL priming coat, powder coating
- Standard operating pressure: 10 bar
- Maximum operating temperature: 110°C

ELECTRICAL

- ✗ Pure electrical radiator prefilled
- ✗ Mixed radiator

TECHNICAL DRAWINGS

- See p. 128

CONNECTION

- ✗ One-point connection for one-pipe system
- ✗ One-point connection for two-pipe system
- ✓ Two-point connection for one-pipe system (connection by way of the central connection) (see p. 312)
- ✓ Two-point connection for two-pipe system (standard) (see p. 312)
- ✗ Integrated valve
- Connections: 1/2" (inner thread)
- A standard automatic air vent is fitted on the top left hand side of the radiator
- **Attention: The water should be PH neutral. Protect X100 or a similar product should be added to the circuit.**

PROTECT X100*

Ref. nr. 11FH55064

price € 89

* 1 bottle (1 litre) per 100 litres installation water

RECOMMENDED CONNECTION (0066)

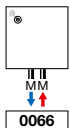

Other connection methods, see p. 125

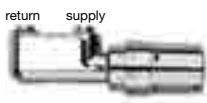

ref. nr. 1182 103 0000 0099

price € 218

Fittings, see p. 327

RECOMMENDED FOR BATHROOM AND KITCHEN IN OPTION



towel rail (chrome)

ref. nr. see p. 125

price € 164

Other accessories, see p. 125



VASCO

ZAROS VERTICAL

Elementary, in its element everywhere

Simplicity is the driving force of this uncomplicated designer radiator. A design that excellently comes into its own in any room, any environment, any interior. Not hindered by unnecessary elements. With a simple line, but generous with heat.



ZAROS VERTICAL (ZAROS V75, ZAROS V100)

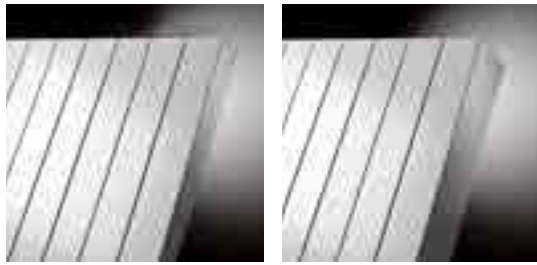

ZAROS V75

ZAROS V100

HOW TO ORDER ZAROS VERTICAL
Delivery time 15 - 30 working days
(transport duration not included)

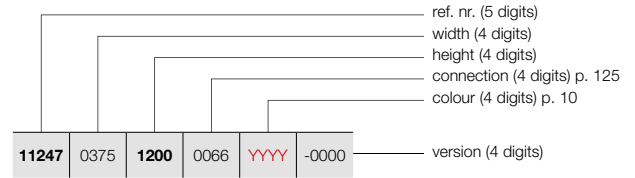

HOW TO ORDER STOCK RADIATOR ZAROS VERTICAL

Delivery time 5 working days
(transport duration not included)

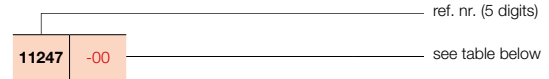

PRICE GROUP: VPG6 - ALUMINIUM DESIGN RADIATORS

REFERENCE CODE CUSTOM MADE ZAROS VERTICAL	TECHNICAL DATA									STANDARD COLOUR		OTHER COLOURS					
	tubes	width (L mm)	height (H mm)	75/65/20 (Watt) (φ50K)	55/45/20 (Watt) (φ30K)	n-exp.	weight (kg)	water content (l)	electr. resistance (Watt)	price S600* (€)	short ref. nr. S600 stock	price colour (€)					
REF. NR. ZAROS VERTICAL ZAROS V75 : 11247																	
11247	0375	1200	0066	YYYY	-0000	5	375	1200	885	453	1,31	13,20	1,00	-	803	-	923
		1600				5	375	1600	1159	594	1,31	16,50	1,38	-	866	11247-05	996
		1800				5	375	1800	1281	656	1,31	18,48	1,44	-	922	11247-06	1060
		2000				5	375	2000	1403	719	1,31	20,45	1,50	-	942	-	1083
		2200				5	375	2200	1502	773	1,30	22,40	1,65	-	1004	-	1155
11247	0450	1200	0066	YYYY	-0000	6	450	1200	1078	552	1,31	15,72	1,20	-	943	-	1084
		1600				6	450	1600	1377	687	1,36	19,57	1,57	-	1011	-	1163
		1800				6	450	1800	1518	770	1,33	21,84	1,69	-	1072	11247-07	1233
		2000				6	450	2000	1659	850	1,31	24,12	1,82	-	1103	-	1268
		2200				6	450	2200	1765	909	1,30	26,55	2,00	-	1179	-	1356
11247	0525	1200	0066	YYYY	-0000	7	525	1200	1272	648	1,32	18,23	1,40	-	1061	-	1220
		1600				7	525	1600	1594	780	1,40	22,63	1,76	-	1154	-	1327
		1800				7	525	1800	1755	876	1,36	25,21	1,95	-	1228	11247-01	1412
		2000				7	525	2000	1915	981	1,31	27,78	2,13	-	1261	-	1450
		2200				7	525	2200	2027	1049	1,29	30,70	2,35	-	1350	-	1553
11247	0600	1200	0066	YYYY	-0000	8	600	1200	1466	747	1,32	20,75	1,60	-	1189	-	1367
		1600				8	600	1600	1812	868	1,44	25,70	1,95	-	1297	-	1492
		1800				8	600	1800	1991	984	1,38	28,58	2,20	-	1381	11247-04	1588
		2000				8	600	2000	2171	1106	1,32	31,45	2,45	-	1421	11247-02	1634
		2200				8	600	2200	2289	1184	1,29	34,85	2,70	-	1522	-	1750
REF. NR. ZAROS VERTICAL ZAROS V100 : 11246																	
11246	0375	1600	0066	YYYY	-0000	5	375	1600	1352	696	1,30	18,85	1,25	-	962	-	1106
		1800				5	375	1800	1490	763	1,31	21,50	1,40	-	1019	-	1172
		2000				5	375	2000	1625	836	1,30	23,30	1,60	-	1049	-	1206
		2200				5	375	2200	1757	904	1,30	25,70	1,65	-	1116	-	1283
11246	0450	1600	0066	YYYY	-0000	6	450	1600	1607	827	1,30	22,38	1,48	-	1122	-	1290
		1800				6	450	1800	1771	902	1,32	25,38	1,68	-	1193	-	1372
		2000				6	450	2000	1931	989	1,31	27,75	1,95	-	1228	-	1412
		2200				6	450	2200	2088	1075	1,30	30,52	2,00	-	1312	-	1509
11246	0525	1600	0066	YYYY	-0000	7	525	1600	1859	952	1,31	25,92	1,72	-	1281	-	1473
		1800				7	525	1800	2049	1039	1,33	29,27	1,97	-	1362	11246-01	1566
		2000				7	525	2000	2235	1145	1,31	32,20	2,30	-	1404	-	1615
		2200				7	525	2200	2417	1244	1,30	35,33	2,35	-	1499	-	1724
11246	0600	1600	0066	YYYY	-0000	8	600	1600	2110	1081	1,31	29,45	1,95	-	1440	-	1656
		1800				8	600	1800	2326	1173	1,34	33,15	2,25	-	1539	11246-03	1770
		2000				8	600	2000	2536	1299	1,31	36,65	2,65	-	1581	11246-02	1818
		2200				8	600	2200	2742	1411	1,30	40,15	2,70	-	1693	-	1947

In conformity with EN442-1: 2014: radiators and convectors

* RAL 9016: no extra charge 15%
For heat outputs in other regimes, see p. 320 (correction factors)
EXPORT. Prices in Euro (excl. VAT)

PRICE GROUP: VPG10B - TOWEL RAILS

ACCESSORIES	WIDTH TOWEL RAIL	COLOUR	REF. NR.	€
ZAROS V75 / ZAROS V100				
TOWEL RAIL		CHROME	1183 238 0000 0099	164
<ul style="list-style-type: none"> h = 22 mm; b = 720 mm (easy adjustable) d = 75 mm; a = 56 mm 				
ZAROS V75 / ZAROS V100				
TOWEL RAIL MULTI+ RIGHT	600 mm	S600	1183 734 0000 0600	204
	600 mm	RAL 9005 ^S	1183 734 0000 9005	204
<ul style="list-style-type: none"> h = 70 mm; b = 600 mm (b tablet = 194 mm); e = 176 mm; c = 170 mm; Mounting on the wall, to the right of the radiator. 				
ZAROS V75 / ZAROS V100				
TOWEL RAIL MULTI+ LEFT	600 mm	S600	1183 735 0000 0600	204
	600 mm	RAL 9005 ^S	1183 735 0000 9005	204
<ul style="list-style-type: none"> h = 70 mm; b = 600 mm (b tablet = 194 mm); e = 176 mm; c = 170 mm; Mounting on the wall, to the left of the radiator. 				

^S structure black

Mounting instructions accessories: see www.vasco.eu
EXPORT. Prices in Euro (excl. VAT)

e = distance front of the accessory up to the wall
d = distance front of the accessory up to front of the radiator
c = distance between wall to back towel bar
a = distance accessory up to the radiator
available from stock

ZAROS CONNECTIONS

ZAROS VERTICAL: ZAROS V75 / ZAROS V100

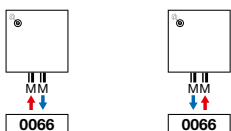

Attention: connecting the radiator can only be as shown by the connecting icons. For any other connection method, we take no responsibility.

BEAMS (BEAMS MONO)

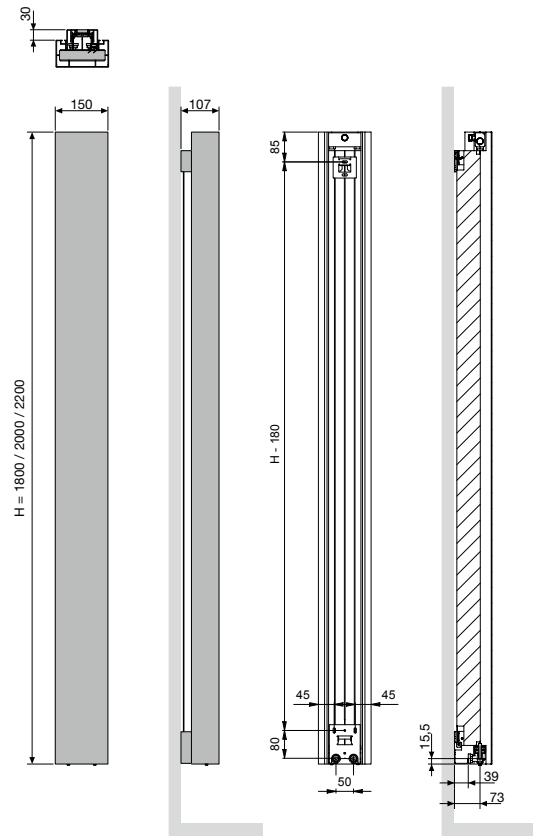

BEAMS MONO

Centre between the connections 50

BEAMS (BEAMS)

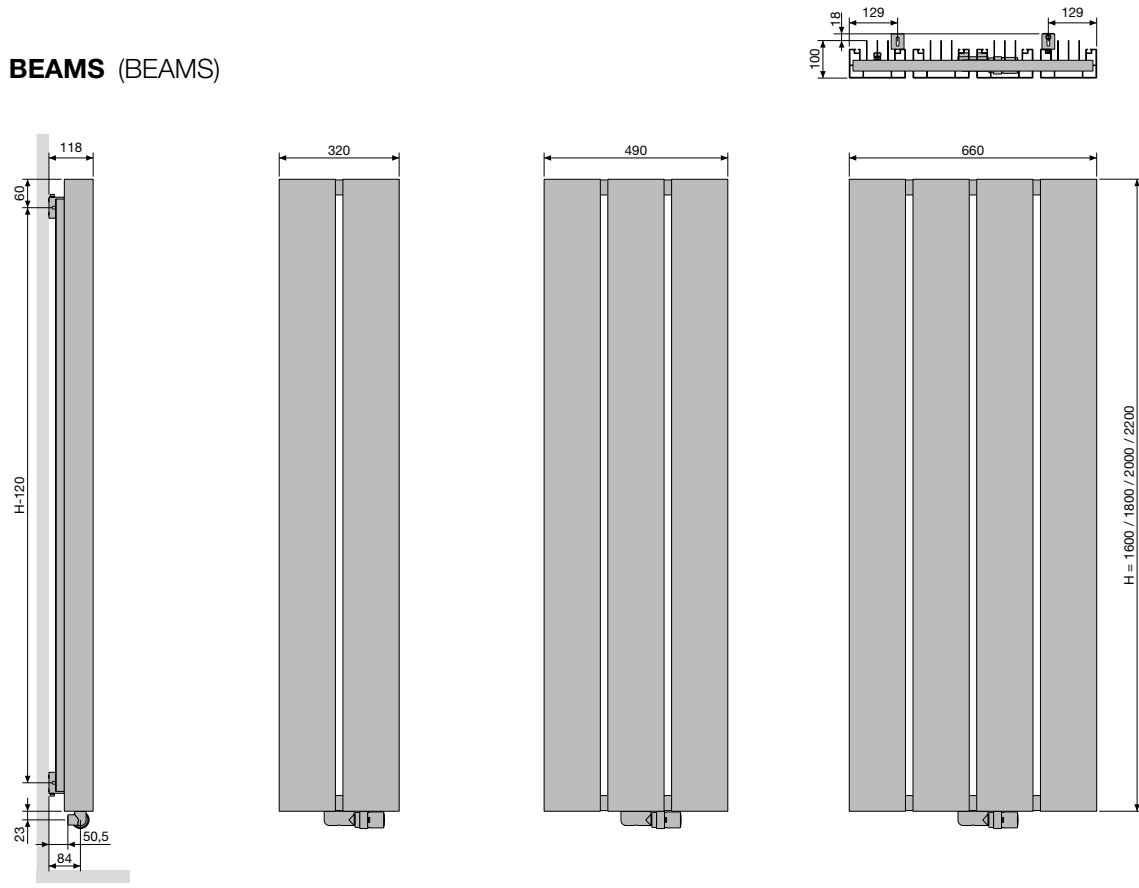

BEAMS

Centre between the connections 50
Centre between the brackets L-258

BRYCE (BRYCE MONO)

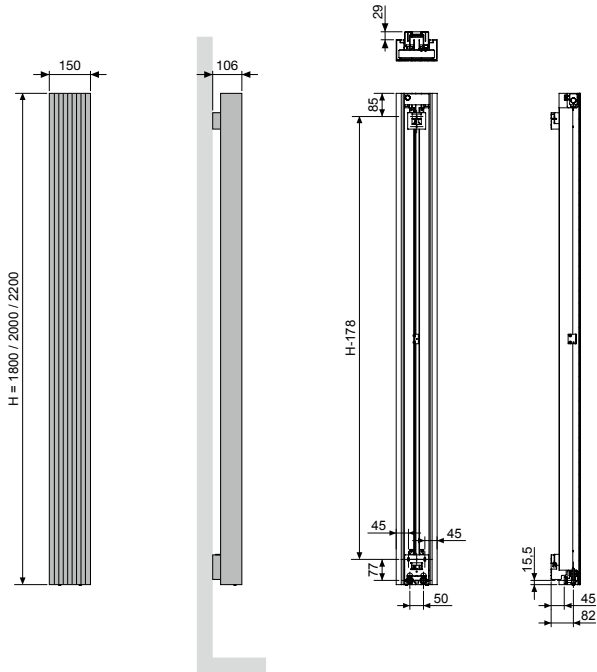

BRYCE MONO
Centre between the connections 50

BRYCE VERTICAL (BRYCE V75)

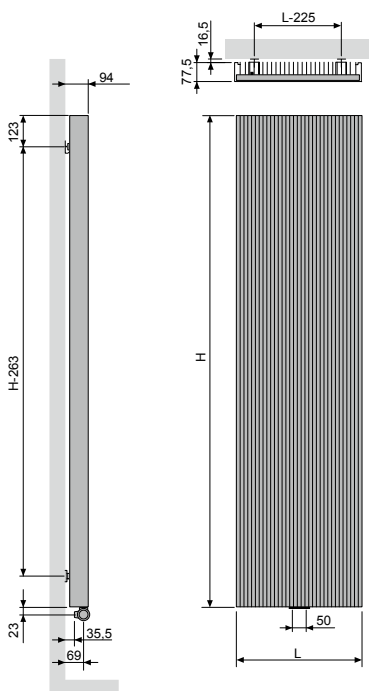

BRYCE V75
Centre between the connections 50
Centre between the brackets L-225

ALU-ZEN VERTICAL (ALU-ZEN)

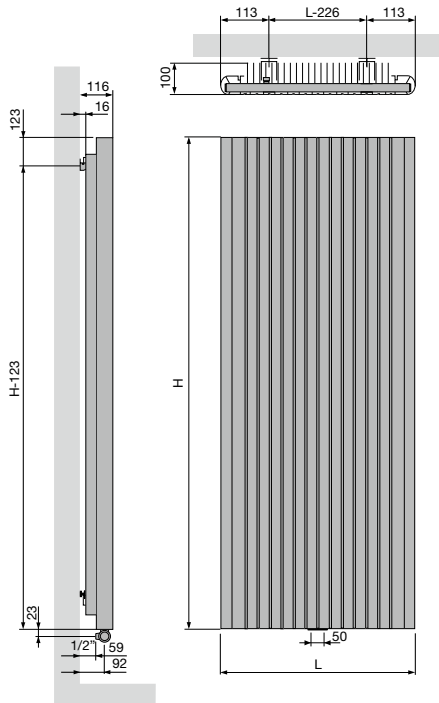

ALU-ZEN

Centre between the connections	50
Centre between the brackets	L-226

ZAROS VERTICAL (ZAROS V75, ZAROS V100)

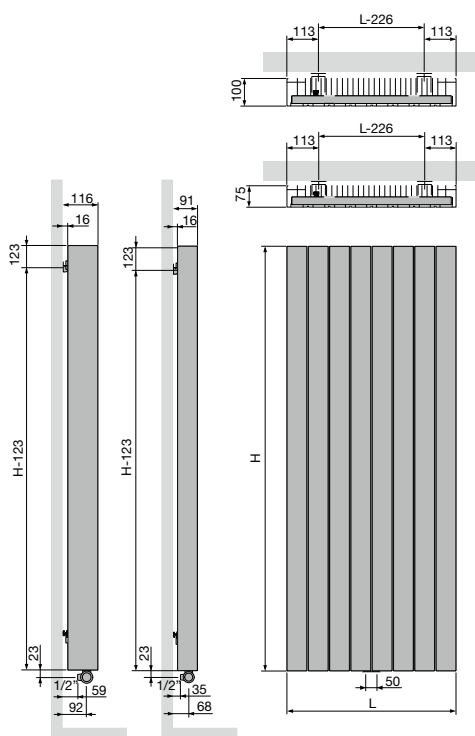

ZAROS V75 / ZAROS V100

Centre between the connections	50
Centre between the brackets	L-226



VASCO

Steel radiators



VASCO steel radiators combine an optimal heat comfort with a thoughtful, timeless design.

Every collection is a unique demonstration of warmth at its most efficient and at its best.

Customised to suit any living space. Suitable for any application. Masterpieces of technical ingenuity and creativity, awarded multiple international design awards.

Experienced technicians, innovative designers and scientific specialists together create solutions in which the details make all the difference.

Steel radiators that constantly set themselves apart by their pure design and ease of use.

Steel radiators

Niva	132
Niva Fan Coil Unit	144
Carré	154
Arche	172
Zana	179
Viola-A	192
Tulipa-A	226



NIVA BATH

Heat up your bathroom in style

How do you make a bathroom radiator just that little bit more than a stylish heat source? VASCO has the answer with the new Niva Bath! Inspired by the successful Niva radiator, the new Niva Bath stands further back from the wall (at a distance of 325 mm). Allowing more space at the rear of the radiator for additional functionality such as shelves for towels. Niva Bath is available in 55 colours and the shelves come standard in black (RAL 9005), or white (S600).

TYPES

- Single, N1L1 and NS1L1 (Soft)

COLOURS

- Standard colour S600 (fine texture white) (RAL 9016: no extra charge 15%)
- Extensive colour chart see p. 10

SPECIAL

- The Niva Vertical Lacquered is available with a lacquered front plate (this means steel plate radiator + lacquered front plate).

BRACKETS

- Wall brackets in the colour RAL 7016 (anthracite grey) standard in the packaging of the radiator (not to use for Niva Bath version). **Niva Bath accessory to be ordered separately: RAL 9005 or S600.**
- Includes 3 shelves (steel) and stainless steel coat rack support (telescopic).
- The bottom shelf is fixed, the other 2 shelves can be mounted to your choice or not.

TECHNICAL

- Electrically welded by means of resistance welding robots (invisible weld seams)
- KTL priming coat, powder coating
- Standard operating pressure: 10 bar
- Maximum operating temperature: 110°C

ELECTRICAL

- ✗ Pure electrical radiator prefilled
- ✗ Mixed radiator

TECHNICAL DRAWINGS

- See p. 150

CONNECTION

- ✗ One-point connection for one-pipe system
- ✗ One-point connection for two-pipe system
- ✓ Two-point connection for one-pipe system (connection by way of the central connection) (see p. 312)
- ✓ Two-point connection for two-pipe system (standard) (see p. 312)
- ✗ Integrated valve
- Connections: ½" (inner thread)

RECOMMENDED CONNECTION (1188)

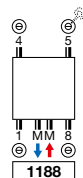

Other connection methods, see p. 149

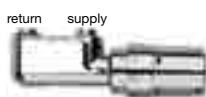

ref. nr. 1182 103 0000 0099
price € 218
 Fittings, see p. 327

RECOMMENDED FOR BATHROOM AND KITCHEN (N1L1) IN OPTION



towel rail (chrome)
 ref. nr. see p. 146
price € 187



HOW TO ORDER NIVA BATH

Delivery time 15 - 30 working days
(transport duration not included)

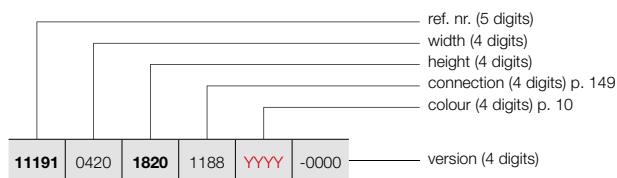

NIVA BATH (N1L1, NS1L1)

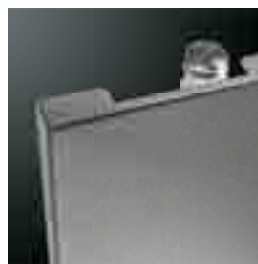

N1L1



NS1L1

HOW TO ORDER STOCK RADIATOR NIVA BATH

Delivery time 5 working days
(transport duration not included)

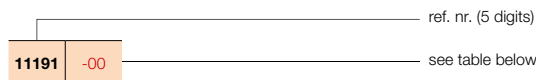

PRICE GROUP: VPG2 - STEEL DESIGN RADIATORS

REFERENCE CODE CUSTOM MADE NIVA	TECHNICAL DATA											STANDARD COLOUR		OTHER COLOURS				
	tubes	width (L mm)	height (H mm)	75/65/20 (Watt) (φ50K)	55/45/20 (Watt) (φ30K)	n-exp.	weight (kg)	water content (l)	electr. resistance (Watt)	price S600* (€)	short ref. nr. S600 stock	price colour (€)	short ref. nr. M301 stock					
REF. NR. NIVA VERTICAL LACQUERED N1L1 : 11191																		
11191	0420	1820	1188	YYY	-0000	-	420	1820	934	486	1,28	27,35	3,70	-	597	11191-03	687	11191-05
		2020				-	420	2020	1023	532	1,28	30,20	4,00	-	632	11191-06	727	-
REF. NR. NIVA SOFT VERTICAL NS1L1 : 11197																		
11197	0440	1820	1188	YYY	-0000	-	440	1820	934	486	1,28	27,35	3,70	-	597	11197-07	687	-
		2020				-	440	2020	1023	532	1,28	30,20	4,00	-	632	11197-08	727	-

In conformity with EN442-1: 2014: radiators and convectors

* RAL 9016: no extra charge 15%

For heat outputs in other regimes, see p. 320 (correction factors)
EXPORT. Prices in Euro (excl. VAT)

PRICE GROUP: VPG10B - TOWEL RAILS

NIVA BATH ACCESSORY (COAT RACK SUPPORT AND 3 SHELVES) TO BE ORDERED SEPARATELY IN COLOUR WHITE OR BLACK

HOW TO ORDER

1. Choose the model of radiator.
2. Choose the Niva Bath accessory in the colour S600 (fine texture white) or in RAL 9005 (Jet Black).

TOTAL PRICE RADIATOR NIVA BATH = PRICE RADIATOR + PRICE ACCESSORY.

	height radiator	colour	ref. nr.	price €
NIVA BATH	1820 mm	S600	1183 803 1820 0600	334
		RAL 9005 ^S	1183 803 1820 9005	334
	2020 mm	S600	1183 803 2020 0600	350
		RAL 9005 ^S	1183 803 2020 9005	350

^S structure black



NIVA VERTICAL LACQUERED (N1L1, N2L1)



TYPES

- Single (N1L1) and double (N2L1)

COLOURS

- Standard colour S600 (fine texture white) (RAL 9016: no extra charge 15%)
- Extensive colour chart see p. 10

SPECIAL

- The Niva Vertical Lacquered is available with a lacquered front plate (this means steel plate radiator + lacquered front plate).

BRACKETS

- Wall brackets in the colour RAL 7016 (anthracite grey) standard. Also in option available in the colour S600 (see p. 146).

TECHNICAL

- Electrically welded by means of resistance welding robots (invisible weld seams)
- KTL priming coat, powder coating
- Standard operating pressure: 10 bar
- Maximum operating temperature: 110°C

ELECTRICAL (available versions: see chapter electrical radiators)

- ✓ Pure electrical radiator prefilled (see p. 58)
- ✓ Mixed radiator (see p. 90)

TECHNICAL DRAWINGS

- See p. 150

CONNECTION

- ✗ One-point connection for one-pipe system
- ✗ One-point connection for two-pipe system
- ✓ Two-point connection for one-pipe system (connection by way of the central connection) (see p. 312)
- ✓ Two-point connection for two-pipe system (standard) (see p. 312)
- ✗ Integrated valve
- Connections: ½" (inner thread)

NIVA VERTICAL LACQUERED

Pure technical class, pure design, pure ambience

The ultra-compact, stylized Niva is still a founding example for many designers and colleague manufacturers. Completely functional due to the optimum air flow and the extra high heat output that starts immediately. Completely design due to the integrity, pure design, the floating character – thanks to the underlying invisible suspension and the organically integrated towel rail.

RECOMMENDED CONNECTION (1188)

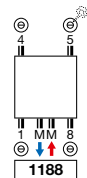

Other connection methods, see p. 149

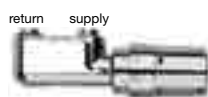

ref. nr. 1182 103 0000 0099

price € 218

Fittings, see p. 327

RECOMMENDED FOR BATHROOM AND KITCHEN IN OPTION



towel rail (chrome)
N1L1 ref. nr. see p. 146
price €187

N2L1 ref. nr. see p. 146
price €187

Other accessories, see p. 146



HOW TO ORDER NIVA VERTICAL LACQUERED

Delivery time 15 - 30 working days
(transport duration not included)

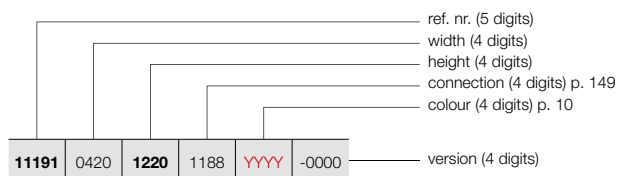

NIVA VERTICAL LACQUERED (N1L1, N2L1)

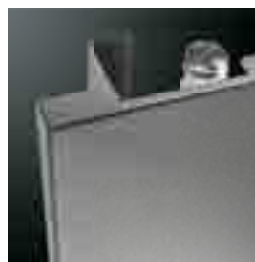

N1L1



N2L1

HOW TO ORDER STOCK RADIATOR NIVA VERTICAL LACQUERED

Delivery time 5 working days
(transport duration not included)

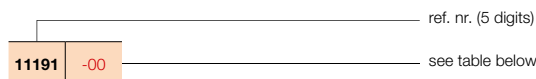

PRICE GROUP: VPG2 - STEEL DESIGN RADIATORS

REFERENCE CODE CUSTOM MADE NIVA VERTICAL LACQUERED	TECHNICAL DATA										STANDARD COLOUR		OTHER COLOURS	
	tubes	width (L mm)	height (H mm)	75/65/20 (Watt) (φ50K)	55/45/20 (Watt) (φ30K)	n-exp.	weight (kg)	water content (l)	electr. resistance (Watt)	price S600* (€)	short ref. nr. S600 stock	price colour (€)	short ref. nr. M301 stock	
REF. NR. NIVA VERTICAL LACQUERED N1L1 : 11191														
11191 0420 1220 1188 YYY -0000	-	420	1220	645	337	1,27	18,10	2,55	-	514	11191-02	591	-	
	-	420	1820	934	486	1,28	27,35	3,70	-	597	11191-03	687	11191-05	
	-	420	2020	1023	532	1,28	30,20	4,00	-	632	11191-06	727	-	
	-	420	2220	1070	559	1,27	33,20	4,50	-	681	-	783	-	
11191 0520 1220 1188 YYY -0000	-	520	1220	815	424	1,28	21,97	3,32	-	579	11191-21	666	-	
	-	520	1820	1128	587	1,28	33,67	4,61	-	672	11191-16	773	11191-01	
	-	520	2020	1257	654	1,28	37,12	5,05	-	711	11191-22	818	-	
	-	520	2220	1310	681	1,28	40,88	5,57	-	767	-	882	-	
11191 0620 1220 1188 YYY -0000	-	620	1220	985	510	1,29	25,83	3,85	-	602	11191-07	692	-	
	-	620	1820	1322	687	1,28	39,98	5,52	-	701	11191-17	806	11191-04	
	-	620	2020	1490	775	1,28	44,03	6,10	-	742	11191-20	853	-	
	-	620	2220	1550	806	1,28	48,57	6,63	-	804	-	925	-	
11191 0720 1820 1188 YYY -0000	-	720	1820	1515	784	1,29	46,30	6,43	-	728	11191-08	837	-	
	-	720	2020	1724	897	1,28	50,95	7,15	-	774	11191-09	890	-	
	-	720	2220	1790	926	1,29	56,25	7,70	-	841	-	967	-	
REF. NR. NIVA VERTICAL LACQUERED N2L1 : 11192														
11192 0420 1220 1188 YYY -0000	-	420	1220	988	506	1,31	26,50	4,90	-	770	-	886	-	
	-	420	1820	1330	681	1,31	42,23	7,28	-	894	11192-02	1028	-	
	-	420	2020	1438	736	1,31	46,75	8,00	-	928	11192-04	1067	-	
	-	420	2220	1543	823	1,23	51,40	8,90	-	982	-	1129	-	
11192 0520 1220 1188 YYY -0000	-	520	1220	1213	621	1,31	33,00	6,48	-	863	11192-05	992	-	
	-	520	1820	1633	836	1,31	51,68	9,07	-	1007	11192-31	1158	-	
	-	520	2020	1764	903	1,31	57,23	10,00	-	1045	11192-32	1202	-	
	-	520	2220	1893	995	1,26	62,73	11,00	-	1105	-	1271	-	
11192 0620 1220 1188 YYY -0000	-	620	1220	1437	732	1,32	39,50	7,02	-	902	11192-37	1037	-	
	-	620	1820	1935	991	1,31	61,14	10,86	-	1049	11192-33	1206	-	
	-	620	2020	2091	1071	1,31	67,72	12,00	-	1088	11192-34	1251	-	
	-	620	2220	2243	1160	1,29	74,07	13,10	-	1157	11192-39	1331	-	
11192 0720 1820 1188 YYY -0000	-	720	1820	2237	1146	1,31	70,60	12,65	-	1085	11192-07	1248	-	
	-	720	2020	2417	1238	1,31	78,20	14,00	-	1136	11192-35	1306	-	
	-	720	2220	2594	1322	1,32	85,40	15,20	-	1214	11192-36	1396	-	

In conformity with EN442-1: 2014: radiators and convectors

* RAL 9016: no extra charge 15%
For heat outputs in other regimes, see p. 320 (correction factors)
EXPORT. Prices in Euro (excl. VAT)

VASCO

NIVA VERTICAL STAINLESS STEEL (N1L1-ES, N2L1-ES)



TYPES

- Single (N1L1-ES) and double (N2L1-ES)

COLOURS

- Stainless steel type 316L, matt brushed with grain 360

SPECIAL

- The Niva Vertical Stainless Steel is available with a front plate in stainless steel (this means steel plate radiator + front plate in stainless steel).
- The Niva Vertical Stainless Steel can be cleaned with a stainless steel cleaner.

BRACKETS

- Wall brackets in the colour RAL 7016 (anthracite grey) standard. Also in option available in the colour S600 (see p. 146).

TECHNICAL

- Electrically welded by means of resistance welding robots (invisible weld seams)
- Standard operating pressure: 10 bar
- Maximum operating temperature: 110°C

ELECTRICAL

- ✗ Pure electrical radiator prefilled
- ✗ Mixed radiator

TECHNICAL DRAWINGS

- See p. 151

CONNECTION

- ✗ One-point connection for one-pipe system
- ✗ One-point connection for two-pipe system
- ✓ Two-point connection for one-pipe system (connection by way of the central connection) (see p. 312)
- ✓ Two-point connection for two-pipe system (standard) (see p. 312)
- ✗ Integrated valve
- Connections: 1/2" (inner thread)

NIVA VERTICAL STAINLESS STEEL

Pure class in all its glory

The Niva Vertical Stainless Steel combines steel plate construction with a stainless steel front plate which gives it a pure and clean design and its floating appearance gives the Niva 'extra shine'. The Niva Vertical Stainless Steel designer radiator is also available with an organically integrated stainless steel towel rail (optional).

RECOMMENDED CONNECTION (1188)

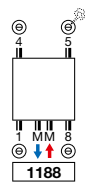

Other connection methods, see p. 149

RECOMMENDED FOR BATHROOM AND KITCHEN IN OPTION



towel rail (chrome)
N1L1 ref. nr. see p. 146
price €187

N2L1 ref. nr. see p. 146
price €187

Other accessories, see p. 146



HOW TO ORDER NIVA VERTICAL STAINLESS STEEL

Delivery time 15 - 30 working days
(transport duration not included)

NIVA VERTICAL STAINLESS STEEL (N1L1-ES, N2L1-ES)

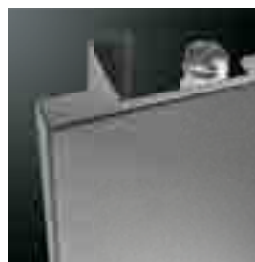
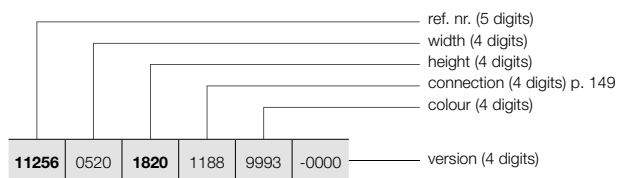

N1L1-ES



N2L1-ES

PRICE GROUP: VPG2 - STEEL DESIGN RADIATORS

REFERENCE CODE CUSTOM MADE NIVA VERTICAL STAINLESS STEEL	TECHNICAL DATA										STANDARD COLOUR				
	tubes	width (L mm)	height (H mm)	75/65/20 (Watt) (φ50K)	55/45/20 (Watt) (φ30K)	n-exp.	weight (kg)	water content (l)	electr. resistance (Watt)	price stainless steel (€)					
REF. NR. N1L1-ES : 11256															
11256	0520	1820	1188	9993	-0000	-	520	1820	1128	587	1,28	33,67	4,61	-	1243
		2020				-	520	2020	1257	654	1,28	37,12	5,05	-	1315
11256	0620	1820	1188	9993	-0000	-	620	1820	1322	687	1,28	39,98	5,52	-	1296
		2020				-	620	2020	1490	775	1,28	44,03	6,10	-	1372
REF. NR. N2L1-ES : 11257															
11257	0520	1820	1188	9993	-0000	-	520	1820	1633	836	1,31	51,68	9,07	-	1862
		2020				-	520	2020	1764	903	1,31	57,23	10,00	-	1931
11257	0620	1820	1188	9993	-0000	-	620	1820	1935	991	1,31	61,14	10,86	-	1939
		2020				-	620	2020	2091	1071	1,31	67,72	12,00	-	2013

In conformity with EN442-1: 2014: radiators and convectors

**For heat outputs in other regimes, see p. 320 (correction factors)
EXPORT. Prices in Euro (excl. VAT)**



NIVA HORIZONTAL LACQUERED (NH1L1, NH2L1, NH2L2)

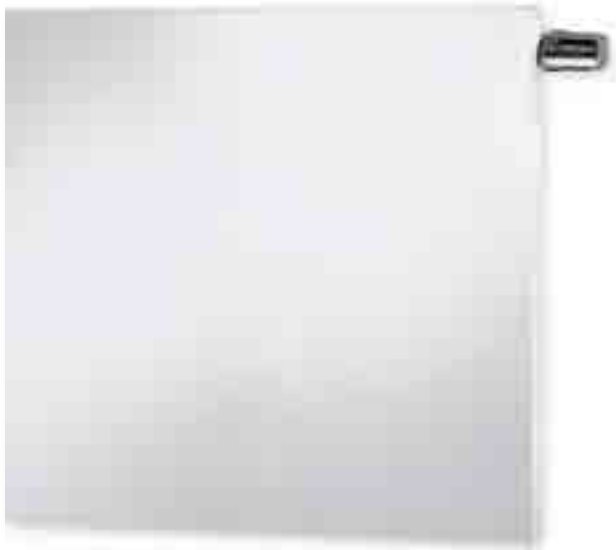

INTEGRATED VALVE NIVA HORIZONTAL LACQUERED

- Radiator in white: thermostatic head in white standard, included in the price
- Radiator in colour: thermostatic head in chrome plated standard, included in the price



TYPES

- NH1L1, NH2L1, NH2L2

COLOURS

- Standard colour S600 (fine texture white) (RAL 9016: no extra charge 15%)
- Extensive colour chart see p. 10

SPECIAL

- The Niva Horizontal Lacquered is available with 1 (NH1L1, NH2L1) or 2 rows (NH2L2) of steel fins at the back of the tubes in order to increase the heat output.
- NH1L1 also available as toilet radiator (520 x 450 mm)

BRACKETS

- Wall brackets in the colour RAL 7016 (anthracite grey) standard. Also in option available in the colour S600 (see p. 146).

TECHNICAL

- Electrically welded by means of resistance welding robots (invisible weld seams)
- KTL priming coat, powder coating
- Standard operating pressure: 10 bar
- Maximum operating temperature: 110°C

ELECTRICAL

- ✗ Pure electrical radiator prefilled
- ✗ Mixed radiator

TECHNICAL DRAWINGS

- See p. 151

CONNECTION

- ✗ One-point connection for one-pipe system
- ✗ One-point connection for two-pipe system
- ✓ Two-point connection for one-pipe system (connection by way of the integrated valve) (see p. 313)
- ✓ Two-point connection for two-pipe system (standard) (see p. 312)
- ✓ Integrated valve (**no extra charge**) (see p. 313)
- Connections: 4x1/2" side (inner thread), 2x3/4" Euro cones (50mm bottom right)

NIVA HORIZONTAL LACQUERED

Pure class in all its simplicity

Also in the horizontal version, the Niva remains an epitome of efficiently applied design. A successful combination of functionality and design, with the choice of one or two blades for a customised heat output. Also available in the toilet version. With optional towel rail in a chrome finish.

RECOMMENDED CONNECTION (0098) INTEGRATED VALVE

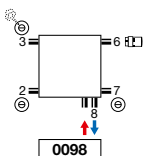

Other connection methods, see p. 149



ref. nr. 11823000000099
price € 147
Fittings, see p. 327

RECOMMENDED FOR BATHROOM AND KITCHEN IN OPTION



towel rail (chrome)
ref. nr. see p. 146
price € 187



HOW TO ORDER NIVA HORIZONTAL LACQUERED

Delivery time 15 - 30 working days
(transport duration not included)

11193	0520	0450	0098	YYYY	-0000
-------	------	------	------	------	-------

ref. nr. (5 digits)
width (4 digits)
height (4 digits)
connection (4 digits) p. 149
colour (4 digits) p. 10

version (4 digits)

NIVA HORIZONTAL LACQUERED (NH1L1, NH2L1, NH2L2)



NH1L1 / NH2L1

HOW TO ORDER STOCK RADIATOR NIVA HORIZONTAL LACQUERED

Delivery time 5 working days
(transport duration not included)

11193	-00
-------	-----

ref. nr. (5 digits)
see table below

PRICE GROUP: VPG2 - STEEL DESIGN RADIATORS

REFERENCE CODE CUSTOM MADE NIVA HORIZONTAL LACQUERED	TECHNICAL DATA									STANDARD COLOUR		OTHER COLOURS					
	tubes	width (L mm)	height (H mm)	75/65/20 (Watt) (φ50K)	55/45/20 (Watt) (φ30K)	n-exp.	weight (kg)	water content (l)	electr. resistance (Watt)	price S600* (€)	short ref. nr. S600 stock	price colour (€)					
REF. NR. NIVA HORIZONTAL LACQUERED NH1L1 : 11193																	
11193	0520	0450	0098	YYYY	-0000	-	520	450	301	158	1,26	7,50	1,19	-	469	11193-01	539
11193	0620	0550	0098	YYYY	-0000	-	620	550	425	223	1,26	11,11	1,66	-	527	-	606
		0650				-	620	650	490	256	1,27	13,28	1,92	-	593	-	682
11193	0820	0550	0098	YYYY	-0000	-	820	550	562	295	1,26	14,69	2,20	-	610	-	702
		0650				-	820	650	649	339	1,27	17,56	2,53	-	675	-	776
11193	1020	0550	0098	YYYY	-0000	-	1020	550	699	367	1,26	18,28	2,73	-	697	-	802
		0650				-	1020	650	807	422	1,27	21,85	3,15	-	761	-	875
		0950				-	1020	950	1124	585	1,28	31,85	4,40	-	940	-	1081
11193	1220	0550	0098	YYYY	-0000	-	1220	550	836	439	1,26	21,86	3,27	-	783	-	900
		0650				-	1220	650	965	504	1,27	26,13	3,77	-	849	-	976
		0950				-	1220	950	1344	699	1,28	38,10	5,26	-	1029	-	1183
REF. NR. NIVA HORIZONTAL LACQUERED NH2L1 : 11194																	
11194	0620	0550	0098	YYYY	-0000	-	620	550	611	318	1,28	17,25	3,27	-	686	-	789
		0650				-	620	650	708	370	1,27	20,70	3,83	-	804	-	925
11194	0820	0550	0098	YYYY	-0000	-	820	550	809	421	1,28	22,81	4,32	-	783	-	900
		0650				-	820	650	936	489	1,27	27,37	5,07	-	902	-	1037
11194	1020	0550	0098	YYYY	-0000	-	1020	550	1006	523	1,28	28,38	5,38	-	881	-	1013
		0650				-	1020	650	1165	609	1,27	34,05	6,30	-	997	11194-23	1147
		0950				-	1020	950	1630	839	1,30	50,20	9,05	-	1198	-	1378
11194	1220	0550	0098	YYYY	-0000	-	1220	550	1203	626	1,28	33,94	6,43	-	976	-	1122
		0650				-	1220	650	1393	728	1,27	40,72	7,54	-	1093	-	1257
		0950				-	1220	950	1950	1004	1,30	60,05	10,82	-	1286	-	1479
11194	1420	0550	0098	YYYY	-0000	-	1420	550	1400	728	1,28	39,50	7,48	-	1136	-	1306
		0650				-	1420	650	1622	848	1,27	47,40	8,78	-	1272	-	1463
11194	1620	0550	0098	YYYY	-0000	-	1620	550	1597	830	1,28	45,07	8,54	-	1296	-	1490
		0650				-	1620	650	1850	967	1,27	54,08	10,01	-	1454	-	1672

In conformity with EN442-1: 2014: radiators and convectors

* RAL 9016: no extra charge 15%
For heat outputs in other regimes, see p. 320 (correction factors)
EXPORT. Prices in Euro (excl. VAT)

NIVA HORIZONTAL LACQUERED (NH2L2)



NH2L2

HOW TO ORDER NIVA HORIZONTAL LACQUERED

Delivery time 15 - 30 working days
(transport duration not included)

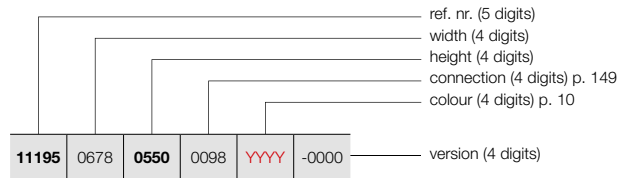

HOW TO ORDER STOCK RADIATOR NIVA HORIZONTAL LACQUERED

Delivery time 5 working days
(transport duration not included)

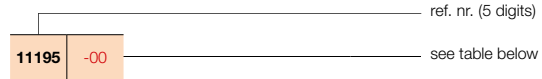

PRICE GROUP: VPG2 - STEEL DESIGN RADIATORS

REFERENCE CODE CUSTOM MADE NIVA HORIZONTAL LACQUERED	TECHNICAL DATA									STANDARD COLOUR		OTHER COLOURS
	tubes	width (L mm)	height (H mm)	75/65/20 (Watt) (φ50K)	55/45/20 (Watt) (φ30K)	n-exp.	weight (kg)	water content (l)	electr. resistance (Watt)	price S600* (€)	short ref. nr. S600 stock	price colour (€)
REF. NR. NIVA HORIZONTAL LACQUERED NH2L2 : 11195												
11195 0678 0550 0098 YYYY -0000	-	678	550	804	416	1,29	20,50	3,40	-	858	-	987
	-	678	650	941	487	1,29	24,28	3,93	-	1008	-	1159
11195 0878 0550 0098 YYYY -0000	-	878	550	1041	539	1,29	26,55	4,40	-	988	-	1136
	-	878	650	1219	631	1,29	31,44	5,09	-	1137	-	1308
11195 1078 0550 0098 YYYY -0000	-	1078	550	1279	662	1,29	32,60	5,40	-	1117	-	1285
	-	1078	650	1496	774	1,29	38,60	6,25	-	1266	11195-16	1456
	-	1078	950	2027	1043	1,30	57,90	9,00	-	1498	-	1723
11195 1278 0550 0098 YYYY -0000	-	1278	550	1516	784	1,29	38,65	6,40	-	1243	-	1429
	-	1278	650	1774	918	1,29	45,77	7,41	-	1393	-	1602
	-	1278	950	2403	1237	1,30	68,64	10,67	-	1626	-	1870
11195 1478 0550 0098 YYYY -0000	-	1478	550	1753	907	1,29	44,69	7,40	-	1440	-	1656
	-	1478	650	2051	1061	1,29	52,93	8,57	-	1614	-	1856
11195 1678 0550 0098 YYYY -0000	-	1678	550	1990	1030	1,29	50,74	8,41	-	1633	-	1878
	-	1678	650	2329	1205	1,29	60,09	9,73	-	1831	-	2106

In conformity with EN442-1: 2014: radiators and convectors

* RAL 9016: no extra charge 15%
For heat outputs in other regimes, see p. 320 (correction factors)
EXPORT. Prices in Euro (excl. VAT)

TYPES

- Single (NS1L1) and double (NS2L1)

COLOURS

- Standard colour S600 (fine texture white) (RAL 9016: no extra charge 15%)
- Extensive colour chart see p. 10

SPECIAL

- The Niva Soft Vertical is available with a lacquered front plate (this means steel plate radiator + lacquered front plate).
- With a flat front plate and rounded sides as a modern-day touch
- Thermostatic head at doorknob height in option (not for NS1L1) (see p. 313).



BRACKETS

- Wall brackets in the colour RAL 7016 (anthracite grey) standard. Also in option available in the colour S600 (see p. 146).

TECHNICAL

- Electrically welded by means of resistance welding robots (invisible weld seams)
- KTL priming coat, powder coating
- Standard operating pressure: 10 bar
- Maximum operating temperature: 110°C

ELECTRICAL

- ✗ Pure electrical radiator prefilled
- ✗ Mixed radiator

TECHNICAL DRAWINGS

- See p. 152

CONNECTION

- ✗ One-point connection for one-pipe system
- ✗ One-point connection for two-pipe system
- ✓ Two-point connection for one-pipe system (connection by way of the central connection) (see p. 312)
- ✓ Two-point connection for two-pipe system (standard) (see p. 312)
- ✓ Integrated valve (**extra charge €157**) (not for NS1L1) (see p. 313)
- Connections: ½" (inner thread)

RECOMMENDED CONNECTION NS1L1/NS2L1 (1188)

return supply

ref. nr. 1182 103 0000 0099
price € 218
 Fittings, see p. 327

RECOMMENDED FOR BATHROOM AND KITCHEN IN OPTION

towel rail (aluminium)
 NS1L1 ref. nr. see p. 146
price € 187

OPTION: CONNECTION NS2L1 (0098) INTEGRATED VALVE (SUPPLEMENT)

ref. nr. 1182 301 0000 0099
price € 147
 Fittings, see p. 327

Supplement: €157 (see p. 313)
 Other connection methods, see p. 149



VASCO

NIVA SOFT VERTICAL

Pure class in all its creativity

The Niva in all its compact, stylish simplicity, but designed with softly rounded edges. A designer radiator that perfectly comes into its own with both a minimalist interior and a contemporary retro surround. Available with a thermostat knob at doorknob height.

Other accessories, see p. 146



NIVA SOFT VERTICAL (NS1L1, NS2L1)



NS1L1



NS2L1

HOW TO ORDER NIVA SOFT

Delivery time 15 - 30 working days
(transport duration not included)

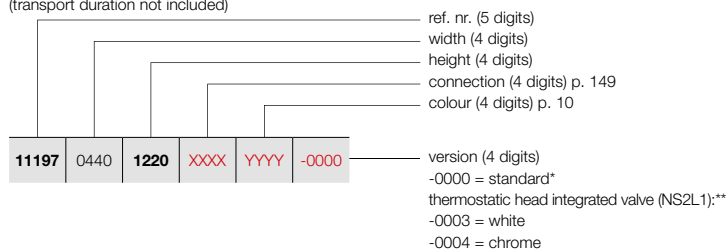

HOW TO ORDER STOCK RADIATOR NIVA SOFT

Delivery time 5 working days
(transport duration not included)

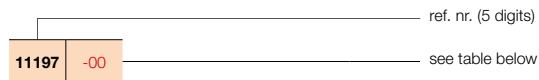

PRICE GROUP: VPG2 - STEEL DESIGN RADIATORS

REFERENCE CODE CUSTOM MADE NIVA SOFT VERTICAL						TECHNICAL DATA									STANDARD COLOUR		OTHER COLOURS	
						tubes	width (L mm)	height (H mm)	75/65/20 (Watt) (φ50K)	55/45/20 (Watt) (φ30K)	n-exp.	weight (kg)	water content (l)	electr. resistance (Watt)	price S600* (€)	short ref. nr. S600 stock	price colour (€)	
REF. NR. NIVA SOFT VERTICAL NS1L1 : 11197																		
11197	0440	1220	XXXX	YYYY	-0000	-	440	1220	645	337	1,27	18,10	2,55	-	514	11197-06	591	
		1820				-	440	1820	934	486	1,28	27,35	3,70	-	597	11197-07	687	
		2020				-	440	2020	1023	532	1,28	30,20	4,00	-	632	11197-08	727	
		2220				-	440	2220	1070	559	1,27	33,20	4,50	-	681	-	783	
11197	0540	1220	XXXX	YYYY	-0000	-	540	1220	815	424	1,28	21,97	3,32	-	579	11197-04	666	
		1820				-	540	1820	1128	587	1,28	33,67	4,61	-	672	11197-01	773	
		2020				-	540	2020	1257	654	1,28	37,12	5,05	-	711	11197-05	818	
		2220				-	540	2220	1310	681	1,28	40,88	5,57	-	767	-	882	
11197	0640	1220	XXXX	YYYY	-0000	-	640	1220	985	510	1,29	25,83	3,85	-	602	11197-09	692	
		1820				-	640	1820	1322	687	1,28	39,98	5,52	-	701	11197-02	806	
		2020				-	640	2020	1490	775	1,28	44,03	6,10	-	742	11197-03	853	
		2220				-	640	2220	1550	806	1,28	48,57	6,63	-	804	-	925	
11197	0740	1820	XXXX	YYYY	-0000	-	740	1820	1515	784	1,29	46,30	6,43	-	728	11197-10	837	
		2020				-	740	2020	1724	897	1,28	50,95	7,15	-	774	11197-11	890	
		2220				-	740	2220	1790	926	1,29	56,25	7,70	-	841	-	967	
REF. NR. NIVA SOFT VERTICAL NS2L1 : 11198																		
11198	0440	1220	XXXX	YYYY	-0000	-	440	1220	988	506	1,31	28,40	4,90	-	770	-	886	
		1820				-	440	1820	1330	681	1,31	42,23	7,28	-	894	11198-08	1028	
		2020				-	440	2020	1438	736	1,31	46,75	8,00	-	928	11198-09	1067	
		2220				-	440	2220	1543	823	1,23	51,40	8,90	-	982	-	1129	
11198	0540	1220	XXXX	YYYY	-0000	-	540	1220	1213	621	1,31	36,83	6,48	-	863	11198-10	992	
		1820				-	540	1820	1633	836	1,31	51,68	9,07	-	1007	11198-01	1158	
		2020				-	540	2020	1764	903	1,31	57,23	10,00	-	1045	11198-02	1202	
		2220				-	540	2220	1893	995	1,26	62,73	11,00	-	1105	-	1271	
11198	0640	1220	XXXX	YYYY	-0000	-	640	1220	1437	732	1,32	38,17	7,02	-	902	-	1037	
		1820				-	640	1820	1935	991	1,31	61,14	10,86	-	1049	11198-03	1206	
		2020				-	640	2020	2091	1071	1,31	67,72	12,00	-	1088	11198-04	1251	
		2220				-	640	2220	2243	1160	1,29	74,07	13,10	-	1157	-	1331	
11198	0740	1820	XXXX	YYYY	-0000	-	740	1820	2237	1146	1,31	70,60	12,65	-	1085	11198-11	1248	
		2020				-	740	2020	2417	1238	1,31	78,20	14,00	-	1136	11198-05	1306	
		2220				-	740	2220	2594	1322	1,32	85,40	15,20	-	1214	-	1396	

In conformity with EN442-1: 2014: radiators and convectors

* RAL 9016: no extra charge 15%

For heat outputs in other regimes, see p. 320 (correction factors)
EXPORT. Prices in Euro (excl. VAT)



NOT AVAILABLE
OUTSIDE THE
EU

NIVA

FAN COIL UNIT

heating & cooling



NIVA FAN COIL UNIT

heating & cooling

Year after year, the heat pump gains more ground in new and existing houses. Experts agree: this is the energy source of the future. The end-user benefits twice, because a heat pump not only heats in an energy-efficient manner but also cools the house - certainly when combined with VASCO's brand-new Niva Fan Coil Unit! A fan coil unit is a heat exchanger including lamellas in which a fan blows hot or cold air into the room. This system, which functions at low water temperatures of 30 - 40°C, has great advantages when combined with a heat pump. The fan coil unit can be used in all the rooms of a house, but it is especially beneficial in bedrooms where we need both heating and cooling. The fan coil unit heats or cools a bedroom in no time from 18°C to 22°C or from 28°C to 24°C. In case of cooling water temperatures between 7 and 12°C are used.

The solution for cosy winters and cool summers!

- 2^{IN}1** the ideal 2-in-1 solution
the desired temperature at a fast speed
- ideal combined with a heat pump**
cooling is only possible using a heat pump with cooling function
- for low water temperature systems**
- superbly quiet operation**
- with modulating fan-regulation**
- includes a copper/aluminium heat exchanger**
- energy-efficient operation**
- touch display with intuitive control**
- recoatable**

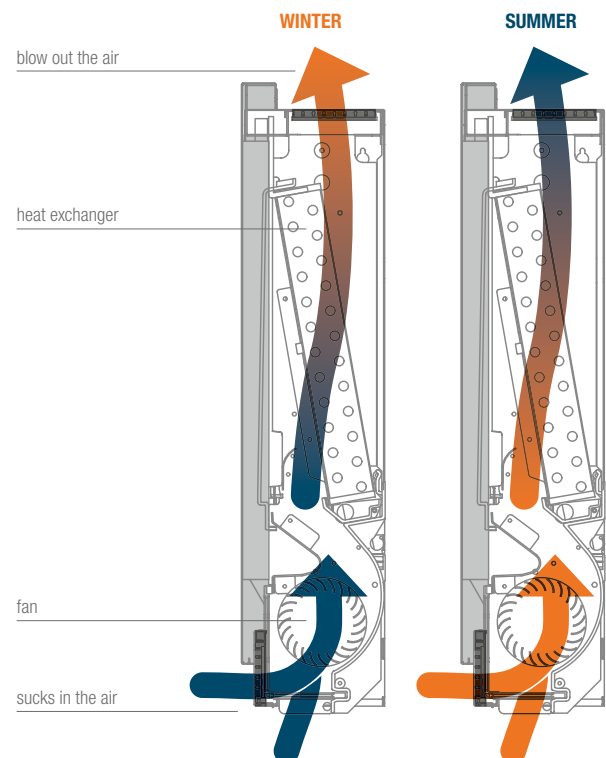

2-IN-1

The Niva fan coil unit generates a comfortable temperature level to each room in your house. The fan coil unit reheats your house in cold weather and provides highly needed cooling during warm days!



NOT AVAILABLE
OUTSIDE THE
EU

NIVA FAN COIL UNIT



PRICE GROUP: VPG8 - FAN COIL

TECHNICAL DATA						STANDARD COLOUR	
width (L mm)	height (H mm)	45/40/20 (Watt)	35/30/20 (Watt)	weight (kg)	water content (l)	price S600 (€)	short ref. nr. S600
TYPE: FC75							
750	610	1018	536	18,00	0,47	-	11600-01
TYPE: FC95							
950	610	2205	1165	21,00	0,80	-	11600-02
TYPE: FC115							
1150	610	3013	1639	24,00	1,13	-	11600-03

In conformity with EN442-1: 2014: radiators and convectors
For heat outputs in other regimes, see p. 320 (correction factors)
Prices on demand





TECHNICAL DATA

		FC75	FC95	FC115
General data				
Heating capacity at 45 / 40 / 20°C	W	1018	2205	3013
Water flow rate	l/h	146	294	438
Pressure loss	kPA	9,10	9,20	19,00
Heating capacity at 35 / 30 / 20°C	W	536	1165	1639
Total cooling capacity at 7 / 12 / 27°C 50% RV	W	955	2222	2914
Palpable cooling capacity	W	683	1483	2043
Water flow rate	l/h	164	381	499
Pressure loss	kPA	13,20	8,90	18,30
Maximum operating pressure	bar	10	10	10
Hydraulic connection		3/4" EK	3/4" EK	3/4" EK
Air technical data				
Maximum air flow rate	m ³ /h	146	294	438
Air flow rate at medium speed	m ³ /h	91	210	318
Air flow rate at minimum speed	m ³ /h	49	124	194
Electric data				
Supply voltage	V/ph/Hz	230/1/50	230/1/50	230/1/50
Maximum power consumption	W	11	19	20
Maximum current consumption	A	0,11	0,16	0,19
Power consumption at minimum speed	W	5	4	6
Noise data				
Sound pressure at maximum air flow *	dB(A)	41	42	44
Sound pressure at average air flow *	dB(A)	33	34	34
Sound pressure at minimum air flow *	dB(A)	24	25	26
Sound power at maximum speed *	dB(A)	54	53	54

* Measured at 1 metre according to ISO 7779

VASCO







BRACKETS		HEIGHT RADIATOR	COLOUR	REF. NR.
N1L1 / N1L1-ES / NS1L1*				
WALL BRACKET		1220 mm	S600	11871 04 1100 0600
		1820 mm	S600	11871 04 1700 0600
		2020 mm	S600	11871 04 1900 0600
		2220 mm	S600	11871 04 2100 0600
N2L1 / N2L1-ES / NS2L1				
WALL BRACKET		1220 mm	S600	11871 05 1100 0600
		1820 mm	S600	11871 05 1700 0600
		2020 mm	S600	11871 05 1900 0600
		2220 mm	S600	11871 05 2100 0600
NH1L1				
WALL BRACKET		450 mm	S600	11871 02 0400 0600
		550 mm	S600	11871 02 0500 0600
		650 mm	S600	11871 02 0600 0600
		950 mm	S600	11871 02 0900 0600
NH2L1 / NH2L2				
WALL BRACKET		550 mm	S600	11871 03 0500 0600
		650 mm	S600	11871 03 0600 0600
		950 mm	S600	11871 03 0900 0600

Prices: see price list "spare parts"

* not available for NS1L1 with integrated valve

PRICE GROUP: VPG10B - TOWEL RAILS

ACCESSORIES	WIDTH TOWEL RAIL	COLOUR	REF. NR.	€
N1L1* / N2L1 / N1L1-ES / N2L1-ES / NS1L1* / NS2L1				
TOWEL RAIL MULTI+ RIGHT 	600 mm	S600	1183 734 0000 0600	204
	600 mm	RAL 9005 ^S	1183 734 0000 9005	204
<ul style="list-style-type: none"> • h = 70 mm; b = 600 mm (b tablet = 194 mm); e = 176 mm; c = 170 mm; • Mounting on the wall, to the right of the radiator. 				
N1L1* / N2L1 / N1L1-ES / N2L1-ES / NS1L1* / NS2L1				
TOWEL RAIL MULTI+ LEFT 	600 mm	S600	1183 735 0000 0600	204
	600 mm	RAL 9005 ^S	1183 735 0000 9005	204
<ul style="list-style-type: none"> • h = 70 mm; b = 600 mm (b tablet = 194 mm); e = 176 mm; c = 170 mm; • Mounting on the wall, to the left of the radiator. 				
N1L1* / N1L1-ES / NS1L1*				
SHORT TOWEL RAIL 	240 mm	S600	1183 710 0000 0600	135
	240 mm	RAL 9005 ^S	1183 710 0000 9005	135
N2L1 / N2L1-ES / NS2L1				
	240 mm	S600	1183 720 0000 0600	135
	240 mm	RAL 9005 ^S	1183 720 0000 9005	135
<ul style="list-style-type: none"> • N1L1 / N1L1-ES: d = 66,5 mm; a = 56,5 mm • NS1L1: d = 68 mm; a = 58 mm • N2L1 / N2L1-ES: d = 59,5 mm; a = 49,5 mm • NS2L1: d = 58 mm; a = 48 mm 				
N1L1* / N1L1-ES / NS1L1*				
LONG TOWEL RAIL 	440 mm	S600	1183 711 0000 0600	135
	440 mm	RAL 9005 ^S	1183 711 0000 9005	135
N2L1 / N2L1-ES / NS2L1				
	440 mm	S600	1183 721 0000 0600	135
	440 mm	RAL 9005 ^S	1183 721 0000 9005	135
<ul style="list-style-type: none"> • N1L1 / N1L1-ES: d = 66,5 mm; a = 56,5 mm • NS1L1: d = 68 mm; a = 58 mm • N2L1 / N2L1-ES: d = 59,5 mm; a = 49,5 mm • NS2L1: d = 58 mm; a = 48 mm 				

^S structure black

* Not possible for Niva Bath

Mounting instructions accessories: see www.vasco.eu
EXPORT. Prices in Euro (excl. VAT)

e = distance front of the accessory up to the wall
d = distance front of the accessory up to front of the radiator
c = distance between wall to back towel bar
a = distance accessory up to the radiator
available from stock

ACCESSORIES		WIDTH TOWEL RAIL	COLOUR	REF. NR.	€		
TOWEL RAIL		N1L1* / N1L1-ES / NS1L1*					
		372 mm	ALUMINIUM	1183 239 0000 0000	187		
		372 mm	CHROME	1183 239 0000 0099	187		
		372 mm	S600	1183 239 0000 0600	187		
		372 mm	RAL 9005 ^M	1183 239 0000 9005	187		
		526 mm	CHROME	1183 271 0000 0099	187		
		526 mm	S600	1183 271 0000 0600	187		
		526 mm	RAL 9005 ^M	1183 271 0000 9005	187		
<ul style="list-style-type: none"> Towel rail in aluminium h = 55 mm; b = 372, 526 mm; d = 56 mm; a = 50 mm; 							
TOWEL RAIL		N2L1 / N2L1-ES / NS2L1					
		372 mm	ALUMINIUM	1183 240 0000 0000	187		
		372 mm	CHROME	1183 240 0000 0099	187		
		372 mm	S600	1183 240 0000 0600	187		
		372 mm	RAL 9005 ^M	1183 240 0000 9005	187		
		526 mm	CHROME	1183 272 0000 0099	187		
		526 mm	S600	1183 272 0000 0600	187		
		526 mm	RAL 9005 ^M	1183 272 0000 9005	187		
<ul style="list-style-type: none"> Towel rail in aluminium h = 55 mm; b = 372, 526 mm; d = 56 mm; a = 50 mm; 							
TOWEL RAIL		WIDTH RADIATOR	COLOUR	REF. NR.	€		
		N1L1 / N1L1-ES / NIVA BATH					
		420 mm	CHROME	1183 213 0000 0099	187		
		520 mm	CHROME	1183 214 0000 0099	187		
		520 mm	STAINLESS STEEL	1183 214 0000 9993	187		
		620 mm	CHROME	1183 215 0000 0099	187		
		620 mm	STAINLESS STEEL	1183 215 0000 9993	187		
		720 mm	CHROME	1183 216 0000 0099	187		
		<ul style="list-style-type: none"> h = 25 mm; b = 440, 540, 640, 740 mm; d = 73 mm; a = 57 mm 					
		TOWEL RAIL		N2L1 / N2L1-ES			
420 mm	CHROME			1183 218 0000 0099	187		
520 mm	CHROME			1183 219 0000 0099	187		
520 mm	DISCONTINUED ITEM STAINLESS STEEL			1183 219 0000 9993	187		
620 mm	CHROME			1183 220 0000 0099	187		
620 mm	DISCONTINUED ITEM STAINLESS STEEL			1183 220 0000 9993	187		
720 mm	CHROME			1183 221 0000 0099	187		
<ul style="list-style-type: none"> h = 25 mm; b = 440, 540, 640, 740 mm; d = 73 mm; a = 57 mm 							
TOWEL RAIL		NH1L1 / NH2L1 / NH2L2					
			CHROME	1183 217 0000 0099	187		
<ul style="list-style-type: none"> h = 25 mm; b = 740 mm (easy adjustable); d = 73 mm; a = 57 mm 							
NIVA BATH		HEIGHT RADIATOR	COLOUR	REF. NR.	€		
		N1L1 / NS1L1					
		1820 mm	S600	1183 803 1820 0600	334		
		1820 mm	RAL 9005 ^S	1183 803 1820 9005	334		
		2020 mm	S600	1183 803 2020 0600	350		
2020 mm	RAL 9005 ^S	1183 803 2020 9005	350				
<ul style="list-style-type: none"> width radiator N1L1: 420 mm; width radiator NS1L1: 440 mm; 							

^S structure black
^M matt black
* Not possible for Niva Bath

d = distance front of the accessory up to front of the radiator
a = distance accessory up to the radiator
available from stock

Mounting instructions accessories: see www.vasco.eu
EXPORT. Prices in Euro (excl. VAT)

NIVA BATH: N1L1 / NS1L1

NIVA VERTICAL LACQUERED: N1L1 / N2L1

NIVA VERTICAL STAINLESS STEEL: N1L1-ES / N2L1-ES

NIVA SOFT VERTICAL: NS1L1 / NS2L1 (without integrated valve)

NIVA MIXED: N1L1-EL-MIX

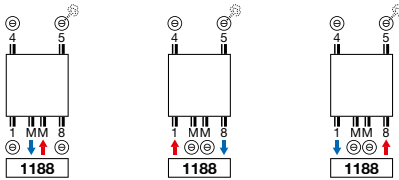

- **Attention:** MM with supply on the right.

NIVA SOFT VERTICAL: NS2L1

INTEGRATED VALVE

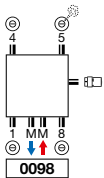

- **Supplement:** €157 (see p. 313)
- **Attention:** MM with supply on the right (on this connection, there is a flow tube at the back).

NIVA HORIZONTAL LACQUERED: NH1L1 / NH2L1 / NH2L2

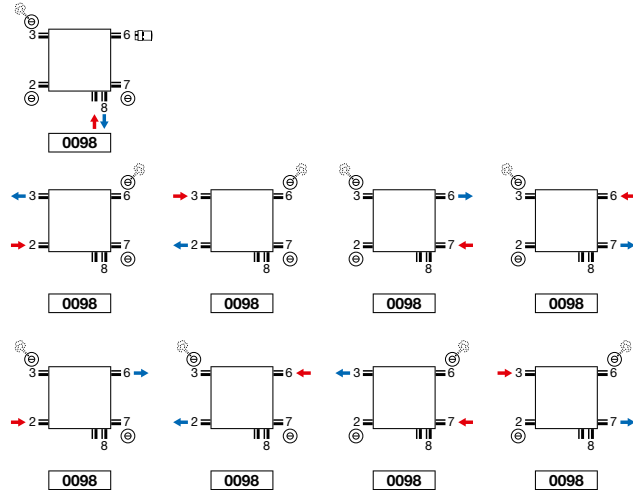

- **Integrated valve:** no extra charge (see p. 313)
- **Thermostatic head only to use with connection on the valve (supply left, return right). Other connections, eg. 23, take thermostatic head out of connection 6. Here the possibility to change the supply and the return.**

NIVA BATH (N1L1, NS1L1)

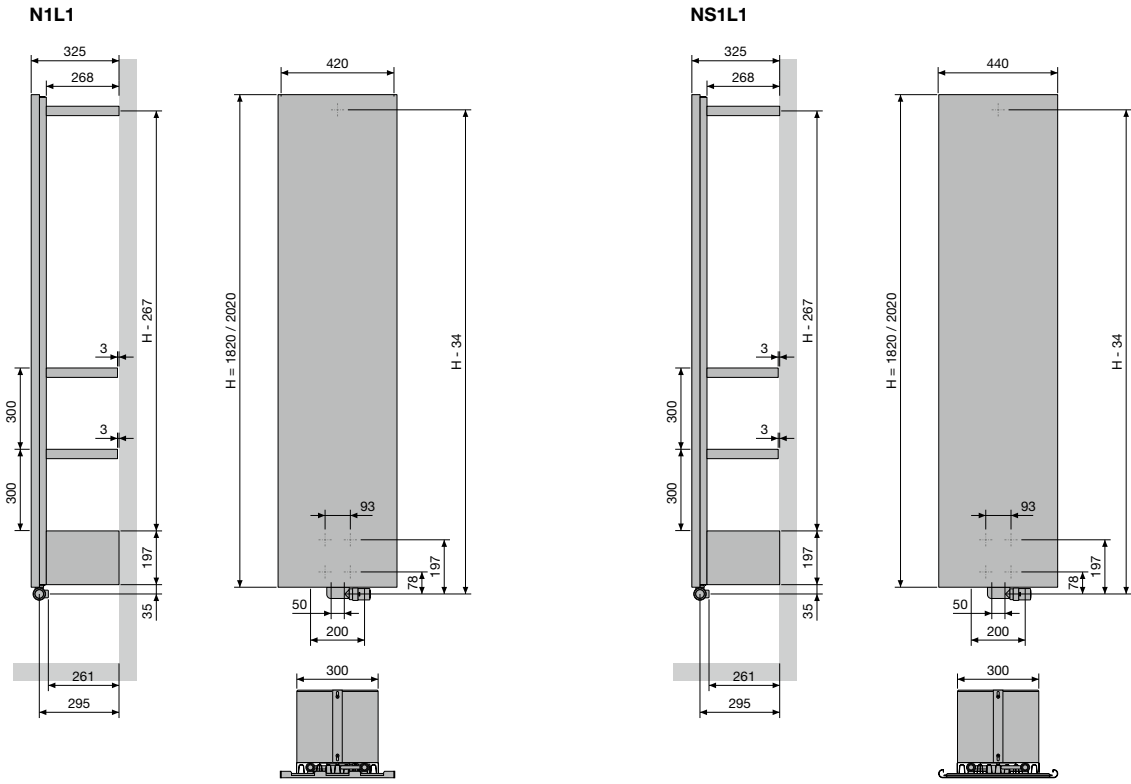

NIVA VERTICAL LACQUERED (N1L1, N2L1)

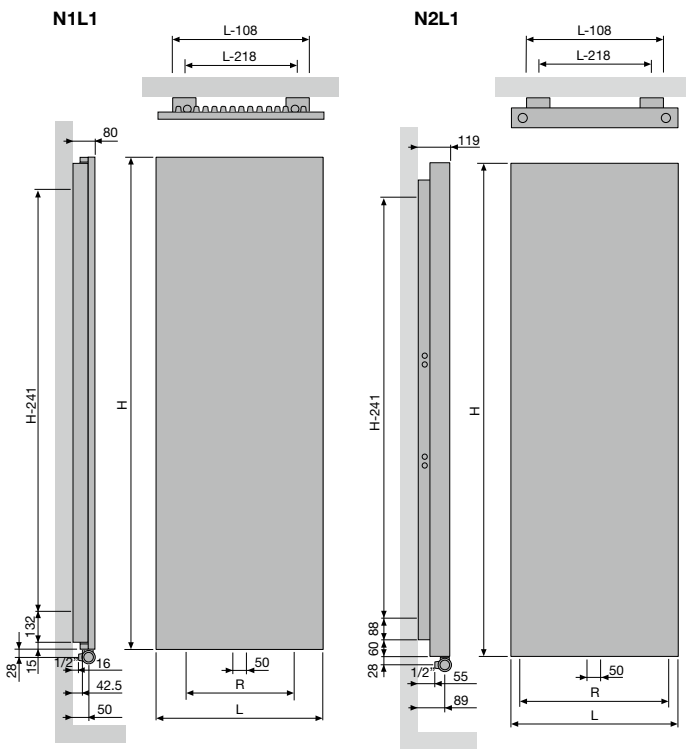

		N1L1			
Width (L)		420	520	620	720
Centre between the connections at the bottom 18 (R)		200	300	400	500
Centre between the brackets		L-218	H-241		
		N2L1			
Width (L)		420	520	620	720
Centre between the connections at the bottom 18 (R)		338	438	538	638
Centre between the brackets		L-218	H-241		

NIVA VERTICAL STAINLESS STEEL (N1L1-ES, N2L1-ES)

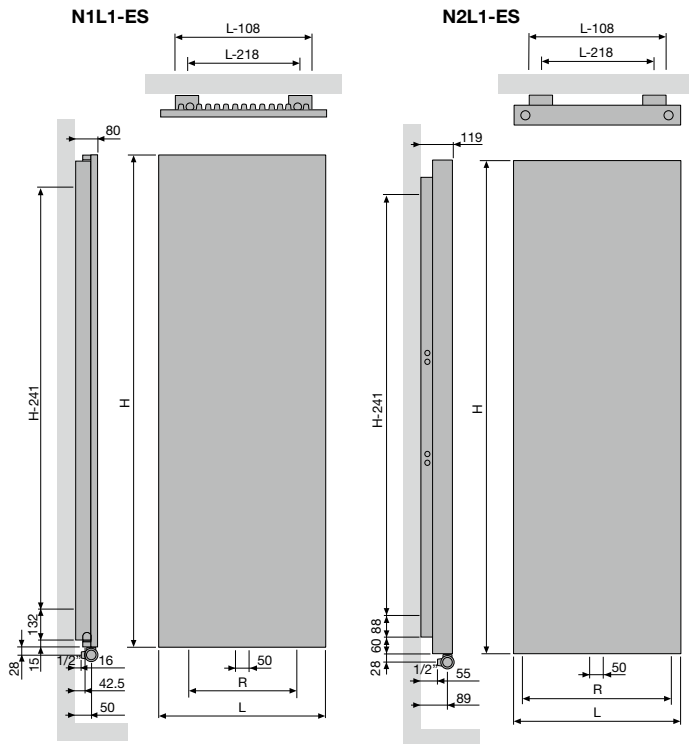

N1L1-ES			
Width (L)	520	620	
Centre between the connections at the bottom 18 (R)	300	400	
Centre between the brackets	L-218	H-241	

N2L1-ES			
Width (L)	520	620	
Centre between the connections at the bottom 18 (R)	438	538	
Centre between the brackets	L-218	H-241	

NIVA HORIZONTAL LACQUERED (NH1L1, NH2L1)

NH1L1 / NH2L1

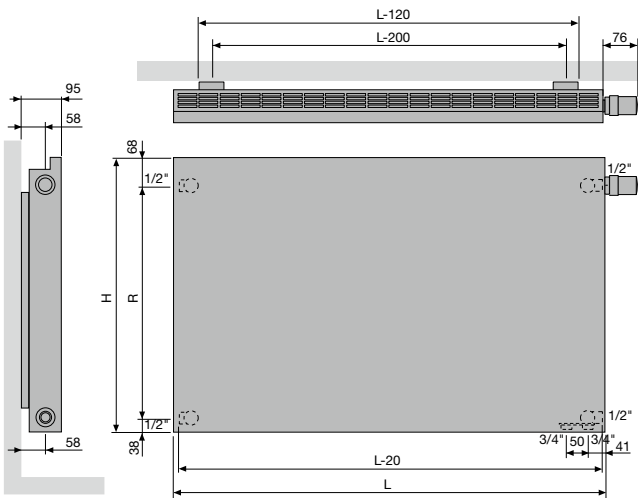

NH1L1				
height (H)	450	550	650	950
Centre between the lateral connections 23/67 (R)	343	443	543	843
Centre between the brackets	L-200			

NH2L1				
height (H)	550	650	950	
Centre between the lateral connections 23/67 (R)	443	543	843	
Centre between the brackets	L-200			

NIVA HORIZONTAL LACQUERED (NH2L2)

NH2L2

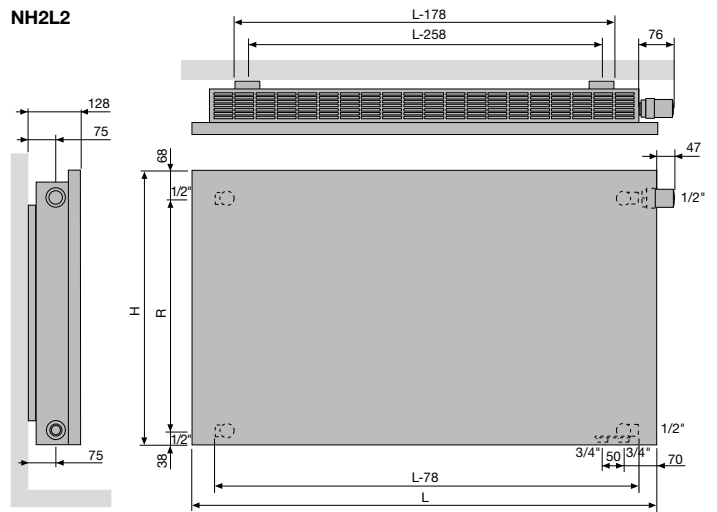

NH2L2			
height (H)	550	650	950
Centre between the lateral connections 23/67 (R)	443	543	843
Centre between the brackets	L-258		

NIVA SOFT VERTICAL (NS1L1)

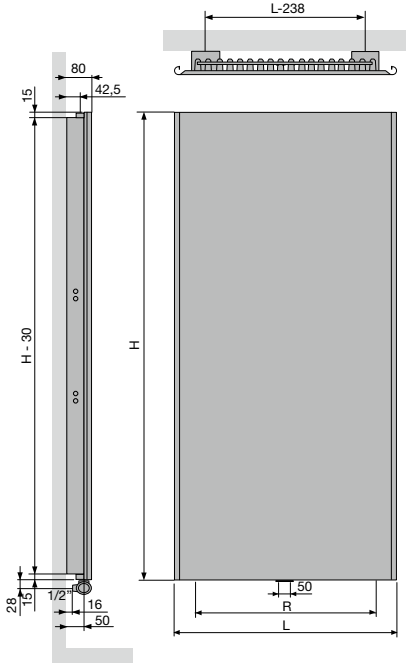

NS1L1				
Width (L)	440	540	640	740
Centre between the connections at the bottom (R)	200	300	400	500
Centre between the brackets	L-238	H-241		

NIVA SOFT VERTICAL (NS2L1)

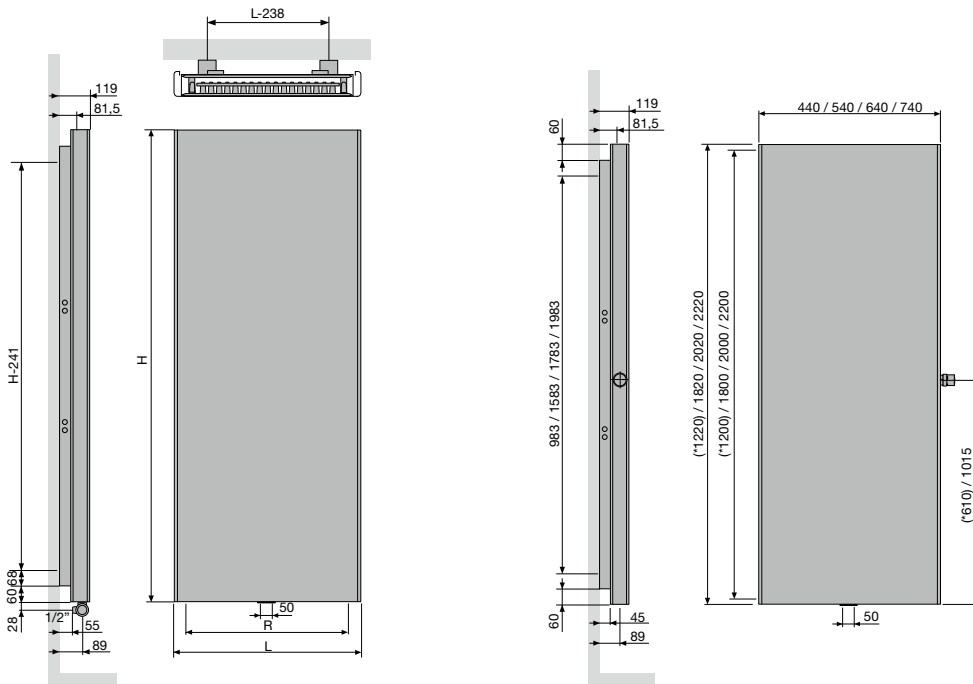

NS2L1				
Width (L)	440	540	640	740
Centre between the connections at the bottom (R)	338	438	538	638
Centre between the brackets	L-238	H-241		

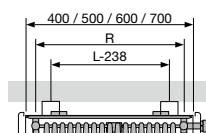



NOT AVAILABLE
OUTSIDE THE
EU

NIVA FAN COIL UNIT

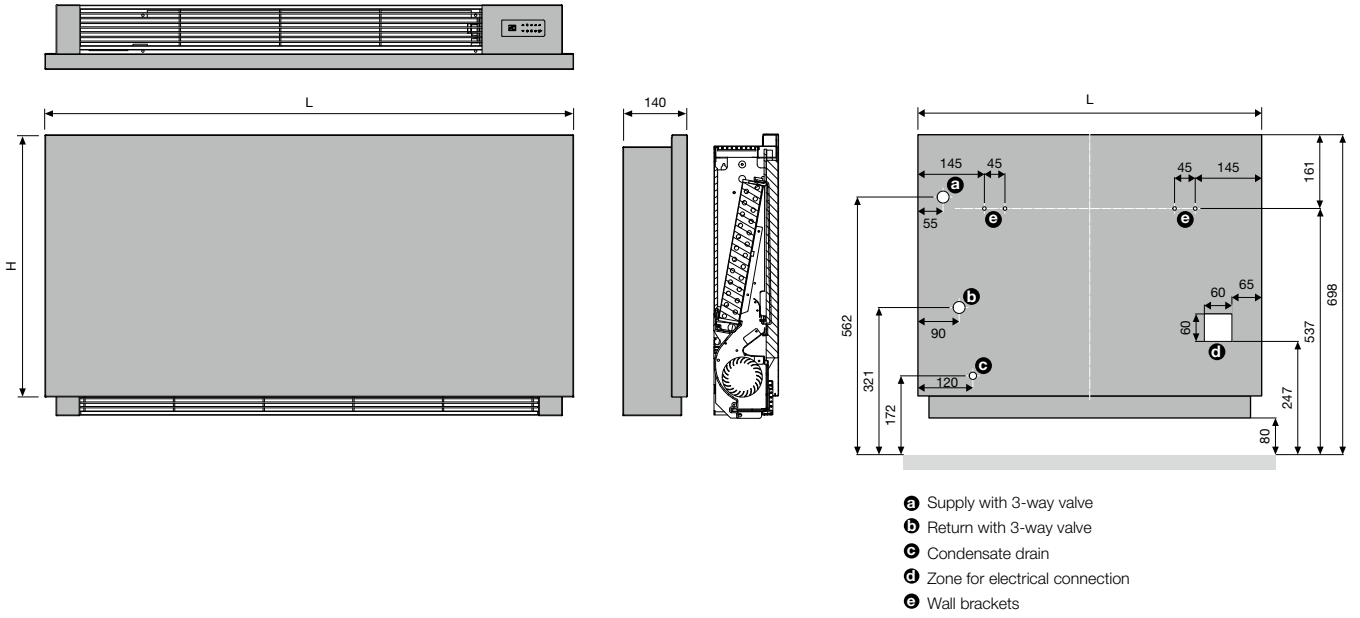

CARRÉ PLUS VERTICAL (CPVN-PLUS)



TYPES

- Vertical: Carré Plus (CPVN-PLUS)

TUBES

- Vertical, square 25 x 25 mm

COLLECTORS

- Horizontal, round Ø 35 mm

COLOURS

- Standard colour white RAL 9016
- Extensive colour chart see p. 10

BRACKETS

- Wall brackets standard

TECHNICAL

- Welded by means of resistance welding robots (invisible weld seams)
- KTL priming coat, powder coating
- Standard operating pressure: 10 bar
- Maximum operating temperature: 110°C

ELECTRICAL

- ✗ Pure electrical radiator prefilled
- ✗ Mixed radiator

TECHNICAL DRAWINGS

- See p. 170

CONNECTION

- ✗ One-point connection for one-pipe system
- ✗ One-point connection for two-pipe system
- ✓ Two-point connection for one-pipe system (connection by way of the central connection) (see p. 312)
- ✓ Two-point connection for two-pipe system (standard) (see p. 312)
- ✗ Integrated valve
- Connections: ½" (inner thread)

CARRÉ PLUS VERTICAL

Minimum clearance, maximum effect

An icon in the world of designer radiators. VASCO developed a whole new type of tube especially for the Carré with sharp corners for an austere design and with optimum thermal efficiency with a minimum clearance. The flat look creates a sense of calm, enhanced by the concealed, beautifully integrated collector. A highly praised designer radiator for which VASCO, as always, also developed the appropriate accessories.

RECOMMENDED CONNECTION (1188)

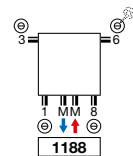

Other connection methods, see p. 169

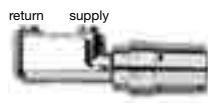

ref. nr. 1182 103 0000 0099
price € 218
 Fittings, see p. 327

RECOMMENDED FOR BATHROOM AND KITCHEN IN OPTION



towel rail straight (chrome)
 ref. nr. see p. 168
price € 187

Other accessories, see p. 168



HOW TO ORDER CARRÉ PLUS VERTICAL

Delivery time 15 - 30 working days
(transport duration not included)

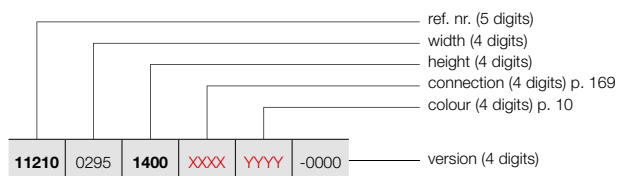

CPVN-PLUS

HOW TO ORDER STOCK RADIATOR CARRÉ PLUS VERTICAL

Delivery time 5 working days
(transport duration not included)

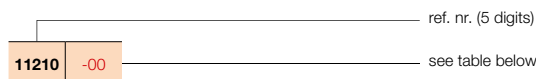

PRICE GROUP: VPG2 - STEEL DESIGN RADIATORS

REFERENCE CODE CUSTOM MADE CARRÉ PLUS VERTICAL	TECHNICAL DATA									STANDARD COLOUR		OTHER COLOURS					
	tubes	width (L mm)	height (H mm)	75/65/20 (Watt) (φ50K)	55/45/20 (Watt) (φ30K)	n-exp.	weight (kg)	water content (l)	electr. resistance (Watt)	price RAL 9016 (€)	short ref. nr. RAL 9016 stock	price colour (€)					
REF. NR. CARRÉ PLUS VERTICAL CPVN-PLUS : 11210																	
11210	0295	1400	XXXX	YYYY	-0000												
						10	295	1400	871	443	1,31	19,70	8,40	-	485	-	558
						10	295	1600	986	505	1,31	21,60	9,40	-	531	-	611
						10	295	1800	1097	559	1,32	23,60	10,50	-	573	-	659
						10	295	2000	1206	614	1,32	26,20	12,00	-	619	-	712
10	295	2200	1312	672	1,31	28,90	13,50	-	664	-	764						
11210	0355	1400	XXXX	YYYY	-0000												
						12	355	1400	1026	521	1,31	23,16	10,08	-	584	-	672
						12	355	1600	1161	595	1,31	25,44	11,28	-	637	-	733
						12	355	1800	1293	659	1,32	27,72	12,48	-	691	11210-16	795
						12	355	2000	1421	724	1,32	30,96	14,40	-	743	-	854
12	355	2200	1545	791	1,31	34,08	16,20	-	791	-	910						
11210	0415	1400	XXXX	YYYY	-0000												
						14	415	1400	1179	599	1,31	26,46	11,76	-	677	-	779
						14	415	1600	1334	683	1,31	29,12	13,16	-	743	-	854
						14	415	1800	1485	757	1,32	31,64	14,56	-	807	-	928
						14	415	2000	1632	836	1,31	35,42	16,66	-	865	11210-05	995
14	415	2200	1775	909	1,31	39,20	18,90	-	927	-	1066						
11210	0475	1400	XXXX	YYYY	-0000												
						16	475	1400	1330	676	1,31	29,60	13,28	-	775	-	891
						16	475	1600	1505	771	1,31	32,48	14,88	-	851	-	979
						16	475	1800	1675	853	1,32	35,52	16,48	-	922	-	1060
						16	475	2000	1841	943	1,31	39,84	19,04	-	993	-	1142
16	475	2200	2002	1025	1,31	44,00	21,60	-	1058	-	1217						
11210	0535	1400	XXXX	YYYY	-0000												
						18	535	1400	1478	751	1,31	32,58	14,94	-	870	-	1001
						18	535	1600	1673	857	1,31	35,82	16,74	-	958	-	1102
						18	535	1800	1862	954	1,31	39,06	18,54	-	1037	11210-07	1193
						18	535	2000	2046	1048	1,31	43,92	21,42	-	1117	11210-09	1285
18	535	2200	2226	1140	1,31	48,78	24,30	-	1190	-	1369						
11210	0595	1400	XXXX	YYYY	-0000												
						20	595	1400	1625	826	1,31	35,20	16,60	-	969	-	1114
						20	595	1600	1839	942	1,31	39,00	18,60	-	1063	-	1222
						20	595	1800	2047	1048	1,31	42,60	20,40	-	1152	11210-11	1325
						20	595	2000	2250	1152	1,31	48,00	23,60	-	1239	11210-12	1425
20	595	2200	2447	1260	1,30	53,40	27,00	-	1323	-	1521						
11210	0655	1400	XXXX	YYYY	-0000												
						22	655	1400	1771	900	1,31	37,84	18,26	-	1068	-	1228
						22	655	1600	2004	1026	1,31	41,80	20,24	-	1169	-	1344
						22	655	1800	2231	1143	1,31	45,76	22,44	-	1267	-	1457
						22	655	2000	2451	1255	1,31	51,70	25,96	-	1365	-	1570
22	655	2200	2666	1372	1,30	57,64	29,48	-	1455	-	1673						
11210	0715	1400	XXXX	YYYY	-0000												
						24	715	1400	1915	973	1,31	40,32	19,68	-	1165	-	1340
						24	715	1600	2167	1110	1,31	44,64	22,08	-	1277	-	1469
						24	715	1800	2412	1235	1,31	48,96	24,24	-	1381	-	1588
						24	715	2000	2651	1365	1,30	55,44	28,32	-	1488	-	1711
24	715	2200	2883	1484	1,30	61,92	32,16	-	1587	-	1825						

In conformity with EN442-1: 2014: radiators and convectors

For heat outputs in other regimes, see p. 320 (correction factors)
EXPORT. Prices in Euro (excl. VAT)

VASCO

CARRÉ PLUS VERTICAL (CPVN-PLUS)



CPVN-PLUS

HOW TO ORDER CARRÉ PLUS VERTICAL

Delivery time 15 - 30 working days
(transport duration not included)

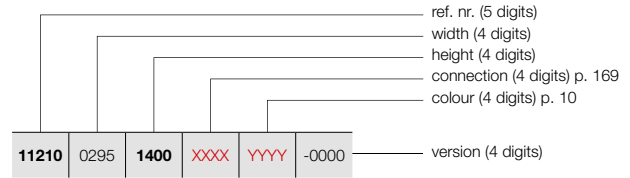

PRICE GROUP: VPG2 - STEEL DESIGN RADIATORS

REFERENCE CODE CUSTOM MADE CARRÉ PLUS VERTICAL	TECHNICAL DATA										STANDARD COLOUR		OTHER COLOURS				
	tubes	width (L mm)	height (H mm)	75/65/20 (Watt) (φ50K)	55/45/20 (Watt) (φ30K)	n-exp.	weight (kg)	water content (l)	electr. resistance (Watt)	price RAL 9016 (€)	short ref. nr. RAL 9016 stock	price colour (€)					
REF. NR. CARRÉ PLUS VERTICAL CPVN-PLUS : 11210																	
11210	0775	1400	XXXX	YYYY	-0000	26	775	1400	2058	1046	1,31	42,64	21,32	-	1263	-	1452
		1600				26	775	1600	2329	1193	1,31	47,32	23,92	-	1381	-	1588
		1800				26	775	1800	2592	1334	1,30	51,74	26,26	-	1497	-	1722
		2000				26	775	2000	2849	1467	1,30	58,76	30,68	-	1612	-	1854
		2200				26	775	2200	3098	1595	1,30	65,78	34,84	-	1719	-	1977
11210	0895	1400	XXXX	YYYY	-0000	30	895	1400	2341	1189	1,31	46,80	24,60	-	1455	-	1673
		1600				30	895	1600	2649	1357	1,31	51,90	27,30	-	1594	-	1833
		1800				30	895	1800	2949	1518	1,30	57,00	30,00	-	1727	-	1986
		2000				30	895	2000	3240	1668	1,30	65,10	35,10	-	1857	-	2136
		2200				30	895	2200	3524	1814	1,30	73,20	40,20	-	1983	-	2280

In conformity with EN442-1: 2014: radiators and convectors

For heat outputs in other regimes, see p. 320 (correction factors)
EXPORT. Prices in Euro (excl. VAT)

TYPES

- Two rows (CPVN2-ZB) of tubes

TUBES

- Vertical, square 25 x 25 mm

COLLECTORS

- Horizontal, round Ø 35 mm

COLOURS

- Standard colour white RAL 9016
- Extensive colour chart see p. 10

BRACKETS

- Wall brackets in the colour RAL 9016 standard. Also in option available in the colour RAL 7016 (see p. 167).

TECHNICAL

- Welded by means of resistance welding robots (invisible weld seams)
- KTL priming coat, powder coating
- Standard operating pressure: 10 bar
- Maximum operating temperature: 110°C

ELECTRICAL

- ✗ Pure electrical radiator prefilled
- ✗ Mixed radiator

TECHNICAL DRAWINGS

- See p. 170

CONNECTION

- ✗ One-point connection for one-pipe system
- ✗ One-point connection for two-pipe system
- ✓ Two-point connection for one-pipe system (connection by way of the central connection) (see p. 312)
- ✓ Two-point connection for two-pipe system (standard) (see p. 312)
- ✗ Integrated valve
- Connections: ½" (inner thread)



RECOMMENDED CONNECTION (1188)

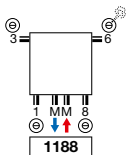

Other connection methods, see p. 169

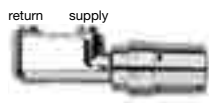

ref. nr. 1182 103 0000 0099

price € 218

Fittings, see p. 327

**RECOMMENDED FOR BATHROOM AND KITCHEN
IN OPTION**



towel rail straight (chrome)

ref. nr. see p. 168

price € 187

Other accessories, see p. 168

CARRÉ VERTICAL

Top design with double heat capacity

The sleek, smooth look of the Carré Plus, which has a double row of pipes for maximum heat output. The Carré Vertical designer radiator continues to be its timeless, functional self, but the extra capacity ensures optimum efficiency, even in larger spaces.



CARRÉ VERTICAL (CPVN2-ZB)



CPVN2-ZB

HOW TO ORDER CARRÉ VERTICAL

Delivery time 15 - 30 working days
(transport duration not included)

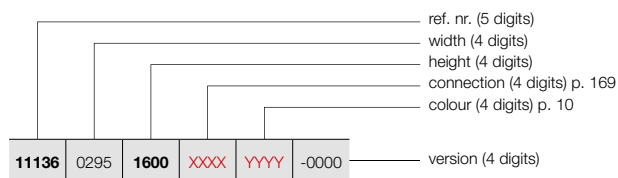

PRICE GROUP: VPG2 - STEEL DESIGN RADIATORS

REFERENCE CODE CUSTOM MADE CARRÉ VERTICAL	tubes	width (L mm)	height (H mm)	TECHNICAL DATA						STANDARD COLOUR	OTHER COLOURS					
				75/65/20 (Watt) (ø50K)	55/45/20 (Watt) (ø30K)	n-exp.	weight (kg)	water content (l)	electr. resistance (Watt)	price RAL 9016 (€)	price colour (€)					
REF. NR. CARRÉ VERTICAL CPVN2-ZB : 11136																
11136	0295	1600	XXXX	YYYY	-0000	10	295	1600	1062	533	1,35	30,20	15,80	-	851	979
		1800				10	295	1800	1174	589	1,35	33,80	17,90	-	922	1060
		2000				10	295	2000	1279	642	1,35	37,30	20,10	-	993	1142
		2200				10	295	2200	1377	691	1,35	40,60	21,30	-	1058	1217
		2400				10	295	2400	1469	737	1,35	43,80	22,60	-	1123	1291
		2600				10	295	2600	1555	780	1,35	47,10	23,90	-	1186	1364
		2800				10	295	2800	1635	820	1,35	50,30	25,10	-	1248	1435
		3000				10	295	3000	1709	858	1,35	53,60	26,40	-	1309	1505
11136	0355	1600	XXXX	YYYY	-0000	12	355	1600	1275	640	1,35	36,24	18,96	-	1020	1173
		1800				12	355	1800	1409	707	1,35	40,56	21,48	-	1106	1272
		2000				12	355	2000	1534	770	1,35	44,76	24,12	-	1190	1369
		2200				12	355	2200	1652	829	1,35	48,72	25,56	-	1268	1458
		2400				12	355	2400	1763	885	1,35	52,56	27,12	-	1347	1549
		2600				12	355	2600	1866	936	1,35	56,52	28,68	-	1422	1635
		2800				12	355	2800	1962	984	1,35	60,36	30,12	-	1496	1720
		3000				12	355	3000	2050	1029	1,35	64,32	31,68	-	1569	1804
11136	0415	1600	XXXX	YYYY	-0000	14	415	1600	1487	746	1,35	42,28	22,12	-	1190	1369
		1800				14	415	1800	1643	824	1,35	47,32	25,06	-	1294	1488
		2000				14	415	2000	1790	898	1,35	52,22	28,14	-	1388	1596
		2200				14	415	2200	1928	967	1,35	56,84	29,82	-	1484	1707
		2400				14	415	2400	2057	1032	1,35	61,32	31,64	-	1569	1804
		2600				14	415	2600	2177	1092	1,35	65,94	33,46	-	1660	1909
		2800				14	415	2800	2289	1149	1,35	70,42	35,14	-	1749	2011
		3000				14	415	3000	2392	1200	1,35	75,04	36,96	-	1831	2106
11136	0475	1600	XXXX	YYYY	-0000	16	475	1600	1700	853	1,35	48,32	25,28	-	1362	1566
		1800				16	475	1800	1878	942	1,35	54,08	28,64	-	1474	1695
		2000				16	475	2000	2046	1027	1,35	59,68	32,16	-	1587	1825
		2200				16	475	2200	2203	1105	1,35	64,96	34,08	-	1691	1945
		2400				16	475	2400	2351	1180	1,35	70,08	36,16	-	1795	2064
		2600				16	475	2600	2488	1248	1,35	75,36	38,24	-	1900	2185
		2800				16	475	2800	2616	1313	1,35	80,48	40,16	-	1999	2299
		3000				16	475	3000	2734	1372	1,35	85,76	42,24	-	2095	2409
11136	0535	1600	XXXX	YYYY	-0000	18	535	1600	1912	959	1,35	54,36	28,44	-	1531	1761
		1800				18	535	1800	2113	1060	1,35	60,84	32,22	-	1660	1909
		2000				18	535	2000	2301	1155	1,35	67,14	36,18	-	1785	2053
		2200				18	535	2200	2479	1244	1,35	73,08	38,34	-	1904	2190
		2400				18	535	2400	2644	1327	1,35	78,84	40,68	-	2024	2328
		2600				18	535	2600	2799	1404	1,35	84,78	43,02	-	2137	2458
		2800				18	535	2800	2942	1476	1,35	90,54	45,18	-	2249	2586
		3000				18	535	3000	3075	1543	1,35	96,48	47,52	-	2353	2706

In conformity with EN442-1: 2014: radiators and convectors

**For heat outputs in other regimes, see p. 320 (correction factors)
EXPORT. Prices in Euro (excl. VAT)**

HOW TO ORDER CARRÉ VERTICAL
 Delivery time 15 - 30 working days
 (transport duration not included)

CARRÉ VERTICAL (CPVN2-ZB)

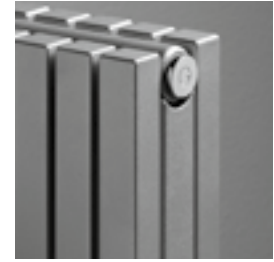
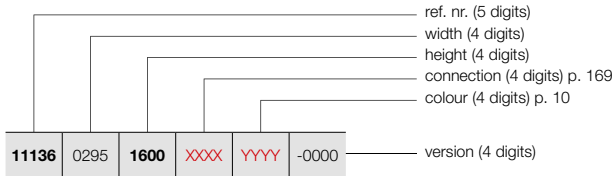

CPVN2-ZB

PRICE GROUP: VPG2 - STEEL DESIGN RADIATORS

REFERENCE CODE CUSTOM MADE CARRÉ VERTICAL	TECHNICAL DATA									STANDARD COLOUR	OTHER COLOURS
	tubes	width (L mm)	height (H mm)	75/65/20 (Watt) (φ50K)	55/45/20 (Watt) (φ30K)	n-exp.	weight (kg)	water content (l)	electr. resistance (Watt)	price RAL 9016 (€)	price colour (€)
REF. NR. CARRÉ VERTICAL CPVN2-ZB : 11136											
11136	0595	1600	XXXX	YYYY	-0000						
		1800									
		2000									
		2200									
		2400									
		2600									
		2800									
		3000									
11136	0655	1600	XXXX	YYYY	-0000						
		1800									
		2000									
		2200									
		2400									
		2600									
		2800									
		3000									
11136	0715	1600	XXXX	YYYY	-0000						
		1800									
		2000									
		2200									
		2400									
		2600									
		2800									
		3000									
11136	0775	1600	XXXX	YYYY	-0000						
		1800									
		2000									
		2200									
		2400									
		2600									
		2800									
		3000									
11136	0895	1600	XXXX	YYYY	-0000						
		1800									
		2000									
		2200									
		2400									
		2600									

VASCO

In conformity with EN442-1: 2014: radiators and convectors

For heat outputs in other regimes, see p. 320 (correction factors)
 EXPORT. Prices in Euro (excl. VAT)

CARRÉ HORIZONTAL (CPHN1-RO, CPHN2-RO)



TYPES

- One (CPHN1-RO) or two rows (CPHN2-RO) of tubes

TUBES

- Horizontal, square 25 x 25 mm

COLLECTORS

- Vertical, round Ø 35 mm

COLOURS

- Standard colour white RAL 9016
- Extensive colour chart see p. 10

SPECIAL

- CPHN1-RO also available as toilet radiator (600 x 415 mm)

BRACKETS

- Wall brackets in the colour RAL 9016 standard. Also in option available in the colour RAL 7016 (see p. 167).

TECHNICAL

- Welded by means of resistance welding robots (invisible weld seams)
- KTL priming coat, powder coating
- Standard operating pressure: 10 bar
- Maximum operating temperature: 110°C

ELECTRICAL

- ✗ Pure electrical radiator prefilled
- ✗ Mixed radiator

TECHNICAL DRAWINGS

- See p. 171

CONNECTION

- ✗ One-point connection for one-pipe system
- ✗ One-point connection for two-pipe system
- ✗ Two-point connection for one-pipe system
- ✓ Two-point connection for two-pipe system (standard) (see p. 312)
- ✗ Integrated valve
- Connections: ½" (inner thread)

CARRÉ HORIZONTAL

Top design for all your heating requirements

The horizontal version of the Carré, with your choice of one or two rows of pipes, for customised heat emission in any room. A designer radiator that also in the horizontal version, stands out thanks to its sleek design and flat look, enhanced by the fully integrated collector.

RECOMMENDED CONNECTION (0018)

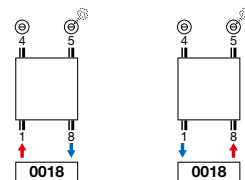

Other connection methods, see p. 169



ref. nr. 1182 101 0000 0099

price € 218

Fittings, see p. 327

RECOMMENDED FOR BATHROOM AND KITCHEN IN OPTION



towel rail straight (chrome)

ref. nr. see p. 168

price € 187

Other accessories, see p. 168



HOW TO ORDER CARRÉ HORIZONTAL

Delivery time 15 - 30 working days
(transport duration not included)

CARRÉ HORIZONTAL (CPHN1-RO)

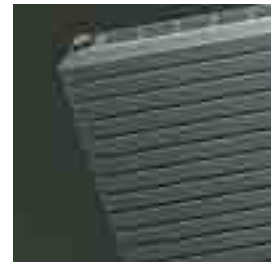
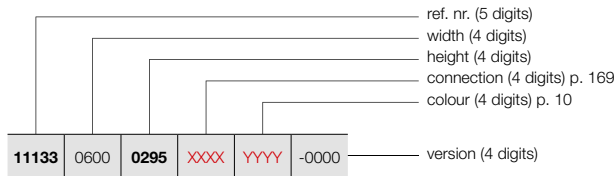

CPHN1-RO

PRICE GROUP: VPG2 - STEEL DESIGN RADIATORS

REFERENCE CODE CUSTOM MADE CARRÉ HORIZONTAL	TECHNICAL DATA									STANDARD COLOUR	OTHER COLOURS					
	tubes	width (L mm)	height (H mm)	75/65/20 (Watt) (φ50K)	55/45/20 (Watt) (φ30K)	n-exp.	weight (kg)	water content (l)	electr. resistance (Watt)	price RAL 9016 (€)	price colour (€)					
REF. NR. CARRÉ HORIZONTAL CPHN1-RO : 11133																
11133	0600	0295	XXXX	YYYY	-0000	10	600	295	221	117	1,25	6,19	2,85	-	231	266
		0355				12	600	355	259	137	1,25	7,41	3,60	-	280	322
		0415				14	600	415	296	156	1,25	8,63	4,35	-	324	373
		0475				16	600	475	333	176	1,25	9,86	5,10	-	373	429
		0535				18	600	535	369	195	1,25	11,08	5,85	-	419	482
		0595				20	600	595	404	213	1,25	12,30	6,60	-	464	534
		0655				22	600	655	439	231	1,26	13,42	6,94	-	512	589
		0775				26	600	775	507	266	1,26	15,67	7,63	-	604	695
		0895				30	600	895	574	302	1,26	17,91	8,31	-	697	802
11133	0800	0295	XXXX	YYYY	-0000	10	800	295	295	156	1,25	8,25	3,80	-	286	329
		0355				12	800	355	346	183	1,25	9,88	4,80	-	338	389
		0415				14	800	415	395	209	1,25	11,51	5,80	-	395	454
		0475				16	800	475	444	234	1,25	13,14	6,80	-	454	522
		0535				18	800	535	492	260	1,25	14,77	7,80	-	510	587
		0595				20	800	595	538	284	1,25	16,40	8,80	-	566	651
		0655				22	800	655	585	307	1,26	17,90	9,26	-	623	716
		0775				26	800	775	676	355	1,26	20,89	10,17	-	738	849
		0895				30	800	895	766	402	1,26	23,88	11,08	-	850	978
11133	1000	0295	XXXX	YYYY	-0000	10	1000	295	369	195	1,25	10,31	4,75	-	327	376
		0355				12	1000	355	432	228	1,25	12,35	6,00	-	395	454
		0415				14	1000	415	494	261	1,25	14,39	7,25	-	461	530
		0475				16	1000	475	555	293	1,25	16,43	8,50	-	529	608
		0535				18	1000	535	615	325	1,25	18,46	9,75	-	595	684
		0595				20	1000	595	673	355	1,25	20,50	11,00	-	661	760
		0655				22	1000	655	731	384	1,26	22,37	11,57	-	728	837
		0775				26	1000	775	845	444	1,26	26,11	12,71	-	858	987
		0895				30	1000	895	957	503	1,26	29,85	13,85	-	990	1139
11133	1200	0295	XXXX	YYYY	-0000	10	1200	295	443	234	1,25	12,37	5,70	-	374	430
		0355				12	1200	355	518	274	1,25	14,82	7,20	-	450	518
		0415				14	1200	415	593	313	1,25	17,27	8,70	-	524	603
		0475				16	1200	475	666	352	1,25	19,72	10,20	-	598	688
		0535				18	1200	535	738	390	1,25	22,15	11,70	-	674	775
		0595				20	1200	595	808	427	1,25	24,60	13,20	-	750	863
		0655				22	1200	655	877	461	1,26	26,84	13,88	-	823	946
		0775				26	1200	775	1014	533	1,26	31,33	15,25	-	974	1120
		0895				30	1200	895	1148	603	1,26	35,82	16,62	-	1121	1289
11133	1400	0295	XXXX	YYYY	-0000	10	1400	295	517	273	1,25	14,43	6,65	-	415	477
		0355				12	1400	355	605	319	1,25	17,29	8,40	-	498	573
		0415				14	1400	415	692	365	1,25	20,15	10,15	-	584	672
		0475				16	1400	475	777	410	1,25	23,00	11,90	-	666	766
		0535				18	1400	535	861	455	1,25	25,84	13,65	-	750	863
		0595				20	1400	595	942	497	1,25	28,70	15,40	-	832	957
		0655				22	1400	655	1023	537	1,26	31,32	16,20	-	916	1053
		0775				26	1400	775	1183	622	1,26	36,55	17,79	-	1081	1243
		0895				30	1400	895	1340	704	1,26	41,79	19,39	-	1245	1432

In conformity with EN442-1: 2014: radiators and convectors

For heat outputs in other regimes, see p. 320 (correction factors)
EXPORT. Prices in Euro (excl. VAT)

CARRÉ HORIZONTAL (CPHN1-RO)

HOW TO ORDER CARRÉ HORIZONTAL

Delivery time 15 - 30 working days
(transport duration not included)

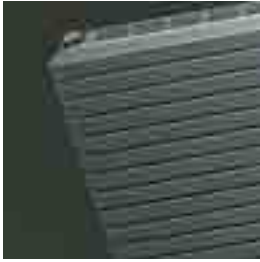

CPHN1-RO

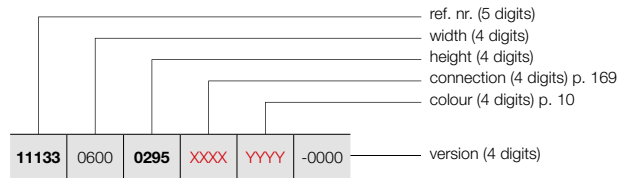

PRICE GROUP: VPG2 - STEEL DESIGN RADIATORS

REFERENCE CODE CUSTOM MADE CARRÉ HORIZONTAL							TECHNICAL DATA						STANDARD COLOUR	OTHER COLOURS		
REF. NR.	width (L mm)	height (H mm)	75/65/20 (Watt) (φ50K)	55/45/20 (Watt) (φ30K)	n-exp.	weight (kg)	water content (l)	electr. resistance (Watt)	price RAL 9016 (€)	price colour (€)						
REF. NR. CARRÉ HORIZONTAL CPHN1-RO : 11133																
11133	1600	0295	XXXX	YYYY	-0000	10	1600	295	590	312	1,25	16,50	7,60	-	456	524
						12	1600	355	691	365	1,25	19,76	9,60	-	544	626
						14	1600	415	790	417	1,25	23,02	11,60	-	637	733
						16	1600	475	888	469	1,25	26,29	13,60	-	730	840
						18	1600	535	984	520	1,25	29,54	15,60	-	821	944
						20	1600	595	1077	569	1,25	32,80	17,60	-	909	1045
						22	1600	655	1170	615	1,26	35,79	18,51	-	1001	1151
						26	1600	775	1352	710	1,26	41,78	20,34	-	1185	1363
						30	1600	895	1531	804	1,26	47,76	22,16	-	1367	1572
						11133	1800	0295	XXXX	YYYY	-0000	10	1800	295	664	351
12	1800	355	778	411	1,25							22,23	10,80	-	595	684
14	1800	415	889	469	1,25							25,90	13,05	-	691	795
16	1800	475	999	528	1,25							29,57	15,30	-	788	906
18	1800	535	1107	585	1,25							33,23	17,55	-	889	1022
20	1800	595	1211	639	1,25							36,90	19,80	-	989	1137
22	1800	655	1316	691	1,26							40,27	20,83	-	1084	1247
26	1800	775	1521	799	1,26							47,00	22,88	-	1284	1477
30	1800	895	1723	905	1,26							53,73	24,93	-	1483	1705
11133	2000	0295	XXXX	YYYY	-0000							10	2000	295	738	390
						12	2000	355	864	456	1,25	24,70	12,00	-	636	731
						14	2000	415	988	522	1,25	28,78	14,50	-	743	854
						16	2000	475	1110	586	1,25	32,86	17,00	-	850	978
						18	2000	535	1230	650	1,25	36,92	19,50	-	957	1101
						20	2000	595	1346	711	1,25	41,00	22,00	-	1062	1221
						22	2000	655	1462	768	1,26	44,74	23,14	-	1167	1342
						26	2000	775	1690	888	1,26	52,22	25,42	-	1380	1587
						30	2000	895	1914	1006	1,26	59,70	27,70	-	1593	1832
						11133	2200	0295	XXXX	YYYY	-0000	10	2200	295	812	429
12	2200	355	950	502	1,25							27,17	13,20	-	680	782
14	2200	415	1087	574	1,25							31,66	15,95	-	791	910
16	2200	475	1221	645	1,25							36,15	18,70	-	905	1041
18	2200	535	1353	714	1,25							40,61	21,45	-	1020	1173
20	2200	595	1481	782	1,25							45,10	24,20	-	1134	1304
22	2200	655	1608	845	1,26							49,21	25,45	-	1245	1432
26	2200	775	1859	977	1,26							57,44	27,96	-	1472	1693
30	2200	895	2105	1106	1,26							65,67	30,47	-	1700	1955
11133	2400	0295	XXXX	YYYY	-0000							10	2400	295	886	468
						12	2400	355	1037	548	1,25	29,64	14,40	-	720	828
						14	2400	415	1186	626	1,25	34,54	17,40	-	842	968
						16	2400	475	1332	703	1,25	39,43	20,40	-	961	1105
						18	2400	535	1476	779	1,25	44,30	23,40	-	1082	1244
						20	2400	595	1615	853	1,25	49,20	26,40	-	1204	1385
						22	2400	655	1754	922	1,26	53,69	27,77	-	1323	1521
						26	2400	775	2028	1065	1,26	62,66	30,50	-	1564	1799
						30	2400	895	2297	1207	1,26	71,64	33,24	-	1804	2075

In conformity with EN442-1: 2014: radiators and convectors

For heat outputs in other regimes, see p. 320 (correction factors)
EXPORT. Prices in Euro (excl. VAT)

HOW TO ORDER CARRÉ HORIZONTAL

Delivery time 15 - 30 working days
(transport duration not included)

CARRÉ HORIZONTAL (CPHN1-RO)

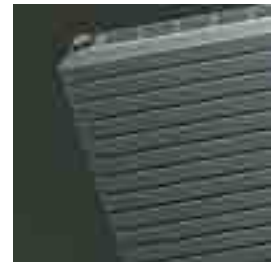
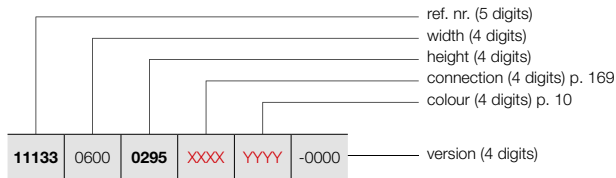

CPHN1-RO

PRICE GROUP: VPG2 - STEEL DESIGN RADIATORS

REFERENCE CODE CUSTOM MADE CARRÉ HORIZONTAL	TECHNICAL DATA									STANDARD COLOUR	OTHER COLOURS					
	tubes	width (L mm)	height (H mm)	75/65/20 (Watt) (φ50K)	55/45/20 (Watt) (φ30K)	n-exp.	weight (kg)	water content (l)	electr. resistance (Watt)	price RAL 9016 (€)	price colour (€)					
REF. NR. CARRÉ HORIZONTAL CPHN1-RO : 11133																
11133	2600	0295	XXXX	YYYY	-0000	10	2600	295	959	506	1,25	26,81	12,35	-	635	730
		0355				12	2600	355	1123	593	1,25	32,11	15,60	-	761	875
		0415				14	2600	415	1284	678	1,25	37,41	18,85	-	889	1022
		0475				16	2600	475	1443	762	1,25	42,72	22,10	-	1015	1167
		0535				18	2600	535	1599	844	1,25	48,00	25,35	-	1146	1318
		0595				20	2600	595	1750	924	1,25	53,30	28,60	-	1271	1462
		0655				22	2600	655	1901	999	1,26	58,16	30,08	-	1399	1609
		0775				26	2600	775	2197	1154	1,26	67,89	33,05	-	1651	1899
		0895				30	2600	895	2488	1307	1,26	77,61	36,01	-	1907	2193
11133	2800	0295	XXXX	YYYY	-0000	10	2800	295	1033	545	1,25	28,87	13,30	-	670	771
		0355				12	2800	355	1210	639	1,25	34,58	16,80	-	802	922
		0415				14	2800	415	1383	730	1,25	40,29	20,30	-	933	1073
		0475				16	2800	475	1554	821	1,25	46,00	23,80	-	1070	1231
		0535				18	2800	535	1722	909	1,25	51,69	27,30	-	1204	1385
		0595				20	2800	595	1884	995	1,25	57,40	30,80	-	1337	1538
		0655				22	2800	655	2047	1075	1,26	62,64	32,40	-	1471	1692
		0775				26	2800	775	2366	1243	1,26	73,11	35,59	-	1738	1999
		0895				30	2800	895	2680	1408	1,26	83,58	38,78	-	2007	2308
11133	3000	0295	XXXX	YYYY	-0000	10	3000	295	1107	585	1,25	30,93	14,25	-	702	807
		0355				12	3000	355	1296	684	1,25	37,05	18,00	-	841	967
		0415				14	3000	415	1482	783	1,25	43,17	21,75	-	982	1129
		0475				16	3000	475	1665	879	1,25	49,29	25,50	-	1121	1289
		0535				18	3000	535	1845	974	1,25	55,38	29,25	-	1264	1454
		0595				20	3000	595	2019	1066	1,25	61,50	33,00	-	1401	1611
		0655				22	3000	655	2193	1152	1,26	67,11	34,71	-	1542	1773
		0775				26	3000	775	2535	1332	1,26	78,33	38,13	-	1823	2096
		0895				30	3000	895	2871	1508	1,26	89,55	41,55	-	2105	2421

In conformity with EN442-1: 2014: radiators and convectors

For heat outputs in other regimes, see p. 320 (correction factors)
EXPORT. Prices in Euro (excl. VAT)



CARRÉ HORIZONTAL (CPHN2-RO)

HOW TO ORDER CARRÉ HORIZONTAL

Delivery time 15 - 30 working days
(transport duration not included)

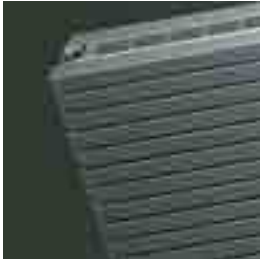

CPHN2-RO

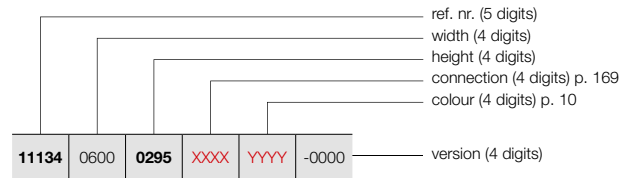

PRICE GROUP: VPG2 - STEEL DESIGN RADIATORS

REFERENCE CODE CUSTOM MADE CARRÉ HORIZONTAL							TECHNICAL DATA						STANDARD COLOUR	OTHER COLOURS		
tubes	width (L mm)	height (H mm)	75/65/20 (Watt) (φ50K)	55/45/20 (Watt) (φ30K)	n-exp.	weight (kg)	water content (l)	electr. resistance (Watt)	price RAL 9016 (€)	price colour (€)						
REF. NR. CARRÉ HORIZONTAL CPHN2-RO : 11134																
11134	0600	0295	XXXX	YYYY	-0000	10	600	295	377	200	1,24	11,94	6,06	-	455	523
		0355				12	600	355	459	242	1,25	14,26	7,27	-	542	623
		0415				14	600	415	539	282	1,27	16,57	8,48	-	635	730
		0475				16	600	475	617	321	1,28	18,89	9,70	-	726	835
		0535				18	600	535	693	359	1,29	21,20	10,91	-	818	941
		0595				20	600	595	766	394	1,30	23,52	12,12	-	905	1041
		0655				22	600	655	836	430	1,30	25,85	13,39	-	997	1147
		0775				26	600	775	967	498	1,30	30,50	15,94	-	1179	1356
		0895				30	600	895	1087	560	1,30	35,16	18,48	-	1362	1566
		11134				0800	0295	XXXX	YYYY	-0000	10	800	295	503	267	1,24
0355	12		800	355	612		323				1,25	19,01	9,70	-	664	764
0415	14		800	415	719		376				1,27	22,10	11,31	-	773	889
0475	16		800	475	823		428				1,28	25,18	12,93	-	883	1015
0535	18		800	535	924		478				1,29	28,27	14,54	-	995	1144
0595	20		800	595	1021		526				1,30	31,36	16,16	-	1106	1272
0655	22		800	655	1114		573				1,30	34,46	17,86	-	1215	1397
0775	26		800	775	1290		664				1,30	40,67	21,25	-	1435	1650
0895	30		800	895	1449		746				1,30	46,88	24,64	-	1656	1904
11134	1000		0295	XXXX	YYYY		-0000				10	1000	295	629	334	1,24
		0355	12			1000		355	765	404	1,25	23,76	12,12	-	773	889
		0415	14			1000		415	899	470	1,27	27,62	14,14	-	901	1036
		0475	16			1000		475	1029	535	1,28	31,48	16,16	-	1030	1185
		0535	18			1000		535	1155	598	1,29	35,34	18,18	-	1156	1329
		0595	20			1000		595	1276	657	1,30	39,20	20,20	-	1288	1481
		0655	22			1000		655	1393	717	1,30	43,08	22,32	-	1418	1631
		0775	26			1000		775	1612	830	1,30	50,84	26,56	-	1674	1925
		0895	30			1000		895	1811	932	1,30	58,60	30,80	-	1930	2220
		11134	1200			0295		XXXX	YYYY	-0000	10	1200	295	755	401	1,24
0355	12			1200	355	918	485				1,25	28,51	14,54	-	879	1011
0415	14			1200	415	1079	564				1,27	33,14	16,97	-	1020	1173
0475	16			1200	475	1235	642				1,28	37,78	19,39	-	1166	1341
0535	18			1200	535	1386	717				1,29	42,41	21,82	-	1313	1510
0595	20			1200	595	1531	788				1,30	47,04	24,24	-	1459	1678
0655	22			1200	655	1672	861				1,30	51,70	26,78	-	1602	1842
0775	26			1200	775	1934	996				1,30	61,01	31,87	-	1899	2184
0895	30			1200	895	2173	1119				1,30	70,32	36,96	-	2187	2515
11134	1400			0295	XXXX	YYYY	-0000				10	1400	295	881	468	1,24
		0355	12	1400				355	1071	566	1,25	33,26	16,97	-	974	1120
		0415	14	1400				415	1259	658	1,27	38,67	19,80	-	1136	1306
		0475	16	1400				475	1441	749	1,28	44,07	22,62	-	1297	1492
		0535	18	1400				535	1617	837	1,29	49,48	25,45	-	1459	1678
		0595	20	1400				595	1786	919	1,30	54,88	28,28	-	1621	1864
		0655	22	1400				655	1950	1004	1,30	60,31	31,25	-	1783	2050
		0775	26	1400				775	2257	1162	1,30	71,18	37,18	-	2109	2425
		0895	30	1400				895	2535	1305	1,30	82,04	43,12	-	2430	2795

In conformity with EN442-1: 2014: radiators and convectors

For heat outputs in other regimes, see p. 320 (correction factors)
EXPORT. Prices in Euro (excl. VAT)

HOW TO ORDER CARRÉ HORIZONTAL

Delivery time 15 - 30 working days
(transport duration not included)

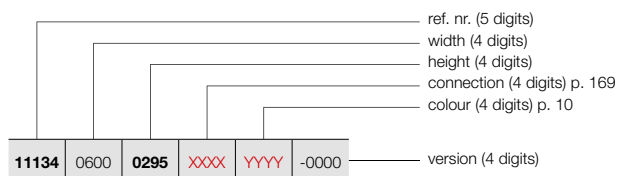

CARRÉ HORIZONTAL (CPHN2-RO)



CPHN2-RO

PRICE GROUP: VPG2 - STEEL DESIGN RADIATORS

REFERENCE CODE CUSTOM MADE CARRÉ HORIZONTAL	TECHNICAL DATA									STANDARD COLOUR	OTHER COLOURS					
	tubes	width (L mm)	height (H mm)	75/65/20 (Watt) (φ50K)	55/45/20 (Watt) (φ30K)	n-exp.	weight (kg)	water content (l)	electr. resistance (Watt)	price RAL 9016 (€)	price colour (€)					
REF. NR. CARRÉ HORIZONTAL CPHN2-RO : 11134																
11134	1600	0295	XXXX	YYYY	-0000	10	1600	295	1006	534	1,24	31,84	16,16	-	888	1021
						12	1600	355	1224	646	1,25	38,02	19,39	-	1066	1226
						14	1600	415	1438	752	1,27	44,19	22,62	-	1243	1429
						16	1600	475	1646	856	1,28	50,37	25,86	-	1422	1635
						18	1600	535	1848	956	1,29	56,54	29,09	-	1598	1838
						20	1600	595	2042	1051	1,30	62,72	32,32	-	1778	2045
						22	1600	655	2229	1147	1,30	68,93	35,71	-	1955	2248
						26	1600	775	2579	1328	1,30	81,34	42,50	-	2310	2657
						30	1600	895	2898	1492	1,30	93,76	49,28	-	2663	3062
11134	1800	0295	XXXX	YYYY	-0000	10	1800	295	1132	601	1,24	35,82	18,18	-	962	1106
						12	1800	355	1377	727	1,25	42,77	21,82	-	1156	1329
						14	1800	415	1618	846	1,27	49,72	25,45	-	1347	1549
						16	1800	475	1852	963	1,28	56,66	29,09	-	1541	1772
						18	1800	535	2079	1076	1,29	63,61	32,72	-	1732	1992
						20	1800	595	2297	1182	1,30	70,56	36,36	-	1928	2217
						22	1800	655	2507	1290	1,30	77,54	40,18	-	2116	2433
						26	1800	775	2902	1494	1,30	91,51	47,81	-	2505	2881
						30	1800	895	3260	1678	1,30	105,48	55,44	-	2888	3321
11134	2000	0295	XXXX	YYYY	-0000	10	2000	295	1258	668	1,24	39,80	20,20	-	1036	1191
						12	2000	355	1530	808	1,25	47,52	24,24	-	1240	1426
						14	2000	415	1798	940	1,27	55,24	28,28	-	1452	1670
						16	2000	475	2058	1070	1,28	62,96	32,32	-	1656	1904
						18	2000	535	2310	1195	1,29	70,68	36,36	-	1864	2144
						20	2000	595	2552	1314	1,30	78,40	40,40	-	2071	2382
						22	2000	655	2786	1434	1,30	86,16	44,64	-	2278	2620
						26	2000	775	3224	1660	1,30	101,68	53,12	-	2688	3091
						30	2000	895	3622	1864	1,30	117,20	61,60	-	3106	3572
11134	2200	0295	XXXX	YYYY	-0000	10	2200	295	1384	735	1,24	43,78	22,22	-	1106	1272
						12	2200	355	1683	889	1,25	52,27	26,66	-	1326	1525
						14	2200	415	1978	1034	1,27	60,76	31,11	-	1547	1779
						16	2200	475	2264	1177	1,28	69,26	35,55	-	1765	2030
						18	2200	535	2541	1315	1,29	77,75	40,00	-	1988	2286
						20	2200	595	2807	1445	1,30	86,24	44,44	-	2211	2543
						22	2200	655	3065	1578	1,30	94,78	49,10	-	2430	2795
						26	2200	775	3546	1825	1,30	111,85	58,43	-	2871	3302
						30	2200	895	3984	2051	1,30	128,92	67,76	-	3316	3813
11134	2400	0295	XXXX	YYYY	-0000	10	2400	295	1510	801	1,24	47,76	24,24	-	1171	1347
						12	2400	355	1836	970	1,25	57,02	29,09	-	1409	1620
						14	2400	415	2158	1128	1,27	66,29	33,94	-	1645	1892
						16	2400	475	2470	1284	1,28	75,55	38,78	-	1876	2157
						18	2400	535	2772	1434	1,29	84,82	43,63	-	2111	2428
						20	2400	595	3062	1576	1,30	94,08	48,48	-	2347	2699
						22	2400	655	3343	1721	1,30	103,39	53,57	-	2578	2965
						26	2400	775	3869	1992	1,30	122,02	63,74	-	3050	3508

In conformity with EN442-1: 2014: radiators and convectors

For heat outputs in other regimes, see p. 320 (correction factors)
EXPORT. Prices in Euro (excl. VAT)

VASCO

CARRÉ HORIZONTAL (CPHN2-RO)



CPHN2-RO

HOW TO ORDER CARRÉ HORIZONTAL

Delivery time 15 - 30 working days
(transport duration not included)

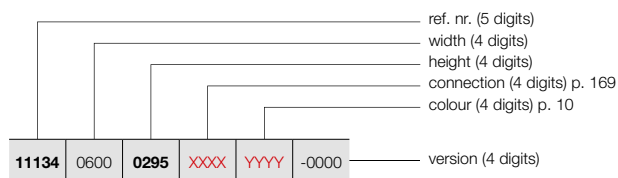

PRICE GROUP: VPG2 - STEEL DESIGN RADIATORS

REFERENCE CODE CUSTOM MADE CARRÉ HORIZONTAL							TECHNICAL DATA					STANDARD COLOUR	OTHER COLOURS			
tubes	width (L mm)	height (H mm)	75/65/20 (Watt) (φ50K)	55/45/20 (Watt) (φ30K)	n-exp.	weight (kg)	water content (l)	electr. resistance (Watt)	price RAL 9016 (€)	price colour (€)						
REF. NR. CARRÉ HORIZONTAL CPHN2-RO : 11134																
11134	2600	0295	XXXX	YYYY	-0000	10	2600	295	1635	868	1,24	51,74	26,26	-	1239	1425
						12	2600	355	1989	1050	1,25	61,78	31,51	-	1487	1710
						14	2600	415	2337	1222	1,27	71,81	36,76	-	1732	1992
						16	2600	475	2675	1391	1,28	81,85	42,02	-	1981	2278
						18	2600	535	3003	1554	1,29	91,88	47,27	-	2230	2565
						20	2600	595	3318	1708	1,30	101,92	52,52	-	2480	2852
						22	2600	655	3622	1864	1,30	112,01	58,03	-	2726	3135
						26	2600	775	4191	2157	1,30	132,18	69,06	-	3223	3706
11134	2800	0295	XXXX	YYYY	-0000	10	2800	295	1761	935	1,24	55,72	28,28	-	1302	1497
						12	2800	355	2142	1131	1,25	66,53	33,94	-	1564	1799
						14	2800	415	2517	1316	1,27	77,34	39,59	-	1825	2099
						16	2800	475	2881	1498	1,28	88,14	45,25	-	2084	2397
						18	2800	535	3234	1673	1,29	98,95	50,90	-	2347	2699
						20	2800	595	3573	1839	1,30	109,76	56,56	-	2607	2998
						22	2800	655	3900	2008	1,30	120,62	62,50	-	2870	3301
						11134	3000	0295	XXXX	YYYY	-0000	10	3000	295	1887	1002
12	3000	355	2295	1212	1,25							71,28	36,36	-	1642	1888
14	3000	415	2697	1410	1,27							82,86	42,42	-	1913	2200
16	3000	475	3087	1605	1,28							94,44	48,48	-	2187	2515
18	3000	535	3465	1793	1,29							106,02	54,54	-	2460	2829
20	3000	595	3828	1970	1,30							117,60	60,60	-	2731	3141
22	3000	655	4179	2151	1,30							129,24	66,96	-	3008	3459





In conformity with EN442-1: 2014: radiators and convectors

For heat outputs in other regimes, see p. 320 (correction factors)
EXPORT. Prices in Euro (excl. VAT)

PRICE GROUP: VPG10 - ACC.

BRACKETS	HEIGHT / WIDTH RADIATOR	COLOUR	REF. NR.	€
CPVN2-ZB / CPHN1-RO / CPHN2-RO				
WALL SETUP	≤ 2400 mm (4 brackets)	RAL 7016	1187 007 0000 7016	41
	≥ 2600 mm (6 brackets)	RAL 7016	1187 008 0000 7016	64

EXPORT. Prices in Euro (excl. VAT)

ACCESSORIES	WIDTH RADIATOR	COLOUR	REF. NR.	€
CPVN-PLUS / CPVN2-ZB / CPHN1-RO / CPHN2-RO				
SQUARE HOOK 		CHROME	1183 500 0000 0099	68
<ul style="list-style-type: none"> h = 24 mm; b = 24 mm; d = 65 mm 				
CPVN-PLUS / CPVN2-ZB / CPHN1-RO / CPHN2-RO				
TOWEL RAIL STRAIGHT 		CHROME	1183 207 0000 0099	187
<ul style="list-style-type: none"> h = 24 mm; b = 720 mm (easy adjustable); d = 66 mm; a = 48 mm 				
CPVN-PLUS / CPVN2-ZB				
TOWEL RAIL MULTI+ RIGHT 	600 mm	S600	1183 734 0000 0600	204
	600 mm	RAL 9005 ^S	1183 734 0000 9005	204
<ul style="list-style-type: none"> h = 70 mm; b = 600 mm (b tablet = 194 mm); e = 176 mm; c = 170 mm; Mounting on the wall, to the right of the radiator. 				
CPVN-PLUS / CPVN2-ZB				
TOWEL RAIL MULTI+ LEFT 	600 mm	S600	1183 735 0000 0600	204
	600 mm	RAL 9005 ^S	1183 735 0000 9005	204
<ul style="list-style-type: none"> h = 70 mm; b = 600 mm (b tablet = 194 mm); e = 176 mm; c = 170 mm; Mounting on the wall, to the left of the radiator. 				

^S structure black

Mounting instructions accessories: see www.vasco.eu
EXPORT. Prices in Euro (excl. VAT)

e = distance front of the accessory up to the wall
d = distance front of the accessory up to front of the radiator
c = distance between wall to back towel bar
a = distance accessory up to the radiator
available from stock

CARRÉ PLUS VERTICAL: CPVN-PLUS (STOCK)
CARRÉ VERTICAL: CPVN2-ZB

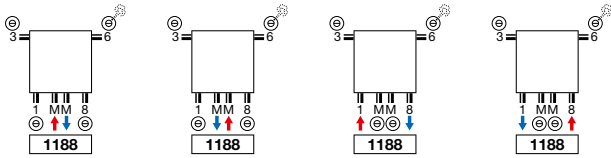

CARRÉ PLUS VERTICAL: CPVN-PLUS (NON STOCK)
CARRÉ VERTICAL: CPVN2-ZB

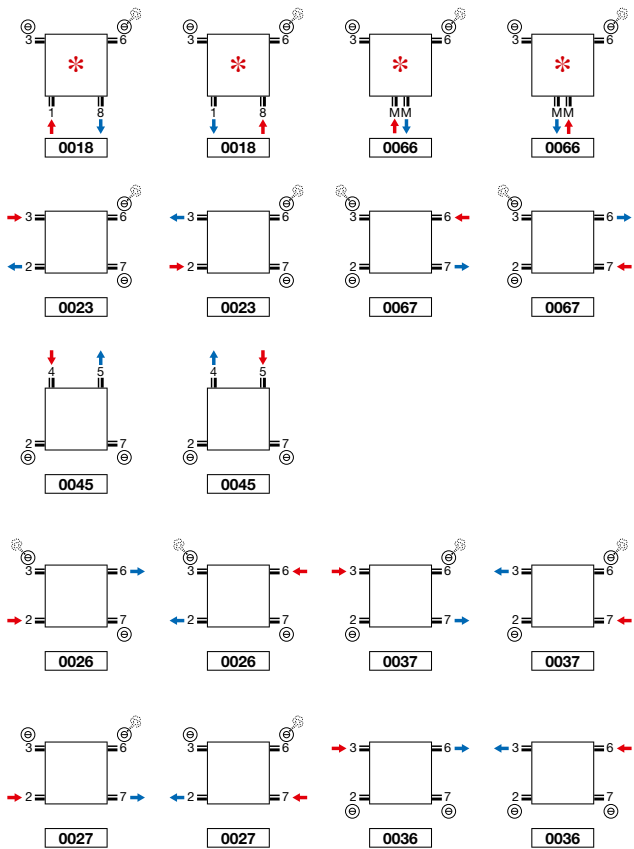

* Attention CPVN-PLUS/CPVN2-ZB 10 tubes: 2/3/6/7 always open.

CARRÉ HORIZONTAL: CPHN1-RO / CPHN2-RO

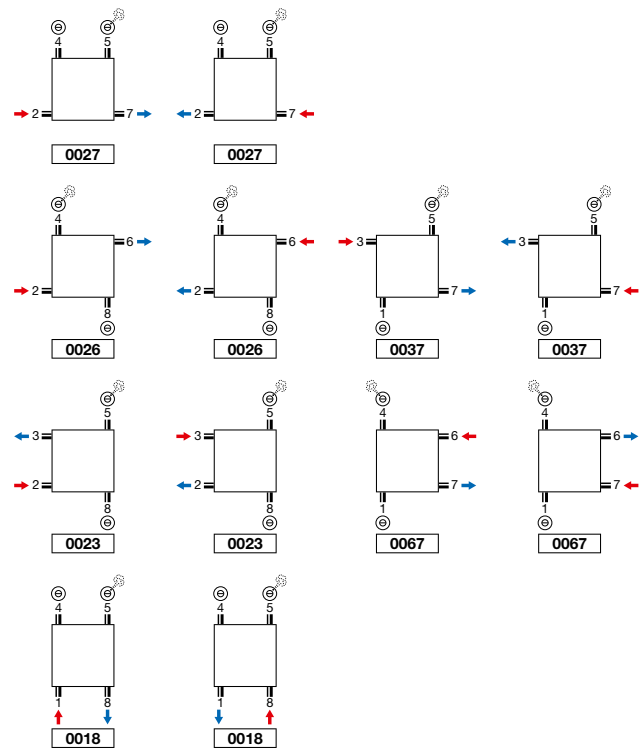

Attention: connecting the radiator can only be as shown by the connecting icons. For any other connection method, we take no responsibility.

CARRÉ PLUS VERTICAL (CPVN-PLUS)

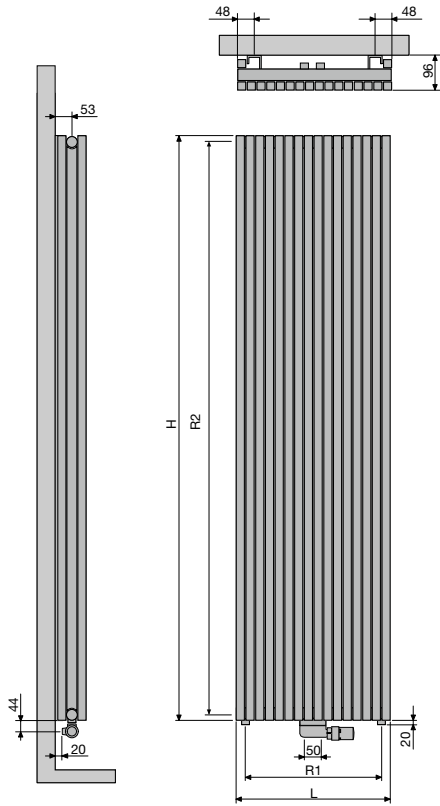

CPVN-PLUS

number of tubes	10	12	14	16	18	20	22	26	30
Width (L)	295	355	415	475	535	595	655	775	895
Centre between the connections at the bottom 18 (R1)	240	300	360	420	480	540	600	720	840
height (H)	1400	1600	1800	2000	2200				
Centre between the lateral connections 23/67 (R2)	1365	1565	1765	1965	2165				
Centre between the brackets	L-200	H-290							

CARRÉ VERTICAL (CPVN2-ZB)

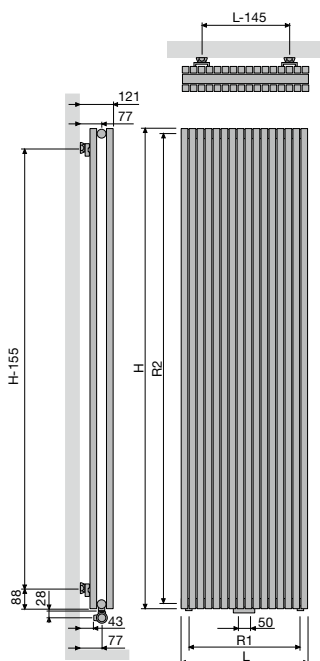

CPVN2-ZB

number of tubes	10	12	14	16	18	20	22	26	30
Width (L)	295	355	415	475	535	595	655	775	895
Centre between the connections at the bottom 18 (R1)	240	300	360	420	480	540	600	720	840
height (H)	1400	1600	1800	2000	2200	2400	2600	2800	3000
Centre between the lateral connections 23/67 (R2)	1365	1565	1765	1965	2165	2365	2565	2765	2965
Centre between the brackets	L-145	H-155							

CARRÉ HORIZONTAL (CPHN1-RO, CPHN2-RO)

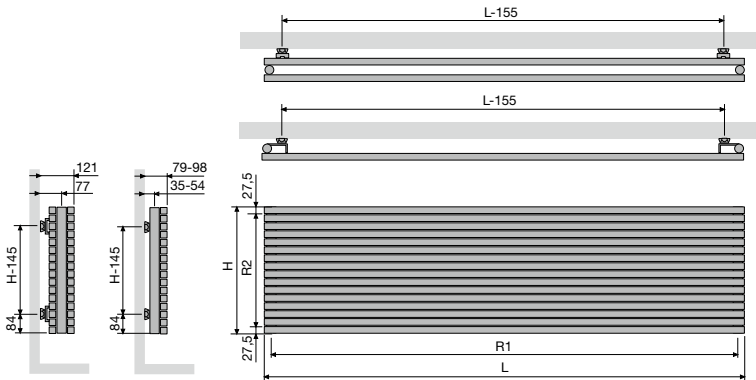

CPHN1-RO / CPHN2-RO

	600	800	1000	1200	1400	1600	1800	2000	2200	2400	2600	2800	3000
Width (L)	600	800	1000	1200	1400	1600	1800	2000	2200	2400	2600	2800	3000
Centre between the connections at the bottom 18 (R1)	565	765	965	1165	1365	1565	1765	1965	2165	2365	2565	2765	2965
height (H)	295	355	415	475	535	595	655	715	775	835	895		
Centre between the lateral connections 23/67 (R2)	240	300	360	420	480	540	600	660	720	780	840		
Centre between the brackets	L-155	H-145											

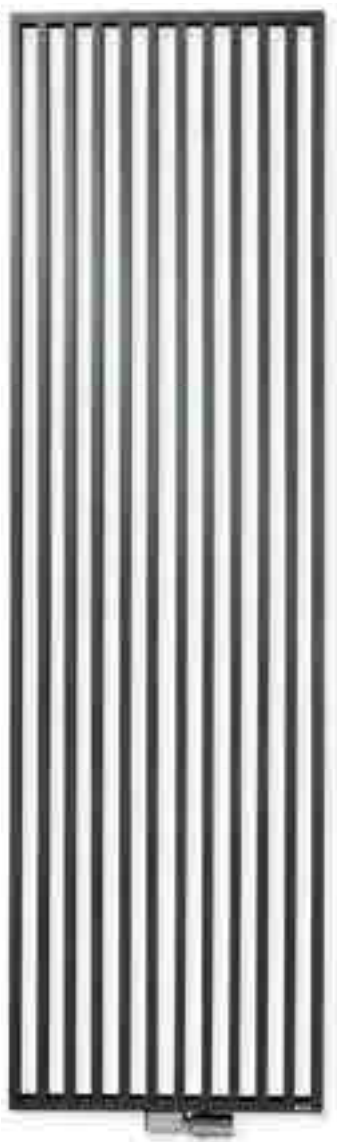

VASCO

TUBES

- Wv: Vertical, rectangular 45 x 20 mm

COLOURS

- Standard colour white RAL 9016
- Extensive colour chart see p. 10

SPECIAL

- The Arche is awarded with the Design Plus Award 2005, Reddot Design Award 2006, Silver Award Designpreis Deutschland 2006 and nominated for the Henry van de Velde prize 2005.

BRACKETS

- Wall brackets standard (telescopic)

TECHNICAL

- KTL priming coat, powder coating
- Standard operating pressure: 4 bar
- Maximum operating temperature: 110°C

ELECTRICAL

- ✗ Pure electrical radiator prefilled
- ✗ Mixed radiator

TECHNICAL DRAWINGS

- See p. 178

CONNECTION

- ✗ One-point connection for one-pipe system
- ✗ One-point connection for two-pipe system
- ✓ Two-point connection for one-pipe system (connection by way of the central connection) (see p. 312)
- ✓ Two-point connection for two-pipe system (standard) (see p. 312)
- ✗ Integrated valve
- Connections: 1/2" (inner thread)

ARCHE VERTICAL

Technology and aesthetics seamlessly united

A designer radiator concept, unique in its kind. The tubes are not mounted on top of each other but rather into each other and together for one seamless, flat structure. The accessories are also nicely integrated into the whole. The perfect relationship between technology and aesthetics provide a unique product that has since won almost all major design prizes, and is also available in a bathroom design with a centre connection.

RECOMMENDED CONNECTION (1188)

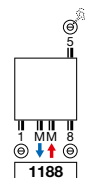

Other connection methods, see p. 177

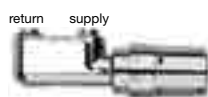

ref. nr. 1182 103 0000 0099
price € 218
 Fittings, see p. 327

RECOMMENDED FOR BATHROOM AND KITCHEN IN OPTION



towel rail (chrome)
 ref. nr. see p. 176
price € 187

Other accessories, see p. 176



HOW TO ORDER ARCHE VERTICAL

Delivery time 15 - 30 working days
(transport duration not included)

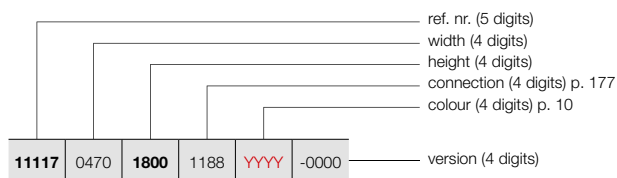

ARCHE VERTICAL (VV)



VV

HOW TO ORDER STOCK RADIATOR ARCHE VERTICAL

Delivery time 5 working days
(transport duration not included)

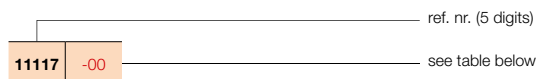

PRICE GROUP: VPG2 - STEEL DESIGN RADIATORS

REFERENCE CODE CUSTOM MADE ARCHE VERTICAL	TECHNICAL DATA									STANDARD COLOUR		OTHER COLOURS					
	tubes	width (L mm)	height (H mm)	75/65/20 (Watt (φ50K))	55/45/20 (Watt (φ30K))	n-exp.	weight (kg)	water content (l)	electr. resistance (Watt)	price RAL 9016 (€)	short ref. nr. RAL 9016 stock	price colour (€)					
REF. NR. ARCHE VERTICAL VV : 11117																	
11117	0470	1800	1188	YYY	-0000	10	470	1800	1050	560	1,23	22,90	13,94	-	541	11117-03	622
		2000				10	470	2000	1164	618	1,24	25,36	15,42	-	582	-	669
		2200				10	470	2200	1279	679	1,24	27,81	16,91	-	609	-	700
11117	0570	1800	1188	YYY	-0000	12	570	1800	1273	679	1,23	27,78	16,90	-	660	-	759
		2000				12	570	2000	1412	749	1,24	30,76	18,70	-	704	-	810
		2200				12	570	2200	1552	824	1,24	33,73	20,50	-	742	-	853
11117	0670	1800	1188	YYY	-0000	14	670	1800	1496	798	1,23	32,65	19,87	-	774	-	890
		2000				14	670	2000	1660	881	1,24	36,15	21,98	-	828	-	952
		2200				14	670	2200	1824	968	1,24	39,65	24,10	-	870	-	1001

In conformity with EN442-1: 2014: radiators and convectors

For heat outputs in other regimes, see p. 320 (correction factors)
EXPORT. Prices in Euro (excl. VAT)

ARCHE PLUS VERTICAL (VWL, VWR)



TYPES

- VWR (towel bar right), VWL (towel bar left)

TUBES

- Vertical, rectangular 45 x 20 mm

COLOURS

- Standard colour white RAL 9016
- Extensive colour chart see p. 10

SPECIAL

- Fixed towel bar, finished with the same powder coating as the radiator
- Attention: this towel bar does not heat!

BRACKETS

- Wall brackets standard (telescopic)

TECHNICAL

- KTL priming coat, powder coating
- Standard operating pressure: 4 bar
- Maximum operating temperature: 110°C

ELECTRICAL

- ✗ Pure electrical radiator prefilled
- ✗ Mixed radiator

TECHNICAL DRAWINGS

- See p. 178

CONNECTION

- ✗ One-point connection for one-pipe system
- ✗ One-point connection for two-pipe system
- ✓ Two-point connection for one-pipe system (connection by way of the central connection) (see p. 312)
- ✓ Two-point connection for two-pipe system (standard) (see p. 312)
- ✗ Integrated valve
- Connections: 1/2" (inner thread)

ARCHE PLUS VERTICAL

Functional beauty across the board

A designer radiator with the unique, flat design of the Arche complemented by a seamlessly welded-on towel rail. Together they form a beautiful whole, accentuated by the perfect relation between the Arche's design and its functionality.

RECOMMENDED CONNECTION (1188)

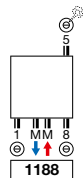

Other connection methods, see p. 177

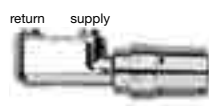

ref. nr. 1182 103 0000 0099

price € 218

Fittings, see p. 327



HOW TO ORDER ARCHE PLUS VERTICAL

Delivery time 15 - 30 working days
(transport duration not included)

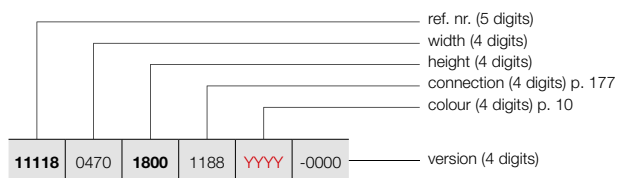

ARCHE PLUS VERTICAL (VL, VWR)



VVL

VWR

HOW TO ORDER STOCK RADIATOR ARCHE PLUS VERTICAL

Delivery time 5 working days
(transport duration not included)

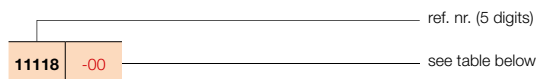

PRICE GROUP: VPG2 - STEEL DESIGN RADIATORS



REFERENCE CODE CUSTOM MADE ARCHE PLUS VERTICAL	TECHNICAL DATA									STANDARD COLOUR		OTHER COLOURS					
	tubes	width (L mm)	height (H mm)	75/65/20 (Watt) (φ50K)	55/45/20 (Watt) (φ30K)	n-exp.	weight (kg)	water content (l)	electr. resistance (Watt)	price RAL 9016 (€)	short ref. nr. RAL 9016 stock	price colour (€)					
REF. NR. ARCHE PLUS VERTICAL VL : 11118																	
11118	0470	1800	1188	YYYY	-0000	10	470	1800	1050	560	1,23	23,49	13,94	-	726	11118-01	835
		2000				10	470	2000	1164	618	1,24	25,95	15,42	-	775	-	891
		2200				10	470	2200	1279	679	1,24	28,40	16,91	-	816	-	938
11118	0570	1800	1188	YYYY	-0000	12	570	1800	1273	679	1,23	28,44	16,90	-	880	-	1012
		2000				12	570	2000	1412	749	1,24	31,42	18,70	-	937	-	1078
		2200				12	570	2200	1552	824	1,24	34,40	20,50	-	990	-	1139
11118	0670	1800	1188	YYYY	-0000	14	670	1800	1496	798	1,23	33,39	19,87	-	1031	-	1186
		2000				14	670	2000	1660	881	1,24	36,89	21,98	-	1105	-	1271
		2200				14	670	2200	1824	968	1,24	40,39	24,10	-	1161	-	1335
REF. NR. ARCHE PLUS VERTICAL VWR : 11119																	
11119	0470	1800	1188	YYYY	-0000	10	470	1800	1050	560	1,23	23,49	13,94	-	726	11119-01	835
		2000				10	470	2000	1164	618	1,24	25,95	15,42	-	775	-	891
		2200				10	470	2200	1279	679	1,24	28,40	16,91	-	816	-	938
11119	0570	1800	1188	YYYY	-0000	12	570	1800	1273	679	1,23	28,44	16,90	-	880	-	1012
		2000				12	570	2000	1412	749	1,24	31,42	18,70	-	937	-	1078
		2200				12	570	2200	1552	824	1,24	34,40	20,50	-	990	-	1139
11119	0670	1800	1188	YYYY	-0000	14	670	1800	1496	798	1,23	33,39	19,87	-	1031	-	1186
		2000				14	670	2000	1660	881	1,24	36,89	21,98	-	1105	-	1271
		2200				14	670	2200	1824	968	1,24	40,39	24,10	-	1161	-	1335

In conformity with EN442-1: 2014: radiators and convectors

For heat outputs in other regimes, see p. 320 (correction factors)
EXPORT. Prices in Euro (excl. VAT)

ARCHE ACCESSORIES
IN OPTION

PRICE GROUP: VPG10B - TOWEL RAILS

ACCESSORIES		COLOUR	REF. NR.	€
HOOK		WV / VWL / WVR		
		CHROME	118341000000099	87
		W		
TOWEL RAIL		CHROME	118322800000099	187

- h = 70 mm; b = 70 mm; d = 59 mm; a = 51 mm;

- h = 22 mm; b = 720 mm (easy adjustable) d = 75 mm; a = 56 mm

Mounting instructions accessories: see www.vasco.eu
EXPORT. Prices in Euro (excl. VAT)

d = distance front of the accessory up to front of the radiator
a = distance accessory up to the radiator
available from stock

ARCHE VERTICAL: W
 ARCHE PLUS VERTICAL: WL / WR

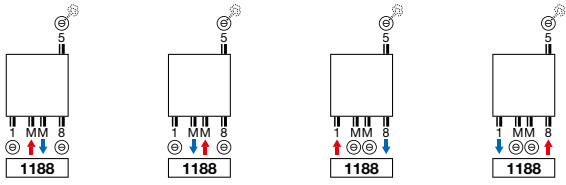

Attention: connecting the radiator can only be as shown by the connecting icons. For any other connection method, we take no responsibility.

ARCHE VERTICAL (VV)

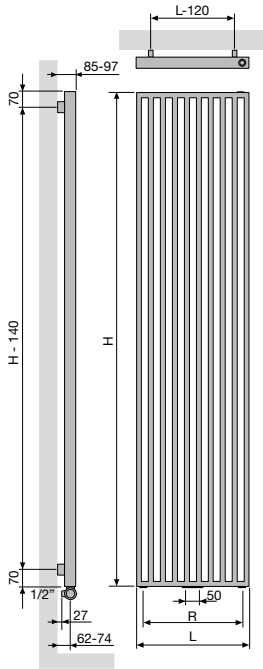

	VV		
number of tubes	10	12	14
Width (L)	470	570	670
Centre between the connections at the bottom 18 (R)	370	470	570
Centre between the brackets	L-120	H-140	

VASCO

ARCHE PLUS VERTICAL (VWL, VWR)

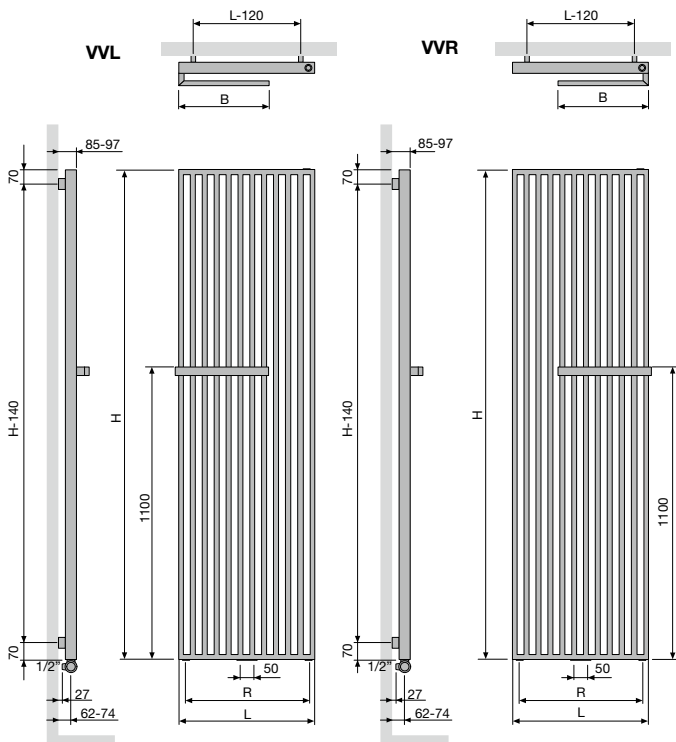

	VWL / VWR		
number of tubes	10	12	14
Width (L)	470	570	670
Centre between the connections at the bottom 18 (R)	370	470	570
Width towel rail (B)	335	385	435
Centre between the brackets	L-120	H-140	

TYPES

- One (ZV-1) or two rows (ZV-2)

TUBES

- Vertical, rectangular 45 x 20 mm

COLLECTORS

- Horizontal, rear, round Ø 35 mm

COLOURS

- Standard colour white RAL 9016
- Extensive colour chart see p. 10

BRACKETS

- Wall brackets standard

TECHNICAL

- Electrically laser welded (invisible weld seams)
- KTL priming coat, powder coating
- Standard operating pressure: 4 bar
- Maximum operating temperature: 110°C

ELECTRICAL

- ✗ Pure electrical radiator prefilled
- ✗ Mixed radiator

TECHNICAL DRAWINGS

- See p. 191

CONNECTION

- ✗ One-point connection for one-pipe system
- ✗ One-point connection for two-pipe system
- ✓ Two-point connection for one-pipe system (connection by way of the central connection) (see p. 312)
- ✓ Two-point connection for two-pipe system (standard) (see p. 312)
- ✗ Integrated valve
- Connections: ½" (inner thread)



VASCO

RECOMMENDED CONNECTION (1188)

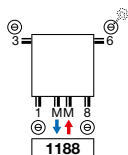

Other connection methods, see p. 190

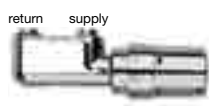

ref. nr. 1182 103 0000 0099

price € 218

Fittings, see p. 327

RECOMMENDED FOR BATHROOM AND KITCHEN IN OPTION



towel rail straight (chrome)

ref. nr. see p. 189

price € 187

Other accessories, see p. 189

ZANA VERTICAL

Tradition and trends in perfect harmony

The Zana combines an unbeatable power with timeless lines. A classic that remains captivating because of its power, class and comfort. The retro feeling is never far away. Modernity is abounding in this unique range of designer radiators for every environment, every room, and every use.



ZANA VERTICAL (ZV-1)



ZV-1

HOW TO ORDER ZANA VERTICAL
 Delivery time 15 - 30 working days
 (transport duration not included)

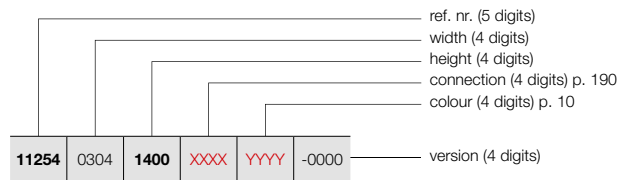

PRICE GROUP: VPG2 - STEEL DESIGN RADIATORS

REFERENCE CODE CUSTOM MADE ZANA VERTICAL						TECHNICAL DATA								STANDARD COLOUR		OTHER COLOURS	
tubes	width (L mm)	height (H mm)	75/65/20 (Watt) (φ50K)	55/45/20 (Watt) (φ30K)	n-exp.	weight (kg)	water content (l)	electr. resistance (Watt)	price RAL 9016 (€)	short ref. nr. RAL 9016 stock	price colour (€)						
REF. NR. ZANA VERTICAL ZV-1 : 11254																	
11254	0304	1400	XXXX	YYYY	-0000	8	304	1400	680	359	1,27	18,16	8,24	-	456	-	524
		1600				8	304	1600	769	406	1,27	20,72	9,44	-	495	-	569
		1800				8	304	1800	859	454	1,28	23,20	10,64	-	535	-	615
		2000				8	304	2000	950	502	1,28	25,68	11,68	-	572	-	658
		2200				8	304	2200	1042	550	1,28	28,08	12,72	-	611	-	703
		2400				8	304	2400	1136	600	1,29	30,56	13,76	-	656	-	754
		2600				8	304	2600	1231	650	1,29	33,04	14,80	-	694	-	798
		2800				8	304	2800	1327	701	1,29	35,44	15,84	-	732	-	842
3000	8	304	3000	1426	753	1,29	37,92	16,88	-	773	-	889					
11254	0384	1400	XXXX	YYYY	-0000	10	384	1400	850	449	1,27	22,70	10,30	-	544	-	626
		1600				10	384	1600	962	508	1,27	25,90	11,80	-	597	-	687
		1800				10	384	1800	1074	567	1,28	29,00	13,30	-	644	11254-03	741
		2000				10	384	2000	1188	627	1,28	32,10	14,60	-	696	-	800
		2200				10	384	2200	1303	688	1,28	35,10	15,90	-	745	-	857
		2400				10	384	2400	1420	750	1,29	38,20	17,20	-	792	-	911
		2600				10	384	2600	1539	813	1,29	41,30	18,50	-	847	-	974
		2800				10	384	2800	1659	876	1,29	44,30	19,80	-	894	-	1028
3000	10	384	3000	1782	941	1,29	47,40	21,10	-	942	-	1083					
11254	0464	1400	XXXX	YYYY	-0000	12	464	1400	1020	539	1,27	27,24	12,36	-	637	-	733
		1600				12	464	1600	1154	609	1,27	31,08	14,16	-	697	-	802
		1800				12	464	1800	1289	681	1,28	34,80	15,96	-	757	11254-12	871
		2000				12	464	2000	1425	752	1,28	38,52	17,52	-	818	11254-01	941
		2200				12	464	2200	1563	825	1,28	42,12	19,08	-	879	-	1011
		2400				12	464	2400	1704	900	1,29	45,84	20,64	-	933	-	1073
		2600				12	464	2600	1846	975	1,29	49,56	22,20	-	996	-	1145
		2800				12	464	2800	1991	1051	1,29	53,16	23,76	-	1054	-	1212
3000	12	464	3000	2139	1130	1,29	56,88	25,32	-	1117	-	1285					
11254	0544	1400	XXXX	YYYY	-0000	14	544	1400	1190	628	1,27	31,78	14,42	-	730	-	840
		1600				14	544	1600	1346	711	1,27	36,26	16,52	-	799	-	919
		1800				14	544	1800	1504	794	1,28	40,60	18,62	-	865	11254-07	995
		2000				14	544	2000	1663	878	1,28	44,94	20,44	-	935	11254-08	1075
		2200				14	544	2200	1824	963	1,28	49,14	22,26	-	1007	-	1158
		2400				14	544	2400	1988	1050	1,29	53,48	24,08	-	1076	-	1237
		2600				14	544	2600	2154	1137	1,29	57,82	25,90	-	1147	-	1319
		2800				14	544	2800	2323	1227	1,29	62,02	27,72	-	1216	-	1398
3000	14	544	3000	2495	1318	1,29	66,36	29,54	-	1286	-	1479					
11254	0624	1400	XXXX	YYYY	-0000	16	624	1400	1360	718	1,27	36,32	16,48	-	822	-	945
		1600				16	624	1600	1539	813	1,27	41,44	18,88	-	901	-	1036
		1800				16	624	1800	1719	908	1,28	46,40	21,28	-	980	11254-09	1127
		2000				16	624	2000	1900	1003	1,28	51,36	23,36	-	1059	11254-02	1218
		2200				16	624	2200	2085	1101	1,28	56,16	25,44	-	1139	-	1310
		2400				16	624	2400	2272	1200	1,29	61,12	27,52	-	1219	-	1402
		2600				16	624	2600	2462	1300	1,29	66,08	29,60	-	1298	-	1493
		2800				16	624	2800	2655	1402	1,29	70,88	31,68	-	1376	-	1582
3000	16	624	3000	2852	1506	1,29	75,84	33,76	-	1456	-	1674					

In conformity with EN442-1: 2014: radiators and convectors

For heat outputs in other regimes, see p. 320 (correction factors)
 EXPORT. Prices in Euro (excl. VAT)



HOW TO ORDER ZANA VERTICAL
 Delivery time 15 - 30 working days
 (transport duration not included)

ZANA VERTICAL (ZV-1)

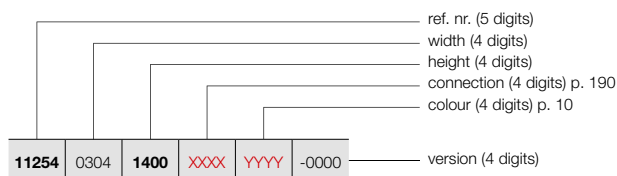

ZV-1

PRICE GROUP: VPG2 - STEEL DESIGN RADIATORS

REFERENCE CODE CUSTOM MADE ZANA VERTICAL						TECHNICAL DATA					STANDARD COLOUR		OTHER COLOURS				
						tubes	width (L mm)	height (H mm)	75/65/20 (Watt) (φ50K)	55/45/20 (Watt) (φ30K)	n-exp.	weight (kg)	water content (l)	electr. resistance (Watt)	price RAL 9016 (€)	short ref. nr. RAL 9016 stock	price colour (€)
REF. NR. ZANA VERTICAL ZV-1 : 11254																	
11254	0304	1400	XXXX	YYYY	-0000	18	704	1400	1531	808	1,27	40,86	18,54	-	915	-	1052
						18	704	1600	1731	914	1,27	46,62	21,24	-	1000	-	1150
						18	704	1800	1933	1021	1,28	52,20	23,94	-	1089	-	1252
						18	704	2000	2138	1129	1,28	57,78	26,28	-	1180	-	1357
						18	704	2200	2345	1238	1,28	63,18	28,62	-	1269	-	1459
						18	704	2400	2555	1349	1,29	68,76	30,96	-	1361	-	1565
						18	704	2600	2769	1462	1,29	74,34	33,30	-	1447	-	1664
						18	704	2800	2987	1577	1,29	79,74	35,64	-	1537	-	1768
						18	704	3000	3208	1694	1,29	85,32	37,98	-	1626	-	1870
11254	0784	1400	XXXX	YYYY	-0000	20	784	1400	1701	898	1,27	45,40	20,60	-	1002	-	1152
						20	784	1600	1923	1015	1,27	51,80	23,60	-	1104	-	1270
						20	784	1800	2148	1134	1,28	58,00	26,60	-	1202	-	1382
						20	784	2000	2375	1254	1,28	64,20	29,20	-	1300	-	1495
						20	784	2200	2606	1376	1,28	70,20	31,80	-	1400	-	1610
						20	784	2400	2839	1499	1,29	76,40	34,40	-	1500	-	1725
						20	784	2600	3077	1625	1,29	82,60	37,00	-	1599	-	1839
						20	784	2800	3319	1753	1,29	88,60	39,60	-	1697	-	1952
						20	784	3000	3564	1882	1,29	94,80	42,20	-	1796	-	2065
11254	0864	1400	XXXX	YYYY	-0000	22	864	1400	1871	988	1,27	49,94	22,66	-	1094	-	1258
						22	864	1600	2116	1117	1,27	56,98	25,96	-	1204	-	1385
						22	864	1800	2363	1248	1,28	63,80	29,26	-	1313	-	1510
						22	864	2000	2613	1380	1,28	70,62	32,12	-	1422	-	1635
						22	864	2200	2866	1513	1,28	77,22	34,98	-	1531	-	1761
						22	864	2400	3123	1649	1,29	84,04	37,84	-	1644	-	1891
						22	864	2600	3385	1788	1,29	90,86	40,70	-	1752	-	2015
						22	864	2800	3650	1927	1,29	97,46	43,56	-	1861	-	2140
						22	864	3000	3921	2071	1,29	104,28	46,42	-	1968	-	2263
11254	0944	1400	XXXX	YYYY	-0000	24	944	1400	2041	1078	1,27	54,48	24,72	-	1186	-	1364
						24	944	1600	2308	1219	1,27	62,16	28,32	-	1304	-	1500
						24	944	1800	2578	1361	1,28	69,60	31,92	-	1425	-	1639
						24	944	2000	2850	1505	1,28	77,04	35,04	-	1543	-	1774
						24	944	2200	3127	1651	1,28	84,24	38,16	-	1662	-	1911
						24	944	2400	3407	1799	1,29	91,68	41,28	-	1783	-	2050
						24	944	2600	3692	1950	1,29	99,12	44,40	-	1902	-	2187
						24	944	2800	3982	2103	1,29	106,32	47,52	-	2019	-	2322
						24	944	3000	4277	2259	1,29	113,76	50,64	-	2142	-	2463
11254	1024	1400	XXXX	YYYY	-0000	26	1024	1400	2211	1168	1,27	59,02	26,78	-	1279	-	1471
						26	1024	1600	2500	1320	1,27	67,34	30,68	-	1405	-	1616
						26	1024	1800	2793	1475	1,28	75,40	34,58	-	1534	-	1764
						26	1024	2000	3088	1631	1,28	83,46	37,96	-	1665	-	1915
						26	1024	2200	3388	1789	1,28	91,26	41,34	-	1793	-	2062
						26	1024	2400	3691	1949	1,29	99,32	44,72	-	1925	-	2214
						26	1024	2600	4000	2112	1,29	107,38	48,10	-	2052	-	2360
						26	1024	2800	4314	2278	1,29	115,18	51,48	-	2184	-	2512
						26	1024	3000	4634	2447	1,29	123,24	54,86	-	2310	-	2657

In conformity with EN442-1: 2014: radiators and convectors

For heat outputs in other regimes, see p. 320 (correction factors)
 EXPORT. Prices in Euro (excl. VAT)

VASCO

ZANA VERTICAL (ZV-2)



ZV-2

HOW TO ORDER ZANA VERTICAL

Delivery time 15 - 30 working days
(transport duration not included)

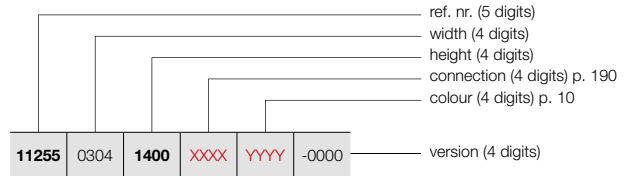

HOW TO ORDER STOCK RADIATOR ZANA VERTICAL

Delivery time 5 working days
(transport duration not included)

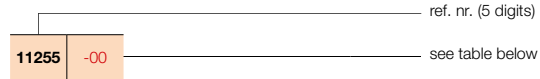

PRICE GROUP: VPG2 - STEEL DESIGN RADIATORS

REFERENCE CODE CUSTOM MADE ZANA VERTICAL						TECHNICAL DATA							STANDARD COLOUR		OTHER COLOURS			
11255	0304	1400	XXXX	YYYY	-0000	tubes	width (L mm)	height (H mm)	75/65/20 (Watt) (φ50K)	55/45/20 (Watt) (φ30K)	n-exp.	weight (kg)	water content (l)	electr. resistance (Watt)	price RAL 9016 (€)	short ref. nr. RAL 9016 stock	price colour (€)	
REF. NR. ZANA VERTICAL ZV-2 : 11255																		
11255	0304	1400	XXXX	YYYY	-0000	8	304	1400	1105	584	1,30	35,20	16,16	-	774	-	890	
		1600				8	304	1600	1242	656	1,30	40,16	18,40	-	839	-	965	
		1800				8	304	1800	1379	728	1,30	45,12	20,64	-	908	-	1044	
		2000				8	304	2000	1515	800	1,30	50,00	23,28	-	978	-	1125	
		2200				8	304	2200	1651	872	1,30	54,80	25,92	-	1043	-	1199	
		2400				8	304	2400	1788	944	1,30	59,68	28,56	-	1110	-	1277	
		2600				8	304	2600	1925	1017	1,30	64,48	31,12	-	1180	-	1357	
		2800				8	304	2800	2062	1089	1,30	69,36	33,76	-	1244	-	1431	
		3000				8	304	3000	2200	1162	1,30	74,16	36,40	-	1313	-	1510	
11255	0384	1400	XXXX	YYYY	-0000	10	384	1400	1381	729	1,30	44,00	20,20	-	929	-	1068	
		1600				10	384	1600	1553	820	1,30	50,20	23,00	-	1014	-	1166	
		1800				10	384	1800	1724	910	1,30	56,40	25,80	-	1096	-	1260	
		2000				10	384	2000	1894	1000	1,30	62,50	29,10	-	1183	-	1360	
		2200				10	384	2200	2064	1090	1,30	68,50	32,40	-	1267	-	1457	
		2400				10	384	2400	2235	1180	1,30	74,60	35,70	-	1350	-	1553	
		2600				10	384	2600	2406	1271	1,30	80,60	38,90	-	1437	-	1653	
		2800				10	384	2800	2577	1361	1,30	86,70	42,20	-	1520	-	1748	
		3000				10	384	3000	2750	1452	1,30	92,70	45,50	-	1602	-	1842	
11255	0464	1400	XXXX	YYYY	-0000	12	464	1400	1657	875	1,30	52,80	24,24	-	1083	-	1245	
		1600				12	464	1600	1863	984	1,30	60,24	27,60	-	1185	-	1363	
		1800				12	464	1800	2068	1092	1,30	67,68	30,96	-	1288	-	1481	
		2000				12	464	2000	2273	1200	1,30	75,00	34,92	-	1388	-	1596	
		2200				12	464	2200	2477	1308	1,30	82,20	38,88	-	1490	-	1714	
		2400				12	464	2400	2682	1416	1,30	89,52	42,84	-	1591	-	1830	
		2600				12	464	2600	2887	1525	1,30	96,72	46,68	-	1691	-	1945	
		2800				12	464	2800	3093	1633	1,30	104,04	50,64	-	1793	-	2062	
		3000				12	464	3000	3300	1743	1,30	111,24	54,60	-	1895	-	2179	
11255	0544	1400	XXXX	YYYY	-0000	14	544	1400	1933	1021	1,30	61,60	28,28	-	1240	-	1426	
		1600				14	544	1600	2174	1148	1,30	70,28	32,20	-	1361	-	1565	
		1800				14	544	1800	2413	1274	1,30	78,96	36,12	-	1474	-	1695	
		2000				14	544	2000	2651	1400	1,30	87,50	40,74	-	1594	11255-02	1833	
		2200				14	544	2200	2890	1526	1,30	95,90	45,36	-	1714	-	1971	
		2400				14	544	2400	3129	1652	1,30	104,44	49,98	-	1831	-	2106	
		2600				14	544	2600	3368	1779	1,30	112,84	54,46	-	1948	-	2240	
		2800				14	544	2800	3608	1905	1,30	121,38	59,08	-	2068	-	2378	
		3000				14	544	3000	3849	2033	1,30	129,78	63,70	-	2186	-	2514	
11255	0624	1400	XXXX	YYYY	-0000	16	624	1400	2209	1167	1,30	70,40	32,32	-	1395	-	1604	
		1600				16	624	1600	2484	1312	1,30	80,32	36,80	-	1529	-	1758	
		1800				16	624	1800	2758	1456	1,30	90,24	41,28	-	1662	-	1911	
		2000				16	624	2000	3030	1600	1,30	100,00	46,56	-	1801	-	2071	
		2200				16	624	2200	3303	1744	1,30	109,60	51,84	-	1936	-	2226	
		2400				16	624	2400	3576	1888	1,30	119,36	57,12	-	2071	-	2382	
		2600				16	624	2600	3849	2033	1,30	128,96	62,24	-	2208	-	2539	
		2800				16	624	2800	4124	2178	1,30	138,72	67,52	-	2339	-	2690	
		3000				16	624	3000	4399	2323	1,30	148,32	72,80	-	2476	-	2847	

In conformity with EN442-1: 2014: radiators and convectors

**For heat outputs in other regimes, see p. 320 (correction factors)
EXPORT. Prices in Euro (excl. VAT)**



HOW TO ORDER ZANA VERTICAL
 Delivery time 15 - 30 working days
 (transport duration not included)

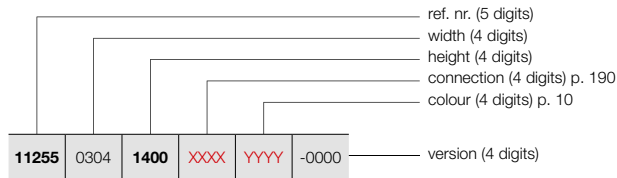

ZANA VERTICAL (ZV-2)



ZV-2

HOW TO ORDER STOCK RADIATOR ZANA VERTICAL

Delivery time 5 working days
 (transport duration not included)

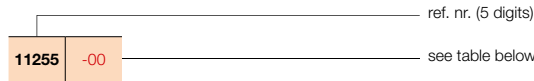

PRICE GROUP: VPG2 - STEEL DESIGN RADIATORS

REFERENCE CODE CUSTOM MADE ZANA VERTICAL	TECHNICAL DATA									STANDARD COLOUR		OTHER COLOURS					
	tubes	width (L mm)	height (H mm)	75/65/20 (Watt (φ50K))	55/45/20 (Watt (φ30K))	n-exp.	weight (kg)	water content (l)	electr. resistance (Watt)	price RAL 9016 (€)	short ref. nr. RAL 9016 stock	price colour (€)					
REF. NR. ZANA VERTICAL ZV-2 : 11255																	
11255	0704	1400	XXXX	YYYY	-0000	18	704	1400	2486	1313	1,30	79,20	36,36	-	1550	-	1783
		1600				18	704	1600	2795	1476	1,30	90,36	41,40	-	1700	-	1955
		1800				18	704	1800	3102	1638	1,30	101,52	46,44	-	1854	-	2132
		2000				18	704	2000	3409	1800	1,30	112,50	52,38	-	2007	11255-01	2308
		2200				18	704	2200	3716	1962	1,30	123,30	58,32	-	2158	-	2482
		2400				18	704	2400	4023	2124	1,30	134,28	64,26	-	2309	-	2655
		2600				18	704	2600	4330	2287	1,30	145,08	70,02	-	2462	-	2831
		2800				18	704	2800	4639	2450	1,30	156,06	75,96	-	2614	-	3006
11255	0784	1400	XXXX	YYYY	-0000	20	784	1400	2762	1459	1,30	88,00	40,40	-	1707	-	1963
		1600				20	784	1600	3105	1640	1,30	100,40	46,00	-	1875	-	2156
		1800				20	784	1800	3447	1820	1,30	112,80	51,60	-	2042	-	2348
		2000				20	784	2000	3788	2000	1,30	125,00	58,20	-	2212	-	2544
		2200				20	784	2200	4129	2180	1,30	137,00	64,80	-	2380	-	2737
		2400				20	784	2400	4470	2360	1,30	149,20	71,40	-	2551	-	2934
		2600				20	784	2600	4812	2541	1,30	161,20	77,80	-	2718	-	3126
		11255				0864	1400	XXXX	YYYY	-0000	22	864	1400	3038	1604	1,30	96,80
1600	22		864	1600	3416		1804				1,30	110,44	50,60	-	2046	-	2353
1800	22		864	1800	3792		2002				1,30	124,08	56,76	-	2231	-	2566
2000	22		864	2000	4167		2200				1,30	137,50	64,02	-	2419	-	2782
2200	22		864	2200	4541		2398				1,30	150,70	71,28	-	2605	-	2996
11255	0944	1400	XXXX	YYYY	-0000	24	944	1400	3314	1750	1,30	105,60	48,48	-	2015	-	2317
		1600				24	944	1600	3726	1968	1,30	120,48	55,20	-	2220	-	2553
		1800				24	944	1800	4136	2184	1,30	135,36	61,92	-	2422	-	2785
		2000				24	944	2000	4545	2400	1,30	150,00	69,84	-	2624	-	3018
11255	1024	1400	XXXX	YYYY	-0000	26	1024	1400	3590	1896	1,30	114,40	52,52	-	2174	-	2500
		1600				26	1024	1600	4037	2132	1,30	130,52	59,80	-	2392	-	2751
		1800				26	1024	1800	4481	2366	1,30	146,64	67,08	-	2610	-	3002

In conformity with EN442-1: 2014: radiators and convectors

For heat outputs in other regimes, see p. 320 (correction factors)
 EXPORT. Prices in Euro (excl. VAT)

ZANA HORIZONTAL (ZH-1, ZH-2)



TYPES

- One (ZH-1) or two rows (ZH-2)

TUBES

- Vertical, rectangular 45 x 20 mm
- Attention: horizontal design, but always with vertical tubes !

COLLECTORS

- Horizontal, rear, round Ø 35 mm

COLOURS

- Standard colour white RAL 9016
- Extensive colour chart see p. 10

SPECIAL

- ZH-1 also available as toilet radiator (384 x 500 mm)

BRACKETS

- Wall brackets standard

TECHNICAL

- Electrically laser welded (invisible weld seams)
- KTL priming coat, powder coating
- Standard operating pressure: 4 bar
- Maximum operating temperature: 110°C

ELECTRICAL

- ✗ Pure electrical radiator prefilled
- ✗ Mixed radiator

TECHNICAL DRAWINGS

- See p. 191

CONNECTION

- ✗ One-point connection for one-pipe system
- ✗ One-point connection for two-pipe system
- ✗ Two-point connection for one-pipe system
- ✓ Two-point connection for two-pipe system (standard) (see p. 312)
- ✗ Integrated valve
- Connections: 1/2" (inner thread)

ZANA HORIZONTAL

Beautiful until the end of time

Also the horizontal version of the Zana designer radiator is a splendid example of class, power and comfort. Together, the vertical pipes and horizontal collectors form a nicely structured geometric whole and contribute to the specific Zana retro look. The Zana Horizontal is available with one or two rows of pipes and there is also a separate toilet version.

RECOMMENDED CONNECTION (0018)

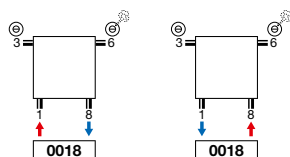

Other connection methods, see p. 190



ref. nr. 1182 101 0000 0099

price € 218

Fittings, see p. 327

RECOMMENDED FOR BATHROOM AND KITCHEN IN OPTION



towel rail straight (chrome)

ref. nr. see p. 189

price € 187

Other accessories, see p. 189



HOW TO ORDER ZANA HORIZONTAL

Delivery time 15 - 30 working days
(transport duration not included)

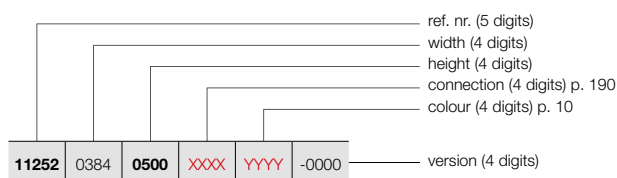

ZANA HORIZONTAL (ZH-1)



ZH-1

PRICE GROUP: VPG2 - STEEL DESIGN RADIATORS

REFERENCE CODE CUSTOM MADE ZANA HORIZONTAL	TECHNICAL DATA										STANDARD COLOUR	OTHER COLOURS				
	tubes	width (L mm)	height (H mm)	75/65/20 (Watt) (φ50K)	55/45/20 (Watt) (φ30K)	n-exp.	weight (kg)	water content (l)	electr. resistance (Watt)	price RAL 9016 (€)	price colour (€)					
REF. NR. ZANA HORIZONTAL ZH-1 : 11252																
11252	0384	0500	XXXX	YYYY	-0000	10	384	500	347	183	1,25	9,00	4,10	-	322	370
11252	0704	0500	XXXX	YYYY	-0000	18	704	500	624	330	1,25	16,20	7,38	-	510	587
		0600				18	704	600	728	384	1,25	18,90	8,46	-	554	637
		0700				18	704	700	831	439	1,25	21,60	9,72	-	598	688
11252	0784	0500	XXXX	YYYY	-0000	20	784	500	694	366	1,25	18,00	8,20	-	556	639
		0600				20	784	600	809	427	1,25	21,00	9,40	-	606	697
		0700				20	784	700	923	487	1,25	24,00	10,80	-	657	756
11252	0864	0500	XXXX	YYYY	-0000	22	864	500	763	403	1,25	19,80	9,02	-	603	693
		0600				22	864	600	890	470	1,25	23,10	10,34	-	658	757
		0700				22	864	700	1015	536	1,25	26,40	11,88	-	710	817
11252	0944	0500	XXXX	YYYY	-0000	24	944	500	832	439	1,25	21,60	9,84	-	647	744
		0600				24	944	600	971	513	1,25	25,20	11,28	-	706	812
		0700				24	944	700	1107	585	1,25	28,80	12,96	-	768	883
11252	1024	0500	XXXX	YYYY	-0000	26	1024	500	902	476	1,25	23,40	10,66	-	696	800
		0600				26	1024	600	1052	556	1,25	27,30	12,22	-	760	874
		0700				26	1024	700	1200	634	1,25	31,20	14,04	-	826	950
11252	1104	0500	XXXX	YYYY	-0000	28	1104	500	971	513	1,25	25,20	11,48	-	742	853
		0600				28	1104	600	1133	598	1,25	29,40	13,16	-	813	935
		0700				28	1104	700	1292	682	1,25	33,60	15,12	-	883	1015
11252	1184	0500	XXXX	YYYY	-0000	30	1184	500	1040	549	1,25	27,00	12,30	-	787	905
		0600				30	1184	600	1214	641	1,25	31,50	14,10	-	861	990
		0700				30	1184	700	1384	731	1,25	36,00	16,20	-	936	1076
11252	1264	0500	XXXX	YYYY	-0000	32	1264	500	1110	586	1,25	28,80	13,12	-	834	959
		0600				32	1264	600	1295	684	1,25	33,60	15,04	-	917	1055
		0700				32	1264	700	1476	779	1,25	38,40	17,28	-	995	1144
11252	1424	0500	XXXX	YYYY	-0000	36	1424	500	1248	659	1,25	32,40	14,76	-	929	1068
		0600				36	1424	600	1457	769	1,25	37,80	16,92	-	1017	1170
		0700				36	1424	700	1661	877	1,25	43,20	19,44	-	1107	1273
11252	1584	0500	XXXX	YYYY	-0000	40	1584	500	1387	732	1,25	36,00	16,40	-	1022	1175
		0600				40	1584	600	1618	854	1,25	42,00	18,80	-	1121	1289
		0700				40	1584	700	1846	975	1,25	48,00	21,60	-	1221	1404
11252	1744	0500	XXXX	YYYY	-0000	44	1744	500	1526	806	1,25	39,60	18,04	-	1117	1285
		0600				44	1744	600	1780	940	1,25	46,20	20,68	-	1225	1409
		0700				44	1744	700	2030	1072	1,25	52,80	23,76	-	1333	1533
11252	1904	0500	XXXX	YYYY	-0000	48	1904	500	1665	879	1,25	43,20	19,68	-	1207	1388
		0600				48	1904	600	1942	1026	1,25	50,40	22,56	-	1327	1526
		0700				48	1904	700	2215	1170	1,25	57,60	25,92	-	1446	1663

In conformity with EN442-1: 2014: radiators and convectors

For heat outputs in other regimes, see p. 320 (correction factors)
EXPORT. Prices in Euro (excl. VAT)

VASCO

ZANA HORIZONTAL (ZH-1)



ZH-1

HOW TO ORDER ZANA HORIZONTAL

Delivery time 15 - 30 working days
(transport duration not included)

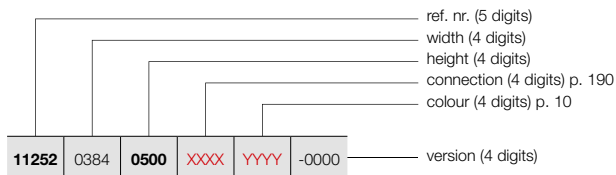

PRICE GROUP: VPG2 - STEEL DESIGN RADIATORS

REFERENCE CODE CUSTOM MADE ZANA HORIZONTAL							TECHNICAL DATA					STANDARD COLOUR	OTHER COLOURS			
tubes	width (L mm)	height (H mm)	75/65/20 (Watt) (φ50K)	55/45/20 (Watt) (φ30K)	n-exp.	weight (kg)	water content (l)	electr. resistance (Watt)	price RAL 9016 (€)	price colour (€)						
REF. NR. ZANA HORIZONTAL ZH-1 : 11252																
11252	2064	0500	XXXX	YYYY	-0000	52	2064	500	1803	952	1,25	46,80	21,32	-	1300	1495
		0600				52	2064	600	2104	1111	1,25	54,60	24,44	-	1430	1645
		0700				52	2064	700	2399	1267	1,25	62,40	28,08	-	1561	1795
11252	2224	0500	XXXX	YYYY	-0000	56	2224	500	1942	1026	1,25	50,40	22,96	-	1395	1604
		0600				56	2224	600	2266	1197	1,25	58,80	26,32	-	1533	1763
		0700				56	2224	700	2584	1365	1,25	67,20	30,24	-	1674	1925
11252	2384	0500	XXXX	YYYY	-0000	60	2384	500	2081	1099	1,25	54,00	24,60	-	1489	1712
		0600				60	2384	600	2428	1282	1,25	63,00	28,20	-	1636	1881
		0700				60	2384	700	2768	1462	1,25	72,00	32,40	-	1787	2055
11252	2544	0500	XXXX	YYYY	-0000	64	2544	500	2220	1172	1,25	57,60	26,24	-	1581	1818
		0600				64	2544	600	2589	1367	1,25	67,20	30,08	-	1741	2002
		0700				64	2544	700	2953	1559	1,25	76,80	34,56	-	1900	2185
11252	2704	0500	XXXX	YYYY	-0000	68	2704	500	2358	1245	1,25	61,20	27,88	-	1675	1926
		0600				68	2704	600	2751	1453	1,25	71,40	31,96	-	1844	2121
		0700				68	2704	700	3138	1657	1,25	81,60	36,72	-	2012	2314
11252	2864	0500	XXXX	YYYY	-0000	72	2864	500	2497	1319	1,25	64,80	29,52	-	1765	2030
		0600				72	2864	600	2913	1538	1,25	75,60	33,84	-	1945	2237
		0700				72	2864	700	3322	1754	1,25	86,40	38,88	-	2125	2444

In conformity with EN442-1: 2014: radiators and convectors

For heat outputs in other regimes, see p. 320 (correction factors)
EXPORT. Prices in Euro (excl. VAT)

VASCO

HOW TO ORDER ZANA HORIZONTAL

Delivery time 15 - 30 working days
(transport duration not included)

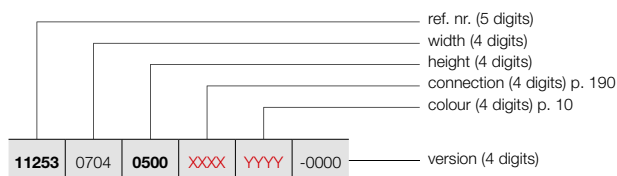

ZANA HORIZONTAL (ZH-2)



ZH-2

PRICE GROUP: VPG2 - STEEL DESIGN RADIATORS

REFERENCE CODE CUSTOM MADE ZANA HORIZONTAL							TECHNICAL DATA				STANDARD COLOUR		OTHER COLOURS			
							tubes	width (L mm)	height (H mm)	75/65/20 (Watt) (φ50K)	55/45/20 (Watt) (φ30K)	n-exp.	weight (kg)	water content (l)	electr. resistance (Watt)	price RAL 9016 (€)
REF. NR. ZANA HORIZONTAL ZH-2 : 11253																
11253	0704	0500	XXXX	YYYY	-0000	18	704	500	1035	547	1,28	30,42	13,50	-	863	992
		0600				18	704	600	1205	636	1,28	35,64	16,02	-	942	1083
		0700				18	704	700	1372	725	1,28	41,04	18,54	-	1015	1167
11253	0784	0500	XXXX	YYYY	-0000	20	784	500	1150	607	1,28	33,80	15,00	-	944	1086
		0600				20	784	600	1339	707	1,28	39,60	17,80	-	1030	1185
		0700				20	784	700	1525	805	1,28	45,60	20,60	-	1115	1282
11253	0864	0500	XXXX	YYYY	-0000	22	864	500	1265	668	1,28	37,18	16,50	-	1023	1176
		0600				22	864	600	1473	778	1,28	43,56	19,58	-	1118	1286
		0700				22	864	700	1677	886	1,28	50,16	22,66	-	1207	1388
11253	0944	0500	XXXX	YYYY	-0000	24	944	500	1380	729	1,28	40,56	18,00	-	1104	1270
		0600				24	944	600	1607	849	1,28	47,52	21,36	-	1204	1385
		0700				24	944	700	1830	966	1,28	54,72	24,72	-	1304	1500
11253	1024	0500	XXXX	YYYY	-0000	26	1024	500	1494	789	1,28	43,94	19,50	-	1183	1360
		0600				26	1024	600	1741	919	1,28	51,48	23,14	-	1295	1489
		0700				26	1024	700	1982	1047	1,28	59,28	26,78	-	1402	1612
11253	1104	0500	XXXX	YYYY	-0000	28	1104	500	1609	850	1,28	47,32	21,00	-	1263	1452
		0600				28	1104	600	1875	990	1,28	55,44	24,92	-	1380	1587
		0700				28	1104	700	2135	1127	1,28	63,84	28,84	-	1497	1722
11253	1184	0500	XXXX	YYYY	-0000	30	1184	500	1724	910	1,28	50,70	22,50	-	1339	1540
		0600				30	1184	600	2009	1061	1,28	59,40	26,70	-	1467	1687
		0700				30	1184	700	2287	1208	1,28	68,40	30,90	-	1595	1834
11253	1264	0500	XXXX	YYYY	-0000	32	1264	500	1839	971	1,28	54,08	24,00	-	1419	1632
		0600				32	1264	600	2143	1132	1,28	63,36	28,48	-	1558	1792
		0700				32	1264	700	2440	1288	1,28	72,96	32,96	-	1689	1942
11253	1424	0500	XXXX	YYYY	-0000	36	1424	500	2069	1093	1,28	60,84	27,00	-	1580	1817
		0600				36	1424	600	2411	1273	1,28	71,28	32,04	-	1729	1988
		0700				36	1424	700	2745	1450	1,28	82,08	37,08	-	1884	2167
11253	1584	0500	XXXX	YYYY	-0000	40	1584	500	2299	1214	1,28	67,60	30,00	-	1738	1999
		0600				40	1584	600	2678	1414	1,28	79,20	35,60	-	1907	2193
		0700				40	1584	700	3050	1611	1,28	91,20	41,20	-	2076	2387
11253	1744	0500	XXXX	YYYY	-0000	44	1744	500	2529	1335	1,28	74,36	33,00	-	1895	2179
		0600				44	1744	600	2946	1556	1,28	87,12	39,16	-	2082	2394
		0700				44	1744	700	3355	1772	1,28	100,32	45,32	-	2266	2606
11253	1904	0500	XXXX	YYYY	-0000	48	1904	500	2759	1457	1,28	81,12	36,00	-	2053	2361
		0600				48	1904	600	3214	1697	1,28	95,04	42,72	-	2257	2596
		0700				48	1904	700	3660	1933	1,28	109,44	49,44	-	2459	2828

In conformity with EN442-1: 2014: radiators and convectors

For heat outputs in other regimes, see p. 320 (correction factors)
EXPORT. Prices in Euro (excl. VAT)

VASCO

ZANA HORIZONTAL (ZH-2)



ZH-2

HOW TO ORDER ZANA HORIZONTAL

Delivery time 15 - 30 working days
(transport duration not included)

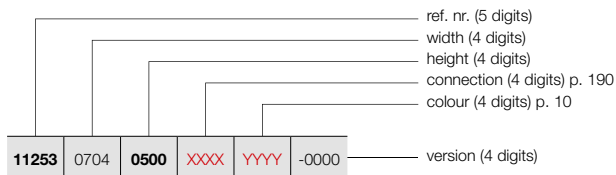

PRICE GROUP: VPG2 - STEEL DESIGN RADIATORS

REFERENCE CODE CUSTOM MADE ZANA HORIZONTAL							TECHNICAL DATA						STANDARD COLOUR	OTHER COLOURS		
tubes	width (L mm)	height (H mm)	75/65/20 (Watt (φ50K)	55/45/20 (Watt (φ30K)	n-exp.	weight (kg)	water content (l)	electr. resistance (Watt)	price RAL 9016 (€)	price colour (€)						
REF. NR. ZANA HORIZONTAL ZH-2 : 11253																
11253	2064	0500	XXXX	YYYY	-0000	52	2064	500	2989	1578	1,28	87,88	39,00	-	2212	2544
		0600				52	2064	600	3482	1839	1,28	102,96	46,28	-	2431	2796
		0700				52	2064	700	3964	2093	1,28	118,56	53,56	-	2650	3048
11253	2224	0500	XXXX	YYYY	-0000	56	2224	500	3219	1700	1,28	94,64	42,00	-	2374	2730
		0600				56	2224	600	3750	1980	1,28	110,88	49,84	-	2607	2998
		0700				56	2224	700	4269	2254	1,28	127,68	57,68	-	2843	3269
11253	2384	0500	XXXX	YYYY	-0000	60	2384	500	3449	1821	1,28	101,40	45,00	-	2530	2910
		0600				60	2384	600	4018	2122	1,28	118,80	53,40	-	2784	3202
		0700				60	2384	700	4574	2415	1,28	136,80	61,80	-	3036	3491
11253	2544	0500	XXXX	YYYY	-0000	64	2544	500	3679	1943	1,28	108,16	48,00	-	2687	3090
		0600				64	2544	600	4285	2263	1,28	126,72	56,96	-	2960	3404
		0700				64	2544	700	4879	2576	1,28	145,92	65,92	-	3227	3711
11253	2704	0500	XXXX	YYYY	-0000	68	2704	500	3909	2064	1,28	114,92	51,00	-	2848	3275
		0600				68	2704	600	4553	2404	1,28	134,64	60,52	-	3133	3603
		0700				68	2704	700	5184	2737	1,28	155,04	70,04	-	3420	3933
11253	2864	0500	XXXX	YYYY	-0000	72	2864	500	4139	2186	1,28	121,68	54,00	-	3006	3457
		0600				72	2864	600	4821	2546	1,28	142,56	64,08	-	3311	3808

In conformity with EN442-1: 2014: radiators and convectors

For heat outputs in other regimes, see p. 320 (correction factors)
EXPORT. Prices in Euro (excl. VAT)

PRICE GROUP: VPG10B - TOWEL RAILS

ACCESSORIES	WIDTH RADIATOR	COLOUR	REF. NR.	€
ZV-1 / ZV-2 / ZH-1 / ZH-2				
TOWEL RAIL STRAIGHT 		CHROME	1183 228 0000 0099	187
<ul style="list-style-type: none"> h = 22 mm; b = 720 mm (easy adjustable); d = 75 mm; a = 56 mm 				
ZV-1 / ZV-2 / ZH-1 / ZH-2				
HOOK 		CHROME	1183 410 0000 0099	87
<ul style="list-style-type: none"> h = 70 mm; b = 70 mm; d = 59 mm; a = 51 mm; 				
ZV-1				
TOWEL RAIL MULTI+ RIGHT 	600 mm	S600	1183 734 0000 0600	204
	600 mm	RAL 9005 ^S	1183 734 0000 9005	204
<ul style="list-style-type: none"> h = 70 mm; b = 600 mm (b tablet = 194 mm); e = 176 mm; c = 170 mm; Mounting on the wall, to the right of the radiator. 				
ZV-1				
TOWEL RAIL MULTI+ LEFT 	600 mm	S600	1183 735 0000 0600	204
	600 mm	RAL 9005 ^S	1183 735 0000 9005	204
<ul style="list-style-type: none"> h = 70 mm; b = 600 mm (b tablet = 194 mm); e = 176 mm; c = 170 mm; Mounting on the wall, to the left of the radiator. 				

^S structure black

Mounting instructions accessories: see www.vasco.eu
EXPORT. Prices in Euro (excl. VAT)

e = distance front of the accessory up to the wall
d = distance front of the accessory up to front of the radiator
c = distance between wall to back towel bar
a = distance accessory up to the radiator
available from stock

ZANA VERTICAL: ZV-1 / ZV-2 (STOCK)

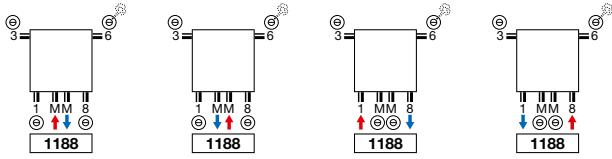

ZANA HORIZONTAL: ZH-1 / ZH-2

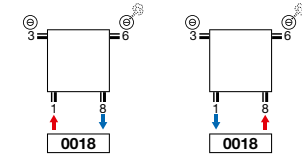

ZANA VERTICAL: ZV-1 / ZV-2 (NON STOCK)

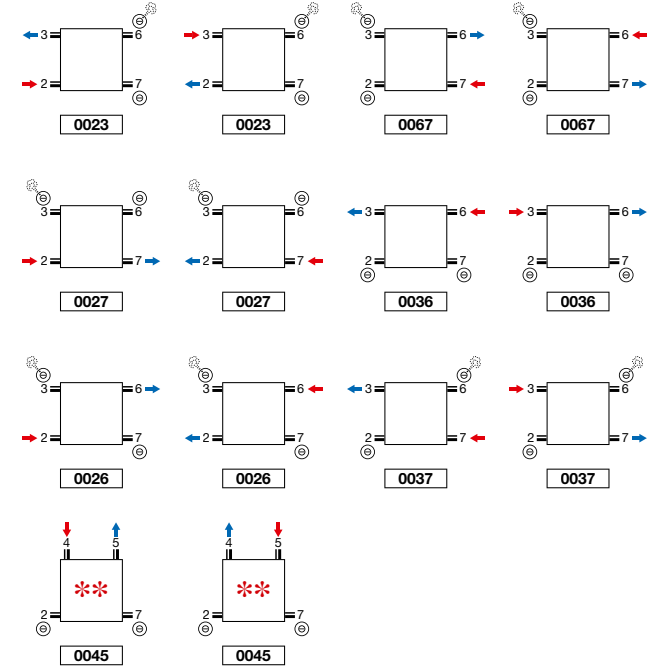
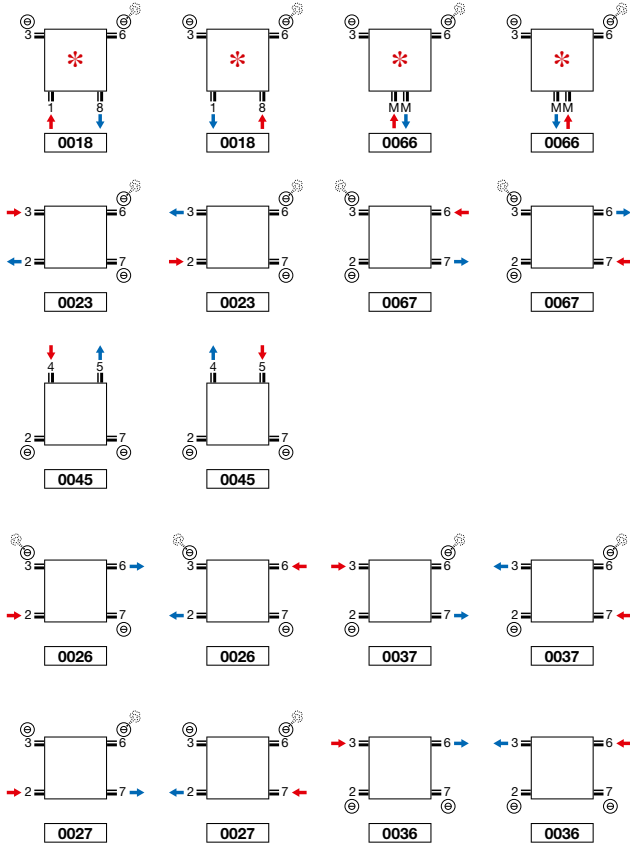

** Not for toilet radiator ZH-1.

* Attention ZV-1/ZV-2 8 tubes: 2/3/6/7 always open.

Attention: connecting the radiator can only be as shown by the connecting icons. For any other connection method, we take no responsibility.

ZANA VERTICAL (ZV-1, ZV-2)

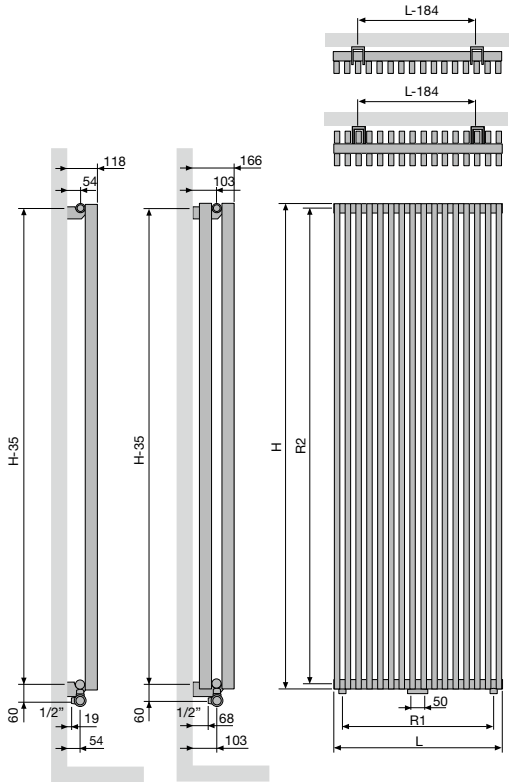

	ZV-1 / ZV-2										
number of tubes	8	10	12	14	16	18	20	22	24	26	
Width (L)	304	384	464	544	624	704	784	864	944	1024	
Centre between the connections at the bottom 18 (R1)	240	320	400	480	560	640	720	800	880	960	
height (H)	1400	1600	1800	2000	2200	2400	2600	2800	3000		
Centre between the lateral connections 23/67 (R2)	1365	1565	1765	1965	2165	2365	2565	2765	2965		
Centre between the brackets	L-184	H-35									

ZANA HORIZONTAL (ZH-1, ZH-2)

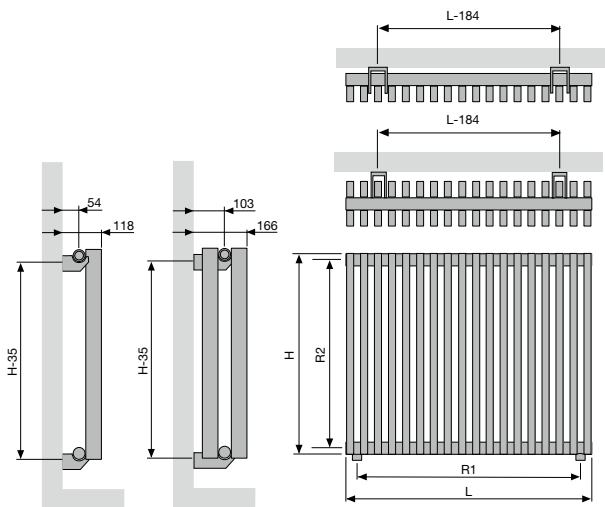

	ZH-1 / ZH-2																		
Width (L)	384	704	784	864	944	1024	1104	1184	1264	1424	1584	1744	1904	2064	2224	2384	2544	2704	2864
Centre between the connections at the bottom 18 (R1)	320	640	720	800	880	960	1040	1120	1200	1360	1520	1680	1840	2000	2160	2320	2480	2640	2800
height (H)	500	600	700																
Centre between the lateral connections 23/67 (R2)	465	565	665																
Centre between the brackets	L-184	H-35																	

VIOLA-A VERTICAL (V1-ZB-A, V1L1-ZB-A, V2-ZB-A)



TYPES

- V1-ZB-A single row of tubes, V2-ZB-A double row of tubes, V1L1-ZB-A with steel fins

TUBES

- Vertical, rectangular 77 x 10 mm

COLLECTORS

- V1-ZB-A: 35 x 43 mm
- V1L1-ZB-A: 35 x 43 mm
- V2-ZB-A: 35 x 41 mm

COLOURS

- Standard colour white RAL 9016
- Extensive colour chart see p. 10

SPECIAL

- Standard delivered with 2 lateral coverings.
- Connection mm only possible with even number of tubes.
- As to type V1L1-ZB-A, steel fins are welded at the back of the flat-oval tubes in order to increase the heat emission.

BRACKETS

- Wall brackets standard (included in packaging of radiator)
- Upper bracket in colour of radiator, bottom:
 - Distance keeper radiator white = distance keeper white.
 - Distance keeper radiator in colour = distance keeper RAL 7024.
- **V2-ZB-A:** Radiator with telescopic support feet + adjustable wall bracket: please indicate code **-0007** for "Finish" when ordering (see p. 221).

TECHNICAL

- Welded by means of resistance welding robots (invisible weld seams)
- ATL priming coat, powder coating
- Standard operating pressure: 4 bar. Extra charge for higher service pressures (10 bar): +10%.
- The delivery time of a radiator with a higher service pressure is 1 week extra.
- Maximum operating temperature: 110°C

ELECTRICAL

- ✗ Pure electrical radiator prefilled
- ✗ Mixed radiator

TECHNICAL DRAWINGS

- See p. 224

CONNECTION

- ✗ One-point connection for one-pipe system
- ✗ One-point connection for two-pipe system
- ✓ Two-point connection for one-pipe system (connection by way of the central connection) (see p. 312)
- ✓ Two-point connection for two-pipe system (standard) (see p. 312)
- ✗ Integrated valve
- Connections: ½" (inner thread)

VIOLA-A VERTICAL

The sobriety expresses class

A tubular radiator that blends seamlessly with any style of living, by its sober class and its natural design. The sleek front and the embedded side panels guarantee a uniform look and an optimum heat output. Viola-A. That is how simple, powerful and attractive heating can be.

RECOMMENDED CONNECTION (1008)

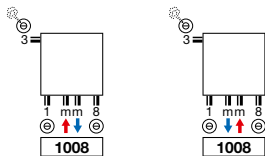

Connection mm only possible with even number of tubes

Other connection methods, see p. 223



ref. nr. 1182001 00009016
price €129
Fittings, see p. 327



ref. nr. 11911630102
price €44

RECOMMENDED FOR BATHROOM AND KITCHEN IN OPTION



towel rail (RAL 9005)
ref. nr. see p. 222
price €145

Other accessories, see p. 222



HOW TO ORDER VIOLA-A VERTICAL

Delivery time 15 - 30 working days
(transport duration not included)

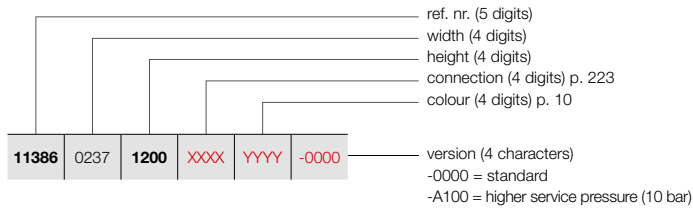

VIOLA-A VERTICAL (V1-ZB-A)



V1-ZB-A

HOW TO ORDER STOCK RADIATOR VIOLA-A VERTICAL

Delivery time 5 working days
(transport duration not included)

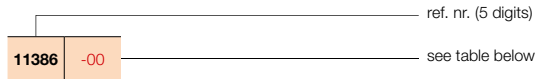

PRICE GROUP: VPG2 - STEEL DESIGN RADIATORS

REFERENCE CODE CUSTOM MADE VIOLA-A VERTICAL							TECHNICAL DATA					STANDARD COLOUR		OTHER COLOURS			
REF. NR.	width	height	75/65/20	55/45/20	n-exp.	weight	water	electr.	price	short ref. nr.	price						
11386	(L mm)	(H mm)	(Watt) (φ50K)	(Watt) (φ30K)		(kg)	content (l)	resistance (Watt)	RAL 9016 (€)	RAL 9016 stock	colour (€)						
REF. NR. VIOLA-A VERTICAL V1-ZB-A : 11386																	
11386	0237	1200	XXX	YYY	-0000	3	237	1200	371	189	1,32	7,80	2,40	-	325	-	374
		1400				3	237	1400	427	218	1,32	9,00	2,73	-	360	-	414
		1600				3	237	1600	483	246	1,32	9,90	3,03	-	386	-	444
		1800				3	237	1800	535	273	1,32	11,10	3,33	-	415	-	477
		2000				3	237	2000	589	301	1,30	12,30	3,60	-	444	-	511
		2200				3	237	2200	640	327	1,28	13,50	3,90	-	472	-	543
		2400				3	237	2400	689	352	1,27	14,40	4,20	-	500	-	575
11386	0317	1200	XXX	YYY	-0000	4	317	1200	480	245	1,31	10,40	3,20	-	386	-	444
		1400				4	317	1400	551	281	1,31	12,00	3,64	-	422	-	485
		1600				4	317	1600	624	318	1,31	13,20	4,04	-	460	-	529
		1800				4	317	1800	695	355	1,32	14,80	4,44	-	495	-	569
		2000				4	317	2000	764	390	1,30	16,40	4,80	-	531	-	611
		2200				4	317	2200	831	424	1,29	18,00	5,20	-	567	-	652
		2400				4	317	2400	894	456	1,27	19,20	5,60	-	604	-	695
11386	0397	1200	XXX	YYY	-0000	5	397	1200	585	298	1,31	13,00	4,00	-	443	-	509
		1400				5	397	1400	673	343	1,31	15,00	4,55	-	487	-	560
		1600				5	397	1600	762	389	1,31	16,50	5,05	-	531	-	611
		1800				5	397	1800	850	434	1,31	18,50	5,55	-	573	-	659
		2000				5	397	2000	936	478	1,30	20,50	6,00	-	619	-	712
		2200				5	397	2200	1017	519	1,29	22,50	6,50	-	664	-	764
		2400				5	397	2400	1094	558	1,28	24,00	7,00	-	705	-	811
11386	0477	1200	XXX	YYY	-0000	6	477	1200	689	352	1,31	15,60	4,80	-	500	-	575
		1400				6	477	1400	792	404	1,31	18,00	5,46	-	553	-	636
		1600				6	477	1600	897	458	1,31	19,80	6,06	-	604	-	695
		1800				6	477	1800	1003	512	1,31	22,20	6,66	-	657	-	756
		2000				6	477	2000	1104	563	1,30	24,60	7,20	-	705	11386-01	811
		2200				6	477	2200	1200	612	1,29	27,00	7,80	-	757	-	871
		2400				6	477	2400	1291	659	1,28	28,80	8,40	-	808	-	929
11386	0557	1200	XXX	YYY	-0000	7	557	1200	790	403	1,30	18,20	5,60	-	561	-	645
		1400				7	557	1400	909	464	1,31	21,00	6,37	-	619	-	712
		1600				7	557	1600	1029	525	1,31	23,10	7,07	-	676	-	777
		1800				7	557	1800	1154	589	1,31	25,90	7,77	-	738	-	849
		2000				7	557	2000	1269	647	1,30	28,70	8,40	-	791	-	910
		2200				7	557	2200	1380	704	1,29	31,50	9,10	-	852	-	980
		2400				7	557	2400	1485	758	1,28	33,60	9,80	-	909	-	1045
11386	0637	1200	XXX	YYY	-0000	8	637	1200	891	455	1,30	20,80	6,40	-	618	-	711
		1400				8	637	1400	1024	522	1,30	24,00	7,28	-	684	-	787
		1600				8	637	1600	1159	591	1,31	26,40	8,08	-	752	-	865
		1800				8	637	1800	1302	664	1,31	29,60	8,88	-	816	-	938
		2000				8	637	2000	1433	731	1,30	32,80	9,60	-	883	-	1015
		2200				8	637	2200	1557	794	1,29	36,00	10,40	-	946	-	1088
		2400				8	637	2400	1676	855	1,29	38,40	11,20	-	1011	-	1163

VASCO

In conformity with EN442-1: 2014: radiators and convectors

For heat outputs in other regimes, see p. 320 (correction factors)
EXPORT. Prices in Euro (excl. VAT)

VIOLA-A VERTICAL (V1-ZB-A)

HOW TO ORDER VIOLA-A VERTICAL

Delivery time 15 - 30 working days
(transport duration not included)



V1-ZB-A

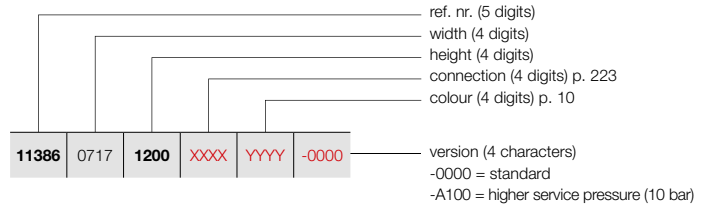

PRICE GROUP: VPG2 - STEEL DESIGN RADIATORS

REFERENCE CODE CUSTOM MADE VIOLA-A VERTICAL							TECHNICAL DATA					STANDARD COLOUR	OTHER COLOURS			
tubes	width (L mm)	height (H mm)	75/65/20 (Watt) (Φ50K)	55/45/20 (Watt) (Φ30K)	n-exp.	weight (kg)	water content (l)	electr. resistance (Watt)	price RAL 9016 (€)	price colour (€)						
REF. NR. VIOLA-A VERTICAL V1-ZB-A : 11386																
11386	0717	1200	XXXX	YYYY	-0000	9	717	1200	989	505	1,29	23,40	7,20	-	676	777
		1400				9	717	1400	1137	580	1,30	27,00	8,19	-	752	865
		1600				9	717	1600	1288	657	1,31	29,70	9,09	-	822	945
		1800				9	717	1800	1449	739	1,31	33,30	9,99	-	895	1029
		2000				9	717	2000	1594	813	1,30	36,90	10,80	-	968	1113
		2200				9	717	2200	1733	884	1,30	40,50	11,70	-	1043	1199
		2400				9	717	2400	1864	951	1,29	43,20	12,60	-	1115	1282
11386	0797	1200	XXXX	YYYY	-0000	10	797	1200	1087	555	1,29	26,00	8,00	-	734	844
		1400				10	797	1400	1249	637	1,30	30,00	9,10	-	816	938
		1600				10	797	1600	1414	721	1,30	33,00	10,10	-	895	1029
		1800				10	797	1800	1594	813	1,31	37,00	11,10	-	975	1121
		2000				10	797	2000	1754	895	1,31	41,00	12,00	-	1054	1212
		2200				10	797	2200	1906	972	1,30	45,00	13,00	-	1136	1306
		2400				10	797	2400	2051	1046	1,29	48,00	14,00	-	1216	1398
11386	0877	1200	XXXX	YYYY	-0000	11	877	1200	1183	604	1,28	28,60	8,80	-	791	910
		1400				11	877	1400	1360	694	1,29	33,00	10,01	-	881	1013
		1600				11	877	1600	1540	786	1,30	36,30	11,11	-	964	1109
		1800				11	877	1800	1738	887	1,31	40,70	12,21	-	1054	1212
		2000				11	877	2000	1912	976	1,31	45,10	13,20	-	1142	1313
		2200				11	877	2200	2078	1060	1,30	49,50	14,30	-	1229	1413
		2400				11	877	2400	2236	1141	1,29	52,80	15,40	-	1317	1515
11386	0957	1200	XXXX	YYYY	-0000	12	957	1200	1279	653	1,28	31,20	9,60	-	851	979
		1400				12	957	1400	1470	750	1,29	36,00	10,92	-	944	1086
		1600				12	957	1600	1664	849	1,30	39,60	12,12	-	1039	1195
		1800				12	957	1800	1881	960	1,31	44,40	13,32	-	1134	1304
		2000				12	957	2000	2069	1056	1,31	49,20	14,40	-	1229	1413
		2200				12	957	2200	2249	1147	1,30	54,00	15,60	-	1325	1524
		2400				12	957	2400	2420	1235	1,30	57,60	16,80	-	1420	1633
11386	1037	1200	XXXX	YYYY	-0000	13	1037	1200	1374	701	1,27	33,80	10,40	-	964	1109
		1400				13	1037	1400	1579	806	1,29	39,00	11,83	-	1075	1236
		1600				13	1037	1600	1788	912	1,30	42,90	13,13	-	1185	1363
		1800				13	1037	1800	2023	1032	1,31	48,10	14,43	-	1296	1490
		2000				13	1037	2000	2225	1135	1,31	53,30	15,60	-	1402	1612
		2200				13	1037	2200	2418	1234	1,30	58,50	16,90	-	1515	1742
		2400				13	1037	2400	2602	1328	1,30	62,40	18,20	-	1623	1866

In conformity with EN442-1: 2014: radiators and convectors

For heat outputs in other regimes, see p. 320 (correction factors)
EXPORT. Prices in Euro (excl. VAT)

HOW TO ORDER VIOLA-A VERTICAL

 Delivery time 15 - 30 working days
 (transport duration not included)

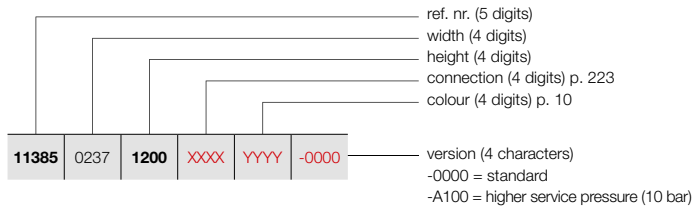
VIOLA-A VERTICAL (V1L1-ZB-A)

V1L1-ZB-A

PRICE GROUP: VPG2 - STEEL DESIGN RADIATORS

REFERENCE CODE CUSTOM MADE VIOLA-A VERTICAL							TECHNICAL DATA					STANDARD COLOUR	OTHER COLOURS			
tubes	width (L mm)	height (H mm)	75/65/20 (Watt) (Ø50K)	55/45/20 (Watt) (Ø30K)	n-exp.	weight (kg)	water content (l)	electr. resistance (Watt)	price RAL 9016 (€)	price colour (€)						
REF. NR. VIOLA-A VERTICAL V1L1-ZB-A: 11385																
11385	0237	1200	XXXX	YYYY	-0000	3	237	1200	464	237	1,28	10,50	2,40	-	408	469
		1400				3	237	1400	531	271	1,28	12,60	2,73	-	446	513
		1600				3	237	1600	597	305	1,29	14,40	3,03	-	483	555
		1800				3	237	1800	661	337	1,29	15,90	3,33	-	521	599
		2000				3	237	2000	723	369	1,30	18,30	3,60	-	556	639
		2200				3	237	2200	784	400	1,32	19,80	3,90	-	594	683
		2400				3	237	2400	843	430	1,33	21,60	4,20	-	630	725
11385	0317	1200	XXXX	YYYY	-0000	4	317	1200	605	309	1,28	14,00	3,20	-	483	555
		1400				4	317	1400	693	354	1,29	16,80	3,64	-	529	608
		1600				4	317	1600	778	397	1,29	19,20	4,04	-	572	658
		1800				4	317	1800	861	439	1,29	21,20	4,44	-	619	712
		2000				4	317	2000	943	481	1,31	24,40	4,80	-	665	765
		2200				4	317	2200	1022	521	1,32	26,40	5,20	-	708	814
		2400				4	317	2400	1099	561	1,33	28,80	5,60	-	756	869
11385	0397	1200	XXXX	YYYY	-0000	5	397	1200	743	379	1,29	17,50	4,00	-	554	637
		1400				5	397	1400	851	434	1,29	21,00	4,55	-	609	700
		1600				5	397	1600	956	488	1,29	24,00	5,05	-	665	765
		1800				5	397	1800	1058	540	1,30	26,50	5,55	-	718	826
		2000				5	397	2000	1158	591	1,31	30,50	6,00	-	774	890
		2200				5	397	2200	1255	640	1,32	33,00	6,50	-	828	952
		2400				5	397	2400	1350	689	1,33	36,00	7,00	-	886	1019
11385	0477	1200	XXXX	YYYY	-0000	6	477	1200	879	448	1,29	21,00	4,80	-	630	725
		1400				6	477	1400	1007	514	1,29	25,20	5,46	-	693	797
		1600				6	477	1600	1131	577	1,30	28,80	6,06	-	756	869
		1800				6	477	1800	1252	639	1,30	31,80	6,66	-	821	944
		2000				6	477	2000	1370	699	1,31	36,60	7,20	-	886	1019
		2200				6	477	2200	1485	758	1,32	39,60	7,80	-	947	1089
		2400				6	477	2400	1598	815	1,33	43,20	8,40	-	1011	1163
11385	0557	1200	XXXX	YYYY	-0000	7	557	1200	1013	517	1,29	24,50	5,60	-	701	806
		1400				7	557	1400	1160	592	1,30	29,40	6,37	-	774	890
		1600				7	557	1600	1303	665	1,30	33,60	7,07	-	848	975
		1800				7	557	1800	1443	736	1,31	37,10	7,77	-	920	1058
		2000				7	557	2000	1579	806	1,31	42,70	8,40	-	993	1142
		2200				7	557	2200	1712	873	1,32	46,20	9,10	-	1066	1226
		2400				7	557	2400	1841	939	1,33	50,40	9,80	-	1139	1310
11385	0637	1200	XXXX	YYYY	-0000	8	637	1200	1146	585	1,29	28,00	6,40	-	773	889
		1400				8	637	1400	1312	669	1,30	33,60	7,28	-	855	983
		1600				8	637	1600	1474	752	1,31	38,40	8,08	-	936	1076
		1800				8	637	1800	1632	833	1,31	42,40	8,88	-	1018	1171
		2000				8	637	2000	1786	911	1,32	48,80	9,60	-	1103	1268
		2200				8	637	2200	1936	988	1,32	52,80	10,40	-	1183	1360
		2400				8	637	2400	2083	1063	1,33	57,60	11,20	-	1266	1456

In conformity with EN442-1: 2014: radiators and convectors

For heat outputs in other regimes, see p. 320 (correction factors)
EXPORT. Prices in Euro (excl. VAT)
VASCO

VIOLA-A VERTICAL (V1L1-ZB-A)

HOW TO ORDER VIOLA-A VERTICAL
 Delivery time 15 - 30 working days
 (transport duration not included)

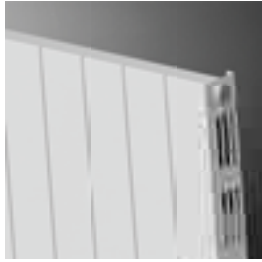

V1L1-ZB-A

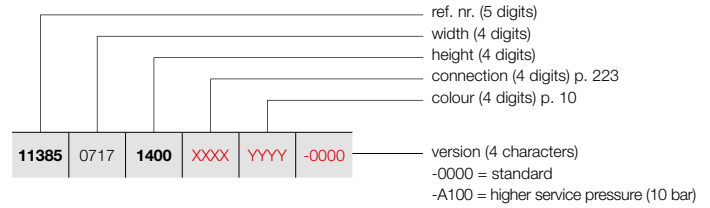

PRICE GROUP: VPG2 - STEEL DESIGN RADIATORS

REFERENCE CODE CUSTOM MADE VIOLA-A VERTICAL							TECHNICAL DATA					STANDARD COLOUR	OTHER COLOURS			
tubes	width (L mm)	height (H mm)	75/65/20 (Watt) (φ50K)	55/45/20 (Watt) (φ30K)	n-exp.	weight (kg)	water content (l)	electr. resistance (Watt)	price RAL 9016 (€)	price colour (€)						
REF. NR. VIOLA-A VERTICAL V1L1-ZB-A : 11385																
11385	0717	1400	XXXX	YYYY	-0000	9	717	1400	1462	746	1,30	37,80	8,19	-	936	1076
		1600				9	717	1600	1643	838	1,31	43,20	9,09	-	1027	1181
		1800				9	717	1800	1819	928	1,32	47,70	9,99	-	1119	1287
		2000				9	717	2000	1990	1015	1,32	54,90	10,80	-	1213	1395
		2200				9	717	2200	2158	1101	1,32	59,40	11,70	-	1300	1495
		2400				9	717	2400	2321	1184	1,33	64,80	12,60	-	1391	1600
11385	0797	1200	XXXX	YYYY	-0000	10	797	1200	1407	718	1,30	35,00	8,00	-	919	1057
		1400				10	797	1400	1611	822	1,31	42,00	9,10	-	1018	1171
		1600				10	797	1600	1810	923	1,31	48,00	10,10	-	1119	1287
		1800				10	797	1800	2004	1022	1,32	53,00	11,10	-	1220	1403
		2000				10	797	2000	2194	1119	1,32	61,00	12,00	-	1317	1515
		2200				10	797	2200	2387	1218	1,32	66,00	13,00	-	1420	1633
		2400				10	797	2400	2558	1305	1,33	72,00	14,00	-	1522	1750
11385	0877	1200	XXXX	YYYY	-0000	11	877	1200	1536	784	1,30	38,50	8,80	-	993	1142
		1400				11	877	1400	1759	897	1,31	46,20	10,01	-	1099	1264
		1600				11	877	1600	1976	1008	1,32	52,80	11,11	-	1211	1393
		1800				11	877	1800	2189	1117	1,32	58,30	12,21	-	1317	1515
		2000				11	877	2000	2394	1221	1,33	67,10	13,20	-	1427	1641
		2200				11	877	2200	2596	1324	1,33	72,60	14,30	-	1537	1768
		2400				11	877	2400	2792	1424	1,33	79,20	15,40	-	1648	1895
11385	0957	1200	XXXX	YYYY	-0000	12	957	1200	1665	849	1,31	42,00	9,60	-	1063	1222
		1400				12	957	1400	1907	973	1,31	50,40	10,92	-	1180	1357
		1600				12	957	1600	2142	1093	1,32	57,60	12,12	-	1299	1494
		1800				12	957	1800	2371	1210	1,33	63,60	13,32	-	1419	1632
		2000				12	957	2000	2595	1324	1,33	73,20	14,40	-	1537	1768
		2200				12	957	2200	2813	1435	1,33	79,20	15,60	-	1656	1904
		2400				12	957	2400	3026	1544	1,33	86,40	16,80	-	1777	2044
11385	1037	1200	XXXX	YYYY	-0000	13	1037	1200	1792	914	1,31	45,50	10,40	-	1211	1393
		1400				13	1037	1400	2052	1047	1,32	54,60	11,83	-	1345	1547
		1600				13	1037	1600	2306	1177	1,33	62,40	13,13	-	1484	1707
		1800				13	1037	1800	2552	1302	1,33	68,90	14,43	-	1618	1861
		2000				13	1037	2000	2793	1425	1,33	79,30	15,60	-	1755	2018
		2200				13	1037	2200	3028	1545	1,33	85,80	16,90	-	1892	2176
		2400				13	1037	2400	3257	1662	1,33	93,60	18,20	-	2031	2336

In conformity with EN442-1: 2014: radiators and convectors

For heat outputs in other regimes, see p. 320 (correction factors)
 EXPORT. Prices in Euro (excl. VAT)

HOW TO ORDER VIOLA-A VERTICAL

Delivery time 15 - 30 working days
(transport duration not included)

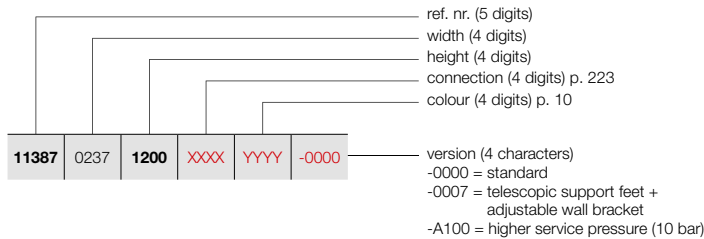

VIOLA-A VERTICAL (V2-ZB-A)



V2-ZB-A

HOW TO ORDER STOCK RADIATOR VIOLA-A VERTICAL

Delivery time 5 working days
(transport duration not included)

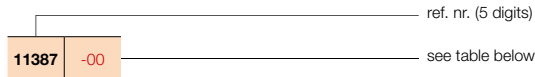

PRICE GROUP: VPG2 - STEEL DESIGN RADIATORS

REFERENCE CODE CUSTOM MADE VIOLA-A VERTICAL							TECHNICAL DATA						STANDARD COLOUR		OTHER COLOURS		
							tubes	width (L mm)	height (H mm)	75/65/20 (Watt) (Φ50K)	55/45/20 (Watt) (Φ30K)	n-exp.	weight (kg)	water content (l)	electr. resistance (Watt)	price RAL 9016 (€)	short ref. nr. RAL 9016 stock
REF. NR. VIOLA-A VERTICAL V2-ZB-A : 11387																	
11387	0237	1200	XXXX	YYYY	-0000	3	237	1200	509	260	1,33	14,40	4,59	-	556	-	639
		1400				3	237	1400	587	299	1,34	16,80	5,04	-	607	-	698
		1600				3	237	1600	664	339	1,35	18,90	5,52	-	657	-	756
		1800				3	237	1800	743	379	1,35	21,30	5,97	-	704	-	810
		2000				3	237	2000	821	419	1,35	23,40	6,39	-	756	-	869
		2200				3	237	2200	900	459	1,34	25,80	6,81	-	806	-	927
		2400				3	237	2400	979	499	1,34	28,20	7,23	-	855	-	983
11387	0317	1200	XXXX	YYYY	-0000	4	317	1200	655	334	1,33	19,20	6,12	-	657	-	756
		1400				4	317	1400	755	385	1,34	22,40	6,72	-	718	-	826
		1600				4	317	1600	854	436	1,35	25,20	7,36	-	783	-	900
		1800				4	317	1800	952	486	1,35	28,40	7,96	-	841	-	967
		2000				4	317	2000	1050	536	1,35	31,20	8,52	-	903	-	1038
		2200				4	317	2200	1147	585	1,35	34,40	9,08	-	963	-	1107
		2400				4	317	2400	1244	635	1,34	37,60	9,64	-	1027	-	1181
11387	0397	1200	XXXX	YYYY	-0000	5	397	1200	802	409	1,33	24,00	7,65	-	755	-	868
		1400				5	397	1400	923	471	1,34	28,00	8,40	-	831	-	956
		1600				5	397	1600	1043	532	1,35	31,50	9,20	-	903	-	1038
		1800				5	397	1800	1162	593	1,36	35,50	9,95	-	980	-	1127
		2000				5	397	2000	1279	653	1,35	39,00	10,65	-	1053	-	1211
		2200				5	397	2200	1394	711	1,35	43,00	11,35	-	1125	-	1294
		2400				5	397	2400	1509	770	1,34	47,00	12,05	-	1202	-	1382
11387	0477	1200	XXXX	YYYY	-0000	6	477	1200	948	484	1,34	28,80	9,18	-	855	-	983
		1400				6	477	1400	1092	557	1,34	33,60	10,08	-	940	-	1081
		1600				6	477	1600	1232	629	1,35	37,80	11,04	-	1027	-	1181
		1800				6	477	1800	1371	699	1,36	42,60	11,94	-	1117	-	1285
		2000				6	477	2000	1507	769	1,35	46,80	12,78	-	1202	-	1382
		2200				6	477	2200	1642	838	1,35	51,60	13,62	-	1292	-	1486
		2400				6	477	2400	1775	906	1,34	56,40	14,46	-	1375	-	1581
11387	0557	1200	XXXX	YYYY	-0000	7	557	1200	1094	558	1,34	33,60	10,71	-	954	-	1097
		1400				7	557	1400	1260	643	1,34	39,20	11,76	-	1053	-	1211
		1600				7	557	1600	1422	726	1,35	44,10	12,88	-	1151	-	1324
		1800				7	557	1800	1580	806	1,36	49,70	13,93	-	1251	-	1439
		2000				7	557	2000	1736	886	1,36	54,60	14,91	-	1347	-	1549
		2200				7	557	2200	1889	964	1,35	60,20	15,89	-	1447	-	1664
		2400				7	557	2400	2040	1041	1,35	65,80	16,87	-	1549	-	1781
11387	0637	1200	XXXX	YYYY	-0000	8	637	1200	1240	633	1,34	38,40	12,24	-	1051	-	1209
		1400				8	637	1400	1428	729	1,35	44,80	13,44	-	1161	-	1335
		1600				8	637	1600	1611	822	1,35	50,40	14,72	-	1273	-	1464
		1800				8	637	1800	1790	913	1,36	56,80	15,92	-	1387	-	1595
		2000				8	637	2000	1965	1003	1,36	62,40	17,04	-	1496	11387-01	1720
		2200				8	637	2200	2136	1090	1,35	68,80	18,16	-	1609	-	1850
		2400				8	637	2400	2305	1176	1,35	75,20	19,28	-	1719	-	1977

In conformity with EN442-1: 2014: radiators and convectors

For heat outputs in other regimes, see p. 320 (correction factors)
EXPORT. Prices in Euro (excl. VAT)

VASCO

VIOLA-A VERTICAL (V2-ZB-A)



V2-ZB-A

HOW TO ORDER VIOLA-A VERTICAL

Delivery time 15 - 30 working days
(transport duration not included)

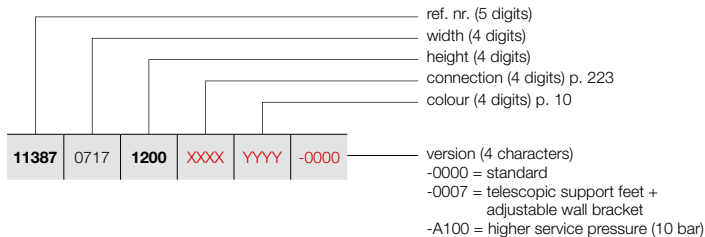

PRICE GROUP: VPG2 - STEEL DESIGN RADIATORS

REFERENCE CODE CUSTOM MADE VIOLA-A VERTICAL	TECHNICAL DATA									STANDARD COLOUR price RAL 9016 (€)	OTHER COLOURS price colour (€)					
	tubes	width (L mm)	height (H mm)	75/65/20 (Watt) (Φ50K)	55/45/20 (Watt) (Φ30K)	n-exp.	weight (kg)	water content (l)	electr. resistance (Watt)							
REF. NR. VIOLA-A VERTICAL V2-ZB-A : 11387																
11387	0717	1200	XXXX	YYYY	-0000	9	717	1200	1387	708	1,34	43,20	13,77	-	1151	1324
		1400				9	717	1400	1596	814	1,35	50,40	15,12	-	1273	1464
		1600				9	717	1600	1801	919	1,36	56,70	16,56	-	1398	1608
		1800				9	717	1800	1999	1020	1,36	63,90	17,91	-	1523	1751
		2000				9	717	2000	2194	1119	1,36	70,20	19,17	-	1647	1894
		2200				9	717	2200	2384	1216	1,35	77,40	20,43	-	1769	2034
		2400				9	717	2400	2570	1311	1,35	84,60	21,69	-	1893	2177
11387	0797	1200	XXXX	YYYY	-0000	10	797	1200	1533	782	1,34	48,00	15,30	-	1245	1432
		1400				10	797	1400	1765	901	1,35	56,00	16,80	-	1387	1595
		1600				10	797	1600	1990	1015	1,36	63,00	18,40	-	1523	1751
		1800				10	797	1800	2209	1127	1,37	71,00	19,90	-	1658	1907
		2000				10	797	2000	2422	1236	1,36	78,00	21,30	-	1793	2062
		2200				10	797	2200	2631	1342	1,36	86,00	22,70	-	1930	2220
		2400				10	797	2400	2836	1447	1,35	94,00	24,10	-	2067	2377
11387	0877	1200	XXXX	YYYY	-0000	11	877	1200	1679	857	1,34	52,80	16,83	-	1347	1549
		1400				11	877	1400	1933	986	1,35	61,60	18,48	-	1494	1718
		1600				11	877	1600	2179	1112	1,36	69,30	20,24	-	1645	1892
		1800				11	877	1800	2418	1234	1,37	78,10	21,89	-	1793	2062
		2000				11	877	2000	2651	1353	1,36	85,80	23,43	-	1942	2233
		2200				11	877	2200	2878	1468	1,36	94,60	24,97	-	2090	2404
		2400				11	877	2400	3101	1582	1,35	103,40	26,51	-	2240	2576
11387	0957	1200	XXXX	YYYY	-0000	12	957	1200	1825	931	1,35	57,60	18,36	-	1445	1662
		1400				12	957	1400	2101	1072	1,35	67,20	20,16	-	1603	1843
		1600				12	957	1600	2369	1209	1,36	75,60	22,08	-	1765	2030
		1800				12	957	1800	2628	1341	1,37	85,20	23,88	-	1929	2218
		2000				12	957	2000	2880	1469	1,36	93,60	25,56	-	2090	2404
		2200				12	957	2200	3126	1595	1,36	103,20	27,24	-	2251	2589
		2400				12	957	2400	3366	1717	1,36	112,80	28,92	-	2414	2776
11387	1037	1200	XXXX	YYYY	-0000	13	1037	1200	1972	1006	1,35	62,40	19,89	-	1645	1892
		1400				13	1037	1400	2270	1158	1,36	72,80	21,84	-	1827	2101
		1600				13	1037	1600	2558	1305	1,36	81,90	23,92	-	2014	2316
		1800				13	1037	1800	2837	1447	1,37	92,30	25,87	-	2199	2529
		2000				13	1037	2000	3109	1586	1,37	101,40	27,69	-	2387	2745
		2200				13	1037	2200	3373	1721	1,36	111,80	29,51	-	2573	2959
		2400				13	1037	2400	3631	1853	1,36	122,20	31,33	-	2760	3174

In conformity with EN442-1: 2014: radiators and convectors

For heat outputs in other regimes, see p. 320 (correction factors)
EXPORT. Prices in Euro (excl. VAT)

VIOLA-A HORIZONTAL (H1-RO-A, H1L1-RO-A, H2-RO-A, H2L1-RO-A, H2L2-RO-A)

TYPES

- H1-RO-A single row of tubes, H2-RO-A double row of tubes, H1L1-RO-A, H2L1-RO-A, H2L2-RO-A (1 or 2 rows of steel fins)



TUBES

- Horizontal, rectangular 77 x 10 mm

COLLECTORS

- H1-RO-A and H1L1-RO-A: 35 x 43 mm
- H2-RO-A and H2L1-RO-A: 35 x 41 mm
- H2L2-RO-A: 35 x 81 mm

COLOURS

- Standard colour white RAL 9016
- Extensive colour chart see p. 10

SPECIAL

- As to type HL-RO, 1 or 2 steel fins are welded at the back of the flat-oval tubes in order to increase the heat emission.
- Standard with grill.
- H1L1-RO-A also available as toilet radiator (500 x 400 mm)

BRACKETS

- Wall brackets standard (included in packaging of radiator)
- Upper bracket in colour of radiator, bottom:
 - Distance keeper radiator white = distance keeper white.
 - Distance keeper radiator in colour = distance keeper RAL 7024.
- **H2-RO-A/H2L1-RO-A:** Radiator with telescopic support feet + adjustable wall bracket: please indicate code **-0007** for "Finish" when ordering (see p. 220).
- **H2-RO-A/H2L1-RO-A:** Also available as free-standing radiator (see p. 221)

TECHNICAL

- Welded by means of resistance welding robots (invisible weld seams)
- ATL priming coat, powder coating
- Standard operating pressure: 4 bar. Extra charge for higher service pressures (10 bar): +10%.
- The delivery time of a radiator with a higher service pressure is 1 week extra.
- Maximum operating temperature: 110°C

ELECTRICAL

- ✗ Pure electrical radiator prefilled
- ✗ Mixed radiator

TECHNICAL DRAWINGS

- See p. 225

CONNECTION

- ✗ One-point connection for one-pipe system
- ✗ One-point connection for two-pipe system
- ✓ Two-point connection for one-pipe system (connection by way of the integrated valve) (see p. 313)
- ✓ Two-point connection for two-pipe system (standard) (see p. 312)
- ✓ Integrated valve (**extra charge €113**) (order as special radiator) (see p. 313)
- Connections: 1/2" (inner thread)



VASCO

VIOLA-A HORIZONTAL

Following a great tradition

Just like the Viola-A Vertical, the Viola-A Horizontal combines a sober, uniform look with optimal heat output. The radiator is available as a single or double. The simple design fits anywhere. It can also be installed as a free-standing model.

RECOMMENDED CONNECTION INTEGRATED VALVE (SUPPLEMENT)

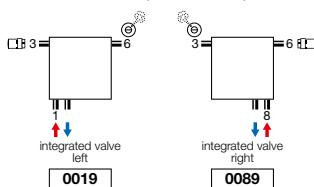

Supplement: **€113** (see p. 313)
Other connection methods, see p. 223
Thermostatic head to be ordered separately



ref. nr. 118230100000099
price **€147**
Fittings, see p. 327



ref. nr. 11911630102
price **€44**
Thermostatic head to be ordered separately

RECOMMENDED FOR BATHROOM AND KITCHEN IN OPTION



towel rail (RAL 9005)
ref. nr. see p. 222
price **€145**
Other accessories, see p. 222



H2-RO-A / H2L1-RO-A

VIOLA-A HORIZONTAL (H1-RO-A)



H1-RO-A
(thermostatic head to be ordered separately)

HOW TO ORDER VIOLA-A HORIZONTAL

Delivery time 15 - 30 working days
(transport duration not included)

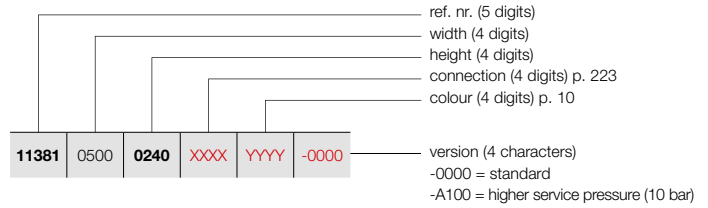

PRICE GROUP: VPG2 - STEEL DESIGN RADIATORS

REFERENCE CODE CUSTOM MADE VIOLA-A HORIZONTAL							TECHNICAL DATA					STANDARD COLOUR	OTHER COLOURS			
tubes	width (L mm)	height (H mm)	75/65/20 (Watt) (φ50K)	55/45/20 (Watt) (φ30K)	n-exp.	weight (kg)	water content (l)	electr. resistance (Watt)	price RAL 9016 (€)	price colour (€)						
REF. NR. VIOLA-A HORIZONTAL H1-RO-A : 11381																
11381	0500	0240	XXXX	YYYY	-0000	3	500	240	141	72	1,25	3,15	1,00	-	246	283
		0320				4	500	320	179	91	1,25	3,25	1,40	-	278	320
		0400				5	500	400	223	114	1,26	5,50	1,70	-	311	358
		0480				6	500	480	266	136	1,26	6,60	2,05	-	343	394
		0560				7	500	560	310	158	1,26	7,70	2,40	-	377	434
		0640				8	500	640	353	180	1,26	8,80	2,75	-	408	469
		0720				9	500	720	396	202	1,26	9,90	3,10	-	442	508
		0800				10	500	800	438	223	1,26	11,00	3,50	-	472	543
		0880				11	500	880	481	245	1,27	12,10	3,85	-	509	585
11381	0600	0240	XXXX	YYYY	-0000	3	600	240	169	86	1,25	3,78	1,20	-	262	301
		0320				4	600	320	215	110	1,25	3,90	1,68	-	301	346
		0400				5	600	400	267	136	1,26	6,60	2,04	-	337	388
		0480				6	600	480	319	163	1,26	7,92	2,46	-	375	431
		0560				7	600	560	371	189	1,26	9,24	2,88	-	410	472
		0640				8	600	640	423	216	1,26	10,56	3,30	-	446	513
		0720				9	600	720	475	242	1,26	11,88	3,72	-	483	555
		0800				10	600	800	526	268	1,26	13,20	4,20	-	522	600
		0880				11	600	880	577	294	1,27	14,52	4,62	-	556	639
11381	0700	0240	XXXX	YYYY	-0000	3	700	240	197	100	1,25	4,41	1,40	-	287	330
		0320				4	700	320	251	128	1,25	4,55	1,96	-	324	373
		0400				5	700	400	312	159	1,26	7,70	2,38	-	365	420
		0480				6	700	480	372	190	1,26	9,24	2,87	-	405	466
		0560				7	700	560	433	221	1,26	10,78	3,36	-	444	511
		0640				8	700	640	494	252	1,26	12,32	3,85	-	485	558
		0720				9	700	720	554	283	1,26	13,86	4,34	-	527	606
		0800				10	700	800	613	313	1,26	15,40	4,90	-	565	650
		0880				11	700	880	673	343	1,27	16,94	5,39	-	606	697
11381	0800	0240	XXXX	YYYY	-0000	3	800	240	225	115	1,25	5,04	1,60	-	307	353
		0320				4	800	320	286	146	1,25	5,20	2,24	-	351	404
		0400				5	800	400	356	182	1,26	8,80	2,72	-	392	451
		0480				6	800	480	426	217	1,26	10,56	3,28	-	437	503
		0560				7	800	560	495	253	1,26	12,32	3,84	-	480	552
		0640				8	800	640	564	288	1,26	14,08	4,40	-	524	603
		0720				9	800	720	633	323	1,26	15,84	4,96	-	567	652
		0800				10	800	800	701	358	1,26	17,60	5,60	-	609	700
		0880				11	800	880	769	392	1,27	19,36	6,16	-	656	754
11381	0900	0240	XXXX	YYYY	-0000	3	900	240	253	129	1,25	5,67	1,80	-	324	373
		0320				4	900	320	322	164	1,25	5,85	2,52	-	374	430
		0400				5	900	400	401	204	1,26	9,90	3,06	-	420	483
		0480				6	900	480	479	244	1,26	11,88	3,69	-	468	538
		0560				7	900	560	557	284	1,26	13,86	4,32	-	516	593
		0640				8	900	640	635	324	1,26	15,84	4,95	-	563	647
		0720				9	900	720	712	363	1,26	17,82	5,58	-	608	699
		0800				10	900	800	788	402	1,26	19,80	6,30	-	658	757
		0880				11	900	880	865	441	1,27	21,78	6,93	-	703	808

In conformity with EN442-1: 2014: radiators and convectors

For heat outputs in other regimes, see p. 320 (correction factors)
EXPORT. Prices in Euro (excl. VAT)

HOW TO ORDER VIOLA-A HORIZONTAL

Delivery time 15 - 30 working days
(transport duration not included)

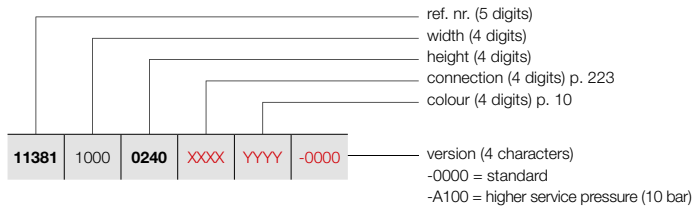

11381	1000	0240	XXXX	YYYY	-0000
-------	------	------	------	------	-------

VIOLA-A HORIZONTAL (H1-RO-A)



H1-RO-A
(thermostatic head to be ordered separately)

PRICE GROUP: VPG2 - STEEL DESIGN RADIATORS

REFERENCE CODE CUSTOM MADE VIOLA-A HORIZONTAL	TECHNICAL DATA									STANDARD COLOUR price RAL 9016 (€)	OTHER COLOURS price colour (€)										
	tubes	width (L mm)	height (H mm)	75/65/20 (Watt) (Φ50K)	55/45/20 (Watt) (Φ30K)	n-exp.	weight (kg)	water content (l)	electr. resistance (Watt)												
REF. NR. VIOLA-A HORIZONTAL H1-RO-A : 11381																					
11381	1000	0240	XXXX	YYYY	-0000	3	1000	240	281	143	1,25	6,30	2,00	-	345	397					
		0320				4	1000	320	358	183	1,25	6,50	2,80	-	394	453					
		0400				5	1000	400	445	227	1,26	11,00	3,40	-	446	513					
		0480				6	1000	480	532	271	1,26	13,20	4,10	-	497	572					
		0560				7	1000	560	619	316	1,26	15,40	4,80	-	549	631					
		0640				8	1000	640	705	360	1,26	17,60	5,50	-	600	690					
		0720				9	1000	720	791	404	1,26	19,80	6,20	-	650	748					
		0800				10	1000	800	876	447	1,26	22,00	7,00	-	702	807					
		0880				11	1000	880	961	490	1,27	24,20	7,70	-	754	867					
		11381				1100	0240	XXXX	YYYY	-0000	3	1100	240	309	158	1,25	6,93	2,20	-	365	420
							0320				4	1100	320	394	201	1,25	7,15	3,08	-	420	483
0400	5		1100	400	490		250				1,26	12,10	3,74	-	472	543					
0480	6		1100	480	585		299				1,26	14,52	4,51	-	530	610					
0560	7		1100	560	681		347				1,26	16,94	5,28	-	585	673					
0640	8		1100	640	776		396				1,26	19,36	6,05	-	637	733					
0720	9		1100	720	870		444				1,26	21,78	6,82	-	694	798					
0800	10		1100	800	964		492				1,26	24,20	7,70	-	750	863					
0880	11		1100	880	1057		539				1,27	26,62	8,47	-	802	922					
11381	1200		0240	XXXX	YYYY		-0000				3	1200	240	337	172	1,25	7,56	2,40	-	384	442
			0320								4	1200	320	430	219	1,25	7,80	3,36	-	443	509
		0400	5			1200		400	534	272	1,26	13,20	4,08	-	500	575					
		0480	6			1200		480	638	326	1,26	15,84	4,92	-	561	645					
		0560	7			1200		560	743	379	1,26	18,48	5,76	-	619	712					
		0640	8			1200		640	846	432	1,26	21,12	6,60	-	676	777					
		0720	9			1200		720	949	484	1,26	23,76	7,44	-	738	849					
		0800	10			1200		800	1051	536	1,26	26,40	8,40	-	791	910					
		0880	11			1200		880	1153	588	1,27	29,04	9,24	-	852	980					
		11381	1400			0240		XXXX	YYYY	-0000	3	1400	240	393	201	1,25	8,82	2,80	-	423	486
						0320					4	1400	320	501	256	1,25	9,10	3,92	-	490	564
0400	5			1400	400	623	318				1,26	15,40	4,76	-	556	639					
0480	6			1400	480	745	380				1,26	18,48	5,74	-	623	716					
0560	7			1400	560	867	442				1,26	21,56	6,72	-	687	790					
0640	8			1400	640	987	504				1,26	24,64	7,70	-	754	867					
0720	9			1400	720	1107	565				1,26	27,72	8,68	-	819	942					
0800	10			1400	800	1226	626				1,26	30,80	9,80	-	887	1020					
0880	11			1400	880	1345	686				1,27	33,88	10,78	-	953	1096					
11381	1600			0240	XXXX	YYYY	-0000				3	1600	240	450	229	1,25	10,08	3,20	-	464	534
				0320							4	1600	320	573	292	1,25	10,40	4,48	-	537	618
		0400	5	1600				400	712	363	1,26	17,60	5,44	-	609	700					
		0480	6	1600				480	851	434	1,26	21,12	6,56	-	684	787					
		0560	7	1600				560	990	505	1,26	24,64	7,68	-	757	871					
		0640	8	1600				640	1128	576	1,26	28,16	8,80	-	831	956					
		0720	9	1600				720	1266	646	1,26	31,68	9,92	-	903	1038					
		0800	10	1600				800	1402	715	1,26	35,20	11,20	-	976	1122					
		0880	11	1600				880	1538	784	1,27	38,72	12,32	-	1051	1209					

In conformity with EN442-1: 2014: radiators and convectors

For heat outputs in other regimes, see p. 320 (correction factors)
EXPORT. Prices in Euro (excl. VAT)

VASCO

VIOLA-A HORIZONTAL (H1-RO-A)



H1-RO-A
(thermostatic head to be ordered separately)

HOW TO ORDER VIOLA-A HORIZONTAL

Delivery time 15 - 30 working days
(transport duration not included)

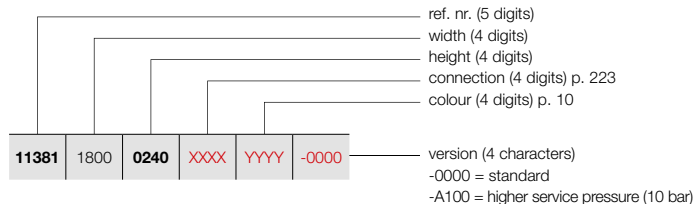

PRICE GROUP: VPG2 - STEEL DESIGN RADIATORS

REFERENCE CODE CUSTOM MADE VIOLA-A HORIZONTAL							TECHNICAL DATA					STANDARD COLOUR	OTHER COLOURS								
tubes	width (L mm)	height (H mm)	75/65/20 (Watt) (Φ50K)	55/45/20 (Watt) (Φ30K)	n-exp.	weight (kg)	water content (l)	electr. resistance (Watt)	price RAL 9016 (€)	price colour (€)											
REF. NR. VIOLA-A HORIZONTAL H1-RO-A : 11381																					
11381	1800	0240	XXXX	YYYY	-0000	3	1800	240	506	258	1,25	11,34	3,60	-	505	581					
		0320				4	1800	320	644	329	1,25	11,70	5,04	-	586	674					
		0400				5	1800	400	801	409	1,26	19,80	6,12	-	667	767					
		0480				6	1800	480	958	489	1,26	23,76	7,38	-	747	859					
		0560				7	1800	560	1114	568	1,26	27,72	8,64	-	827	951					
		0640				8	1800	640	1269	647	1,26	31,68	9,90	-	905	1041					
		0720				9	1800	720	1424	726	1,26	35,64	11,16	-	989	1137					
		0800				10	1800	800	1577	804	1,26	39,60	12,60	-	1068	1228					
		0880				11	1800	880	1730	883	1,27	43,56	13,86	-	1149	1321					
		11381				2000	0240	XXXX	YYYY	-0000	3	2000	240	562	287	1,25	12,60	4,00	-	542	623
							0320				4	2000	320	716	365	1,25	13,00	5,60	-	632	727
0400	5		2000	400	890		454				1,26	22,00	6,80	-	718	826					
0480	6		2000	480	1064		543				1,26	26,40	8,20	-	807	928					
0560	7		2000	560	1238		632				1,26	30,80	9,60	-	895	1029					
0640	8		2000	640	1410		719				1,26	35,20	11,00	-	982	1129					
0720	9		2000	720	1582		807				1,26	39,60	12,40	-	1070	1231					
0800	10		2000	800	1752		894				1,26	44,00	14,00	-	1157	1331					
0880	11		2000	880	1922		981				1,27	48,40	15,40	-	1244	1431					
11381	2200		0240	XXXX	YYYY		-0000				3	2200	240	618	315	1,25	13,86	4,40	-	585	673
			0320								4	2200	320	788	402	1,25	14,30	6,16	-	680	782
		0400	5			2200		400	979	499	1,26	24,20	7,48	-	775	891					
		0480	6			2200		480	1170	597	1,26	29,04	9,02	-	866	996					
		0560	7			2200		560	1362	695	1,26	33,88	10,56	-	963	1107					
		0640	8			2200		640	1551	791	1,26	38,72	12,10	-	1059	1218					
		0720	9			2200		720	1740	888	1,26	43,56	13,64	-	1155	1328					
		0800	10			2200		800	1927	983	1,26	48,40	15,40	-	1248	1435					
		0880	11			2200		880	2114	1079	1,27	53,24	16,94	-	1345	1547					
		11381	2400			0240		XXXX	YYYY	-0000	3	2400	240	674	344	1,25	15,12	4,80	-	625	719
						0320					4	2400	320	859	438	1,25	15,60	6,72	-	729	838
0400	5			2400	400	1068	545				1,26	26,40	8,16	-	831	956					
0480	6			2400	480	1277	651				1,26	31,68	9,84	-	931	1071					
0560	7			2400	560	1486	758				1,26	36,96	11,52	-	1032	1187					
0640	8			2400	640	1692	863				1,26	42,24	13,20	-	1136	1306					
0720	9			2400	720	1898	969				1,26	47,52	14,88	-	1238	1424					
0800	10			2400	800	2102	1073				1,26	52,80	16,80	-	1340	1541					
0880	11			2400	880	2306	1177				1,27	58,08	18,48	-	1444	1661					
11381	2600			0240	XXXX	YYYY	-0000				3	2600	240	731	373	1,25	16,38	5,20	-	665	765
				0320							4	2600	320	931	475	1,25	16,90	7,28	-	774	890
		0400	5	2600				400	1157	590	1,26	28,60	8,84	-	886	1019					
		0480	6	2600				480	1383	706	1,26	34,32	10,66	-	995	1144					
		0560	7	2600				560	1609	821	1,26	40,04	12,48	-	1104	1270					
		0640	8	2600				640	1833	935	1,26	45,76	14,30	-	1214	1396					
		0720	9	2600				720	2057	1049	1,26	51,48	16,12	-	1323	1521					
		0800	10	2600				800	2278	1162	1,26	57,20	18,20	-	1434	1649					
		0880	11	2600				880	2499	1275	1,27	62,92	20,02	-	1542	1773					

In conformity with EN442-1: 2014: radiators and convectors

For heat outputs in other regimes, see p. 320 (correction factors)
EXPORT. Prices in Euro (excl. VAT)

HOW TO ORDER VIOLA-A HORIZONTAL

Delivery time 15 - 30 working days
(transport duration not included)

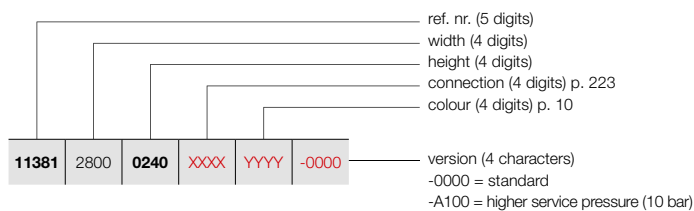

H1-RO-A
(thermostatic head to be ordered separately)

PRICE GROUP: VPG2 - STEEL DESIGN RADIATORS

REFERENCE CODE CUSTOM MADE VIOLA-A HORIZONTAL	TECHNICAL DATA									STANDARD COLOUR	OTHER COLOURS					
	tubes	width (L mm)	height (H mm)	75/65/20 (Watt) (φ50K)	55/45/20 (Watt) (φ30K)	n-exp.	weight (kg)	water content (l)	electr. resistance (Watt)	price RAL 9016 (€)	price colour (€)					
REF. NR. VIOLA-A HORIZONTAL H1-RO-A : 11381																
11381	2800	0240	XXXX	YYYY	-0000	3	2800	240	787	401	1,25	17,64	5,60	-	703	808
		0320				4	2800	320	1002	511	1,25	18,20	7,84	-	822	945
		0400				5	2800	400	1246	636	1,26	30,80	9,52	-	936	1076
		0480				6	2800	480	1490	760	1,26	36,96	11,48	-	1056	1214
		0560				7	2800	560	1733	884	1,26	43,12	13,44	-	1171	1347
		0640				8	2800	640	1974	1007	1,26	49,28	15,40	-	1292	1486
		0720				9	2800	720	2215	1130	1,26	55,44	17,36	-	1405	1616
		0800				10	2800	800	2453	1251	1,26	61,60	19,60	-	1525	1754
		0880				11	2800	880	2691	1373	1,27	67,76	21,56	-	1642	1888
11381	3000	0240	XXXX	YYYY	-0000	3	3000	240	843	430	1,25	18,90	6,00	-	743	854
		0320				4	3000	320	1074	548	1,25	19,50	8,40	-	865	995
		0400				5	3000	400	1335	681	1,26	33,00	10,20	-	994	1143
		0480				6	3000	480	1596	814	1,26	39,60	12,30	-	1118	1286
		0560				7	3000	560	1857	947	1,26	46,20	14,40	-	1240	1426
		0640				8	3000	640	2115	1079	1,26	52,80	16,50	-	1367	1572
		0720				9	3000	720	2373	1211	1,26	59,40	18,60	-	1490	1714
		0800				10	3000	800	2628	1341	1,26	66,00	21,00	-	1615	1857
		0880				11	3000	880	2883	1471	1,27	72,60	23,10	-	1740	2001

In conformity with EN442-1: 2014: radiators and convectors

For heat outputs in other regimes, see p. 320 (correction factors)
EXPORT. Prices in Euro (excl. VAT)

VIOLA-A HORIZONTAL (H1L1-RO-A)

HOW TO ORDER VIOLA-A HORIZONTAL

Delivery time 15 - 30 working days
(transport duration not included)



H1L1-RO-A
(thermostatic head to be ordered separately)

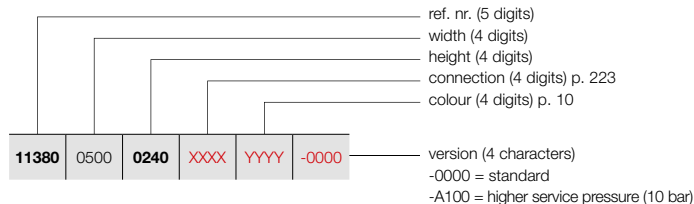

PRICE GROUP: VPG2 - STEEL DESIGN RADIATORS

REFERENCE CODE CUSTOM MADE VIOLA-A HORIZONTAL							TECHNICAL DATA					STANDARD COLOUR	OTHER COLOURS			
tubes	width (L mm)	height (H mm)	75/65/20 (Watt) (Φ50K)	55/45/20 (Watt) (Φ30K)	n-exp.	weight (kg)	water content (l)	electr. resistance (Watt)	price RAL 9016 (€)	price colour (€)						
REF. NR. VIOLA-A HORIZONTAL H1L1-RO-A : 11380																
11380	0500	0240	XXXX	YYYY	-0000	3	500	240	261	133	1,24	5,45	1,00	-	285	328
		0320				4	500	320	334	170	1,26	7,30	1,40	-	323	371
		0400				5	500	400	399	204	1,27	9,10	1,70	-	367	422
		0480				6	500	480	464	237	1,28	10,95	2,05	-	409	470
		0560				7	500	560	530	270	1,30	12,75	2,40	-	455	523
		0640				8	500	640	581	296	1,30	14,60	2,75	-	496	570
		0720				9	500	720	618	315	1,30	15,70	3,10	-	538	619
		0800				10	500	800	684	349	1,31	18,25	3,50	-	584	672
		0880				11	500	880	719	367	1,31	19,35	3,85	-	625	719
11380	0600	0240	XXXX	YYYY	-0000	3	600	240	313	160	1,24	6,54	1,20	-	310	357
		0320				4	600	320	401	204	1,26	8,76	1,68	-	360	414
		0400				5	600	400	479	244	1,27	10,92	2,04	-	407	468
		0480				6	600	480	557	284	1,28	13,14	2,46	-	456	524
		0560				7	600	560	635	324	1,30	15,30	2,88	-	500	575
		0640				8	600	640	697	356	1,30	17,52	3,30	-	552	635
		0720				9	600	720	741	378	1,30	18,84	3,72	-	600	690
		0800				10	600	800	821	419	1,31	21,90	4,20	-	646	743
		0880				11	600	880	863	440	1,31	23,22	4,62	-	697	802
11380	0700	0240	XXXX	YYYY	-0000	3	700	240	365	186	1,24	7,63	1,40	-	334	384
		0320				4	700	320	468	239	1,26	10,22	1,96	-	390	449
		0400				5	700	400	559	285	1,27	12,74	2,38	-	444	511
		0480				6	700	480	650	331	1,28	15,33	2,87	-	498	573
		0560				7	700	560	741	378	1,30	17,85	3,36	-	553	636
		0640				8	700	640	813	415	1,30	20,44	3,85	-	606	697
		0720				9	700	720	865	441	1,30	21,98	4,34	-	661	760
		0800				10	700	800	958	489	1,31	25,55	4,90	-	713	820
		0880				11	700	880	1007	514	1,31	27,09	5,39	-	768	883
11380	0800	0240	XXXX	YYYY	-0000	3	800	240	418	213	1,24	8,72	1,60	-	364	419
		0320				4	800	320	534	273	1,26	11,68	2,24	-	423	486
		0400				5	800	400	638	326	1,27	14,56	2,72	-	483	555
		0480				6	800	480	742	379	1,28	17,52	3,28	-	541	622
		0560				7	800	560	847	432	1,30	20,40	3,84	-	603	693
		0640				8	800	640	930	474	1,30	23,36	4,40	-	664	764
		0720				9	800	720	988	504	1,30	25,12	4,96	-	724	833
		0800				10	800	800	1094	558	1,31	29,20	5,60	-	783	900
		0880				11	800	880	1150	587	1,31	30,96	6,16	-	841	967
11380	0900	0240	XXXX	YYYY	-0000	3	900	240	470	240	1,24	9,81	1,80	-	392	451
		0320				4	900	320	601	307	1,26	13,14	2,52	-	458	527
		0400				5	900	400	718	366	1,27	16,38	3,06	-	523	601
		0480				6	900	480	835	426	1,28	19,71	3,69	-	588	676
		0560				7	900	560	953	486	1,30	22,95	4,32	-	652	750
		0640				8	900	640	1046	534	1,30	26,28	4,95	-	717	825
		0720				9	900	720	1112	567	1,30	28,26	5,58	-	784	902
		0800				10	900	800	1231	628	1,31	32,85	6,30	-	850	978
		0880				11	900	880	1294	660	1,31	34,83	6,93	-	916	1053

In conformity with EN442-1: 2014: radiators and convectors

For heat outputs in other regimes, see p. 320 (correction factors)
EXPORT. Prices in Euro (excl. VAT)

HOW TO ORDER VIOLA-A HORIZONTAL

Delivery time 15 - 30 working days
(transport duration not included)

VIOLA-A HORIZONTAL (H1L1-RO-A)

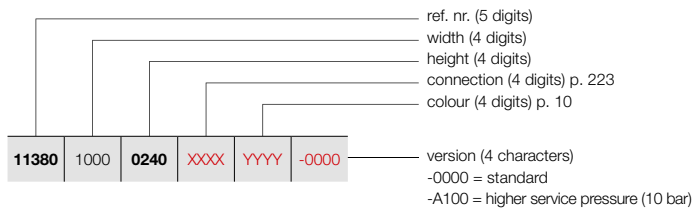

H1L1-RO-A
(thermostatic head to be ordered separately)

PRICE GROUP: VPG2 - STEEL DESIGN RADIATORS

REFERENCE CODE CUSTOM MADE VIOLA-A HORIZONTAL							TECHNICAL DATA				STANDARD COLOUR	OTHER COLOURS									
tubes	width (L mm)	height (H mm)	75/65/20 (Watt) (φ50K)	55/45/20 (Watt) (φ30K)	n-exp.	weight (kg)	water content (l)	electr. resistance (Watt)	price RAL 9016 (€)	price colour (€)											
REF. NR. VIOLA-A HORIZONTAL H1L1-RO-A : 11380																					
11380	1000	0240	XXXX	YYYY	-0000	3	1000	240	522	266	1,24	10,90	2,00	-	420	483					
		0320				4	1000	320	668	341	1,26	14,60	2,80	-	489	562					
		0400				5	1000	400	798	407	1,27	18,20	3,40	-	563	647					
		0480				6	1000	480	928	473	1,28	21,90	4,10	-	632	727					
		0560				7	1000	560	1059	540	1,30	25,50	4,80	-	702	807					
		0640				8	1000	640	1162	593	1,30	29,20	5,50	-	774	890					
		0720				9	1000	720	1235	630	1,30	31,40	6,20	-	847	974					
		0800				10	1000	800	1368	698	1,31	36,50	7,00	-	916	1053					
		0880				11	1000	880	1438	734	1,31	38,70	7,70	-	988	1136					
		11380				1100	0240	XXXX	YYYY	-0000	3	1100	240	574	293	1,24	11,99	2,20	-	446	513
							0320				4	1100	320	735	375	1,26	16,06	3,08	-	524	603
0400	5		1100	400	878		448				1,27	20,02	3,74	-	600	690					
0480	6		1100	480	1021		521				1,28	24,09	4,51	-	676	777					
0560	7		1100	560	1165		594				1,30	28,05	5,28	-	754	867					
0640	8		1100	640	1278		652				1,30	32,12	6,05	-	831	956					
0720	9		1100	720	1359		693				1,30	34,54	6,82	-	904	1040					
0800	10		1100	800	1505		768				1,31	40,15	7,70	-	981	1128					
0880	11		1100	880	1582		807				1,31	42,57	8,47	-	1058	1217					
11380	1200		0240	XXXX	YYYY		-0000				3	1200	240	626	320	1,24	13,08	2,40	-	473	544
			0320								4	1200	320	802	409	1,26	17,52	3,36	-	556	639
		0400	5			1200		400	958	489	1,27	21,84	4,08	-	637	733					
		0480	6			1200		480	1114	568	1,28	26,28	4,92	-	720	828					
		0560	7			1200		560	1271	648	1,30	30,60	5,76	-	802	922					
		0640	8			1200		640	1394	711	1,30	35,04	6,60	-	886	1019					
		0720	9			1200		720	1482	756	1,30	37,68	7,44	-	964	1109					
		0800	10			1200		800	1642	838	1,31	43,80	8,40	-	1050	1208					
		0880	11			1200		880	1726	880	1,31	46,44	9,24	-	1129	1298					
		11380	1400			0240		XXXX	YYYY	-0000	3	1400	240	731	373	1,24	15,26	2,80	-	530	610
						0320					4	1400	320	935	477	1,26	20,44	3,92	-	625	719
0400	5			1400	400	1117	570				1,27	25,48	4,76	-	714	821					
0480	6			1400	480	1299	663				1,28	30,66	5,74	-	808	929					
0560	7			1400	560	1483	756				1,30	35,70	6,72	-	903	1038					
0640	8			1400	640	1627	830				1,30	40,88	7,70	-	996	1145					
0720	9			1400	720	1729	882				1,30	43,96	8,68	-	1085	1248					
0800	10			1400	800	1915	977				1,31	51,10	9,80	-	1183	1360					
0880	11			1400	880	2013	1027				1,31	54,18	10,78	-	1273	1464					
11380	1600			0240	XXXX	YYYY	-0000				3	1600	240	835	426	1,24	17,44	3,20	-	586	674
				0320							4	1600	320	1069	545	1,26	23,36	4,48	-	690	794
		0400	5	1600				400	1277	651	1,27	29,12	5,44	-	791	910					
		0480	6	1600				480	1485	758	1,28	35,04	6,56	-	899	1034					
		0560	7	1600				560	1694	864	1,30	40,80	7,68	-	1001	1151					
		0640	8	1600				640	1859	949	1,30	46,72	8,80	-	1106	1272					
		0720	9	1600				720	1976	1008	1,30	50,24	9,92	-	1213	1395					
		0800	10	1600				800	2189	1117	1,31	58,40	11,20	-	1314	1511					
		0880	11	1600				880	2301	1174	1,31	61,92	12,32	-	1420	1633					



In conformity with EN442-1: 2014: radiators and convectors

For heat outputs in other regimes, see p. 320 (correction factors)
EXPORT. Prices in Euro (excl. VAT)

VIOLA-A HORIZONTAL (H1L1-RO-A)

HOW TO ORDER VIOLA-A HORIZONTAL

Delivery time 15 - 30 working days
(transport duration not included)



H1L1-RO-A
(thermostatic head to be ordered separately)

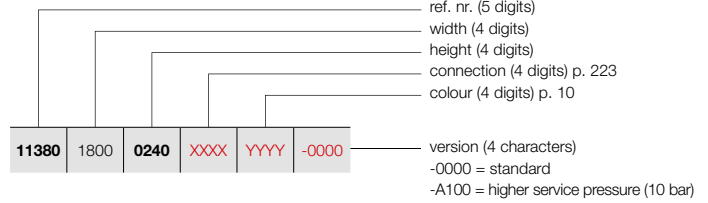

PRICE GROUP: VPG2 - STEEL DESIGN RADIATORS

REFERENCE CODE CUSTOM MADE VIOLA-A HORIZONTAL							TECHNICAL DATA					STANDARD COLOUR	OTHER COLOURS								
tubes	width (L mm)	height (H mm)	75/65/20 (Watt) (Φ50K)	55/45/20 (Watt) (Φ30K)	n-exp.	weight (kg)	water content (l)	electr. resistance (Watt)	price RAL 9016 (€)	price colour (€)											
REF. NR. VIOLA-A HORIZONTAL H1L1-RO-A : 11380																					
11380	1800	0240	XXXX	YYYY	-0000	3	1800	240	940	479	1,24	19,62	3,60	-	638	734					
		0320				4	1800	320	1202	613	1,26	26,28	5,04	-	756	869					
		0400				5	1800	400	1436	733	1,27	32,76	6,12	-	868	998					
		0480				6	1800	480	1670	852	1,28	39,42	7,38	-	988	1136					
		0560				7	1800	560	1906	973	1,30	45,90	8,64	-	1104	1270					
		0640				8	1800	640	2092	1067	1,30	52,56	9,90	-	1219	1402					
		0720				9	1800	720	2223	1134	1,30	56,52	11,16	-	1332	1532					
		0800				10	1800	800	2462	1256	1,31	65,70	12,60	-	1447	1664					
		0880				11	1800	880	2588	1321	1,31	69,66	13,86	-	1563	1797					
		11380				2000	0240	XXXX	YYYY	-0000	3	2000	240	1044	533	1,24	21,80	4,00	-	696	800
							0320				4	2000	320	1336	682	1,26	29,20	5,60	-	822	945
0400	5		2000	400	1596		814				1,27	36,40	6,80	-	951	1094					
0480	6		2000	480	1856		947				1,28	43,80	8,20	-	1075	1236					
0560	7		2000	560	2118		1081				1,30	51,00	9,60	-	1202	1382					
0640	8		2000	640	2324		1186				1,30	58,40	11,00	-	1329	1528					
0720	9		2000	720	2470		1260				1,30	62,80	12,40	-	1455	1673					
0800	10		2000	800	2736		1396				1,31	73,00	14,00	-	1581	1818					
0880	11		2000	880	2876		1467				1,31	77,40	15,40	-	1710	1967					
11380	2200		0240	XXXX	YYYY		-0000				3	2200	240	1148	586	1,24	23,98	4,40	-	753	866
			0320								4	2200	320	1470	750	1,26	32,12	6,16	-	889	1022
		0400	5			2200		400	1756	896	1,27	40,04	7,48	-	1026	1180					
		0480	6			2200		480	2042	1042	1,28	48,18	9,02	-	1165	1340					
		0560	7			2200		560	2330	1189	1,30	56,10	10,56	-	1300	1495					
		0640	8			2200		640	2556	1304	1,30	64,24	12,10	-	1440	1656					
		0720	9			2200		720	2717	1386	1,30	69,08	13,64	-	1578	1815					
		0800	10			2200		800	3010	1536	1,31	80,30	15,40	-	1716	1973					
		0880	11			2200		880	3164	1614	1,31	85,14	16,94	-	1852	2130					
		11380	2400			0240		XXXX	YYYY	-0000	3	2400	240	1253	639	1,24	26,16	4,80	-	806	927
						0320					4	2400	320	1603	818	1,26	35,04	6,72	-	956	1099
0400	5			2400	400	1915	977				1,27	43,68	8,16	-	1105	1271					
0480	6			2400	480	2227	1136				1,28	52,56	9,84	-	1254	1442					
0560	7			2400	560	2542	1297				1,30	61,20	11,52	-	1400	1610					
0640	8			2400	640	2789	1423				1,30	70,08	13,20	-	1550	1783					
0720	9			2400	720	2964	1512				1,30	75,36	14,88	-	1697	1952					
0800	10			2400	800	3283	1675				1,31	87,60	16,80	-	1848	2125					
0880	11			2400	880	3451	1761				1,31	92,88	18,48	-	1999	2299					
11380	2600			0240	XXXX	YYYY	-0000				3	2600	240	1357	692	1,24	28,34	5,20	-	860	989
				0320							4	2600	320	1737	886	1,26	37,96	7,28	-	1020	1173
		0400	5	2600				400	2075	1059	1,27	47,32	8,84	-	1180	1357					
		0480	6	2600				480	2413	1231	1,28	56,94	10,66	-	1340	1541					
		0560	7	2600				560	2753	1405	1,30	66,30	12,48	-	1500	1725					
		0640	8	2600				640	3021	1541	1,30	75,92	14,30	-	1660	1909					
		0720	9	2600				720	3211	1638	1,30	81,64	16,12	-	1822	2095					
		0800	10	2600				800	3557	1815	1,31	94,90	18,20	-	1981	2278					
		0880	11	2600				880	3739	1908	1,31	100,62	20,02	-	2142	2463					

In conformity with EN442-1: 2014: radiators and convectors

For heat outputs in other regimes, see p. 320 (correction factors)
EXPORT. Prices in Euro (excl. VAT)

VASCO

HOW TO ORDER VIOLA-A HORIZONTAL

Delivery time 15 - 30 working days
(transport duration not included)

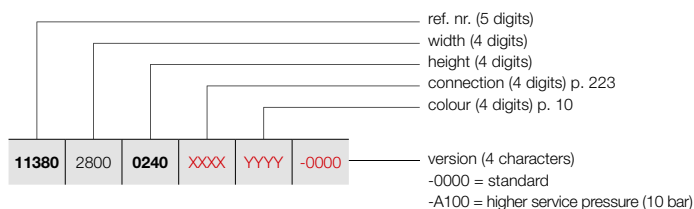

VIOLA-A HORIZONTAL (H1L1-RO-A)



H1L1-RO-A
(thermostatic head to be ordered separately)

PRICE GROUP: VPG2 - STEEL DESIGN RADIATORS

REFERENCE CODE CUSTOM MADE VIOLA-A HORIZONTAL	TECHNICAL DATA									STANDARD COLOUR	OTHER COLOURS					
	tubes	width (L mm)	height (H mm)	75/65/20 (Watt) (φ50K)	55/45/20 (Watt) (φ30K)	n-exp.	weight (kg)	water content (l)	electr. resistance (Watt)	price RAL 9016 (€)	price colour (€)					
REF. NR. VIOLA-A HORIZONTAL H1L1-RO-A : 11380																
11380	2800	0240	XXXX	YYYY	-0000	3	2800	240	1462	746	1,24	30,52	5,60	-	917	1055
		0320				4	2800	320	1870	954	1,26	40,88	7,84	-	1085	1248
		0400				5	2800	400	2234	1140	1,27	50,96	9,52	-	1259	1448
		0480				6	2800	480	2598	1326	1,28	61,32	11,48	-	1428	1642
		0560				7	2800	560	2965	1513	1,30	71,40	13,44	-	1601	1841
		0640				8	2800	640	3254	1660	1,30	81,76	15,40	-	1773	2039
		0720				9	2800	720	3458	1764	1,30	87,92	17,36	-	1943	2234
		0800				10	2800	800	3830	1954	1,31	102,20	19,60	-	2115	2432
		0880				11	2800	880	4026	2054	1,31	108,36	21,56	-	2286	2629
11380	3000	0240	XXXX	YYYY	-0000	3	3000	240	1566	799	1,24	32,70	6,00	-	973	1119
		0320				4	3000	320	2004	1022	1,26	43,80	8,40	-	1153	1326
		0400				5	3000	400	2394	1221	1,27	54,60	10,20	-	1337	1538
		0480				6	3000	480	2784	1420	1,28	65,70	12,30	-	1520	1748
		0560				7	3000	560	3177	1621	1,30	76,50	14,40	-	1700	1955
		0640				8	3000	640	3486	1779	1,30	87,60	16,50	-	1882	2164
		0720				9	3000	720	3705	1890	1,30	94,20	18,60	-	2067	2377
		0800				10	3000	800	4104	2094	1,31	109,50	21,00	-	2249	2586
		0880				11	3000	880	4314	2201	1,31	116,10	23,10	-	2429	2793

In conformity with EN442-1: 2014: radiators and convectors

For heat outputs in other regimes, see p. 320 (correction factors)
EXPORT. Prices in Euro (excl. VAT)

VIOLA-A HORIZONTAL (H2-RO-A)



H2-RO-A
(thermostatic head to be ordered separately)

HOW TO ORDER VIOLA-A HORIZONTAL

Delivery time 15 - 30 working days
(transport duration not included)

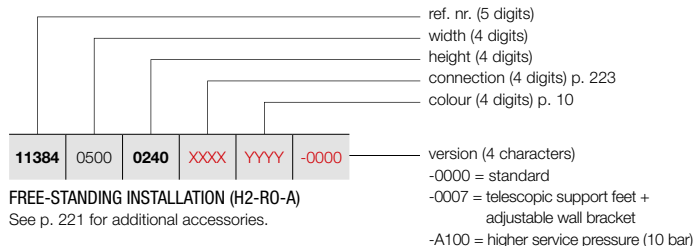

FREE-STANDING INSTALLATION (H2-RO-A)

See p. 221 for additional accessories.

PRICE GROUP: VPG2 - STEEL DESIGN RADIATORS

REFERENCE CODE CUSTOM MADE VIOLA-A HORIZONTAL	TECHNICAL DATA									STANDARD COLOUR	OTHER COLOURS
	tubes	width (L mm)	height (H mm)	75/65/20 (Watt) (Ø50K)	55/45/20 (Watt) (Ø30K)	n-exp.	weight (kg)	water content (l)	electr. resistance (Watt)	price RAL 9016 (€)	price colour (€)
REF. NR. VIOLA-A HORIZONTAL H2-RO-A : 11384											
11384 0500 0240 XXXX YYYY -0000	3	500	240	218	111	1,23	6,10	1,70	-	464	534
	4	500	320	273	139	1,22	8,15	2,25	-	530	610
	5	500	400	329	168	1,23	10,15	2,85	-	596	685
	6	500	480	389	198	1,25	12,20	3,45	-	661	760
	7	500	560	454	231	1,26	14,25	4,05	-	728	837
	8	500	640	523	267	1,27	16,25	4,65	-	789	907
	9	500	720	600	306	1,28	18,30	5,25	-	856	984
	10	500	800	663	338	1,28	20,35	5,70	-	922	1060
	11	500	880	726	370	1,29	22,35	6,20	-	989	1137
11384 0600 0240 XXXX YYYY -0000	3	600	240	262	133	1,23	7,32	2,04	-	498	573
	4	600	320	327	167	1,22	9,78	2,70	-	571	657
	5	600	400	395	201	1,23	12,18	3,42	-	642	738
	6	600	480	467	238	1,25	14,64	4,14	-	717	825
	7	600	560	544	278	1,26	17,10	4,86	-	788	906
	8	600	640	628	320	1,27	19,50	5,58	-	861	990
	9	600	720	719	367	1,28	21,96	6,30	-	933	1073
	10	600	800	795	406	1,28	24,42	6,84	-	1008	1159
	11	600	880	871	444	1,29	26,82	7,44	-	1080	1242
11384 0700 0240 XXXX YYYY -0000	3	700	240	305	156	1,23	8,54	2,38	-	535	615
	4	700	320	382	195	1,22	11,41	3,15	-	615	707
	5	700	400	461	235	1,23	14,21	3,99	-	694	798
	6	700	480	545	278	1,25	17,08	4,83	-	774	890
	7	700	560	635	324	1,26	19,95	5,67	-	854	982
	8	700	640	732	374	1,27	22,75	6,51	-	933	1073
	9	700	720	839	428	1,28	25,62	7,35	-	1014	1166
	10	700	800	928	473	1,28	28,49	7,98	-	1094	1258
	11	700	880	1016	518	1,29	31,29	8,68	-	1173	1349
11384 0800 0240 XXXX YYYY -0000	3	800	240	349	178	1,23	9,76	2,72	-	569	654
	4	800	320	436	222	1,22	13,04	3,60	-	657	756
	5	800	400	526	269	1,23	16,24	4,56	-	743	854
	6	800	480	622	318	1,25	19,52	5,52	-	832	957
	7	800	560	726	370	1,26	22,80	6,48	-	919	1057
	8	800	640	837	427	1,27	26,00	7,44	-	1004	1155
	9	800	720	959	489	1,28	29,28	8,40	-	1093	1257
	10	800	800	1060	541	1,28	32,56	9,12	-	1180	1357
	11	800	880	1161	592	1,29	35,76	9,92	-	1267	1457
11384 0900 0240 XXXX YYYY -0000	3	900	240	392	200	1,23	10,98	3,06	-	603	693
	4	900	320	491	250	1,22	14,67	4,05	-	700	805
	5	900	400	592	302	1,23	18,27	5,13	-	791	910
	6	900	480	700	357	1,25	21,96	6,21	-	888	1021
	7	900	560	816	416	1,26	25,65	7,29	-	982	1129
	8	900	640	941	480	1,27	29,25	8,37	-	1076	1237
	9	900	720	1079	551	1,28	32,94	9,45	-	1170	1346
	10	900	800	1193	608	1,28	36,63	10,26	-	1267	1457
	11	900	880	1306	666	1,29	40,23	11,16	-	1364	1569

In conformity with EN442-1: 2014: radiators and convectors

For heat outputs in other regimes, see p. 320 (correction factors)
EXPORT. Prices in Euro (excl. VAT)

HOW TO ORDER VIOLA-A HORIZONTAL

Delivery time 15 - 30 working days
(transport duration not included)

VIOLA-A HORIZONTAL (H2-RO-A)

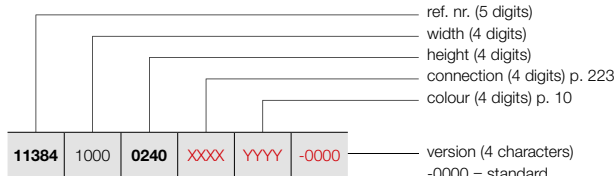

- ref. nr. (5 digits)
- width (4 digits)
- height (4 digits)
- connection (4 digits) p. 223
- colour (4 digits) p. 10
- version (4 characters)
- 0000 = standard
- 0007 = telescopic support feet + adjustable wall bracket
- A100 = higher service pressure (10 bar)

FREE-STANDING INSTALLATION (H2-RO-A)
See p. 221 for additional accessories.



H2-RO-A
(thermostatic head to be ordered separately)

PRICE GROUP: VPG2 - STEEL DESIGN RADIATORS

REFERENCE CODE CUSTOM MADE VIOLA-A HORIZONTAL	TECHNICAL DATA									STANDARD COLOUR	OTHER COLOURS	
	tubes	width (L mm)	height (H mm)	75/65/20 (Watt) (φ50K)	55/45/20 (Watt) (φ30K)	n-exp.	weight (kg)	water content (l)	electr. resistance (Watt)	price RAL 9016 (€)	price colour (€)	
REF. NR. VIOLA-A HORIZONTAL H2-RO-A : 11384												
11384 1000 0240 XXXX YYYY -0000	3	1000	240	436	222	1,23	12,20	3,40	-	637	733	
	4	1000	320	545	278	1,22	16,30	4,50	-	741	852	
	5	1000	400	658	336	1,23	20,30	5,70	-	842	968	
	6	1000	480	778	397	1,25	24,40	6,90	-	944	1086	
	7	1000	560	907	463	1,26	28,50	8,10	-	1049	1206	
	8	1000	640	1046	534	1,27	32,50	9,30	-	1150	1323	
	9	1000	720	1199	612	1,28	36,60	10,50	-	1251	1439	
	10	1000	800	1325	676	1,28	40,70	11,40	-	1350	1553	
	11	1000	880	1451	740	1,29	44,70	12,40	-	1454	1672	
	11384 1100 0240 XXXX YYYY -0000	3	1100	240	480	245	1,23	13,42	3,74	-	674	775
		4	1100	320	600	306	1,22	17,93	4,95	-	783	900
5		1100	400	724	369	1,23	22,33	6,27	-	892	1026	
6		1100	480	856	437	1,25	26,84	7,59	-	1000	1150	
7		1100	560	998	509	1,26	31,35	8,91	-	1110	1277	
8		1100	640	1151	587	1,27	35,75	10,23	-	1220	1403	
9		1100	720	1319	673	1,28	40,26	11,55	-	1329	1528	
10		1100	800	1458	744	1,28	44,77	12,54	-	1439	1655	
11		1100	880	1596	814	1,29	49,17	13,64	-	1548	1780	
11384 1200 0240 XXXX YYYY -0000		3	1200	240	523	267	1,23	14,64	4,08	-	705	811
		4	1200	320	654	334	1,22	19,56	5,40	-	823	946
	5	1200	400	790	403	1,23	24,36	6,84	-	940	1081	
	6	1200	480	934	476	1,25	29,28	8,28	-	1058	1217	
	7	1200	560	1088	555	1,26	34,20	9,72	-	1173	1349	
	8	1200	640	1255	640	1,27	39,00	11,16	-	1293	1487	
	9	1200	720	1439	734	1,28	43,92	12,60	-	1405	1616	
	10	1200	800	1590	811	1,28	48,84	13,68	-	1525	1754	
	11	1200	880	1741	888	1,29	53,64	14,88	-	1642	1888	
	11384 1400 0240 XXXX YYYY -0000	3	1400	240	610	311	1,23	17,08	4,76	-	777	894
		4	1400	320	763	389	1,22	22,82	6,30	-	906	1042
5		1400	400	921	470	1,23	28,42	7,98	-	1038	1194	
6		1400	480	1089	556	1,25	34,16	9,66	-	1170	1346	
7		1400	560	1270	648	1,26	39,90	11,34	-	1300	1495	
8		1400	640	1464	747	1,27	45,50	13,02	-	1434	1649	
9		1400	720	1679	856	1,28	51,24	14,70	-	1564	1799	
10		1400	800	1855	946	1,28	56,98	15,96	-	1695	1949	
11		1400	880	2031	1036	1,29	62,58	17,36	-	1826	2100	
11384 1600 0240 XXXX YYYY -0000		3	1600	240	698	356	1,23	19,52	5,44	-	848	975
		4	1600	320	872	445	1,22	26,08	7,20	-	994	1143
	5	1600	400	1053	537	1,23	32,48	9,12	-	1137	1308	
	6	1600	480	1245	635	1,25	39,04	11,04	-	1284	1477	
	7	1600	560	1451	740	1,26	45,60	12,96	-	1428	1642	
	8	1600	640	1674	854	1,27	52,00	14,88	-	1577	1814	
	9	1600	720	1918	979	1,28	58,56	16,80	-	1720	1978	
	10	1600	800	2120	1082	1,28	65,12	18,24	-	1867	2147	
	11	1600	880	2322	1184	1,29	71,52	19,84	-	2013	2315	

In conformity with EN442-1: 2014: radiators and convectors

For heat outputs in other regimes, see p. 320 (correction factors)
EXPORT. Prices in Euro (excl. VAT)

VIOLA-A HORIZONTAL (H2-RO-A)



H2-RO-A
(thermostatic head to be ordered separately)

HOW TO ORDER VIOLA-A HORIZONTAL

Delivery time 15 - 30 working days
(transport duration not included)

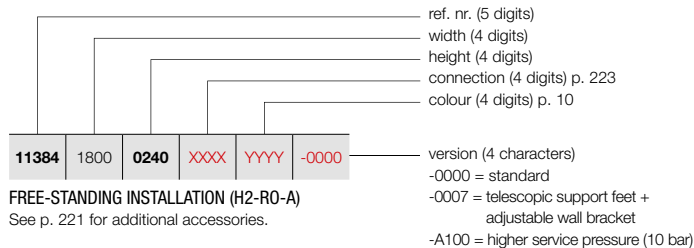

FREE-STANDING INSTALLATION (H2-RO-A)

See p. 221 for additional accessories.

PRICE GROUP: VPG2 - STEEL DESIGN RADIATORS

REFERENCE CODE CUSTOM MADE VIOLA-A HORIZONTAL							TECHNICAL DATA					STANDARD COLOUR	OTHER COLOURS			
tubes	width (L mm)	height (H mm)	75/65/20 (Watt) (Φ50K)	55/45/20 (Watt) (Φ30K)	n-exp.	weight (kg)	water content (l)	electr. resistance (Watt)	price RAL 9016 (€)	price colour (€)						
REF. NR. VIOLA-A HORIZONTAL H2-RO-A : 11384																
11384	1800	0240	XXXX	YYYY	-0000	3	1800	240	785	400	1,23	21,96	6,12	-	916	1053
		0320				4	1800	320	981	501	1,22	29,34	8,10	-	1075	1236
		0400				5	1800	400	1184	604	1,23	36,54	10,26	-	1236	1421
		0480				6	1800	480	1400	714	1,25	43,92	12,42	-	1398	1608
		0560				7	1800	560	1633	833	1,26	51,30	14,58	-	1558	1792
		0640				8	1800	640	1883	961	1,27	58,50	16,74	-	1718	1976
		0720				9	1800	720	2158	1101	1,28	65,88	18,90	-	1878	2160
		0800				10	1800	800	2385	1217	1,28	73,26	20,52	-	2040	2346
		0880				11	1800	880	2612	1333	1,29	80,46	22,32	-	2198	2528
11384	2000	0240	XXXX	YYYY	-0000	3	2000	240	872	445	1,23	24,40	6,80	-	986	1134
		0320				4	2000	320	1090	556	1,22	32,60	9,00	-	1158	1332
		0400				5	2000	400	1316	671	1,23	40,60	11,40	-	1336	1536
		0480				6	2000	480	1556	794	1,25	48,80	13,80	-	1512	1739
		0560				7	2000	560	1814	926	1,26	57,00	16,20	-	1687	1940
		0640				8	2000	640	2092	1067	1,27	65,00	18,60	-	1862	2141
		0720				9	2000	720	2398	1223	1,28	73,20	21,00	-	2036	2341
		0800				10	2000	800	2650	1352	1,28	81,40	22,80	-	2212	2544
		0880				11	2000	880	2902	1481	1,29	89,40	24,80	-	2387	2745
11384	2200	0240	XXXX	YYYY	-0000	3	2200	240	959	489	1,23	26,84	7,48	-	1053	1211
		0320				4	2200	320	1199	612	1,22	35,86	9,90	-	1241	1427
		0400				5	2200	400	1448	739	1,23	44,66	12,54	-	1435	1650
		0480				6	2200	480	1712	873	1,25	53,68	15,18	-	1623	1866
		0560				7	2200	560	1995	1018	1,26	62,70	17,82	-	1813	2085
		0640				8	2200	640	2301	1174	1,27	71,50	20,46	-	2006	2307
		0720				9	2200	720	2638	1346	1,28	80,52	23,10	-	2192	2521
		0800				10	2200	800	2915	1487	1,28	89,54	25,08	-	2385	2743
		0880				11	2200	880	3192	1629	1,29	98,34	27,28	-	2573	2959
11384	2400	0240	XXXX	YYYY	-0000	3	2400	240	1046	534	1,23	29,28	8,16	-	1123	1291
		0320				4	2400	320	1308	667	1,22	39,12	10,80	-	1327	1526
		0400				5	2400	400	1579	806	1,23	48,72	13,68	-	1531	1761
		0480				6	2400	480	1867	953	1,25	58,56	16,56	-	1738	1999
		0560				7	2400	560	2177	1111	1,26	68,40	19,44	-	1942	2233
		0640				8	2400	640	2510	1281	1,27	78,00	22,32	-	2146	2468
		0720				9	2400	720	2878	1468	1,28	87,84	25,20	-	2351	2704
		0800				10	2400	800	3180	1622	1,28	97,68	27,36	-	2554	2937
		0880				11	2400	880	3482	1777	1,29	107,28	29,76	-	2759	3173
11384	2600	0240	XXXX	YYYY	-0000	3	2600	240	1134	578	1,23	31,72	8,84	-	1191	1370
		0320				4	2600	320	1417	723	1,22	42,38	11,70	-	1413	1625
		0400				5	2600	400	1711	873	1,23	52,78	14,82	-	1631	1876
		0480				6	2600	480	2023	1032	1,25	63,44	17,94	-	1851	2129
		0560				7	2600	560	2358	1203	1,26	74,10	21,06	-	2071	2382
		0640				8	2600	640	2720	1388	1,27	84,50	24,18	-	2291	2635
		0720				9	2600	720	3117	1591	1,28	95,16	27,30	-	2507	2883
		0800				10	2600	800	3445	1758	1,28	105,82	29,64	-	2726	3135
		0880				11	2600	880	3773	1925	1,29	116,22	32,24	-	2944	3386

In conformity with EN442-1: 2014: radiators and convectors

For heat outputs in other regimes, see p. 320 (correction factors)
EXPORT. Prices in Euro (excl. VAT)

HOW TO ORDER VIOLA-A HORIZONTAL

Delivery time 15 - 30 working days
(transport duration not included)

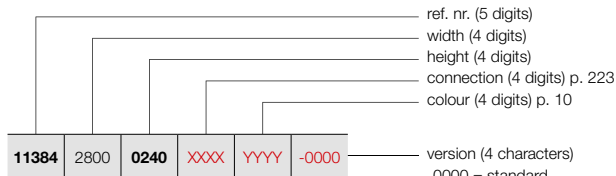

FREE-STANDING INSTALLATION (H2-RO-A)

See p. 221 for additional accessories.

- ref. nr. (5 digits)
- width (4 digits)
- height (4 digits)
- connection (4 digits) p. 223
- colour (4 digits) p. 10
- version (4 characters)
- 0000 = standard
- 0007 = telescopic support feet + adjustable wall bracket
- A100 = higher service pressure (10 bar)

VIOLA-A HORIZONTAL (H2-RO-A)



H2-RO-A
(thermostatic head to be ordered separately)

PRICE GROUP: VPG2 - STEEL DESIGN RADIATORS

REFERENCE CODE CUSTOM MADE VIOLA-A HORIZONTAL	TECHNICAL DATA									STANDARD COLOUR	OTHER COLOURS					
	tubes	width (L mm)	height (H mm)	75/65/20 (Watt) (Φ50K)	55/45/20 (Watt) (Φ30K)	n-exp.	weight (kg)	water content (l)	electr. resistance (Watt)	price RAL 9016 (€)	price colour (€)					
REF. NR. VIOLA-A HORIZONTAL H2-RO-A : 11384																
11384	2800	0240	XXXX	YYYY	-0000	3	2800	240	1221	623	1,23	34,16	9,52	-	1263	1452
		0320				4	2800	320	1526	779	1,22	45,64	12,60	-	1494	1718
		0400				5	2800	400	1842	940	1,23	56,84	15,96	-	1729	1988
		0480				6	2800	480	2178	1111	1,25	68,32	19,32	-	1965	2260
		0560				7	2800	560	2540	1296	1,26	79,80	22,68	-	2196	2525
		0640				8	2800	640	2929	1494	1,27	91,00	26,04	-	2430	2795
		0720				9	2800	720	3357	1713	1,28	102,48	29,40	-	2665	3065
		0800				10	2800	800	3710	1893	1,28	113,96	31,92	-	2900	3335
		0880				11	2800	880	4063	2073	1,29	125,16	34,72	-	3133	3603
11384	3000	0240	XXXX	YYYY	-0000	3	3000	240	1308	667	1,23	36,60	10,20	-	1331	1531
		0320				4	3000	320	1635	834	1,22	48,90	13,50	-	1580	1817
		0400				5	3000	400	1974	1007	1,23	60,90	17,10	-	1827	2101
		0480				6	3000	480	2334	1191	1,25	73,20	20,70	-	2077	2389
		0560				7	3000	560	2721	1388	1,26	85,50	24,30	-	2327	2676
		0640				8	3000	640	3138	1601	1,27	97,50	27,90	-	2573	2959
		0720				9	3000	720	3597	1835	1,28	109,80	31,50	-	2822	3245
		0800				10	3000	800	3975	2028	1,28	122,10	34,20	-	3072	3533
		0880				11	3000	880	4353	2221	1,29	134,10	37,20	-	3320	3818

In conformity with EN442-1: 2014: radiators and convectors

For heat outputs in other regimes, see p. 320 (correction factors)
EXPORT. Prices in Euro (excl. VAT)

VIOLA-A HORIZONTAL (H2L1-RO-A)



H2L1-RO-A
(thermostatic head to be ordered separately)

HOW TO ORDER VIOLA-A HORIZONTAL

Delivery time 15 - 30 working days
(transport duration not included)

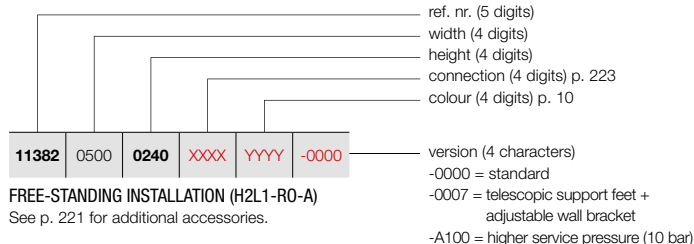

FREE-STANDING INSTALLATION (H2L1-RO-A)
See p. 221 for additional accessories.

PRICE GROUP: VPG2 - STEEL DESIGN RADIATORS

REFERENCE CODE CUSTOM MADE VIOLA-A HORIZONTAL							TECHNICAL DATA					STANDARD COLOUR	OTHER COLOURS			
tubes	width (L mm)	height (H mm)	75/65/20 (Watt) (Φ50K)	55/45/20 (Watt) (Φ30K)	n-exp.	weight (kg)	water content (l)	electr. resistance (Watt)	price RAL 9016 (€)	price colour (€)						
REF. NR. VIOLA-A HORIZONTAL H2L1-RO-A : 11382																
11382	0500	0240	XXXX	YYYY	-0000	3	500	240	322	164	1,28	7,75	1,70	-	518	596
		0320				4	500	320	399	204	1,30	10,35	2,25	-	598	688
		0400				5	500	400	474	242	1,32	12,90	2,85	-	681	783
		0480				6	500	480	550	280	1,34	15,50	3,45	-	764	879
		0560				7	500	560	625	319	1,36	18,10	4,05	-	849	976
		0640				8	500	640	677	345	1,36	20,65	4,65	-	929	1068
		0720				9	500	720	728	371	1,36	23,25	5,25	-	1011	1163
		0800				10	500	800	780	398	1,37	25,80	5,70	-	1094	1258
		0880				11	500	880	822	419	1,36	27,85	6,20	-	1178	1355
11382	0600	0240	XXXX	YYYY	-0000	3	600	240	386	197	1,28	9,30	2,04	-	556	639
		0320				4	600	320	479	244	1,30	12,42	2,70	-	646	743
		0400				5	600	400	569	290	1,32	15,48	3,42	-	740	851
		0480				6	600	480	659	336	1,34	18,60	4,14	-	832	957
		0560				7	600	560	749	382	1,36	21,72	4,86	-	922	1060
		0640				8	600	640	812	414	1,36	24,78	5,58	-	1012	1164
		0720				9	600	720	874	446	1,36	27,90	6,30	-	1106	1272
		0800				10	600	800	936	478	1,37	30,96	6,84	-	1197	1377
		0880				11	600	880	986	503	1,36	33,42	7,44	-	1288	1481
11382	0700	0240	XXXX	YYYY	-0000	3	700	240	450	230	1,28	10,85	2,38	-	597	687
		0320				4	700	320	559	285	1,30	14,49	3,15	-	697	802
		0400				5	700	400	664	339	1,32	18,06	3,99	-	798	918
		0480				6	700	480	769	393	1,34	21,70	4,83	-	899	1034
		0560				7	700	560	874	446	1,36	25,34	5,67	-	997	1147
		0640				8	700	640	947	483	1,36	28,91	6,51	-	1096	1260
		0720				9	700	720	1019	520	1,36	32,55	7,35	-	1198	1378
		0800				10	700	800	1092	557	1,37	36,12	7,98	-	1298	1493
		0880				11	700	880	1151	587	1,36	38,99	8,68	-	1399	1609
11382	0800	0240	XXXX	YYYY	-0000	3	800	240	514	262	1,28	12,40	2,72	-	637	733
		0320				4	800	320	638	326	1,30	16,56	3,60	-	747	859
		0400				5	800	400	758	387	1,32	20,64	4,56	-	855	983
		0480				6	800	480	879	449	1,34	24,80	5,52	-	962	1106
		0560				7	800	560	999	510	1,36	28,96	6,48	-	1074	1235
		0640				8	800	640	1082	552	1,36	33,04	7,44	-	1183	1360
		0720				9	800	720	1165	594	1,36	37,20	8,40	-	1293	1487
		0800				10	800	800	1248	637	1,37	41,28	9,12	-	1400	1610
		0880				11	800	880	1315	671	1,36	44,56	9,92	-	1510	1737
11382	0900	0240	XXXX	YYYY	-0000	3	900	240	579	295	1,28	13,95	3,06	-	677	779
		0320				4	900	320	718	366	1,30	18,63	4,05	-	794	913
		0400				5	900	400	853	435	1,32	23,22	5,13	-	915	1052
		0480				6	900	480	989	505	1,34	27,90	6,21	-	1030	1185
		0560				7	900	560	1124	574	1,36	32,58	7,29	-	1150	1323
		0640				8	900	640	1218	621	1,36	37,17	8,37	-	1267	1457
		0720				9	900	720	1310	669	1,36	41,85	9,45	-	1385	1593
		0800				10	900	800	1404	716	1,37	46,44	10,26	-	1500	1725
		0880				11	900	880	1480	755	1,36	50,13	11,16	-	1618	1861

In conformity with EN442-1: 2014: radiators and convectors

For heat outputs in other regimes, see p. 320 (correction factors)
EXPORT. Prices in Euro (excl. VAT)

HOW TO ORDER VIOLA-A HORIZONTAL

Delivery time 15 - 30 working days
(transport duration not included)

VIOLA-A HORIZONTAL (H2L1-RO-A)

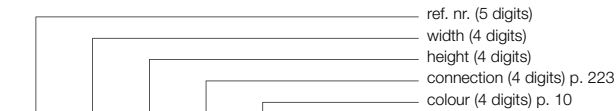

11382	1000	0240	XXXX	YYYY	-0000
-------	------	------	------	------	-------

- version (4 characters)
- 0000 = standard
- 0007 = telescopic support feet + adjustable wall bracket
- A100 = higher service pressure (10 bar)

FREE-STANDING INSTALLATION (H2L1-RO-A)
See p. 221 for additional accessories.

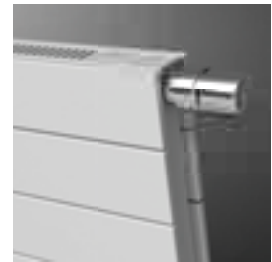

H2L1-RO-A
(thermostatic head to be ordered separately)

PRICE GROUP: VPG2 - STEEL DESIGN RADIATORS

REFERENCE CODE CUSTOM MADE VIOLA-A HORIZONTAL	TECHNICAL DATA									STANDARD COLOUR	OTHER COLOURS										
	tubes	width (L mm)	height (H mm)	75/65/20 (Watt) (φ50K)	55/45/20 (Watt) (φ30K)	n-exp.	weight (kg)	water content (l)	electr. resistance (Watt)	price RAL 9016 (€)	price colour (€)										
REF. NR. VIOLA-A HORIZONTAL H2L1-RO-A : 11382																					
11382	1000	0240	XXXX	YYYY	-0000	3	1000	240	643	328	1,28	15,50	3,40	-	717	825					
		0320				4	1000	320	798	407	1,30	20,70	4,50	-	847	974					
		0400				5	1000	400	948	484	1,32	25,80	5,70	-	973	1119					
		0480				6	1000	480	1099	561	1,34	31,00	6,90	-	1096	1260					
		0560				7	1000	560	1249	637	1,36	36,20	8,10	-	1224	1408					
		0640				8	1000	640	1353	690	1,36	41,30	9,30	-	1350	1553					
		0720				9	1000	720	1456	743	1,36	46,50	10,50	-	1476	1697					
		0800				10	1000	800	1560	796	1,37	51,60	11,40	-	1602	1842					
		0880				11	1000	880	1644	839	1,36	55,70	12,40	-	1731	1991					
		11382				1100	0240	XXXX	YYYY	-0000	3	1100	240	707	361	1,28	17,05	3,74	-	757	871
							0320				4	1100	320	878	448	1,30	22,77	4,95	-	894	1028
0400	5		1100	400	1043		532				1,32	28,38	6,27	-	1029	1183					
0480	6		1100	480	1209		617				1,34	34,10	7,59	-	1165	1340					
0560	7		1100	560	1374		701				1,36	39,82	8,91	-	1299	1494					
0640	8		1100	640	1488		759				1,36	45,43	10,23	-	1435	1650					
0720	9		1100	720	1602		817				1,36	51,15	11,55	-	1569	1804					
0800	10		1100	800	1716		876				1,37	56,76	12,54	-	1705	1961					
0880	11		1100	880	1808		923				1,36	61,27	13,64	-	1840	2116					
11382	1200		0240	XXXX	YYYY		-0000				3	1200	240	772	394	1,28	18,60	4,08	-	799	919
			0320								4	1200	320	958	489	1,30	24,84	5,40	-	942	1083
		0400	5			1200		400	1138	580	1,32	30,96	6,84	-	1084	1247					
		0480	6			1200		480	1319	673	1,34	37,20	8,28	-	1230	1415					
		0560	7			1200		560	1499	765	1,36	43,44	9,72	-	1375	1581					
		0640	8			1200		640	1624	828	1,36	49,56	11,16	-	1520	1748					
		0720	9			1200		720	1747	891	1,36	55,80	12,60	-	1662	1911					
		0800	10			1200		800	1872	955	1,37	61,92	13,68	-	1809	2080					
		0880	11			1200		880	1973	1007	1,36	66,84	14,88	-	1952	2245					
		11382	1400			0240		XXXX	YYYY	-0000	3	1400	240	900	459	1,28	21,70	4,76	-	881	1013
						0320					4	1400	320	1117	570	1,30	28,98	6,30	-	1043	1199
0400	5			1400	400	1327	677				1,32	36,12	7,98	-	1204	1385					
0480	6			1400	480	1539	785				1,34	43,40	9,66	-	1366	1571					
0560	7			1400	560	1749	892				1,36	50,68	11,34	-	1527	1756					
0640	8			1400	640	1894	966				1,36	57,82	13,02	-	1688	1941					
0720	9			1400	720	2038	1040				1,36	65,10	14,70	-	1850	2128					
0800	10			1400	800	2184	1114				1,37	72,24	15,96	-	2012	2314					
0880	11			1400	880	2302	1174				1,36	77,98	17,36	-	2174	2500					
11382	1600			0240	XXXX	YYYY	-0000				3	1600	240	1029	525	1,28	24,80	5,44	-	960	1104
				0320							4	1600	320	1277	651	1,30	33,12	7,20	-	1139	1310
		0400	5	1600				400	1517	774	1,32	41,28	9,12	-	1318	1516					
		0480	6	1600				480	1758	897	1,34	49,60	11,04	-	1497	1722					
		0560	7	1600				560	1998	1020	1,36	57,92	12,96	-	1679	1931					
		0640	8	1600				640	2165	1104	1,36	66,08	14,88	-	1857	2136					
		0720	9	1600				720	2330	1189	1,36	74,40	16,80	-	2036	2341					
		0800	10	1600				800	2496	1273	1,37	82,56	18,24	-	2217	2550					
		0880	11	1600				880	2630	1342	1,36	89,12	19,84	-	2393	2752					

In conformity with EN442-1: 2014: radiators and convectors

For heat outputs in other regimes, see p. 320 (correction factors)
EXPORT. Prices in Euro (excl. VAT)

VIOLA-A HORIZONTAL (H2L1-RO-A)



H2L1-RO-A
(thermostatic head to be ordered separately)

HOW TO ORDER VIOLA-A HORIZONTAL

Delivery time 15 - 30 working days
(transport duration not included)

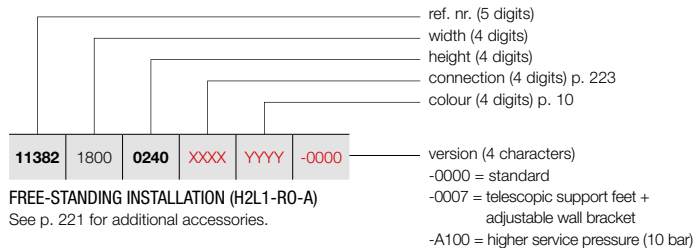

FREE-STANDING INSTALLATION (H2L1-RO-A)

See p. 221 for additional accessories.

PRICE GROUP: VPG2 - STEEL DESIGN RADIATORS

REFERENCE CODE CUSTOM MADE VIOLA-A HORIZONTAL							TECHNICAL DATA					STANDARD COLOUR	OTHER COLOURS								
tubes	width (L mm)	height (H mm)	75/65/20 (Watt) (Φ50K)	55/45/20 (Watt) (Φ30K)	n-exp.	weight (kg)	water content (l)	electr. resistance (Watt)	price RAL 9016 (€)	price colour (€)											
REF. NR. VIOLA-A HORIZONTAL H2L1-RO-A : 11382																					
11382	1800	0240	XXXX	YYYY	-0000	3	1800	240	1157	591	1,28	27,90	6,12	-	1043	1199					
		0320				4	1800	320	1436	733	1,30	37,26	8,10	-	1238	1424					
		0400				5	1800	400	1706	871	1,32	46,44	10,26	-	1435	1650					
		0480				6	1800	480	1978	1009	1,34	55,80	12,42	-	1633	1878					
		0560				7	1800	560	2248	1147	1,36	65,16	14,58	-	1827	2101					
		0640				8	1800	640	2435	1243	1,36	74,34	16,74	-	2025	2329					
		0720				9	1800	720	2621	1337	1,36	83,70	18,90	-	2222	2555					
		0800				10	1800	800	2808	1433	1,37	92,88	20,52	-	2419	2782					
		0880				11	1800	880	2959	1510	1,36	100,26	22,32	-	2614	3006					
		11382				2000	0240	XXXX	YYYY	-0000	3	2000	240	1286	656	1,28	31,00	6,80	-	1121	1289
							0320				4	2000	320	1596	814	1,30	41,40	9,00	-	1337	1538
0400	5		2000	400	1896		967				1,32	51,60	11,40	-	1550	1783					
0480	6		2000	480	2198		1121				1,34	62,00	13,80	-	1763	2027					
0560	7		2000	560	2498		1274				1,36	72,40	16,20	-	1979	2276					
0640	8		2000	640	2706		1381				1,36	82,60	18,60	-	2192	2521					
0720	9		2000	720	2912		1486				1,36	93,00	21,00	-	2407	2768					
0800	10		2000	800	3120		1592				1,37	103,20	22,80	-	2620	3013					
0880	11		2000	880	3288		1678				1,36	111,40	24,80	-	2835	3260					
11382	2200		0240	XXXX	YYYY		-0000				3	2200	240	1415	722	1,28	34,10	7,48	-	1204	1385
			0320								4	2200	320	1756	896	1,30	45,54	9,90	-	1435	1650
		0400	5			2200		400	2086	1064	1,32	56,76	12,54	-	1665	1915					
		0480	6			2200		480	2418	1234	1,34	68,20	15,18	-	1900	2185					
		0560	7			2200		560	2748	1402	1,36	79,64	17,82	-	2130	2450					
		0640	8			2200		640	2977	1519	1,36	90,86	20,46	-	2359	2713					
		0720	9			2200		720	3203	1634	1,36	102,30	23,10	-	2596	2985					
		0800	10			2200		800	3432	1751	1,37	113,52	25,08	-	2824	3248					
		0880	11			2200		880	3617	1845	1,36	122,54	27,28	-	3055	3513					
		11382	2400			0240		XXXX	YYYY	-0000	3	2400	240	1543	787	1,28	37,20	8,16	-	1282	1474
						0320					4	2400	320	1915	977	1,30	49,68	10,80	-	1533	1763
0400	5			2400	400	2275	1161				1,32	61,92	13,68	-	1783	2050					
0480	6			2400	480	2638	1346				1,34	74,40	16,56	-	2031	2336					
0560	7			2400	560	2998	1529				1,36	86,88	19,44	-	2281	2623					
0640	8			2400	640	3247	1657				1,36	99,12	22,32	-	2530	2910					
0720	9			2400	720	3494	1783				1,36	111,60	25,20	-	2781	3198					
0800	10			2400	800	3744	1910				1,37	123,84	27,36	-	3029	3483					
0880	11			2400	880	3946	2013				1,36	133,68	29,76	-	3279	3771					
11382	2600			0240	XXXX	YYYY	-0000				3	2600	240	1672	853	1,28	40,30	8,84	-	1366	1571
				0320							4	2600	320	2075	1059	1,30	53,82	11,70	-	1631	1876
		0400	5	2600				400	2465	1258	1,32	67,08	14,82	-	1900	2185					
		0480	6	2600				480	2857	1458	1,34	80,60	17,94	-	2164	2489					
		0560	7	2600				560	3247	1657	1,36	94,12	21,06	-	2430	2795					
		0640	8	2600				640	3518	1795	1,36	107,38	24,18	-	2701	3106					
		0720	9	2600				720	3786	1931	1,36	120,90	27,30	-	2966	3411					
		0800	10	2600				800	4056	2069	1,37	134,16	29,64	-	3235	3720					
		0880	11	2600				880	4274	2181	1,36	144,82	32,24	-	3500	4025					

In conformity with EN442-1: 2014: radiators and convectors

For heat outputs in other regimes, see p. 320 (correction factors)
EXPORT. Prices in Euro (excl. VAT)

HOW TO ORDER VIOLA-A HORIZONTAL

Delivery time 15 - 30 working days
(transport duration not included)

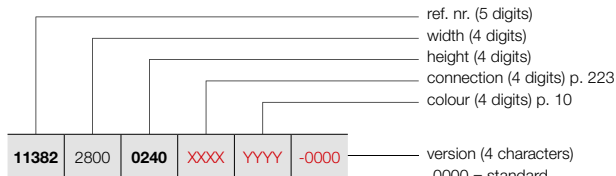

FREE-STANDING INSTALLATION (H2L1-RO-A)

See p. 221 for additional accessories.

- ref. nr. (5 digits)
- width (4 digits)
- height (4 digits)
- connection (4 digits) p. 223
- colour (4 digits) p. 10
- version (4 characters)
- 0000 = standard
- 0007 = telescopic support feet + adjustable wall bracket
- A100 = higher service pressure (10 bar)

VIOLA-A HORIZONTAL (H2L1-RO-A)



H2L1-RO-A
(thermostatic head to be ordered separately)

PRICE GROUP: VPG2 - STEEL DESIGN RADIATORS

REFERENCE CODE CUSTOM MADE VIOLA-A HORIZONTAL	TECHNICAL DATA									STANDARD COLOUR	OTHER COLOURS					
	tubes	width (L mm)	height (H mm)	75/65/20 (Watt) (Φ50K)	55/45/20 (Watt) (Φ30K)	n-exp.	weight (kg)	water content (l)	electr. resistance (Watt)	price RAL 9016 (€)	price colour (€)					
REF. NR. VIOLA-A HORIZONTAL H2L1-RO-A : 11382																
11382	2800	0240	XXXX	YYYY	-0000	3	2800	240	1800	919	1,28	43,40	9,52	-	1445	1662
		0320				4	2800	320	2234	1140	1,30	57,96	12,60	-	1729	1988
		0400				5	2800	400	2654	1354	1,32	72,24	15,96	-	2013	2315
		0480				6	2800	480	3077	1570	1,34	86,80	19,32	-	2298	2643
		0560				7	2800	560	3497	1784	1,36	101,36	22,68	-	2581	2968
		0640				8	2800	640	3788	1933	1,36	115,64	26,04	-	2867	3297
		0720				9	2800	720	4077	2080	1,36	130,20	29,40	-	3153	3626
		0800				10	2800	800	4368	2229	1,37	144,48	31,92	-	3435	3950
		0880				11	2800	880	4603	2349	1,36	155,96	34,72	-	3720	4278
11382	3000	0240	XXXX	YYYY	-0000	3	3000	240	1929	984	1,28	46,50	10,20	-	1526	1755
		0320				4	3000	320	2394	1221	1,30	62,10	13,50	-	1827	2101
		0400				5	3000	400	2844	1451	1,32	77,40	17,10	-	2130	2450
		0480				6	3000	480	3297	1682	1,34	93,00	20,70	-	2430	2795
		0560				7	3000	560	3747	1912	1,36	108,60	24,30	-	2731	3141
		0640				8	3000	640	4059	2071	1,36	123,90	27,90	-	3036	3491
		0720				9	3000	720	4368	2229	1,36	139,50	31,50	-	3338	3839
		0800				10	3000	800	4680	2388	1,37	154,80	34,20	-	3641	4187
		0880				11	3000	880	4932	2516	1,36	167,10	37,20	-	3942	4533

In conformity with EN442-1: 2014: radiators and convectors

For heat outputs in other regimes, see p. 320 (correction factors)
EXPORT. Prices in Euro (excl. VAT)

VIOLA-A HORIZONTAL (H2L2-RO-A)

HOW TO ORDER VIOLA-A HORIZONTAL

Delivery time 15 - 30 working days
(transport duration not included)



H2L2-RO-A
(thermostatic head to be ordered separately)

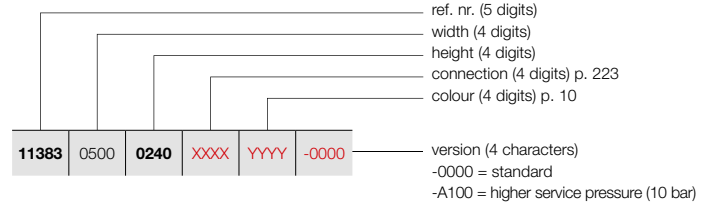

PRICE GROUP: VPG2 - STEEL DESIGN RADIATORS

REFERENCE CODE CUSTOM MADE VIOLA-A HORIZONTAL							TECHNICAL DATA				STANDARD COLOUR	OTHER COLOURS				
tubes	width (L mm)	height (H mm)	75/65/20 (Watt) (Φ50K)	55/45/20 (Watt) (Φ30K)	n-exp.	weight (kg)	water content (l)	electr. resistance (Watt)	price RAL 9016 (€)	price colour (€)						
REF. NR. VIOLA-A HORIZONTAL H2L2-RO-A : 11383																
11383	0500	0240	XXXX	YYYY	-0000	3	500	240	433	221	1,25	9,70	2,00	-	559	643
		0320				4	500	320	538	274	1,30	12,90	2,75	-	652	750
		0400				5	500	400	663	338	1,31	16,10	3,45	-	745	857
		0480				6	500	480	788	402	1,33	19,40	4,15	-	837	963
		0560				7	500	560	913	466	1,34	22,60	4,85	-	931	1071
		0640				8	500	640	993	507	1,34	25,85	5,50	-	1023	1176
		0720				9	500	720	1073	547	1,34	29,10	6,20	-	1119	1287
		0800				10	500	800	1153	588	1,36	32,30	6,90	-	1213	1395
		0880				11	500	880	1204	614	1,36	34,45	7,60	-	1304	1500
11383	0600	0240	XXXX	YYYY	-0000	3	600	240	519	265	1,25	11,64	2,40	-	607	698
		0320				4	600	320	645	329	1,30	15,48	3,30	-	710	817
		0400				5	600	400	796	406	1,31	19,32	4,14	-	816	938
		0480				6	600	480	946	482	1,33	23,28	4,98	-	921	1059
		0560				7	600	560	1096	559	1,34	27,12	5,82	-	1023	1176
		0640				8	600	640	1192	608	1,34	31,02	6,60	-	1128	1297
		0720				9	600	720	1287	657	1,34	34,92	7,44	-	1230	1415
		0800				10	600	800	1383	706	1,36	38,76	8,28	-	1337	1538
		0880				11	600	880	1445	737	1,36	41,34	9,12	-	1442	1658
11383	0700	0240	XXXX	YYYY	-0000	3	700	240	606	309	1,25	13,58	2,80	-	657	756
		0320				4	700	320	753	384	1,30	18,06	3,85	-	773	889
		0400				5	700	400	928	474	1,31	22,54	4,83	-	888	1021
		0480				6	700	480	1103	563	1,33	27,16	5,81	-	1001	1151
		0560				7	700	560	1278	652	1,34	31,64	6,79	-	1118	1286
		0640				8	700	640	1390	709	1,34	36,19	7,70	-	1230	1415
		0720				9	700	720	1502	766	1,34	40,74	8,68	-	1346	1548
		0800				10	700	800	1614	823	1,36	45,22	9,66	-	1460	1679
		0880				11	700	880	1686	860	1,36	48,23	10,64	-	1577	1814
11383	0800	0240	XXXX	YYYY	-0000	3	800	240	692	353	1,25	15,52	3,20	-	704	810
		0320				4	800	320	860	439	1,30	20,64	4,40	-	832	957
		0400				5	800	400	1061	541	1,31	25,76	5,52	-	958	1102
		0480				6	800	480	1261	643	1,33	31,04	6,64	-	1082	1244
		0560				7	800	560	1461	745	1,34	36,16	7,76	-	1211	1393
		0640				8	800	640	1589	811	1,34	41,36	8,80	-	1336	1536
		0720				9	800	720	1716	876	1,34	46,56	9,92	-	1460	1679
		0800				10	800	800	1844	941	1,36	51,68	11,04	-	1587	1825
		0880				11	800	880	1926	983	1,36	55,12	12,16	-	1714	1971
11383	0900	0240	XXXX	YYYY	-0000	3	900	240	779	397	1,25	17,46	3,60	-	755	868
		0320				4	900	320	968	494	1,30	23,22	4,95	-	891	1025
		0400				5	900	400	1193	609	1,31	28,98	6,21	-	1027	1181
		0480				6	900	480	1418	724	1,33	34,92	7,47	-	1165	1340
		0560				7	900	560	1643	838	1,34	40,68	8,73	-	1300	1495
		0640				8	900	640	1787	912	1,34	46,53	9,90	-	1439	1655
		0720				9	900	720	1931	985	1,34	52,38	11,16	-	1575	1811
		0800				10	900	800	2075	1058	1,36	58,14	12,42	-	1714	1971
		0880				11	900	880	2167	1106	1,36	62,01	13,68	-	1850	2128

In conformity with EN442-1: 2014: radiators and convectors

For heat outputs in other regimes, see p. 320 (correction factors)
EXPORT. Prices in Euro (excl. VAT)

HOW TO ORDER VIOLA-A HORIZONTAL

Delivery time 15 - 30 working days
(transport duration not included)

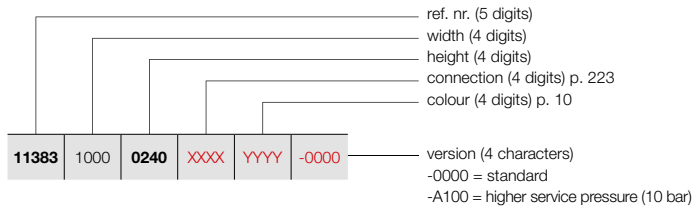

VIOLA-A HORIZONTAL (H2L2-RO-A)



H2L2-RO-A
(thermostatic head to be ordered separately)

PRICE GROUP: VPG2 - STEEL DESIGN RADIATORS

REFERENCE CODE CUSTOM MADE VIOLA-A HORIZONTAL						TECHNICAL DATA					STANDARD COLOUR	OTHER COLOURS									
tubes	width (L mm)	height (H mm)	75/65/20 (Watt) (Φ50K)	55/45/20 (Watt) (Φ30K)	n-exp.	weight (kg)	water content (l)	electr. resistance (Watt)	price RAL 9016 (€)	price colour (€)											
REF. NR. VIOLA-A HORIZONTAL H2L2-RO-A : 11383																					
11383	1000	0240	XXXX	YYYY	-0000	3	1000	240	865	441	1,25	19,40	4,00	-	802	922					
		0320				4	1000	320	1075	548	1,30	25,80	5,50	-	953	1096					
		0400				5	1000	400	1326	677	1,31	32,20	6,90	-	1096	1260					
		0480				6	1000	480	1576	804	1,33	38,80	8,30	-	1244	1431					
		0560				7	1000	560	1826	932	1,34	45,20	9,70	-	1393	1602					
		0640				8	1000	640	1986	1013	1,34	51,70	11,00	-	1541	1772					
		0720				9	1000	720	2145	1094	1,34	58,20	12,40	-	1689	1942					
		0800				10	1000	800	2305	1176	1,36	64,60	13,80	-	1836	2111					
		0880				11	1000	880	2408	1229	1,36	68,90	15,20	-	1983	2280					
		11383				1100	0240	XXXX	YYYY	-0000	3	1100	240	952	485	1,25	21,34	4,40	-	852	980
							0320				4	1100	320	1183	603	1,30	28,38	6,05	-	1009	1160
0400	5		1100	400	1459		744				1,31	35,42	7,59	-	1169	1344					
0480	6		1100	480	1734		884				1,33	42,68	9,13	-	1327	1526					
0560	7		1100	560	2009		1025				1,34	49,72	10,67	-	1488	1711					
0640	8		1100	640	2185		1115				1,34	56,87	12,10	-	1646	1893					
0720	9		1100	720	2360		1204				1,34	64,02	13,64	-	1803	2073					
0800	10		1100	800	2536		1294				1,36	71,06	15,18	-	1963	2257					
0880	11		1100	880	2649		1351				1,36	75,79	16,72	-	2120	2438					
11383	1200		0240	XXXX	YYYY		-0000				3	1200	240	1038	530	1,25	23,28	4,80	-	902	1037
			0320								4	1200	320	1290	658	1,30	30,96	6,60	-	1070	1231
		0400	5			1200		400	1591	812	1,31	38,64	8,28	-	1239	1425					
		0480	6			1200		480	1891	965	1,33	46,56	9,96	-	1409	1620					
		0560	7			1200		560	2191	1118	1,34	54,24	11,64	-	1578	1815					
		0640	8			1200		640	2383	1216	1,34	62,04	13,20	-	1750	2013					
		0720	9			1200		720	2574	1313	1,34	69,84	14,88	-	1918	2206					
		0800	10			1200		800	2766	1411	1,36	77,52	16,56	-	2084	2397					
		0880	11			1200		880	2890	1474	1,36	82,68	18,24	-	2256	2594					
		11383	1400			0240		XXXX	YYYY	-0000	3	1400	240	1211	618	1,25	27,16	5,60	-	998	1148
						0320					4	1400	320	1505	768	1,30	36,12	7,70	-	1190	1369
0400	5			1400	400	1856	947				1,31	45,08	9,66	-	1381	1588					
0480	6			1400	480	2206	1126				1,33	54,32	11,62	-	1571	1807					
0560	7			1400	560	2556	1304				1,34	63,28	13,58	-	1761	2025					
0640	8			1400	640	2780	1419				1,34	72,38	15,40	-	1955	2248					
0720	9			1400	720	3003	1532				1,34	81,48	17,36	-	2146	2468					
0800	10			1400	800	3227	1646				1,36	90,44	19,32	-	2336	2686					
0880	11			1400	880	3371	1720				1,36	96,46	21,28	-	2528	2907					
11383	1600			0240	XXXX	YYYY	-0000				3	1600	240	1384	706	1,25	31,04	6,40	-	1095	1259
				0320							4	1600	320	1720	878	1,30	41,28	8,80	-	1311	1508
		0400	5	1600				400	2122	1082	1,31	51,52	11,04	-	1523	1751					
		0480	6	1600				480	2522	1287	1,33	62,08	13,28	-	1737	1998					
		0560	7	1600				560	2922	1491	1,34	72,32	15,52	-	1948	2240					
		0640	8	1600				640	3178	1621	1,34	82,72	17,60	-	2160	2484					
		0720	9	1600				720	3432	1751	1,34	93,12	19,84	-	2375	2731					
		0800	10	1600				800	3688	1882	1,36	103,36	22,08	-	2587	2975					
		0880	11	1600				880	3853	1966	1,36	110,24	24,32	-	2800	3220					

In conformity with EN442-1: 2014: radiators and convectors

For heat outputs in other regimes, see p. 320 (correction factors)
EXPORT. Prices in Euro (excl. VAT)



VIOLA-A HORIZONTAL (H2L2-RO-A)



H2L2-RO-A
(thermostatic head to be ordered separately)

HOW TO ORDER VIOLA-A HORIZONTAL

Delivery time 15 - 30 working days
(transport duration not included)

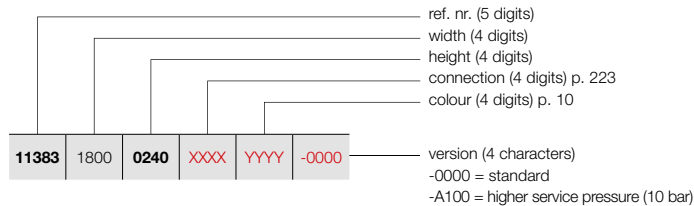

PRICE GROUP: VPG2 - STEEL DESIGN RADIATORS

REFERENCE CODE CUSTOM MADE VIOLA-A HORIZONTAL						TECHNICAL DATA					STANDARD COLOUR	OTHER COLOURS				
tubes	width (L mm)	height (H mm)	75/65/20 (Watt) (Φ50K)	55/45/20 (Watt) (Φ30K)	n-exp.	weight (kg)	water content (l)	electr. resistance (Watt)	price RAL 9016 (€)	price colour (€)						
REF. NR. VIOLA-A HORIZONTAL H2L2-RO-A : 11383																
11383	1800	0240	XXXX	YYYY	-0000	3	1800	240	1557	794	1,25	34,92	7,20	-	1192	1371
		0320				4	1800	320	1935	987	1,30	46,44	9,90	-	1427	1641
		0400				5	1800	400	2387	1218	1,31	57,96	12,42	-	1662	1911
		0480				6	1800	480	2837	1447	1,33	69,84	14,94	-	1900	2185
		0560				7	1800	560	3287	1677	1,34	81,36	17,46	-	2132	2452
		0640				8	1800	640	3575	1824	1,34	93,06	19,80	-	2368	2723
		0720				9	1800	720	3861	1970	1,34	104,76	22,32	-	2605	2996
		0800				10	1800	800	4149	2117	1,36	116,28	24,84	-	2837	3263
		0880				11	1800	880	4334	2211	1,36	124,02	27,36	-	3075	3536
11383	2000	0240	XXXX	YYYY	-0000	3	2000	240	1730	883	1,25	38,80	8,00	-	1293	1487
		0320				4	2000	320	2150	1097	1,30	51,60	11,00	-	1548	1780
		0400				5	2000	400	2652	1353	1,31	64,40	13,80	-	1804	2075
		0480				6	2000	480	3152	1608	1,33	77,60	16,60	-	2061	2370
		0560				7	2000	560	3652	1863	1,34	90,40	19,40	-	2320	2668
		0640				8	2000	640	3972	2027	1,34	103,40	22,00	-	2575	2961
		0720				9	2000	720	4290	2189	1,34	116,40	24,80	-	2831	3256
		0800				10	2000	800	4610	2352	1,36	129,20	27,60	-	3089	3552
		0880				11	2000	880	4816	2457	1,36	137,80	30,40	-	3345	3847
11383	2200	0240	XXXX	YYYY	-0000	3	2200	240	1903	971	1,25	42,68	8,80	-	1389	1597
		0320				4	2200	320	2365	1207	1,30	56,76	12,10	-	1666	1916
		0400				5	2200	400	2917	1488	1,31	70,84	15,18	-	1945	2237
		0480				6	2200	480	3467	1769	1,33	85,36	18,26	-	2225	2559
		0560				7	2200	560	4017	2050	1,34	99,44	21,34	-	2503	2878
		0640				8	2200	640	4369	2229	1,34	113,74	24,20	-	2782	3199
		0720				9	2200	720	4719	2408	1,34	128,04	27,28	-	3061	3520
		0800				10	2200	800	5071	2587	1,36	142,12	30,36	-	3339	3840
		0880				11	2200	880	5298	2703	1,36	151,58	33,44	-	3617	4160
11383	2400	0240	XXXX	YYYY	-0000	3	2400	240	2076	1059	1,25	46,56	9,60	-	1488	1711
		0320				4	2400	320	2580	1316	1,30	61,92	13,20	-	1788	2056
		0400				5	2400	400	3182	1624	1,31	77,28	16,56	-	2084	2397
		0480				6	2400	480	3782	1930	1,33	93,12	19,92	-	2389	2747
		0560				7	2400	560	4382	2236	1,34	108,48	23,28	-	2687	3090
		0640				8	2400	640	4766	2432	1,34	124,08	26,40	-	2987	3435
		0720				9	2400	720	5148	2627	1,34	139,68	29,76	-	3285	3778
		0800				10	2400	800	5532	2822	1,36	155,04	33,12	-	3586	4124
		0880				11	2400	880	5779	2949	1,36	165,36	36,48	-	3888	4471
11383	2600	0240	XXXX	YYYY	-0000	3	2600	240	2249	1147	1,25	50,44	10,40	-	1585	1823
		0320				4	2600	320	2795	1426	1,30	67,08	14,30	-	1907	2193
		0400				5	2600	400	3448	1759	1,31	83,72	17,94	-	2228	2562
		0480				6	2600	480	4098	2091	1,33	100,88	21,58	-	2551	2934
		0560				7	2600	560	4748	2422	1,34	117,52	25,22	-	2872	3303
		0640				8	2600	640	5164	2634	1,34	134,42	28,60	-	3194	3673
		0720				9	2600	720	5577	2845	1,34	151,32	32,24	-	3513	4040
		0800				10	2600	800	5993	3058	1,36	167,96	35,88	-	3839	4415
		0880				11	2600	880	6261	3194	1,36	179,14	39,52	-	4161	4785

In conformity with EN442-1: 2014: radiators and convectors

For heat outputs in other regimes, see p. 320 (correction factors)
EXPORT. Prices in Euro (excl. VAT)

HOW TO ORDER VIOLA-A HORIZONTAL

Delivery time 15 - 30 working days
(transport duration not included)

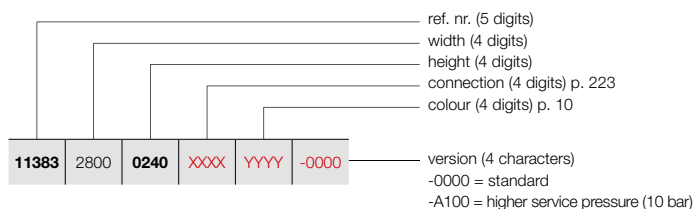

VIOLA-A HORIZONTAL (H2L2-RO-A)



H2L2-RO-A
(thermostatic head to be ordered separately)

PRICE GROUP: VPG2 - STEEL DESIGN RADIATORS

REFERENCE CODE CUSTOM MADE VIOLA-A HORIZONTAL	TECHNICAL DATA									STANDARD COLOUR	OTHER COLOURS					
	tubes	width (L mm)	height (H mm)	75/65/20 (Watt) (Φ50K)	55/45/20 (Watt) (Φ30K)	n-exp.	weight (kg)	water content (l)	electr. resistance (Watt)	price RAL 9016 (€)	price colour (€)					
REF. NR. VIOLA-A HORIZONTAL H2L2-RO-A : 11383																
11383	2800	0240	XXXX	YYYY	-0000	3	2800	240	2422	1236	1,25	54,32	11,20	-	1683	1935
		0320				4	2800	320	3010	1536	1,30	72,24	15,40	-	2026	2330
		0400				5	2800	400	3713	1894	1,31	90,16	19,32	-	2372	2728
		0480				6	2800	480	4413	2251	1,33	108,64	23,24	-	2714	3121
		0560				7	2800	560	5113	2609	1,34	126,56	27,16	-	3059	3518
		0640				8	2800	640	5561	2837	1,34	144,76	30,80	-	3401	3911
		0720				9	2800	720	6006	3064	1,34	162,96	34,72	-	3745	4307
		0800				10	2800	800	6454	3293	1,36	180,88	38,64	-	4088	4701
11383	3000	0240	XXXX	YYYY	-0000	3	3000	240	2595	1324	1,25	58,20	12,00	-	1780	2047
		0320				4	3000	320	3225	1645	1,30	77,40	16,50	-	2146	2468
		0400				5	3000	400	3978	2030	1,31	96,60	20,70	-	2509	2885
		0480				6	3000	480	4728	2412	1,33	116,40	24,90	-	2874	3305
		0560				7	3000	560	5478	2795	1,34	135,60	29,10	-	3242	3728
		0640				8	3000	640	5958	3040	1,34	155,10	33,00	-	3609	4150
		0720				9	3000	720	6435	3283	1,34	174,60	37,20	-	3974	4570



In conformity with EN442-1: 2014: radiators and convectors

For heat outputs in other regimes, see p. 320 (correction factors)
EXPORT. Prices in Euro (excl. VAT)

VIOLA-A WALL BRACKETS





IN OPTION

PRICE GROUP: VPG10 - ACC.

WALL SETUP	WIDTH RADIATOR	COLOUR	REF. NR.	€
TELESCOPIC SUPPORT FEET + ADJUSTABLE WALL BRACKET 	V2-ZB-A			
	(2 feet)	RAL 9016	*	82
		COLOUR	*	94
	H2-RO-A, H2L1-RO-A			
	≤ 2000 mm (2 feet)	RAL 9016	*	82
	≥ 2200 mm (3 feet)	RAL 9016	*	125
	COLOUR	*	144	
* Attention: Feet must be ordered at the same time as the radiator. Please indicate code -0007 for "Finish" when ordering.				
COVER ROSETTE FOOT SCREED 	V2-ZB-A			
		RAL 9016	11810390000	30
• 56 x 56 mm. Number of rosettes = number of feet				
COVER ROSETTE FOOT FINISHED FLOOR 	H2-RO-A, H2L1-RO-A			
		RAL 9016	11810400000	38
• 104 x 84 mm. Number of rosettes = number of feet				

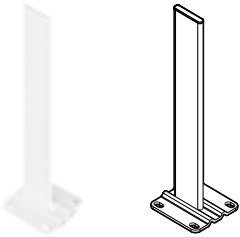
EXPORT. Prices in Euro (excl. VAT)

PRICE GROUP: VPG10 - ACC.



FREE-STANDING INSTALLATION	HEIGHT FOOT	COLOUR	REF. NR.	€
FOOT FREE-STANDING INSTALLATION 	H1-RO-A, H1L1-RO-A, H2-RO-A, H2L1-RO-A, H2L2-RO-A			
	H = 450 mm	RAL 9016	11810350450	61
		COLOUR	11810350450C	70
	H = 550 mm	RAL 9016	11810350550	61
		COLOUR	11810350550C	70
	H = 600 mm	RAL 9016	11810350600	61
		COLOUR	11810350600C	70
	H = 650 mm	RAL 9016	11810350650	61
		COLOUR	11810350650C	70
	H = 750 mm	RAL 9016	11810350750	61
		COLOUR	11810350750C	70
	H = 850 mm	RAL 9016	11810350850	75
		COLOUR	11810350850C	86
	H = 900 mm	RAL 9016	11810350900	75
	COLOUR	11810350900C	86	
H = 1050 mm	RAL 9016	11810351050	75	
	COLOUR	11810351050C	86	
H = 1200 mm	RAL 9016	11810351200	75	
	COLOUR	11810351200C	86	
<ul style="list-style-type: none"> Finished floor: height foot = height radiator + 150 mm Screed: height foot = height radiator + 300 mm Shorten yourself if necessary 				
BRACKET FOOT FREE-STANDING INSTALLATION 	H1-RO-A, H1L1-RO-A, H2-RO-A, H2L1-RO-A, H2L2-RO-A			
		RAL 9016	11810360000	49
	COLOUR	11810360000C	56	
COVER ROSETTE FOOT SCREED 	H1-RO-A, H1L1-RO-A, H2-RO-A, H2L1-RO-A, H2L2-RO-A			
		RAL 9016	11810370000	12
	COLOUR	11810370000C	14	
<ul style="list-style-type: none"> 100 x 40 mm. Number of rosettes = number of feet 				
COVER ROSETTE FOOT FINISHED FLOOR 	H1-RO-A, H1L1-RO-A, H2-RO-A, H2L1-RO-A, H2L2-RO-A			
		RAL 9016	11810380000	15
	COLOUR	11810380000C	17	
<ul style="list-style-type: none"> 115 x 110 mm. Number of rosettes = number of feet 				

height radiator (mm)	Length radiator (mm)	number of feet	number of brackets foot
240 - 880	500-2000	2x	2x
	2200-3000	3x	3x

EXPORT. Prices in Euro (excl. VAT)

VIOLA-A ACCESSORIES
IN OPTION

PRICE GROUP: VPG10 - ACC.

ACCESSORIES		COLOUR	REF. NR.	€
THERMOSTATIC HEAD		V1-ZB-A, V1L1-ZB-A, V2-ZB-A H1-RO-A, H1L1-RO-A, H2-RO-A, H2L1-RO-A, H2L2-RO-A		
		WHITE	11911630102	44
THERMOSTATIC HEAD		V1-ZB-A, V1L1-ZB-A, V2-ZB-A H1-RO-A, H1L1-RO-A, H2-RO-A, H2L1-RO-A, H2L2-RO-A		
		CHROME	11911631102	63

PRICE GROUP: VPG10B - TOWEL RAILS

ACCESSORIES	WIDTH TOWEL RAIL	COLOUR	REF. NR.	€	
HOOK		V1-ZB-A, V1L1-ZB-A, V2-ZB-A			
		CHROME	118341100000099	87	
TOWEL RAIL		V1-ZB-A, V1L1-ZB-A, V2-ZB-A H1-RO-A, H1L1-RO-A, H2-RO-A, H2L1-RO-A, H2L2-RO-A			
		500 mm	CHROME	118327000000099	145
		500 mm	RAL 9016	118327000009016	145
		500 mm	RAL 9005 ^{MB}	118327000009005	145

- h = 70 mm; b = 70 mm; d = 51 mm; a = 43 mm;

- h = 55 mm; b = 500 mm; d = 53 mm; a = 38 mm;

^{MB} matt black

d = distance front of the accessory up to front of the radiator
a = distance accessory up to the radiator

Mounting instructions accessories: see www.vasco.eu
EXPORT. Prices in Euro (excl. VAT)

available from stock

VIOLA-A VERTICAL: V1-ZB-A / V1L1-ZB-A / V2-ZB-A (STOCK)

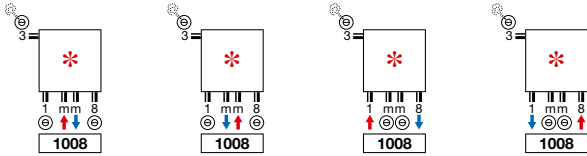

- * Inlet and outlet can be interchangeable
- Above connection for stock radiator with even number of tubes. Also available for non-stock radiators with even number of tubes.

VIOLA-A VERTICAL: V1-ZB-A / V1L1-ZB-A / V2-ZB-A (NON STOCK)

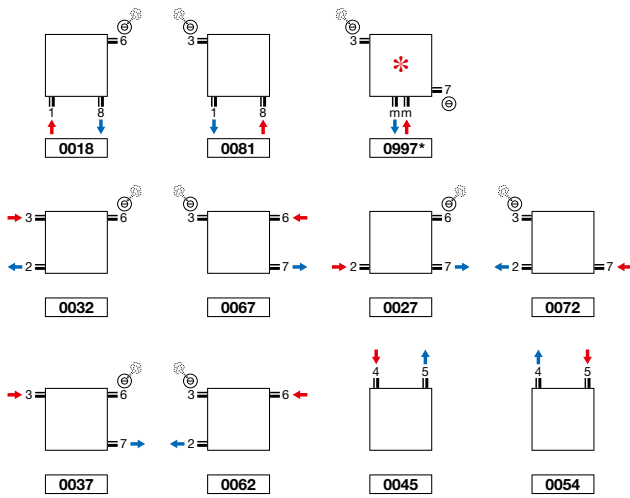

- * Inlet and outlet can be interchangeable
- Connection mm only possible with even number of tubes

VIOLA-A HORIZONTAL: H1-RO-A / H1L1-RO-A / H2-RO-A / H2L1-RO-A / H2L2-RO-A (NON STOCK)

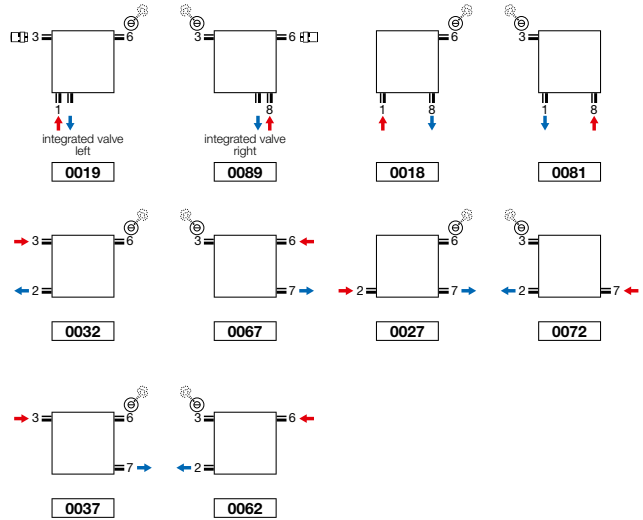

- Connection 0019 and 0089: thermostatic head to be ordered separately
- Integrated valve (extra charge) (see p. 313)

VIOLA-A VERTICAL (V1-ZB-A, V1L1-ZB-A, V2-ZB-A)

V1-ZB-A

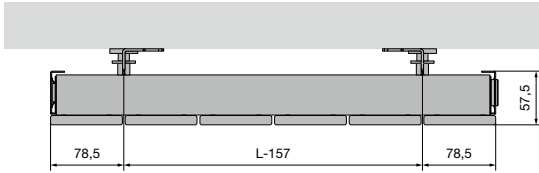

V1L1-ZB-A

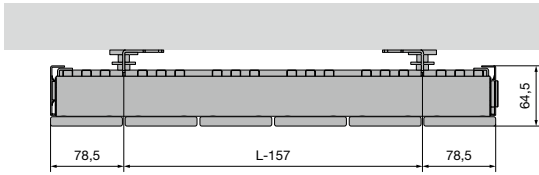

V2-ZB-A

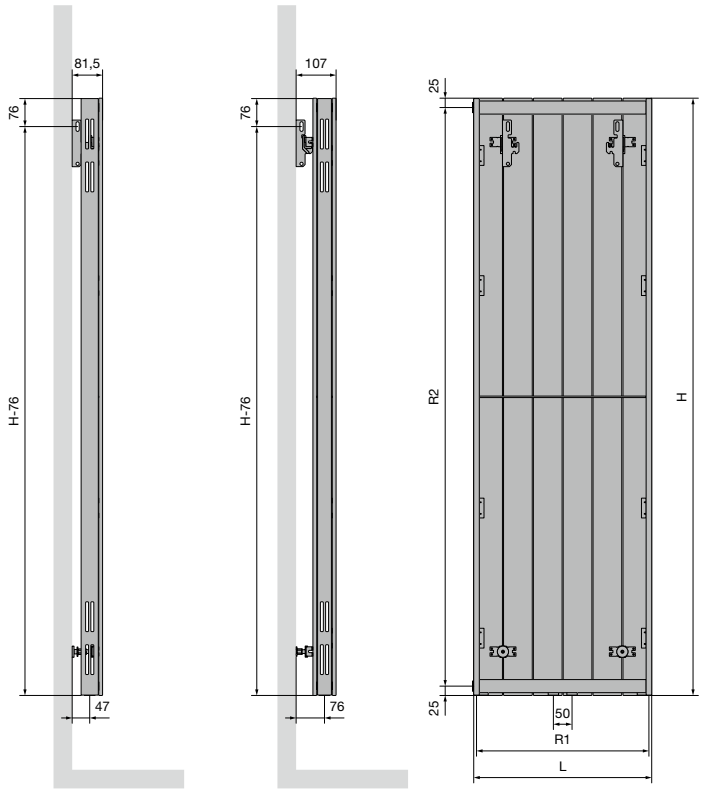
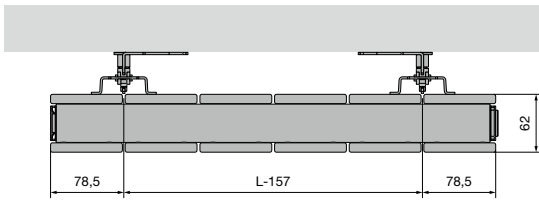

	V1-ZB-A / V1L1-ZB-A / V2-ZB-A											
number of tubes	3	4	5	6	7	8	9	10	11	12	13	
Width (L)	237	317	397	477	557	637	717	797	877	957	1037	
Centre between the connections at the bottom 18 (R1)	187	267	347	427	507	587	667	747	827	907	987	
height (H)	1200	1400	1600	1800	2000	2200	2400					
Centre between the lateral connections 23/67 (R2)	1150	1350	1550	1750	1950	2150	2350					
Centre between the brackets	L-157	H-76										

VIOLA-A HORIZONTAL (H1-RO-A, H1L1-RO-A, H2-RO-A, H2L1-RO-A, H2L2-RO-A)

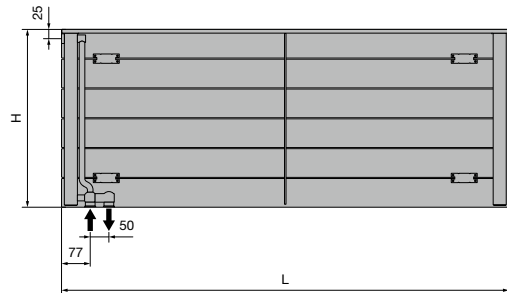
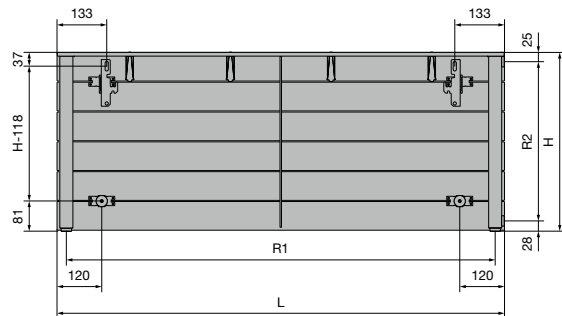
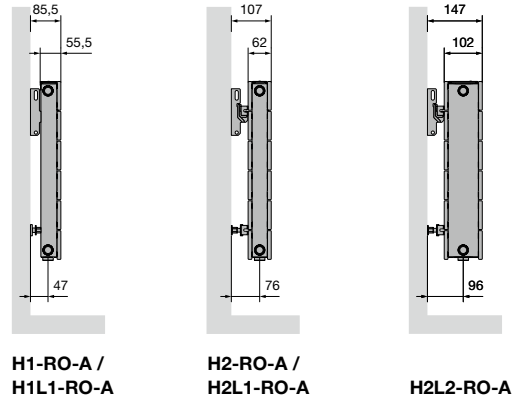
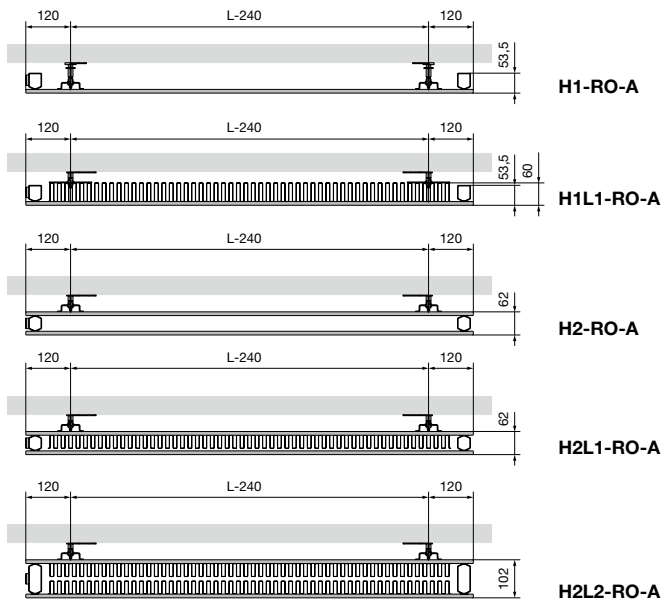

	H1-RO-A / H1L1-RO-A / H2-RO-A / H2L1-RO-A / H2L2-RO-A																
Width (L)	500	600	700	800	900	1000	1100	1200	1400	1600	1800	2000	2200	2400	2600	2800	3000
Centre between the connections at the bottom (R1)	450	550	650	750	850	950	1050	1150	1350	1550	1750	1950	2150	2350	2550	2750	2950
height (H)	240	320	400	480	560	640	720	800	880								
Centre between the lateral connections 23/67 (R2)	187	267	347	427	507	587	667	747	827								
Centre between the brackets	L-240	H-118															

TULIPA-A VERTICAL (TV1-A, TV2-A)



TYPES

- One (TV1-A) or two rows (TV2-A) of tubes

TUBES

- Vertical, flat-oval 60 x 10 mm

COLLECTORS

- Horizontal, rear, round Ø 32 mm

COLOURS

- Standard colour white RAL 9016
- Extensive colour chart see p. 10

SPECIAL

- Tulipa-A 6 and 8 tubes: connection 1mm8, 18, 81 not possible

BRACKETS

- Wall brackets standard (included in packaging of radiator)
- **TV1-A / TV2-A:** also available as free-standing radiator, see p. 240. Additional wall mounting support necessary for height radiator > 600 mm

TECHNICAL

- Welded by means of resistance welding robots (invisible weld seams)
- ATL priming coat, powder coating
- Standard operating pressure: 6 bar. Extra charge for higher service pressures (10 bar): +10%.
- The delivery time of a radiator with a higher service pressure is 1 week extra.
- Maximum operating temperature: 110°C

ELECTRICAL

- ✗ Pure electrical radiator prefilled
- ✗ Mixed radiator

TECHNICAL DRAWINGS

- See p. 243

CONNECTION

- ✗ One-point connection for one-pipe system
- ✗ One-point connection for two-pipe system
- ✓ Two-point connection for one-pipe system (connection by way of the central connection) (see p. 312)
- ✓ Two-point connection for two-pipe system (standard) (see p. 312)
- ✗ Integrated valve
- Connections: ½" (inner thread)

TULIPA-A VERTICAL

Heat in plain sight

A first generation designer radiator. Suitable for all areas and applications. Characterised by its classic open structure and the perpendicular connection of the pipes to the collector. The guarantee for an immaculate heating comfort, everywhere in house.

RECOMMENDED CONNECTION (1008)

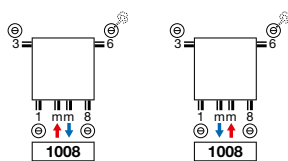

ref. nr. 1182.001.0000.9016
price €129
Fittings, see p. 327



ref. nr. 11911630102
price €44

RECOMMENDED FOR BATHROOM AND KITCHEN IN OPTION



towel rail (RAL 9005)
ref. nr. see p. 241
price €145

Other accessories, see p. 241

Other connection methods, see p. 242



TV1-A / TV2-A

HOW TO ORDER TULIPA-A VERTICAL

Delivery time 15 - 30 working days
(transport duration not included)

11378	0270	1000	XXXX	YYYY	-0000
-------	------	------	------	------	-------

ref. nr. (5 digits)
width (4 digits)
height (4 digits)
connection (4 digits) p. 242
colour (4 digits) p. 10

version (4 characters)
-0000 = standard
-0006 = with fixed feet
-A100 = higher service pressure (10 bar)

FREE-STANDING INSTALLATION (TV1-A)

See p. 240 for additional accessories.

HOW TO ORDER STOCK RADIATOR TULIPA-A VERTICAL

Delivery time 5 working days
(transport duration not included)

11378	-00
-------	-----

ref. nr. (5 digits)
see table below

TULIPA-A VERTICAL (TV1-A)

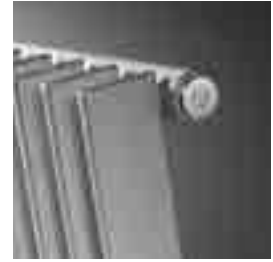

TV1-A

PRICE GROUP: VPG2 - STEEL DESIGN RADIATORS

REFERENCE CODE CUSTOM MADE TULIPA-A VERTICAL	TECHNICAL DATA									STANDARD COLOUR		OTHER COLOURS
	tubes	width (L mm)	height (H mm)	75/65/20 (Watt) (φ50K)	55/45/20 (Watt) (φ30K)	n-exp.	weight (kg)	water content (l)	electr. resistance (Watt)	price RAL 9016 (€)	short ref. nr. RAL 9016 stock	price colour (€)
REF. NR. TULIPA-A VERTICAL TV1-A : 11378												
11378 0270 1000 XXXX YYYY -0000	6	270	1000	384	204	1,24	9,60	2,64	-	262	-	301
	6	270	1200	456	240	1,24	11,40	3,12	-	291	-	335
	6	270	1500	564	294	1,25	14,40	3,84	-	331	-	381
	6	270	1600	600	312	1,26	15,00	4,08	-	343	-	394
	6	270	1800	660	342	1,26	16,80	4,56	-	368	-	423
	6	270	2000	738	384	1,27	18,60	4,98	-	394	-	453
	6	270	2200	810	420	1,27	20,40	5,46	-	421	-	484
	6	270	2500	912	474	1,28	23,40	6,18	-	495	-	569
	6	270	3000	1092	558	1,29	27,60	7,32	-	527	-	606
11378 0360 1000 XXXX YYYY -0000	8	360	1000	512	272	1,24	12,80	3,52	-	325	-	374
	8	360	1200	608	320	1,24	15,20	4,16	-	363	-	417
	8	360	1500	752	392	1,25	19,20	5,12	-	414	-	476
	8	360	1600	800	416	1,26	20,00	5,44	-	433	-	498
	8	360	1800	880	456	1,26	22,40	6,08	-	467	-	537
	8	360	2000	984	512	1,27	24,80	6,64	-	499	-	574
	8	360	2200	1080	560	1,27	27,20	7,28	-	536	-	616
	8	360	2500	1216	632	1,28	31,20	8,24	-	587	-	675
	8	360	3000	1456	744	1,29	36,80	9,76	-	675	-	776
11378 0450 1000 XXXX YYYY -0000	10	450	1000	640	340	1,24	16,00	4,40	-	389	-	447
	10	450	1200	760	400	1,24	19,00	5,20	-	434	-	499
	10	450	1500	940	490	1,25	24,00	6,40	-	499	-	574
	10	450	1600	1000	520	1,26	25,00	6,80	-	522	-	600
	10	450	1800	1100	570	1,26	28,00	7,60	-	564	-	649
	10	450	2000	1230	640	1,27	31,00	8,30	-	606	-	697
	10	450	2200	1350	700	1,27	34,00	9,10	-	647	-	744
	10	450	2500	1520	790	1,28	39,00	10,30	-	717	-	825
	10	450	3000	1820	930	1,29	46,00	12,20	-	823	-	946
11378 0540 1000 XXXX YYYY -0000	12	540	1000	768	408	1,24	19,20	5,28	-	451	-	519
	12	540	1200	912	480	1,24	22,80	6,24	-	505	-	581
	12	540	1500	1128	588	1,25	28,80	7,68	-	582	-	669
	12	540	1600	1200	624	1,26	30,00	8,16	-	607	-	698
	12	540	1800	1320	684	1,26	33,60	9,12	-	661	11378-01	760
	12	540	2000	1476	768	1,27	37,20	9,96	-	710	11378-02	817
	12	540	2200	1620	840	1,27	40,80	10,92	-	764	-	879
	12	540	2500	1824	948	1,28	46,80	12,36	-	842	-	968
	12	540	3000	2184	1116	1,29	55,20	14,64	-	974	-	1120

In conformity with EN442-1: 2014: radiators and convectors

For heat outputs in other regimes, see p. 320 (correction factors)
EXPORT. Prices in Euro (excl. VAT)

TULIPA-A VERTICAL (TV1-A)



TV1-A

HOW TO ORDER TULIPA-A VERTICAL

Delivery time 15 - 30 working days
(transport duration not included)

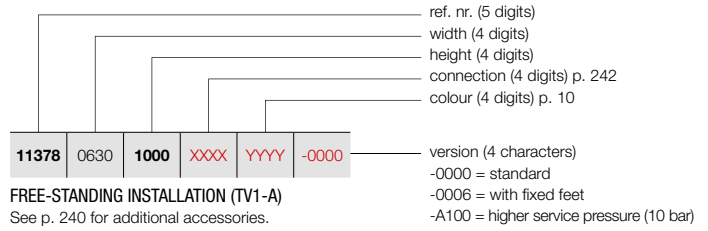

FREE-STANDING INSTALLATION (TV1-A)
See p. 240 for additional accessories.

PRICE GROUP: VPG2 - STEEL DESIGN RADIATORS

REFERENCE CODE CUSTOM MADE TULIPA-A VERTICAL							TECHNICAL DATA					STANDARD COLOUR	OTHER COLOURS			
tubes	width (L mm)	height (H mm)	75/65/20 (Watt) (Φ50K)	55/45/20 (Watt) (Φ30K)	n-exp.	weight (kg)	water content (l)	electr. resistance (Watt)	price RAL 9016 (€)	price colour (€)						
REF. NR. TULIPA-A VERTICAL TV1-A : 11378																
11378	0630	1000	XXXX	YYYY	-0000	14	630	1000	896	476	1,24	22,40	6,16	-	515	592
		1200				14	630	1200	1064	560	1,24	26,60	7,28	-	573	659
		1500				14	630	1500	1316	686	1,25	33,60	8,96	-	667	767
		1600				14	630	1600	1400	728	1,26	35,00	9,52	-	697	802
		1800				14	630	1800	1540	798	1,26	39,20	10,64	-	757	871
		2000				14	630	2000	1722	896	1,27	43,40	11,62	-	819	942
		2200				14	630	2200	1890	980	1,27	47,60	12,74	-	881	1013
		2500				14	630	2500	2128	1106	1,28	54,60	14,42	-	969	1114
		3000				14	630	3000	2548	1302	1,29	64,40	17,08	-	1121	1289
11378	0720	1000	XXXX	YYYY	-0000	16	720	1000	1024	544	1,24	25,60	7,04	-	578	665
		1200				16	720	1200	1216	640	1,24	30,40	8,32	-	644	741
		1500				16	720	1500	1504	784	1,25	38,40	10,24	-	750	863
		1600				16	720	1600	1600	832	1,26	40,00	10,88	-	785	903
		1800				16	720	1800	1760	912	1,26	44,80	12,16	-	854	982
		2000				16	720	2000	1968	1024	1,27	49,60	13,28	-	923	1061
		2200				16	720	2200	2160	1120	1,27	54,40	14,56	-	994	1143
		2500				16	720	2500	2432	1264	1,28	62,40	16,48	-	1098	1263
		3000				16	720	3000	2912	1488	1,29	73,60	19,52	-	1269	1459
11378	0810	1000	XXXX	YYYY	-0000	18	810	1000	1152	612	1,24	28,80	7,92	-	638	734
		1200				18	810	1200	1368	720	1,24	34,20	9,36	-	717	825
		1500				18	810	1500	1692	882	1,25	43,20	11,52	-	831	956
		1600				18	810	1600	1800	936	1,26	45,00	12,24	-	870	1001
		1800				18	810	1800	1980	1026	1,26	50,40	13,68	-	953	1096
		2000				18	810	2000	2214	1152	1,27	55,80	14,94	-	1029	1183
		2200				18	810	2200	2430	1260	1,27	61,20	16,38	-	1107	1273
		2500				18	810	2500	2736	1422	1,28	70,20	18,54	-	1225	1409
		3000				18	810	3000	3276	1674	1,29	82,80	21,96	-	1420	1633
11378	0900	1000	XXXX	YYYY	-0000	20	900	1000	1280	680	1,24	32,00	8,80	-	702	807
		1200				20	900	1200	1520	800	1,24	38,00	10,40	-	787	905
		1500				20	900	1500	1880	980	1,25	48,00	12,80	-	917	1055
		1600				20	900	1600	2000	1040	1,26	50,00	13,60	-	961	1105
		1800				20	900	1800	2200	1140	1,26	56,00	15,20	-	1050	1208
		2000				20	900	2000	2460	1280	1,27	62,00	16,60	-	1134	1304
		2200				20	900	2200	2700	1400	1,27	68,00	18,20	-	1223	1406
		2500				20	900	2500	3040	1580	1,28	78,00	20,60	-	1352	1555
		3000				20	900	3000	3640	1860	1,29	92,00	24,40	-	1566	1801

In conformity with EN442-1: 2014: radiators and convectors

For heat outputs in other regimes, see p. 320 (correction factors)
EXPORT. Prices in Euro (excl. VAT)

HOW TO ORDER TULIPA-A VERTICAL

Delivery time 15 - 30 working days
(transport duration not included)

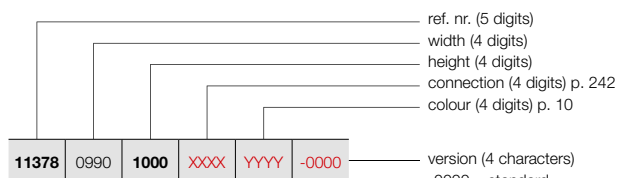

FREE-STANDING INSTALLATION (TV1-A)

See p. 240 for additional accessories.

TULIPA-A VERTICAL (TV1-A)



TV1-A

PRICE GROUP: VPG2 - STEEL DESIGN RADIATORS

REFERENCE CODE CUSTOM MADE TULIPA-A VERTICAL	TECHNICAL DATA									STANDARD COLOUR	OTHER COLOURS					
	tubes	width (L mm)	height (H mm)	75/65/20 (Watt) (Φ50K)	55/45/20 (Watt) (Φ30K)	n-exp.	weight (kg)	water content (l)	electr. resistance (Watt)	price RAL 9016 (€)	price colour (€)					
REF. NR. TULIPA-A VERTICAL TV1-A : 11378																
11378	0990	1000	XXXX	YYYY	-0000	22	990	1000	1408	748	1,24	35,20	9,68	-	764	879
						22	990	1200	1672	880	1,24	41,80	11,44	-	859	988
						22	990	1500	2068	1078	1,25	52,80	14,08	-	1004	1155
						22	990	1600	2200	1144	1,26	55,00	14,96	-	1051	1209
						22	990	1800	2420	1254	1,26	61,60	16,72	-	1147	1319
						22	990	2000	2706	1408	1,27	68,20	18,26	-	1240	1426
						22	990	2200	2970	1540	1,27	74,80	20,02	-	1337	1538
						22	990	2500	3344	1738	1,28	85,80	22,66	-	1479	1701
11378	1080	1000	XXXX	YYYY	-0000	24	1080	1000	1536	816	1,24	38,40	10,56	-	827	951
						24	1080	1200	1824	960	1,24	45,60	12,48	-	929	1068
						24	1080	1500	2256	1176	1,25	57,60	15,36	-	1086	1249
						24	1080	1600	2400	1248	1,26	60,00	16,32	-	1139	1310
						24	1080	1800	2640	1368	1,26	67,20	18,24	-	1241	1427
						24	1080	2000	2952	1536	1,27	74,40	19,92	-	1346	1548
						24	1080	2200	3240	1680	1,27	81,60	21,84	-	1452	1670
11378	1170	1000	XXXX	YYYY	-0000	26	1170	1000	1664	884	1,24	41,60	11,44	-	889	1022
						26	1170	1200	1976	1040	1,24	49,40	13,52	-	1001	1151
						26	1170	1500	2444	1274	1,25	62,40	16,64	-	1171	1347
						26	1170	1600	2600	1352	1,26	65,00	17,68	-	1227	1411
						26	1170	1800	2860	1482	1,26	72,80	19,76	-	1339	1540
						26	1170	2000	3198	1664	1,27	80,60	21,58	-	1453	1671
11378	1260	1000	XXXX	YYYY	-0000	28	1260	1000	1792	952	1,24	44,80	12,32	-	953	1096
						28	1260	1200	2128	1120	1,24	53,20	14,56	-	1072	1233
						28	1260	1500	2632	1372	1,25	67,20	17,92	-	1253	1441
						28	1260	1600	2800	1456	1,26	70,00	19,04	-	1314	1511
						28	1260	1800	3080	1596	1,26	78,40	21,28	-	1437	1653

In conformity with EN442-1: 2014: radiators and convectors

For heat outputs in other regimes, see p. 320 (correction factors)
EXPORT. Prices in Euro (excl. VAT)

TULIPA-A VERTICAL (TV2-A)



TV2-A

HOW TO ORDER TULIPA-A VERTICAL

Delivery time 15 - 30 working days
(transport duration not included)

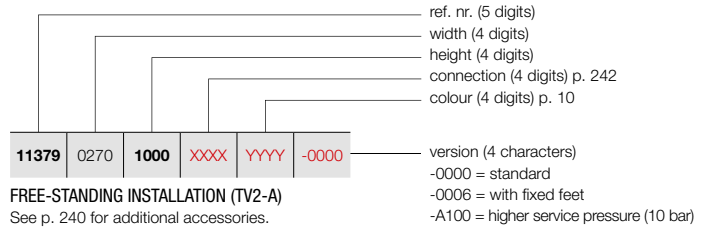

FREE-STANDING INSTALLATION (TV2-A)

See p. 240 for additional accessories.

HOW TO ORDER STOCK RADIATOR VIOLA-A VERTICAL

Delivery time 5 working days
(transport duration not included)

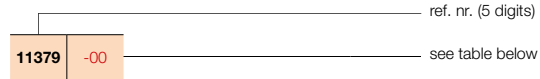

PRICE GROUP: VPG2 - STEEL DESIGN RADIATORS

REFERENCE CODE CUSTOM MADE TULIPA-A VERTICAL							TECHNICAL DATA					STANDARD COLOUR		OTHER COLOURS			
tubes	width (L mm)	height (H mm)	75/65/20 (Watt) (Φ50K)	55/45/20 (Watt) (Φ30K)	n-exp.	weight (kg)	water content (l)	electr. resistance (Watt)	price RAL 9016 (€)	short ref. nr. RAL 9016 stock	price colour (€)						
REF. NR. TULIPA-A VERTICAL TV2-A : 11379																	
11379	0270	1000	XXXX	YYYY	-0000	6	270	1000	636	330	1,26	18,60	4,98	-	464	-	534
		1200				6	270	1200	750	390	1,26	22,20	5,94	-	510	-	587
		1500				6	270	1500	924	480	1,27	27,60	7,32	-	577	-	664
		1600				6	270	1600	984	504	1,28	29,40	7,80	-	600	-	690
		1800				6	270	1800	1134	582	1,28	33,00	8,70	-	642	-	738
		2000				6	270	2000	1212	624	1,29	36,60	9,66	-	693	-	797
		2200				6	270	2200	1326	684	1,29	40,20	10,56	-	739	-	850
		2500				6	270	2500	1500	768	1,30	45,60	12,00	-	807	-	928
		3000				6	270	3000	1788	906	1,31	54,60	14,34	-	920	-	1058
11379	0360	1000	XXXX	YYYY	-0000	8	360	1000	848	440	1,26	24,80	6,64	-	571	-	657
		1200				8	360	1200	1000	520	1,26	29,60	7,92	-	633	-	728
		1500				8	360	1500	1232	640	1,27	36,80	9,76	-	726	-	835
		1600				8	360	1600	1312	672	1,28	39,20	10,40	-	755	-	868
		1800				8	360	1800	1512	776	1,28	44,00	11,60	-	816	-	938
		2000				8	360	2000	1616	832	1,29	48,80	12,88	-	880	-	1012
		2200				8	360	2200	1768	912	1,29	53,60	14,08	-	936	-	1076
		2500				8	360	2500	2000	1024	1,30	60,80	16,00	-	1028	-	1182
		3000				8	360	3000	2384	1208	1,31	72,80	19,12	-	1180	-	1357
11379	0450	1000	XXXX	YYYY	-0000	10	450	1000	1060	550	1,26	31,00	8,30	-	681	-	783
		1200				10	450	1200	1250	650	1,26	37,00	9,90	-	756	-	869
		1500				10	450	1500	1540	800	1,27	46,00	12,20	-	872	-	1003
		1600				10	450	1600	1640	840	1,28	49,00	13,00	-	909	-	1045
		1800				10	450	1800	1890	970	1,28	55,00	14,50	-	988	-	1136
		2000				10	450	2000	2020	1040	1,29	61,00	16,10	-	1062	-	1221
		2200				10	450	2200	2210	1140	1,29	67,00	17,60	-	1136	-	1306
		2500				10	450	2500	2500	1280	1,30	76,00	20,00	-	1254	-	1442
		3000				10	450	3000	2980	1510	1,31	91,00	23,90	-	1442	-	1658
11379	0540	1000	XXXX	YYYY	-0000	12	540	1000	1272	660	1,26	37,20	9,96	-	788	-	906
		1200				12	540	1200	1500	780	1,26	44,40	11,88	-	885	-	1018
		1500				12	540	1500	1848	960	1,27	55,20	14,64	-	1020	-	1173
		1600				12	540	1600	1968	1008	1,28	58,80	15,60	-	1064	-	1224
		1800				12	540	1800	2268	1164	1,28	66,00	17,40	-	1156	-	1329
		2000				12	540	2000	2424	1248	1,29	73,20	19,32	-	1244	11379-01	1431
		2200				12	540	2200	2652	1368	1,29	80,40	21,12	-	1337	-	1538
		2500				12	540	2500	3000	1536	1,30	91,20	24,00	-	1474	-	1695
		3000				12	540	3000	3576	1812	1,31	109,20	28,68	-	1703	-	1958

In conformity with EN442-1: 2014: radiators and convectors

For heat outputs in other regimes, see p. 320 (correction factors)
EXPORT. Prices in Euro (excl. VAT)

HOW TO ORDER TULIPA-A VERTICAL

Delivery time 15 - 30 working days
(transport duration not included)

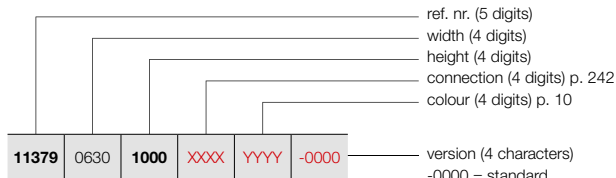

FREE-STANDING INSTALLATION (TV2-A)

See p. 240 for additional accessories.

- version (4 characters)
- 0000 = standard
- 0006 = with fixed feet
- A100 = higher service pressure (10 bar)

HOW TO ORDER STOCK RADIATOR VIOLA-A VERTICAL

Delivery time 5 working days
(transport duration not included)

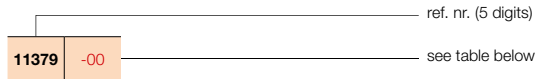

TULIPA-A VERTICAL (TV2-A)



TV2-A

PRICE GROUP: VPG2 - STEEL DESIGN RADIATORS

REFERENCE CODE CUSTOM MADE TULIPA-A VERTICAL	TECHNICAL DATA									STANDARD COLOUR		OTHER COLOURS
	tubes	width (L mm)	height (H mm)	75/65/20 (Watt) (Φ50K)	55/45/20 (Watt) (Φ30K)	n-exp.	weight (kg)	water content (l)	electr. resistance (Watt)	price RAL 9016 (€)	short ref. nr. RAL 9016 stock	price colour (€)
REF. NR. TULIPA-A VERTICAL TV2-A : 11379												
11379	0630	1000	XXXX	YYYY	-0000							
		1200								901	-	1036
		1500								1008	-	1159
		1600								1168	-	1343
		1800								1221	-	1404
		2000								1326	-	1525
		2200								1434	11379-02	1649
		2500								1537	-	1768
		3000								1699	-	1954
										1963	-	2257
11379	0720	1000	XXXX	YYYY	-0000							
		1200								1011	-	1163
		1500								1132	-	1302
		1600								1314	-	1511
		1800								1373	-	1579
		2000								1493	-	1717
		2200								1616	-	1858
		2500								1738	-	1999
		3000								1921	-	2209
										2223	-	2556
11379	0810	1000	XXXX	YYYY	-0000							
		1200								1120	-	1288
		1500								1258	-	1447
		1600								1459	-	1678
		1800								1527	-	1756
		2000								1662	-	1911
		2200								1801	-	2071
		2500								1939	-	2230
		3000								2144	-	2466
										2484	-	2857
11379	0900	1000	XXXX	YYYY	-0000							
		1200								1228	-	1412
		1500								1380	-	1587
		1600								1607	-	1848
		1800								1685	-	1938
		2000								1835	-	2110
		2200								1983	-	2280
		2500								2139	-	2460
		3000								2368	-	2723
										2744	-	3156

In conformity with EN442-1: 2014: radiators and convectors

For heat outputs in other regimes, see p. 320 (correction factors)
EXPORT. Prices in Euro (excl. VAT)

TULIPA-A VERTICAL (TV2-A)



TV2-A

HOW TO ORDER TULIPA-A VERTICAL

Delivery time 15 - 30 working days
(transport duration not included)

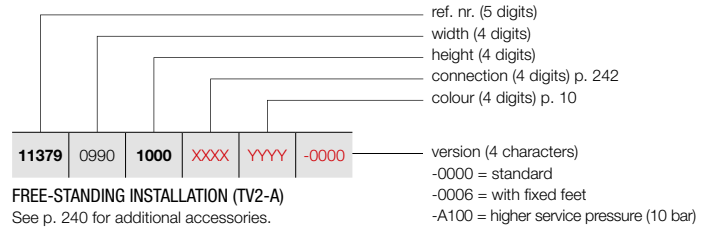

FREE-STANDING INSTALLATION (TV2-A)
See p. 240 for additional accessories.

PRICE GROUP: VPG2 - STEEL DESIGN RADIATORS

REFERENCE CODE CUSTOM MADE TULIPA-A VERTICAL							TECHNICAL DATA					STANDARD COLOUR	OTHER COLOURS			
tubes	width (L mm)	height (H mm)	75/65/20 (Watt) (Φ50K)	55/45/20 (Watt) (Φ30K)	n-exp.	weight (kg)	water content (l)	electr. resistance (Watt)	price RAL 9016 (€)	price colour (€)						
REF. NR. TULIPA-A VERTICAL TV2-A : 11379																
11379	0990	1000	XXXX	YYYY	-0000	22	990	1000	2332	1210	1,26	68,20	18,26	-	1337	1538
		1200				22	990	1200	2750	1430	1,26	81,40	21,78	-	1502	1727
		1500				22	990	1500	3388	1760	1,27	101,20	26,84	-	1753	2016
		1600				22	990	1600	3608	1848	1,28	107,80	28,60	-	1837	2113
		1800				22	990	1800	4158	2134	1,28	121,00	31,90	-	2007	2308
		2000				22	990	2000	4444	2288	1,29	134,20	35,42	-	2174	2500
		2200				22	990	2200	4862	2508	1,29	147,40	38,72	-	2339	2690
		2500				22	990	2500	5500	2816	1,30	167,20	44,00	-	2589	2977
11379	1080	1000	XXXX	YYYY	-0000	24	1080	1000	2544	1320	1,26	74,40	19,92	-	1446	1663
		1200				24	1080	1200	3000	1560	1,26	88,80	23,76	-	1626	1870
		1500				24	1080	1500	3696	1920	1,27	110,40	29,28	-	1904	2190
		1600				24	1080	1600	3936	2016	1,28	117,60	31,20	-	1997	2297
		1800				24	1080	1800	4536	2328	1,28	132,00	34,80	-	2175	2501
		2000				24	1080	2000	4848	2496	1,29	146,40	38,64	-	2355	2708
		2200				24	1080	2200	5304	2736	1,29	160,80	42,24	-	2539	2920
11379	1170	1000	XXXX	YYYY	-0000	26	1170	1000	2756	1430	1,26	80,60	21,58	-	1554	1787
		1200				26	1170	1200	3250	1690	1,26	96,20	25,74	-	1754	2017
		1500				26	1170	1500	4004	2080	1,27	119,60	31,72	-	2048	2355
		1600				26	1170	1600	4264	2184	1,28	127,40	33,80	-	2147	2469
		1800				26	1170	1800	4914	2522	1,28	143,00	37,70	-	2346	2698
		2000				26	1170	2000	5252	2704	1,29	158,60	41,86	-	2541	2922
11379	1260	1000	XXXX	YYYY	-0000	28	1260	1000	2968	1540	1,26	86,80	23,24	-	1662	1911
		1200				28	1260	1200	3500	1820	1,26	103,60	27,72	-	1876	2157
		1500				28	1260	1500	4312	2240	1,27	128,80	34,16	-	2194	2523
		1600				28	1260	1600	4592	2352	1,28	137,20	36,40	-	2299	2644
		1800				28	1260	1800	5292	2716	1,28	154,00	40,60	-	2511	2888

In conformity with EN442-1: 2014: radiators and convectors

For heat outputs in other regimes, see p. 320 (correction factors)
EXPORT. Prices in Euro (excl. VAT)

TYPES

- One (TH1-A) or two rows (TH2-A) of tubes

TUBES

- Vertical, flat-oval 60 x 10 mm

COLLECTORS

- Horizontal, rear, round Ø 32 mm

COLOURS

- Standard colour white RAL 9016
- Extensive colour chart see p. 10

SPECIAL

- TH1-A also available as toilet radiator (540 x 500 mm)

BRACKETS

- Wall brackets standard (included in packaging of radiator)
- **TH1-A / TH2-A:** also available as free-standing radiator, see p. 240. Additional wall mounting support necessary for height radiator > 600 mm.

TECHNICAL

- Welded by means of resistance welding robots (invisible weld seams)
- ATL priming coat, powder coating
- Standard operating pressure: 6 bar. Extra charge for higher service pressures (10 bar): +10%.
- The delivery time of a radiator with a higher service pressure is 1 week extra.
- Maximum operating temperature: 110°C

ELECTRICAL

- ✗ Pure electrical radiator prefilled
- ✗ Mixed radiator

TECHNICAL DRAWINGS

- See p. 243

CONNECTION

- ✗ One-point connection for one-pipe system
- ✗ One-point connection for two-pipe system
- ✓ Two-point connection for one-pipe system (connection by way of the central connection) (see p. 312)
- ✓ Two-point connection for two-pipe system (standard) (see p. 312)
- ✗ Integrated valve
- Connections: ½" (inner thread)



TULIPA-A HORIZONTAL

Eternal charm, timeless class

The horizontal version of the Tulipa-A. The textbook example of a designer radiator in its most authentic form. Characterised by its classic open structure and the perpendicular connection of the pipes to the collector. A designer radiator which continues to charm. A classic that fits anywhere.

RECOMMENDED CONNECTION (0018)

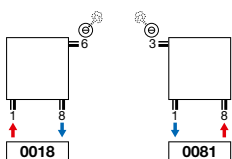

ref. nr. 1182 101 0000 0099
price €218
 Fittings, see p. 327

Other connection methods, see p. 242

RECOMMENDED FOR BATHROOM AND KITCHEN IN OPTION



towel rail (RAL 9005)
 ref. nr. see p. 241
price €145
 Other accessories, see p. 241



TULIPA-A HORIZONTAL (TH1-A)

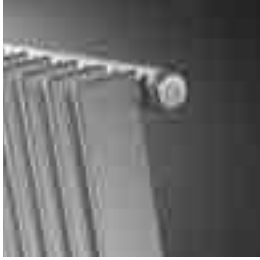

TH1-A

HOW TO ORDER TULIPA-A HORIZONTAL

Delivery time 15 - 30 working days
(transport duration not included)

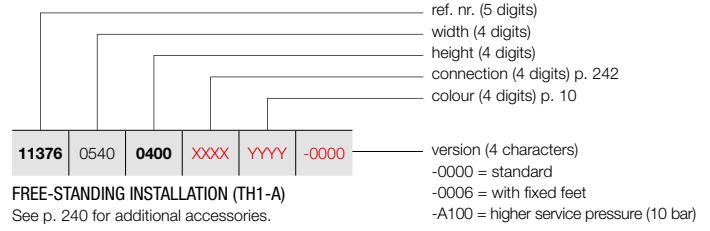

FREE-STANDING INSTALLATION (TH1-A)
See p. 240 for additional accessories.

PRICE GROUP: VPG2 - STEEL DESIGN RADIATORS

REFERENCE CODE CUSTOM MADE TULIPA-A HORIZONTAL							TECHNICAL DATA					STANDARD COLOUR	OTHER COLOURS			
tubes	width (L mm)	height (H mm)	75/65/20 (Watt) (Φ50K)	55/45/20 (Watt) (Φ30K)	n-exp.	weight (kg)	water content (l)	electr. resistance (Watt)	price RAL 9016 (€)	price colour (€)						
REF. NR. TULIPA-A HORIZONTAL TH1-A : 11376																
11376	0540	0400	XXXX	YYYY	-0000	12	540	400	348	180	1,22	9,60	2,52	-	296	340
		0500				12	540	500	420	216	1,23	10,80	3,00	-	322	370
		0600				12	540	600	492	264	1,23	12,00	3,48	-	350	403
		0700				12	540	700	564	300	1,23	14,40	3,96	-	374	430
		0800				12	540	800	636	336	1,23	15,60	4,44	-	400	460
		0900				12	540	900	696	372	1,24	18,00	4,92	-	426	490
11376	0630	0400	XXXX	YYYY	-0000	14	630	400	406	210	1,22	11,20	2,94	-	329	378
		0500				14	630	500	490	252	1,23	12,60	3,50	-	363	417
		0600				14	630	600	574	308	1,23	15,40	4,06	-	392	451
		0700				14	630	700	658	350	1,23	16,80	4,62	-	422	485
		0800				14	630	800	742	392	1,23	18,20	5,18	-	455	523
		0900				14	630	900	812	434	1,24	21,00	5,74	-	483	555
11376	0720	0400	XXXX	YYYY	-0000	16	720	400	464	240	1,22	12,80	3,36	-	368	423
		0500				16	720	500	560	288	1,23	14,40	4,00	-	403	463
		0600				16	720	600	656	352	1,23	17,60	4,64	-	438	504
		0700				16	720	700	752	400	1,23	19,20	5,28	-	471	542
		0800				16	720	800	848	448	1,23	20,80	5,92	-	509	585
		0900				16	720	900	928	496	1,24	24,00	6,56	-	541	622
11376	0810	0400	XXXX	YYYY	-0000	18	810	400	522	270	1,22	14,40	3,78	-	405	466
		0500				18	810	500	630	324	1,23	16,20	4,50	-	443	509
		0600				18	810	600	738	396	1,23	19,80	5,22	-	483	555
		0700				18	810	700	846	450	1,23	21,60	5,94	-	523	601
		0800				18	810	800	954	504	1,23	23,40	6,66	-	563	647
		0900				18	810	900	1044	558	1,24	27,00	7,38	-	600	690
11376	0900	0400	XXXX	YYYY	-0000	20	900	400	580	300	1,22	16,00	4,20	-	442	508
		0500				20	900	500	700	360	1,23	18,00	5,00	-	485	558
		0600				20	900	600	820	440	1,23	22,00	5,80	-	529	608
		0700				20	900	700	940	500	1,23	24,00	6,60	-	570	656
		0800				20	900	800	1060	560	1,23	26,00	7,40	-	615	707
		0900				20	900	900	1160	620	1,24	30,00	8,20	-	660	759
11376	0990	0400	XXXX	YYYY	-0000	22	990	400	638	330	1,22	17,60	4,62	-	475	546
		0500				22	990	500	770	396	1,23	19,80	5,50	-	527	606
		0600				22	990	600	902	484	1,23	24,20	6,38	-	571	657
		0700				22	990	700	1034	550	1,23	26,40	7,26	-	622	715
		0800				22	990	800	1166	616	1,23	28,60	8,14	-	670	771
		0900				22	990	900	1276	682	1,24	33,00	9,02	-	714	821
11376	1080	0400	XXXX	YYYY	-0000	24	1080	400	696	360	1,22	19,20	5,04	-	515	592
		0500				24	1080	500	840	432	1,23	21,60	6,00	-	566	651
		0600				24	1080	600	984	528	1,23	26,40	6,96	-	618	711
		0700				24	1080	700	1128	600	1,23	28,80	7,92	-	671	772
		0800				24	1080	800	1272	672	1,23	31,20	8,88	-	724	833
		0900				24	1080	900	1392	744	1,24	36,00	9,84	-	774	890

In conformity with EN442-1: 2014: radiators and convectors

For heat outputs in other regimes, see p. 320 (correction factors)
EXPORT. Prices in Euro (excl. VAT)

HOW TO ORDER TULIPA-A HORIZONTAL

Delivery time 15 - 30 working days
(transport duration not included)

TULIPA-A HORIZONTAL (TH1-A)

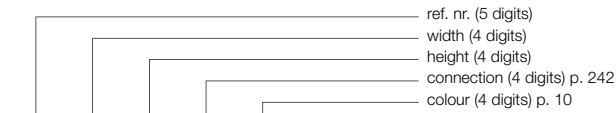

11376	1170	0400	XXXX	YYYY	-0000
-------	------	------	------	------	-------

version (4 characters)
-0000 = standard
-0006 = with fixed feet
-A100 = higher service pressure (10 bar)

FREE-STANDING INSTALLATION (TH1-A)
See p. 240 for additional accessories.

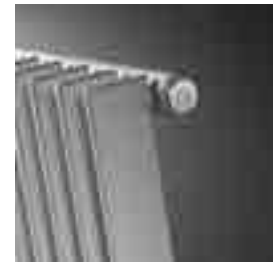

TH1-A

PRICE GROUP: VPG2 - STEEL DESIGN RADIATORS

REFERENCE CODE CUSTOM MADE TULIPA-A HORIZONTAL	TECHNICAL DATA									STANDARD COLOUR	OTHER COLOURS					
	tubes	width (L mm)	height (H mm)	75/65/20 (Watt) (φ50K)	55/45/20 (Watt) (φ30K)	n-exp.	weight (kg)	water content (l)	electr. resistance (Watt)	price RAL 9016 (€)	price colour (€)					
REF. NR. TULIPA-A HORIZONTAL TH1-A : 11376																
11376	1170	0400	XXXX	YYYY	-0000	26	1170	400	754	390	1,22	20,80	5,46	-	550	633
		0500				26	1170	500	910	468	1,23	23,40	6,50	-	606	697
		0600				26	1170	600	1066	572	1,23	28,60	7,54	-	665	765
		0700				26	1170	700	1222	650	1,23	28,80	8,58	-	718	826
		0800				26	1170	800	1378	728	1,23	31,20	9,62	-	775	891
		0900				26	1170	900	1508	806	1,24	36,00	10,66	-	833	958
11376	1260	0400	XXXX	YYYY	-0000	28	1260	400	812	420	1,22	22,40	5,88	-	588	676
		0500				28	1260	500	980	504	1,23	25,20	7,00	-	646	743
		0600				28	1260	600	1148	616	1,23	30,80	8,12	-	706	812
		0700				28	1260	700	1316	700	1,23	33,60	9,24	-	768	883
		0800				28	1260	800	1484	784	1,23	36,40	10,36	-	831	956
		0900				28	1260	900	1624	868	1,24	42,00	11,48	-	891	1025
11376	1440	0400	XXXX	YYYY	-0000	32	1440	400	928	480	1,22	25,60	6,72	-	660	759
		0500				32	1440	500	1120	576	1,23	28,80	8,00	-	730	840
		0600				32	1440	600	1312	704	1,23	35,20	9,28	-	798	918
		0700				32	1440	700	1504	800	1,23	38,40	10,56	-	865	995
		0800				32	1440	800	1696	896	1,23	41,60	11,84	-	935	1075
		0900				32	1440	900	1856	992	1,24	48,00	13,12	-	1007	1158
11376	1620	0400	XXXX	YYYY	-0000	36	1620	400	1044	540	1,22	28,80	7,56	-	732	842
		0500				36	1620	500	1260	648	1,23	32,40	9,00	-	810	932
		0600				36	1620	600	1476	792	1,23	39,60	10,44	-	889	1022
		0700				36	1620	700	1692	900	1,23	43,20	11,88	-	964	1109
		0800				36	1620	800	1908	1008	1,23	46,80	13,32	-	1048	1205
		0900				36	1620	900	2088	1116	1,24	54,00	14,76	-	1121	1289
11376	1800	0400	XXXX	YYYY	-0000	40	1800	400	1160	600	1,22	32,00	8,40	-	804	925
		0500				40	1800	500	1400	720	1,23	36,00	10,00	-	892	1026
		0600				40	1800	600	1640	880	1,23	44,00	11,60	-	978	1125
		0700				40	1800	700	1880	1000	1,23	48,00	13,20	-	1064	1224
		0800				40	1800	800	2120	1120	1,23	52,00	14,80	-	1152	1325
		0900				40	1800	900	2320	1240	1,24	60,00	16,40	-	1238	1424
11376	1980	0400	XXXX	YYYY	-0000	44	1980	400	1276	660	1,22	35,20	9,24	-	880	1012
		0500				44	1980	500	1540	792	1,23	39,60	11,00	-	974	1120
		0600				44	1980	600	1804	968	1,23	48,40	12,76	-	1069	1229
		0700				44	1980	700	2068	1100	1,23	52,80	14,52	-	1161	1335
		0800				44	1980	800	2332	1232	1,23	57,20	16,28	-	1259	1448
		0900				44	1980	900	2552	1364	1,24	66,00	18,04	-	1352	1555
11376	2160	0400	XXXX	YYYY	-0000	48	2160	400	1392	720	1,22	38,40	10,08	-	953	1096
		0500				48	2160	500	1680	864	1,23	43,20	12,00	-	1054	1212
		0600				48	2160	600	1968	1056	1,23	52,80	13,92	-	1157	1331
		0700				48	2160	700	2256	1200	1,23	57,60	15,84	-	1264	1454
		0800				48	2160	800	2544	1344	1,23	62,40	17,76	-	1367	1572
		0900				48	2160	900	2784	1488	1,24	72,00	19,68	-	1471	1692

In conformity with EN442-1: 2014: radiators and convectors

For heat outputs in other regimes, see p. 320 (correction factors)
EXPORT. Prices in Euro (excl. VAT)

VASCO

TULIPA-A HORIZONTAL (TH1-A)

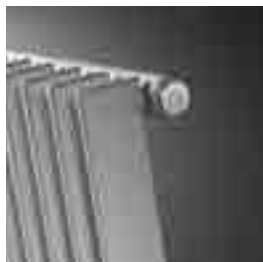

TH1-A

HOW TO ORDER TULIPA-A HORIZONTAL

Delivery time 15 - 30 working days
(transport duration not included)

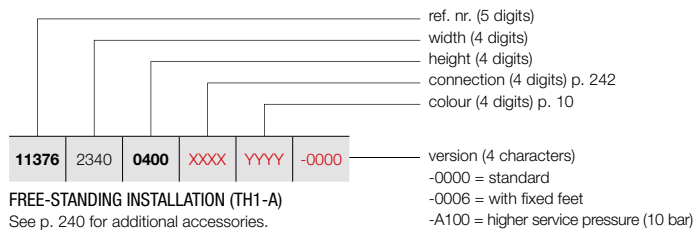

FREE-STANDING INSTALLATION (TH1-A)

See p. 240 for additional accessories.

PRICE GROUP: VPG2 - STEEL DESIGN RADIATORS

REFERENCE CODE CUSTOM MADE TULIPA-A HORIZONTAL							TECHNICAL DATA					STANDARD COLOUR	OTHER COLOURS			
tubes	width (L mm)	height (H mm)	75/65/20 (Watt) (Φ50K)	55/45/20 (Watt) (Φ30K)	n-exp.	weight (kg)	water content (l)	electr. resistance (Watt)	price RAL 9016 (€)	price colour (€)						
REF. NR. TULIPA-A HORIZONTAL TH1-A : 11376																
11376	2340	0400	XXXX	YYYY	-0000	52	2340	400	1508	780	1,22	41,60	10,92	-	1022	1175
		0500				52	2340	500	1820	936	1,23	46,80	13,00	-	1136	1306
		0600				52	2340	600	2132	1144	1,23	57,20	15,08	-	1245	1432
		0700				52	2340	700	2444	1300	1,23	62,40	17,16	-	1364	1569
		0800				52	2340	800	2756	1456	1,23	67,60	19,24	-	1474	1695
		0900				52	2340	900	3016	1612	1,24	78,00	21,32	-	1587	1825
11376	2520	0400	XXXX	YYYY	-0000	56	2520	400	1624	840	1,22	44,80	11,76	-	1095	1259
		0500				56	2520	500	1960	1008	1,23	50,40	14,00	-	1219	1402
		0600				56	2520	600	2296	1232	1,23	61,60	16,24	-	1338	1539
		0700				56	2520	700	2632	1400	1,23	67,20	18,48	-	1459	1678
		0800				56	2520	800	2968	1568	1,23	72,80	20,72	-	1581	1818
		0900				56	2520	900	3248	1736	1,24	84,00	22,96	-	1701	1956
11376	2700	0400	XXXX	YYYY	-0000	60	2700	400	1740	900	1,22	48,00	12,60	-	1167	1342
		0500				60	2700	500	2100	1080	1,23	54,00	15,00	-	1298	1493
		0600				60	2700	600	2460	1320	1,23	66,00	17,40	-	1427	1641
		0700				60	2700	700	2820	1500	1,23	72,00	19,80	-	1560	1794
		0800				60	2700	800	3180	1680	1,23	78,00	22,20	-	1688	1941
11376	2880	0400	XXXX	YYYY	-0000	64	2880	400	1856	960	1,22	51,20	13,44	-	1240	1426
		0500				64	2880	500	2240	1152	1,23	57,60	16,00	-	1380	1587
		0600				64	2880	600	2624	1408	1,23	70,40	18,56	-	1520	1748
		0700				64	2880	700	3008	1600	1,23	76,80	21,12	-	1658	1907
11376	3060	0400	XXXX	YYYY	-0000	68	3060	400	1972	1020	1,22	54,40	14,28	-	1313	1510
		0500				68	3060	500	2380	1224	1,23	61,20	17,00	-	1460	1679
		0600				68	3060	600	2788	1496	1,23	74,80	19,72	-	1609	1850
		0700				68	3060	700	3196	1700	1,23	81,60	22,44	-	1755	2018

In conformity with EN442-1: 2014: radiators and convectors

For heat outputs in other regimes, see p. 320 (correction factors)
EXPORT. Prices in Euro (excl. VAT)

VASCO

HOW TO ORDER TULIPA-A HORIZONTAL

Delivery time 15 - 30 working days
(transport duration not included)

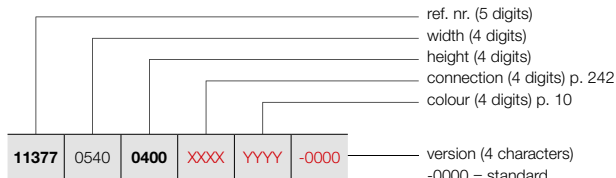

ref. nr. (5 digits)
width (4 digits)
height (4 digits)
connection (4 digits) p. 242
colour (4 digits) p. 10

version (4 characters)
-0000 = standard
-0006 = with fixed feet
-A100 = higher service pressure (10 bar)

FREE-STANDING INSTALLATION (TH2-A)
See p. 240 for additional accessories.

TULIPA-A HORIZONTAL (TH2-A)



TH2-A

PRICE GROUP: VPG2 - STEEL DESIGN RADIATORS

REFERENCE CODE CUSTOM MADE TULIPA-A HORIZONTAL							TECHNICAL DATA					STANDARD COLOUR	OTHER COLOURS				
							tubes	width (L mm)	height (H mm)	75/65/20 (Watt) (φ50K)	55/45/20 (Watt) (φ30K)	n-exp.	weight (kg)	water content (l)	electr. resistance (Watt)	price RAL 9016 (€)	price colour (€)
REF. NR. TULIPA-A HORIZONTAL TH2-A : 11377																	
11377	0540	0400	XXXX	YYYY	-0000	12	540	400	588	312	1,24	16,80	4,32	-	522	600	
							12	540	500	648	372	1,25	20,40	5,28	-	565	650
							12	540	600	816	432	1,25	24,00	6,24	-	608	699
							12	540	700	936	492	1,25	26,40	7,20	-	656	754
							12	540	800	1044	552	1,25	30,00	8,16	-	701	806
							12	540	900	1164	600	1,26	33,60	9,00	-	745	857
11377	0630	0400	XXXX	YYYY	-0000	14	630	400	686	364	1,24	19,60	5,04	-	582	669	
							14	630	500	756	434	1,25	23,80	6,16	-	633	728
							14	630	600	952	504	1,25	28,00	7,28	-	687	790
							14	630	700	1092	574	1,25	30,80	8,40	-	741	852
							14	630	800	1218	644	1,25	35,00	9,52	-	791	910
							14	630	900	1358	700	1,26	39,20	10,50	-	848	975
11377	0720	0400	XXXX	YYYY	-0000	16	720	400	784	416	1,24	22,40	5,76	-	642	738	
							16	720	500	864	496	1,25	27,20	7,04	-	705	811
							16	720	600	1088	576	1,25	32,00	8,32	-	767	882
							16	720	700	1248	656	1,25	35,20	9,60	-	827	951
							16	720	800	1392	736	1,25	40,00	10,88	-	889	1022
							16	720	900	1552	800	1,26	44,80	12,00	-	951	1094
11377	0810	0400	XXXX	YYYY	-0000	18	810	400	882	468	1,24	25,20	6,48	-	708	814	
							18	810	500	972	558	1,25	30,60	7,92	-	777	894
							18	810	600	1224	648	1,25	36,00	9,36	-	848	975
							18	810	700	1404	738	1,25	39,60	10,80	-	915	1052
							18	810	800	1566	828	1,25	45,00	12,24	-	982	1129
							18	810	900	1746	900	1,26	50,40	13,50	-	1051	1209
11377	0900	0400	XXXX	YYYY	-0000	20	900	400	980	520	1,24	28,00	7,20	-	774	890	
							20	900	500	1080	620	1,25	34,00	8,80	-	850	978
							20	900	600	1360	720	1,25	40,00	10,40	-	923	1061
							20	900	700	1560	820	1,25	44,00	12,00	-	1000	1150
							20	900	800	1740	920	1,25	50,00	13,60	-	1075	1236
							20	900	900	1940	1000	1,26	56,00	15,00	-	1153	1326
11377	0990	0400	XXXX	YYYY	-0000	22	990	400	1078	572	1,24	30,80	7,92	-	834	959	
							22	990	500	1188	682	1,25	37,40	9,68	-	920	1058
							22	990	600	1496	792	1,25	44,00	11,44	-	1001	1151
							22	990	700	1716	902	1,25	48,40	13,20	-	1084	1247
							22	990	800	1914	1012	1,25	55,00	14,96	-	1169	1344
							22	990	900	2134	1100	1,26	61,60	16,50	-	1255	1443
11377	1080	0400	XXXX	YYYY	-0000	24	1080	400	1176	624	1,24	33,60	8,64	-	901	1036	
							24	1080	500	1296	744	1,25	40,80	10,56	-	993	1142
							24	1080	600	1632	864	1,25	48,00	12,48	-	1080	1242
							24	1080	700	1872	984	1,25	52,80	14,40	-	1171	1347
							24	1080	800	2088	1104	1,25	60,00	16,32	-	1266	1456
							24	1080	900	2328	1200	1,26	67,20	18,00	-	1352	1555

In conformity with EN442-1: 2014: radiators and convectors

For heat outputs in other regimes, see p. 320 (correction factors)
EXPORT. Prices in Euro (excl. VAT)

VASCO

TULIPA-A HORIZONTAL (TH2-A)



TH2-A

HOW TO ORDER TULIPA-A HORIZONTAL

Delivery time 15 - 30 working days
(transport duration not included)

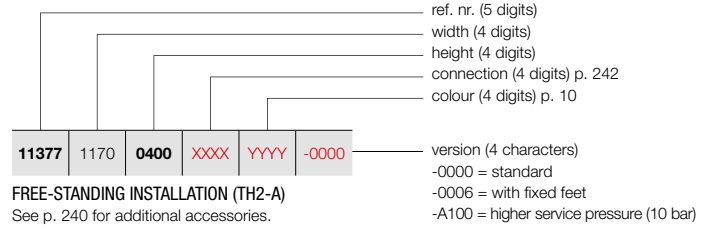

FREE-STANDING INSTALLATION (TH2-A)
See p. 240 for additional accessories.

PRICE GROUP: VPG2 - STEEL DESIGN RADIATORS

REFERENCE CODE CUSTOM MADE TULIPA-A HORIZONTAL							TECHNICAL DATA					STANDARD COLOUR	OTHER COLOURS			
tubes	width (L mm)	height (H mm)	75/65/20 (Watt) (Φ50K)	55/45/20 (Watt) (Φ30K)	n-exp.	weight (kg)	water content (l)	electr. resistance (Watt)	price RAL 9016 (€)	price colour (€)						
REF. NR. TULIPA-A HORIZONTAL TH2-A : 11377																
11377	1170	0400	XXXX	YYYY	-0000	26	1170	400	1274	676	1,24	36,40	9,36	-	962	1106
		0500				26	1170	500	1404	806	1,25	44,20	11,44	-	1062	1221
		0600				26	1170	600	1768	936	1,25	52,00	13,52	-	1160	1334
		0700				26	1170	700	2028	1066	1,25	57,20	15,60	-	1259	1448
		0800				26	1170	800	2262	1196	1,25	65,00	17,68	-	1361	1565
		0900				26	1170	900	2522	1300	1,26	72,80	19,50	-	1458	1677
11377	1260	0400	XXXX	YYYY	-0000	28	1260	400	1372	728	1,24	39,20	10,08	-	1027	1181
		0500				28	1260	500	1512	868	1,25	47,60	12,32	-	1134	1304
		0600				28	1260	600	1904	1008	1,25	56,00	14,56	-	1239	1425
		0700				28	1260	700	2184	1148	1,25	61,60	16,80	-	1346	1548
		0800				28	1260	800	2436	1288	1,25	70,00	19,04	-	1453	1671
		0900				28	1260	900	2716	1400	1,26	78,40	21,00	-	1560	1794
11377	1440	0400	XXXX	YYYY	-0000	32	1440	400	1568	832	1,24	44,80	11,52	-	1153	1326
		0500				32	1440	500	1728	992	1,25	54,40	14,08	-	1277	1469
		0600				32	1440	600	2176	1152	1,25	64,00	16,64	-	1395	1604
		0700				32	1440	700	2496	1312	1,25	70,40	19,20	-	1520	1748
		0800				32	1440	800	2784	1472	1,25	80,00	21,76	-	1637	1883
		0900				32	1440	900	3104	1600	1,26	89,60	24,00	-	1760	2024
11377	1620	0400	XXXX	YYYY	-0000	36	1620	400	1764	936	1,24	50,40	12,96	-	1281	1473
		0500				36	1620	500	1944	1116	1,25	61,20	15,84	-	1419	1632
		0600				36	1620	600	2448	1296	1,25	72,00	18,72	-	1554	1787
		0700				36	1620	700	2808	1476	1,25	79,20	21,60	-	1691	1945
		0800				36	1620	800	3132	1656	1,25	90,00	24,48	-	1827	2101
		0900				36	1620	900	3492	1800	1,26	100,80	27,00	-	1963	2257
11377	1800	0400	XXXX	YYYY	-0000	40	1800	400	1960	1040	1,24	56,00	14,40	-	1405	1616
		0500				40	1800	500	2160	1240	1,25	68,00	17,60	-	1561	1795
		0600				40	1800	600	2720	1440	1,25	80,00	20,80	-	1714	1971
		0700				40	1800	700	3120	1640	1,25	88,00	24,00	-	1862	2141
		0800				40	1800	800	3480	1840	1,25	100,00	27,20	-	2015	2317
		0900				40	1800	900	3880	2000	1,26	112,00	30,00	-	2166	2491
11377	1980	0400	XXXX	YYYY	-0000	44	1980	400	2156	1144	1,24	61,60	15,84	-	1536	1766
		0500				44	1980	500	2376	1364	1,25	74,80	19,36	-	1703	1958
		0600				44	1980	600	2992	1584	1,25	88,00	22,88	-	1869	2149
		0700				44	1980	700	3432	1804	1,25	96,80	26,40	-	2036	2341
		0800				44	1980	800	3828	2024	1,25	110,00	29,92	-	2201	2531
		0900				44	1980	900	4268	2200	1,26	123,20	33,00	-	2372	2728
11377	2160	0400	XXXX	YYYY	-0000	48	2160	400	2352	1248	1,24	67,20	17,28	-	1662	1911
		0500				48	2160	500	2592	1488	1,25	81,60	21,12	-	1847	2124
		0600				48	2160	600	3264	1728	1,25	96,00	24,96	-	2027	2331
		0700				48	2160	700	3744	1968	1,25	105,60	28,80	-	2210	2542
		0800				48	2160	800	4176	2208	1,25	120,00	32,64	-	2390	2749
		0900				48	2160	900	4656	2400	1,26	134,40	36,00	-	2575	2961

In conformity with EN442-1: 2014: radiators and convectors

For heat outputs in other regimes, see p. 320 (correction factors)
EXPORT. Prices in Euro (excl. VAT)

HOW TO ORDER TULIPA-A HORIZONTAL

Delivery time 15 - 30 working days
(transport duration not included)

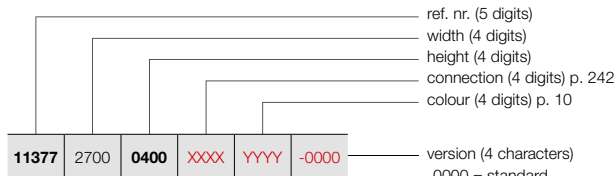

FREE-STANDING INSTALLATION (TH2-A)

See p. 240 for additional accessories.

TULIPA-A HORIZONTAL (TH2-A)



TH2-A

PRICE GROUP: VPG2 - STEEL DESIGN RADIATORS

REFERENCE CODE CUSTOM MADE TULIPA-A HORIZONTAL	TECHNICAL DATA									STANDARD COLOUR	OTHER COLOURS					
	tubes	width (L mm)	height (H mm)	75/65/20 (Watt) (φ50K)	55/45/20 (Watt) (φ30K)	n-exp.	weight (kg)	water content (l)	electr. resistance (Watt)	price RAL 9016 (€)	price colour (€)					
REF. NR. TULIPA-A HORIZONTAL TH2-A : 11377																
11377	2340	0400	XXXX	YYYY	-0000	52	2340	400	2548	1352	1,24	72,80	18,72	-	1791	2060
						52	2340	500	2808	1612	1,25	88,40	22,88	-	1986	2284
						52	2340	600	3536	1872	1,25	104,00	27,04	-	2185	2513
						52	2340	700	4056	2132	1,25	114,40	31,20	-	2382	2739
						52	2340	800	4524	2392	1,25	130,00	35,36	-	2579	2966
						52	2340	900	5044	2600	1,26	145,60	39,00	-	2777	3194
11377	2520	0400	XXXX	YYYY	-0000	56	2520	400	2744	1456	1,24	78,40	20,16	-	1918	2206
						56	2520	500	3024	1736	1,25	95,20	24,64	-	2130	2450
						56	2520	600	3808	2016	1,25	112,00	29,12	-	2343	2694
						56	2520	700	4368	2296	1,25	123,20	33,60	-	2553	2936
						56	2520	800	4872	2576	1,25	140,00	38,08	-	2765	3180
						56	2520	900	5432	2800	1,26	156,80	42,00	-	2976	3422
11377	2700	0400	XXXX	YYYY	-0000	60	2700	400	2940	1560	1,24	84,00	21,60	-	2042	2348
						60	2700	500	3240	1860	1,25	102,00	26,40	-	2273	2614
						60	2700	600	4080	2160	1,25	120,00	31,20	-	2497	2872
						60	2700	700	4680	2460	1,25	132,00	36,00	-	2726	3135
						60	2700	800	5220	2760	1,25	150,00	40,80	-	2956	3399
11377	2880	0400	XXXX	YYYY	-0000	64	2880	400	3136	1664	1,24	89,60	23,04	-	2174	2500
						64	2880	500	3456	1984	1,25	108,80	28,16	-	2415	2777
						64	2880	600	4352	2304	1,25	128,00	33,28	-	2655	3053
						64	2880	700	4992	2624	1,25	140,80	38,40	-	2900	3335
11377	3060	0400	XXXX	YYYY	-0000	68	3060	400	3332	1768	1,24	95,20	24,48	-	2297	2642
						68	3060	500	3672	2108	1,25	115,60	29,92	-	2555	2938
						68	3060	600	4624	2448	1,25	136,00	35,36	-	2814	3236
						68	3060	700	5304	2788	1,25	149,60	40,80	-	3072	3533

In conformity with EN442-1: 2014: radiators and convectors

For heat outputs in other regimes, see p. 320 (correction factors)
EXPORT. Prices in Euro (excl. VAT)

TULIPA-A FREE-STANDING INSTALLATION
IN OPTION

PRICE GROUP: VPG10 - ACC.



FREE-STANDING INSTALLATION		COLOUR	REF. NR.	€	
FIXED FOOT		TV1-A / TH1-A			
		150 mm (no lateral support)	RAL 9016	*	71
			COLOUR	*	82
		TV2-A / TH2-A			
		150 mm (no lateral support)	RAL 9016	*	143
			COLOUR	*	164

- Additional wall mounting support necessary for height radiator > 600 mm (included).
- Please indicate code **-0006** for "Finish" when ordering (fixed foot included in the price).
- No rosettes available.

	TV1-A / TV2-A	TH1-A / TH2-A		
length radiator (mm)		540 - 1440	1620 - 2340	> 2340
number of feet	2x	2x	3x	4x

EXPORT. Prices in Euro (excl. VAT)

PRICE GROUP: VPG10 - ACC.

ACCESSORIES		COLOUR	REF. NR.	€
THERMOSTATIC HEAD		TV1-A / TV2-A		
		WHITE	11911630102	44
THERMOSTATIC HEAD		TV1-A / TV2-A		
		CHROME	11911631102	63

PRICE GROUP: VPG10B - TOWEL RAILS

ACCESSORIES	WIDTH TOWEL RAIL	COLOUR	REF. NR.	€	
TOWEL RAIL		TV1-A / TV2-A / TH1-A / TH2-A			
		500 mm	CHROME	1183 269 0000 0099	145
		500 mm	RAL 9016	1183 269 0000 9016	145
		500 mm	RAL 9005 ^M	1183 269 0000 9005	145

- h = 55 mm; b = 500 mm; d = 58 mm; a = 43 mm;

^M matt black

Mounting instructions accessories: see www.vasco.eu
EXPORT. Prices in Euro (excl. VAT)

d = distance front of the accessory up to front of the radiator
a = distance accessory up to the radiator
available from stock

TULIPA-A CONNECTIONS

TULIPA-A VERTICAL: TV1-A / TV2-A (STOCK)

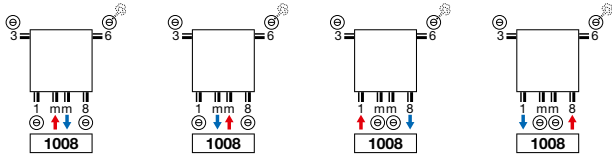

TULIPA-A HORIZONTAL: TH1-A / TH2-A (NON STOCK)

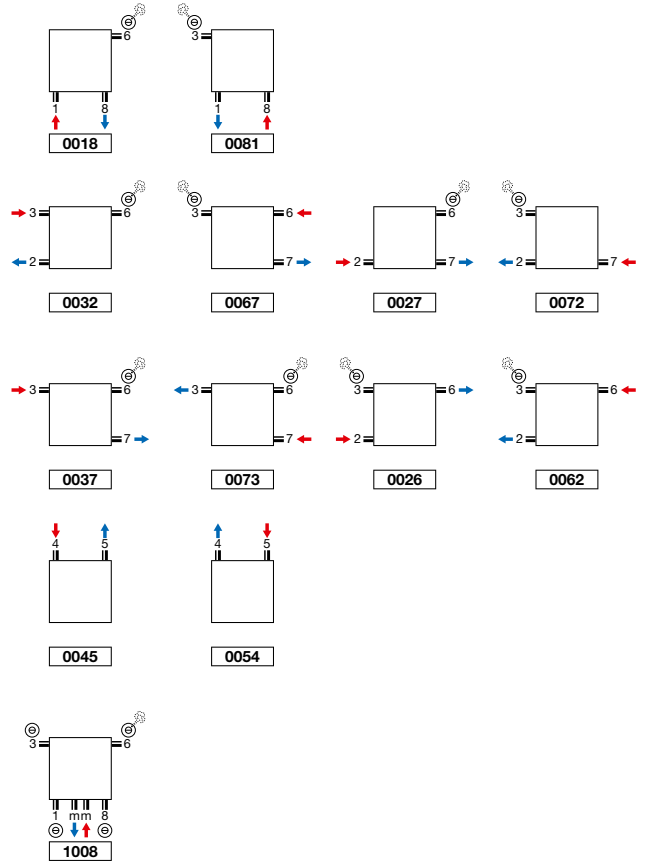

TULIPA-A VERTICAL: TV1-A / TV2-A (NON STOCK)

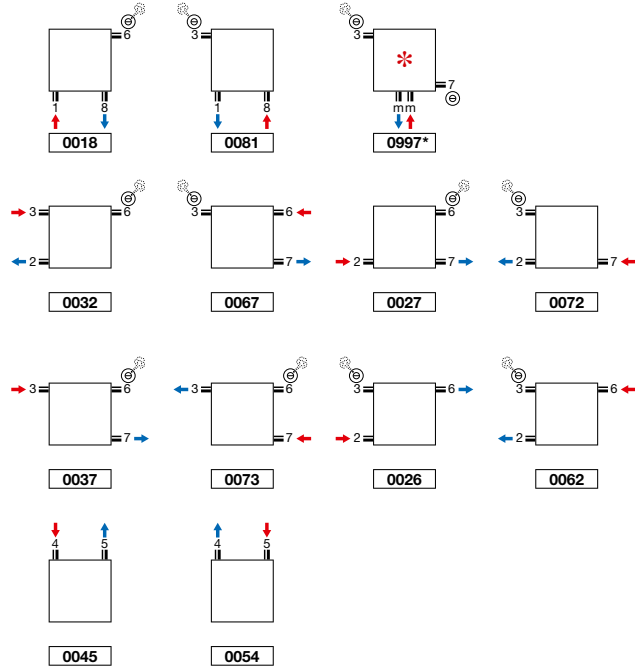

- * Connection 0997: inlet has to be on the right side!
- Tulipa-A 6 and 8 tubes: connection 1mm8, 18, 81 not possible

Attention: connecting the radiator can only be as shown by the connecting icons. For any other connection method, we take no responsibility.

TULIPA-A VERTICAL (TV1-A, TV2-A)

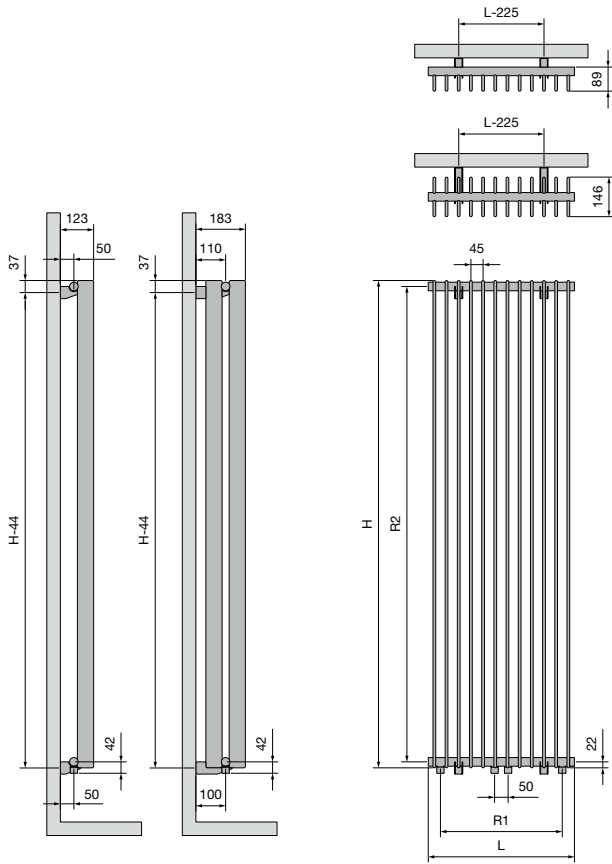

	TV1-A / TV2-A											
Width (L)	270	360	450	540	630	720	810	900	990	1080	1170	1260
Centre between the connections at the bottom 18 (R1)	180	270	360	450	540	630	720	810	900	990	1080	1170
height (H)	1000	1200	1500	1600	1800	2000	2200	2500	3000			
Centre between the lateral connections 23/67 (R2)	956	1156	1456	1556	1756	1956	2156	2456	2956			
Centre between the brackets	H-44											

TULIPA-A HORIZONTAL (TH1-A, TH2-A)

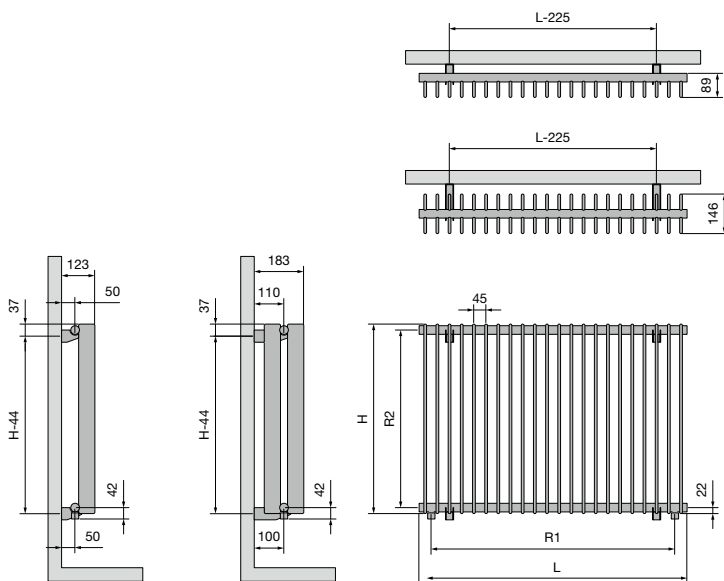

	TH1-A / TH2-A																		
Width (L)	540	630	720	810	900	990	1080	1170	1260	1440	1620	1800	1980	2160	2340	2520	2700	2880	3060
Centre between the connections at the bottom 18 (R1)	450	540	630	720	810	900	990	1080	1170	1350	1530	1710	1890	2070	2250	2430	2610	2790	2970
height (H)	400	500	600	700	800	900													
Centre between the lateral connections 23/67 (R2)	356	456	556	656	756	856													
Centre between the brackets	H-44																		

Panel radiators



Are you looking for a clean pure look without a lot of frills? Then a radiator from the FlatLine collection is an excellent choice. The FlatLine radiator, with its flat front panel and beautiful finish with textured surface raises every contemporary interior to a higher level.

Another unique detail is that the FlatLine radiator has a **water-conducting flat front panel** that increases heat output. It can be effortlessly attached to **low temperature systems**.

VASCO panel radiators are not just ordinary radiators. The radiator and sheet-metal create a **sleek, beautifully finished product** that also contains unique heating technology.

It is a radiator concept that combines high efficiency with a compact volume. Vertical, horizontal or plinth, these are always discreet yet completely present in any home environment.

Panel radiators

FlatLine	246
Flat-V-Line	252
Flat-Plint-Line	254

FLATLINE (T21S, T22, T33)



All horizontal FlatLine radiators have the VASCO label in the top grille.

TYPES

- T21S, T22, T33

COLOURS

- Standard colour S600 (fine texture white)
- Not available in other colours

BRACKETS

- The radiator is standard delivered with a full assembly set: locked consoles (number depending on the length of the radiator), designer plugs, designer air vents, valve inserts

TECHNICAL

- Electrically welded by means of resistance welding robots (invisible weld seams)
- KTL priming coat, powder coating
- Standard operating pressure: 6 bar
- Maximum operating temperature: 110°C

ELECTRICAL

- ✗ Pure electrical radiator prefilled
- ✗ Mixed radiator

TECHNICAL DRAWINGS

- See p. 259

CONNECTION

- ✗ One-point connection for one-pipe system
- ✗ One-point connection for two-pipe system
- ✓ Two-point connection for one-pipe system (connection by way of the integrated valve) (see p. 312)
- ✓ Two-point connection for two-pipe system (standard) (see p. 312)
- ✓ Integrated valve **(no extra charge)** (see p. 313)
- Connections: 4x1/2" side (inner thread), 2x3/4" Euro cones (50mm bottom right) and 2x3/4" Euro cones (50mm centre)

FLATLINE

Top technology for superior heat output

Are you striving for a sincere, pure look without a lot of frills? Then FlatLine is the choice for you. It is extremely stylish in its timeless simplicity. With its flat front plate and the fantastic finish with textured paint it lifts every contemporary interior to a higher level. The direct contact between the front plate and the water channels results in a surprisingly high yield.

RECOMMENDED CONNECTION (0098) INTEGRATED VALVE

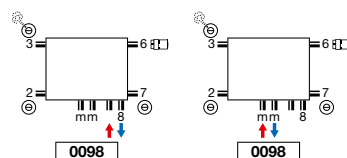

Other connection methods, see p. 258



ref. nr. 11823000000099
price € 147
Fittings, see p. 327

RECOMMENDED FOR BATHROOM AND KITCHEN IN OPTION



towel rail (LR)
ref. nr. see p. 257
price € 119

Other accessories, see p. 257



white
ref. nr. 11911630102
price € 44



chrome
ref. nr. 11911631102
price € 63



HOW TO ORDER FLATLINE T21S
 Delivery time 5 working days
 (transport duration not included)

FLATLINE (T21S)

2140040F

ref. nr. (8 characters)
 see table below



T21S

PRICE GROUP: VPG4 - PANEL RADIATORS A

REFERENCE CODE CUSTOM MADE FLATLINE T21S	TECHNICAL DATA									STANDARD COLOUR	
	tubes	width (L mm)	height (H mm)	75/65/20 (Watt) (Φ50K)	55/45/20 (Watt) (Φ30K)	n-exp.	weight (kg)	water content (l)	electr. resistance (Watt)	price S600 (€)	short ref. nr. S600 stock
108F2140040190	-	400	400	366	190	1,28	8,53	1,41	-	244	2140040F
108F2140060190	-	600	400	548	285	1,28	12,79	2,11	-	294	2140060F
108F2140080190	-	800	400	731	380	1,28	17,06	2,82	-	331	2140080F
108F2140100190	-	1000	400	914	475	1,28	21,32	3,52	-	386	2140100F
108F2140120190	-	1200	400	1097	570	1,28	25,58	4,22	-	430	2140120F
108F2140140190	-	1400	400	1280	665	1,28	29,85	4,93	-	481	2140140F
108F2140160190	-	1600	400	1462	761	1,28	34,11	5,63	-	520	2140160F
108F2140180190	-	1800	400	1645	856	1,28	38,38	6,34	-	584	2140180F
108F2140200190	-	2000	400	1828	951	1,28	42,64	7,04	-	650	2140200F
108F2140240190	-	2400	400	2194	1141	1,28	51,17	8,45	-	777	2140240F
108F2150040190	-	400	500	440	228	1,29	10,63	1,67	-	282	2150040F
108F2150060190	-	600	500	661	342	1,29	15,95	2,51	-	344	2150060F
108F2150080190	-	800	500	881	456	1,29	21,26	3,34	-	404	2150080F
108F2150100190	-	1000	500	1101	570	1,29	26,58	4,18	-	463	2150100F
108F2150120190	-	1200	500	1321	684	1,29	31,90	5,02	-	523	2150120F
108F2150140190	-	1400	500	1541	797	1,29	37,21	5,85	-	591	2150140F
108F2150160190	-	1600	500	1762	911	1,29	42,53	6,69	-	645	2150160F
108F2150180190	-	1800	500	1982	1025	1,29	47,84	7,52	-	702	2150180F
108F2150200190	-	2000	500	2202	1139	1,29	53,16	8,36	-	776	2150200F
108F2160040190	-	400	600	512	264	1,30	12,74	1,94	-	301	2160040F
108F2160060190	-	600	600	768	395	1,30	19,11	2,91	-	367	2160060F
108F2160080190	-	800	600	1024	527	1,30	25,48	3,88	-	439	2160080F
108F2160100190	-	1000	600	1280	659	1,30	31,85	4,85	-	510	2160100F
108F2160120190	-	1200	600	1536	791	1,30	38,22	5,82	-	584	2160120F
108F2160140190	-	1400	600	1792	922	1,30	44,59	6,79	-	633	2160140F
108F2160160190	-	1600	600	2048	1054	1,30	50,96	7,76	-	719	2160160F
108F2160180190	-	1800	600	2304	1186	1,30	57,33	8,73	-	813	2160180F
108F2170040190	-	400	700	581	297	1,31	14,91	2,21	-	301	2170040F
108F2170060190	-	600	700	871	446	1,31	22,36	3,32	-	399	2170060F
108F2170080190	-	800	700	1162	595	1,31	29,82	4,42	-	482	2170080F
108F2170100190	-	1000	700	1452	744	1,31	37,27	5,53	-	553	2170100F
108F2170120190	-	1200	700	1742	892	1,31	44,72	6,64	-	657	2170120F
108F2190040190	-	400	900	711	361	1,33	19,24	2,76	-	350	2190040F
108F2190060190	-	600	900	1067	541	1,33	28,86	4,14	-	447	2190060F
108F2190080190	-	800	900	1422	721	1,33	38,48	5,52	-	554	2190080F
108F2190100190	-	1000	900	1778	901	1,33	48,10	6,90	-	659	2190100F
108F2190120190	-	1200	900	2134	1082	1,33	57,72	8,28	-	791	2190120F

In conformity with EN442-1: 2014: radiators and convectors

For heat outputs in other regimes, see p. 320 (correction factors)
 EXPORT. Prices in Euro (excl. VAT)

VASCO

FLATLINE (T22)



T22

HOW TO ORDER FLATLINE T22
 Delivery time 5 working days
 (transport duration not included)

2230100F

ref. nr. (8 characters)
 see table below

PRICE GROUP: VPG4 - PANEL RADIATORS A

REFERENCE CODE CUSTOM MADE FLATLINE T22	TECHNICAL DATA									STANDARD COLOUR	
	tubes	width (L mm)	height (H mm)	75/65/20 (Watt) (φ50K)	55/45/20 (Watt) (φ30K)	n-exp.	weight (kg)	water content (l)	electr. resistance (Watt)	price S600 (€)	short ref. nr. S600 stock
108F2230100190	-	1000	300	900	463	1,30	18,60	3,00	-	413	2230100F
108F2230120190	-	1200	300	1080	556	1,30	22,32	3,60	-	458	2230120F
108F2230140190	-	1400	300	1260	649	1,30	26,04	4,20	-	510	2230140F
108F2230160190	-	1600	300	1440	741	1,30	29,76	4,80	-	553	2230160F
108F2230180190	-	1800	300	1620	834	1,30	33,48	5,40	-	607	2230180F
108F2230200190	-	2000	300	1800	927	1,30	37,20	6,00	-	640	2230200F
108F2230220190	-	2200	300	1980	1019	1,30	40,92	6,60	-	708	2230220F
108F2230240190	-	2400	300	2160	1112	1,30	44,64	7,20	-	769	2230240F
108F2240060190	-	600	400	694	356	1,31	14,88	2,17	-	352	2240060F
108F2240080190	-	800	400	926	474	1,31	19,84	2,90	-	413	2240080F
108F2240100190	-	1000	400	1157	593	1,31	24,80	3,62	-	476	2240100F
108F2240120190	-	1200	400	1388	711	1,31	29,76	4,34	-	537	2240120F
108F2240140190	-	1400	400	1620	830	1,31	34,72	5,07	-	575	2240140F
108F2240160190	-	1600	400	1851	948	1,31	39,68	5,79	-	656	2240160F
108F2240180190	-	1800	400	2083	1067	1,31	44,64	6,52	-	737	2240180F
108F2240200190	-	2000	400	2314	1185	1,31	49,60	7,24	-	820	2240200F
108F2240220190	-	2200	400	2545	1304	1,31	54,56	7,96	-	903	2240220F
108F2240240190	-	2400	400	2777	1422	1,31	59,52	8,69	-	983	2240240F
108F2240260190	-	2600	400	3008	1541	1,31	64,48	9,41	-	1027	2240260F
108F2240300190	-	3000	400	3471	1778	1,31	74,40	10,86	-	1233	2240300F
108F2250040190	-	400	500	562	288	1,31	12,40	1,69	-	312	2250040F
108F2250060190	-	600	500	842	431	1,31	18,60	2,54	-	386	2250060F
108F2250080190	-	800	500	1123	575	1,31	24,80	3,38	-	461	2250080F
108F2250100190	-	1000	500	1404	719	1,31	31,00	4,23	-	543	2250100F
108F2250120190	-	1200	500	1685	863	1,31	37,20	5,08	-	620	2250120F
108F2250140190	-	1400	500	1966	1007	1,31	43,40	5,92	-	693	2250140F
108F2250160190	-	1600	500	2246	1150	1,31	49,60	6,77	-	791	2250160F
108F2250180190	-	1800	500	2527	1294	1,31	55,80	7,61	-	890	2250180F
108F2250200190	-	2000	500	2808	1438	1,31	62,00	8,46	-	990	2250200F
108F2250220190	-	2200	500	3089	1582	1,31	68,20	9,31	-	1085	2250220F
108F2250240190	-	2400	500	3370	1726	1,31	74,40	10,15	-	1183	2250240F
108F2250260190	-	2600	500	3650	1869	1,31	80,60	11,00	-	1236	2250260F
108F2260040190	-	400	600	657	336	1,31	14,88	1,94	-	344	2260040F
108F2260060190	-	600	600	985	505	1,31	22,32	2,91	-	429	2260060F
108F2260080190	-	800	600	1314	673	1,31	29,76	3,88	-	518	2260080F
108F2260100190	-	1000	600	1642	841	1,31	37,20	4,85	-	575	2260100F
108F2260120190	-	1200	600	1970	1009	1,31	44,64	5,82	-	690	2260120F
108F2260140190	-	1400	600	2299	1177	1,31	52,08	6,79	-	804	2260140F
108F2260160190	-	1600	600	2627	1345	1,31	59,52	7,76	-	921	2260160F
108F2260180190	-	1800	600	2956	1514	1,31	66,96	8,73	-	1033	2260180F
108F2260200190	-	2000	600	3284	1682	1,31	74,40	9,70	-	1148	2260200F
108F2260220190	-	2200	600	3612	1850	1,31	81,84	10,67	-	1261	2260220F
108F2260240190	-	2400	600	3941	2018	1,31	89,28	11,64	-	1377	2260240F

In conformity with EN442-1: 2014: radiators and convectors

For heat outputs in other regimes, see p. 320 (correction factors)
 EXPORT. Prices in Euro (excl. VAT)



HOW TO ORDER FLATLINE T22
 Delivery time 5 working days
 (transport duration not included)

FLATLINE (T22)



T22

ref. nr. (8 characters)
 see table below

2230100F

PRICE GROUP: VPG4 - PANEL RADIATORS A

REFERENCE CODE CUSTOM MADE FLATLINE T22	TECHNICAL DATA									STANDARD COLOUR	
	tubes	width (L mm)	height (H mm)	75/65/20 (Watt) (Φ50K)	55/45/20 (Watt) (Φ30K)	n-exp.	weight (kg)	water content (l)	electr. resistance (Watt)	price S600 (€)	short ref. nr. S600 stock
108F2270040190	-	400	700	749	383	1,31	17,49	2,21	-	355	2270040F
108F2270060190	-	600	700	1123	575	1,31	26,24	3,31	-	461	2270060F
108F2270080190	-	800	700	1498	767	1,31	34,98	4,42	-	573	2270080F
108F2270100190	-	1000	700	1872	959	1,31	43,73	5,52	-	677	2270100F
108F2270120190	-	1200	700	2246	1150	1,31	52,48	6,62	-	777	2270120F
108F2270140190	-	1400	700	2621	1342	1,31	61,22	7,73	-	910	2270140F
108F2270160190	-	1600	700	2995	1534	1,31	69,97	8,83	-	1038	2270160F
108F2270180190	-	1800	700	3370	1726	1,31	78,71	9,94	-	1173	2270180F
108F2290040190	-	400	900	925	474	1,31	22,72	2,74	-	411	2290040F
108F2290060190	-	600	900	1387	710	1,31	34,08	4,11	-	537	2290060F
108F2290080190	-	800	900	1850	947	1,31	45,44	5,48	-	663	2290080F
108F2290100190	-	1000	900	2312	1184	1,31	56,80	6,85	-	793	2290100F
108F2290120190	-	1200	900	2774	1421	1,31	68,16	8,22	-	950	2290120F
108F2290140190	-	1400	900	3237	1658	1,31	79,52	9,59	-	1112	2290140F

In conformity with EN442-1: 2014: radiators and convectors

For heat outputs in other regimes, see p. 320 (correction factors)
 EXPORT. Prices in Euro (excl. VAT)

FLATLINE (T33)



T33

HOW TO ORDER FLATLINE T33
 Delivery time 5 working days
 (transport duration not included)

3330100F

ref. nr. (8 characters)
 see table below

PRICE GROUP: VPG4 - PANEL RADIATORS A

REFERENCE CODE CUSTOM MADE FLATLINE T33	TECHNICAL DATA									STANDARD COLOUR	
	tubes	width (L mm)	height (H mm)	75/65/20 (Watt) (Φ50K)	55/45/20 (Watt) (Φ30K)	n-exp.	weight (kg)	water content (l)	electr. resistance (Watt)	price S600 (€)	short ref. nr. S600 stock
108F3330100190	-	1000	300	1300	669	1,30	26,35	4,65	-	509	3330100F
108F3330120190	-	1200	300	1560	803	1,30	31,62	5,58	-	546	3330120F
108F3330140190	-	1400	300	1820	937	1,30	36,89	6,51	-	636	3330140F
108F3330160190	-	1600	300	2080	1071	1,30	42,16	7,44	-	725	3330160F
108F3330180190	-	1800	300	2340	1205	1,30	47,43	8,37	-	818	3330180F
108F3330200190	-	2000	300	2600	1338	1,30	52,70	9,30	-	909	3330200F
108F3330220190	-	2200	300	2860	1472	1,30	57,97	10,23	-	999	3330220F
108F3330240190	-	2400	300	3120	1606	1,30	63,24	11,16	-	1089	3330240F
108F3330300190	-	3000	300	3900	2008	1,30	79,05	13,95	-	1364	3330300F
108F3340080190	-	800	400	1329	684	1,30	28,24	4,42	-	518	3340080F
108F3340100190	-	1000	400	1661	855	1,30	35,30	5,53	-	597	3340100F
108F3340120190	-	1200	400	1993	1026	1,30	42,36	6,64	-	697	3340120F
108F3340140190	-	1400	400	2325	1197	1,30	49,42	7,74	-	813	3340140F
108F3340160190	-	1600	400	2658	1368	1,30	56,48	8,85	-	930	3340160F
108F3340180190	-	1800	400	2990	1539	1,30	63,54	9,95	-	1045	3340180F
108F3340200190	-	2000	400	3322	1710	1,30	70,60	11,06	-	1162	3340200F
108F3340220190	-	2200	400	3654	1881	1,30	77,66	12,17	-	1278	3340220F
108F3340240190	-	2400	400	3986	2052	1,30	84,72	13,27	-	1395	3340240F
108F3340300190	-	3000	400	4983	2565	1,30	105,90	16,59	-	1738	3340300F
108F3350060190	-	600	500	1202	619	1,30	26,55	3,85	-	436	3350060F
108F3350080190	-	800	500	1602	825	1,30	35,40	5,14	-	591	3350080F
108F3350100190	-	1000	500	2003	1031	1,30	44,25	6,42	-	702	3350100F
108F3350120190	-	1200	500	2404	1237	1,30	53,10	7,70	-	837	3350120F
108F3350140190	-	1400	500	2804	1443	1,30	61,95	8,99	-	980	3350140F
108F3350160190	-	1600	500	3205	1650	1,30	70,80	10,27	-	1119	3350160F
108F3350180190	-	1800	500	3605	1856	1,30	79,65	11,56	-	1257	3350180F
108F3350200190	-	2000	500	4006	2062	1,30	88,50	12,84	-	1397	3350200F
108F3350220190	-	2200	500	4407	2268	1,30	97,35	14,12	-	1538	3350220F
108F3350240190	-	2400	500	4807	2475	1,30	106,20	15,41	-	1675	3350240F
108F3360060190	-	600	600	1396	719	1,30	31,92	4,38	-	540	3360060F
108F3360080190	-	800	600	1862	958	1,30	42,56	5,84	-	671	3360080F
108F3360100190	-	1000	600	2327	1198	1,30	53,20	7,30	-	813	3360100F
108F3360120190	-	1200	600	2792	1437	1,30	63,84	8,76	-	975	3360120F
108F3360140190	-	1400	600	3258	1677	1,30	74,48	10,22	-	1137	3360140F
108F3360160190	-	1600	600	3723	1917	1,30	85,12	11,68	-	1298	3360160F
108F3360180190	-	1800	600	4189	2156	1,30	95,76	13,14	-	1460	3360180F
108F3360200190	-	2000	600	4654	2396	1,30	106,40	14,60	-	1621	3360200F
108F3370060190	-	600	700	1582	814	1,30	34,24	4,68	-	584	3370060F
108F3370080190	-	800	700	2110	1086	1,30	45,66	6,24	-	736	3370080F
108F3370100190	-	1000	700	2637	1357	1,30	57,07	7,80	-	921	3370100F
108F3370120190	-	1200	700	3164	1629	1,30	68,48	9,36	-	1197	3370120F
108F3370140190	-	1400	700	3692	1900	1,30	79,90	10,92	-	1378	3370140F

In conformity with EN442-1: 2014: radiators and convectors

For heat outputs in other regimes, see p. 320 (correction factors)
 EXPORT. Prices in Euro (excl. VAT)

VASCO

HOW TO ORDER FLATLINE T33
 Delivery time 5 working days
 (transport duration not included)

FLATLINE (T33)



T33

ref. nr. (8 characters)
 see table below

3330100F

PRICE GROUP: VPG4 - PANEL RADIATORS A

REFERENCE CODE CUSTOM MADE FLATLINE T33	TECHNICAL DATA									STANDARD COLOUR	
	tubes	width (L mm)	height (H mm)	75/65/20 (Watt) (Φ50K)	55/45/20 (Watt) (Φ30K)	n-exp.	weight (kg)	water content (l)	electr. resistance (Watt)	price S600 (€)	short ref. nr. S600 stock
108F3390040190	-	400	900	1286	662	1,30	25,92	3,52	-	449	3390040F
108F3390060190	-	600	900	1930	993	1,30	38,88	5,28	-	674	3390060F
108F3390080190	-	800	900	2573	1324	1,30	51,84	7,04	-	900	3390080F
108F3390100190	-	1000	900	3216	1655	1,30	64,80	8,80	-	1122	3390100F
108F3390120190	-	1200	900	3859	1987	1,30	77,76	10,56	-	1348	3390120F
108F3390140190	-	1400	900	4502	2318	1,30	90,72	12,32	-	1573	3390140F
108F3390160190	-	1600	900	5146	2649	1,30	103,68	14,08	-	1795	3390160F

In conformity with EN442-1: 2014: radiators and convectors

For heat outputs in other regimes, see p. 320 (correction factors)
 EXPORT. Prices in Euro (excl. VAT)

FLAT-V-LINE (T21S, T22)



TYPES

- T21S, T22

COLOURS

- Standard colour S600 (fine texture white)
- Not available in other colours

BRACKETS

- The radiator is standard delivered with a full assembly set: consoles (J), designer plugs, designer air vents

TECHNICAL

- Electrically welded by means of resistance welding robots (invisible weld seams)
- KTL priming coat, powder coating
- Standard operating pressure: 10 bar
- Maximum operating temperature: 110°C

ELECTRICAL

- ✗ Pure electrical radiator prefilled
- ✗ Mixed radiator

TECHNICAL DRAWINGS

- See p. 259

CONNECTION

- ✗ One-point connection for one-pipe system
- ✗ One-point connection for two-pipe system
- ✓ Two-point connection for one-pipe system (connection by way of the central connection) (see p. 312)
- ✓ Two-point connection for two-pipe system (standard) (see p. 312)
- ✗ Integrated valve
- Connections: 4x1/2" (1-8-4-5) (inner thread), 2x3/4" Euro cones (50mm centre)



RECOMMENDED CONNECTION (8008)

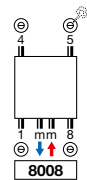

RECOMMENDED FOR BATHROOM AND KITCHEN IN OPTION



towel rail
ref. nr. see p. 257
price €119

Other connection methods, see p. 258

Other accessories, see p. 257

FLAT-V-LINE

Stylish and highly qualitative

Its synthesis of simplicity, efficiency and aesthetics, enhanced by the smart, fixed middle connector, allows this designer radiator panel to blend harmoniously into any living and working space. It has a specially designed towel rail for bathroom and kitchen.



ref. nr. 118230200000099
price €147
Fittings, see p. 327



white
ref. nr. 11911630102
price €44



chrome
ref. nr. 11911631102
price €63



HOW TO ORDER FLAT-V-LINE

Delivery time 15 - 30 working days
(transport duration not included)

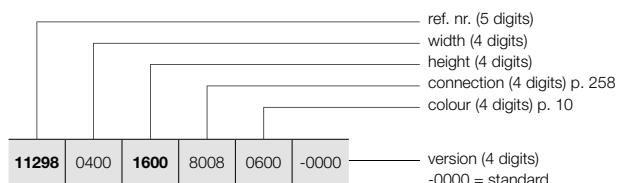

FLAT-V-LINE (T21S, T22)



T21S

T22

HOW TO ORDER STOCK RADIATOR FLAT-V-LINE

Delivery time 5 working days
(transport duration not included)

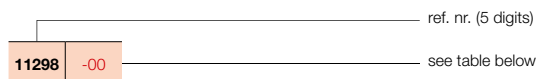

PRICE GROUP: VPG4 - PANEL RADIATORS A

REFERENCE CODE CUSTOM MADE FLAT-V-LINE	TECHNICAL DATA										STANDARD COLOUR	
	tubes	width (L mm)	height (H mm)	75/65/20 (Watt) (φ50K)	55/45/20 (Watt) (φ30K)	n-exp.	weight (kg)	water content (l)	electr. resistance (Watt)	price S600 (€)	short ref. nr. S600 stock	
REF. NR. FLAT-V-LINE T21S : 11298												
11298 0400 1600 8008 0600 -0000	-	400	1600	1047	531	1,33	35,35	6,38	-	842	11298-07	
	-	400	1800	1120	562	1,35	39,34	7,15	-	881	11298-01	
	-	400	2000	1198	598	1,36	43,34	7,93	-	911	11298-02	
	-	400	2200	1283	609	1,46	46,84	8,70	-	992	-	
11298 0500 1600 8008 0600 -0000	-	500	1600	1309	664	1,33	44,19	7,98	-	927	-	
	-	500	1800	1400	703	1,35	49,18	8,94	-	967	11298-03	
	-	500	2000	1498	748	1,36	54,18	9,91	-	1036	11298-04	
	-	500	2200	1604	761	1,46	58,55	10,88	-	1109	-	
11298 0600 1600 8008 0600 -0000	-	600	1600	1571	796	1,33	53,03	9,58	-	1027	-	
	-	600	1800	1680	843	1,35	59,02	10,73	-	1076	11298-05	
	-	600	2000	1798	898	1,36	65,02	11,89	-	1159	11298-06	
	-	600	2200	1925	913	1,46	70,26	13,06	-	1230	-	
11298 0700 1600 8008 0600 -0000	-	700	1600	1833	929	1,33	61,87	11,17	-	1122	-	
	-	700	1800	1960	984	1,35	68,85	12,52	-	1195	-	
	-	700	2000	2097	1047	1,36	75,85	13,87	-	1275	-	
	-	700	2200	2246	1065	1,46	81,97	15,23	-	1378	-	
11298 0800 1600 8008 0600 -0000	-	800	1600	2094	1062	1,33	70,70	12,77	-	1268	-	
	-	800	1800	2240	1124	1,35	78,69	14,30	-	1348	-	
	-	800	2000	2397	1197	1,36	86,69	15,86	-	1462	-	
	-	800	2200	2566	1218	1,46	93,68	17,41	-	1524	-	
REF. NR. FLAT-V-LINE T22 : 11299												
11299 0400 1600 8008 0600 -0000	-	400	1600	1281	626	1,40	39,86	6,38	-	939	-	
	-	400	1800	1394	668	1,44	43,79	7,15	-	1033	11299-01	
	-	400	2000	1509	708	1,48	47,72	7,93	-	1111	11299-02	
	-	400	2200	1626	816	1,35	52,08	8,70	-	1195	-	
11299 0500 1600 8008 0600 -0000	-	500	1600	1601	783	1,40	49,83	7,98	-	1021	-	
	-	500	1800	1743	836	1,44	54,74	8,94	-	1120	11299-03	
	-	500	2000	1886	886	1,48	59,65	9,91	-	1231	11299-04	
	-	500	2200	2032	1020	1,35	65,10	10,88	-	1322	-	
11299 0600 1600 8008 0600 -0000	-	600	1600	1921	940	1,40	59,80	9,58	-	1129	-	
	-	600	1800	2092	1003	1,44	65,69	10,73	-	1236	11299-05	
	-	600	2000	2263	1063	1,48	71,58	11,89	-	1349	11299-06	
	-	600	2200	2438	1223	1,35	78,12	13,06	-	1439	-	
11299 0700 1600 8008 0600 -0000	-	700	1600	2241	1096	1,40	69,76	11,17	-	1239	-	
	-	700	1800	2440	1170	1,44	76,64	12,52	-	1354	11299-07	
	-	700	2000	2640	1240	1,48	83,51	13,87	-	1476	11299-08	
	-	700	2200	2845	1427	1,35	91,14	15,23	-	1557	-	
11299 0800 1600 8008 0600 -0000	-	800	1600	2562	1253	1,40	79,73	12,77	-	1354	-	
	-	800	1800	2789	1337	1,44	87,58	14,30	-	1492	-	
	-	800	2000	3018	1417	1,48	95,44	15,86	-	1620	11299-09	
	-	800	2200	3251	1631	1,35	104,16	17,41	-	1696	11299-10	

VASCO

FLAT-PLINT-LINE (T22, T33)



TYPES

- T22, T33

COLOURS

- Standard colour S600 (fine texture white)
- Not available in other colours

BRACKETS

- To be ordered separately, not included in the price of the radiator
- Valve insert (M30 x 1,5) standard delivered

TECHNICAL

- Electrically welded by means of resistance welding robots (invisible weld seams)
- KTL priming coat, powder coating
- Standard operating pressure: 10 bar
- Maximum operating temperature: 110°C

ELECTRICAL

- ✗ Pure electrical radiator prefilled
- ✗ Mixed radiator

TECHNICAL DRAWINGS

- See p. 260

CONNECTION

- ✗ One-point connection for one-pipe system
- ✗ One-point connection for two-pipe system
- ✓ Two-point connection for one-pipe system (connection by way of the integrated valve) (see p. 312)
- ✓ Two-point connection for two-pipe system (standard) (see p. 312)
- ✓ Integrated valve **(no extra charge)** (see p. 313)
- Connections: 4x1/2" side (inner thread), 2x3/4" Euro cones (50mm bottom right) and 2x3/4" Euro cones (50mm centre)

FLAT-PLINT-LINE

Extremely flexible

The VASCO Flat-Plint-Line is a horizontal plinth panel radiator with a decorative surface front panel, side panels and designer line grid. This combines a superior heat supply with futuristic technology and stylish appearance.

RECOMMENDED CONNECTION (8008) INTEGRATED VALVE

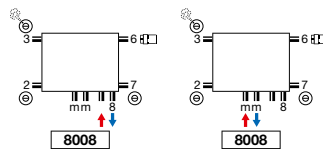

Other connection methods, see p. 258



ref. nr. 11823000000099
price €147
Fittings, see p. 327



white
ref. nr. 11911630102
price €44



chrome
ref. nr. 11911631102
price €63



HOW TO ORDER FLAT-PLINT-LINE

Delivery time 30 working days
(transport duration not included)

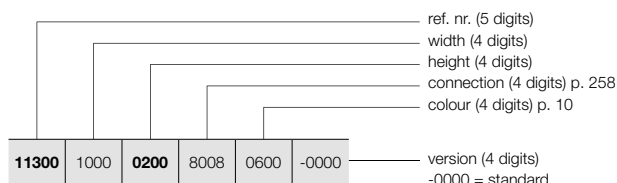

WALL BRACKET / TELESCOPIC FLOOR BRACKETS

See p. 256 for additional accessories.

HOW TO ORDER STOCK RADIATOR FLAT-PLINT-LINE

Delivery time 5 working days
(transport duration not included)

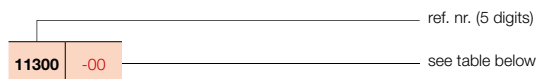

FLAT-PLINT-LINE (T22, T33)



T22

T33

PRICE GROUP: VPG4 - PANEL RADIATORS A

REFERENCE CODE CUSTOM MADE FLAT-PLINT-LINE	TECHNICAL DATA										STANDARD COLOUR	
	tubes	width (L mm)	height (H mm)	75/65/20 (Watt) (φ50K)	55/45/20 (Watt) (φ30K)	n-exp.	weight (kg)	water content (l)	electr. resistance (Watt)	price S600 (€)	short ref. nr. S600 stock	
REF. NR. FLAT-PLINT-LINE T22 : 11300												
11300 1000 0200 8008 0600 -0000	-	1000	200	605	313	1,29	12,90	2,55	-	347	11300-01	
11300 1200 0200 8008 0600 -0000	-	1200	200	726	376	1,29	15,48	3,06	-	384	11300-02	
11300 1400 0200 8008 0600 -0000	-	1400	200	847	438	1,29	18,06	3,57	-	425	-	
11300 1600 0200 8008 0600 -0000	-	1600	200	968	501	1,29	20,64	4,08	-	455	11300-03	
11300 1800 0200 8008 0600 -0000	-	1800	200	1089	563	1,29	23,22	4,59	-	474	-	
11300 2000 0200 8008 0600 -0000	-	2000	200	1210	626	1,29	25,80	5,10	-	494	11300-04	
11300 2200 0200 8008 0600 -0000	-	2200	200	1331	689	1,29	28,38	5,61	-	537	-	
11300 2400 0200 8008 0600 -0000	-	2400	200	1452	751	1,29	30,96	6,12	-	575	-	
11300 2600 0200 8008 0600 -0000	-	2600	200	1573	814	1,29	33,54	6,63	-	619	-	
11300 3000 0200 8008 0600 -0000	-	3000	200	1815	939	1,29	38,70	7,65	-	685	-	
REF. NR. FLAT-PLINT-LINE T33 : 11301												
11301 1000 0200 8008 0600 -0000	-	1000	200	866	450	1,28	18,25	3,80	-	440	11301-01	
11301 1200 0200 8008 0600 -0000	-	1200	200	1039	540	1,28	21,90	4,56	-	492	11301-02	
11301 1400 0200 8008 0600 -0000	-	1400	200	1212	630	1,28	25,55	5,32	-	540	-	
11301 1600 0200 8008 0600 -0000	-	1600	200	1386	720	1,28	29,20	6,08	-	580	11301-03	
11301 1800 0200 8008 0600 -0000	-	1800	200	1559	810	1,28	32,85	6,84	-	605	-	
11301 2000 0200 8008 0600 -0000	-	2000	200	1732	900	1,28	36,50	7,60	-	639	11301-04	
11301 2200 0200 8008 0600 -0000	-	2200	200	1905	990	1,28	40,15	8,36	-	695	-	
11301 2400 0200 8008 0600 -0000	-	2400	200	2078	1080	1,28	43,80	9,12	-	749	-	
11301 2600 0200 8008 0600 -0000	-	2600	200	2252	1170	1,28	47,45	9,88	-	804	-	
11301 3000 0200 8008 0600 -0000	-	3000	200	2598	1350	1,28	54,75	11,40	-	908	-	

In conformity with EN442-1: 2014: radiators and convectors

For heat outputs in other regimes, see p. 320 (correction factors)
EXPORT. Prices in Euro (excl. VAT)

PANEL RADIATORS BRACKETS / FREE-STANDING INSTALLATION
IN OPTION

PRICE GROUP: VPG10 - ACC.

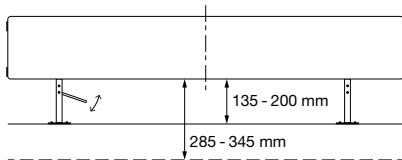

FREE-STANDING INSTALLATION	WIDTH RADIATOR		REF. NR.	€
FLAT-PLINT-LINE				
WALL BRACKETS	< 1600 mm (set of 2 pieces)		1189 002 0200 0000	23
	1600-2400 mm (set of 3 pieces)		1189 003 0200 0000	29
	> 2400 mm (set of 4 pieces)		1189 004 0200 0000	38
FLAT-PLINT-LINE				
TELESCOPIC FLOOR BRACKETS	≤ 1200 mm (set of 2 pieces)	concrete floor (height 285 - 345 mm)	1189 122 0000 0000	165
		finished floor (height 135 - 200 mm)	1189 112 0000 0000	165
	> 1200 mm (set of 3 pieces)	concrete floor (height 285 - 345 mm)	1189 123 0000 0000	218
finished floor (height 135 - 200 mm)		1189 113 0000 0000	218	



EXPORT. Prices in Euro (excl. VAT)

PANEL RADIATORS ACCESSORIES IN OPTION

PRICE GROUP: VPG10 - ACC.

ACCESSORIES		COLOUR	REF. NR.	€
THERMOSTATIC HEAD		FLATLINE / FLAT-V-LINE / FLAT-PLINT-LINE		
		WHITE	11911630102	44
THERMOSTATIC HEAD		FLATLINE / FLAT-V-LINE / FLAT-PLINT-LINE		
		CHROME	11911631102	63

PRICE GROUP: VPG10B - TOWEL RAILS

ACCESSORIES		WIDTH TOWEL RAIL	COLOUR	REF. NR.	€
TOWEL RAIL (LR)		FLATLINE			
		500 mm	CHROME	11911988050	119
		600 mm	CHROME	11911988060	127
		700 mm	CHROME	11911988070	135
		800 mm	CHROME	11911988080	141
TOWEL RAIL (MM) DISCONTINUED ITEM		FLATLINE			
		700 mm	CHROME	11911989070	141
TOWEL RAIL		FLAT-V-LINE			
		400 mm	CHROME	11832520000099	111
		500 mm	CHROME	11832530000099	119
		600 mm	CHROME	11832540000099	127
		700 mm	CHROME	11832550000099	135
		800 mm	CHROME	11832560000099	141

Mounting instructions accessories: see www.vasco.eu
EXPORT. Prices in Euro (excl. VAT)

available from stock

PANEL RADIATORS CONNECTIONS

FLATLINE: T21S / T22 / T33

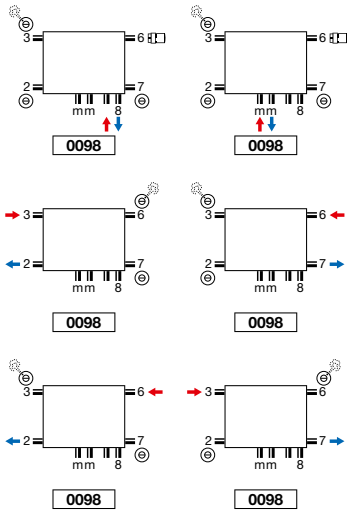

- Thermostatic head only to use with connection on the valve (supply left, return right). Other connections, eg. 23, take thermostatic head out of connection 6. Here the possibility to change the supply and the return.
- Integrated valve: no extra charge (see p. 313)

FLAT-V-LINE: T21S / T22

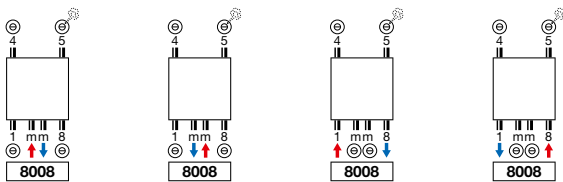

- Connection at the top not possible.

FLAT-PLINT-LINE: T22 / T33

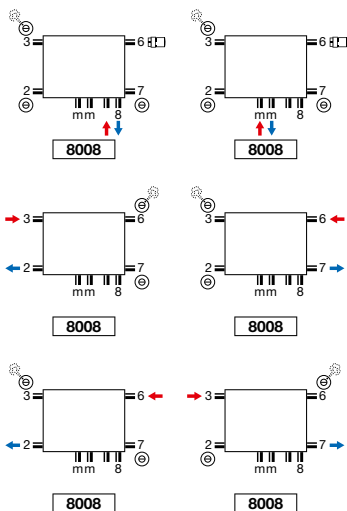

- Thermostatic head only to use with connection on the valve (supply left, return right). Other connections, eg. 23, take thermostatic head out of connection 6. Here the possibility to change the supply and the return.
- Integrated valve: no extra charge (see p. 313)

Attention: connecting the radiator can only be as shown by the connecting icons. For any other connection method, we take no responsibility.

FLATLINE (T21S, T22, T33)

TOP VIEW

T21S

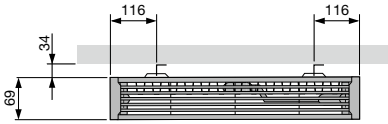

T22

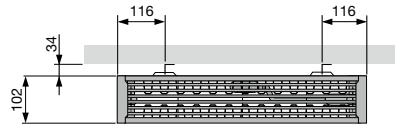

T33

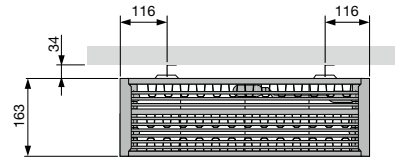

SIDE VIEW

T21S

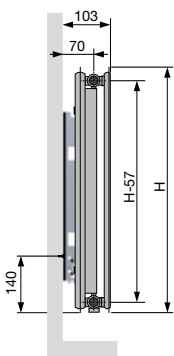

T22

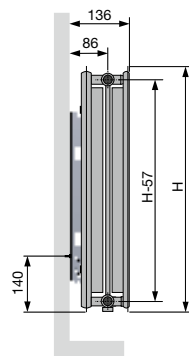

T33

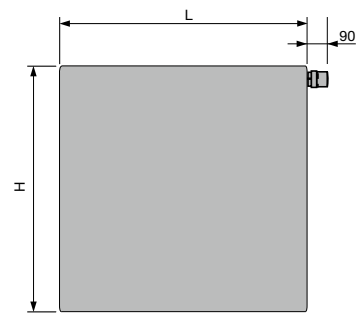
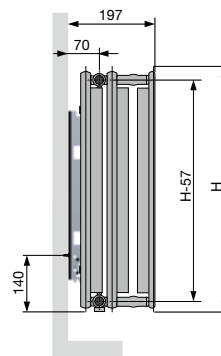

BOTTOM VIEW

T21S

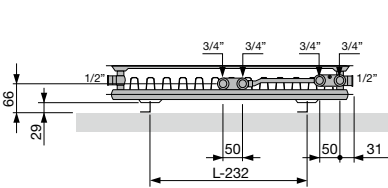

T22

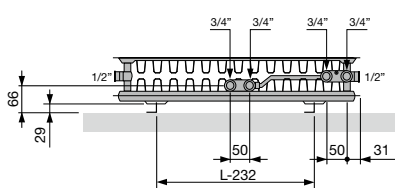

T33

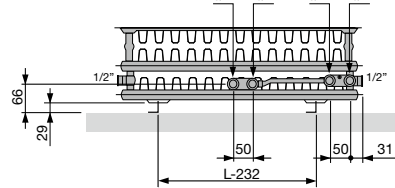

FLAT-V-LINE (T21S / T22)

SIDE VIEW

T21S

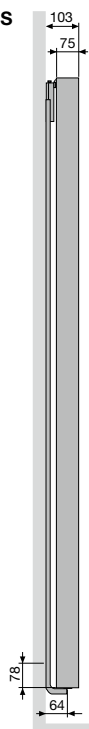

T22

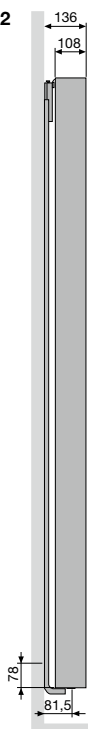

TOP VIEW

T21S

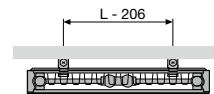

T22

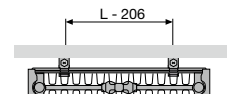

BOTTOM VIEW

T21S

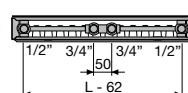

T22

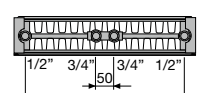

FLAT-PLINT-LINE (T22 / T33)

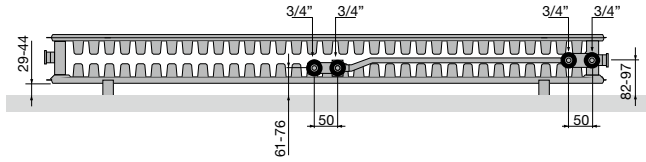

T22 | Bottom view



T22 | Top view

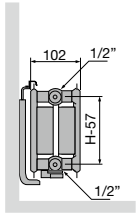

T22 | Side view

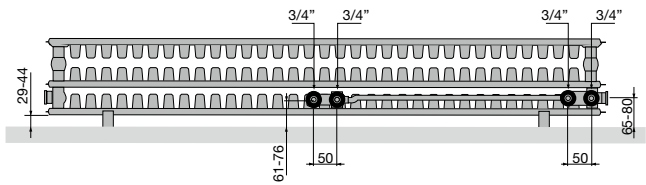
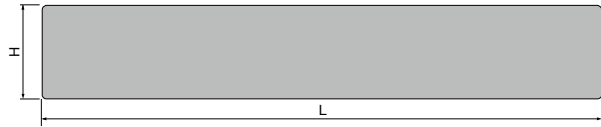

T33 | Bottom view



T33 | Top view

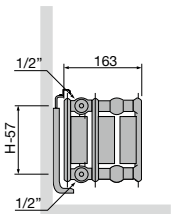

T33 | Side view

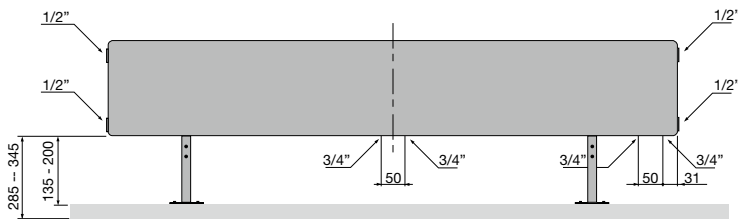
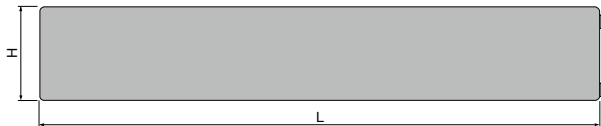



VASCO

Plinth radiators



VASCO also applies its critical approach to comfort and design to its plinth radiators.

Everything is focused on achieving the **highest possible efficiency** and as beautiful design as possible; the best and most elegant way to provide the space under large window surfaces with an appropriate heating solution.

VASCO plinth radiators provide equal heat distribution throughout the entire living space, with **minimum heat loss through the window.**

They can be stand-alone or fitted to the wall at the appropriate height, depth and length depending on the required heating capacity.

Plinth radiators

Primula

264

PRIMULA P1 / P2 / P3 / P4



TYPES

- P1, P2, P3, P4

TUBES

- Horizontal, rectangular 70 x 10 mm
- Between the square tubes, a powerful convection heat exchanger is welded, consisting of steel tubes of Ø 12 x 1 mm and rectangular fins of 0,4 mm.

COLLECTORS

- 2 integrated steel collectors

COLOURS

- Standard colour white RAL 9016
- Extensive colour chart see p. 10

SPECIAL

- Primula is available in 4 heights (70, 140, 210 and 280 mm), in 5 depths (80-130-180-230-280) and in 20 lengths (from 500 to 3900 mm).
- An elegant covering grill is supplied as standard.
- Wall supports, telescopic floor brackets or column feet are available with price supplement (are not included in the price).

BRACKETS

- To be ordered separately, not included in the price of the radiator

TECHNICAL

- Electrically laser welded
- KTL priming coat, powder coating
- Standard operating pressure: 4 bar
- Extra charge for higher service pressures (10 bar): +10%.
- The delivery time of a radiator with a higher service pressure is 1 week extra.
- Maximum operating temperature: 110°C

ELECTRICAL

- ✗ Pure electrical radiator prefilled
- ✗ Mixed radiator

TECHNICAL DRAWINGS

- See p. 288

CONNECTION

- ✗ One-point connection for one-pipe system
- ✗ One-point connection for two-pipe system
- ✗ Two-point connection for one-pipe system
- ✓ Two-point connection for two-pipe system (standard) (see p. 312)
- ✗ Integrated valve
- Connections: ½" (inner thread)

PRIMULA

Heating comfort with a sense of space

Heat a room with large windows, fully in line with the interior design and the architecture is right up the street of the Primula designer plinth radiator. The sleek, horizontal lines at low altitude contribute to the desired sense of space and the high heat output, also in the minimal version, it makes the contemporary comfort complete.

RECOMMENDED CONNECTION (0018)

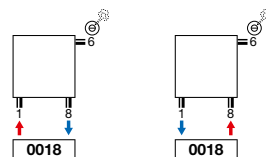

Other connection methods, see p. 287



HOW TO ORDER P1/80

Delivery time 15 - 30 working days
(transport duration not included)

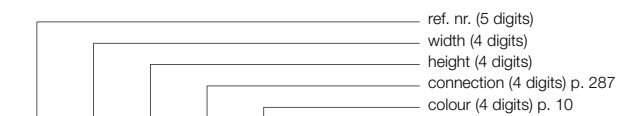

version (4 digits)
-0000 = standard
-A100 = higher service pressure (10 bar)

WALL BRACKET / TELESCOPIC FLOOR BRACKETS /
STEEL COLUMN FEET

See p. 285 for additional accessories.

PRIMULA P1 (P1/80)



P1

PRICE GROUP: VPG3 - PLINTH RADIATORS

REFERENCE CODE CUSTOM MADE P1	TECHNICAL DATA										STANDARD COLOUR	OTHER COLOURS				
	tubes	width (L mm)	height (H mm)	75/65/20 (Watt) (φ50K)	55/45/20 (Watt) (φ30K)	n-exp.	weight (kg)	water content (l)	electr. resistance (Watt)	price RAL 9016 (€)	price colour (€)					
REF. NR. P1 P1/80 : 11201																
11201	0500	0070	XXXX	YYYY	-0000	-	500	70	203	101	1,36	3,07	0,66	-	278	320
11201	0600	0070	XXXX	YYYY	-0000	-	600	70	243	121	1,36	3,68	0,79	-	291	335
11201	0700	0070	XXXX	YYYY	-0000	-	700	70	284	142	1,36	4,29	0,92	-	303	348
11201	0800	0070	XXXX	YYYY	-0000	-	800	70	324	162	1,36	4,90	1,05	-	316	363
11201	0900	0070	XXXX	YYYY	-0000	-	900	70	365	182	1,36	5,52	1,18	-	326	375
11201	1000	0070	XXXX	YYYY	-0000	-	1000	70	405	202	1,36	6,13	1,31	-	339	390
11201	1100	0070	XXXX	YYYY	-0000	-	1100	70	446	223	1,36	6,74	1,44	-	359	413
11201	1200	0070	XXXX	YYYY	-0000	-	1200	70	486	243	1,36	7,36	1,57	-	368	423
11201	1400	0070	XXXX	YYYY	-0000	-	1400	70	567	283	1,36	8,58	1,83	-	393	452
11201	1600	0070	XXXX	YYYY	-0000	-	1600	70	648	323	1,36	9,81	2,10	-	420	483
11201	1800	0070	XXXX	YYYY	-0000	-	1800	70	729	364	1,36	11,03	2,36	-	446	513
11201	2000	0070	XXXX	YYYY	-0000	-	2000	70	810	404	1,36	12,26	2,62	-	471	542
11201	2200	0070	XXXX	YYYY	-0000	-	2200	70	891	445	1,36	13,49	2,88	-	497	572
11201	2400	0070	XXXX	YYYY	-0000	-	2400	70	972	485	1,36	14,71	3,14	-	524	603
11201	2600	0070	XXXX	YYYY	-0000	-	2600	70	1053	526	1,36	15,94	3,41	-	550	633
11201	2800	0070	XXXX	YYYY	-0000	-	2800	70	1134	566	1,36	17,16	3,67	-	573	659
11201	3000	0070	XXXX	YYYY	-0000	-	3000	70	1215	607	1,36	18,39	3,93	-	602	692
11201	3300	0070	XXXX	YYYY	-0000	-	3300	70	1337	667	1,36	20,23	4,32	-	639	735
11201	3600	0070	XXXX	YYYY	-0000	-	3600	70	1458	728	1,36	22,07	4,72	-	680	782
11201	3900	0070	XXXX	YYYY	-0000	-	3900	70	1580	789	1,36	23,91	5,11	-	718	826

In conformity with EN442-1: 2014: radiators and convectors

For heat outputs in other regimes, see p. 320 (correction factors)
EXPORT. Prices in Euro (excl. VAT)

PRIMULA P1 (P1/130)



P1

HOW TO ORDER P1/130

Delivery time 15 - 30 working days
(transport duration not included)

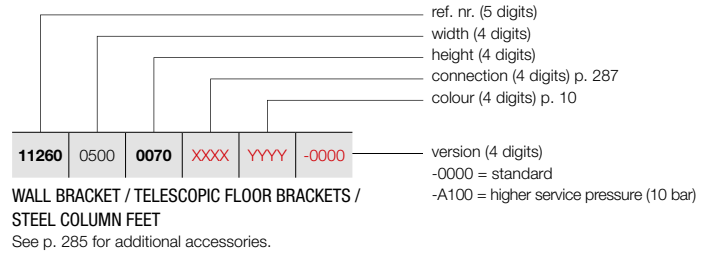

PRICE GROUP: VPG3 - PLINTH RADIATORS

REFERENCE CODE CUSTOM MADE P1	TECHNICAL DATA										STANDARD COLOUR	OTHER COLOURS
	tubes	width (L mm)	height (H mm)	75/65/20 (Watt) (φ50K)	55/45/20 (Watt) (φ30K)	n-exp.	weight (kg)	water content (l)	electr. resistance (Watt)	price RAL 9016 (€)	price colour (€)	
REF. NR. P1 P1/130 : 11260												
11260 0500 0070 XXXX YYYY -0000	-	500	70	312	156	1,36	4,33	0,88	-	369	424	
11260 0600 0070 XXXX YYYY -0000	-	600	70	374	187	1,36	5,19	1,05	-	390	449	
11260 0700 0070 XXXX YYYY -0000	-	700	70	437	218	1,36	6,06	1,23	-	410	472	
11260 0800 0070 XXXX YYYY -0000	-	800	70	499	249	1,36	6,92	1,40	-	433	498	
11260 0900 0070 XXXX YYYY -0000	-	900	70	562	281	1,36	7,79	1,58	-	451	519	
11260 1000 0070 XXXX YYYY -0000	-	1000	70	624	312	1,36	8,65	1,75	-	471	542	
11260 1100 0070 XXXX YYYY -0000	-	1100	70	686	342	1,36	9,52	1,93	-	491	565	
11260 1200 0070 XXXX YYYY -0000	-	1200	70	749	374	1,36	10,38	2,10	-	515	592	
11260 1400 0070 XXXX YYYY -0000	-	1400	70	874	436	1,36	12,11	2,45	-	553	636	
11260 1600 0070 XXXX YYYY -0000	-	1600	70	998	498	1,36	13,84	2,80	-	596	685	
11260 1800 0070 XXXX YYYY -0000	-	1800	70	1123	561	1,36	15,57	3,15	-	635	730	
11260 2000 0070 XXXX YYYY -0000	-	2000	70	1248	623	1,36	17,30	3,50	-	676	777	
11260 2200 0070 XXXX YYYY -0000	-	2200	70	1373	685	1,36	19,03	3,85	-	717	825	
11260 2400 0070 XXXX YYYY -0000	-	2400	70	1498	748	1,36	20,76	4,20	-	757	871	
11260 2600 0070 XXXX YYYY -0000	-	2600	70	1622	810	1,36	22,49	4,55	-	799	919	
11260 2800 0070 XXXX YYYY -0000	-	2800	70	1747	872	1,36	24,22	4,90	-	839	965	
11260 3000 0070 XXXX YYYY -0000	-	3000	70	1872	935	1,36	25,95	5,25	-	883	1015	
11260 3300 0070 XXXX YYYY -0000	-	3300	70	2059	1028	1,36	28,55	5,78	-	940	1081	
11260 3600 0070 XXXX YYYY -0000	-	3600	70	2246	1121	1,36	31,14	6,30	-	1002	1152	
11260 3900 0070 XXXX YYYY -0000	-	3900	70	2434	1215	1,36	33,74	6,83	-	1064	1224	

In conformity with EN442-1: 2014: radiators and convectors

For heat outputs in other regimes, see p. 320 (correction factors)
EXPORT. Prices in Euro (excl. VAT)

HOW TO ORDER P1/180

Delivery time 15 - 30 working days
(transport duration not included)

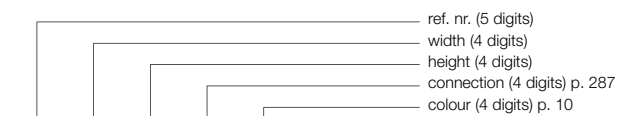

version (4 digits)
-0000 = standard
-A100 = higher service pressure (10 bar)

WALL BRACKET / TELESCOPIC FLOOR BRACKETS /
STEEL COLUMN FEET

See p. 285 for additional accessories.

PRIMULA P1 (P1/180)



P1

PRICE GROUP: VPG3 - PLINTH RADIATORS

REFERENCE CODE CUSTOM MADE P1	TECHNICAL DATA										STANDARD COLOUR	OTHER COLOURS
	tubes	width (L mm)	height (H mm)	75/65/20 (Watt) (φ50K)	55/45/20 (Watt) (φ30K)	n-exp.	weight (kg)	water content (l)	electr. resistance (Watt)	price RAL 9016 (€)	price colour (€)	
REF. NR. P1 P1/180 : 11264												
11264 0500 0070 XXXX YYYY -0000	-	500	70	422	212	1,35	5,70	1,05	-	490	564	
11264 0600 0070 XXXX YYYY -0000	-	600	70	506	254	1,35	6,84	1,26	-	524	603	
11264 0700 0070 XXXX YYYY -0000	-	700	70	590	296	1,35	7,98	1,47	-	554	637	
11264 0800 0070 XXXX YYYY -0000	-	800	70	674	338	1,35	9,12	1,68	-	588	676	
11264 0900 0070 XXXX YYYY -0000	-	900	70	759	381	1,35	10,26	1,89	-	619	712	
11264 1000 0070 XXXX YYYY -0000	-	1000	70	843	423	1,35	11,40	2,10	-	650	748	
11264 1100 0070 XXXX YYYY -0000	-	1100	70	927	465	1,35	12,54	2,31	-	683	785	
11264 1200 0070 XXXX YYYY -0000	-	1200	70	1012	508	1,35	13,68	2,52	-	713	820	
11264 1400 0070 XXXX YYYY -0000	-	1400	70	1180	592	1,35	15,96	2,94	-	779	896	
11264 1600 0070 XXXX YYYY -0000	-	1600	70	1349	677	1,35	18,24	3,36	-	842	968	
11264 1800 0070 XXXX YYYY -0000	-	1800	70	1517	761	1,35	20,52	3,78	-	905	1041	
11264 2000 0070 XXXX YYYY -0000	-	2000	70	1686	846	1,35	22,80	4,20	-	969	1114	
11264 2200 0070 XXXX YYYY -0000	-	2200	70	1855	931	1,35	25,08	4,62	-	1031	1186	
11264 2400 0070 XXXX YYYY -0000	-	2400	70	2023	1015	1,35	27,36	5,04	-	1095	1259	
11264 2600 0070 XXXX YYYY -0000	-	2600	70	2192	1100	1,35	29,64	5,46	-	1158	1332	
11264 2800 0070 XXXX YYYY -0000	-	2800	70	2360	1184	1,35	31,92	5,88	-	1224	1408	
11264 3000 0070 XXXX YYYY -0000	-	3000	70	2529	1269	1,35	34,20	6,30	-	1288	1481	
11264 3300 0070 XXXX YYYY -0000	-	3300	70	2782	1396	1,35	37,62	6,93	-	1382	1589	
11264 3600 0070 XXXX YYYY -0000	-	3600	70	3035	1523	1,35	41,04	7,56	-	1477	1699	
11264 3900 0070 XXXX YYYY -0000	-	3900	70	3288	1650	1,35	44,46	8,19	-	1575	1811	

In conformity with EN442-1: 2014: radiators and convectors

For heat outputs in other regimes, see p. 320 (correction factors)
EXPORT. Prices in Euro (excl. VAT)

PRIMULA P1 (P1/230)



P1

HOW TO ORDER P1/230

Delivery time 15 - 30 working days
(transport duration not included)

ref. nr. (5 digits)
width (4 digits)
height (4 digits)
connection (4 digits) p. 287
colour (4 digits) p. 10

version (4 digits)
-0000 = standard
-A100 = higher service pressure (10 bar)

11268 | 0500 | 0070 | XXXX | YYYY | -0000

WALL BRACKET / TELESCOPIC FLOOR BRACKETS / STEEL COLUMN FEET
See p. 285 for additional accessories.

PRICE GROUP: VPG3 - PLINTH RADIATORS

REFERENCE CODE CUSTOM MADE P1	TECHNICAL DATA										STANDARD COLOUR	OTHER COLOURS				
	tubes	width (L mm)	height (H mm)	75/65/20 (Watt) (φ50K)	55/45/20 (Watt) (φ30K)	n-exp.	weight (kg)	water content (l)	electr. resistance (Watt)	price RAL 9016 (€)	price colour (€)					
REF. NR. P1 P1/230 : 11268																
11268	0500	0070	XXXX	YYYY	-0000	-	500	70	523	258	1,38	6,90	1,20	-	629	723
11268	0600	0070	XXXX	YYYY	-0000	-	600	70	627	310	1,38	8,28	1,44	-	670	771
11268	0700	0070	XXXX	YYYY	-0000	-	700	70	732	362	1,38	9,66	1,68	-	710	817
11268	0800	0070	XXXX	YYYY	-0000	-	800	70	836	413	1,38	11,04	1,92	-	754	867
11268	0900	0070	XXXX	YYYY	-0000	-	900	70	941	465	1,38	12,42	2,16	-	794	913
11268	1000	0070	XXXX	YYYY	-0000	-	1000	70	1045	516	1,38	13,80	2,40	-	837	963
11268	1100	0070	XXXX	YYYY	-0000	-	1100	70	1150	568	1,38	15,18	2,64	-	883	1015
11268	1200	0070	XXXX	YYYY	-0000	-	1200	70	1254	620	1,38	16,56	2,88	-	922	1060
11268	1400	0070	XXXX	YYYY	-0000	-	1400	70	1463	723	1,38	19,32	3,36	-	1007	1158
11268	1600	0070	XXXX	YYYY	-0000	-	1600	70	1672	826	1,38	22,08	3,84	-	1091	1255
11268	1800	0070	XXXX	YYYY	-0000	-	1800	70	1881	929	1,38	24,84	4,32	-	1175	1351
11268	2000	0070	XXXX	YYYY	-0000	-	2000	70	2090	1033	1,38	27,60	4,80	-	1263	1452
11268	2200	0070	XXXX	YYYY	-0000	-	2200	70	2299	1136	1,38	30,36	5,28	-	1345	1547
11268	2400	0070	XXXX	YYYY	-0000	-	2400	70	2508	1239	1,38	33,12	5,76	-	1427	1641
11268	2600	0070	XXXX	YYYY	-0000	-	2600	70	2717	1343	1,38	35,88	6,24	-	1514	1741
11268	2800	0070	XXXX	YYYY	-0000	-	2800	70	2926	1446	1,38	38,64	6,72	-	1597	1837
11268	3000	0070	XXXX	YYYY	-0000	-	3000	70	3135	1549	1,38	41,40	7,20	-	1683	1935
11268	3300	0070	XXXX	YYYY	-0000	-	3300	70	3449	1704	1,38	45,54	7,92	-	1810	2082
11268	3600	0070	XXXX	YYYY	-0000	-	3600	70	3762	1859	1,38	49,68	8,64	-	1934	2224
11268	3900	0070	XXXX	YYYY	-0000	-	3900	70	4076	2014	1,38	53,82	9,36	-	2061	2370

In conformity with EN442-1: 2014: radiators and convectors

For heat outputs in other regimes, see p. 320 (correction factors)
EXPORT. Prices in Euro (excl. VAT)

HOW TO ORDER P1/280

Delivery time 15 - 30 working days
(transport duration not included)

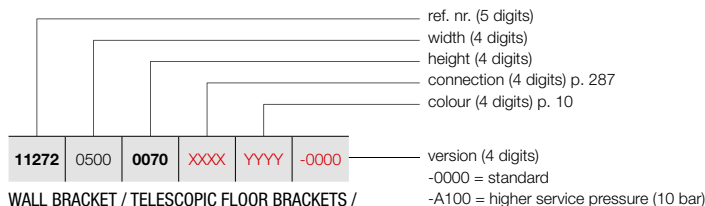

WALL BRACKET / TELESCOPIC FLOOR BRACKETS /
STEEL COLUMN FEET

See p. 285 for additional accessories.

PRIMULA P1 (P1/280)



P1

PRICE GROUP: VPG3 - PLINTH RADIATORS

REFERENCE CODE CUSTOM MADE P1	TECHNICAL DATA										STANDARD COLOUR	OTHER COLOURS
	tubes	width (L mm)	height (H mm)	75/65/20 (Watt) (φ50K)	55/45/20 (Watt) (φ30K)	n-exp.	weight (kg)	water content (l)	electr. resistance (Watt)	price RAL 9016 (€)	price colour (€)	
REF. NR. P1 P1/280 : 11272												
11272 0500 0070 XXXX YYYY -0000	-	500	70	630	315	1,36	8,00	1,40	-	768	883	
11272 0600 0070 XXXX YYYY -0000	-	600	70	756	377	1,36	9,60	1,68	-	821	944	
11272 0700 0070 XXXX YYYY -0000	-	700	70	882	440	1,36	11,20	1,96	-	870	1001	
11272 0800 0070 XXXX YYYY -0000	-	800	70	1008	503	1,36	12,80	2,24	-	923	1061	
11272 0900 0070 XXXX YYYY -0000	-	900	70	1134	566	1,36	14,40	2,52	-	976	1122	
11272 1000 0070 XXXX YYYY -0000	-	1000	70	1260	629	1,36	16,00	2,80	-	1027	1181	
11272 1100 0070 XXXX YYYY -0000	-	1100	70	1386	692	1,36	17,60	3,08	-	1080	1242	
11272 1200 0070 XXXX YYYY -0000	-	1200	70	1512	755	1,36	19,20	3,36	-	1132	1302	
11272 1400 0070 XXXX YYYY -0000	-	1400	70	1764	881	1,36	22,40	3,92	-	1233	1418	
11272 1600 0070 XXXX YYYY -0000	-	1600	70	2016	1006	1,36	25,60	4,48	-	1338	1539	
11272 1800 0070 XXXX YYYY -0000	-	1800	70	2268	1132	1,36	28,80	5,04	-	1443	1659	
11272 2000 0070 XXXX YYYY -0000	-	2000	70	2520	1258	1,36	32,00	5,60	-	1547	1779	
11272 2200 0070 XXXX YYYY -0000	-	2200	70	2772	1384	1,36	35,20	6,16	-	1649	1896	
11272 2400 0070 XXXX YYYY -0000	-	2400	70	3024	1510	1,36	38,40	6,72	-	1753	2016	
11272 2600 0070 XXXX YYYY -0000	-	2600	70	3276	1635	1,36	41,60	7,28	-	1855	2133	
11272 2800 0070 XXXX YYYY -0000	-	2800	70	3528	1761	1,36	44,80	7,84	-	1960	2254	
11272 3000 0070 XXXX YYYY -0000	-	3000	70	3780	1887	1,36	48,00	8,40	-	2062	2371	
11272 3300 0070 XXXX YYYY -0000	-	3300	70	4158	2076	1,36	52,80	9,24	-	2219	2552	
11272 3600 0070 XXXX YYYY -0000	-	3600	70	4536	2264	1,36	57,60	10,08	-	2375	2731	
11272 3900 0070 XXXX YYYY -0000	-	3900	70	4914	2453	1,36	62,40	10,92	-	2528	2907	

In conformity with EN442-1: 2014: radiators and convectors

For heat outputs in other regimes, see p. 320 (correction factors)
EXPORT. Prices in Euro (excl. VAT)

PRIMULA P2 (P2/80)



P2

HOW TO ORDER P2/80

Delivery time 15 - 30 working days
(transport duration not included)

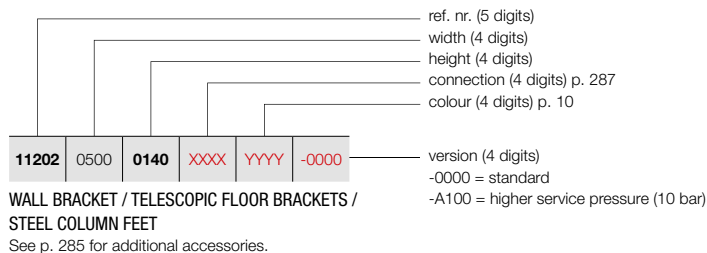

PRICE GROUP: VPG3 - PLINTH RADIATORS

REFERENCE CODE CUSTOM MADE P2	TECHNICAL DATA										STANDARD COLOUR	OTHER COLOURS
	tubes	width (L mm)	height (H mm)	75/65/20 (Watt) (φ50K)	55/45/20 (Watt) (φ30K)	n-exp.	weight (kg)	water content (l)	electr. resistance (Watt)	price RAL 9016 (€)	price colour (€)	
REF. NR. P2 P2/80 : 11202												
11202 0500 0140 XXXX YYYY -0000	-	500	140	304	153	1,35	5,73	1,46	-	324	373	
11202 0600 0140 XXXX YYYY -0000	-	600	140	365	183	1,35	6,88	1,75	-	345	397	
11202 0700 0140 XXXX YYYY -0000	-	700	140	426	214	1,35	8,02	2,04	-	364	419	
11202 0800 0140 XXXX YYYY -0000	-	800	140	486	244	1,35	9,17	2,33	-	383	440	
11202 0900 0140 XXXX YYYY -0000	-	900	140	547	274	1,35	10,31	2,62	-	403	463	
11202 1000 0140 XXXX YYYY -0000	-	1000	140	608	305	1,35	11,46	2,91	-	422	485	
11202 1100 0140 XXXX YYYY -0000	-	1100	140	669	336	1,35	12,61	3,20	-	442	508	
11202 1200 0140 XXXX YYYY -0000	-	1200	140	730	366	1,35	13,75	3,49	-	461	530	
11202 1400 0140 XXXX YYYY -0000	-	1400	140	851	427	1,35	16,04	4,07	-	498	573	
11202 1600 0140 XXXX YYYY -0000	-	1600	140	973	488	1,35	18,34	4,66	-	538	619	
11202 1800 0140 XXXX YYYY -0000	-	1800	140	1094	549	1,35	20,63	5,24	-	578	665	
11202 2000 0140 XXXX YYYY -0000	-	2000	140	1216	610	1,35	22,92	5,82	-	616	708	
11202 2200 0140 XXXX YYYY -0000	-	2200	140	1338	671	1,35	25,21	6,40	-	657	756	
11202 2400 0140 XXXX YYYY -0000	-	2400	140	1459	732	1,35	27,50	6,98	-	694	798	
11202 2600 0140 XXXX YYYY -0000	-	2600	140	1581	793	1,35	29,80	7,57	-	732	842	
11202 2800 0140 XXXX YYYY -0000	-	2800	140	1702	854	1,35	32,09	8,15	-	773	889	
11202 3000 0140 XXXX YYYY -0000	-	3000	140	1824	915	1,35	34,38	8,73	-	810	932	
11202 3300 0140 XXXX YYYY -0000	-	3300	140	2006	1007	1,35	37,82	9,60	-	865	995	
11202 3600 0140 XXXX YYYY -0000	-	3600	140	2189	1098	1,35	41,26	10,48	-	927	1066	
11202 3900 0140 XXXX YYYY -0000	-	3900	140	2371	1190	1,35	44,69	11,35	-	986	1134	

In conformity with EN442-1: 2014: radiators and convectors

For heat outputs in other regimes, see p. 320 (correction factors)
EXPORT. Prices in Euro (excl. VAT)

HOW TO ORDER P2/130

Delivery time 15 - 30 working days
(transport duration not included)

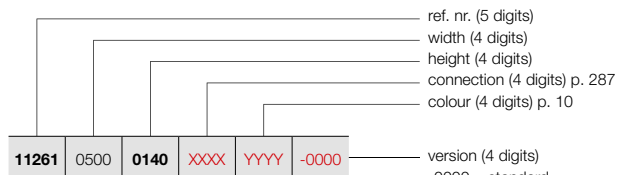

WALL BRACKET / TELESCOPIC FLOOR BRACKETS /
STEEL COLUMN FEET

See p. 285 for additional accessories.

PRIMULA P2 (P2/130)



P2

PRICE GROUP: VPG3 - PLINTH RADIATORS

REFERENCE CODE CUSTOM MADE P2	TECHNICAL DATA										STANDARD COLOUR	OTHER COLOURS
	tubes	width (L mm)	height (H mm)	75/65/20 (Watt) (φ50K)	55/45/20 (Watt) (φ30K)	n-exp.	weight (kg)	water content (l)	electr. resistance (Watt)	price RAL 9016 (€)	price colour (€)	
REF. NR. P2 P2/130 : 11261												
11261 0500 0140 XXXX YYYY -0000	-	500	140	442	221	1,36	7,77	1,87	-	421	484	
11261 0600 0140 XXXX YYYY -0000	-	600	140	530	265	1,36	9,32	2,24	-	457	526	
11261 0700 0140 XXXX YYYY -0000	-	700	140	619	309	1,36	10,87	2,61	-	490	564	
11261 0800 0140 XXXX YYYY -0000	-	800	140	707	353	1,36	12,42	2,98	-	529	608	
11261 0900 0140 XXXX YYYY -0000	-	900	140	796	397	1,36	13,98	3,36	-	564	649	
11261 1000 0140 XXXX YYYY -0000	-	1000	140	884	441	1,36	15,53	3,73	-	598	688	
11261 1100 0140 XXXX YYYY -0000	-	1100	140	972	485	1,36	17,08	4,10	-	633	728	
11261 1200 0140 XXXX YYYY -0000	-	1200	140	1061	530	1,36	18,64	4,48	-	670	771	
11261 1400 0140 XXXX YYYY -0000	-	1400	140	1238	618	1,36	21,74	5,22	-	740	851	
11261 1600 0140 XXXX YYYY -0000	-	1600	140	1414	706	1,36	24,85	5,97	-	808	929	
11261 1800 0140 XXXX YYYY -0000	-	1800	140	1591	794	1,36	27,95	6,71	-	881	1013	
11261 2000 0140 XXXX YYYY -0000	-	2000	140	1768	883	1,36	31,06	7,46	-	951	1094	
11261 2200 0140 XXXX YYYY -0000	-	2200	140	1945	971	1,36	34,17	8,21	-	1020	1173	
11261 2400 0140 XXXX YYYY -0000	-	2400	140	2122	1059	1,36	37,27	8,95	-	1091	1255	
11261 2600 0140 XXXX YYYY -0000	-	2600	140	2298	1147	1,36	40,38	9,70	-	1160	1334	
11261 2800 0140 XXXX YYYY -0000	-	2800	140	2475	1236	1,36	43,48	10,44	-	1230	1415	
11261 3000 0140 XXXX YYYY -0000	-	3000	140	2652	1324	1,36	46,59	11,19	-	1300	1495	
11261 3300 0140 XXXX YYYY -0000	-	3300	140	2917	1456	1,36	51,25	12,31	-	1405	1616	
11261 3600 0140 XXXX YYYY -0000	-	3600	140	3182	1588	1,36	55,91	13,43	-	1515	1742	
11261 3900 0140 XXXX YYYY -0000	-	3900	140	3448	1721	1,36	60,57	14,55	-	1618	1861	

In conformity with EN442-1: 2014: radiators and convectors

For heat outputs in other regimes, see p. 320 (correction factors)
EXPORT. Prices in Euro (excl. VAT)

PRIMULA P2 (P2/180)



P2

HOW TO ORDER P2/180
 Delivery time 15 - 30 working days
 (transport duration not included)

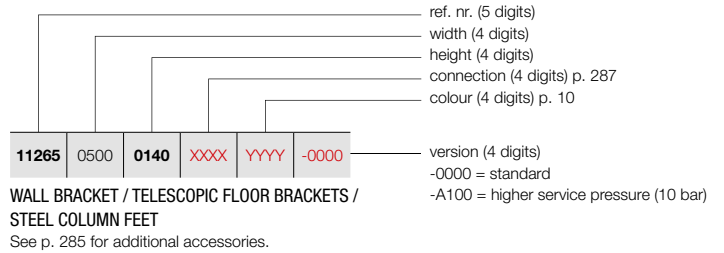

PRICE GROUP: VPG3 - PLINTH RADIATORS

REFERENCE CODE CUSTOM MADE P2	TECHNICAL DATA										STANDARD COLOUR	OTHER COLOURS	
	tubes	width (L mm)	height (H mm)	75/65/20 (Watt (φ50K))	55/45/20 (Watt (φ30K))	n-exp.	weight (kg)	water content (l)	electr. resistance (Watt)	price RAL 9016 (€)			price colour (€)
REF. NR. P2 P2/180 : 11265													
11265 0500 0140 XXXX YYYY -0000	-	500	140	611	305	1,36	9,90	2,23	-		554	637	
11265 0600 0140 XXXX YYYY -0000	-	600	140	733	366	1,36	11,88	2,67	-		606	697	
11265 0700 0140 XXXX YYYY -0000	-	700	140	855	427	1,36	13,86	3,12	-		657	756	
11265 0800 0140 XXXX YYYY -0000	-	800	140	977	488	1,36	15,84	3,56	-		705	811	
11265 0900 0140 XXXX YYYY -0000	-	900	140	1099	549	1,36	17,82	4,01	-		757	871	
11265 1000 0140 XXXX YYYY -0000	-	1000	140	1221	610	1,36	19,80	4,45	-		807	928	
11265 1100 0140 XXXX YYYY -0000	-	1100	140	1343	670	1,36	21,78	4,90	-		858	987	
11265 1200 0140 XXXX YYYY -0000	-	1200	140	1465	731	1,36	23,76	5,34	-		906	1042	
11265 1400 0140 XXXX YYYY -0000	-	1400	140	1709	853	1,36	27,72	6,23	-		1008	1159	
11265 1600 0140 XXXX YYYY -0000	-	1600	140	1954	975	1,36	31,68	7,12	-		1110	1277	
11265 1800 0140 XXXX YYYY -0000	-	1800	140	2198	1097	1,36	35,64	8,01	-		1213	1395	
11265 2000 0140 XXXX YYYY -0000	-	2000	140	2442	1219	1,36	39,60	8,90	-		1312	1509	
11265 2200 0140 XXXX YYYY -0000	-	2200	140	2686	1341	1,36	43,56	9,79	-		1413	1625	
11265 2400 0140 XXXX YYYY -0000	-	2400	140	2930	1463	1,36	47,52	10,68	-		1514	1741	
11265 2600 0140 XXXX YYYY -0000	-	2600	140	3175	1585	1,36	51,48	11,57	-		1614	1856	
11265 2800 0140 XXXX YYYY -0000	-	2800	140	3419	1707	1,36	55,44	12,46	-		1715	1972	
11265 3000 0140 XXXX YYYY -0000	-	3000	140	3663	1829	1,36	59,40	13,35	-		1813	2085	
11265 3300 0140 XXXX YYYY -0000	-	3300	140	4029	2011	1,36	65,34	14,69	-		1966	2261	
11265 3600 0140 XXXX YYYY -0000	-	3600	140	4396	2195	1,36	71,28	16,02	-		2116	2433	
11265 3900 0140 XXXX YYYY -0000	-	3900	140	4762	2377	1,36	77,22	17,36	-		2266	2606	

In conformity with EN442-1: 2014: radiators and convectors

For heat outputs in other regimes, see p. 320 (correction factors)
EXPORT. Prices in Euro (excl. VAT)

HOW TO ORDER P2/230

Delivery time 15 - 30 working days
(transport duration not included)

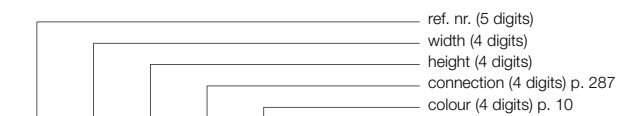

version (4 digits)
-0000 = standard
-A100 = higher service pressure (10 bar)

WALL BRACKET / TELESCOPIC FLOOR BRACKETS /
STEEL COLUMN FEET

See p. 285 for additional accessories.

PRIMULA P2 (P2/230)



P2

PRICE GROUP: VPG3 - PLINTH RADIATORS

REFERENCE CODE CUSTOM MADE P2	TECHNICAL DATA										STANDARD COLOUR	OTHER COLOURS
	tubes	width (L mm)	height (H mm)	75/65/20 (Watt) (φ50K)	55/45/20 (Watt) (φ30K)	n-exp.	weight (kg)	water content (l)	electr. resistance (Watt)	price RAL 9016 (€)	price colour (€)	
REF. NR. P2 P2/230 : 11269												
11269 0500 0140 XXXX YYYY -0000	-	500	140	756	375	1,37	11,88	2,73	-	713	820	
11269 0600 0140 XXXX YYYY -0000	-	600	140	907	450	1,37	14,25	3,27	-	785	903	
11269 0700 0140 XXXX YYYY -0000	-	700	140	1058	525	1,37	16,63	3,82	-	854	982	
11269 0800 0140 XXXX YYYY -0000	-	800	140	1209	600	1,37	19,00	4,36	-	923	1061	
11269 0900 0140 XXXX YYYY -0000	-	900	140	1360	675	1,37	21,38	4,91	-	995	1144	
11269 1000 0140 XXXX YYYY -0000	-	1000	140	1511	750	1,37	23,75	5,45	-	1063	1222	
11269 1100 0140 XXXX YYYY -0000	-	1100	140	1662	825	1,37	26,13	6,00	-	1133	1303	
11269 1200 0140 XXXX YYYY -0000	-	1200	140	1813	900	1,37	28,50	6,54	-	1204	1385	
11269 1400 0140 XXXX YYYY -0000	-	1400	140	2115	1050	1,37	33,25	7,63	-	1340	1541	
11269 1600 0140 XXXX YYYY -0000	-	1600	140	2418	1201	1,37	38,00	8,72	-	1483	1705	
11269 1800 0140 XXXX YYYY -0000	-	1800	140	2720	1351	1,37	42,75	9,81	-	1620	1863	
11269 2000 0140 XXXX YYYY -0000	-	2000	140	3022	1501	1,37	47,50	10,90	-	1759	2023	
11269 2200 0140 XXXX YYYY -0000	-	2200	140	3324	1651	1,37	52,25	11,99	-	1900	2185	
11269 2400 0140 XXXX YYYY -0000	-	2400	140	3626	1801	1,37	57,00	13,08	-	2039	2345	
11269 2600 0140 XXXX YYYY -0000	-	2600	140	3929	1951	1,37	61,75	14,17	-	2178	2505	
11269 2800 0140 XXXX YYYY -0000	-	2800	140	4231	2101	1,37	66,50	15,26	-	2319	2667	
11269 3000 0140 XXXX YYYY -0000	-	3000	140	4533	2251	1,37	71,25	16,35	-	2456	2824	
11269 3300 0140 XXXX YYYY -0000	-	3300	140	4986	2476	1,37	78,38	17,99	-	2663	3062	
11269 3600 0140 XXXX YYYY -0000	-	3600	140	5440	2702	1,37	85,50	19,62	-	2872	3303	
11269 3900 0140 XXXX YYYY -0000	-	3900	140	5893	2927	1,37	92,63	21,26	-	3082	3544	

In conformity with EN442-1: 2014: radiators and convectors

For heat outputs in other regimes, see p. 320 (correction factors)
EXPORT. Prices in Euro (excl. VAT)

PRIMULA P2 (P2/280)



P2

HOW TO ORDER P2/280

Delivery time 15 - 30 working days
(transport duration not included)

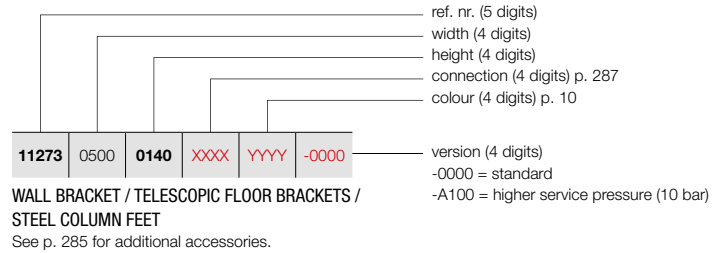

PRICE GROUP: VPG3 - PLINTH RADIATORS

REFERENCE CODE CUSTOM MADE P2	TECHNICAL DATA										STANDARD COLOUR	OTHER COLOURS
	tubes	width (L mm)	height (H mm)	75/65/20 (Watt) (φ50K)	55/45/20 (Watt) (φ30K)	n-exp.	weight (kg)	water content (l)	electr. resistance (Watt)	price RAL 9016 (€)	price colour (€)	
REF. NR. P2 P2/280 : 11273												
11273 0500 0140 XXXX YYYY -0000	-	500	140	953	473	1,37	13,85	2,98	-	880	1012	
11273 0600 0140 XXXX YYYY -0000	-	600	140	1143	568	1,37	16,62	3,57	-	961	1105	
11273 0700 0140 XXXX YYYY -0000	-	700	140	1334	663	1,37	19,39	4,17	-	1050	1208	
11273 0800 0140 XXXX YYYY -0000	-	800	140	1524	757	1,37	22,16	4,76	-	1134	1304	
11273 0900 0140 XXXX YYYY -0000	-	900	140	1715	852	1,37	24,93	5,36	-	1220	1403	
11273 1000 0140 XXXX YYYY -0000	-	1000	140	1905	946	1,37	27,70	5,95	-	1304	1500	
11273 1100 0140 XXXX YYYY -0000	-	1100	140	2096	1041	1,37	30,47	6,55	-	1389	1597	
11273 1200 0140 XXXX YYYY -0000	-	1200	140	2286	1135	1,37	33,24	7,14	-	1475	1696	
11273 1400 0140 XXXX YYYY -0000	-	1400	140	2667	1325	1,37	38,78	8,33	-	1647	1894	
11273 1600 0140 XXXX YYYY -0000	-	1600	140	3048	1514	1,37	44,32	9,52	-	1817	2090	
11273 1800 0140 XXXX YYYY -0000	-	1800	140	3429	1703	1,37	49,86	10,71	-	1986	2284	
11273 2000 0140 XXXX YYYY -0000	-	2000	140	3810	1892	1,37	55,40	11,90	-	2158	2482	
11273 2200 0140 XXXX YYYY -0000	-	2200	140	4191	2082	1,37	60,94	13,09	-	2330	2680	
11273 2400 0140 XXXX YYYY -0000	-	2400	140	4572	2271	1,37	66,48	14,28	-	2502	2877	
11273 2600 0140 XXXX YYYY -0000	-	2600	140	4953	2460	1,37	72,02	15,47	-	2673	3074	
11273 2800 0140 XXXX YYYY -0000	-	2800	140	5334	2649	1,37	77,56	16,66	-	2840	3266	
11273 3000 0140 XXXX YYYY -0000	-	3000	140	5715	2838	1,37	83,10	17,85	-	3014	3466	
11273 3300 0140 XXXX YYYY -0000	-	3300	140	6287	3123	1,37	91,41	19,64	-	3271	3762	
11273 3600 0140 XXXX YYYY -0000	-	3600	140	6858	3406	1,37	99,72	21,42	-	3526	4055	
11273 3900 0140 XXXX YYYY -0000	-	3900	140	7430	3690	1,37	108,03	23,21	-	3782	4349	

In conformity with EN442-1: 2014: radiators and convectors

For heat outputs in other regimes, see p. 320 (correction factors)
EXPORT. Prices in Euro (excl. VAT)

HOW TO ORDER P3/80

Delivery time 15 - 30 working days
(transport duration not included)

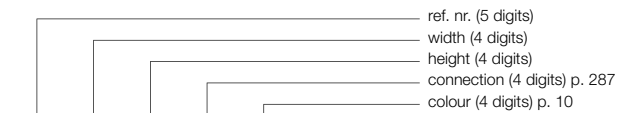

11203	0500	0210	XXXX	YYYY	-0000
-------	------	------	------	------	-------

version (4 digits)
-0000 = standard
-A100 = higher service pressure (10 bar)

WALL BRACKET / TELESCOPIC FLOOR BRACKETS / STEEL COLUMN FEET

See p. 285 for additional accessories.

PRIMULA P3 (P3/80)



P3

PRICE GROUP: VPG3 - PLINTH RADIATORS

REFERENCE CODE CUSTOM MADE P3	TECHNICAL DATA										STANDARD COLOUR	OTHER COLOURS				
	tubes	width (L mm)	height (H mm)	75/65/20 (Watt) (φ50K)	55/45/20 (Watt) (φ30K)	n-exp.	weight (kg)	water content (l)	electr. resistance (Watt)	price RAL 9016 (€)	price colour (€)					
REF. NR. P3 P3/80 : 11203																
11203	0500	0210	XXXX	YYYY	-0000	-	500	210	378	190	1,35	8,40	2,25	-	464	534
11203	0600	0210	XXXX	YYYY	-0000	-	600	210	454	228	1,35	10,08	2,70	-	487	560
11203	0700	0210	XXXX	YYYY	-0000	-	700	210	529	265	1,35	11,76	3,15	-	515	592
11203	0800	0210	XXXX	YYYY	-0000	-	800	210	605	304	1,35	13,44	3,60	-	537	618
11203	0900	0210	XXXX	YYYY	-0000	-	900	210	680	341	1,35	15,12	4,05	-	563	647
11203	1000	0210	XXXX	YYYY	-0000	-	1000	210	756	379	1,35	16,80	4,50	-	586	674
11203	1100	0210	XXXX	YYYY	-0000	-	1100	210	832	417	1,35	18,48	4,95	-	609	700
11203	1200	0210	XXXX	YYYY	-0000	-	1200	210	907	455	1,35	20,16	5,40	-	635	730
11203	1400	0210	XXXX	YYYY	-0000	-	1400	210	1058	531	1,35	23,52	6,30	-	683	785
11203	1600	0210	XXXX	YYYY	-0000	-	1600	210	1210	607	1,35	26,88	7,20	-	732	842
11203	1800	0210	XXXX	YYYY	-0000	-	1800	210	1361	683	1,35	30,24	8,10	-	782	899
11203	2000	0210	XXXX	YYYY	-0000	-	2000	210	1512	759	1,35	33,60	9,00	-	828	952
11203	2200	0210	XXXX	YYYY	-0000	-	2200	210	1663	834	1,35	36,96	9,90	-	880	1012
11203	2400	0210	XXXX	YYYY	-0000	-	2400	210	1814	910	1,35	40,32	10,80	-	924	1063
11203	2600	0210	XXXX	YYYY	-0000	-	2600	210	1966	986	1,35	43,68	11,70	-	975	1121
11203	2800	0210	XXXX	YYYY	-0000	-	2800	210	2117	1062	1,35	47,04	12,60	-	1022	1175
11203	3000	0210	XXXX	YYYY	-0000	-	3000	210	2268	1138	1,35	50,40	13,50	-	1072	1233
11203	3300	0210	XXXX	YYYY	-0000	-	3300	210	2495	1252	1,35	55,44	14,85	-	1146	1318
11203	3600	0210	XXXX	YYYY	-0000	-	3600	210	2722	1366	1,35	60,48	16,20	-	1219	1402
11203	3900	0210	XXXX	YYYY	-0000	-	3900	210	2948	1479	1,35	65,52	17,55	-	1293	1487

In conformity with EN442-1: 2014: radiators and convectors

For heat outputs in other regimes, see p. 320 (correction factors)
EXPORT. Prices in Euro (excl. VAT)



PRIMULA P3 (P3/130)



P3

HOW TO ORDER P3/130

Delivery time 15 - 30 working days
(transport duration not included)

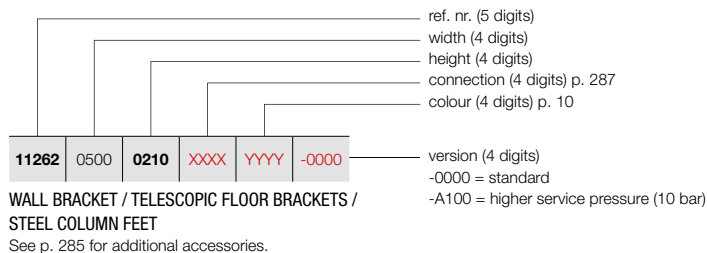

PRICE GROUP: VPG3 - PLINTH RADIATORS

REFERENCE CODE CUSTOM MADE P3	TECHNICAL DATA										STANDARD COLOUR	OTHER COLOURS
	tubes	width (L mm)	height (H mm)	75/65/20 (Watt) (φ50K)	55/45/20 (Watt) (φ30K)	n-exp.	weight (kg)	water content (l)	electr. resistance (Watt)	price RAL 9016 (€)	price colour (€)	
REF. NR. P3 P3/130 : 11262												
11262 0500 0210 XXXX YYYY -0000	-	500	210	560	281	1,35	11,20	2,85	-	559	643	
11262 0600 0210 XXXX YYYY -0000	-	600	210	672	337	1,35	13,44	3,42	-	597	687	
11262 0700 0210 XXXX YYYY -0000	-	700	210	784	393	1,35	15,68	3,99	-	636	731	
11262 0800 0210 XXXX YYYY -0000	-	800	210	896	450	1,35	17,92	4,56	-	675	776	
11262 0900 0210 XXXX YYYY -0000	-	900	210	1008	506	1,35	20,16	5,13	-	713	820	
11262 1000 0210 XXXX YYYY -0000	-	1000	210	1120	562	1,35	22,40	5,70	-	755	868	
11262 1100 0210 XXXX YYYY -0000	-	1100	210	1232	618	1,35	24,64	6,27	-	791	910	
11262 1200 0210 XXXX YYYY -0000	-	1200	210	1344	674	1,35	26,88	6,84	-	833	958	
11262 1400 0210 XXXX YYYY -0000	-	1400	210	1568	787	1,35	31,36	7,98	-	909	1045	
11262 1600 0210 XXXX YYYY -0000	-	1600	210	1792	899	1,35	35,84	9,12	-	993	1142	
11262 1800 0210 XXXX YYYY -0000	-	1800	210	2016	1012	1,35	40,32	10,26	-	1069	1229	
11262 2000 0210 XXXX YYYY -0000	-	2000	210	2240	1124	1,35	44,80	11,40	-	1149	1321	
11262 2200 0210 XXXX YYYY -0000	-	2200	210	2464	1236	1,35	49,28	12,54	-	1227	1411	
11262 2400 0210 XXXX YYYY -0000	-	2400	210	2688	1349	1,35	53,76	13,68	-	1304	1500	
11262 2600 0210 XXXX YYYY -0000	-	2600	210	2912	1461	1,35	58,24	14,82	-	1382	1589	
11262 2800 0210 XXXX YYYY -0000	-	2800	210	3136	1574	1,35	62,72	15,96	-	1460	1679	
11262 3000 0210 XXXX YYYY -0000	-	3000	210	3360	1686	1,35	67,20	17,10	-	1541	1772	
11262 3300 0210 XXXX YYYY -0000	-	3300	210	3696	1855	1,35	73,92	18,81	-	1659	1908	
11262 3600 0210 XXXX YYYY -0000	-	3600	210	4032	2023	1,35	80,64	20,52	-	1778	2045	
11262 3900 0210 XXXX YYYY -0000	-	3900	210	4368	2192	1,35	87,36	22,23	-	1895	2179	

In conformity with EN442-1: 2014: radiators and convectors

For heat outputs in other regimes, see p. 320 (correction factors)
EXPORT. Prices in Euro (excl. VAT)

HOW TO ORDER P3/180

Delivery time 15 - 30 working days
(transport duration not included)

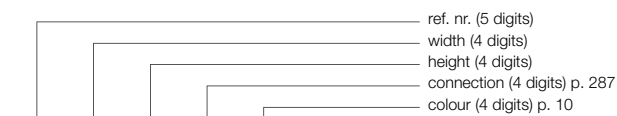

ref. nr. (5 digits)
width (4 digits)
height (4 digits)
connection (4 digits) p. 287
colour (4 digits) p. 10

11266 0500 **0210** XXXX YYYY -0000

version (4 digits)

-0000 = standard

-A100 = higher service pressure (10 bar)

WALL BRACKET / TELESCOPIC FLOOR BRACKETS /
STEEL COLUMN FEET

See p. 285 for additional accessories.

PRIMULA P3 (P3/180)



P3

PRICE GROUP: VPG3 - PLINTH RADIATORS

REFERENCE CODE CUSTOM MADE P3	TECHNICAL DATA										STANDARD COLOUR	OTHER COLOURS				
	tubes	width (L mm)	height (H mm)	75/65/20 (Watt) (φ50K)	55/45/20 (Watt) (φ30K)	n-exp.	weight (kg)	water content (l)	electr. resistance (Watt)	price RAL 9016 (€)	price colour (€)					
REF. NR. P3 P3/180 : 11266																
11266	0500	0210	XXXX	YYYY	-0000	-	500	210	771	381	1,38	14,10	3,40	-	714	821
11266	0600	0210	XXXX	YYYY	-0000	-	600	210	925	457	1,38	16,92	4,08	-	773	889
11266	0700	0210	XXXX	YYYY	-0000	-	700	210	1079	533	1,38	19,74	4,76	-	828	952
11266	0800	0210	XXXX	YYYY	-0000	-	800	210	1233	609	1,38	22,56	5,44	-	886	1019
11266	0900	0210	XXXX	YYYY	-0000	-	900	210	1387	685	1,38	25,38	6,12	-	937	1078
11266	1000	0210	XXXX	YYYY	-0000	-	1000	210	1541	761	1,38	28,20	6,80	-	996	1145
11266	1100	0210	XXXX	YYYY	-0000	-	1100	210	1695	838	1,38	31,02	7,48	-	1052	1210
11266	1200	0210	XXXX	YYYY	-0000	-	1200	210	1849	914	1,38	33,84	8,16	-	1107	1273
11266	1400	0210	XXXX	YYYY	-0000	-	1400	210	2157	1066	1,38	39,48	9,52	-	1219	1402
11266	1600	0210	XXXX	YYYY	-0000	-	1600	210	2466	1219	1,38	45,12	10,88	-	1329	1528
11266	1800	0210	XXXX	YYYY	-0000	-	1800	210	2774	1371	1,38	50,76	12,24	-	1442	1658
11266	2000	0210	XXXX	YYYY	-0000	-	2000	210	3082	1523	1,38	56,40	13,60	-	1551	1784
11266	2200	0210	XXXX	YYYY	-0000	-	2200	210	3390	1675	1,38	62,04	14,96	-	1662	1911
11266	2400	0210	XXXX	YYYY	-0000	-	2400	210	3698	1827	1,38	67,68	16,32	-	1774	2040
11266	2600	0210	XXXX	YYYY	-0000	-	2600	210	4007	1980	1,38	73,32	17,68	-	1885	2168
11266	2800	0210	XXXX	YYYY	-0000	-	2800	210	4315	2132	1,38	78,96	19,04	-	1999	2299
11266	3000	0210	XXXX	YYYY	-0000	-	3000	210	4623	2284	1,38	84,60	20,40	-	2110	2427
11266	3300	0210	XXXX	YYYY	-0000	-	3300	210	5085	2513	1,38	93,06	22,44	-	2278	2620
11266	3600	0210	XXXX	YYYY	-0000	-	3600	210	5548	2741	1,38	101,52	24,48	-	2444	2811
11266	3900	0210	XXXX	YYYY	-0000	-	3900	210	6010	2970	1,38	109,98	26,52	-	2610	3002

In conformity with EN442-1: 2014: radiators and convectors

For heat outputs in other regimes, see p. 320 (correction factors)
EXPORT. Prices in Euro (excl. VAT)

PRIMULA P3 (P3/230)



P3

HOW TO ORDER P3/230

Delivery time 15 - 30 working days
(transport duration not included)

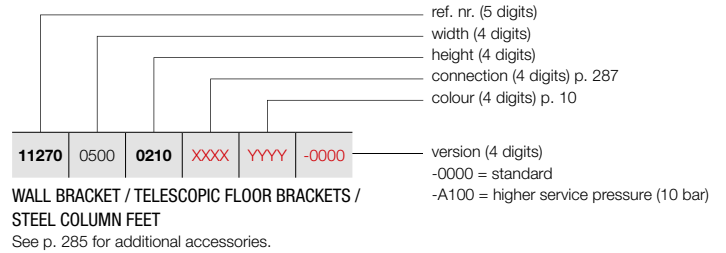

PRICE GROUP: VPG3 - PLINTH RADIATORS

REFERENCE CODE CUSTOM MADE P3	TECHNICAL DATA										STANDARD COLOUR	OTHER COLOURS
	tubes	width (L mm)	height (H mm)	75/65/20 (Watt) (φ50K)	55/45/20 (Watt) (φ30K)	n-exp.	weight (kg)	water content (l)	electr. resistance (Watt)	price RAL 9016 (€)	price colour (€)	
REF. NR. P3 P3/230 : 11270												
11270 0500 0210 XXXX YYYY -0000	-	500	210	950	472	1,37	16,85	4,25	-	880	1012	
11270 0600 0210 XXXX YYYY -0000	-	600	210	1140	566	1,37	20,22	5,10	-	951	1094	
11270 0700 0210 XXXX YYYY -0000	-	700	210	1330	661	1,37	23,59	5,95	-	1022	1175	
11270 0800 0210 XXXX YYYY -0000	-	800	210	1520	755	1,37	26,96	6,80	-	1095	1259	
11270 0900 0210 XXXX YYYY -0000	-	900	210	1710	849	1,37	30,33	7,65	-	1167	1342	
11270 1000 0210 XXXX YYYY -0000	-	1000	210	1900	944	1,37	33,70	8,50	-	1240	1426	
11270 1100 0210 XXXX YYYY -0000	-	1100	210	2090	1038	1,37	37,07	9,35	-	1314	1511	
11270 1200 0210 XXXX YYYY -0000	-	1200	210	2280	1132	1,37	40,44	10,20	-	1387	1595	
11270 1400 0210 XXXX YYYY -0000	-	1400	210	2660	1321	1,37	47,18	11,90	-	1533	1763	
11270 1600 0210 XXXX YYYY -0000	-	1600	210	3040	1510	1,37	53,92	13,60	-	1680	1932	
11270 1800 0210 XXXX YYYY -0000	-	1800	210	3420	1699	1,37	60,66	15,30	-	1823	2096	
11270 2000 0210 XXXX YYYY -0000	-	2000	210	3800	1887	1,37	67,40	17,00	-	1968	2263	
11270 2200 0210 XXXX YYYY -0000	-	2200	210	4180	2076	1,37	74,14	18,70	-	2115	2432	
11270 2400 0210 XXXX YYYY -0000	-	2400	210	4560	2265	1,37	80,88	20,40	-	2260	2599	
11270 2600 0210 XXXX YYYY -0000	-	2600	210	4940	2454	1,37	87,62	22,10	-	2406	2767	
11270 2800 0210 XXXX YYYY -0000	-	2800	210	5320	2642	1,37	94,36	23,80	-	2552	2935	
11270 3000 0210 XXXX YYYY -0000	-	3000	210	5700	2831	1,37	101,10	25,50	-	2698	3103	
11270 3300 0210 XXXX YYYY -0000	-	3300	210	6270	3114	1,37	111,21	28,05	-	2916	3353	
11270 3600 0210 XXXX YYYY -0000	-	3600	210	6840	3397	1,37	121,32	30,60	-	3134	3604	
11270 3900 0210 XXXX YYYY -0000	-	3900	210	7410	3680	1,37	131,43	33,15	-	3352	3855	

In conformity with EN442-1: 2014: radiators and convectors

For heat outputs in other regimes, see p. 320 (correction factors)
EXPORT. Prices in Euro (excl. VAT)

HOW TO ORDER P3/280

Delivery time 15 - 30 working days
(transport duration not included)

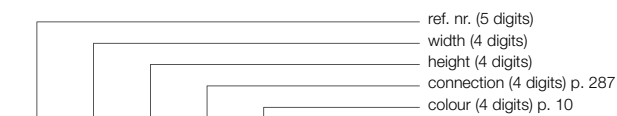

ref. nr. (5 digits)
width (4 digits)
height (4 digits)
connection (4 digits) p. 287
colour (4 digits) p. 10

11274 0500 0210 XXXX YYYY -0000
WALL BRACKET / TELESCOPIC FLOOR BRACKETS /
STEEL COLUMN FEET

version (4 digits)
-0000 = standard
-A100 = higher service pressure (10 bar)

See p. 285 for additional accessories.

PRIMULA P3 (P3/280)



P3

PRICE GROUP: VPG3 - PLINTH RADIATORS

REFERENCE CODE CUSTOM MADE P3	TECHNICAL DATA										STANDARD COLOUR	OTHER COLOURS
	tubes	width (L mm)	height (H mm)	75/65/20 (Watt) (φ50K)	55/45/20 (Watt) (φ30K)	n-exp.	weight (kg)	water content (l)	electr. resistance (Watt)	price RAL 9016 (€)	price colour (€)	
REF. NR. P3 P3/280 : 11274												
11274 0500 0210 XXXX YYYY -0000	-	500	210	1176	581	1,38	19,70	4,55	-	1039	1195	
11274 0600 0210 XXXX YYYY -0000	-	600	210	1411	697	1,38	23,64	5,46	-	1125	1294	
11274 0700 0210 XXXX YYYY -0000	-	700	210	1646	813	1,38	27,58	6,37	-	1214	1396	
11274 0800 0210 XXXX YYYY -0000	-	800	210	1881	929	1,38	31,52	7,28	-	1298	1493	
11274 0900 0210 XXXX YYYY -0000	-	900	210	2116	1046	1,38	35,46	8,19	-	1385	1593	
11274 1000 0210 XXXX YYYY -0000	-	1000	210	2351	1162	1,38	39,40	9,10	-	1472	1693	
11274 1100 0210 XXXX YYYY -0000	-	1100	210	2586	1278	1,38	43,34	10,01	-	1560	1794	
11274 1200 0210 XXXX YYYY -0000	-	1200	210	2821	1394	1,38	47,28	10,92	-	1646	1893	
11274 1400 0210 XXXX YYYY -0000	-	1400	210	3291	1626	1,38	55,16	12,74	-	1817	2090	
11274 1600 0210 XXXX YYYY -0000	-	1600	210	3762	1859	1,38	63,04	14,56	-	1987	2285	
11274 1800 0210 XXXX YYYY -0000	-	1800	210	4232	2091	1,38	70,92	16,38	-	2162	2486	
11274 2000 0210 XXXX YYYY -0000	-	2000	210	4702	2323	1,38	78,80	18,20	-	2335	2685	
11274 2200 0210 XXXX YYYY -0000	-	2200	210	5172	2556	1,38	86,68	20,02	-	2507	2883	
11274 2400 0210 XXXX YYYY -0000	-	2400	210	5642	2788	1,38	94,56	21,84	-	2681	3083	
11274 2600 0210 XXXX YYYY -0000	-	2600	210	6113	3021	1,38	102,44	23,66	-	2857	3286	
11274 2800 0210 XXXX YYYY -0000	-	2800	210	6583	3253	1,38	110,32	25,48	-	3027	3481	
11274 3000 0210 XXXX YYYY -0000	-	3000	210	7053	3485	1,38	118,20	27,30	-	3198	3678	
11274 3300 0210 XXXX YYYY -0000	-	3300	210	7758	3834	1,38	130,02	30,03	-	3459	3978	
11274 3600 0210 XXXX YYYY -0000	-	3600	210	8464	4182	1,38	141,84	32,76	-	3717	4275	

In conformity with EN442-1: 2014: radiators and convectors

For heat outputs in other regimes, see p. 320 (correction factors)
EXPORT. Prices in Euro (excl. VAT)

PRIMULA P4 (P4/80)



P4

HOW TO ORDER P4/80

Delivery time 15 - 30 working days
(transport duration not included)

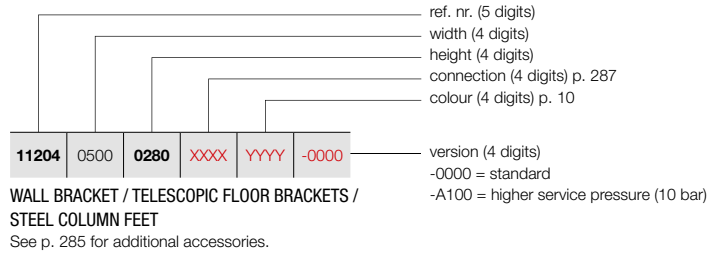

PRICE GROUP: VPG3 - PLINTH RADIATORS

REFERENCE CODE CUSTOM MADE P4	TECHNICAL DATA										STANDARD COLOUR	OTHER COLOURS
	tubes	width (L mm)	height (H mm)	75/65/20 (Watt) (φ50K)	55/45/20 (Watt) (φ30K)	n-exp.	weight (kg)	water content (l)	electr. resistance (Watt)	price RAL 9016 (€)	price colour (€)	
REF. NR. P4 P4/80 : 11204												
11204 0500 0280 XXXX YYYY -0000	-	500	280	435	219	1,34	11,07	3,05	-	588	676	
11204 0600 0280 XXXX YYYY -0000	-	600	280	522	263	1,34	13,28	3,65	-	622	715	
11204 0700 0280 XXXX YYYY -0000	-	700	280	609	307	1,34	15,50	4,26	-	652	750	
11204 0800 0280 XXXX YYYY -0000	-	800	280	696	351	1,34	17,71	4,87	-	686	789	
11204 0900 0280 XXXX YYYY -0000	-	900	280	783	395	1,34	19,93	5,48	-	717	825	
11204 1000 0280 XXXX YYYY -0000	-	1000	280	870	439	1,34	22,14	6,09	-	753	866	
11204 1100 0280 XXXX YYYY -0000	-	1100	280	957	483	1,34	24,35	6,70	-	784	902	
11204 1200 0280 XXXX YYYY -0000	-	1200	280	1044	527	1,34	26,57	7,31	-	818	941	
11204 1400 0280 XXXX YYYY -0000	-	1400	280	1218	614	1,34	31,00	8,53	-	885	1018	
11204 1600 0280 XXXX YYYY -0000	-	1600	280	1392	702	1,34	35,42	9,74	-	947	1089	
11204 1800 0280 XXXX YYYY -0000	-	1800	280	1566	790	1,34	39,85	10,96	-	1011	1163	
11204 2000 0280 XXXX YYYY -0000	-	2000	280	1740	878	1,34	44,28	12,18	-	1076	1237	
11204 2200 0280 XXXX YYYY -0000	-	2200	280	1914	965	1,34	48,71	13,40	-	1142	1313	
11204 2400 0280 XXXX YYYY -0000	-	2400	280	2088	1053	1,34	53,14	14,62	-	1207	1388	
11204 2600 0280 XXXX YYYY -0000	-	2600	280	2262	1141	1,34	57,56	15,83	-	1272	1463	
11204 2800 0280 XXXX YYYY -0000	-	2800	280	2436	1229	1,34	61,99	17,05	-	1338	1539	
11204 3000 0280 XXXX YYYY -0000	-	3000	280	2610	1316	1,34	66,42	18,27	-	1402	1612	
11204 3300 0280 XXXX YYYY -0000	-	3300	280	2871	1448	1,34	73,06	20,10	-	1501	1726	
11204 3600 0280 XXXX YYYY -0000	-	3600	280	3132	1580	1,34	79,70	21,92	-	1599	1839	
11204 3900 0280 XXXX YYYY -0000	-	3900	280	3393	1711	1,34	86,35	23,75	-	1696	1950	

In conformity with EN442-1: 2014: radiators and convectors

For heat outputs in other regimes, see p. 320 (correction factors)
EXPORT. Prices in Euro (excl. VAT)

HOW TO ORDER P4/130

Delivery time 15 - 30 working days
(transport duration not included)

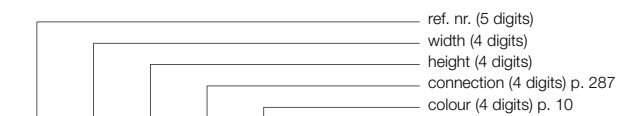

11263	0500	0280	XXXX	YYYY	-0000
-------	------	------	------	------	-------

version (4 digits)
-0000 = standard
-A100 = higher service pressure (10 bar)

WALL BRACKET / TELESCOPIC FLOOR BRACKETS /
STEEL COLUMN FEET

See p. 285 for additional accessories.

PRIMULA P4 (P4/130)



P4

PRICE GROUP: VPG3 - PLINTH RADIATORS

REFERENCE CODE CUSTOM MADE P4	TECHNICAL DATA										STANDARD COLOUR	OTHER COLOURS				
	tubes	width (L mm)	height (H mm)	75/65/20 (Watt) (φ50K)	55/45/20 (Watt) (φ30K)	n-exp.	weight (kg)	water content (l)	electr. resistance (Watt)	price RAL 9016 (€)	price colour (€)					
REF. NR. P4 P4/130 : 11263																
11263	0500	0280	XXXX	YYYY	-0000	-	500	280	678	333	1,39	14,64	3,84	-	657	756
11263	0600	0280	XXXX	YYYY	-0000	-	600	280	813	400	1,39	17,57	4,61	-	705	811
11263	0700	0280	XXXX	YYYY	-0000	-	700	280	949	467	1,39	20,50	5,38	-	757	871
11263	0800	0280	XXXX	YYYY	-0000	-	800	280	1084	533	1,39	23,42	6,14	-	807	928
11263	0900	0280	XXXX	YYYY	-0000	-	900	280	1220	600	1,39	26,35	6,91	-	858	987
11263	1000	0280	XXXX	YYYY	-0000	-	1000	280	1355	666	1,39	29,28	7,68	-	908	1044
11263	1100	0280	XXXX	YYYY	-0000	-	1100	280	1491	733	1,39	32,21	8,45	-	959	1103
11263	1200	0280	XXXX	YYYY	-0000	-	1200	280	1626	799	1,39	35,14	9,22	-	1009	1160
11263	1400	0280	XXXX	YYYY	-0000	-	1400	280	1897	933	1,39	40,99	10,75	-	1112	1279
11263	1600	0280	XXXX	YYYY	-0000	-	1600	280	2168	1066	1,39	46,85	12,29	-	1214	1396
11263	1800	0280	XXXX	YYYY	-0000	-	1800	280	2439	1199	1,39	52,70	13,82	-	1314	1511
11263	2000	0280	XXXX	YYYY	-0000	-	2000	280	2710	1332	1,39	58,56	15,36	-	1416	1628
11263	2200	0280	XXXX	YYYY	-0000	-	2200	280	2981	1466	1,39	64,42	16,90	-	1518	1746
11263	2400	0280	XXXX	YYYY	-0000	-	2400	280	3252	1599	1,39	70,27	18,43	-	1617	1860
11263	2600	0280	XXXX	YYYY	-0000	-	2600	280	3523	1732	1,39	76,13	19,97	-	1719	1977
11263	2800	0280	XXXX	YYYY	-0000	-	2800	280	3794	1865	1,39	81,98	21,50	-	1821	2094
11263	3000	0280	XXXX	YYYY	-0000	-	3000	280	4065	1998	1,39	87,84	23,04	-	1920	2208
11263	3300	0280	XXXX	YYYY	-0000	-	3300	280	4472	2199	1,39	96,62	25,34	-	2075	2386
11263	3600	0280	XXXX	YYYY	-0000	-	3600	280	4878	2398	1,39	105,41	27,65	-	2226	2560
11263	3900	0280	XXXX	YYYY	-0000	-	3900	280	5285	2598	1,39	114,19	29,95	-	2377	2734

In conformity with EN442-1: 2014: radiators and convectors

For heat outputs in other regimes, see p. 320 (correction factors)
EXPORT. Prices in Euro (excl. VAT)

PRIMULA P4 (P4/180)



P4

HOW TO ORDER P4/180

Delivery time 15 - 30 working days
(transport duration not included)

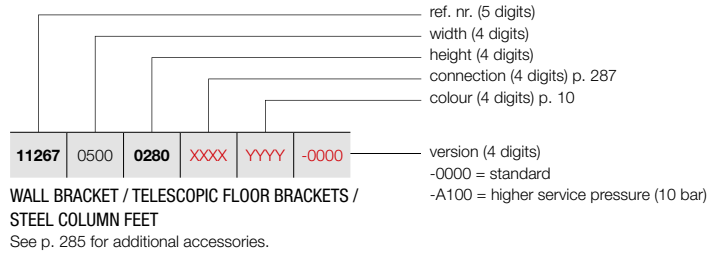

PRICE GROUP: VPG3 - PLINTH RADIATORS

REFERENCE CODE CUSTOM MADE P4	TECHNICAL DATA										STANDARD COLOUR	OTHER COLOURS
	tubes	width (L mm)	height (H mm)	75/65/20 (Watt) (φ50K)	55/45/20 (Watt) (φ30K)	n-exp.	weight (kg)	water content (l)	electr. resistance (Watt)	price RAL 9016 (€)	price colour (€)	
REF. NR. P4 P4/180 : 11267												
11267 0500 0280 XXXX YYYY -0000	-	500	280	919	449	1,40	18,30	4,58	-	848	975	
11267 0600 0280 XXXX YYYY -0000	-	600	280	1103	539	1,40	21,96	5,49	-	917	1055	
11267 0700 0280 XXXX YYYY -0000	-	700	280	1287	629	1,40	25,62	6,41	-	989	1137	
11267 0800 0280 XXXX YYYY -0000	-	800	280	1470	719	1,40	29,28	7,32	-	1058	1217	
11267 0900 0280 XXXX YYYY -0000	-	900	280	1654	809	1,40	32,94	8,24	-	1129	1298	
11267 1000 0280 XXXX YYYY -0000	-	1000	280	1838	899	1,40	36,60	9,15	-	1201	1381	
11267 1100 0280 XXXX YYYY -0000	-	1100	280	2022	989	1,40	40,26	10,07	-	1269	1459	
11267 1200 0280 XXXX YYYY -0000	-	1200	280	2206	1079	1,40	43,92	10,98	-	1340	1541	
11267 1400 0280 XXXX YYYY -0000	-	1400	280	2573	1258	1,40	51,24	12,81	-	1484	1707	
11267 1600 0280 XXXX YYYY -0000	-	1600	280	2941	1438	1,40	58,56	14,64	-	1623	1866	
11267 1800 0280 XXXX YYYY -0000	-	1800	280	3308	1618	1,40	65,88	16,47	-	1764	2029	
11267 2000 0280 XXXX YYYY -0000	-	2000	280	3676	1798	1,40	73,20	18,30	-	1908	2194	
11267 2200 0280 XXXX YYYY -0000	-	2200	280	4044	1978	1,40	80,52	20,13	-	2048	2355	
11267 2400 0280 XXXX YYYY -0000	-	2400	280	4411	2157	1,40	87,84	21,96	-	2189	2517	
11267 2600 0280 XXXX YYYY -0000	-	2600	280	4779	2337	1,40	95,16	23,79	-	2332	2682	
11267 2800 0280 XXXX YYYY -0000	-	2800	280	5146	2517	1,40	102,48	25,62	-	2476	2847	
11267 3000 0280 XXXX YYYY -0000	-	3000	280	5514	2697	1,40	109,80	27,45	-	2614	3006	
11267 3300 0280 XXXX YYYY -0000	-	3300	280	6065	2966	1,40	120,78	30,20	-	2827	3251	
11267 3600 0280 XXXX YYYY -0000	-	3600	280	6617	3236	1,40	131,76	32,94	-	3039	3495	
11267 3900 0280 XXXX YYYY -0000	-	3900	280	7168	3506	1,40	142,74	35,69	-	3252	3740	

In conformity with EN442-1: 2014: radiators and convectors

For heat outputs in other regimes, see p. 320 (correction factors)
EXPORT. Prices in Euro (excl. VAT)

HOW TO ORDER P4/230

Delivery time 15 - 30 working days
(transport duration not included)

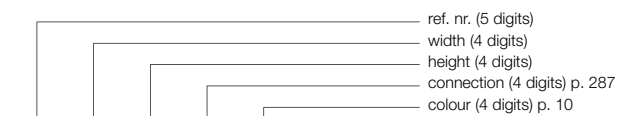

version (4 digits)
-0000 = standard
-A100 = higher service pressure (10 bar)

WALL BRACKET / TELESCOPIC FLOOR BRACKETS /
STEEL COLUMN FEET

See p. 285 for additional accessories.

PRIMULA P4 (P4/230)



P4

PRICE GROUP: VPG3 - PLINTH RADIATORS

REFERENCE CODE CUSTOM MADE P4	TECHNICAL DATA										STANDARD COLOUR	OTHER COLOURS
	tubes	width (L mm)	height (H mm)	75/65/20 (Watt) (φ50K)	55/45/20 (Watt) (φ30K)	n-exp.	weight (kg)	water content (l)	electr. resistance (Watt)	price RAL 9016 (€)	price colour (€)	
REF. NR. P4 P4/230 : 11271												
11271 0500 0280 XXXX YYYY -0000	-	500	280	1129	552	1,40	21,83	5,78	-	1056	1214	
11271 0600 0280 XXXX YYYY -0000	-	600	280	1355	663	1,40	26,19	6,93	-	1151	1324	
11271 0700 0280 XXXX YYYY -0000	-	700	280	1581	773	1,40	30,56	8,09	-	1244	1431	
11271 0800 0280 XXXX YYYY -0000	-	800	280	1806	883	1,40	34,92	9,24	-	1339	1540	
11271 0900 0280 XXXX YYYY -0000	-	900	280	2032	994	1,40	39,29	10,40	-	1435	1650	
11271 1000 0280 XXXX YYYY -0000	-	1000	280	2258	1104	1,40	43,65	11,55	-	1529	1758	
11271 1100 0280 XXXX YYYY -0000	-	1100	280	2484	1215	1,40	48,02	12,71	-	1623	1866	
11271 1200 0280 XXXX YYYY -0000	-	1200	280	2710	1326	1,40	52,38	13,86	-	1718	1976	
11271 1400 0280 XXXX YYYY -0000	-	1400	280	3161	1546	1,40	61,11	16,17	-	1908	2194	
11271 1600 0280 XXXX YYYY -0000	-	1600	280	3613	1767	1,40	69,84	18,48	-	2097	2412	
11271 1800 0280 XXXX YYYY -0000	-	1800	280	4064	1988	1,40	78,57	20,79	-	2286	2629	
11271 2000 0280 XXXX YYYY -0000	-	2000	280	4516	2209	1,40	87,30	23,10	-	2478	2850	
11271 2200 0280 XXXX YYYY -0000	-	2200	280	4968	2430	1,40	96,03	25,41	-	2665	3065	
11271 2400 0280 XXXX YYYY -0000	-	2400	280	5419	2651	1,40	104,76	27,72	-	2857	3286	
11271 2600 0280 XXXX YYYY -0000	-	2600	280	5871	2872	1,40	113,49	30,03	-	3043	3499	
11271 2800 0280 XXXX YYYY -0000	-	2800	280	6322	3092	1,40	122,22	32,34	-	3236	3721	
11271 3000 0280 XXXX YYYY -0000	-	3000	280	6774	3313	1,40	130,95	34,65	-	3421	3934	
11271 3300 0280 XXXX YYYY -0000	-	3300	280	7451	3644	1,40	144,05	38,12	-	3708	4264	

In conformity with EN442-1: 2014: radiators and convectors

For heat outputs in other regimes, see p. 320 (correction factors)
EXPORT. Prices in Euro (excl. VAT)

PRIMULA P4 (P4/280)



P4

HOW TO ORDER P4/280

Delivery time 15 - 30 working days
(transport duration not included)

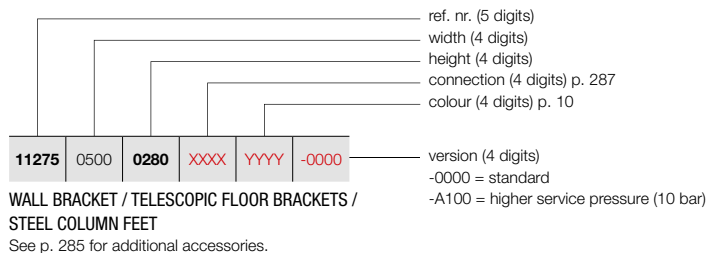

PRICE GROUP: VPG3 - PLINTH RADIATORS

REFERENCE CODE CUSTOM MADE P4	TECHNICAL DATA										STANDARD COLOUR	OTHER COLOURS
	tubes	width (L mm)	height (H mm)	75/65/20 (Watt) (φ50K)	55/45/20 (Watt) (φ30K)	n-exp.	weight (kg)	water content (l)	electr. resistance (Watt)	price RAL 9016 (€)	price colour (€)	
REF. NR. P4 P4/280 : 11275												
11275 0500 0280 XXXX YYYY -0000	-	500	280	1335	653	1,40	25,55	6,13	-	1272	1463	
11275 0600 0280 XXXX YYYY -0000	-	600	280	1602	784	1,40	30,66	7,35	-	1388	1596	
11275 0700 0280 XXXX YYYY -0000	-	700	280	1869	914	1,40	35,77	8,58	-	1501	1726	
11275 0800 0280 XXXX YYYY -0000	-	800	280	2136	1045	1,40	40,88	9,80	-	1616	1858	
11275 0900 0280 XXXX YYYY -0000	-	900	280	2403	1175	1,40	45,99	11,03	-	1731	1991	
11275 1000 0280 XXXX YYYY -0000	-	1000	280	2670	1306	1,40	51,10	12,25	-	1846	2123	
11275 1100 0280 XXXX YYYY -0000	-	1100	280	2937	1437	1,40	56,21	13,48	-	1960	2254	
11275 1200 0280 XXXX YYYY -0000	-	1200	280	3204	1567	1,40	61,32	14,70	-	2075	2386	
11275 1400 0280 XXXX YYYY -0000	-	1400	280	3738	1828	1,40	71,54	17,15	-	2300	2645	
11275 1600 0280 XXXX YYYY -0000	-	1600	280	4272	2090	1,40	81,76	19,60	-	2530	2910	
11275 1800 0280 XXXX YYYY -0000	-	1800	280	4806	2351	1,40	91,98	22,05	-	2758	3172	
11275 2000 0280 XXXX YYYY -0000	-	2000	280	5340	2612	1,40	102,20	24,50	-	2986	3434	
11275 2200 0280 XXXX YYYY -0000	-	2200	280	5874	2873	1,40	112,42	26,95	-	3214	3696	
11275 2400 0280 XXXX YYYY -0000	-	2400	280	6408	3134	1,40	122,64	29,40	-	3444	3961	
11275 2600 0280 XXXX YYYY -0000	-	2600	280	6942	3395	1,40	132,86	31,85	-	3672	4223	
11275 2800 0280 XXXX YYYY -0000	-	2800	280	7476	3657	1,40	143,08	34,30	-	3898	4483	

In conformity with EN442-1: 2014: radiators and convectors

For heat outputs in other regimes, see p. 320 (correction factors)
EXPORT. Prices in Euro (excl. VAT)

PRICE GROUP: VPG10 - ACC.

LENGTH IN MM NUMBER NEEDED PER PLINTH	REF. NR. P/80	REF. NR. P/130	REF. NR. P/180	REF. NR. P/230	REF. NR. P/280	COLOUR	€
---	------------------	-------------------	-------------------	-------------------	-------------------	--------	---

WALL BRACKET*



500 - 1800: 2	118601200009016	118602200009016	118603200009016	118604200009016	118605200009016	RAL 9016	28
	11860120000XXXX	11860220000XXXX	11860320000XXXX	11860420000XXXX	11860520000XXXX	COLOUR	32
2000 - 2400: 3	118601300009016	118602300009016	118603300009016	118604300009016	118605300009016	RAL 9016	42
	11860130000XXXX	11860230000XXXX	11860330000XXXX	11860430000XXXX	11860530000XXXX	COLOUR	48
2600 - 3600: 4	118601400009016	118602400009016	118603400009016	118604400009016	118605400009016	RAL 9016	56
	11860140000XXXX	11860240000XXXX	11860340000XXXX	11860440000XXXX	11860540000XXXX	COLOUR	64
3900: 5	118601500009016	118602500009016	118603500009016	118604500009016	118605500009016	RAL 9016	70
	11860150000XXXX	11860250000XXXX	11860350000XXXX	11860450000XXXX	11860550000XXXX	COLOUR	80

When ordering the wall mounting brackets, please indicate the type (80-130-180-230-280) and the colour. Maximum width/bracket: for P3: depth = 180 mm, for P4: depth = 130 mm.

* number needed per plinth:

in mm	P1					P2					P3			P4	
	80	130	180	230	280	80	130	180	230	280	80	130	180	80	130
up to 1800 mm	2	3	3	4	4	2	3	3	4	5	2	3	3	2	3
1900 - 2400 mm	2	3	3	4	4	2	3	3	4	6	2	3	3	3	3
2500 - 3600 mm	3	3	3	4	5	3	3	4	5	6	3	3	4	3	4
3700 - 3900 mm	3	3	3	4	5	3	3	4	5	6	3	4	4	3	4

EXPORT. Prices in Euro (excl. VAT)

PRIMULA FREE-STANDING INSTALLATION
IN OPTION

PRICE GROUP: VPG10 - ACC.

LENGTH IN MM NUMBER NEEDED PER PLINTH	COLOUR	REF. NR. P/80	€	REF. NR. P/130	€	REF. NR. P/180	€	REF. NR. P/230	€	REF. NR. P/280	€
--	--------	------------------	---	-------------------	---	-------------------	---	-------------------	---	-------------------	---

**STEEL COLUMN
FEET**



500 - 1800: 2	RAL 9016	118621200009016	86	118622200009016	88	118623200009016	90	118624200009016	92	118625200009016	98
	COLOUR	11862120000XXXX	98	11862220000XXXX	102	11862320000XXXX	104	11862420000XXXX	106	11862520000XXXX	112
2000 - 2400: 3	RAL 9016	118621300009016	129	118622300009016	132	118623300009016	135	118624300009016	138	118625300009016	147
	COLOUR	11862130000XXXX	147	11862230000XXXX	153	11862330000XXXX	156	11862430000XXXX	159	11862530000XXXX	168
2600 - 3600: 4	RAL 9016	118621400009016	172	118622400009016	176	118623400009016	180	118624400009016	184	118625400009016	196
	COLOUR	11862140000XXXX	196	11862240000XXXX	204	11862340000XXXX	208	11862440000XXXX	212	11862540000XXXX	224
3900: 5	RAL 9016	118621500009016	215	118622500009016	220	118623500009016	225	118624500009016	230	118625500009016	245
	COLOUR	11862150000XXXX	245	11862250000XXXX	255	11862350000XXXX	260	11862450000XXXX	265	11862550000XXXX	280

Steel column feet enable to fix a thermostatic valve. The standard height of the feet is 150 mm. Possible for all connections except for connection 11 and 88. Number of column feet needed = number of telescopic feet needed.

EXPORT. Prices in Euro (excl. VAT)

PRICE GROUP: VPG10 - ACC.

LENGTH IN MM NUMBER NEEDED PER PLINTH	REF. NR. P/80	REF. NR. P/130	REF. NR. P/180	REF. NR. P/230	REF. NR. P/280	COLOUR	€
--	------------------	-------------------	-------------------	-------------------	-------------------	--------	---

**TELESCOPIC FLOOR
BRACKETS**



500 - 1800: 2	118611200009016	118612200009016	118613200009016	118614200009016	118615200009016	RAL 9016	46
	11861120000XXXX	11861220000XXXX	11861320000XXXX	11861420000XXXX	11861520000XXXX	COLOUR	52
2000 - 2400: 3	118611300009016	118612300009016	118613300009016	118614300009016	118615300009016	RAL 9016	69
	11861130000XXXX	11861230000XXXX	11861330000XXXX	11861430000XXXX	11861530000XXXX	COLOUR	78
2600 - 3600: 4	118611400009016	118612400009016	118613400009016	118614400009016	118615400009016	RAL 9016	92
	11861140000XXXX	11861240000XXXX	11861340000XXXX	11861440000XXXX	11861540000XXXX	COLOUR	104
3900: 5	118611500009016	118612500009016	118613500009016	118614500009016	118615500009016	RAL 9016	115
	11861150000XXXX	11861250000XXXX	11861350000XXXX	11861450000XXXX	11861550000XXXX	COLOUR	130

When ordering the floor brackets, please indicate the type (80-130-180-230-280) and the colour. The feet are delivered standard with rosets. Max. height of the floor brackets: 265 mm. Min. height of the floor brackets: 205 mm. The upper part of the foot consists of a rectangular foot of 40/25 mm, the lower part of a rectangular foot of 35/20 mm.

EXPORT. Prices in Euro (excl. VAT)

PRIMULA: P1 / P2 / P3 / P4

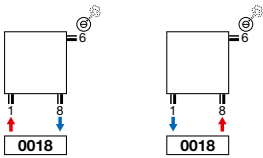

PRIMULA: P2 / P3 / P4

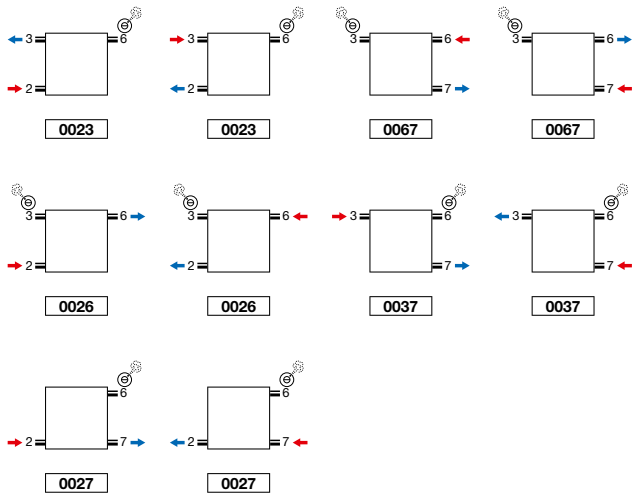

UNIVERSAL CONNECTION

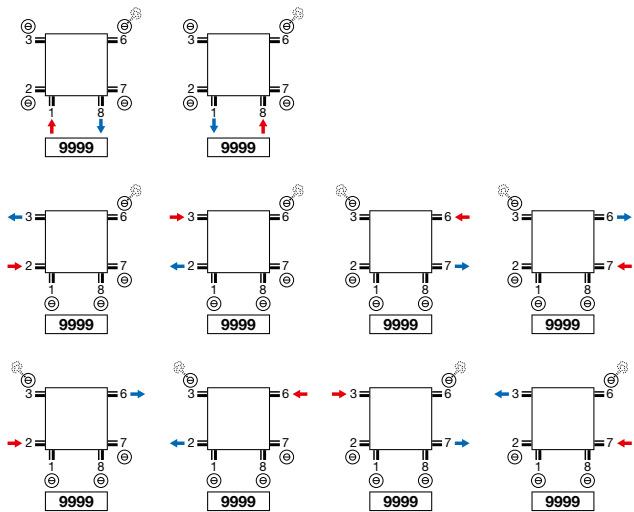

- P2, P3, P4 universal connection 6 x ½ (1, 2, 3, 6, 7, 8)
- P1 universal connection 4 x ½ (1, 3, 6, 8)

ATTENTION: TWO-PIPE SYSTEM:

- not possible for type P1: 23, 67

Attention: connecting the radiator can only be as shown by the connecting icons. For any other connection method, we take no responsibility.

PRIMULA (P1, P2, P3, P4)

Connection 0018 | Top view

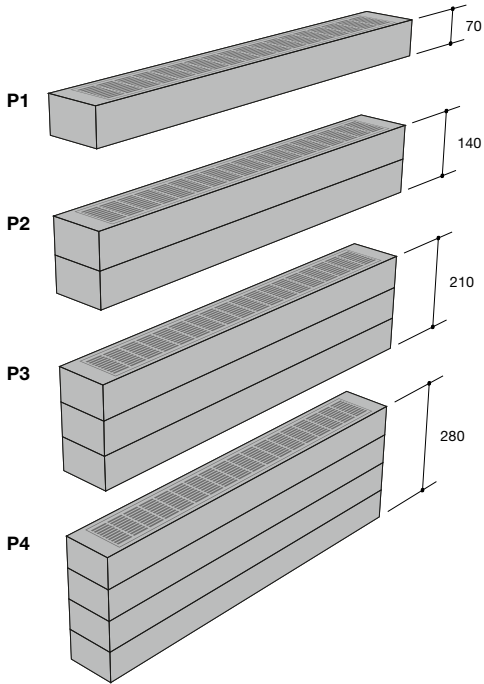
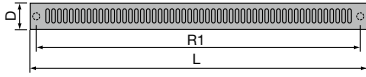

Universal connection 9999 (standard) | Side view

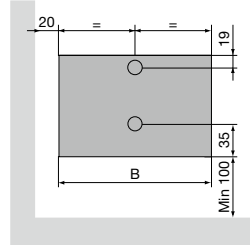

Connection 0023/0067 | Side view

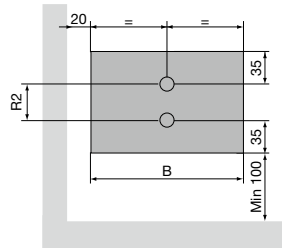

	P1 / P2 / P3 / P4
Centre between the connections at the bottom 18 (R1)	Width (L) - 46
Centre between the lateral connections 23/67 (P2, P3, P4) (R2)	Height (H) - 70
Remote connection to the wall (S1)	20 + depth (D) / 2



VASCO

Column radiators



The VASCO column radiator combines high power with a rapid heat output.

It can be stand-alone or fitted to the wall and delivers top performance in combination with low water temperature systems such as heat pumps and solar water heaters. **A retro radiator in the most durable sense of the word.**

The VASCO column radiator is tailored towards economical and sustainable energy use right down to the smallest details. It features smart connectors and fixing systems and innovative technological solutions.

Column radiators

Vintage

292

VINTAGE (VINTAGE 50)



TYPES

- Vintage 50: distance between the columns 50 mm
- 4 depths (D110, D160, D220, D250)

COLOURS

- Standard colour S600 (fine texture white) (RAL 9016: no extra charge 15%)
- Available in transparent coating (colour code 9990)
- **Attention: do not equip a radiator in transparent coating in damp rooms!**
- Extensive colour chart see p. 10

SPECIAL

- Wall- or floor mounting

BRACKETS

- Standard wall brackets and feet, 1/2" plug, 1/2" air vent
- Brackets in the colour of the radiator (number depends on the length of the radiator)
- The feet and brackets of radiators in transparent coating are lacquered in the colour N507.

TECHNICAL

- KTL priming coat, epoxy-polyester powder coating
- Standard operating pressure: 5 bar
- Maximum operating temperature: 110°C

TECHNICAL DRAWINGS

- See p. 308

CONNECTION

- 4x 1/2" (23, 67, 26, 37)
- Air vent in connection 3 or 6
- Connections: 1/2" (inner thread)
- Connection 27, 72: **supplement €70**

VINTAGE

The past has made a complete comeback

Back to the 'primal radiator'. Very popular because of its imaginative, authentic look. Offered as standard in white, but also available in a transparent coating for an even more pronounced vintage look. Vintage guarantees an extremely high heat output. Ideal for the heating of large, high rooms, also in combination with low-energy technologies. A designer radiator like no other that comes into its own in a retro interior and likes to be placed in front of a window.

RECOMMENDED CONNECTION (2367)

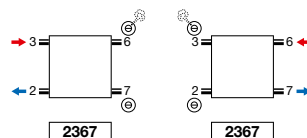

Other connection methods, see p. 307



HOW TO ORDER VINTAGE 50

Delivery time 15 - 30 working days
(transport duration not included)

VINTAGE (VINTAGE 50 / D110)

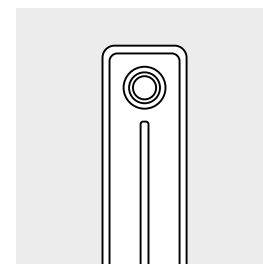
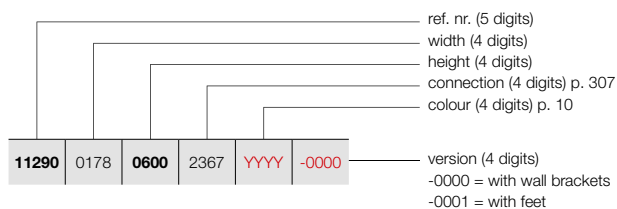

VINTAGE 50 / D110

PRICE GROUP: VPG5 - COLUMN RADIATORS

REFERENCE CODE CUSTOM MADE VINTAGE 50	TECHNICAL DATA										STANDARD COLOUR	OTHER COLOURS
	tubes	width (L mm)	height (H mm)	75/65/20 (Watt) (φ50K)	55/45/20 (Watt) (φ30K)	n-exp.	weight (kg)	water content (l)	electr. resistance (Watt)	price S600 (€)	price colour (€)	
REF. NR. VINTAGE 50/D110 : 11290												
11290 0178 0600 2367 YYY -0000	3	178	600	165	87	1,25	4,17	2,49	-	377	434	
	3	178	1000	252	131	1,28	6,57	3,39	-	400	460	
11290 0228 0600 2367 YYY -0000	4	228	600	220	116	1,25	5,56	3,32	-	393	452	
	4	228	1000	336	175	1,28	8,76	4,52	-	426	490	
11290 0278 0600 2367 YYY -0000	5	278	600	275	145	1,25	6,95	4,15	-	415	477	
	5	278	1000	420	218	1,28	10,95	5,65	-	456	524	
11290 0328 0600 2367 YYY -0000	6	328	600	330	174	1,25	8,34	4,98	-	434	499	
	6	328	1000	504	262	1,28	13,14	6,78	-	480	552	
11290 0378 0600 2367 YYY -0000	7	378	600	385	203	1,25	9,73	5,81	-	451	519	
	7	378	1000	588	306	1,28	15,33	7,91	-	508	584	
11290 0428 0600 2367 YYY -0000	8	428	600	440	232	1,25	11,12	6,64	-	475	546	
	8	428	1000	672	349	1,28	17,52	9,04	-	538	619	
11290 0478 0600 2367 YYY -0000	9	478	600	495	261	1,25	12,51	7,47	-	495	569	
	9	478	1000	756	393	1,28	19,71	10,17	-	565	650	
11290 0528 0600 2367 YYY -0000	10	528	600	550	290	1,25	13,90	8,30	-	515	592	
	10	528	1000	840	437	1,28	21,90	11,30	-	593	682	
11290 0578 0600 2367 YYY -0000	11	578	600	605	319	1,25	15,29	9,13	-	537	618	
	11	578	1000	924	481	1,28	24,09	12,43	-	623	716	
11290 0628 0600 2367 YYY -0000	12	628	600	660	349	1,25	16,68	9,96	-	556	639	
	12	628	1000	1008	524	1,28	26,28	13,56	-	646	743	
11290 0678 0600 2367 YYY -0000	13	678	600	715	378	1,25	18,07	10,79	-	573	659	
	13	678	1000	1092	568	1,28	28,47	14,69	-	675	776	
11290 0728 0600 2367 YYY -0000	14	728	600	770	407	1,25	19,46	11,62	-	595	684	
	14	728	1000	1176	612	1,28	30,66	15,82	-	701	806	
11290 0778 0600 2367 YYY -0000	15	778	600	825	436	1,25	20,85	12,45	-	609	700	
	15	778	1000	1260	655	1,28	32,85	16,95	-	728	837	
11290 0828 0600 2367 YYY -0000	16	828	600	880	465	1,25	22,24	13,28	-	631	726	
	16	828	1000	1344	699	1,28	35,04	18,08	-	753	866	
11290 0878 0600 2367 YYY -0000	17	878	600	935	494	1,25	23,63	14,11	-	646	743	
	17	878	1000	1428	743	1,28	37,23	19,21	-	777	894	
11290 0928 0600 2367 YYY -0000	18	928	600	990	523	1,25	25,02	14,94	-	669	769	
	18	928	1000	1512	786	1,28	39,42	20,34	-	804	925	
11290 0978 0600 2367 YYY -0000	19	978	600	1045	552	1,25	26,41	15,77	-	684	787	
	19	978	1000	1596	830	1,28	41,61	21,47	-	831	956	

In conformity with EN442-1: 2014: radiators and convectors

For heat outputs in other regimes, see p. 320 (correction factors)
EXPORT. Prices in Euro (excl. VAT)



VINTAGE (VINTAGE 50 / D110)

HOW TO ORDER VINTAGE 50
 Delivery time 15 - 30 working days
 (transport duration not included)

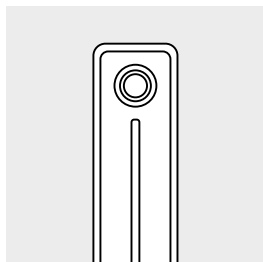

VINTAGE 50 / D110

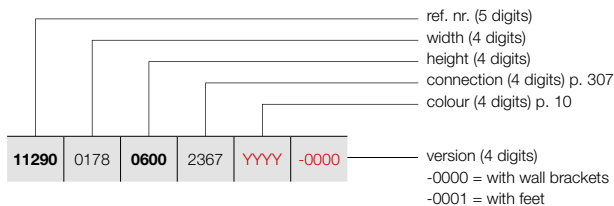

PRICE GROUP: VPG5 - COLUMN RADIATORS

REFERENCE CODE CUSTOM MADE VINTAGE 50						TECHNICAL DATA					STANDARD COLOUR	OTHER COLOURS				
tubes	width (L mm)	height (H mm)	75/65/20 (Watt) (φ50K)	55/45/20 (Watt) (φ30K)	n-exp.	weight (kg)	water content (l)	electr. resistance (Watt)	price S600 (€)	price colour (€)						
REF. NR. VINTAGE 50/D110 : 11290																
11290	1028	600	2367	YYYY	-0000	20	1028	600	1100	581	1,25	27,80	16,60	-	703	808
						20	1028	1000	1680	874	1,28	43,80	22,60	-	855	983
11290	1078	600	2367	YYYY	-0000	21	1078	600	1155	610	1,25	29,19	17,43	-	738	849
						21	1078	1000	1764	917	1,28	45,99	23,73	-	895	1029
11290	1128	600	2367	YYYY	-0000	22	1128	600	1210	639	1,25	30,58	18,26	-	754	867
						22	1128	1000	1848	961	1,28	48,18	24,86	-	921	1059
11290	1178	600	2367	YYYY	-0000	23	1178	600	1265	668	1,25	31,97	19,09	-	773	889
						23	1178	1000	1932	1005	1,28	50,37	25,99	-	946	1088
11290	1228	600	2367	YYYY	-0000	24	1228	600	1320	697	1,25	33,36	19,92	-	788	906
						24	1228	1000	2016	1048	1,28	52,56	27,12	-	973	1119
11290	1278	600	2367	YYYY	-0000	25	1278	600	1375	726	1,25	34,75	20,75	-	808	929
						25	1278	1000	2100	1092	1,28	54,75	28,25	-	997	1147
11290	1328	600	2367	YYYY	-0000	26	1328	600	1430	755	1,25	36,14	21,58	-	842	968
						26	1328	1000	2184	1136	1,28	56,94	29,38	-	1038	1194
11290	1378	600	2367	YYYY	-0000	27	1378	600	1485	784	1,25	37,53	22,41	-	860	989
						27	1378	1000	2268	1179	1,28	59,13	30,51	-	1066	1226
11290	1428	600	2367	YYYY	-0000	28	1428	600	1540	813	1,25	38,92	23,24	-	881	1013
						28	1428	1000	2352	1223	1,28	61,32	31,64	-	1091	1255
11290	1478	600	2367	YYYY	-0000	29	1478	600	1595	842	1,25	40,31	24,07	-	899	1034
						29	1478	1000	2436	1267	1,28	63,51	32,77	-	1118	1286
11290	1528	600	2367	YYYY	-0000	30	1528	600	1650	871	1,25	41,70	24,90	-	917	1055
						30	1528	1000	2520	1310	1,28	65,70	33,90	-	1142	1313
11290	1578	600	2367	YYYY	-0000	31	1578	600	1705	900	1,25	43,09	25,73	-	933	1073
						31	1578	1000	2604	1354	1,28	67,89	35,03	-	1173	1349
11290	1628	600	2367	YYYY	-0000	32	1628	600	1760	929	1,25	44,48	26,56	-	954	1097
						32	1628	1000	2688	1398	1,28	70,08	36,16	-	1201	1381
11290	1678	600	2367	YYYY	-0000	33	1678	600	1815	958	1,25	45,87	27,39	-	1011	1163
						33	1678	1000	2772	1442	1,28	72,27	37,29	-	1267	1457
11290	1728	600	2367	YYYY	-0000	34	1728	600	1870	987	1,25	47,26	28,22	-	1029	1183
						34	1728	1000	2856	1485	1,28	74,46	38,42	-	1294	1488
11290	1778	600	2367	YYYY	-0000	35	1778	600	1925	1017	1,25	48,65	29,05	-	1050	1208
						35	1778	1000	2940	1529	1,28	76,65	39,55	-	1317	1515
11290	1828	600	2367	YYYY	-0000	36	1828	600	1980	1046	1,25	50,04	29,88	-	1072	1233
						36	1828	1000	3024	1573	1,28	78,84	40,68	-	1344	1546
11290	1878	600	2367	YYYY	-0000	37	1878	600	2035	1075	1,25	51,43	30,71	-	1088	1251
						37	1878	1000	3108	1616	1,28	81,03	41,81	-	1369	1574

VASCO

HOW TO ORDER VINTAGE 50

Delivery time 15 - 30 working days
(transport duration not included)

VINTAGE (VINTAGE 50 / D110)

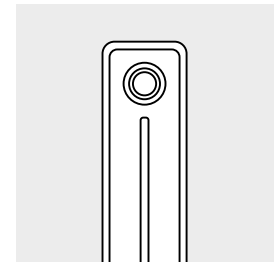
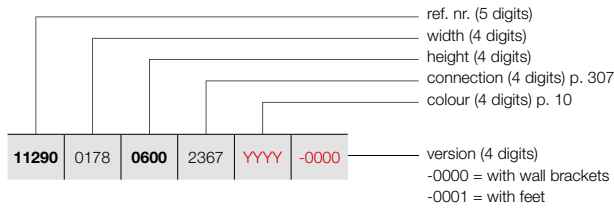

VINTAGE 50 / D110

PRICE GROUP: VPG5 - COLUMN RADIATORS

REFERENCE CODE CUSTOM MADE VINTAGE 50	TECHNICAL DATA									STANDARD COLOUR	OTHER COLOURS
	tubes	width (L mm)	height (H mm)	75/65/20 (Watt) (φ50K)	55/45/20 (Watt) (φ30K)	n-exp.	weight (kg)	water content (l)	electr. resistance (Watt)	price S600 (€)	price colour (€)
REF. NR. VINTAGE 50/D110 : 11290											
11290 1928 0600 2367 YYY -0000	38	1928	600	2090	1104	1,25	52,82	31,54	-	1108	1274
	38	1928	1000	3192	1660	1,28	83,22	42,94	-	1395	1604
11290 1978 0600 2367 YYY -0000	39	1978	600	2145	1133	1,25	54,21	32,37	-	1125	1294
	39	1978	1000	3276	1704	1,28	85,41	44,07	-	1422	1635
11290 2028 0600 2367 YYY -0000	40	2028	600	2200	1162	1,25	55,60	33,20	-	1147	1319
	40	2028	1000	3360	1747	1,28	87,60	45,20	-	1446	1663
11290 2078 0600 2367 YYY -0000	41	2078	600	2255	1191	1,25	56,99	34,03	-	1161	1335
	41	2078	1000	3444	1791	1,28	89,79	46,33	-	1472	1693
11290 2128 0600 2367 YYY -0000	42	2128	600	2310	1220	1,25	58,38	34,86	-	1183	1360
	42	2128	1000	3528	1835	1,28	91,98	47,46	-	1497	1722
11290 2178 0600 2367 YYY -0000	43	2178	600	2365	1249	1,25	59,77	35,69	-	1201	1381
	43	2178	1000	3612	1878	1,28	94,17	48,59	-	1526	1755
11290 2228 0600 2367 YYY -0000	44	2228	600	2420	1278	1,25	61,16	36,52	-	1220	1403
	44	2228	1000	3696	1922	1,28	96,36	49,72	-	1550	1783
11290 2278 0600 2367 YYY -0000	45	2278	600	2475	1307	1,25	62,55	37,35	-	1236	1421
	45	2278	1000	3780	1966	1,28	98,55	50,85	-	1577	1814
11290 2328 0600 2367 YYY -0000	46	2328	600	2530	1336	1,25	63,94	38,18	-	1256	1444
11290 2378 0600 2367 YYY -0000	47	2378	600	2585	1365	1,25	65,33	39,01	-	1272	1463
11290 2428 0600 2367 YYY -0000	48	2428	600	2640	1394	1,25	66,72	39,84	-	1294	1488
11290 2478 0600 2367 YYY -0000	49	2478	600	2695	1423	1,25	68,11	40,67	-	1311	1508
11290 2528 0600 2367 YYY -0000	50	2528	600	2750	1452	1,25	69,50	41,50	-	1329	1528
11290 2578 0600 2367 YYY -0000	51	2578	600	2805	1481	1,25	70,89	42,33	-	1365	1570
11290 2628 0600 2367 YYY -0000	52	2628	600	2860	1510	1,25	72,28	43,16	-	1381	1588
11290 2678 0600 2367 YYY -0000	53	2678	600	2915	1539	1,25	73,67	43,99	-	1399	1609
11290 2728 0600 2367 YYY -0000	54	2728	600	2970	1568	1,25	75,06	44,82	-	1419	1632
11290 2778 0600 2367 YYY -0000	55	2778	600	3025	1597	1,25	76,45	45,65	-	1437	1653
11290 2828 0600 2367 YYY -0000	56	2828	600	3080	1626	1,25	77,84	46,48	-	1455	1673
11290 2878 0600 2367 YYY -0000	57	2878	600	3135	1655	1,25	79,23	47,31	-	1472	1693
11290 2928 0600 2367 YYY -0000	58	2928	600	3190	1685	1,25	80,62	48,14	-	1491	1715
11290 2978 0600 2367 YYY -0000	59	2978	600	3245	1714	1,25	82,01	48,97	-	1510	1737
11290 3028 0600 2367 YYY -0000	60	3028	600	3300	1743	1,25	83,40	49,80	-	1528	1757

VINTAGE (VINTAGE 50 / D160)

HOW TO ORDER VINTAGE 50
 Delivery time 15 - 30 working days
 (transport duration not included)

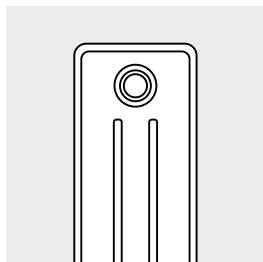

VINTAGE 50 / D160

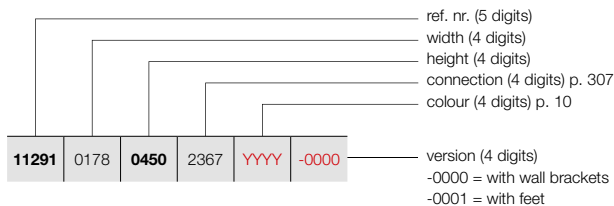

PRICE GROUP: VPG5 - COLUMN RADIATORS

REFERENCE CODE CUSTOM MADE VINTAGE 50						TECHNICAL DATA						STANDARD COLOUR	OTHER COLOURS			
						tubes	width (L mm)	height (H mm)	75/65/20 (Watt) (φ50K)	55/45/20 (Watt) (φ30K)	n-exp.	weight (kg)	water content (l)	electr. resistance (Watt)	price S600 (€)	price colour (€)
REF. NR. VINTAGE 50/D160 : 11291																
11291	0178	0450	2367	YYYY	-0000	3	178	450	174	92	1,24	4,47	2,82	-	380	437
		0600				3	178	600	219	115	1,26	6,00	3,42	-	393	452
		1000				3	178	1000	333	172	1,29	9,63	4,89	-	429	493
11291	0228	0450	2367	YYYY	-0000	4	228	450	232	123	1,24	5,96	3,76	-	399	459
		0600				4	228	600	292	153	1,26	8,00	4,56	-	417	480
		1000				4	228	1000	444	230	1,29	12,84	6,52	-	460	529
11291	0278	0450	2367	YYYY	-0000	5	278	450	290	154	1,24	7,45	4,70	-	419	482
		0600				5	278	600	365	192	1,26	10,00	5,70	-	440	506
		1000				5	278	1000	555	287	1,29	16,05	8,15	-	495	569
11291	0328	0450	2367	YYYY	-0000	6	328	450	348	185	1,24	8,94	5,64	-	436	501
		0600				6	328	600	438	230	1,26	12,00	6,84	-	463	532
		1000				6	328	1000	666	345	1,29	19,26	9,78	-	528	607
11291	0378	0450	2367	YYYY	-0000	7	378	450	406	215	1,24	10,43	6,58	-	455	523
		0600				7	378	600	511	268	1,26	14,00	7,98	-	485	558
		1000				7	378	1000	777	402	1,29	22,47	11,41	-	561	645
11291	0428	0450	2367	YYYY	-0000	8	428	450	464	246	1,24	11,92	7,52	-	478	550
		0600				8	428	600	584	307	1,26	16,00	9,12	-	516	593
		1000				8	428	1000	888	459	1,29	25,68	13,04	-	598	688
11291	0478	0450	2367	YYYY	-0000	9	478	450	522	277	1,24	13,41	8,46	-	496	570
		0600				9	478	600	657	345	1,26	18,00	10,26	-	537	618
		1000				9	478	1000	999	517	1,29	28,89	14,67	-	632	727
11291	0528	0450	2367	YYYY	-0000	10	528	450	580	308	1,24	14,90	9,40	-	515	592
		0600				10	528	600	730	384	1,26	20,00	11,40	-	561	645
		1000				10	528	1000	1110	574	1,29	32,10	16,30	-	665	765
11291	0578	0450	2367	YYYY	-0000	11	578	450	638	339	1,24	16,39	10,34	-	538	619
		0600				11	578	600	803	422	1,26	22,00	12,54	-	590	679
		1000				11	578	1000	1221	632	1,29	35,31	17,93	-	703	808
11291	0628	0450	2367	YYYY	-0000	12	628	450	696	369	1,24	17,88	11,28	-	556	639
		0600				12	628	600	876	460	1,26	24,00	13,68	-	609	700
		1000				12	628	1000	1332	689	1,29	38,52	19,56	-	738	849
11291	0678	0450	2367	YYYY	-0000	13	678	450	754	400	1,24	19,37	12,22	-	572	658
		0600				13	678	600	949	499	1,26	26,00	14,82	-	633	728
		1000				13	678	1000	1443	747	1,29	41,73	21,19	-	767	882
11291	0728	0450	2367	YYYY	-0000	14	728	450	812	431	1,24	20,86	13,16	-	594	683
		0600				14	728	600	1022	537	1,26	28,00	15,96	-	657	756
		1000				14	728	1000	1554	804	1,29	44,94	22,82	-	801	921
11291	0778	0450	2367	YYYY	-0000	15	778	450	870	462	1,24	22,35	14,10	-	609	700
		0600				15	778	600	1095	575	1,26	30,00	17,10	-	677	779
		1000				15	778	1000	1665	861	1,29	48,15	24,45	-	833	958

In conformity with EN442-1: 2014: radiators and convectors

For heat outputs in other regimes, see p. 320 (correction factors)
 EXPORT. Prices in Euro (excl. VAT)

HOW TO ORDER VINTAGE 50

Delivery time 15 - 30 working days
(transport duration not included)

VINTAGE (VINTAGE 50 / D160)

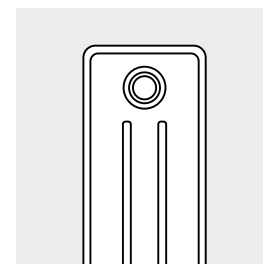
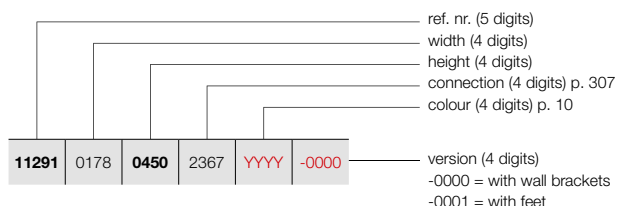

VINTAGE 50 / D160

PRICE GROUP: VPG5 - COLUMN RADIATORS

REFERENCE CODE CUSTOM MADE VINTAGE 50	TECHNICAL DATA									STANDARD COLOUR	OTHER COLOURS
	tubes	width (L mm)	height (H mm)	75/65/20 (Watt) (φ50K)	55/45/20 (Watt) (φ30K)	n-exp.	weight (kg)	water content (l)	electr. resistance (Watt)	price S600 (€)	price colour (€)
REF. NR. VINTAGE 50/D160 : 11291											
11291 0178 0450 2367 YYY -0000	16	828	450	928	493	1,24	23,84	15,04	-	630	725
	16	828	600	1168	614	1,26	32,00	18,24	-	701	806
	16	828	1000	1776	919	1,29	51,36	26,08	-	863	992
11291 0878 0450 2367 YYY -0000	17	878	450	986	523	1,24	25,33	15,98	-	644	741
	17	878	600	1241	652	1,26	34,00	19,38	-	724	833
	17	878	1000	1887	976	1,29	54,57	27,71	-	899	1034
11291 0928 0450 2367 YYY -0000	18	928	450	1044	554	1,24	26,82	16,92	-	665	765
	18	928	600	1314	690	1,26	36,00	20,52	-	745	857
	18	928	1000	1998	1034	1,29	57,78	29,34	-	931	1071
11291 0978 0450 2367 YYY -0000	19	978	450	1102	585	1,24	28,31	17,86	-	681	783
	19	978	600	1387	729	1,26	38,00	21,66	-	767	882
	19	978	1000	2109	1091	1,29	60,99	30,97	-	962	1106
11291 1028 0450 2367 YYY -0000	20	1028	450	1160	616	1,24	29,80	18,80	-	701	806
	20	1028	600	1460	767	1,26	40,00	22,80	-	788	906
	20	1028	1000	2220	1149	1,29	64,20	32,60	-	997	1147
11291 1078 0450 2367 YYY -0000	21	1078	450	1218	646	1,24	31,29	19,74	-	731	841
	21	1078	600	1533	805	1,26	42,00	23,94	-	826	950
	21	1078	1000	2331	1206	1,29	67,41	34,23	-	1043	1199
11291 1128 0450 2367 YYY -0000	22	1128	450	1276	677	1,24	32,78	20,68	-	752	865
	22	1128	600	1606	844	1,26	44,00	25,08	-	849	976
	22	1128	1000	2442	1263	1,29	70,62	35,86	-	1075	1236
11291 1178 0450 2367 YYY -0000	23	1178	450	1334	708	1,24	34,27	21,62	-	767	882
	23	1178	600	1679	882	1,26	46,00	26,22	-	866	996
	23	1178	1000	2553	1321	1,29	73,83	37,49	-	1107	1273
11291 1228 0450 2367 YYY -0000	24	1228	450	1392	739	1,24	35,76	22,56	-	785	903
	24	1228	600	1752	920	1,26	48,00	27,36	-	892	1026
	24	1228	1000	2664	1378	1,29	77,04	39,12	-	1140	1311
11291 1278 0450 2367 YYY -0000	25	1278	450	1450	770	1,24	37,25	23,50	-	802	922
	25	1278	600	1825	959	1,26	50,00	28,50	-	916	1053
	25	1278	1000	2775	1436	1,29	80,25	40,75	-	1171	1347
11291 1328 0450 2367 YYY -0000	26	1328	450	1508	800	1,24	38,74	24,44	-	837	963
	26	1328	600	1898	997	1,26	52,00	29,64	-	956	1099
	26	1328	1000	2886	1493	1,29	83,46	42,38	-	1223	1406
11291 1378 0450 2367 YYY -0000	27	1378	450	1566	831	1,24	40,23	25,38	-	856	984
	27	1378	600	1971	1036	1,26	54,00	30,78	-	976	1122
	27	1378	1000	2997	1551	1,29	86,67	44,01	-	1256	1444
11291 1428 0450 2367 YYY -0000	28	1428	450	1624	862	1,24	41,72	26,32	-	873	1004
	28	1428	600	2044	1074	1,26	56,00	31,92	-	998	1148
	28	1428	1000	3108	1608	1,29	89,88	45,64	-	1288	1481

In conformity with EN442-1: 2014: radiators and convectors

For heat outputs in other regimes, see p. 320 (correction factors)
EXPORT. Prices in Euro (excl. VAT)



VINTAGE (VINTAGE 50 / D160)

HOW TO ORDER VINTAGE 50
 Delivery time 15 - 30 working days
 (transport duration not included)

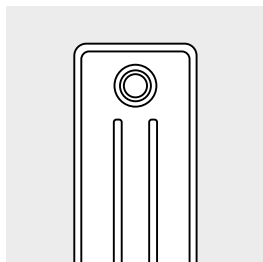

VINTAGE 50 / D160

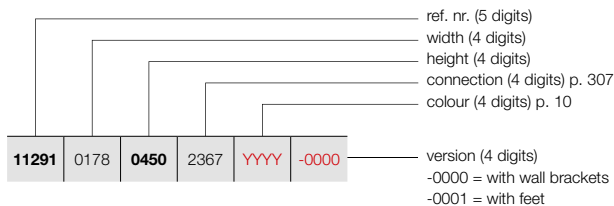

PRICE GROUP: VPG5 - COLUMN RADIATORS

REFERENCE CODE CUSTOM MADE VINTAGE 50						TECHNICAL DATA					STANDARD COLOUR	OTHER COLOURS				
						tubes	width (L mm)	height (H mm)	75/65/20 (Watt) (φ50K)	55/45/20 (Watt) (φ30K)	n-exp.	weight (kg)	water content (l)	electr. resistance (Watt)	price S600 (€)	price colour (€)
REF. NR. VINTAGE 50/D160 : 11291																
11291	1478	0450	2367	YYYY	-0000	29	1478	450	1682	893	1,24	43,21	27,26	-	892	1026
		0600				29	1478	600	2117	1112	1,26	58,00	33,06	-	1020	1173
		1000				29	1478	1000	3219	1665	1,29	93,09	47,27	-	1319	1517
11291	1528	0450	2367	YYYY	-0000	30	1528	450	1740	924	1,24	44,70	28,20	-	908	1044
		0600				30	1528	600	2190	1151	1,26	60,00	34,20	-	1045	1202
		1000				30	1528	1000	3330	1723	1,29	96,30	48,90	-	1351	1554
11291	1578	0450	2367	YYYY	-0000	31	1578	450	1798	954	1,24	46,19	29,14	-	928	1067
		0600				31	1578	600	2263	1189	1,26	62,00	34,34	-	1066	1226
11291	1628	0450	2367	YYYY	-0000	32	1628	450	1856	985	1,24	47,68	30,08	-	946	1088
		0600				32	1628	600	2336	1227	1,26	64,00	36,48	-	1085	1248
11291	1678	0450	2367	YYYY	-0000	33	1678	450	1914	1016	1,24	49,17	31,02	-	1002	1152
		0600				33	1678	600	2409	1266	1,26	66,00	37,62	-	1151	1324
11291	1728	0450	2367	YYYY	-0000	34	1728	450	1972	1047	1,24	50,66	31,96	-	1020	1173
		0600				34	1728	600	2482	1304	1,26	68,00	38,76	-	1173	1349
11291	1778	0450	2367	YYYY	-0000	35	1778	450	2030	1077	1,24	52,15	32,90	-	1038	1194
		0600				35	1778	600	2555	1342	1,26	70,00	39,90	-	1193	1372
11291	1828	0450	2367	YYYY	-0000	36	1828	450	2088	1108	1,24	53,64	33,84	-	1064	1224
		0600				36	1828	600	2628	1381	1,26	72,00	41,04	-	1224	1408
11291	1878	0450	2367	YYYY	-0000	37	1878	450	2146	1139	1,24	55,13	34,78	-	1081	1243
		0600				37	1878	600	2701	1419	1,26	74,00	42,18	-	1244	1431
11291	1928	0450	2367	YYYY	-0000	38	1928	450	2204	1170	1,24	56,62	35,72	-	1099	1264
		0600				38	1928	600	2774	1457	1,26	76,00	43,32	-	1268	1458
11291	1978	0450	2367	YYYY	-0000	39	1978	450	2262	1201	1,24	58,11	36,66	-	1118	1286
		0600				39	1978	600	2847	1496	1,26	78,00	44,46	-	1293	1487
11291	2028	0450	2367	YYYY	-0000	40	2028	450	2320	1231	1,24	59,60	37,60	-	1134	1304
		0600				40	2028	600	2920	1534	1,26	80,00	45,60	-	1313	1510
11291	2078	0450	2367	YYYY	-0000	41	2078	450	2378	1262	1,24	61,09	38,54	-	1153	1326
		0600				41	2078	600	2993	1572	1,26	82,00	46,74	-	1336	1536
11291	2128	0450	2367	YYYY	-0000	42	2128	450	2436	1293	1,24	62,58	39,48	-	1170	1346
		0600				42	2128	600	3066	1611	1,26	84,00	47,88	-	1361	1565
11291	2178	0450	2367	YYYY	-0000	43	2178	450	2494	1324	1,24	64,07	40,42	-	1189	1367
		0600				43	2178	600	3139	1649	1,26	86,00	49,02	-	1380	1587
11291	2228	0450	2367	YYYY	-0000	44	2228	450	2552	1355	1,24	65,56	41,36	-	1206	1387
		0600				44	2228	600	3212	1688	1,26	88,00	50,16	-	1401	1611
11291	2278	0450	2367	YYYY	-0000	45	2278	450	2610	1385	1,24	67,05	42,30	-	1225	1409
		0600				45	2278	600	3285	1726	1,26	90,00	51,30	-	1425	1639

In conformity with EN442-1: 2014: radiators and convectors

For heat outputs in other regimes, see p. 320 (correction factors)
 EXPORT. Prices in Euro (excl. VAT)

HOW TO ORDER VINTAGE 50

Delivery time 15 - 30 working days
(transport duration not included)

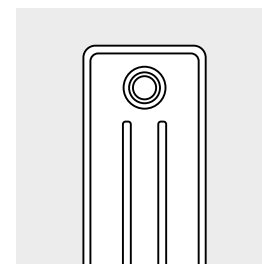
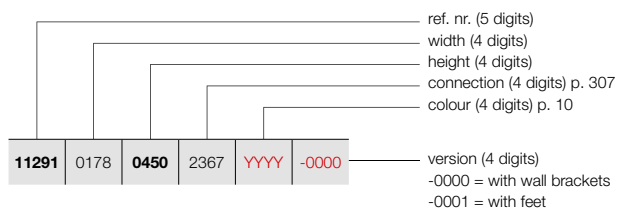

VINTAGE 50 / D160

PRICE GROUP: VPG5 - COLUMN RADIATORS

REFERENCE CODE CUSTOM MADE VINTAGE 50	TECHNICAL DATA									STANDARD COLOUR	OTHER COLOURS
	tubes	width (L mm)	height (H mm)	75/65/20 (Watt) (φ50K)	55/45/20 (Watt) (φ30K)	n-exp.	weight (kg)	water content (l)	electr. resistance (Watt)	price S600 (€)	price colour (€)
REF. NR. VINTAGE 50/D160 : 11291											
11291	2328	0450	2367	YYYY	-0000						
		0600									
	46	2328	450	2668	1416	1,24	68,54	43,24	-	1241	1427
	46	2328	600	3358	1764	1,26	92,00	52,44	-	1446	1663
11291	2378	0450	2367	YYYY	-0000						
		0600									
	47	2378	450	2726	1447	1,24	70,03	44,18	-	1263	1452
	47	2378	600	3431	1803	1,26	94,00	53,58	-	1469	1689
11291	2428	0450	2367	YYYY	-0000						
		0600									
	48	2428	450	2784	1478	1,24	71,52	45,12	-	1279	1471
	48	2428	600	3504	1841	1,26	96,00	54,72	-	1491	1715
11291	2478	0450	2367	YYYY	-0000						
		0600									
	49	2478	450	2842	1508	1,24	73,01	46,06	-	1297	1492
11291	2528	0450	2367	YYYY	-0000						
		0600									
	50	2528	450	2900	1539	1,24	74,50	47,00	-	1314	1511
11291	2578	0450	2367	YYYY	-0000						
		0600									
	51	2578	450	2958	1570	1,24	75,99	47,94	-	1348	1550
11291	2628	0450	2367	YYYY	-0000						
		0600									
	52	2628	450	3016	1601	1,24	77,48	48,88	-	1368	1573
11291	2678	0450	2367	YYYY	-0000						
		0600									
	53	2678	450	3074	1632	1,24	78,97	49,82	-	1385	1593
11291	2728	0450	2367	YYYY	-0000						
		0600									
	54	2728	450	3132	1662	1,24	80,46	50,76	-	1402	1612
11291	2778	0450	2367	YYYY	-0000						
		0600									
	55	2778	450	3190	1693	1,24	81,95	51,70	-	1422	1635
11291	2828	0450	2367	YYYY	-0000						
		0600									
	56	2828	450	3248	1724	1,24	83,44	52,64	-	1440	1656
11291	2878	0450	2367	YYYY	-0000						
		0600									
	57	2878	450	3306	1755	1,24	84,93	53,58	-	1456	1674
11291	2928	0450	2367	YYYY	-0000						
		0600									
	58	2928	450	3364	1786	1,24	86,42	54,52	-	1475	1696
11291	2978	0450	2367	YYYY	-0000						
		0600									
	59	2978	450	3422	1816	1,24	87,91	55,46	-	1493	1717
11291	3028	0450	2367	YYYY	-0000						
		0600									
	60	3028	450	3480	1847	1,24	89,40	56,40	-	1512	1739

In conformity with EN442-1: 2014: radiators and convectors

For heat outputs in other regimes, see p. 320 (correction factors)
EXPORT. Prices in Euro (excl. VAT)

VINTAGE (VINTAGE 50 / D220)

HOW TO ORDER VINTAGE 50
 Delivery time 15 - 30 working days
 (transport duration not included)

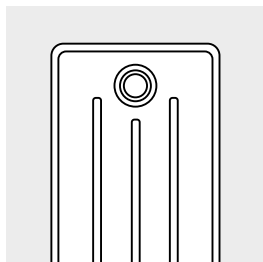

VINTAGE 50 / D220

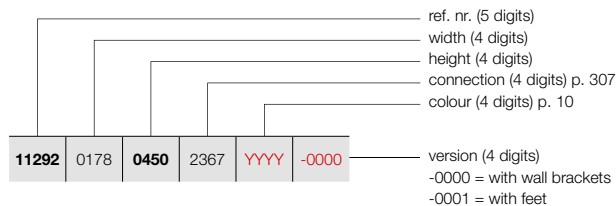

PRICE GROUP: VPG5 - COLUMN RADIATORS

REFERENCE CODE CUSTOM MADE VINTAGE 50						TECHNICAL DATA						STANDARD COLOUR	OTHER COLOURS			
tubes	width (L mm)	height (H mm)	75/65/20 (Watt) (φ50K)	55/45/20 (Watt) (φ30K)	n-exp.	weight (kg)	water content (l)	electr. resistance (Watt)	price S600 (€)	price colour (€)						
REF. NR. VINTAGE 50/D220 : 11292																
11292	0178	0450	2367	YYYY	-0000	3	178	450	225	119	1,25	6,00	3,69	-	392	451
		0600				3	178	600	282	148	1,26	7,86	4,44	-	409	470
		1000				3	178	1000	435	226	1,28	13,68	7,26	-	455	523
11292	0228	0450	2367	YYYY	-0000	4	228	450	300	158	1,25	8,00	4,92	-	413	475
		0600				4	228	600	376	198	1,26	10,48	5,92	-	438	504
		1000				4	228	1000	580	302	1,28	18,24	9,68	-	496	570
11292	0278	0450	2367	YYYY	-0000	5	278	450	375	198	1,25	10,00	6,15	-	437	503
		0600				5	278	600	470	247	1,26	13,10	7,40	-	468	538
		1000				5	278	1000	725	377	1,28	22,80	12,10	-	538	619
11292	0328	0450	2367	YYYY	-0000	6	328	450	450	238	1,25	12,00	7,38	-	460	529
		0600				6	328	600	564	296	1,26	15,72	8,88	-	495	569
		1000				6	328	1000	870	452	1,28	27,36	14,52	-	582	669
11292	0378	0450	2367	YYYY	-0000	7	378	450	525	277	1,25	14,00	8,61	-	480	552
		0600				7	378	600	658	346	1,26	18,34	10,36	-	523	601
		1000				7	378	1000	1015	528	1,28	31,92	16,94	-	623	716
11292	0428	0450	2367	YYYY	-0000	8	428	450	600	317	1,25	16,00	9,84	-	510	587
		0600				8	428	600	752	395	1,26	20,96	11,84	-	566	639
		1000				8	428	1000	1160	603	1,28	36,48	19,36	-	671	772
11292	0478	0450	2367	YYYY	-0000	9	478	450	675	356	1,25	18,00	11,07	-	530	610
		0600				9	478	600	846	444	1,26	23,58	13,32	-	585	673
		1000				9	478	1000	1305	679	1,28	41,04	21,78	-	711	818
11292	0528	0450	2367	YYYY	-0000	10	528	450	750	396	1,25	20,00	12,30	-	552	635
		0600				10	528	600	940	494	1,26	26,20	14,80	-	609	700
		1000				10	528	1000	1450	754	1,28	45,60	24,20	-	755	868
11292	0578	0450	2367	YYYY	-0000	11	578	450	825	436	1,25	22,00	13,53	-	582	669
		0600				11	578	600	1034	543	1,26	28,82	16,28	-	642	738
		1000				11	578	1000	1595	829	1,28	50,16	26,62	-	802	922
11292	0628	0450	2367	YYYY	-0000	12	628	450	900	475	1,25	24,00	14,76	-	602	692
		0600				12	628	600	1128	593	1,26	31,44	17,76	-	674	775
		1000				12	628	1000	1740	905	1,28	54,72	29,04	-	847	974
11292	0678	0450	2367	YYYY	-0000	13	678	450	975	515	1,25	26,00	15,99	-	625	719
		0600				13	678	600	1222	642	1,26	34,06	19,24	-	701	806
		1000				13	678	1000	1885	980	1,28	59,28	31,46	-	887	1020
11292	0728	0450	2367	YYYY	-0000	14	728	450	1050	554	1,25	28,00	17,22	-	642	738
		0600				14	728	600	1316	691	1,26	36,68	20,72	-	729	838
		1000				14	728	1000	2030	1056	1,28	63,84	33,88	-	927	1066
11292	0778	0450	2367	YYYY	-0000	15	778	450	1125	594	1,25	30,00	18,45	-	669	769
		0600				15	778	600	1410	741	1,26	39,30	22,20	-	755	868
		1000				15	778	1000	2175	1131	1,28	68,40	36,30	-	968	1113

In conformity with EN442-1: 2014: radiators and convectors

For heat outputs in other regimes, see p. 320 (correction factors)
 EXPORT. Prices in Euro (excl. VAT)

HOW TO ORDER VINTAGE 50
 Delivery time 15 - 30 working days
 (transport duration not included)

VINTAGE (VINTAGE 50 / D220)

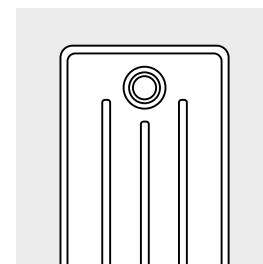
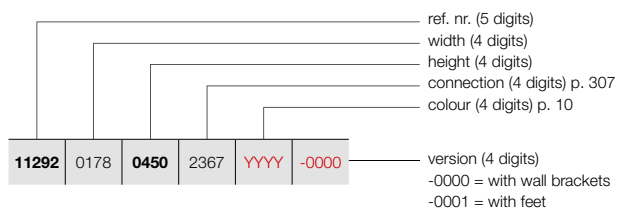

VINTAGE 50 / D220

PRICE GROUP: VPG5 - COLUMN RADIATORS

REFERENCE CODE CUSTOM MADE VINTAGE 50	TECHNICAL DATA									STANDARD COLOUR	OTHER COLOURS
	tubes	width (L mm)	height (H mm)	75/65/20 (Watt) (φ50K)	55/45/20 (Watt) (φ30K)	n-exp.	weight (kg)	water content (l)	electr. resistance (Watt)	price S600 (€)	price colour (€)
REF. NR. VINTAGE 50/D220 : 11292											
11292 0828 0450 2367 YYYY -0000 0600 1000	16	828	450	1200	634	1,25	32,00	19,68	-	687	790
	16	828	600	1504	790	1,26	41,92	23,68	-	783	900
	16	828	1000	2320	1206	1,28	72,96	38,72	-	1011	1163
11292 0878 0450 2367 YYYY -0000 0600 1000	17	878	450	1275	673	1,25	34,00	20,91	-	708	814
	17	878	600	1598	840	1,26	44,54	25,16	-	810	932
	17	878	1000	2465	1282	1,28	77,52	41,14	-	1053	1211
11292 0928 0450 2367 YYYY -0000 0600 1000	18	928	450	1350	713	1,25	36,00	22,14	-	731	841
	18	928	600	1692	889	1,26	47,16	26,64	-	837	963
	18	928	1000	2610	1357	1,28	82,08	43,56	-	1094	1258
11292 0978 0450 2367 YYYY -0000 0600 1000	19	978	450	1425	752	1,25	38,00	23,37	-	754	867
	19	978	600	1786	938	1,26	49,78	28,12	-	862	991
	19	978	1000	2755	1433	1,28	86,64	45,98	-	1136	1306
11292 1028 0450 2367 YYYY -0000 0600 1000	20	1028	450	1500	792	1,25	40,00	24,60	-	774	890
	20	1028	600	1880	988	1,26	52,40	29,60	-	892	1026
	20	1028	1000	2900	1508	1,28	91,20	48,40	-	1178	1355
11292 1078 0450 2367 YYYY -0000 0600 1000	21	1078	450	1575	832	1,25	42,00	25,83	-	808	929
	21	1078	600	1974	1037	1,26	55,02	31,08	-	931	1071
	21	1078	1000	3045	1584	1,28	95,76	50,82	-	1231	1416
11292 1128 0450 2367 YYYY -0000 0600 1000	22	1128	450	1650	871	1,25	44,00	27,06	-	832	957
	22	1128	600	2068	1086	1,26	57,64	32,56	-	960	1104
	22	1128	1000	3190	1659	1,28	100,32	53,24	-	1273	1464
11292 1178 0450 2367 YYYY -0000 0600 1000	23	1178	450	1725	911	1,25	46,00	28,29	-	852	980
	23	1178	600	2162	1136	1,26	60,26	34,04	-	989	1137
	23	1178	1000	3335	1734	1,28	104,88	55,66	-	1315	1512
11292 1228 0450 2367 YYYY -0000 0600 1000	24	1228	450	1800	951	1,25	48,00	29,52	-	873	1004
	24	1228	600	2256	1185	1,26	62,88	35,52	-	1014	1166
	24	1228	1000	3480	1810	1,28	109,44	58,08	-	1361	1565
11292 1278 0450 2367 YYYY -0000 0600 1000	25	1278	450	1875	990	1,25	50,00	30,75	-	895	1029
	25	1278	600	2350	1235	1,26	65,50	37,00	-	1043	1199
	25	1278	1000	3625	1885	1,28	114,00	60,50	-	1399	1609
11292 1328 0450 2367 YYYY -0000 0600 1000	26	1328	450	1950	1030	1,25	52,00	31,98	-	932	1072
	26	1328	600	2444	1284	1,26	68,12	38,48	-	1084	1247
	26	1328	1000	3770	1961	1,28	118,56	62,92	-	1458	1677
11292 1378 0450 2367 YYYY -0000 0600 1000	27	1378	450	2025	1069	1,25	54,00	33,21	-	957	1101
	27	1378	600	2538	1333	1,26	70,74	39,96	-	1115	1282
	27	1378	1000	3915	2036	1,28	123,12	65,34	-	1498	1723
11292 1428 0450 2367 YYYY -0000 0600 1000	28	1428	450	2100	1109	1,25	56,00	34,44	-	976	1122
	28	1428	600	2632	1383	1,26	73,36	41,44	-	1140	1311
	28	1428	1000	4060	2111	1,28	127,68	67,76	-	1541	1772

In conformity with EN442-1: 2014: radiators and convectors

For heat outputs in other regimes, see p. 320 (correction factors)
 EXPORT. Prices in Euro (excl. VAT)

VASCO

VINTAGE (VINTAGE 50 / D220)

HOW TO ORDER VINTAGE 50
 Delivery time 15 - 30 working days
 (transport duration not included)

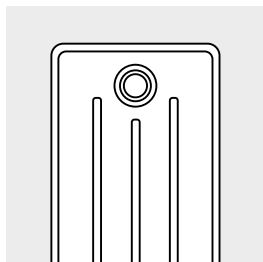

VINTAGE 50 / D220

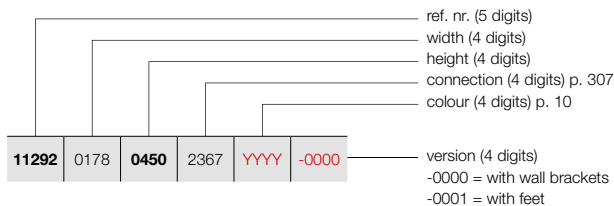

PRICE GROUP: VPG5 - COLUMN RADIATORS

REFERENCE CODE CUSTOM MADE VINTAGE 50						TECHNICAL DATA					STANDARD COLOUR	OTHER COLOURS				
						tubes	width (L mm)	height (H mm)	75/65/20 (Watt) (φ50K)	55/45/20 (Watt) (φ30K)	n-exp.	weight (kg)	water content (l)	electr. resistance (Watt)	price S600 (€)	price colour (€)
REF. NR. VINTAGE 50/D220 : 11292																
11292	1478	0450	2367	YYYY	-0000	29	1478	450	2175	1149	1,25	58,00	35,67	-	998	1148
		0600				29	1478	600	2726	1432	1,26	75,98	42,92	-	1167	1342
		1000				29	1478	1000	4205	2187	1,28	132,24	70,18	-	1584	1822
11292	1528	0450	2367	YYYY	-0000	30	1528	450	2250	1188	1,25	60,00	36,90	-	1018	1171
		0600				30	1528	600	2820	1482	1,26	78,60	44,40	-	1193	1372
		1000				30	1528	1000	4350	2262	1,28	136,80	72,60	-	1623	1866
11292	1578	0450	2367	YYYY	-0000	31	1578	450	2325	1228	1,25	62,00	38,13	-	1043	1199
		0600				31	1578	600	2914	1531	1,26	81,22	45,88	-	1224	1408
11292	1628	0450	2367	YYYY	-0000	32	1628	450	2400	1267	1,25	64,00	39,36	-	1064	1224
		0600				32	1628	600	3008	1580	1,26	83,84	47,36	-	1251	1439
11292	1678	0450	2367	YYYY	-0000	33	1678	450	2475	1307	1,25	66,00	40,59	-	1124	1293
		0600				33	1678	600	3102	1630	1,26	86,46	48,84	-	1317	1515
11292	1728	0450	2367	YYYY	-0000	34	1728	450	2550	1347	1,25	68,00	41,82	-	1149	1321
		0600				34	1728	600	3196	1679	1,26	89,08	50,32	-	1345	1547
11292	1778	0450	2367	YYYY	-0000	35	1778	450	2625	1386	1,25	70,00	43,05	-	1167	1342
		0600				35	1778	600	3290	1728	1,26	91,70	51,80	-	1372	1578
11292	1828	0450	2367	YYYY	-0000	36	1828	450	2700	1426	1,25	72,00	44,28	-	1193	1372
		0600				36	1828	600	3384	1778	1,26	94,32	53,28	-	1404	1615
11292	1878	0450	2367	YYYY	-0000	37	1878	450	2775	1465	1,25	74,00	45,51	-	1219	1402
		0600				37	1878	600	3478	1827	1,26	96,36	54,76	-	1434	1649
11292	1928	0450	2367	YYYY	-0000	38	1928	450	2850	1505	1,25	76,00	46,74	-	1238	1424
		0600				38	1928	600	3572	1877	1,26	99,56	56,24	-	1459	1678
11292	1978	0450	2367	YYYY	-0000	39	1978	450	2925	1545	1,25	78,00	47,97	-	1263	1452
		0600				39	1978	600	3666	1926	1,26	102,18	57,72	-	1489	1712
11292	2028	0450	2367	YYYY	-0000	40	2028	450	3000	1584	1,25	80,00	49,20	-	1281	1473
		0600				40	2028	600	3760	1975	1,26	104,80	59,20	-	1517	1745
11292	2078	0450	2367	YYYY	-0000	41	2078	450	3075	1624	1,25	82,00	50,43	-	1302	1497
		0600				41	2078	600	3854	2025	1,26	107,42	60,68	-	1542	1773
11292	2128	0450	2367	YYYY	-0000	42	2128	450	3150	1663	1,25	84,00	51,66	-	1326	1525
		0600				42	2128	600	3948	2074	1,26	110,04	62,16	-	1569	1804
11292	2178	0450	2367	YYYY	-0000	43	2178	450	3225	1703	1,25	86,00	52,89	-	1346	1548
		0600				43	2178	600	4042	2124	1,26	112,66	63,64	-	1597	1837
11292	2228	0450	2367	YYYY	-0000	44	2228	450	3300	1743	1,25	88,00	54,12	-	1369	1574
		0600				44	2228	600	4136	2173	1,26	115,28	65,12	-	1624	1868
11292	2278	0450	2367	YYYY	-0000	45	2278	450	3375	1782	1,25	90,00	55,35	-	1389	1597
		0600				45	2278	600	4230	2222	1,26	117,90	66,60	-	1651	1899

In conformity with EN442-1: 2014: radiators and convectors

For heat outputs in other regimes, see p. 320 (correction factors)
 EXPORT. Prices in Euro (excl. VAT)

HOW TO ORDER VINTAGE 50

Delivery time 15 - 30 working days
(transport duration not included)

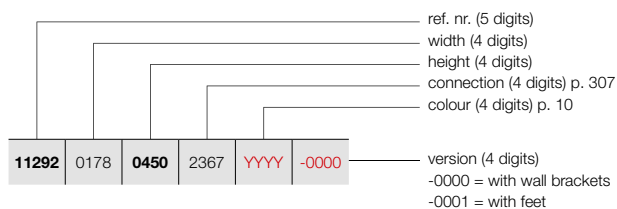

VINTAGE (VINTAGE 50 / D220)

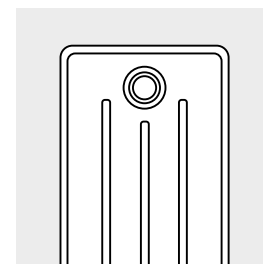

VINTAGE 50 / D220

PRICE GROUP: VPG5 - COLUMN RADIATORS

REFERENCE CODE CUSTOM MADE VINTAGE 50	TECHNICAL DATA									STANDARD COLOUR	OTHER COLOURS
	tubes	width (L mm)	height (H mm)	75/65/20 (Watt) (φ50K)	55/45/20 (Watt) (φ30K)	n-exp.	weight (kg)	water content (l)	electr. resistance (Watt)	price S600 (€)	price colour (€)
REF. NR. VINTAGE 50/D220 : 11292											
11292	2328	0450	2367	YYYY	-0000						
		0600									
	46	2328	450	3450	1822	1,25	93,84	56,58	-	1413	1625
	46	2328	600	4324	2272	1,26	120,52	68,08	-	1682	1934
11292	2378	0450	2367	YYYY	-0000						
		0600									
	47	2378	450	3525	1861	1,25	94,00	57,81	-	1434	1649
	47	2378	600	4418	2321	1,26	123,14	69,56	-	1707	1963
11292	2428	0450	2367	YYYY	-0000						
		0600									
	48	2428	450	3600	1901	1,25	96,00	59,04	-	1455	1673
	48	2428	600	4512	2370	1,26	125,76	71,04	-	1733	1993
11292	2478	0450	2367	YYYY	-0000						
		0600									
	49	2478	450	3675	1941	1,25	99,96	60,27	-	1475	1696
	49	2478	600	4606	2420	1,26	128,38	72,52	-	1760	2024
11292	2528	0450	2367	YYYY	-0000						
		0600									
	50	2528	450	3750	1980	1,25	102,00	61,50	-	1497	1722
	50	2528	600	4700	2469	1,26	131,00	74,00	-	1791	2060
11292	2578	0450	2367	YYYY	-0000						
		0600									
	51	2578	450	3825	2020	1,25	104,04	62,73	-	1536	1766
11292	2628	0450	2367	YYYY	-0000						
		0600									
	52	2628	450	3900	2059	1,25	106,08	63,96	-	1558	1792
11292	2678	0450	2367	YYYY	-0000						
		0600									
	53	2678	450	3975	2099	1,25	108,12	65,19	-	1580	1817
11292	2728	0450	2367	YYYY	-0000						
		0600									
	54	2728	450	4050	2139	1,25	110,16	66,42	-	1599	1839
11292	2778	0450	2367	YYYY	-0000						
		0600									
	55	2778	450	4125	2178	1,25	112,20	67,65	-	1622	1865
11292	2828	0450	2367	YYYY	-0000						
		0600									
	56	2828	450	4200	2218	1,25	114,24	68,88	-	1645	1892
11292	2878	0450	2367	YYYY	-0000						
		0600									
	57	2878	450	4275	2257	1,25	116,28	70,11	-	1665	1915
11292	2928	0450	2367	YYYY	-0000						
		0600									
	58	2928	450	4350	2297	1,25	118,32	71,34	-	1688	1941
11292	2978	0450	2367	YYYY	-0000						
		0600									
	59	2978	450	4425	2337	1,25	120,36	72,57	-	1710	1967
11292	3028	0450	2367	YYYY	-0000						
		0600									
	60	3028	450	4500	2376	1,25	122,40	73,80	-	1731	1991

In conformity with EN442-1: 2014: radiators and convectors

For heat outputs in other regimes, see p. 320 (correction factors)
EXPORT. Prices in Euro (excl. VAT)

VINTAGE (VINTAGE 50 / D250)

HOW TO ORDER VINTAGE 50
 Delivery time 15 - 30 working days
 (transport duration not included)

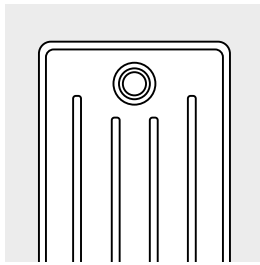

VINTAGE 50 / D250

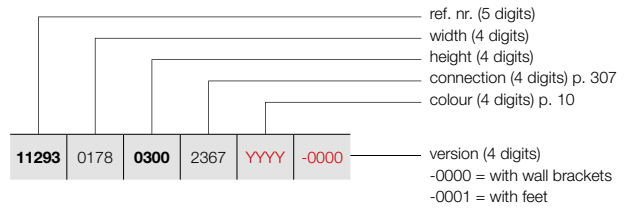

PRICE GROUP: VPG5 - COLUMN RADIATORS

REFERENCE CODE CUSTOM MADE VINTAGE 50	TECHNICAL DATA										STANDARD COLOUR	OTHER COLOURS
	tubes	width (L mm)	height (H mm)	75/65/20 (Watt) (φ50K)	55/45/20 (Watt) (φ30K)	n-exp.	weight (kg)	water content (l)	electr. resistance (Watt)	price S600 (€)	price colour (€)	
REF. NR. VINTAGE 50/D250 : 11293												
11293 0178 0300 2367 YYY -0000	3	178	300	186	98	1,26	4,56	2,97	-	399	459	
11293 0228 0300 2367 YYY -0000	4	228	300	248	130	1,26	6,08	3,96	-	421	484	
11293 0278 0300 2367 YYY -0000	5	278	300	310	163	1,26	7,60	4,95	-	443	509	
11293 0328 0300 2367 YYY -0000	6	328	300	372	195	1,26	9,12	5,94	-	464	534	
11293 0378 0300 2367 YYY -0000	7	378	300	434	228	1,26	10,64	6,93	-	485	558	
11293 0428 0300 2367 YYY -0000	8	428	300	496	261	1,26	12,16	7,92	-	514	591	
11293 0478 0300 2367 YYY -0000	9	478	300	558	293	1,26	13,68	8,91	-	534	614	
11293 0528 0300 2367 YYY -0000	10	528	300	620	326	1,26	15,20	9,90	-	553	636	
11293 0578 0300 2367 YYY -0000	11	578	300	682	358	1,26	16,72	10,89	-	582	669	
11293 0628 0300 2367 YYY -0000	12	628	300	744	391	1,26	18,34	11,88	-	603	693	
11293 0678 0300 2367 YYY -0000	13	678	300	806	423	1,26	19,76	12,87	-	623	716	
11293 0728 0300 2367 YYY -0000	14	728	300	868	456	1,26	21,28	13,86	-	642	738	
11293 0778 0300 2367 YYY -0000	15	778	300	930	489	1,26	22,80	14,85	-	667	767	
11293 0828 0300 2367 YYY -0000	16	828	300	992	521	1,26	24,32	15,84	-	686	789	
11293 0878 0300 2367 YYY -0000	17	878	300	1054	554	1,26	25,84	16,83	-	705	811	
11293 0928 0300 2367 YYY -0000	18	928	300	1116	586	1,26	27,36	17,82	-	729	838	
11293 0978 0300 2367 YYY -0000	19	978	300	1178	619	1,26	28,88	18,81	-	750	863	
11293 1028 0300 2367 YYY -0000	20	1028	300	1240	651	1,26	30,40	19,80	-	768	883	
11293 1078 0300 2367 YYY -0000	21	1078	300	1302	684	1,26	31,92	20,79	-	802	922	
11293 1128 0300 2367 YYY -0000	22	1128	300	1364	717	1,26	33,44	21,78	-	823	946	
11293 1178 0300 2367 YYY -0000	23	1178	300	1426	749	1,26	34,96	22,77	-	848	975	
11293 1228 0300 2367 YYY -0000	24	1228	300	1488	782	1,26	36,68	23,76	-	863	992	
11293 1278 0300 2367 YYY -0000	25	1278	300	1550	814	1,26	38,00	24,75	-	888	1021	
11293 1328 0300 2367 YYY -0000	26	1328	300	1612	847	1,26	39,52	25,74	-	928	1067	
11293 1378 0300 2367 YYY -0000	27	1378	300	1674	879	1,26	41,04	26,73	-	951	1094	
11293 1428 0300 2367 YYY -0000	28	1428	300	1736	912	1,26	42,56	27,72	-	969	1114	
11293 1478 0300 2367 YYY -0000	29	1478	300	1798	945	1,26	44,08	28,71	-	993	1142	

VASCO

HOW TO ORDER VINTAGE 50

Delivery time 15 - 30 working days
(transport duration not included)

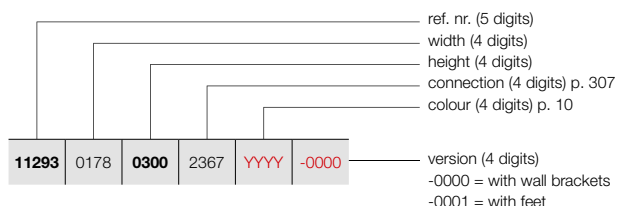

VINTAGE (VINTAGE 50 / D250)

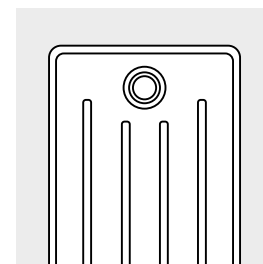

VINTAGE 50 / D250

PRICE GROUP: VPG5 - COLUMN RADIATORS

REFERENCE CODE CUSTOM MADE VINTAGE 50	TECHNICAL DATA										STANDARD COLOUR	OTHER COLOURS
	tubes	width (L mm)	height (H mm)	75/65/20 (Watt) (φ50K)	55/45/20 (Watt) (φ30K)	n-exp.	weight (kg)	water content (l)	electr. resistance (Watt)	price S600 (€)	price colour (€)	
REF. NR. VINTAGE 50/D250 : 11293												
11293 1528 0300 2367 YYYY -0000	30	1528	300	1860	977	1,26	45,60	29,70	-	1011	1163	
11293 1578 0300 2367 YYYY -0000	31	1578	300	1922	1010	1,26	47,12	30,69	-	1032	1187	
11293 1628 0300 2367 YYYY -0000	32	1628	300	1984	1042	1,26	48,64	31,68	-	1054	1212	
11293 1678 0300 2367 YYYY -0000	33	1678	300	2046	1075	1,26	50,16	32,67	-	1117	1285	
11293 1728 0300 2367 YYYY -0000	34	1728	300	2108	1107	1,26	51,68	33,66	-	1136	1306	
11293 1778 0300 2367 YYYY -0000	35	1778	300	2170	1140	1,26	53,20	34,65	-	1156	1329	
11293 1828 0300 2367 YYYY -0000	36	1828	300	2232	1173	1,26	55,02	35,64	-	1184	1362	
11293 1878 0300 2367 YYYY -0000	37	1878	300	2294	1205	1,26	56,24	36,63	-	1205	1386	
11293 1928 0300 2367 YYYY -0000	38	1928	300	2356	1238	1,26	57,76	37,62	-	1225	1409	
11293 1978 0300 2367 YYYY -0000	39	1978	300	2418	1270	1,26	59,28	38,61	-	1244	1431	
11293 2028 0300 2367 YYYY -0000	40	2028	300	2480	1303	1,26	60,80	39,60	-	1267	1457	
11293 2078 0300 2367 YYYY -0000	41	2078	300	2542	1336	1,26	62,32	40,59	-	1288	1481	
11293 2128 0300 2367 YYYY -0000	42	2128	300	2604	1368	1,26	63,84	41,58	-	1309	1505	
11293 2178 0300 2367 YYYY -0000	43	2178	300	2666	1401	1,26	65,36	42,57	-	1329	1528	
11293 2228 0300 2367 YYYY -0000	44	2228	300	2728	1433	1,26	66,88	43,56	-	1348	1550	
11293 2278 0300 2367 YYYY -0000	45	2278	300	2790	1466	1,26	68,40	44,55	-	1371	1577	
11293 2328 0300 2367 YYYY -0000	46	2328	300	2852	1498	1,26	69,92	45,54	-	1390	1599	
11293 2378 0300 2367 YYYY -0000	47	2378	300	2914	1531	1,26	71,44	46,53	-	1413	1625	
11293 2428 0300 2367 YYYY -0000	48	2428	300	2976	1564	1,26	73,36	47,52	-	1434	1649	
11293 2478 0300 2367 YYYY -0000	49	2478	300	3038	1596	1,26	74,48	48,51	-	1454	1672	
11293 2528 0300 2367 YYYY -0000	50	2528	300	3100	1629	1,26	76,00	49,50	-	1475	1696	
11293 2578 0300 2367 YYYY -0000	51	2578	300	3162	1661	1,26	77,52	50,49	-	1518	1746	
11293 2628 0300 2367 YYYY -0000	52	2628	300	3224	1694	1,26	79,04	51,48	-	1537	1768	
11293 2678 0300 2367 YYYY -0000	53	2678	300	3286	1726	1,26	80,56	52,47	-	1560	1794	
11293 2728 0300 2367 YYYY -0000	54	2728	300	3348	1759	1,26	82,08	53,46	-	1580	1817	
11293 2778 0300 2367 YYYY -0000	55	2778	300	3410	1792	1,26	83,60	54,45	-	1599	1839	
11293 2828 0300 2367 YYYY -0000	56	2828	300	3472	1824	1,26	85,12	55,44	-	1620	1863	

VINTAGE (VINTAGE 50 / D250)

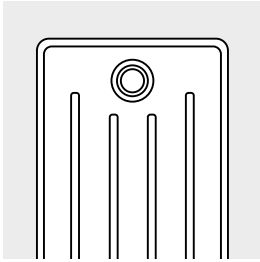

VINTAGE 50 / D250

HOW TO ORDER VINTAGE 50

Delivery time 15 - 30 working days
(transport duration not included)

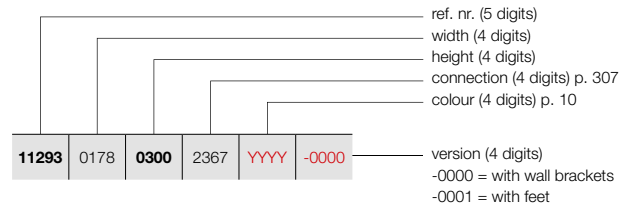

PRICE GROUP: VPG5 - COLUMN RADIATORS

REFERENCE CODE CUSTOM MADE VINTAGE 50	TECHNICAL DATA									STANDARD COLOUR	OTHER COLOURS
	tubes	width (L mm)	height (H mm)	75/65/20 (Watt) (φ50K)	55/45/20 (Watt) (φ30K)	n-exp.	weight (kg)	water content (l)	electr. resistance (Watt)	price S600 (€)	price colour (€)
REF. NR. VINTAGE 50/D250 : 11293											
11293 2878 0300 2367 YYYY -0000	57	2878	300	3534	1857	1,26	86,64	56,43	-	1645	1892
11293 2928 0300 2367 YYYY -0000	58	2928	300	3596	1889	1,26	88,16	57,42	-	1662	1911
11293 2978 0300 2367 YYYY -0000	59	2978	300	3658	1922	1,26	89,68	58,41	-	1686	1939
11293 3028 0300 2367 YYYY -0000	60	3028	300	3720	1954	1,26	91,70	59,40	-	1705	1961

In conformity with EN442-1: 2014: radiators and convectors

For heat outputs in other regimes, see p. 320 (correction factors)
EXPORT. Prices in Euro (excl. VAT)

PRICE GROUP: VPG10 - ACC.

BRACKETS			COLOUR
		VINTAGE 50	
WALL BRACKETS			in the colour of the radiator*
		VINTAGE 50	
FEET		2 feet for 25 columns 3 feet for 50 columns 4 feet for 60 columns	in the colour of the radiator* in the colour of the radiator* in the colour of the radiator*

* The feet and brackets of radiators in transparent coating are lacquered in the colour N507.

VINTAGE CONNECTIONS

VINTAGE: VINTAGE 50

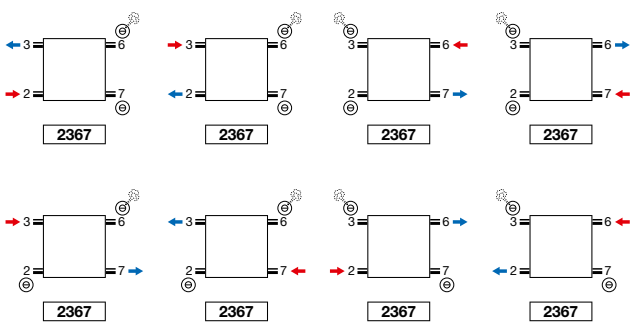

- Air vent in connection 3 or 6

VINTAGE: VINTAGE 50

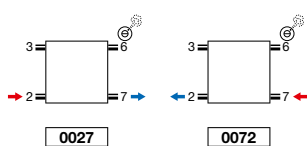

- Air vent in connection 3 or 6
- Connections on special demand: supplement €70

Attention: connecting the radiator can only be as shown by the connecting icons. For any other connection method, we take no responsibility.

VINTAGE (VINTAGE 50)

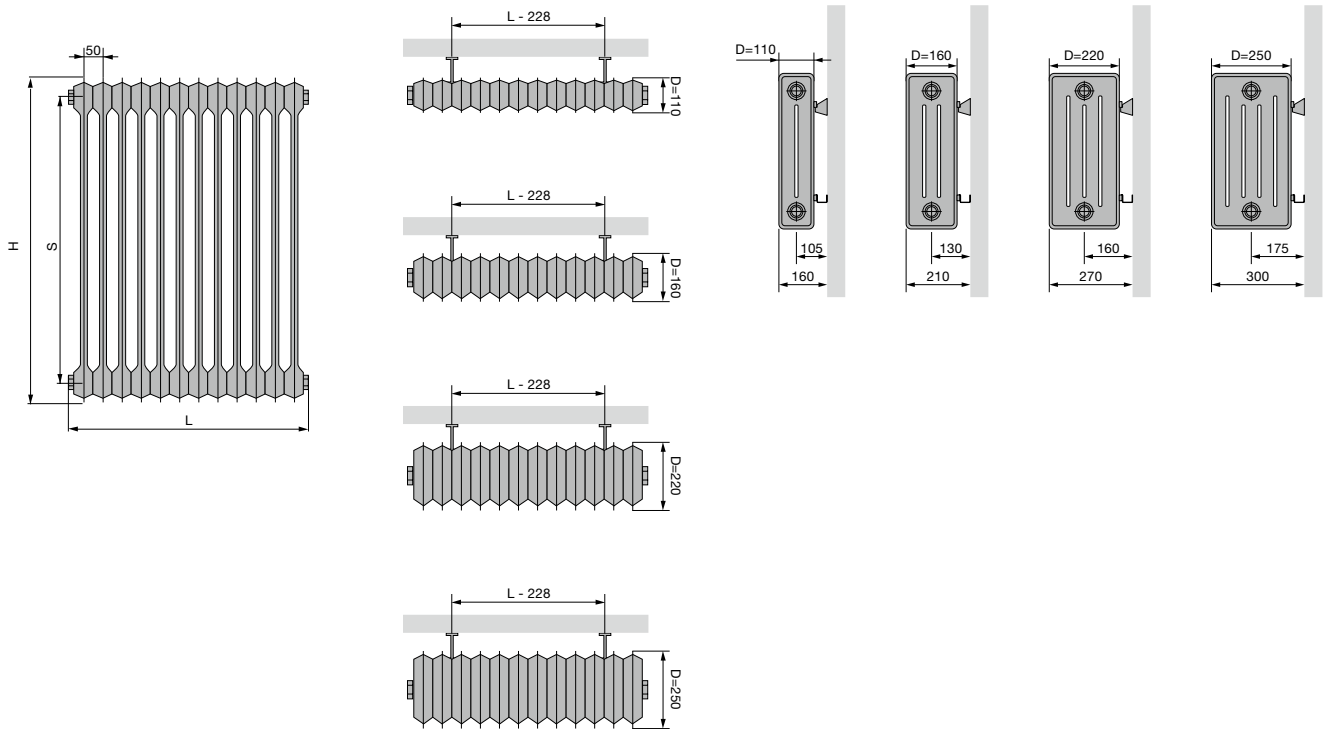

VINTAGE 50

height (H)	300	450	600	1000
Centre between the lateral connections (S)	200	350	500	900

VINTAGE (VINTAGE 50)

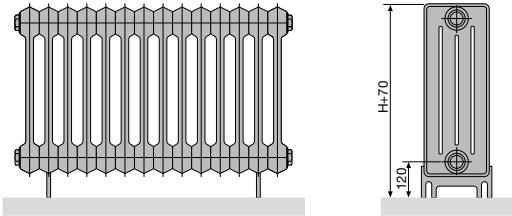

VINTAGE 50 (FLOOR MOUNTING)

Number of columns	2-25	26-50	51-60
Number of feet	2	3	4

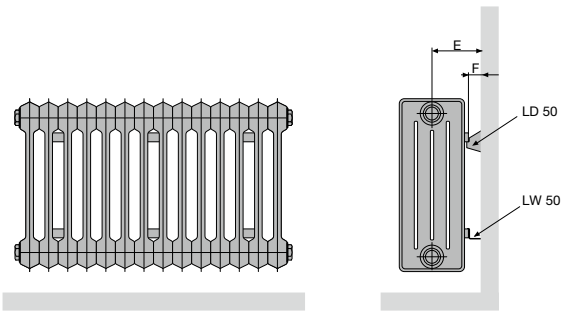

VINTAGE 50 (WALL MOUNTING) LD 50 + LW 50

Depth (D)	110	160	220	250
Distance between wall and connection (E)	105	130	160	175
Distance between wall and backside radiator (F)	50			

VINTAGE 50 (WALL MOUNTING)

Number of columns	3-5	6-25	26-50	51-60
Number of wall brackets set LD 50 + LW 50	1	2	3	4

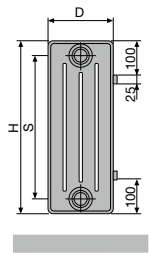

VINTAGE 50

height (H)	300	450	600	1000
Centre between the lateral connections (S)	200	350	500	900

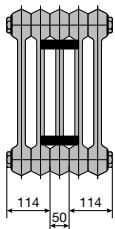

3-5 tubes

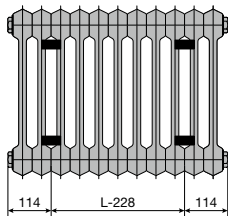

6-25 tubes

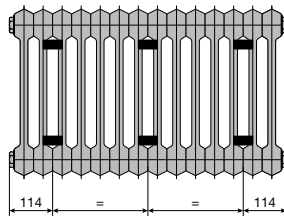

26-50 tubes

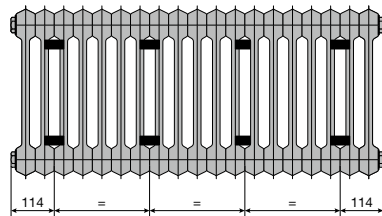

51-60 tubes

Technical

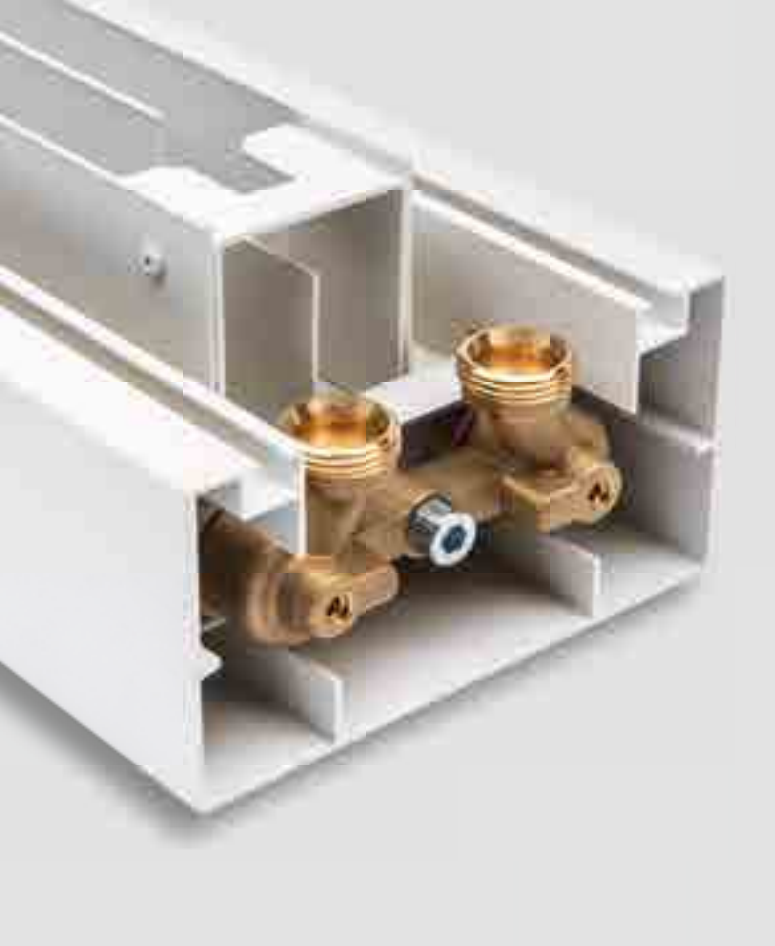

Behind every radiator there is a lot of technological ingenuity which is carried through to the smallest detail. Together with experts from the scientific world VASCO is constantly looking for smart new solutions to be able to deliver better performance. The technique pages provide you with more information about the available connection systems, valves and correction factors. **The correct information means a maximum return.**

Technical

Summary colours	321
Summary accessories	322
Summary valve sets	327
Summary stock radiators	330

TECHNICAL POSSIBLE CONNECTION SYSTEMS

1. POSSIBLE CONNECTION SYSTEMS

1.1. ONE-PIPE SYSTEM 1

A one-pipe system was often used in home construction in the 1970s and 1980s. It is a series circuit of radiators.

The return water from the previous radiator is the supply for the following radiator. To ensure that the water temperature is high enough in the following radiator, you need to use a valve with a bypass.

The bypass mixes the radiator's return water with hotter supply water, so that the temperature of the water serving as supply for the following radiator will be higher. A maximum of 50% of the hot supply water can be mixed. We offer the mm valve set for a one-pipe system. This has an adjustable bypass. 2

Note: The output of radiators is always indicated at 75/65/20°C. As the supply temperature for the following radiators is lower (than 75°C), a correction factor is employed to define the correct output of the radiator.

You can find this factor in the table of correction factors on p. 320.

The full system, therefore, has to be calculated correctly so that there is compensation for the heat loss.

1.2. TWO-PIPE SYSTEM

There are two different systems:

1. With copper or plastic pipes
2. With steel pipes

The valves VASCO sells are suitable for two-pipe systems.

1.2.1. System with copper or plastic pipes 3

This is the system most commonly used in contemporary home construction. You start with a collector, where every radiator has a separate supply and return pipe.

1.2.2. System with steel pipes 4

This system was commonly used in the 1980s.

In this system, two steel pipes are placed around the exterior walls of the house.

One pipe is used for the supply water and the other for the return water. Each radiator is connected to these pipes separately.

1 One-pipe system

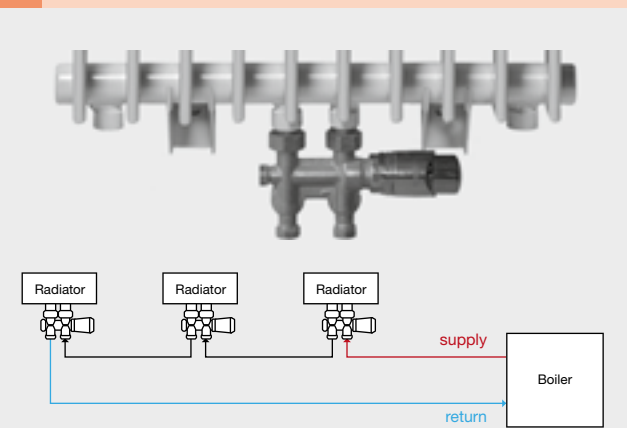

2 mm valve set

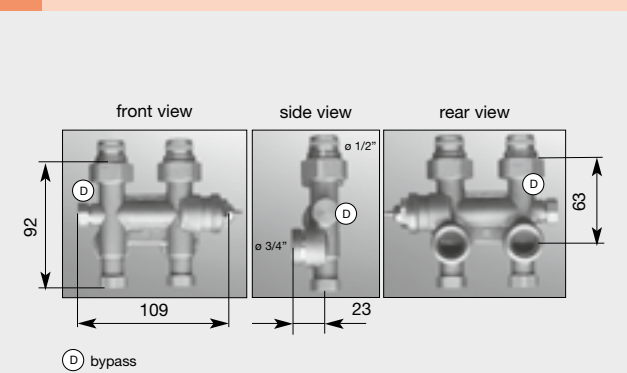

3 System with copper or plastic pipes

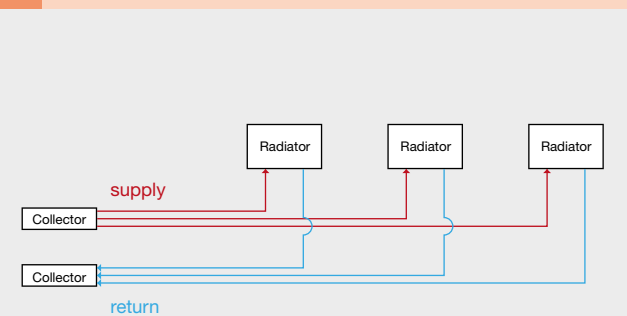

4 System with steel pipes

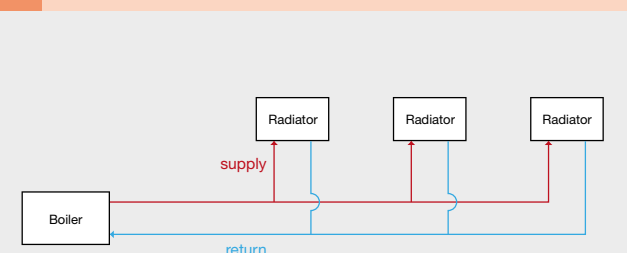

1.3. INTEGRATED VALVE

An integrated valve is available for the following radiators:

integrated valve	thermostatic head	position	supplement	thermostatic head inclusive
Niva Horizontal (standard)	right	left	0	yes
Niva Soft NS2L1	right	right	€ 157	yes
Viola-A Horizontal	right/left*	left/right*	€ 113	no
FlatLine (standard)	right	left	0	no
Flat-Plint-Line (standard)	right	left	0	no

* for thermostat control right supply must be left, for thermostat control left supply must be right

Please enter the code for "Finish":

thermostatic head (colour)	colour code
white	code 03
chrome	code 04

For Viola-A Horizontal, FlatLine, Flat-Plint-Line and Niva Horizontal no codes should be specified.

- **Viola-A Horizontal:** thermostat control to be ordered separately p. 222
- **FlatLine:** thermostat control to be ordered separately p. 257
- **Niva Horizontal:** white control is delivered with white radiator (S600/9016) - chrome control with other colours

The insert can be pre-adjusted exactly. The radiator with integrated valve is already fitted in the factory.

INTEGRATED VALVE FOR THE VIOLA-A HORIZONTAL 5

(Available as from 4 tubes on)

INTEGRATED VALVE FOR THE NIVA HORIZONTAL 6

The Niva Horizontal is supplied (**no extra charge**) with an integrated valve as standard (always on the right side). The connections are 50 mm apart and have a 3/4" outer thread (Euroconus). The supply should always be connected to the 50-mm connection on the left side. The insert is fitted in connection 6.

Note: If you don't want to connect the radiator via the integrated valve but via another connection, then the insert has to be removed. Then you will be able to change the supply and return. The temperature is then controlled by a valve with thermostatic head, which you need to buy (not in the VASCO range).

INTEGRATED VALVE FOR THE NIVA SOFT

The Niva Soft is supplied with an integrated valve upon request (thermostatic head on the right). The connections are at 50mm distance from each other in the centre at the bottom of the radiator. The supply must always be connected to the right.

INTEGRATED VALVE FOR THE FLATLINE 7

The FlatLine is supplied as standard with an integrated valve (always on the right side). It is possible to use the function of the thermostat, **if the radiator is connected on the universal connection or on the right-sided 50-mm connection**. The supply should always be connected to the 50-mm connection on the left side. The insert is fitted in connection 6.

5 Integrated valve for the Viola-A Horizontal



ref. nr. 1182 301 0000 0099
price €147

6 Integrated valve for the Niva Horizontal

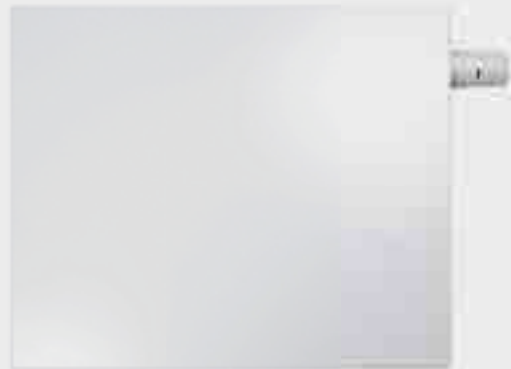

ref. nr. 1182 300 0000 0099
price €147

7 Insert FlatLine



TECHNICAL POSSIBLE CONNECTION SYSTEMS

1.4. FLOW TUBE

When connecting 4-5 (= on the top) you need to place a special flow tube at the top of the collector (in the return connection). In that case, the lowest tube passes less heat on to the others.

Flow tube : The pre-mounted flow tube has to be removed.

flow tube	ref. nr.	
600	1188 001 0000 0000	CB 21
940	1188 005 0000 0000	ZBD 21
1260	1188 009 0000 0000	CB 40
1330	1188 010 0000 0000	ZBD 32
1665	1188 012 0000 0000	CB 50/ ZBD 40

Price for flow tube (= riser pipe) per piece: € 17

2. VALVES

2.1. MM DESIGNER VALVE SET

MM designer valve set square / MM designer valve set straight **8**

- Connection

The connection on the valve set comprises 2 x 1/2" inner thread. The VASCO designer valve set is supplied with an attractive designer thermostatic head as standard. **When using the VASCO designer valve set, the supply needs to be connected to the right of the valve** (see indication on valve). When using a flow tube, it should always be fitted to the supply side. If you connect the supply to the left, the designer valve will not work.

Solution: Fit a reverse header, but the pressure loss over the valve will be greater (see diagram for reverse header p. 315). This is important for the hydraulic balance. **9 12**

- Pre-adjustment

Depending on the required pressure loss, you can set the valve in accordance with the diagram for the designer valve set adjacent. **11 12** The VASCO designer valve set is suitable for two-pipe systems (not one-point systems). The two connections can be shut off entirely so you can wallpaper or service the radiator without having to empty the entire central heating system. To turn off the connection, it is best to first fit the plastic cap, supplied as standard, on the valve on the thermostatic head side and then shut it off. You can close off the return with the socket screw on the underside of the valve. **10**

Square:

colour	ref. nr.	price
white	1182 103 0000 9016	€ 195
black ^M	1182 103 0000 9005	€ 218
chrome	1182 103 0000 0099	€ 218

^M matt black

Straight:

colour	ref. nr.	price
chrome	1182 104 0000 0099	€ 218



PRICE GROUP: VPG10 - ACC.

8 MM designer valve set square / MM designer valve set straight



9 Reverse header



ref. nr. 1182 203 0000 0000
price €86

10 MM designer valve set square / MM designer valve set straight

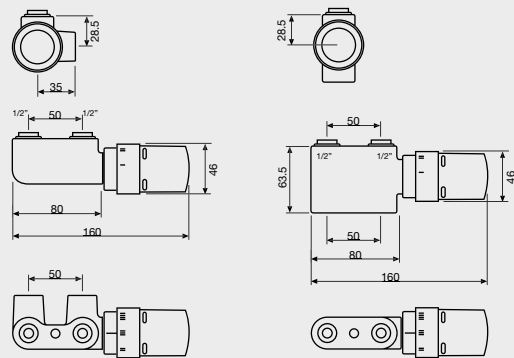

SQUARE DESIGNER VALVE SET

STRAIGHT DESIGNER VALVE SET

11 Pressure loss diagram for designer valve se MM

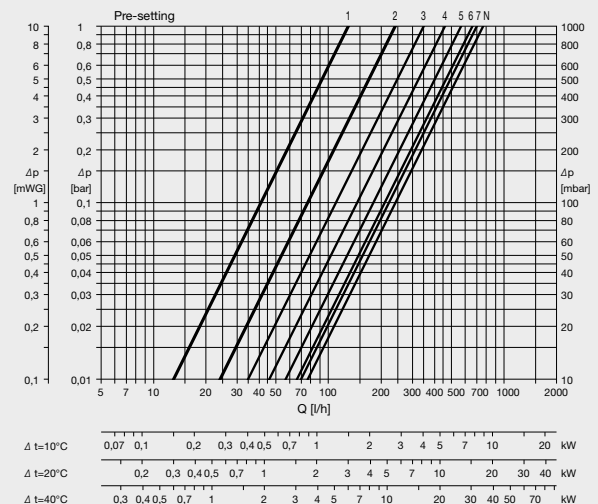

PRICE GROUP: VPG10 - ACC.

Fittings for the MM designer valve set

- For copper pipe 10 mm - colour nickel
ref. nr. 118220800000000 **Price: € 9 / piece;**
- For copper pipe 12 mm - colour nickel
ref. nr. 118220600000000 **Price: € 9 / piece;**
- For copper pipe 14 mm - colour nickel
ref. nr. 118220900000000 **Price: € 9 / piece;**
- For copper pipe 15 mm - colour nickel
ref. nr. 118220700000000 **Price: € 9 / piece;**
- For copper pipe 16 mm - colour nickel
ref. nr. 118221000000000 **Price: € 9 / piece;**
- For PEX/multilayered pipe (with or without aluminium coating) 14 x 2 mm
ref. nr. 118220500000000 **Price: € 11 / piece;**
- For PEX/multilayered pipe (with or without aluminium coating) 16 x 2 mm
ref. nr. 118220400000000 **Price: € 11 / piece**



Copper

PEX/multilayered

Note: The MM designer valve set can only be used for the central monobloc connection (1MM8).

2.2. 1-8 DESIGNER VALVE SET

1-8 designer valve set left			1-8 designer valve set right		
colour	ref. nr.	price	colour	ref. nr.	price
white	1182 101 0000 9016	€ 195	white	1182 102 0000 9016	€ 195
chrome	1182 101 0000 0099	€ 218	chrome	1182 102 0000 0099	€ 218

Remember : The thermostatic head has to be fitted in the return. The 1-8 valve set can be used for radiators with the capacities in the table below:

ΔT_{s-Tr}	temperature regime			output (Watt)
10	75 / 65	70 / 60	55 / 45	1300
15	80 / 65	70 / 55	60 / 45	1950
20	80 / 60	70 / 50	60 / 40	2600

Ts = Temperature supply / Tr = Temperature return

Fittings for the MM designer valve set

- For copper pipe 10 mm - colour nickel
ref. nr. 118220800000000 **Price: € 9 / piece;**
- For copper pipe 12 mm - colour nickel
ref. nr. 118220600000000 **Price: € 9 / piece;**
- For copper pipe 14 mm - colour nickel
ref. nr. 118220900000000 **Price: € 9 / piece;**
- For copper pipe 15 mm - colour nickel
ref. nr. 118220700000000 **Price: € 9 / piece;**
- For copper pipe 16 mm - colour nickel
ref. nr. 118221000000000 **Price: € 9 / piece;**
- For PEX/multilayered pipe (with or without aluminium coating) 14 x 2 mm
ref. nr. 118220500000000 **Price: € 11 / piece;**
- For PEX/multilayered pipe (with or without aluminium coating) 16 x 2 mm
ref. nr. 118220400000000 **Price: € 11 / piece**



Copper

PEX/multilayered

12 Pressure loss diagram for reverse header

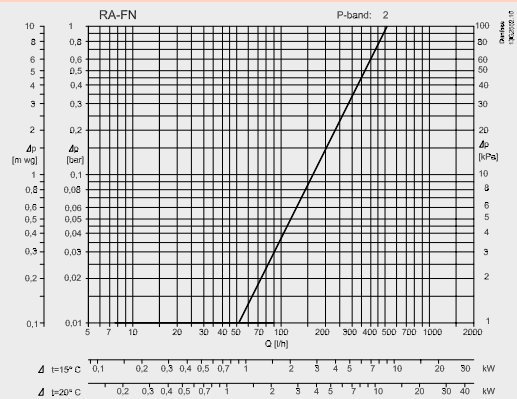

13 1-8 designer valve set left / 1-8 designer valve set right



14 1-8 designer valve set

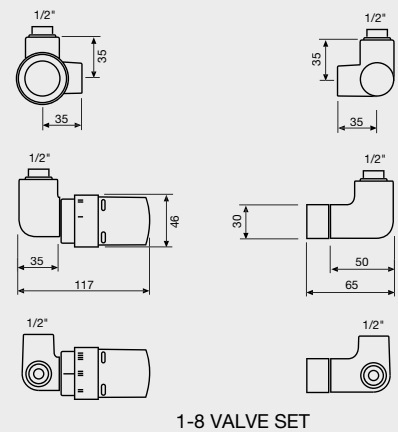

1-8 VALVE SET

15 Pressure loss diagrams for 1-8 designer valve set

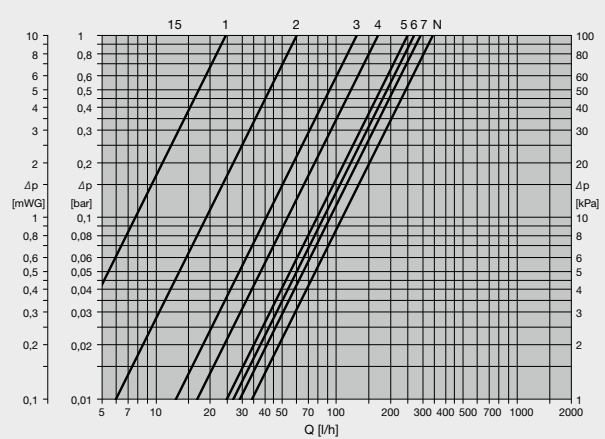

TECHNICAL VALVES

2.3. mm VALVE SET

The valve is always pointed at right angles to the wall.

Can be used for both the new 1MM8 (1188) central monobloc connection and the 1mm8 (1008) central connection. The connection on the valve set comprises 2 x 3/4" outer thread. When you use the VASCO mm valve set you can exchange the supply and return. When using a flow tube, it should always be fitted to the supply side.

- Pre-adjustment

Depending on the required pressure loss, you can adjust the valve in accordance with the diagrams on p. 316. The VASCO mm valve set can be used for one- and two-pipe systems. 

For two-pipe systems: leave the bypass in the closed position. Adjust pressure loss on the hexagonal nut with a scale division from 1 to 6.

For one-pipe systems: set the hexagonal nut to mark 6. Turn the bypass back from closed position (factory setting) a number of rotations in accordance with the diagram on p. 316. 

The supply and return pipes can be shut off entirely so you can wallpaper or service the radiator without having to empty the entire central heating system. A reverse header is not necessary.

When you use the VASCO mm valve set, you can pre-adjust the individual designer radiators according to the heat requirement. This pre-adjustment (kv value) can also be adjusted when the system is working until the heat distribution is optimally set. The kv value is set on the hexagonal nut (using a hex key 13). You can choose from the thermostatic head types below.



white
ref. nr. 11911630102
price € 44



chrome
ref. nr. 11911631102
price € 63

Remember: you need an M30 x 1.5 connection.

The mm valve has a rear connection 2 x 3/4" outer thread with manual adjusting screw and protection cap.

The protection cap with straight underside is available in the following colours:

- RAL 9016
Ref. nr.: 1182 001 0000 9016
Price: €129
- Chrome
Ref. nr.: 1182 001 0000 0099
Price: €139

The protection cap with curved underside is available in the following colours:

- RAL 9016
Ref. nr.: 1182 002 0000 9016
Price: €129

The following products are also available for the mm valve:

Knee coupling for thermostatic head

These can be ordered separately and make sure that the thermostatic head faces forwards and not to the side. This is particularly advisable with narrow radiators to guarantee they are well secured. This knee coupling for the thermostatic head is only available in RAL 9016.

Ref. nr.: 1182 201 0000 0000
Price: € 30

PRICE GROUP: VPG10 - ACC.

16 mm valve set



17 Pressure loss diagram for mm valve set

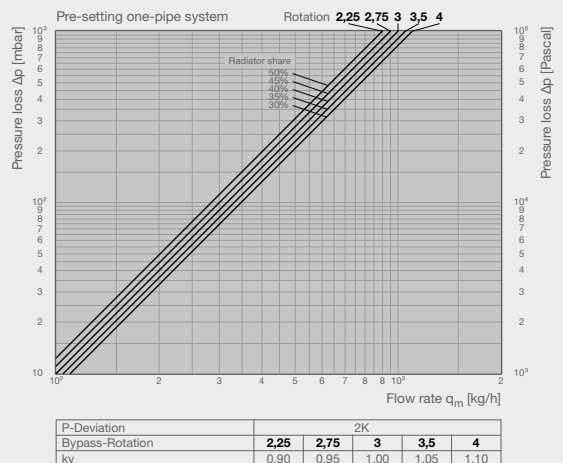
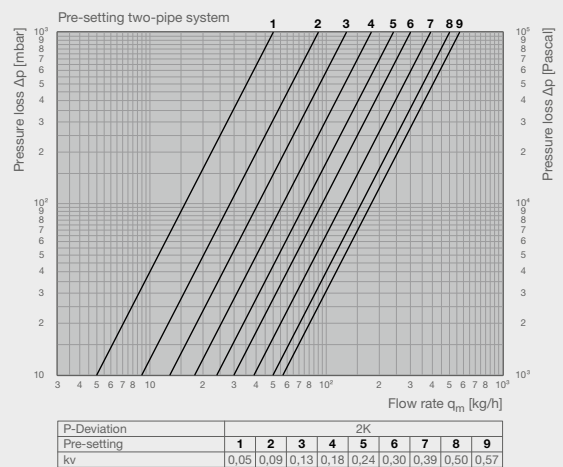

18 Knee coupling for thermostatic head

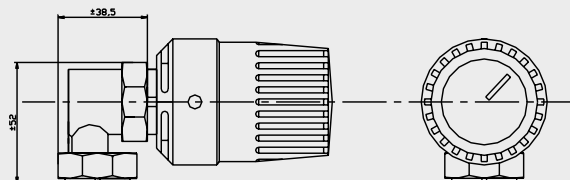

90° curve

This can be used for bathroom radiators.
Use: Floor mounting (vertical), instead of wall mounting (horizontal)

Ref. nr.:1182 202 0000 0000
Price: € 30 / set

Fittings for the mm valve set

- For copper pipe 10 mm - colour nickel
ref. nr. 1182 250 0000 0000 **Price: € 9 / piece;**
- For copper pipe 12 mm - colour nickel
ref. nr. 1182 251 0000 0000 **Price: € 9 / piece;**
- For copper pipe 14 mm - colour nickel
ref. nr. 1182 252 0000 0000 **Price: € 9 / piece;**
- For copper pipe 15 mm - colour nickel
ref. nr. 1182 253 0000 0000 **Price: € 9 / piece;**
- For copper pipe 16 mm - colour nickel
ref. nr. 1182 254 0000 0000 **Price: € 9 / piece;**
- For copper pipe 18 mm - colour nickel
ref. nr. 1182 255 0000 0000 **Price: € 9 / piece;**
- For PEX/multilayered pipe (with or without aluminium coating) 14 x 2 mm
ref. nr. 1182 256 0000 0000 **Price: € 11 / piece;**
- For PEX/multilayered pipe (with or without aluminium coating) 16 x 2 mm
ref. nr. 1182 257 0000 0000 **Price: € 11 / piece**



Copper

PEX/multilayered

2.4. CH/FH VALVE (central heating/floor heating)

Composition and functioning

The connection fitting is composed of a settable thermostatic valve, a thermostat head, a shut-off valve and a return temperature limiter for a two-pipe radiator system in combination with a floor heating circuit.

Room temperature is controlled by the thermostatic valve together with the included thermostat head in combination with a radiator. The floor heating is set independent of the thermostatic valve by limiting the return temperature.

- Operating temperature: 2 °C to 70°C
- Max. operating pressure: 10 bar
- Fluid: Water and suitable water-glycol mixtures in accordance with directive VDI 2035. Not suitable for steam, oily or aggressive fluids.
- Control range return temperature: 10 °C to 40°C

19 90° curve

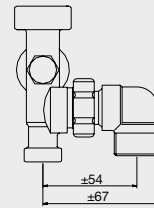

20 Bent radiator connector 50 mm 3/4"

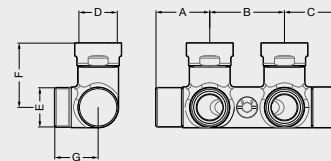

D	A	B	C	E	F	G
3/4" F	36	50	36	3/4" EK	43	29

21 Bent radiator connector valve 50 mm 3/4"

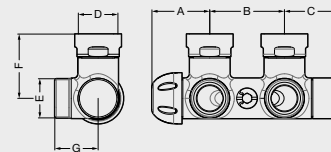

D	A	B	C	E	F	G
3/4" F	39	50	36	3/4" EK	44	30

22 Bent radiator connector 50 mm 1/2"

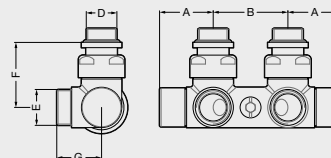

D	A	B	E	F	G
1/2"	36	50	3/4" EK	44	30

23 CH/FH Valve

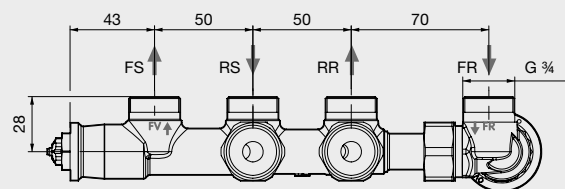
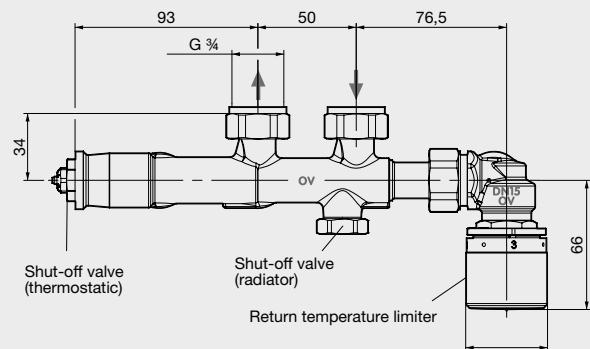

FS = Floor heating supply RR = Radiator return
RS = Radiator supply FR = Floor heating return





TECHNICAL CORRECTION FACTORS

Starting hot water temperature **75/65/20°C** and n exponent: 1.3 (new Euro standard)

Example :

Required output: 1050 Watt
 Room temperature: Ti = 22°C
 Waterregime: 70 / 50° C
 In other words:
 Ts= 70°C (supply) = 70°C
 Tr = 50°C (return) = 50°C

Solution:

The correction factor = 0.70
 Radiator type, for example
 1050: 0.70 = 1,500 Watt
 with regime 75/65/20 = ΔT50
 (see tables for regime 75/65/20°C)

Ts °C	Ti °C	Tr °C													Ti °C
		25	30	35	40	45	50	55	60	65	70	75	80	85	
90	12	0,88	0,95	1,01	1,08	1,15	1,21	1,28	1,35	1,42	1,49	1,56	1,64	1,71	12
	15	0,81	0,87	0,94	1,00	1,07	1,13	1,20	1,27	1,34	1,41	1,48	1,55	1,62	15
	18	0,74	0,80	0,86	0,92	0,99	1,05	1,12	1,19	1,25	1,32	1,39	1,46	1,53	18
	20	0,69	0,75	0,81	0,87	0,94	1,00	1,07	1,13	1,20	1,27	1,34	1,41	1,48	20
	22	0,64	0,70	0,76	0,82	0,88	0,95	1,01	1,08	1,15	1,21	1,28	1,35	1,42	22
24	0,59	0,65	0,71	0,77	0,83	0,90	0,96	1,03	1,09	1,16	1,23	1,29	1,36	24	
85	12	0,82	0,88	0,95	1,01	1,08	1,15	1,21	1,28	1,35	1,42	1,49	1,56	12	
	15	0,75	0,81	0,87	0,94	1,00	1,07	1,13	1,20	1,27	1,34	1,41	1,48	15	
	18	0,68	0,74	0,80	0,86	0,92	0,99	1,05	1,12	1,19	1,25	1,32	1,39	18	
	20	0,63	0,69	0,75	0,81	0,87	0,94	1,00	1,07	1,13	1,20	1,27	1,34	20	
	22	0,58	0,64	0,70	0,76	0,82	0,88	0,95	1,01	1,08	1,15	1,21	1,28	22	
24	0,54	0,59	0,65	0,71	0,77	0,83	0,90	0,96	1,03	1,09	1,16	1,23	24		
80	12	0,76	0,82	0,88	0,95	1,01	1,08	1,15	1,21	1,28	1,35	1,42	12		
	15	0,69	0,75	0,81	0,87	0,94	1,00	1,07	1,13	1,20	1,27	1,34	15		
	18	0,62	0,68	0,74	0,80	0,86	0,92	0,99	1,05	1,12	1,19	1,25	18		
	20	0,57	0,63	0,69	0,75	0,81	0,87	0,94	1,00	1,07	1,13	1,20	20		
	22	0,53	0,58	0,64	0,70	0,76	0,82	0,88	0,95	1,01	1,08	1,15	22		
24	0,48	0,54	0,59	0,65	0,71	0,77	0,83	0,90	0,96	1,03	1,09	24			
75	12	0,70	0,76	0,82	0,88	0,95	1,01	1,08	1,15	1,21	1,28	12			
	15	0,63	0,69	0,75	0,81	0,87	0,94	1,00	1,07	1,13	1,20	15			
	18	0,56	0,62	0,68	0,74	0,80	0,86	0,92	0,99	1,05	1,12	18			
	20	0,51	0,57	0,63	0,69	0,75	0,81	0,87	0,94	1,00	1,07	20			
	22	0,47	0,53	0,58	0,64	0,70	0,76	0,82	0,88	0,95	1,01	22			
24	0,43	0,48	0,54	0,59	0,65	0,71	0,77	0,83	0,90	0,96	24				
70	12	0,64	0,70	0,76	0,82	0,88	0,95	1,01	1,08	1,15	1,21	12			
	15	0,57	0,63	0,69	0,75	0,81	0,87	0,94	1,00	1,07	1,13	15			
	18	0,50	0,56	0,62	0,68	0,74	0,80	0,86	0,92	0,99	1,05	18			
	20	0,46	0,51	0,57	0,63	0,69	0,75	0,81	0,87	0,94	1,00	20			
	22	0,42	0,47	0,53	0,58	0,64	0,70	0,76	0,82	0,88	0,95	22			
24	0,37	0,43	0,48	0,54	0,59	0,65	0,71	0,77	0,83	0,89	24				
65	12	0,58	0,64	0,70	0,76	0,82	0,88	0,95	1,01	1,08	1,15	12			
	15	0,51	0,57	0,63	0,69	0,75	0,81	0,87	0,94	1,00	1,07	15			
	18	0,45	0,50	0,56	0,62	0,68	0,74	0,80	0,86	0,92	0,99	18			
	20	0,41	0,46	0,51	0,57	0,63	0,69	0,75	0,81	0,87	0,94	20			
	22	0,36	0,42	0,47	0,53	0,58	0,64	0,70	0,76	0,82	0,88	22			
24	0,32	0,37	0,43	0,48	0,54	0,59	0,65	0,71	0,77	0,83	24				
60	12	0,53	0,58	0,64	0,70	0,76	0,82	0,88	0,95	1,01	1,08	12			
	15	0,46	0,51	0,57	0,63	0,69	0,75	0,81	0,87	0,94	1,00	15			
	18	0,40	0,45	0,50	0,56	0,62	0,68	0,74	0,80	0,86	0,92	18			
	20	0,35	0,41	0,46	0,51	0,57	0,63	0,69	0,75	0,81	0,87	20			
	22	0,31	0,36	0,42	0,47	0,53	0,58	0,64	0,70	0,76	0,82	22			
24	0,27	0,32	0,37	0,43	0,48	0,54	0,59	0,65	0,71	0,77	24				
55	12	0,47	0,53	0,58	0,64	0,70	0,76	0,82	0,88	0,95	1,01	12			
	15	0,41	0,46	0,51	0,57	0,63	0,69	0,75	0,81	0,87	0,94	15			
	18	0,34	0,40	0,45	0,50	0,56	0,62	0,68	0,74	0,80	0,86	18			
	20	0,30	0,35	0,41	0,46	0,51	0,57	0,63	0,69	0,75	0,81	20			
	22	0,26	0,31	0,36	0,42	0,47	0,53	0,58	0,64	0,70	0,76	22			
24	0,23	0,27	0,32	0,37	0,43	0,48	0,54	0,59	0,65	0,71	24				
50	12	0,42	0,47	0,53	0,58	0,64	0,70	0,76	0,82	0,88	0,95	12			
	15	0,35	0,41	0,46	0,51	0,57	0,63	0,69	0,75	0,81	0,87	15			
	18	0,29	0,34	0,40	0,45	0,50	0,56	0,62	0,68	0,74	0,80	18			
	20	0,26	0,30	0,35	0,41	0,46	0,51	0,57	0,63	0,69	0,75	20			
	22	0,22	0,26	0,31	0,36	0,42	0,47	0,53	0,58	0,64	0,70	22			
24	0,18	0,23	0,27	0,32	0,37	0,43	0,48	0,54	0,59	0,65	24				
45	12	0,36	0,42	0,47	0,53	0,58	0,64	0,70	0,76	0,82	0,88	12			
	15	0,30	0,35	0,41	0,46	0,51	0,57	0,63	0,69	0,75	0,81	15			
	18	0,25	0,29	0,34	0,40	0,45	0,50	0,56	0,62	0,68	0,74	18			
	20	0,21	0,26	0,30	0,35	0,41	0,46	0,51	0,57	0,63	0,69	20			
	22	0,17	0,22	0,26	0,31	0,36	0,42	0,47	0,53	0,58	0,64	22			
24	0,14	0,18	0,23	0,27	0,32	0,37	0,43	0,48	0,54	0,59	24				
40	12	0,31	0,36	0,42	0,47	0,53	0,58	0,64	0,70	0,76	0,82	12			
	15	0,26	0,30	0,35	0,40	0,45	0,50	0,56	0,62	0,68	0,74	15			
	18	0,20	0,25	0,29	0,34	0,40	0,45	0,50	0,56	0,62	0,68	18			
	20	0,16	0,21	0,26	0,31	0,36	0,42	0,47	0,53	0,58	0,64	20			
	22	0,13	0,17	0,22	0,27	0,32	0,37	0,43	0,48	0,54	0,59	22			
24	0,10	0,14	0,18	0,23	0,27	0,32	0,37	0,43	0,48	0,54	24				
35	12	0,26	0,31	0,36	0,42	0,47	0,53	0,58	0,64	0,70	0,76	12			
	15	0,21	0,26	0,31	0,36	0,42	0,47	0,53	0,58	0,64	0,70	15			
	18	0,16	0,20	0,25	0,30	0,35	0,41	0,46	0,51	0,57	0,63	18			
	20	0,12	0,16	0,21	0,26	0,31	0,36	0,42	0,47	0,53	0,58	20			
	22	0,09	0,13	0,17	0,22	0,27	0,32	0,37	0,43	0,48	0,54	22			
24	0,06	0,10	0,14	0,18	0,23	0,27	0,32	0,37	0,43	0,48	24				
30	12	0,22	0,26	0,31	0,36	0,42	0,47	0,53	0,58	0,64	0,70	12			
	15	0,16	0,20	0,25	0,30	0,35	0,41	0,46	0,51	0,57	0,63	15			
	18	0,12	0,16	0,21	0,26	0,31	0,36	0,42	0,47	0,53	0,58	18			
	20	0,08	0,12	0,16	0,21	0,26	0,31	0,36	0,42	0,47	0,53	20			
	22	0,06	0,09	0,13	0,17	0,22	0,27	0,32	0,37	0,43	0,48	22			
24	0,03	0,06	0,09	0,13	0,17	0,22	0,27	0,32	0,37	0,43	24				







TECHNICAL SUMMARY COLOURS

• = Standard colour

		ONI	IRIS-A	AGAVE-A	ASTER-A	BANO	ONI-EL	BEAMS MONO-EL	IRIS-A EL / BL / BL-MIX	AGAVE-A EL / BL	ASTER-A EL / BL / BL-MIX	CARRÉ CB-EL / CARRÉ CB-EL-BL	ZANA BATHROOM EL	NIVA-EL / NIVA-A BL / NIVA MIXED	E-BANO	E-PANEL	BEAMS (MONO)	BRYCE (MONO)	ALU-ZEN	ZAROS	NIVA	NIVA FAN COIL UNIT	CARRÉ	ARCHE	ZANA	VIOLA-A	TULIPA-A	FLATLINE / FLAT-V-LINE / FLAT-PLINT-LINE	PRIMULA	VINTAGE		
NOBLE	SAN 0019 Pergamon	•	•	•	•		•	•	•	•	•	•	•	•			•	•	•	•	•			•	•	•	•	•	•	•	•	
	3012 Pink	•	•	•	•		•	•	•	•	•	•	•	•	•			•	•	•	•	•			•	•	•	•	•	•	•	•
	9898 Silver	•	•	•	•		•	•	•	•	•	•	•	•	•			•	•	•	•	•			•	•	•	•	•	•	•	•
	1035 Pearl Beige	•	•	•	•		•	•	•	•	•	•	•	•	•			•	•	•	•	•			•	•	•	•	•	•	•	•
	9899 Gold	•	•	•	•		•	•	•	•	•	•	•	•	•			•	•	•	•	•			•	•	•	•	•	•	•	•
	9894 Curry	•	•	•	•		•	•	•	•	•	•	•	•	•			•	•	•	•	•			•	•	•	•	•	•	•	•
	9893 Bronze	•	•	•	•		•	•	•	•	•	•	•	•	•			•	•	•	•	•			•	•	•	•	•	•	•	•
WHITE BLACK	RAL 9001 Cream White	•	•	•	•		•	•	•	•	•	•	•	•			•	•	•	•	•			•	•	•	•	•	•	•	•	
	S600 White Fine Texture	•	•	•	•		•	•	•	•	•	•	•	•	•			•	•	•	•	•			•	•	•	•	•	•	•	•
	RAL 9016 Traffic White	•	•	•	•		•	•	•	•	•	•	•	•	•			•	•	•	•	•			•	•	•	•	•	•	•	•
	RAL 9010 Pure White	•	•	•	•		•	•	•	•	•	•	•	•	•			•	•	•	•	•			•	•	•	•	•	•	•	•
	9826 Brown Black	•	•	•	•		•	•	•	•	•	•	•	•	•			•	•	•	•	•			•	•	•	•	•	•	•	•
	9827 Grey Anthracite	•	•	•	•		•	•	•	•	•	•	•	•	•			•	•	•	•	•			•	•	•	•	•	•	•	•
	RAL 9005 Jet Black (structure)	•	•	•	•		•	•	•	•	•	•	•	•	•			•	•	•	•	•			•	•	•	•	•	•	•	•
NATURAL GREY MATT	N500 Mist White	•	•	•	•		•	•	•	•	•	•	•	•			•	•	•	•	•			•	•	•	•	•	•	•	•	
	N502 Sand Light	•	•	•	•		•	•	•	•	•	•	•	•			•	•	•	•	•			•	•	•	•	•	•	•	•	
	N503 Sand	•	•	•	•		•	•	•	•	•	•	•	•			•	•	•	•	•			•	•	•	•	•	•	•	•	
	N504 Platina Grey	•	•	•	•		•	•	•	•	•	•	•	•			•	•	•	•	•			•	•	•	•	•	•	•	•	
	N505 Dust Grey	•	•	•	•		•	•	•	•	•	•	•	•			•	•	•	•	•			•	•	•	•	•	•	•	•	
	N506 Warm Grey	•	•	•	•		•	•	•	•	•	•	•	•			•	•	•	•	•			•	•	•	•	•	•	•	•	
	N507 Brown Grey	•	•	•	•		•	•	•	•	•	•	•	•			•	•	•	•	•			•	•	•	•	•	•	•	•	
PURE GREY MATT	RAL 9003 Signal White	•	•	•	•		•	•	•	•	•	•	•	•			•	•	•	•	•			•	•	•	•	•	•	•	•	
	RAL 7047 Tele Grey 4	•	•	•	•		•	•	•	•	•	•	•	•			•	•	•	•	•			•	•	•	•	•	•	•	•	
	RAL 7040 Window Grey	•	•	•	•		•	•	•	•	•	•	•	•			•	•	•	•	•			•	•	•	•	•	•	•	•	
	RAL 7046 Tele Grey 2	•	•	•	•		•	•	•	•	•	•	•	•			•	•	•	•	•			•	•	•	•	•	•	•	•	
	RAL 7031 Blue Grey	•	•	•	•		•	•	•	•	•	•	•	•			•	•	•	•	•			•	•	•	•	•	•	•	•	
	RAL 7015 Slate Grey	•	•	•	•		•	•	•	•	•	•	•	•			•	•	•	•	•			•	•	•	•	•	•	•	•	
	RAL 7016 Anthracite Grey	•	•	•	•		•	•	•	•	•	•	•	•			•	•	•	•	•			•	•	•	•	•	•	•	•	
METALLIC GREY STRUCTURE	M307 Grey Aluminium	•	•	•	•		•	•	•	•	•	•	•	•			•	•	•	•	•			•	•	•	•	•	•	•		
	M306 White Aluminium	•	•	•	•		•	•	•	•	•	•	•	•			•	•	•	•	•			•	•	•	•	•	•	•		
	M303 Grey White January	•	•	•	•		•	•	•	•	•	•	•	•			•	•	•	•	•			•	•	•	•	•	•	•		
	M302 Aluminium Grey January	•	•	•	•		•	•	•	•	•	•	•	•			•	•	•	•	•			•	•	•	•	•	•	•		
	M301 Anthracite January	•	•	•	•		•	•	•	•	•	•	•	•			•	•	•	•	•			•	•	•	•	•	•	•		
	M300 Black January	•	•	•	•		•	•	•	•	•	•	•	•			•	•	•	•	•			•	•	•	•	•	•	•		
	M304 Brown January	•	•	•	•		•	•	•	•	•	•	•	•			•	•	•	•	•			•	•	•	•	•	•	•		
BLUE GREEN MINERAL	9801 Dark Blue	•	•	•	•		•	•	•	•	•	•	•	•			•	•	•	•	•			•	•	•	•	•	•	•		
	9802 Mid Blue	•	•	•	•		•	•	•	•	•	•	•	•			•	•	•	•	•			•	•	•	•	•	•	•		
	9803 Grey Blue	•	•	•	•		•	•	•	•	•	•	•	•			•	•	•	•	•			•	•	•	•	•	•	•		
	9804 Forest Green	•	•	•	•		•	•	•	•	•	•	•	•			•	•	•	•	•			•	•	•	•	•	•	•		
	9805 Jade Green	•	•	•	•		•	•	•	•	•	•	•	•			•	•	•	•	•			•	•	•	•	•	•	•		
	9806 Grey Green	•	•	•	•		•	•	•	•	•	•	•	•			•	•	•	•	•			•	•	•	•	•	•	•		
	9807 Warm Green	•	•	•	•		•	•	•	•	•	•	•	•			•	•	•	•	•			•	•	•	•	•	•	•		
TERRA COTTA MINERAL	9808 Dark Brown	•	•	•	•		•	•	•	•	•	•	•	•			•	•	•	•	•			•	•	•	•	•	•	•		
	9809 Rust Brown	•	•	•	•		•	•	•	•	•	•	•	•			•	•	•	•	•			•	•	•	•	•	•	•		
	9810 Quarts Brown	•	•	•	•		•	•	•	•	•	•	•	•			•	•	•	•	•			•	•	•	•	•	•	•		
	9811 Light Beige	•	•	•	•		•	•	•	•	•	•	•	•			•	•	•	•	•			•	•	•	•	•	•	•		
	9812 Orange Brown	•	•	•	•		•	•	•	•	•	•	•	•			•	•	•	•	•			•	•	•	•	•	•	•		
	9813 Blood Red	•	•	•	•		•	•	•	•	•	•	•	•			•	•	•	•	•			•	•	•	•	•	•	•		
	9814 Purple Red	•	•	•	•		•	•	•	•	•	•	•	•			•	•	•	•	•			•	•	•	•	•	•	•		
UNI COLOURS FINE TEXTURE	9815 Melon Yellow	•	•	•	•		•	•	•	•	•	•	•	•			•	•	•	•	•			•	•	•	•	•	•	•		
	9816 Carmine Red	•	•	•	•		•	•	•	•	•	•	•	•			•	•	•	•	•			•	•	•	•	•	•	•		
	9817 Claret Violet	•	•	•	•		•	•	•	•	•	•	•	•			•	•	•	•	•			•	•	•	•	•	•	•		
	9818 Night Blue	•	•	•	•		•	•	•	•	•	•	•	•			•	•	•	•	•			•	•	•	•	•	•	•		
	S601 Pigeon Blue	•	•	•	•		•	•	•	•	•	•	•	•			•	•	•	•	•			•	•	•	•	•	•	•		
	9820 Yellow Green	•	•	•	•		•	•	•	•	•	•	•	•			•	•	•	•	•			•	•	•	•	•	•	•		
	9821 Moss Green	•	•	•	•		•	•	•	•	•	•	•	•			•	•	•	•	•			•	•	•	•	•	•	•		
9990 Transparent coating																																

TECHNICAL SUMMARY ACCESSORIES
IN OPTION

PRICE GROUP: VPG10B - TOWEL RAILS



ref. nr.	dimensions (w)	price €	colour	ONI O-NP / O-NP-EL	BEAMS	BRYCE	ALU-ZEN	ZAROS VERTICAL	NIVA-A BLOWER NIVA-EL-BL-A	NIVA NIVA-EL / NTL1-EL-MIX	NIVA NTL1	NIVA N2L1	NIVA NTL1-ES	NIVA N2L1-ES	NIVA SOFT NTL1	NIVA SOFT NS2L1	CARRÉ PLUS	ZANA ZV-1		
 <p>towel rail MULTI+ right</p>	<p>towel rail MULTI+ right 1183 734 0000 0600 1183 734 0000 9005</p>	600 mm	204	S600	•	•	•	•	•	•	•	•	•	•	•	•	•	•	•	
		600 mm	204	RAL 9005 ^S	•	•	•	•	•	•	•	•	•	•	•	•	•	•	•	•
 <p>towel rail MULTI+ left</p>	<p>towel rail MULTI+ left 1183 735 0000 0600 1183 735 0000 9005</p>	600 mm	204	S600	•	•	•	•	•	•	•	•	•	•	•	•	•	•	•	
		600 mm	204	RAL 9005 ^S	•	•	•	•	•	•	•	•	•	•	•	•	•	•	•	•
 <p>towel rail</p>	<p>towel rail 1183 262 0000 0000* 1183 263 0000 0000* 1183 264 0000 0000*</p>	380 mm	164	aluminium	•	•	•	•	•	•	•	•	•	•	•	•	•	•	•	
		550 mm	164	aluminium	•	•	•	•	•	•	•	•	•	•	•	•	•	•	•	•
		720 mm	164	aluminium	•	•	•	•	•	•	•	•	•	•	•	•	•	•	•	•
 <p>towel rail</p>	<p>towel rail 1183 234 0000 0000 1183 235 0000 0000 1183 236 0000 0000 1183 237 0000 0000</p>	435 mm	164	aluminium	•	•	•	•	•	•	•	•	•	•	•	•	•	•	•	
		510 mm	164	aluminium	•	•	•	•	•	•	•	•	•	•	•	•	•	•	•	•
		585 mm	164	aluminium	•	•	•	•	•	•	•	•	•	•	•	•	•	•	•	•
		660 mm	164	aluminium	•	•	•	•	•	•	•	•	•	•	•	•	•	•	•	•
 <p>towel rail</p>	<p>towel rail 1183 244 0000 0000* 1183 245 0000 0000* 1183 246 0000 0000* 1183 247 0000 0000*</p>	435 mm	164	aluminium	•	•	•	•	•	•	•	•	•	•	•	•	•	•	•	
		510 mm	164	aluminium	•	•	•	•	•	•	•	•	•	•	•	•	•	•	•	•
		585 mm	164	aluminium	•	•	•	•	•	•	•	•	•	•	•	•	•	•	•	•
		660 mm	164	aluminium	•	•	•	•	•	•	•	•	•	•	•	•	•	•	•	•
 <p>towel rail</p>	<p>towel rail 1183 238 0000 0099</p>	720 mm	164	chrome	•	•	•	•	•	•	•	•	•	•	•	•	•	•	•	
 <p>towel rail</p>	<p>towel rail 1183 213 0000 0099 1183 214 0000 0099 1183 214 0000 9993 1183 215 0000 0099 1183 215 0000 9993 1183 216 0000 0099</p>	440 mm	187	chrome	•	•	•	•	•	•	•	•	•	•	•	•	•	•	•	
		540 mm	187	chrome	•	•	•	•	•	•	•	•	•	•	•	•	•	•	•	•
		540 mm	187	stainless steel	•	•	•	•	•	•	•	•	•	•	•	•	•	•	•	•
		640 mm	187	chrome	•	•	•	•	•	•	•	•	•	•	•	•	•	•	•	•
		640 mm	187	stainless steel	•	•	•	•	•	•	•	•	•	•	•	•	•	•	•	•
740 mm	187	chrome	•	•	•	•	•	•	•	•	•	•	•	•	•	•	•	•		

^S structure black

* DISCONTINUED ITEM

TECHNICAL SUMMARY ACCESSORIES IN OPTION

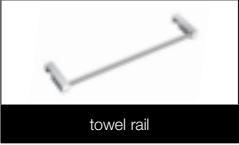
PRICE GROUP: VPG10B - TOWEL RAILS

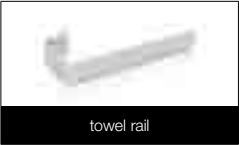
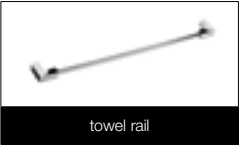
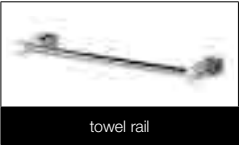
ref. nr.	dimensions (w)	price €	colour	CARRÉ BATHROOM CB-EL / CB-EL-BL	ZANA BATHROOM ZBD-EL	NIVA-A BLOWER NIVA-EL-BL-A	NIVA NIVA-EL / NTL1-EL-MIX	NIVA NTL1	NIVA N2L1	NIVA NTL1-ES	NIVA N2L1-ES	NIVA HORIZONTAL	NIVA SOFT NS1L1	NIVA SOFT NS2L1	CARRÉ PLUS	CARRÉ VERTICAL	CARRÉ HORIZONTAL	ARCHE VERTICAL VV	ZANA VERTICAL	ZANA HORIZONTAL	ZANA BATHROOM
 towel rail	towel rail																				
	1183 218 0000 0099	440 mm	187	chrome																	
	1183 219 0000 0099	540 mm	187	chrome																	
	1183 219 0000 9993*	540 mm	187	stainless steel																	
	1183 220 0000 0099	640 mm	187	chrome																	
1183 220 0000 9993*	640 mm	187	stainless steel																		
1183 221 0000 0099	740 mm	187	chrome																		
 towel rail	towel rail																				
	1183 217 0000 0099	740 mm	187	chrome																	
 towel rail	towel rail																				
	1183 239 0000 0000	372 mm	187	aluminium		•	•	•													
	1183 239 0000 0099	372 mm	187	chrome		•	•	•													
	1183 239 0000 0600	372 mm	187	S600		•	•	•													
	1183 239 0000 9005	372 mm	187	RAL 9005 ^M		•	•	•													
1183 271 0000 0099	526 mm	187	chrome		•	•	•														
1183 271 0000 0600	526 mm	187	S600		•	•	•														
1183 271 0000 9005	526 mm	187	RAL 9005 ^M		•	•	•														
 towel rail	towel rail																				
	1183 240 0000 0000	372 mm	187	aluminium																	
	1183 240 0000 0099	372 mm	187	chrome																	
	1183 240 0000 0600	372 mm	187	S600																	
	1183 240 0000 9005	372 mm	187	RAL 9005 ^M																	
1183 272 0000 0099	526 mm	187	chrome																		
1183 272 0000 0600	526 mm	187	S600																		
1183 272 0000 9005	526 mm	187	RAL 9005 ^M																		
 towel rail	towel rail																				
	1183 207 0000 0099	720 mm	187	chrome		•															
 towel rail	towel rail																				
	1183 228 0000 0099	720 mm	187	chrome		•															

^M matt black

• = Attention: towel rail only possible for NIVA-EL(-BL)(-MIX) from version 2021!

* DISCONTINUED ITEM

TECHNICAL SUMMARY ACCESSORIES IN OPTION

PRICE GROUP: VPG10B - TOWEL RAILS

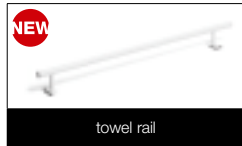

ref. nr.
towel rail
11911972040
11911972050
11911972060

dimensions (w)
400 mm
500 mm
600 mm

price
€
94
101
108

colour

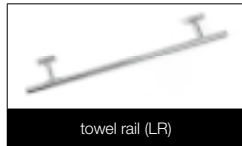

towel rail (LR)
11911988050
11911988060
11911988070
11911988080

500 mm
600 mm
700 mm
800 mm

119 chrome
127 chrome
135 chrome
141 chrome

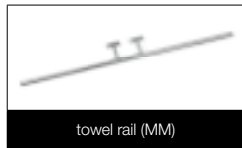

towel rail (MM)
11911989070*

700 mm

141 chrome

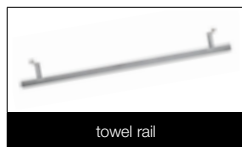

towel rail
1183252 0000 0099
1183253 0000 0099
1183254 0000 0099
1183255 0000 0099
1183256 0000 0099

400 mm
500 mm
600 mm
700 mm
800 mm

111 chrome
119 chrome
127 chrome
135 chrome
141 chrome



folding drying and stacking rack
1183001 0000 0099
1183002 0000 0099
1183003 0000 0099
1183004 0000 0099

380 x 158 mm
380 x 158 mm
380 x 158 mm
380 x 158 mm

135 chrome
135 chrome
135 chrome
135 chrome

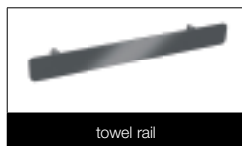

towel rail
1183270 0000 0099
1183270 0000 9016
1183270 0000 9005

500 mm
500 mm
500 mm





145 chrome
145 RAL 9016 ^M
145 RAL 9005 ^M

IRIS-A HDM-A / HDRM-A				
AGAVE-A HRM-A				
IRIS-A HD-EL-A / HDR-EL-A / HD-EL-BLA				
IRIS-A HDM-BL-MXA				
AGAVE-A HR-EL-A / HR-EL-BLA				
E-PANEL VERTICAL EP-V-FL				
VIOLA-A				
FLATLINE T21S / T22 / T33				
FLAT-V-LINE T21S / T22				

* DISCONTINUED ITEM

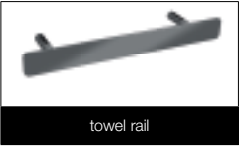
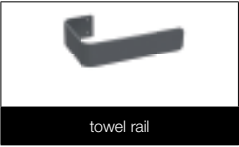
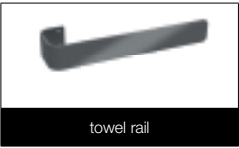





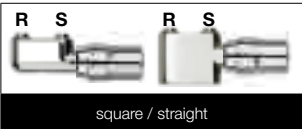
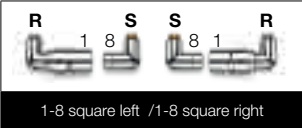

TECHNICAL SUMMARY ACCESSORIES IN OPTION

PRICE GROUP: VPG10B - TOWEL RAILS

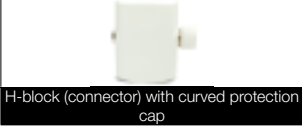
	ref. nr.	dimensions (w)	price €	colour	ONI O.P. / O.NIP. / O.NPEL	BEAMS MONO	BEAMS MONO-EL	BEAMS	BRYCE MONO	BRYCE	CARRÉ BATHROOM CB-EL / CB-EL-BL	ZANA BATHROOM ZBD-EL	CARRÉ	ARCHE VERTICAL W	ARCHE BATHROOM	ZANA	VIOLA-A	TULIPA-A	
	towel rail 1183 269 0000 0099 1183 269 0000 9016 1183 269 0000 9005	500 mm 500 mm 500 mm	145 145 145	chrome RAL 9016 RAL 9005 ^M															
	towel rail 1183 273 0000 0099 1183 273 0000 0600 1183 273 0000 9005	240 mm 240 mm 240 mm	107 107 107	chrome S600 RAL 9005 ^M		•	•	•	•	•									
	towel rail 1183 274 0000 0099 1183 274 0000 0600 1183 274 0000 9005	372 mm 372 mm 372 mm	160 160 160	chrome S600 RAL 9005 ^M		•	•	•	•	•									
	square hook 1183 500 0000 0099	24 mm	68	chrome							•		•						
	hook 1183 410 0000 0099	70 mm	87	chrome									•	•	•				
	hook 1183 411 0000 0099	70 mm	87	chrome													•		

^M matt black

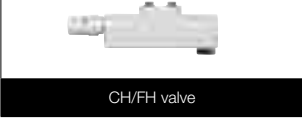
TECHNICAL MODELS OF VALVE SET COMBINED WITH RADIATORS IN OPTION

	•	ONI
	•	IRIS-A (HDM-A / HDM-A** / HDM-BL-MIX-A)
	•	AGAVE-A (HRM-A)
	•	ASTER-A (HF-A / HF-BL-MIX-A)
	•	BANO (BM / BMR*)
	•	BANO with central connection (BM/mm / BMR/mm**)
	•	CARRÉ BATHROOM (CB)
	•	ARCHE BATHROOM (AB)
	•	ZANA BATHROOM (ZBO)
	•	BEAMS MONO
	•	BEAMS
	•	BRYCE MONO
	•	BRYCE
	•	ALU-ZEN
	•	ZAROS VERTICAL (Zaros V75 / Zaros V100)
	•	NIVA VERTICAL LACQUERED (N1L1 / N2L1 / N1L1-EL-MIX)
	•	NIVA VERTICAL STAINLESS STEEL (N1L1-ES / N2L1-ES)
	•	NIVA HORIZONTAL LACQUERED (NH1L1 / NH2L1 / NH2L2)
	•	NIVA SOFT VERTICAL (NS1L1 / NS2L1)
	•	CARRÉ PLUS VERTICAL (CPVN-PLUS)
	•	CARRÉ VERTICAL (CPVN2-ZB)
	•	CARRÉ HORIZONTAL (CPHN1-RO / OPHN2-FORO)
	•	ARCHE VERTICAL (V)
	•	ARCHE PLUS VERTICAL (VL / VVR)
	•	ZANA VERTICAL (ZV-1 / ZV-2)
	•	ZANA HORIZONTAL (ZH-1 / ZH-2)
	•	VIOLA-A VERTICAL (V1-ZB-A / V1L1-ZB-A / V2-ZB-A*)
	•	VIOLA-A HORIZONTAL (H1-RO-A / H1L1-RO-A / H2-RO-A / H2L1-RO-A / H2L2-RO-A)
	•	TULIPA-A VERTICAL (TV1-A / TV2-A)
	•	TULIPA-A HORIZONTAL (TH1-A / TH2-A)
	•	FLATLINE (T21S / T22 / T33)**
	•	FLAT-V-LINE (T21S / T22)**
	•	FLAT-PLINT-LINE (T22 / T33)**

R = return / S = supply











* mm connection is possible only with even number of pipes

** CH/FH valve not possible for curved radiators

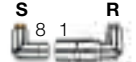
*** thermostatic head (see p. 257)

TECHNICAL MODELS OF VALVE SET COMBINED WITH RADIATORS IN OPTION

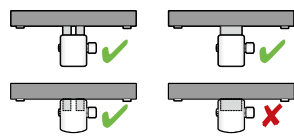
PRICE GROUP: VPG10 - ACC.

TYPE	COLOUR	REF. NR.	€*	FITTINGS	REF. NR.	€*	
SQUARE							
R S 	white	1182 103 0000 9016	195	½" For copper pipe 10 mm - colour nickel	1182 208 0000 0000	9	
	black ^M	1182 103 0000 9005	218	½" For copper pipe 12 mm - colour nickel	1182 206 0000 0000	9	
	chrome	1182 103 0000 0099	218	½" For copper pipe 14 mm - colour nickel	1182 209 0000 0000	9	
				½" For copper pipe 15 mm - colour nickel	1182 207 0000 0000	9	
				½" For copper pipe 16 mm - colour nickel	1182 210 0000 0000	9	
				½" For PEX/multilayered pipe (with or without aluminium coating) 14 x 2 mm	1182 205 0000 0000	11	
				½" For PEX/multilayered pipe (with or without aluminium coating) 16 x 2 mm	1182 204 0000 0000	11	
<ul style="list-style-type: none"> • Wall connection • Only two-pipe system • Supply on the right • Connection radiator side: ½" • Connection fitting side: ½" (inner thread) • Always order 2 fittings per valve set 							
STRAIGHT							
R S 	chrome	1182 104 0000 0099	218				
<ul style="list-style-type: none"> • Floor connection • Only two-pipe system • Supply on the right • Connection radiator side: ½" • Connection fitting side: ½" (inner thread) • Always order 2 fittings per valve set 	 <p style="text-align: center;">Copper PEX/multilayered</p>						
1-8 SQUARE LEFT							
R S 	white	1182 101 0000 9016	195				
	chrome	1182 101 0000 0099	218				
1-8 SQUARE RIGHT							
S R 	white	1182 102 0000 9016	195				
	chrome	1182 102 0000 0099	218				
<ul style="list-style-type: none"> • Wall connection • Only two-pipe system • Thermostatic head in return • Connection radiator side: ½" • Connection fitting side: ½" (inner thread) • Always order 2 fittings per valve set 							
H-BLOCK (CONNECTOR) WITH STRAIGHT PROTECTION CAP							
	white	1182 001 0000 9016	129	¾" For copper pipe 10 mm - colour nickel	1182 250 0000 0000	9	
	chrome	1182 001 0000 0099	139	¾" For copper pipe 12 mm - colour nickel	1182 251 0000 0000	9	
				¾" For copper pipe 14 mm - colour nickel	1182 252 0000 0000	9	
				¾" For copper pipe 15 mm - colour nickel	1182 253 0000 0000	9	
				¾" For copper pipe 16 mm - colour nickel	1182 254 0000 0000	9	
				¾" For copper pipe 18 mm - colour nickel	1182 255 0000 0000	9	
				¾" For PEX/multilayered pipe (with or without aluminium coating) 14 x 2 mm	1182 256 0000 0000	11	
				¾" For PEX/multilayered pipe (with or without aluminium coating) 16 x 2 mm	1182 257 0000 0000	11	
<ul style="list-style-type: none"> • Wall connection (floor connection possible when ordering curves, see p. 317) • One-pipe or two-pipe system • Thermostatic head not supplied • Supply and return are interchangeable • Connection radiator side: ½" • Connection fitting side: ¾" (Euro cones) • Always order 2 fittings per valve set • Thermostatic heads: 	 <p style="text-align: center;">Copper PEX/multilayered</p>						
H-BLOCK (CONNECTOR) WITH CURVED PROTECTION CAP							
	white	1182 002 0000 9016	129				
<ul style="list-style-type: none"> • Wall connection (floor connection possible when ordering curves, see p. 317) • One-pipe or two-pipe system • Thermostatic head not supplied • Supply and return are interchangeable • Connection radiator side: ½" • Connection fitting side: ¾" (Euro cones) • Always order 2 fittings per valve set • Thermostatic heads: 							
	white	ref. nr. 11911630102	price € 44		chrome	ref. nr. 11911631102	price € 63

^M matt black









R = return / S = supply

* Price per piece

** Please indicate colour when ordering (XXXX)

TECHNICAL MODELS OF VALVE SET COMBINED WITH RADIATORS IN OPTION

PRICE GROUP: VPG10 - ACC.

TYPE	COLOUR	REF. NR.	€*	FITTINGS	REF. NR.	€*	
BENT RADIATOR CONNECTOR 50MM 3/4"							
 <ul style="list-style-type: none"> Wall connection One-pipe or two-pipe system Supply and return are interchangeable Connection radiator side: 3/4" (Euro cones) Connection fitting side: 3/4" (Euro cones) Always order 2 fittings per valve set 	chrome	1182.300.0000.0099	147	3/4" For copper pipe 12 mm - colour chrome	1182.258.0000.0099	13	
					3/4" For copper pipe 14 mm - colour chrome	1182.264.0000.0099	13
					3/4" For copper pipe 15 mm - colour chrome	1182.259.0000.0099	13
					3/4" For PEX/multilayered pipe 14 x 2 mm – colour chrome	1182.260.0000.0099	14
					3/4" For PEX/multilayered pipe 16 x 2 mm – colour chrome	1182.261.0000.0099	14
					3/4" For PEX/multilayered pipe 16 x 2,25 mm – colour chrome	1182.262.0000.0099	14
					3/4" For PEX/multilayered pipe 20 x 2 mm – colour chrome	1182.263.0000.0099	14
BENT RADIATOR CONNECTOR VALVE 50MM 3/4"							
 <ul style="list-style-type: none"> Wall connection One-pipe or two-pipe system Supply on the right Connection radiator side: 3/4" (Euro cones) Connection fitting side: 3/4" (Euro cones) Always order 2 fittings per valve set 	chrome	1182.302.0000.0099	147	 Copper  PEX/multilayered			
BENT RADIATOR CONNECTOR 50MM 1/2"							
 <ul style="list-style-type: none"> Wall connection One-pipe or two-pipe system Supply and return are interchangeable Connection radiator side: 1/2" Connection fitting side: 3/4" (Euro cones) Always order 2 fittings per valve set 	chrome	1182.301.0000.0099	147				
CH/FH VALVE							
 <ul style="list-style-type: none"> Wall connection Only two-pipe system Connection radiator side: 1/2" or 3/4" Connection fitting side: 3/4" (Euro cones) Always order 2 fittings per valve set 	white	1182.305.0000.9016	394	3/4" For copper pipe 10 mm - colour nickel	1182.250.0000.0000	9	
	chrome	1182.305.0000.0099	424	3/4" For copper pipe 12 mm - colour nickel	1182.251.0000.0000	9	
				3/4" For copper pipe 14 mm - colour nickel	1182.252.0000.0000	9	
				3/4" For copper pipe 15 mm - colour nickel	1182.253.0000.0000	9	
				3/4" For copper pipe 16 mm - colour nickel	1182.254.0000.0000	9	
				3/4" For copper pipe 18 mm - colour nickel	1182.255.0000.0000	9	
				3/4" For PEX/multilayered pipe (with or without aluminium coating) 14 x 2 mm	1182.256.0000.0000	11	
				3/4" For PEX/multilayered pipe (with or without aluminium coating) 16 x 2 mm	1182.257.0000.0000	11	
BUILT-IN THERMOSTAT BOX							
 <ul style="list-style-type: none"> Wall connection (built-in) Only two-pipe system Connection radiator side: 3/4" Connection fitting side: 3/4" (Euro cones) Always order 4 fittings per valve set 	chrome	1182.306.0000.0099	409	 Copper  PEX/multilayered			

R = return / S = supply
* Price per piece

TECHNICAL SUMMARY STOCK RADIATORS

PRICE GROUP: VPG1 - BATHROOM RADIATORS

ONI

SEE P. 14



O-P

O-NP

TECHNICAL DATA					STANDARD COLOUR		OTHER COLOURS	
tubes	width (L mm)	height (H mm)	75/65/20 (Watt) (Ø50K)	55/45/20 (Watt) (Ø30K)	price S600 (€)	short ref. nr. S600 stock	price colour (€)	short ref. nr. M301 stock
REF. NR. ONI O-P : 11311								
-	500	1400	573	307	1203	11311-01	1383	-
-	500	1800	795	420	1360	11311-02	1564	-
-	500	2000	815	430	1436	11311-03	1651	-
REF. NR. ONI O-NP : 11312								
-	500	1400	573	307	1112	11312-01	1279	-
-	500	1800	795	420	1267	11312-02	1457	-
-	500	2000	815	430	1344	11312-03	1546	-

PRICE GROUP: VPG1 - BATHROOM RADIATORS

IRIS-A

SEE P. 16

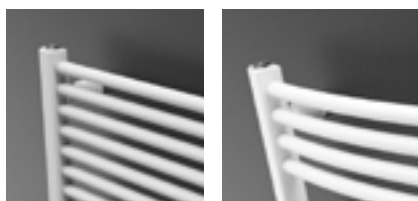

HDM-A

HDRM-A

TECHNICAL DATA					STANDARD COLOUR		OTHER COLOURS	
tubes	width (L mm)	height (H mm)	75/65/20 (Watt) (Ø50K)	55/45/20 (Watt) (Ø30K)	price RAL 9016 (€)	short ref. nr. RAL 9016 stock	price colour (€)	short ref. nr. M301 stock
REF. NR. IRIS-A HDM-A : 11388								
28	450	1104	511	268	544	11388-01	626	-
34	450	1308	600	314	658	11388-02	757	-
43	450	1682	764	400	724	11388-03	833	-
18	500	696	369	195	446	11388-04	513	-
28	500	1104	563	296	564	11388-05	649	-
34	500	1308	661	346	676	11388-06	777	-
43	500	1682	842	440	747	11388-07	859	-
18	600	696	436	230	467	11388-08	537	-
28	600	1104	666	349	596	11388-09	685	-
34	600	1308	782	409	711	11388-10	818	-
43	600	1682	996	521	788	11388-11	906	-
51	600	1954	1154	606	899	11388-12	1034	-
34	750	1308	960	501	764	11388-13	879	-
43	750	1682	1222	639	856	11388-14	984	-
51	750	1954	1417	743	976	11388-15	1122	-
43	900	1682	1445	755	923	11388-16	1061	-
51	900	1954	1675	878	1053	11388-17	1211	-
REF. NR. IRIS-A HDRM-A : 11389								
43	600	1682	996	521	866	11389-01	996	-

PRICE GROUP: VPG1 - BATHROOM RADIATORS

AGAVE-A

SEE P. 19

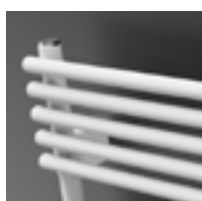

HRM-A

TECHNICAL DATA					STANDARD COLOUR		OTHER COLOURS	
tubes	width (L mm)	height (H mm)	75/65/20 (Watt) (Ø50K)	55/45/20 (Watt) (Ø30K)	price RAL 9016 (€)	short ref. nr. RAL 9016 stock	price colour (€)	short ref. nr. M301 stock
REF. NR. AGAVE-A HRM-A : 11394								
29	500	1171	638	345	657	11394-01	756	-
44	500	1798	921	493	1034	11394-02	1189	-
29	600	1171	763	411	700	11394-03	805	-
44	600	1798	1102	591	1108	11394-04	1274	-
44	750	1798	1372	738	1191	11394-05	1370	-

TECHNICAL SUMMARY STOCK RADIATORS

ASTER-A

SEE P. 21



HF-A

PRICE GROUP: VPG1 - BATHROOM RADIATORS

TECHNICAL DATA					STANDARD COLOUR		OTHER COLOURS	
tubes	width (L mm)	height (H mm)	75/65/20 (Watt) (φ50K)	55/45/20 (Watt) (φ30K)	price RAL 9016 (€)	short ref. nr. RAL 9016 stock	price colour (€)	short ref. nr. M301 stock

REF. NR. ASTER-A HF-A : 11397

21	450	1471	634	336	785	11397-01	903	-
27	450	1834	780	410	865	11397-02	995	-
16	600	1169	667	357	765	11397-03	880	-
21	600	1471	825	441	881	11397-04	1013	-
27	600	1834	1014	541	994	11397-05	1143	-

PRICE GROUP: VPG1 - BATHROOM RADIATORS

BANO

SEE P. 23



BM



BMR

TECHNICAL DATA					STANDARD COLOUR	
tubes	width (L mm)	height (H mm)	75/65/20 (Watt) (φ50K)	55/45/20 (Watt) (φ30K)	short ref. nr. RAL 9016 stock	

REF. NR. BANO BM : 11101

15	500	702	347	185	11101-13	
25	500	1186	574	311	11101-04	
35	500	1714	823	439	11101-07	
25	600	1186	676	366	11101-08	
35	600	1714	970	520	11101-09	

REF. NR. BANO BMR : 11104

35	600	1714	970	520	11104-09	
----	-----	------	-----	-----	-----------------	--

Prices on demand

PRICE GROUP: VPG1 - BATHROOM RADIATORS

BANO with central connection

SEE P. 25



BMmm



BMRmm

TECHNICAL DATA					STANDARD COLOUR	
tubes	width (L mm)	height (H mm)	75/65/20 (Watt) (φ50K)	55/45/20 (Watt) (φ30K)	short ref. nr. RAL 9016 stock	

REF. NR. BANO WITH CENTRAL CONNECTION BMmm : 11103

15	500	702	347	185	11103-02	
25	500	1186	574	311	11103-03	
35	500	1714	823	439	11103-05	
15	600	702	409	218	11103-08	
25	600	1186	676	366	11103-04	
35	600	1714	970	520	11103-06	

REF. NR. BANO WITH CENTRAL CONNECTION BMRmm : 11105

35	600	1714	970	520	11105-07	
----	-----	------	-----	-----	-----------------	--

Prices on demand

PRICE GROUP: VPG1 - BATHROOM RADIATORS

CARRÉ BATHROOM

SEE P. 27

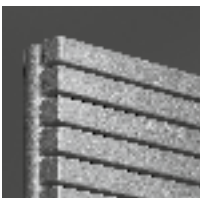

CB

TECHNICAL DATA					STANDARD COLOUR		OTHER COLOURS	
tubes	width (L mm)	height (H mm)	75/65/20 (Watt) (φ50K)	55/45/20 (Watt) (φ30K)	price RAL 9016 (€)	short ref. nr. RAL 9016 stock	price colour (€)	short ref. nr. M301 stock

REF. NR. CARRÉ BATHROOM CB : 11128

40	500	1375	747	399	998	11128-12	1148	-
50	600	1735	1089	581	1241	11128-24	1427	-

TECHNICAL SUMMARY STOCK RADIATORS

ARCHE BATHROOM

SEE P. 29



AB

PRICE GROUP: VPG1 - BATHROOM RADIATORS

TECHNICAL DATA					STANDARD COLOUR		OTHER COLOURS	
tubes	width (L mm)	height (H mm)	75/65/20 (Watt) (Φ50K)	55/45/20 (Watt) (Φ30K)	price RAL 9016 (€)	short ref. nr. RAL 9016 stock	price colour (€)	short ref. nr. M301 stock

REF. NR. ARCHE BATHROOM AB : 11259

28	500	1470	805	419	1048	11259-04	1205	-
36	500	1870	1022	531	1216	11259-02	1398	-
28	600	1470	942	487	1094	11259-05	1258	-
36	600	1870	1197	622	1269	11259-03	1459	-

BEAMS MONO-EL

SEE P. 54



BEAMS MONO-EL

PRICE GROUP: VPG7 - ELECTRIC RADIATORS

TECHNICAL DATA					STANDARD COLOUR		OTHER COLOURS	
tubes	width (L mm)	height (H mm)	electr. resistance	version	price S600 (€)	short ref. nr. S600 stock	price colour (€)	short ref. nr. M301 stock

REF. NR. BEAMS MONO-EL : 11349

-	150	1800	950	-0000	1057	11349-01	1216	-
				-0014	OD	11349-02	OD	-
				-00 15	OD	11349-03	OD	-

Controller included in the price!

OD = Prices on demand

ONI-EL

SEE P. 56



O-P-EL



O-NP-EL

PRICE GROUP: VPG7 - ELECTRIC RADIATORS

TECHNICAL DATA				STANDARD COLOUR		OTHER COLOURS	
tubes	width (L mm)	height (H mm)	electr. resistance	price S600 (€)	short ref. nr. S600 stock	price colour (€)	short ref. nr. M301 stock

REF. NR. O-P-EL : 11348

-	500	1400	750	1249	11348-01	1436	-
-	500	1800	1000	1378	11348-02	1585	-

REF. NR. O-NP-EL : 11356

-	500	1800	1000	1306	11356-01	1502	-
---	-----	------	------	-------------	-----------------	-------------	---

Controller included in the price!

NIVA-EL

SEE P. 58



NIVA-EL

PRICE GROUP: VPG7 - ELECTRIC RADIATORS

TECHNICAL DATA				STANDARD COLOUR		OTHER COLOURS	
tubes	width (L mm)	height (H mm)	electr. resistance	price S600 (€)	short ref. nr. S600 stock	price colour (€)	short ref. nr. M301 stock

REF. NR. NIVA-EL : 11361

-	420	1820	900	900	11361-01	1035	-
-	520	920	500	788	11361-02	906	-
-	520	1420	900	860	11361-03	989	-
-	520	1820	1100	940	11361-04	1081	-
-	620	1820	1300	974	11361-05	1120	-
-	620	2020	1500	1083	11361-06	1245	-

Controller included in the price!

PRICE GROUP: VPG7 - ELECTRIC RADIATORS

IRIS-A ELECTRIC

SEE P. 60

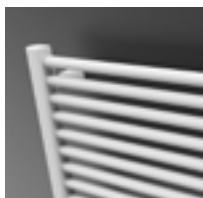

HD-EL-A

TECHNICAL DATA				STANDARD COLOUR		OTHER COLOURS	
tubes	width (L mm)	height (H mm)	electr. resistance	price RAL 9016 (€)	short ref. nr. RAL 9016 stock	price colour (€)	short ref. nr. M301 stock

REF. NR. IRIS-A HD-EL-A : 11390

28	500	1104	500	552	11390-01	635	-
34	500	1308	750	618	11390-02	711	-
43	600	1682	1000	730	11390-05	840	-
51	600	1954	1250	804	11390-03	925	-
51	750	1954	1500	850	11390-04	978	-

Regulation to be ordered separately, see also p. 49.

PRICE GROUP: VPG7 - ELECTRIC RADIATORS

ASTER-A ELECTRIC

SEE P. 64



HF-EL-A

TECHNICAL DATA				STANDARD COLOUR		OTHER COLOURS	
tubes	width (L mm)	height (H mm)	electr. resistance	price RAL 9016 (€)	short ref. nr. RAL 9016 stock	price colour (€)	short ref. nr. M301 stock

REF. NR. ASTER-A HF-EL-A : 11398

16	500	1169	500	774	11398-01	890	-
27	500	1834	750	923	11398-02	1061	-
27	600	1834	1000	1085	11398-03	1248	-

Regulation to be ordered separately, see also p. 49.

PRICE GROUP: VPG7 - ELECTRIC RADIATORS

CARRÉ BATHROOM ELECTRIC E-VOLVE

SEE P. 66

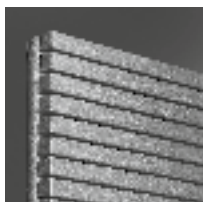

CB-EL

TECHNICAL DATA				STANDARD COLOUR		OTHER COLOURS	
tubes	width (L mm)	height (H mm)	electr. resistance	price RAL 9016 (€)	short ref. nr. RAL 9016 stock	price colour (€)	short ref. nr. M301 stock

REF. NR. CARRÉ BATHROOM CB-EL : 11335

50	600	1737	1250	1400	11335-01	1610	-
----	-----	------	------	-------------	-----------------	-------------	---

Regulation to be ordered separately, see also p. 49.

PRICE GROUP: VPG7 - ELECTRIC RADIATORS

E-BANO

SEE P. 70



BM-EL

TECHNICAL DATA				STANDARD COLOUR	
tubes	width (L mm)	height (H mm)	electr. resistance	short ref. nr. RAL 9016 stock	

REF. NR. E-BANO BM-EL : 11342

18	500	878	500	11342-05	
26	500	1274	750	11342-06	
35	500	1714	1000	11342-07	
37	600	1802	1250	11342-08	

Controller included in the price!

Prices on demand

TECHNICAL SUMMARY STOCK RADIATORS

PRICE GROUP: VPG7 - ELECTRIC RADIATORS

E-PANEL

SEE P. 72



EP-H-FL



EP-H-RIB



EP-V-FL

TECHNICAL DATA				STANDARD COLOUR		OTHER COLOURS	
tubes	width (L mm)	height (H mm)	electr. resistance	price RAL 9016 (€)	short ref. nr. RAL 9016 stock	price colour (€)	short ref. nr. M301 stock
REF. NR. E-PANEL HORIZONTAL EP-H-FL : 11339							
-	500	600	500	714	11339-01	821	-
-	800	600	1000	833	11339-02	958	-
-	1001	600	1500	966	11339-03	1111	-
-	1201	600	2000	1118	11339-04	1286	-
REF. NR. E-PANEL HORIZONTAL EP-H-RIB : 11340							
-	500	600	500	607	11340-01	698	-
-	800	600	1000	708	11340-02	814	-
-	1001	600	1500	823	11340-03	946	-
-	1201	600	2000	951	11340-04	1094	-
REF. NR. E-PANEL VERTICAL EP-V-FL : 11341							
-	400	1801	1000	856	11341-01	984	-
-	500	1800	1250	930	11341-02	1070	-
-	500	2000	1500	1004	11341-03	1155	-
-	600	2000	1750	1080	11341-04	1242	-

Controller included in the price!

PRICE GROUP: VPG7 - ELECTRIC RADIATORS

IRIS-A BLOWER

SEE P. 77

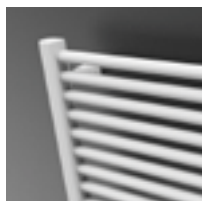

HD-EL-BL-A

TECHNICAL DATA					STANDARD COLOUR		OTHER COLOURS	
tubes	width (L mm)	height (H mm)	electr. resistance	output Blower (Watt)	price RAL 9016 (€)	short ref. nr. RAL 9016 stock	price colour (€)	short ref. nr. M301 stock
REF. NR. IRIS-A BLOWER HD-EL-BL-A : 11392								
28	500	1104	500	+1000	932	11392-01	1072	-
34	500	1308	750	+1000	986	11392-02	1134	-
43	600	1682	1000	+1000	1118	11392-03	1286	-
51	600	1954	1250	+1000	1250	11392-04	1438	-
51	750	1954	1500	+1000	1399	11392-05	1609	-

Blower included in the price!

PRICE GROUP: VPG7 - ELECTRIC RADIATORS

ASTER-A BLOWER

SEE P. 79



HF-EL-BL-A

TECHNICAL DATA					STANDARD COLOUR		OTHER COLOURS	
tubes	width (L mm)	height (H mm)	electr. resistance	output Blower (Watt)	price RAL 9016 (€)	short ref. nr. RAL 9016 stock	price colour (€)	short ref. nr. M301 stock
REF. NR. ASTER-A BLOWER HF-EL-BL-A : 11399								
16	500	1169	500	+1000	1220	11399-01	1403	-
27	500	1834	750	+1000	1413	11399-02	1625	-
27	600	1834	1000	+1000	1664	11399-03	1914	-

Blower included in the price!

PRICE GROUP: VPG7 - ELECTRIC RADIATORS

CARRÉ BATHROOM BLOWER

SEE P. 80

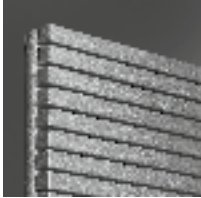

CB-EL-BL

TECHNICAL DATA					STANDARD COLOUR		OTHER COLOURS	
tubes	width (L mm)	height (H mm)	electr. resistance	output Blower (Watt)	price RAL 9016 (€)	short ref. nr. RAL 9016 stock	price colour (€)	short ref. nr. M301 stock

REF. NR. CARRÉ BATHROOM BLOWER CB-EL-BL : 11319

32	500	1137	750	+1000	1454	11319-01	1672	-
50	600	1737	1250	+1000	1840	11319-02	2116	-

Blower included in the price!

PRICE GROUP: VPG7 - ELECTRIC RADIATORS

NIVA-A ELECTRIC BLOWER

SEE P. 81



NIVA-EL-BL-A

TECHNICAL DATA					STANDARD COLOUR		OTHER COLOURS	
tubes	width (L mm)	height (H mm)	electr. resistance	output Blower (Watt)	price S600 (€)	short ref. nr. S600 stock	price colour (€)	short ref. nr. M301 stock

REF. NR. NIVA-A BLOWER NIVA-EL-BL-A : 11402

-	620	1298	750	+1000	1368	11402-02	1573	-
-	620	1842	1000	+1000	1485	11402-01	1708	-

Blower included in the price!

PRICE GROUP: VPG7 - ELECTRIC RADIATORS

IRIS-A BLOWER MIXED

SEE P. 92



HDM-BL-MIX-A

TECHNICAL DATA						STANDARD COLOUR		OTHER COLOURS	
tubes	width (L mm)	height (H mm)	75/65/20 (Watt) (φ50K)	55/45/20 (Watt) (φ30K)	output Blower (Watt)	price RAL 9016 (€)	short ref. nr. RAL 9016 stock	price colour (€)	short ref. nr. M301 stock

REF. NR. IRIS-A BLOWER MIXED HDM-BL-MIX-A : 11393

42	600	1682	996	521	+1000	OD	11393-01	OD	-
----	-----	------	-----	-----	-------	-----------	-----------------	-----------	---

Blower included in the price!

OD = Prices on demand

PRICE GROUP: VPG7 - ELECTRIC RADIATORS

ASTER-A BLOWER MIXED

SEE P. 93



HF-BL-MIX-A

TECHNICAL DATA						STANDARD COLOUR		OTHER COLOURS	
tubes	width (L mm)	height (H mm)	75/65/20 (Watt) (φ50K)	55/45/20 (Watt) (φ30K)	output Blower (Watt)	price RAL 9016 (€)	short ref. nr. RAL 9016 stock	price colour (€)	short ref. nr. M301 stock

REF. NR. ASTER-A BLOWER MIXED HF-BL-MIX-A : 11400

27	600	1834	1014	541	+1000	OD	11400-01	OD	-
----	-----	------	------	-----	-------	-----------	-----------------	-----------	---

Blower included in the price!

OD = Prices on demand

TECHNICAL SUMMARY STOCK RADIATORS

BEAMS MONO

SEE P. 110



BEAMS MONO

PRICE GROUP: VPG6 - ALUMINIUM DESIGN RADIATORS

tubes	TECHNICAL DATA				STANDARD COLOUR		OTHER COLOURS	
	width (L mm)	height (H mm)	75/65/20 (Watt) (φ50K)	55/45/20 (Watt) (φ30K)	price S600 (€)	short ref. nr. S600 stock	price colour (€)	short ref. nr. M301 stock
REF. NR. BEAMS MONO : 11258								
-	150	1800	671	351	843	11258-09	969	-
-	150	2000	734	384	888	11258-10	1021	-

BEAMS

SEE P. 112



BEAMS

PRICE GROUP: VPG6 - ALUMINIUM DESIGN RADIATORS

tubes	TECHNICAL DATA				STANDARD COLOUR		OTHER COLOURS	
	width (L mm)	height (H mm)	75/65/20 (Watt) (φ50K)	55/45/20 (Watt) (φ30K)	price S600 (€)	short ref. nr. S600 stock	price colour (€)	short ref. nr. M301 stock
REF. NR. BEAMS : 11258								
2	320	1600	1127	583	881	11258-04	1013	-
2	320	1800	1237	643	934	11258-01	1074	-
2	320	2000	1348	701	959	11258-05	1103	-
3	490	1600	1658	867	1284	11258-06	1477	-
3	490	1800	1821	947	1361	11258-02	1565	-
3	490	2000	1983	1026	1400	11258-03	1610	-
4	660	1800	2385	1247	1752	11258-07	2015	-
4	660	2000	2598	1337	1805	11258-08	2076	-

BRYCE MONO

SEE P. 115



BRYCE MONO

PRICE GROUP: VPG6 - ALUMINIUM DESIGN RADIATORS

tubes	TECHNICAL DATA				STANDARD COLOUR		OTHER COLOURS	
	width (L mm)	height (H mm)	75/65/20 (Watt) (φ50K)	55/45/20 (Watt) (φ30K)	price S600 (€)	short ref. nr. S600 stock	price colour (€)	short ref. nr. M301 stock
REF. NR. BRYCE MONO : 11209								
-	150	1800	586	306	843	11209-10	969	-

BRYCE

SEE P. 117



BRYCE V75



BRYCE V100

PRICE GROUP: VPG6 - ALUMINIUM DESIGN RADIATORS

tubes	TECHNICAL DATA				STANDARD COLOUR		OTHER COLOURS	
	width (L mm)	height (H mm)	75/65/20 (Watt) (φ50K)	55/45/20 (Watt) (φ30K)	price S600 (€)	short ref. nr. S600 stock	price colour (€)	short ref. nr. M301 stock
REF. NR. BRYCE VERTICAL BRYCE V75 : 11328								
-	450	1800	1555	784	1136	11328-01	1306	-
-	525	1800	1792	895	1310	11328-02	1507	-
-	600	1800	2028	1007	1481	11328-03	1703	-
-	600	2000	2204	1123	1530	11328-04	1760	-
REF. NR. BRYCE VERTICAL BRYCE V100 : 11209								
-	450	1800	1644	838	1361	11209-01	1565	-
-	525	1800	1914	975	1556	11209-03	1789	-
-	600	1800	2184	1113	1752	11209-08	2015	-
-	600	2000	2391	1218	1805	11209-05	2076	-

TECHNICAL SUMMARY STOCK RADIATORS

PRICE GROUP: VPG6 - ALUMINIUM DESIGN RADIATORS

ALU-ZEN

SEE P. 120

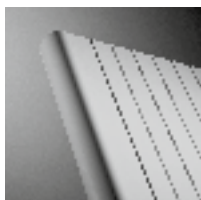

ALU-ZEN

TECHNICAL DATA					STANDARD COLOUR		OTHER COLOURS	
tubes	width (L mm)	height (H mm)	75/65/20 (Watt) (φ50K)	55/45/20 (Watt) (φ30K)	price S600 (€)	short ref. nr. S600 stock	price colour (€)	short ref. nr. M301 stock

REF. NR. ALU-ZEN VERTICAL : 11114

-	450	1800	1596	817	1361	11114-06	1565	-
-	525	1800	1874	960	1553	11114-01	1786	-
-	600	1800	2155	1104	1752	11114-03	2015	-
-	600	2000	2351	1204	1805	11114-02	2076	-

PRICE GROUP: VPG6 - ALUMINIUM DESIGN RADIATORS

ZAROS VERTICAL

SEE P. 123



ZAROS V75



ZAROS V100

TECHNICAL DATA					STANDARD COLOUR		OTHER COLOURS	
tubes	width (L mm)	height (H mm)	75/65/20 (Watt) (φ50K)	55/45/20 (Watt) (φ30K)	price S600 (€)	short ref. nr. S600 stock	price colour (€)	short ref. nr. M301 stock

REF. NR. ZAROS VERTICAL ZAROS V75 : 11247

5	375	1600	1159	594	866	11247-05	996	-
5	375	1800	1281	656	922	11247-06	1060	-
6	450	1800	1518	770	1072	11247-07	1233	-
7	525	1800	1755	876	1228	11247-01	1412	-
8	600	1800	1991	984	1381	11247-04	1588	-
8	600	2000	2171	1106	1421	11247-02	1634	-

REF. NR. ZAROS VERTICAL ZAROS V100 : 11246

7	525	1800	2049	1039	1362	11246-01	1566	-
8	600	1800	2326	1173	1539	11246-03	1770	-
8	600	2000	2536	1299	1581	11246-02	1818	-

PRICE GROUP: VPG2 - STEEL DESIGN RADIATORS

NIVA VERTICAL LACQUERED

SEE P. 134



N1L1



N2L1

TECHNICAL DATA					STANDARD COLOUR		OTHER COLOURS	
tubes	width (L mm)	height (H mm)	75/65/20 (Watt) (φ50K)	55/45/20 (Watt) (φ30K)	price S600 (€)	short ref. nr. S600 stock	price colour (€)	short ref. nr. M301 stock

REF. NR. NIVA VERTICAL LACQUERED N1L1 : 11191

-	420	1220	645	337	514	11191-02	591	-
-	420	1820	934	486	597	11191-03	687	11191-05
-	420	2020	1023	532	632	11191-06	727	-
-	520	1220	815	424	579	11191-21	666	-
-	520	1820	1128	587	672	11191-16	773	11191-01
-	520	2020	1257	654	711	11191-22	818	-
-	620	1220	985	510	602	11191-07	692	-
-	620	1820	1322	687	701	11191-17	806	11191-04
-	620	2020	1490	775	742	11191-20	853	-
-	720	1820	1515	784	728	11191-08	837	-
-	720	2020	1724	897	774	11191-09	890	-

REF. NR. NIVA VERTICAL LACQUERED N2L1 : 11192

-	420	1820	1330	681	894	11192-02	1028	-
-	420	2020	1438	736	928	11192-04	1067	-
-	520	1220	1213	621	863	11192-05	992	-
-	520	1820	1633	836	1007	11192-31	1158	-
-	520	2020	1764	903	1045	11192-32	1202	-
-	620	1220	1437	732	902	11192-37	1037	-
-	620	1820	1935	991	1049	11192-33	1206	-
-	620	2020	2091	1071	1088	11192-34	1251	-
-	620	2220	2243	1160	1157	11192-39	1331	-
-	720	1820	2237	1146	1085	11192-07	1248	-
-	720	2020	2417	1238	1136	11192-35	1306	-
-	720	2220	2594	1322	1214	11192-36	1396	-

TECHNICAL SUMMARY STOCK RADIATORS

NIVA HORIZONTAL LACQUERED

SEE P. 138



NH1L1 / NH2L1

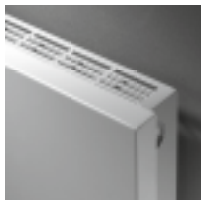

NH2L2

PRICE GROUP: VPG2 - STEEL DESIGN RADIATORS

TECHNICAL DATA					STANDARD COLOUR		OTHER COLOURS	
tubes	width (L mm)	height (H mm)	75/65/20 (Watt) (φ50K)	55/45/20 (Watt) (φ30K)	price S600 (€)	short ref. nr. S600 stock	price colour (€)	short ref. nr. M301 stock
REF. NR. NIVA HORIZONTAL LACQUERED NH1L1 : 11193								
-	520	450	301	158	469	11193-01	539	-
REF. NR. NIVA HORIZONTAL LACQUERED NH2L1 : 11194								
-	1020	650	1165	609	997	11194-23	1147	-
REF. NR. NIVA HORIZONTAL LACQUERED NH2L2 : 11195								
-	1078	650	1496	774	1266	11195-16	1456	-

NIVA SOFT VERTICAL

SEE P. 141

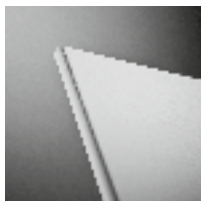

NS1L1

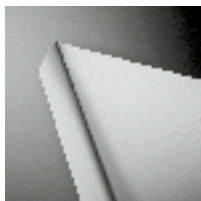

NS2L1

PRICE GROUP: VPG2 - STEEL DESIGN RADIATORS

TECHNICAL DATA					STANDARD COLOUR		OTHER COLOURS	
tubes	width (L mm)	height (H mm)	75/65/20 (Watt) (φ50K)	55/45/20 (Watt) (φ30K)	price S600 (€)	short ref. nr. S600 stock	price colour (€)	short ref. nr. M301 stock
REF. NR. NIVA SOFT VERTICAL NS1L1 : 11197								
-	440	1220	645	337	514	11197-06	591	-
-	440	1820	934	486	597	11197-07	687	-
-	440	2020	1023	532	632	11197-08	727	-
-	540	1220	815	424	579	11197-04	666	-
-	540	1820	1128	587	672	11197-01	773	-
-	540	2020	1257	654	711	11197-05	818	-
-	640	1220	985	510	602	11197-09	692	-
-	640	1820	1322	687	701	11197-02	806	-
-	640	2020	1490	775	742	11197-03	853	-
-	740	1820	1515	784	728	11197-10	837	-
-	740	2020	1724	897	774	11197-11	890	-
REF. NR. NIVA SOFT VERTICAL NS2L1 : 11198								
-	440	1820	1330	681	894	11198-08	1028	-
-	440	2020	1438	736	928	11198-09	1067	-
-	540	1220	1213	621	863	11198-10	992	-
-	540	1820	1633	836	1007	11198-01	1158	-
-	540	2020	1764	903	1045	11198-02	1202	-
-	640	1820	1935	991	1049	11198-03	1206	-
-	640	2020	2091	1071	1088	11198-04	1251	-
-	740	1820	2237	1146	1085	11198-11	1248	-
-	740	2020	2417	1238	1136	11198-05	1306	-

PRICE GROUP: VPG2 - STEEL DESIGN RADIATORS

CARRÉ PLUS VERTICAL

SEE P. 154



CPVN-PLUS

TECHNICAL DATA					STANDARD COLOUR		OTHER COLOURS	
tubes	width (L mm)	height (H mm)	75/65/20 (Watt) (ϕ 50K)	55/45/20 (Watt) (ϕ 30K)	price RAL 9016 (€)	short ref. nr. RAL 9016 stock	price colour (€)	short ref. nr. M301 stock

REF. NR. CARRÉ PLUS VERTICAL CPVN-PLUS : 11210

12	355	1800	1293	659	691	11210-16	795	-
14	415	2000	1632	836	865	11210-05	995	-
18	535	1800	1862	954	1037	11210-07	1193	-
18	535	2000	2046	1048	1117	11210-09	1285	-
20	595	1800	2047	1048	1152	11210-11	1325	-
20	595	2000	2250	1152	1239	11210-12	1425	-

PRICE GROUP: VPG2 - STEEL DESIGN RADIATORS

ARCHE VERTICAL

SEE P. 172



W

TECHNICAL DATA					STANDARD COLOUR		OTHER COLOURS	
tubes	width (L mm)	height (H mm)	75/65/20 (Watt) (ϕ 50K)	55/45/20 (Watt) (ϕ 30K)	price RAL 9016 (€)	short ref. nr. RAL 9016 stock	price colour (€)	short ref. nr. M301 stock

REF. NR. ARCHE VERTICAL W : 11117

10	470	1800	1050	560	541	11117-03	622	-
----	-----	------	------	-----	------------	-----------------	------------	---

PRICE GROUP: VPG2 - STEEL DESIGN RADIATORS

ARCHE PLUS VERTICAL

SEE P. 174

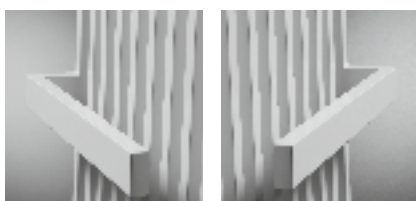

WL

VVR

TECHNICAL DATA					STANDARD COLOUR		OTHER COLOURS	
tubes	width (L mm)	height (H mm)	75/65/20 (Watt) (ϕ 50K)	55/45/20 (Watt) (ϕ 30K)	price RAL 9016 (€)	short ref. nr. RAL 9016 stock	price colour (€)	short ref. nr. M301 stock

REF. NR. ARCHE PLUS VERTICAL VVL : 11118

10	470	1800	1050	560	726	11118-01	835	-
----	-----	------	------	-----	------------	-----------------	------------	---

REF. NR. ARCHE PLUS VERTICAL VVR : 11119

10	470	1800	1050	560	726	11119-01	835	-
----	-----	------	------	-----	------------	-----------------	------------	---

TECHNICAL SUMMARY STOCK RADIATORS

ZANA VERTICAL

SEE P. 179

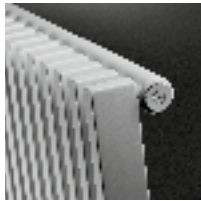

ZV-1

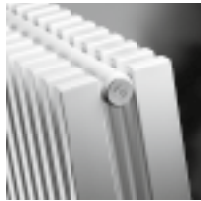

ZV-2

PRICE GROUP: VPG2 - STEEL DESIGN RADIATORS

TECHNICAL DATA					STANDARD COLOUR		OTHER COLOURS	
tubes	width (L mm)	height (H mm)	75/65/20 (Watt) (φ50K)	55/45/20 (Watt) (φ30K)	price RAL 9016 (€)	short ref. nr. RAL 9016 stock	price colour (€)	short ref. nr. M301 stock

REF. NR. ZANA VERTICAL ZV-1 : 11254

10	384	1800	1074	567	644	11254-03	741	-
12	464	1800	1289	681	757	11254-12	871	-
12	464	2000	1425	752	818	11254-01	941	-
14	544	1800	1504	794	865	11254-07	995	-
14	544	2000	1663	878	935	11254-08	1075	-
16	624	1800	1719	908	980	11254-09	1127	-
16	624	2000	1900	1003	1059	11254-02	1218	-

REF. NR. ZANA VERTICAL ZV-2 : 11255

14	544	2000	2651	1400	1594	11255-02	1833	-
18	704	2000	3409	1800	2007	11255-01	2308	-

VIOLA-A VERTICAL

SEE P. 192



V1-ZB-A



V2-ZB-A

PRICE GROUP: VPG2 - STEEL DESIGN RADIATORS

TECHNICAL DATA					STANDARD COLOUR		OTHER COLOURS	
tubes	width (L mm)	height (H mm)	75/65/20 (Watt) (φ50K)	55/45/20 (Watt) (φ30K)	price RAL 9016 (€)	short ref. nr. RAL 9016 stock	price colour (€)	short ref. nr. M301 stock

REF. NR. VIOLA-A VERTICAL V1-ZB-A : 11386

6	477	2000	1104	563	705	11386-01	811	-
---	-----	------	------	-----	------------	-----------------	------------	---

REF. NR. VIOLA-A VERTICAL V2-ZB-A : 11387

8	637	2000	1965	1003	1496	11387-01	1720	-
---	-----	------	------	------	-------------	-----------------	-------------	---

TULIPA-A VERTICAL

SEE P. 233

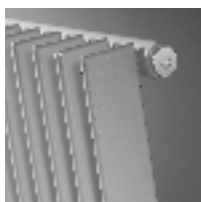

TV1-A



TV2-A

PRICE GROUP: VPG2 - STEEL DESIGN RADIATORS

TECHNICAL DATA					STANDARD COLOUR		OTHER COLOURS	
tubes	width (L mm)	height (H mm)	75/65/20 (Watt) (φ50K)	55/45/20 (Watt) (φ30K)	price RAL 9016 (€)	short ref. nr. RAL 9016 stock	price colour (€)	short ref. nr. M301 stock

REF. NR. TULIPA-A VERTICAL TV1-A : 11378

12	540	1800	1320	684	661	11378-01	760	-
12	540	2000	1476	768	710	11378-02	817	-

REF. NR. TULIPA-A VERTICAL TV2-A : 11379

12	540	2000	2424	1248	1244	11379-01	1431	-
14	630	2000	2828	1456	1434	11379-02	1649	-

FLATLINE

FULL STOCK OVERVIEW: SEE P. 246



T21S

T22

T33

FLAT-V-LINE

SEE P. 252



T21S

T22

TECHNICAL DATA					STANDARD COLOUR	
tubes	width (L mm)	height (H mm)	75/65/20 (Watt) (φ50K)	55/45/20 (Watt) (φ30K)	price S600 (€)	short ref. nr. S600 stock
REF. NR. FLAT-V-LINE T21S : 11298						
-	400	1600	1047	531	842	11298-07
-	400	1800	1120	562	881	11298-01
-	400	2000	1198	598	911	11298-02
-	500	1800	1400	703	967	11298-03
-	500	2000	1498	748	1036	11298-04
-	600	1800	1680	843	1076	11298-05
-	600	2000	1798	898	1159	11298-06
REF. NR. FLAT-V-LINE T22 : 11299						
-	400	1800	1394	668	1033	11299-01
-	400	2000	1509	708	1111	11299-02
-	500	1800	1743	836	1120	11299-03
-	500	2000	1886	886	1231	11299-04
-	600	1800	2092	1003	1236	11299-05
-	600	2000	2263	1063	1349	11299-06
-	700	1800	2440	1170	1354	11299-07
-	700	2000	2640	1240	1476	11299-08
-	800	2000	3018	1417	1620	11299-09
-	800	2200	3251	1631	1696	11299-10

FLAT-PLINT-LINE

SEE P. 254



T22

T33

TECHNICAL DATA					STANDARD COLOUR	
tubes	width (L mm)	height (H mm)	75/65/20 (Watt) (φ50K)	55/45/20 (Watt) (φ30K)	price S600 (€)	short ref. nr. S600 stock
REF. NR. FLAT-PLINT-LINE T22 : 11300						
-	1000	200	605	313	347	11300-01
-	1200	200	726	376	384	11300-02
-	1600	200	968	501	455	11300-03
-	2000	200	1210	626	494	11300-04
REF. NR. FLAT-PLINT-LINE T33 : 11301						
-	1000	200	866	450	440	11301-01
-	1200	200	1039	540	492	11301-02
-	1600	200	1386	720	580	11301-03
-	2000	200	1732	900	639	11301-04





VASCO Group nv
(Head Office)
Kruishoefstraat 50
B-3650 Dilsen
+32 (0)89 79 04 11
info@vasco.eu
www.vasco.eu

ARBONIA
climate



Download the **VASCO**
App Climate Control for
your customised indoor
climate regulation.



Follow us on
Facebook and **YouTube**.

