

Panel radiators



Are you looking for a clean pure look without a lot of frills? Then a radiator from the FlatLine collection is an excellent choice. The FlatLine radiator, with its flat front panel and beautiful finish with textured surface raises every contemporary interior to a higher level.

Another unique detail is that the FlatLine radiator has a **water-conducting flat front panel** that increases heat output. It can be effortlessly attached to **low temperature systems**.

VASCO panel radiators are not just ordinary radiators. The radiator and sheet-metal create a **sleek, beautifully finished product** that also contains unique heating technology.

It is a radiator concept that combines high efficiency with a compact volume. Vertical, horizontal or plinth, these are always discreet yet completely present in any home environment.

Panel radiators

FlatLine	246
Flat-V-Line	252
Flat-Plint-Line	254

FLATLINE (T21S, T22, T33)



All horizontal FlatLine radiators have the VASCO label in the top grille.

TYPES

- T21S, T22, T33

COLOURS

- Standard colour S600 (fine texture white)
- Not available in other colours

BRACKETS

- The radiator is standard delivered with a full assembly set: locked consoles (number depending on the length of the radiator), designer plugs, designer air vents, valve inserts

TECHNICAL

- Electrically welded by means of resistance welding robots (invisible weld seams)
- KTL priming coat, powder coating
- Standard operating pressure: 6 bar
- Maximum operating temperature: 110°C

ELECTRICAL

- ✗ Pure electrical radiator prefilled
- ✗ Mixed radiator

TECHNICAL DRAWINGS

- See p. 259

CONNECTION

- ✗ One-point connection for one-pipe system
- ✗ One-point connection for two-pipe system
- ✓ Two-point connection for one-pipe system (connection by way of the integrated valve) (see p. 312)
- ✓ Two-point connection for two-pipe system (standard) (see p. 312)
- ✓ Integrated valve **(no extra charge)** (see p. 314)
- Connections: 4x1/2" side (inner thread), 2x3/4" Euro cones (50mm bottom right) and 2x3/4" Euro cones (50mm centre)

FLATLINE

Top technology for superior heat output

Are you striving for a sincere, pure look without a lot of frills? Then FlatLine is the choice for you. It is extremely stylish in its timeless simplicity. With its flat front plate and the fantastic finish with textured paint it lifts every contemporary interior to a higher level. The direct contact between the front plate and the water channels results in a surprisingly high yield.

RECOMMENDED CONNECTION (0098) INTEGRATED VALVE

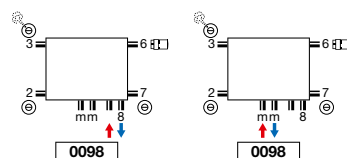

Other connection methods, see p. 258



ref. nr. 11823000000099
price € 147
Fittings, see p. 327

RECOMMENDED FOR BATHROOM AND KITCHEN IN OPTION



towel rail (LR)
ref. nr. see p. 257
price € 119

Other accessories, see p. 257



white
ref. nr. 11911630102
price € 44



chrome
ref. nr. 11911631102
price € 63



HOW TO ORDER FLATLINE T21S
 Delivery time 5 working days
 (transport duration not included)

FLATLINE (T21S)



T21S

2140040F

ref. nr. (8 characters)
 see table below

PRICE GROUP: VPG4 - PANEL RADIATORS A

REFERENCE CODE CUSTOM MADE FLATLINE T21S	TECHNICAL DATA									STANDARD COLOUR	
	tubes	width (L mm)	height (H mm)	75/65/20 (Watt) (Φ50K)	55/45/20 (Watt) (Φ30K)	n-exp.	weight (kg)	water content (l)	electr. resistance (Watt)	price S600 (€)	short ref. nr. S600 stock
108F2140040190	-	400	400	366	190	1,28	8,53	1,41	-	244	2140040F
108F2140060190	-	600	400	548	285	1,28	12,79	2,11	-	294	2140060F
108F2140080190	-	800	400	731	380	1,28	17,06	2,82	-	331	2140080F
108F2140100190	-	1000	400	914	475	1,28	21,32	3,52	-	386	2140100F
108F2140120190	-	1200	400	1097	570	1,28	25,58	4,22	-	430	2140120F
108F2140140190	-	1400	400	1280	665	1,28	29,85	4,93	-	481	2140140F
108F2140160190	-	1600	400	1462	761	1,28	34,11	5,63	-	520	2140160F
108F2140180190	-	1800	400	1645	856	1,28	38,38	6,34	-	584	2140180F
108F2140200190	-	2000	400	1828	951	1,28	42,64	7,04	-	650	2140200F
108F2140240190	-	2400	400	2194	1141	1,28	51,17	8,45	-	777	2140240F
108F2150040190	-	400	500	440	228	1,29	10,63	1,67	-	282	2150040F
108F2150060190	-	600	500	661	342	1,29	15,95	2,51	-	344	2150060F
108F2150080190	-	800	500	881	456	1,29	21,26	3,34	-	404	2150080F
108F2150100190	-	1000	500	1101	570	1,29	26,58	4,18	-	463	2150100F
108F2150120190	-	1200	500	1321	684	1,29	31,90	5,02	-	523	2150120F
108F2150140190	-	1400	500	1541	797	1,29	37,21	5,85	-	591	2150140F
108F2150160190	-	1600	500	1762	911	1,29	42,53	6,69	-	645	2150160F
108F2150180190	-	1800	500	1982	1025	1,29	47,84	7,52	-	702	2150180F
108F2150200190	-	2000	500	2202	1139	1,29	53,16	8,36	-	776	2150200F
108F2160040190	-	400	600	512	264	1,30	12,74	1,94	-	301	2160040F
108F2160060190	-	600	600	768	395	1,30	19,11	2,91	-	367	2160060F
108F2160080190	-	800	600	1024	527	1,30	25,48	3,88	-	439	2160080F
108F2160100190	-	1000	600	1280	659	1,30	31,85	4,85	-	510	2160100F
108F2160120190	-	1200	600	1536	791	1,30	38,22	5,82	-	584	2160120F
108F2160140190	-	1400	600	1792	922	1,30	44,59	6,79	-	633	2160140F
108F2160160190	-	1600	600	2048	1054	1,30	50,96	7,76	-	719	2160160F
108F2160180190	-	1800	600	2304	1186	1,30	57,33	8,73	-	813	2160180F
108F2170040190	-	400	700	581	297	1,31	14,91	2,21	-	301	2170040F
108F2170060190	-	600	700	871	446	1,31	22,36	3,32	-	399	2170060F
108F2170080190	-	800	700	1162	595	1,31	29,82	4,42	-	482	2170080F
108F2170100190	-	1000	700	1452	744	1,31	37,27	5,53	-	553	2170100F
108F2170120190	-	1200	700	1742	892	1,31	44,72	6,64	-	657	2170120F
108F2190040190	-	400	900	711	361	1,33	19,24	2,76	-	350	2190040F
108F2190060190	-	600	900	1067	541	1,33	28,86	4,14	-	447	2190060F
108F2190080190	-	800	900	1422	721	1,33	38,48	5,52	-	554	2190080F
108F2190100190	-	1000	900	1778	901	1,33	48,10	6,90	-	659	2190100F
108F2190120190	-	1200	900	2134	1082	1,33	57,72	8,28	-	791	2190120F

In conformity with EN442-1: 2014: radiators and convectors

For heat outputs in other regimes, see p. 320 (correction factors)
 EXPORT. Prices in Euro (excl. VAT)

VASCO

FLATLINE (T22)



T22

HOW TO ORDER FLATLINE T22
 Delivery time 5 working days
 (transport duration not included)

2230100F

ref. nr. (8 characters)
 see table below

PRICE GROUP: VPG4 - PANEL RADIATORS A

REFERENCE CODE CUSTOM MADE FLATLINE T22	TECHNICAL DATA									STANDARD COLOUR	
	tubes	width (L mm)	height (H mm)	75/65/20 (Watt) (φ50K)	55/45/20 (Watt) (φ30K)	n-exp.	weight (kg)	water content (l)	electr. resistance (Watt)	price S600 (€)	short ref. nr. S600 stock
108F2230100190	-	1000	300	900	463	1,30	18,60	3,00	-	413	2230100F
108F2230120190	-	1200	300	1080	556	1,30	22,32	3,60	-	458	2230120F
108F2230140190	-	1400	300	1260	649	1,30	26,04	4,20	-	510	2230140F
108F2230160190	-	1600	300	1440	741	1,30	29,76	4,80	-	553	2230160F
108F2230180190	-	1800	300	1620	834	1,30	33,48	5,40	-	607	2230180F
108F2230200190	-	2000	300	1800	927	1,30	37,20	6,00	-	640	2230200F
108F2230220190	-	2200	300	1980	1019	1,30	40,92	6,60	-	708	2230220F
108F2230240190	-	2400	300	2160	1112	1,30	44,64	7,20	-	769	2230240F
108F2240060190	-	600	400	694	356	1,31	14,88	2,17	-	352	2240060F
108F2240080190	-	800	400	926	474	1,31	19,84	2,90	-	413	2240080F
108F2240100190	-	1000	400	1157	593	1,31	24,80	3,62	-	476	2240100F
108F2240120190	-	1200	400	1388	711	1,31	29,76	4,34	-	537	2240120F
108F2240140190	-	1400	400	1620	830	1,31	34,72	5,07	-	575	2240140F
108F2240160190	-	1600	400	1851	948	1,31	39,68	5,79	-	656	2240160F
108F2240180190	-	1800	400	2083	1067	1,31	44,64	6,52	-	737	2240180F
108F2240200190	-	2000	400	2314	1185	1,31	49,60	7,24	-	820	2240200F
108F2240220190	-	2200	400	2545	1304	1,31	54,56	7,96	-	903	2240220F
108F2240240190	-	2400	400	2777	1422	1,31	59,52	8,69	-	983	2240240F
108F2240260190	-	2600	400	3008	1541	1,31	64,48	9,41	-	1027	2240260F
108F2240300190	-	3000	400	3471	1778	1,31	74,40	10,86	-	1233	2240300F
108F2250040190	-	400	500	562	288	1,31	12,40	1,69	-	312	2250040F
108F2250060190	-	600	500	842	431	1,31	18,60	2,54	-	386	2250060F
108F2250080190	-	800	500	1123	575	1,31	24,80	3,38	-	461	2250080F
108F2250100190	-	1000	500	1404	719	1,31	31,00	4,23	-	543	2250100F
108F2250120190	-	1200	500	1685	863	1,31	37,20	5,08	-	620	2250120F
108F2250140190	-	1400	500	1966	1007	1,31	43,40	5,92	-	693	2250140F
108F2250160190	-	1600	500	2246	1150	1,31	49,60	6,77	-	791	2250160F
108F2250180190	-	1800	500	2527	1294	1,31	55,80	7,61	-	890	2250180F
108F2250200190	-	2000	500	2808	1438	1,31	62,00	8,46	-	990	2250200F
108F2250220190	-	2200	500	3089	1582	1,31	68,20	9,31	-	1085	2250220F
108F2250240190	-	2400	500	3370	1726	1,31	74,40	10,15	-	1183	2250240F
108F2250260190	-	2600	500	3650	1869	1,31	80,60	11,00	-	1236	2250260F
108F2260040190	-	400	600	657	336	1,31	14,88	1,94	-	344	2260040F
108F2260060190	-	600	600	985	505	1,31	22,32	2,91	-	429	2260060F
108F2260080190	-	800	600	1314	673	1,31	29,76	3,88	-	518	2260080F
108F2260100190	-	1000	600	1642	841	1,31	37,20	4,85	-	575	2260100F
108F2260120190	-	1200	600	1970	1009	1,31	44,64	5,82	-	690	2260120F
108F2260140190	-	1400	600	2299	1177	1,31	52,08	6,79	-	804	2260140F
108F2260160190	-	1600	600	2627	1345	1,31	59,52	7,76	-	921	2260160F
108F2260180190	-	1800	600	2956	1514	1,31	66,96	8,73	-	1033	2260180F
108F2260200190	-	2000	600	3284	1682	1,31	74,40	9,70	-	1148	2260200F
108F2260220190	-	2200	600	3612	1850	1,31	81,84	10,67	-	1261	2260220F
108F2260240190	-	2400	600	3941	2018	1,31	89,28	11,64	-	1377	2260240F

In conformity with EN442-1: 2014: radiators and convectors

For heat outputs in other regimes, see p. 320 (correction factors)
 EXPORT. Prices in Euro (excl. VAT)



HOW TO ORDER FLATLINE T22
 Delivery time 5 working days
 (transport duration not included)

FLATLINE (T22)



T22

ref. nr. (8 characters)
 see table below

2230100F

PRICE GROUP: VPG4 - PANEL RADIATORS A

REFERENCE CODE CUSTOM MADE FLATLINE T22	TECHNICAL DATA									STANDARD COLOUR	
	tubes	width (L mm)	height (H mm)	75/65/20 (Watt) (Φ50K)	55/45/20 (Watt) (Φ30K)	n-exp.	weight (kg)	water content (l)	electr. resistance (Watt)	price S600 (€)	short ref. nr. S600 stock
108F2270040190	-	400	700	749	383	1,31	17,49	2,21	-	355	2270040F
108F2270060190	-	600	700	1123	575	1,31	26,24	3,31	-	461	2270060F
108F2270080190	-	800	700	1498	767	1,31	34,98	4,42	-	573	2270080F
108F2270100190	-	1000	700	1872	959	1,31	43,73	5,52	-	677	2270100F
108F2270120190	-	1200	700	2246	1150	1,31	52,48	6,62	-	777	2270120F
108F2270140190	-	1400	700	2621	1342	1,31	61,22	7,73	-	910	2270140F
108F2270160190	-	1600	700	2995	1534	1,31	69,97	8,83	-	1038	2270160F
108F2270180190	-	1800	700	3370	1726	1,31	78,71	9,94	-	1173	2270180F
108F2290040190	-	400	900	925	474	1,31	22,72	2,74	-	411	2290040F
108F2290060190	-	600	900	1387	710	1,31	34,08	4,11	-	537	2290060F
108F2290080190	-	800	900	1850	947	1,31	45,44	5,48	-	663	2290080F
108F2290100190	-	1000	900	2312	1184	1,31	56,80	6,85	-	793	2290100F
108F2290120190	-	1200	900	2774	1421	1,31	68,16	8,22	-	950	2290120F
108F2290140190	-	1400	900	3237	1658	1,31	79,52	9,59	-	1112	2290140F

In conformity with EN442-1: 2014: radiators and convectors

For heat outputs in other regimes, see p. 320 (correction factors)
 EXPORT. Prices in Euro (excl. VAT)

FLATLINE (T33)



T33

HOW TO ORDER FLATLINE T33
 Delivery time 5 working days
 (transport duration not included)

3330100F

ref. nr. (8 characters)
 see table below

PRICE GROUP: VPG4 - PANEL RADIATORS A

REFERENCE CODE CUSTOM MADE FLATLINE T33	TECHNICAL DATA									STANDARD COLOUR	
	tubes	width (L mm)	height (H mm)	75/65/20 (Watt) (Φ50K)	55/45/20 (Watt) (Φ30K)	n-exp.	weight (kg)	water content (l)	electr. resistance (Watt)	price S600 (€)	short ref. nr. S600 stock
108F3330100190	-	1000	300	1300	669	1,30	26,35	4,65	-	509	3330100F
108F3330120190	-	1200	300	1560	803	1,30	31,62	5,58	-	546	3330120F
108F3330140190	-	1400	300	1820	937	1,30	36,89	6,51	-	636	3330140F
108F3330160190	-	1600	300	2080	1071	1,30	42,16	7,44	-	725	3330160F
108F3330180190	-	1800	300	2340	1205	1,30	47,43	8,37	-	818	3330180F
108F3330200190	-	2000	300	2600	1338	1,30	52,70	9,30	-	909	3330200F
108F3330220190	-	2200	300	2860	1472	1,30	57,97	10,23	-	999	3330220F
108F3330240190	-	2400	300	3120	1606	1,30	63,24	11,16	-	1089	3330240F
108F3330300190	-	3000	300	3900	2008	1,30	79,05	13,95	-	1364	3330300F
108F3340080190	-	800	400	1329	684	1,30	28,24	4,42	-	518	3340080F
108F3340100190	-	1000	400	1661	855	1,30	35,30	5,53	-	597	3340100F
108F3340120190	-	1200	400	1993	1026	1,30	42,36	6,64	-	697	3340120F
108F3340140190	-	1400	400	2325	1197	1,30	49,42	7,74	-	813	3340140F
108F3340160190	-	1600	400	2658	1368	1,30	56,48	8,85	-	930	3340160F
108F3340180190	-	1800	400	2990	1539	1,30	63,54	9,95	-	1045	3340180F
108F3340200190	-	2000	400	3322	1710	1,30	70,60	11,06	-	1162	3340200F
108F3340220190	-	2200	400	3654	1881	1,30	77,66	12,17	-	1278	3340220F
108F3340240190	-	2400	400	3986	2052	1,30	84,72	13,27	-	1395	3340240F
108F3340300190	-	3000	400	4983	2565	1,30	105,90	16,59	-	1738	3340300F
108F3350060190	-	600	500	1202	619	1,30	26,55	3,85	-	436	3350060F
108F3350080190	-	800	500	1602	825	1,30	35,40	5,14	-	591	3350080F
108F3350100190	-	1000	500	2003	1031	1,30	44,25	6,42	-	702	3350100F
108F3350120190	-	1200	500	2404	1237	1,30	53,10	7,70	-	837	3350120F
108F3350140190	-	1400	500	2804	1443	1,30	61,95	8,99	-	980	3350140F
108F3350160190	-	1600	500	3205	1650	1,30	70,80	10,27	-	1119	3350160F
108F3350180190	-	1800	500	3605	1856	1,30	79,65	11,56	-	1257	3350180F
108F3350200190	-	2000	500	4006	2062	1,30	88,50	12,84	-	1397	3350200F
108F3350220190	-	2200	500	4407	2268	1,30	97,35	14,12	-	1538	3350220F
108F3350240190	-	2400	500	4807	2475	1,30	106,20	15,41	-	1675	3350240F
108F3360060190	-	600	600	1396	719	1,30	31,92	4,38	-	540	3360060F
108F3360080190	-	800	600	1862	958	1,30	42,56	5,84	-	671	3360080F
108F3360100190	-	1000	600	2327	1198	1,30	53,20	7,30	-	813	3360100F
108F3360120190	-	1200	600	2792	1437	1,30	63,84	8,76	-	975	3360120F
108F3360140190	-	1400	600	3258	1677	1,30	74,48	10,22	-	1137	3360140F
108F3360160190	-	1600	600	3723	1917	1,30	85,12	11,68	-	1298	3360160F
108F3360180190	-	1800	600	4189	2156	1,30	95,76	13,14	-	1460	3360180F
108F3360200190	-	2000	600	4654	2396	1,30	106,40	14,60	-	1621	3360200F
108F3370060190	-	600	700	1582	814	1,30	34,24	4,68	-	584	3370060F
108F3370080190	-	800	700	2110	1086	1,30	45,66	6,24	-	736	3370080F
108F3370100190	-	1000	700	2637	1357	1,30	57,07	7,80	-	921	3370100F
108F3370120190	-	1200	700	3164	1629	1,30	68,48	9,36	-	1197	3370120F
108F3370140190	-	1400	700	3692	1900	1,30	79,90	10,92	-	1378	3370140F

In conformity with EN442-1: 2014: radiators and convectors

For heat outputs in other regimes, see p. 320 (correction factors)
 EXPORT. Prices in Euro (excl. VAT)

HOW TO ORDER FLATLINE T33
 Delivery time 5 working days
 (transport duration not included)

FLATLINE (T33)



T33

ref. nr. (8 characters)
 see table below

3330100F

PRICE GROUP: VPG4 - PANEL RADIATORS A

REFERENCE CODE CUSTOM MADE FLATLINE T33	TECHNICAL DATA									STANDARD COLOUR	
	tubes	width (L mm)	height (H mm)	75/65/20 (Watt) (Φ50K)	55/45/20 (Watt) (Φ30K)	n-exp.	weight (kg)	water content (l)	electr. resistance (Watt)	price S600 (€)	short ref. nr. S600 stock
108F3390040190	-	400	900	1286	662	1,30	25,92	3,52	-	449	3390040F
108F3390060190	-	600	900	1930	993	1,30	38,88	5,28	-	674	3390060F
108F3390080190	-	800	900	2573	1324	1,30	51,84	7,04	-	900	3390080F
108F3390100190	-	1000	900	3216	1655	1,30	64,80	8,80	-	1122	3390100F
108F3390120190	-	1200	900	3859	1987	1,30	77,76	10,56	-	1348	3390120F
108F3390140190	-	1400	900	4502	2318	1,30	90,72	12,32	-	1573	3390140F
108F3390160190	-	1600	900	5146	2649	1,30	103,68	14,08	-	1795	3390160F

In conformity with EN442-1: 2014: radiators and convectors

For heat outputs in other regimes, see p. 320 (correction factors)
 EXPORT. Prices in Euro (excl. VAT)

FLAT-V-LINE (T21S, T22)



TYPES

- T21S, T22

COLOURS

- Standard colour S600 (fine texture white)
- Not available in other colours

BRACKETS

- The radiator is standard delivered with a full assembly set: consoles (J), designer plugs, designer air vents

TECHNICAL

- Electrically welded by means of resistance welding robots (invisible weld seams)
- KTL priming coat, powder coating
- Standard operating pressure: 10 bar
- Maximum operating temperature: 110°C

ELECTRICAL

- ✗ Pure electrical radiator prefilled
- ✗ Mixed radiator

TECHNICAL DRAWINGS

- See p. 259

CONNECTION

- ✗ One-point connection for one-pipe system
- ✗ One-point connection for two-pipe system
- ✓ Two-point connection for one-pipe system (connection by way of the central connection) (see p. 312)
- ✓ Two-point connection for two-pipe system (standard) (see p. 312)
- ✗ Integrated valve
- Connections: 4x1/2" (1-8-4-5) (inner thread), 2x3/4" Euro cones (50mm centre)



RECOMMENDED CONNECTION (8008)

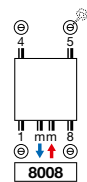

Other connection methods, see p. 258

RECOMMENDED FOR BATHROOM AND KITCHEN IN OPTION



towel rail
ref. nr. see p. 257
price €119

Other accessories, see p. 257

FLAT-V-LINE

Stylish and highly qualitative

Its synthesis of simplicity, efficiency and aesthetics, enhanced by the smart, fixed middle connector, allows this designer radiator panel to blend harmoniously into any living and working space. It has a specially designed towel rail for bathroom and kitchen.



ref. nr. 118230200000099
price €147
Fittings, see p. 327



white
ref. nr. 11911630102
price €44



chrome
ref. nr. 11911631102
price €63



HOW TO ORDER FLAT-V-LINE

Delivery time 15 - 30 working days
(transport duration not included)

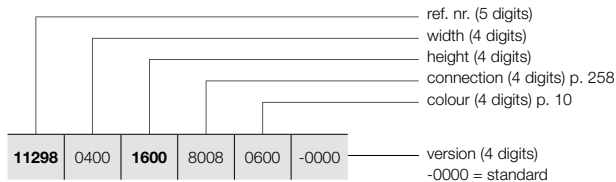

FLAT-V-LINE (T21S, T22)

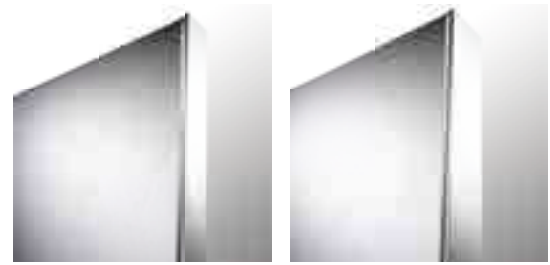

T21S

T22

HOW TO ORDER STOCK RADIATOR FLAT-V-LINE

Delivery time 5 working days
(transport duration not included)

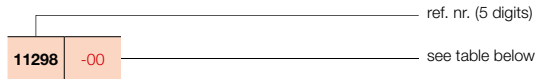

PRICE GROUP: VPG4 - PANEL RADIATORS A

REFERENCE CODE CUSTOM MADE FLAT-V-LINE	TECHNICAL DATA									STANDARD COLOUR	
	tubes	width (L mm)	height (H mm)	75/65/20 (Watt) (Ø50K)	55/45/20 (Watt) (Ø30K)	n-exp.	weight (kg)	water content (l)	electr. resistance (Watt)	price S600 (€)	short ref. nr. S600 stock
REF. NR. FLAT-V-LINE T21S : 11298											
11298 0400 1600 8008 0600 -0000	-	400	1600	1047	531	1,33	35,35	6,38	-	842	11298-07
	-	400	1800	1120	562	1,35	39,34	7,15	-	881	11298-01
	-	400	2000	1198	598	1,36	43,34	7,93	-	911	11298-02
	-	400	2200	1283	609	1,46	46,84	8,70	-	992	-
11298 0500 1600 8008 0600 -0000	-	500	1600	1309	664	1,33	44,19	7,98	-	927	-
	-	500	1800	1400	703	1,35	49,18	8,94	-	967	11298-03
	-	500	2000	1498	748	1,36	54,18	9,91	-	1036	11298-04
	-	500	2200	1604	761	1,46	58,55	10,88	-	1109	-
11298 0600 1600 8008 0600 -0000	-	600	1600	1571	796	1,33	53,03	9,58	-	1027	-
	-	600	1800	1680	843	1,35	59,02	10,73	-	1076	11298-05
	-	600	2000	1798	898	1,36	65,02	11,89	-	1159	11298-06
	-	600	2200	1925	913	1,46	70,26	13,06	-	1230	-
11298 0700 1600 8008 0600 -0000	-	700	1600	1833	929	1,33	61,87	11,17	-	1122	-
	-	700	1800	1960	984	1,35	68,85	12,52	-	1195	-
	-	700	2000	2097	1047	1,36	75,85	13,87	-	1275	-
	-	700	2200	2246	1065	1,46	81,97	15,23	-	1378	-
11298 0800 1600 8008 0600 -0000	-	800	1600	2094	1062	1,33	70,70	12,77	-	1268	-
	-	800	1800	2240	1124	1,35	78,69	14,30	-	1348	-
	-	800	2000	2397	1197	1,36	86,69	15,86	-	1462	-
	-	800	2200	2566	1218	1,46	93,68	17,41	-	1524	-
REF. NR. FLAT-V-LINE T22 : 11299											
11299 0400 1600 8008 0600 -0000	-	400	1600	1281	626	1,40	39,86	6,38	-	939	-
	-	400	1800	1394	668	1,44	43,79	7,15	-	1033	11299-01
	-	400	2000	1509	708	1,48	47,72	7,93	-	1111	11299-02
	-	400	2200	1626	816	1,35	52,08	8,70	-	1195	-
11299 0500 1600 8008 0600 -0000	-	500	1600	1601	783	1,40	49,83	7,98	-	1021	-
	-	500	1800	1743	836	1,44	54,74	8,94	-	1120	11299-03
	-	500	2000	1886	886	1,48	59,65	9,91	-	1231	11299-04
	-	500	2200	2032	1020	1,35	65,10	10,88	-	1322	-
11299 0600 1600 8008 0600 -0000	-	600	1600	1921	940	1,40	59,80	9,58	-	1129	-
	-	600	1800	2092	1003	1,44	65,69	10,73	-	1236	11299-05
	-	600	2000	2263	1063	1,48	71,58	11,89	-	1349	11299-06
	-	600	2200	2438	1223	1,35	78,12	13,06	-	1439	-
11299 0700 1600 8008 0600 -0000	-	700	1600	2241	1096	1,40	69,76	11,17	-	1239	-
	-	700	1800	2440	1170	1,44	76,64	12,52	-	1354	11299-07
	-	700	2000	2640	1240	1,48	83,51	13,87	-	1476	11299-08
	-	700	2200	2845	1427	1,35	91,14	15,23	-	1557	-
11299 0800 1600 8008 0600 -0000	-	800	1600	2562	1253	1,40	79,73	12,77	-	1354	-
	-	800	1800	2789	1337	1,44	87,58	14,30	-	1492	-
	-	800	2000	3018	1417	1,48	95,44	15,86	-	1620	11299-09
	-	800	2200	3251	1631	1,35	104,16	17,41	-	1696	11299-10

VASCO

FLAT-PLINT-LINE (T22, T33)



TYPES

- T22, T33

COLOURS

- Standard colour S600 (fine texture white)
- Not available in other colours

BRACKETS

- To be ordered separately, not included in the price of the radiator
- Valve insert (M30 x 1,5) standard delivered

TECHNICAL

- Electrically welded by means of resistance welding robots (invisible weld seams)
- KTL priming coat, powder coating
- Standard operating pressure: 10 bar
- Maximum operating temperature: 110°C

ELECTRICAL

- ✗ Pure electrical radiator prefilled
- ✗ Mixed radiator

TECHNICAL DRAWINGS

- See p. 260

CONNECTION

- ✗ One-point connection for one-pipe system
- ✗ One-point connection for two-pipe system
- ✓ Two-point connection for one-pipe system (connection by way of the integrated valve) (see p. 312)
- ✓ Two-point connection for two-pipe system (standard) (see p. 312)
- ✓ Integrated valve **(no extra charge)** (see p. 314)
- Connections: 4x1/2" side (inner thread), 2x3/4" Euro cones (50mm bottom right) and 2x3/4" Euro cones (50mm centre)

FLAT-PLINT-LINE

Extremely flexible

The VASCO Flat-Plint-Line is a horizontal plinth panel radiator with a decorative surface front panel, side panels and designer line grid. This combines a superior heat supply with futuristic technology and stylish appearance.

RECOMMENDED CONNECTION (8008) INTEGRATED VALVE

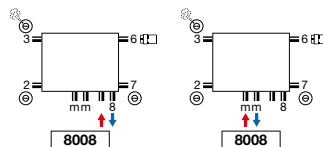

Other connection methods, see p. 258



ref. nr. 11823000000099
price €147
Fittings, see p. 327



white
ref. nr. 11911630102
price €44



chrome
ref. nr. 11911631102
price €63



HOW TO ORDER FLAT-PLINT-LINE

Delivery time 30 working days
(transport duration not included)

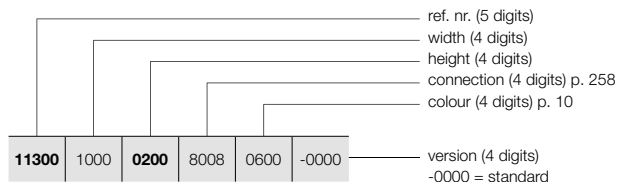

WALL BRACKET / TELESCOPIC FLOOR BRACKETS

See p. 256 for additional accessories.

HOW TO ORDER STOCK RADIATOR FLAT-PLINT-LINE

Delivery time 5 working days
(transport duration not included)

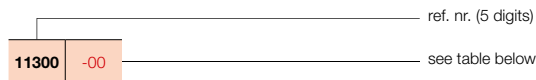

FLAT-PLINT-LINE (T22, T33)



T22

T33

PRICE GROUP: VPG4 - PANEL RADIATORS A

REFERENCE CODE CUSTOM MADE FLAT-PLINT-LINE	TECHNICAL DATA										STANDARD COLOUR	
	tubes	width (L mm)	height (H mm)	75/65/20 (Watt) (φ50K)	55/45/20 (Watt) (φ30K)	n-exp.	weight (kg)	water content (l)	electr. resistance (Watt)	price S600 (€)	short ref. nr. S600 stock	
REF. NR. FLAT-PLINT-LINE T22 : 11300												
11300 1000 0200 8008 0600 -0000	-	1000	200	605	313	1,29	12,90	2,55	-	347	11300-01	
11300 1200 0200 8008 0600 -0000	-	1200	200	726	376	1,29	15,48	3,06	-	384	11300-02	
11300 1400 0200 8008 0600 -0000	-	1400	200	847	438	1,29	18,06	3,57	-	425	-	
11300 1600 0200 8008 0600 -0000	-	1600	200	968	501	1,29	20,64	4,08	-	455	11300-03	
11300 1800 0200 8008 0600 -0000	-	1800	200	1089	563	1,29	23,22	4,59	-	474	-	
11300 2000 0200 8008 0600 -0000	-	2000	200	1210	626	1,29	25,80	5,10	-	494	11300-04	
11300 2200 0200 8008 0600 -0000	-	2200	200	1331	689	1,29	28,38	5,61	-	537	-	
11300 2400 0200 8008 0600 -0000	-	2400	200	1452	751	1,29	30,96	6,12	-	575	-	
11300 2600 0200 8008 0600 -0000	-	2600	200	1573	814	1,29	33,54	6,63	-	619	-	
11300 3000 0200 8008 0600 -0000	-	3000	200	1815	939	1,29	38,70	7,65	-	685	-	
REF. NR. FLAT-PLINT-LINE T33 : 11301												
11301 1000 0200 8008 0600 -0000	-	1000	200	866	450	1,28	18,25	3,80	-	440	11301-01	
11301 1200 0200 8008 0600 -0000	-	1200	200	1039	540	1,28	21,90	4,56	-	492	11301-02	
11301 1400 0200 8008 0600 -0000	-	1400	200	1212	630	1,28	25,55	5,32	-	540	-	
11301 1600 0200 8008 0600 -0000	-	1600	200	1386	720	1,28	29,20	6,08	-	580	11301-03	
11301 1800 0200 8008 0600 -0000	-	1800	200	1559	810	1,28	32,85	6,84	-	605	-	
11301 2000 0200 8008 0600 -0000	-	2000	200	1732	900	1,28	36,50	7,60	-	639	11301-04	
11301 2200 0200 8008 0600 -0000	-	2200	200	1905	990	1,28	40,15	8,36	-	695	-	
11301 2400 0200 8008 0600 -0000	-	2400	200	2078	1080	1,28	43,80	9,12	-	749	-	
11301 2600 0200 8008 0600 -0000	-	2600	200	2252	1170	1,28	47,45	9,88	-	804	-	
11301 3000 0200 8008 0600 -0000	-	3000	200	2598	1350	1,28	54,75	11,40	-	908	-	

In conformity with EN442-1: 2014: radiators and convectors

For heat outputs in other regimes, see p. 320 (correction factors)
EXPORT. Prices in Euro (excl. VAT)

PANEL RADIATORS BRACKETS / FREE-STANDING INSTALLATION
IN OPTION

PRICE GROUP: VPG10 - ACC.

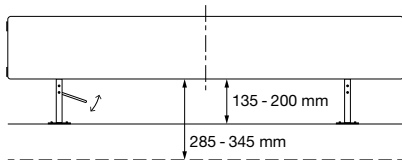

FREE-STANDING INSTALLATION	WIDTH RADIATOR		REF. NR.	€
FLAT-PLINT-LINE				
WALL BRACKETS	< 1600 mm (set of 2 pieces)		1189 002 0200 0000	23
	1600-2400 mm (set of 3 pieces)		1189 003 0200 0000	29
	> 2400 mm (set of 4 pieces)		1189 004 0200 0000	38
FLAT-PLINT-LINE				
TELESCOPIC FLOOR BRACKETS	≤ 1200 mm (set of 2 pieces)	concrete floor (height 285 - 345 mm)	1189 122 0000 0000	165
		finished floor (height 135 - 200 mm)	1189 112 0000 0000	165
	> 1200 mm (set of 3 pieces)	concrete floor (height 285 - 345 mm)	1189 123 0000 0000	218
finished floor (height 135 - 200 mm)		1189 113 0000 0000	218	





EXPORT. Prices in Euro (excl. VAT)

PANEL RADIATORS ACCESSORIES
IN OPTION

PRICE GROUP: VPG10 - ACC.

ACCESSORIES		COLOUR	REF. NR.	€
THERMOSTATIC HEAD		FLATLINE / FLAT-V-LINE / FLAT-PLINT-LINE		
		WHITE	11911630102	44
THERMOSTATIC HEAD		FLATLINE / FLAT-V-LINE / FLAT-PLINT-LINE		
		CHROME	11911631102	63

PRICE GROUP: VPG10B - TOWEL RAILS

ACCESSORIES		WIDTH TOWEL RAIL	COLOUR	REF. NR.	€
TOWEL RAIL (LR)		FLATLINE			
		500 mm	CHROME	11911988050	119
		600 mm	CHROME	11911988060	127
		700 mm	CHROME	11911988070	135
		800 mm	CHROME	11911988080	141
TOWEL RAIL (MM) DISCONTINUED ITEM		FLATLINE			
		700 mm	CHROME	11911989070	141
TOWEL RAIL		FLAT-V-LINE			
		400 mm	CHROME	11832520000099	111
		500 mm	CHROME	11832530000099	119
		600 mm	CHROME	11832540000099	127
		700 mm	CHROME	11832550000099	135
		800 mm	CHROME	11832560000099	141

Mounting instructions accessories: see www.vasco.eu
EXPORT. Prices in Euro (excl. VAT)

available from stock

PANEL RADIATORS CONNECTIONS

FLATLINE: T21S / T22 / T33

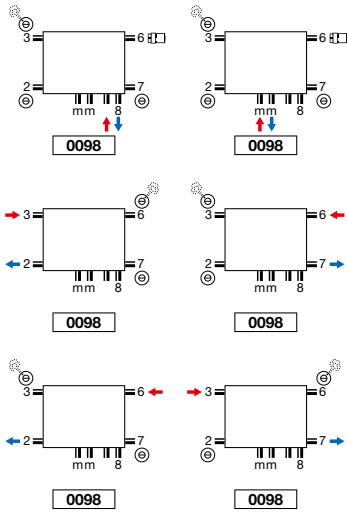

- Thermostatic head only to use with connection on the valve (supply left, return right). Other connections, eg. 23, take thermostatic head out of connection 6. Here the possibility to change the supply and the return.
- Integrated valve: no extra charge (see p. 314)

FLAT-V-LINE: T21S / T22

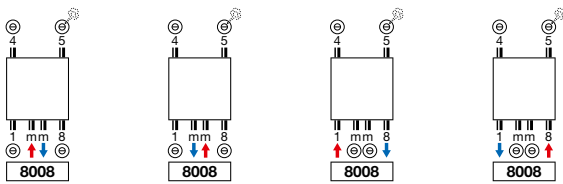

- Connection at the top not possible.

FLAT-PLINT-LINE: T22 / T33

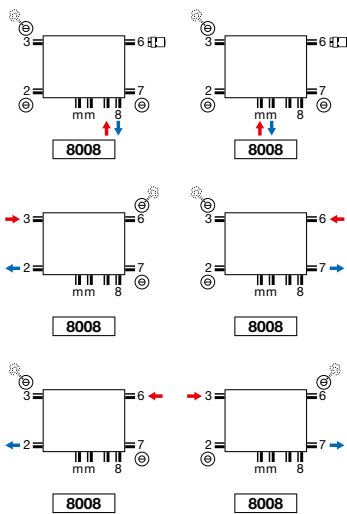

- Thermostatic head only to use with connection on the valve (supply left, return right). Other connections, eg. 23, take thermostatic head out of connection 6. Here the possibility to change the supply and the return.
- Integrated valve: no extra charge (see p. 314)

Attention: connecting the radiator can only be as shown by the connecting icons. For any other connection method, we take no responsibility.

FLATLINE (T21S, T22, T33)

TOP VIEW

T21S

T22

T33

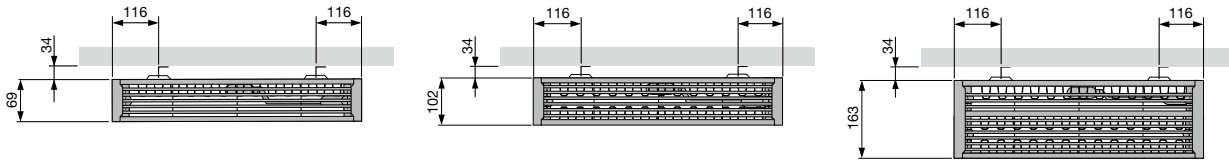

SIDE VIEW

T21S

T22

T33

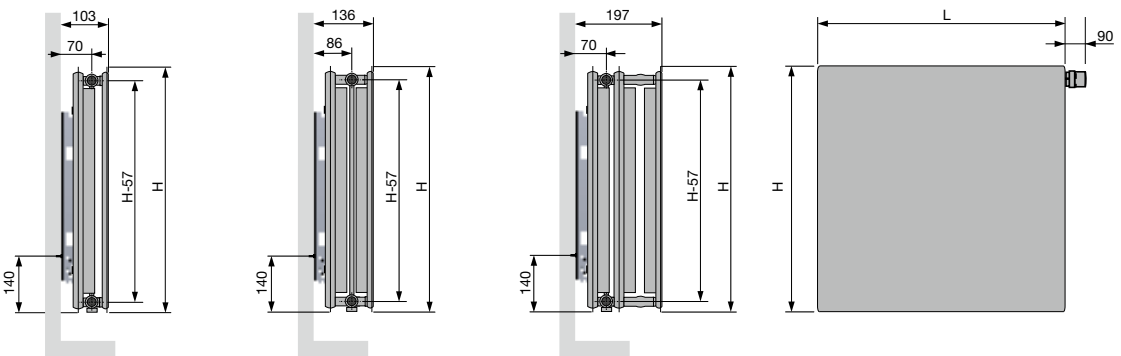

BOTTOM VIEW

T21S

T22

T33

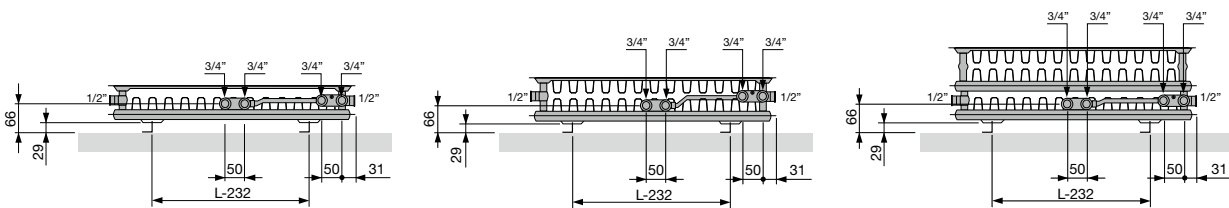

FLAT-V-LINE (T21S / T22)

SIDE VIEW

T21S

T22

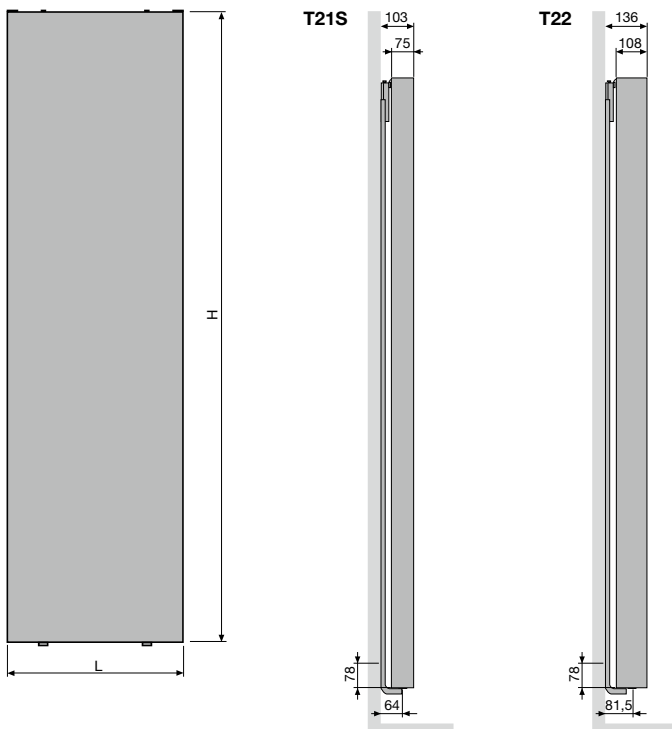

TOP VIEW

T21S

T22

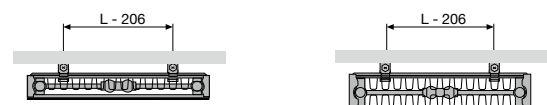

BOTTOM VIEW

T21S

T22



FLAT-PLINT-LINE (T22 / T33)

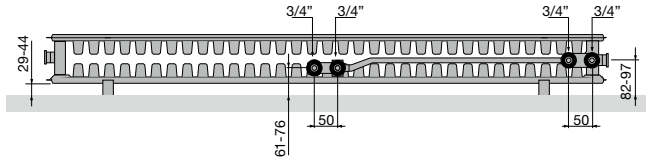

T22 | Bottom view



T22 | Top view

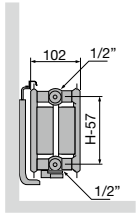

T22 | Side view

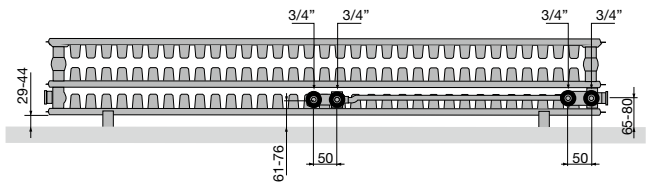
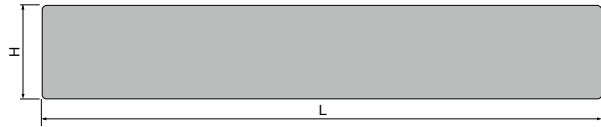

T33 | Bottom view



T33 | Top view

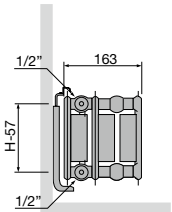

T33 | Side view

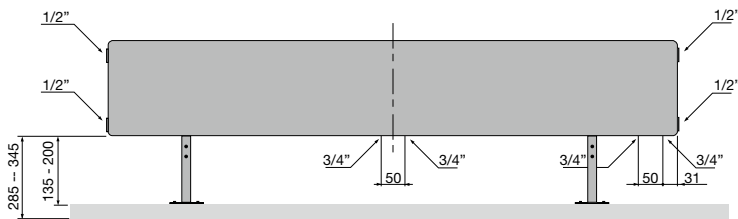
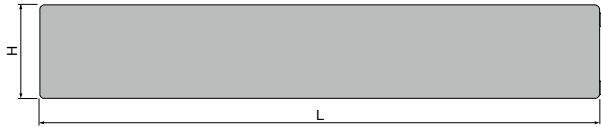



VASCO