

Steel radiators



VASCO steel radiators combine an optimal heat comfort with a thoughtful, timeless design.

Every collection is a unique demonstration of warmth at its most efficient and at its best.

Customised to suit any living space. Suitable for any application. Masterpieces of technical ingenuity and creativity, awarded multiple international design awards.

Experienced technicians, innovative designers and scientific specialists together create solutions in which the details make all the difference.

Steel radiators that constantly set themselves apart by their pure design and ease of use.

Steel radiators

Niva	132
Niva Fan Coil Unit	144
Carré	154
Arche	172
Zana	179
Viola-A	192
Tulipa-A	226



NIVA BATH

Heat up your bathroom in style

How do you make a bathroom radiator just that little bit more than a stylish heat source? VASCO has the answer with the new Niva Bath! Inspired by the successful Niva radiator, the new Niva Bath stands further back from the wall (at a distance of 325 mm). Allowing more space at the rear of the radiator for additional functionality such as shelves for towels. Niva Bath is available in 55 colours and the shelves come standard in black (RAL 9005), or white (S600).

TYPES

- Single, N1L1 and NS1L1 (Soft)

COLOURS

- Standard colour S600 (fine texture white) (RAL 9016: no extra charge 15%)
- Extensive colour chart see p. 10

SPECIAL

- The Niva Vertical Lacquered is available with a lacquered front plate (this means steel plate radiator + lacquered front plate).

BRACKETS

- Wall brackets in the colour RAL 7016 (anthracite grey) standard in the packaging of the radiator (not to use for Niva Bath version). **Niva Bath accessory to be ordered separately: RAL 9005 or S600.**
- Includes 3 shelves (steel) and stainless steel coat rack support (telescopic).
- The bottom shelf is fixed, the other 2 shelves can be mounted to your choice or not.

TECHNICAL

- Electrically welded by means of resistance welding robots (invisible weld seams)
- KTL priming coat, powder coating
- Standard operating pressure: 10 bar
- Maximum operating temperature: 110°C

ELECTRICAL

- ✗ Pure electrical radiator prefilled
- ✗ Mixed radiator

TECHNICAL DRAWINGS

- See p. 150

CONNECTION

- ✗ One-point connection for one-pipe system
- ✗ One-point connection for two-pipe system
- ✓ Two-point connection for one-pipe system (connection by way of the central connection) (see p. 312)
- ✓ Two-point connection for two-pipe system (standard) (see p. 312)
- ✗ Integrated valve
- Connections: ½" (inner thread)

RECOMMENDED CONNECTION (1188)

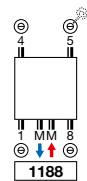

Other connection methods, see p. 149

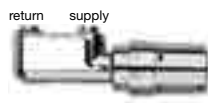

ref. nr. 1182 103 0000 0099

price € 218

Fittings, see p. 327

RECOMMENDED FOR BATHROOM AND KITCHEN (N1L1) IN OPTION



towel rail (chrome)
ref. nr. see p. 146
price € 187



HOW TO ORDER NIVA BATH

Delivery time 15 - 30 working days
(transport duration not included)

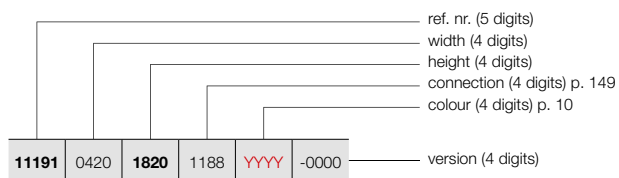

NIVA BATH (N1L1, NS1L1)

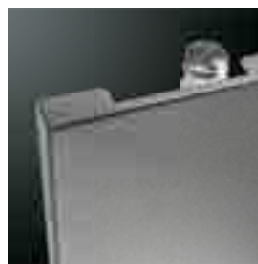

N1L1



NS1L1

HOW TO ORDER STOCK RADIATOR NIVA BATH

Delivery time 5 working days
(transport duration not included)

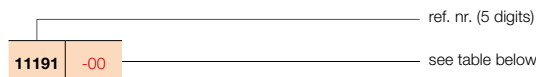

PRICE GROUP: VPG2 - STEEL DESIGN RADIATORS

REFERENCE CODE CUSTOM MADE NIVA	TECHNICAL DATA											STANDARD COLOUR		OTHER COLOURS				
	tubes	width (L mm)	height (H mm)	75/65/20 (Watt) (φ50K)	55/45/20 (Watt) (φ30K)	n-exp.	weight (kg)	water content (l)	electr. resistance (Watt)	price S600* (€)	short ref. nr. S600 stock	price colour (€)	short ref. nr. M301 stock					
REF. NR. NIVA VERTICAL LACQUERED N1L1 : 11191																		
11191	0420	1820	1188	YYY	-0000	-	420	1820	934	486	1,28	27,35	3,70	-	597	11191-03	687	11191-05
		2020				-	420	2020	1023	532	1,28	30,20	4,00	-	632	11191-06	727	-
REF. NR. NIVA SOFT VERTICAL NS1L1 : 11197																		
11197	0440	1820	1188	YYY	-0000	-	440	1820	934	486	1,28	27,35	3,70	-	597	11197-07	687	-
		2020				-	440	2020	1023	532	1,28	30,20	4,00	-	632	11197-08	727	-

In conformity with EN442-1: 2014: radiators and convectors

* RAL 9016: no extra charge 15%

For heat outputs in other regimes, see p. 320 (correction factors)
EXPORT. Prices in Euro (excl. VAT)

PRICE GROUP: VPG10B - TOWEL RAILS

NIVA BATH ACCESSORY (COAT RACK SUPPORT AND 3 SHELVES) TO BE ORDERED SEPARATELY IN COLOUR WHITE OR BLACK

HOW TO ORDER

1. Choose the model of radiator.
2. Choose the Niva Bath accessory in the colour S600 (fine texture white) or in RAL 9005 (Jet Black).

TOTAL PRICE RADIATOR NIVA BATH = PRICE RADIATOR + PRICE ACCESSORY.

	height radiator	colour	ref. nr.	price €
NIVA BATH	1820 mm	S600	1183 803 1820 0600	334
		RAL 9005 ^S	1183 803 1820 9005	334
	2020 mm	S600	1183 803 2020 0600	350
		RAL 9005 ^S	1183 803 2020 9005	350

^S structure black



NIVA VERTICAL LACQUERED (N1L1, N2L1)



TYPES

- Single (N1L1) and double (N2L1)

COLOURS

- Standard colour S600 (fine texture white) (RAL 9016: no extra charge 15%)
- Extensive colour chart see p. 10

SPECIAL

- The Niva Vertical Lacquered is available with a lacquered front plate (this means steel plate radiator + lacquered front plate).

BRACKETS

- Wall brackets in the colour RAL 7016 (anthracite grey) standard. Also in option available in the colour S600 (see p. 146).

TECHNICAL

- Electrically welded by means of resistance welding robots (invisible weld seams)
- KTL priming coat, powder coating
- Standard operating pressure: 10 bar
- Maximum operating temperature: 110°C

ELECTRICAL (available versions: see chapter electrical radiators, p. 42)

- ✓ Pure electrical radiator prefilled (see p. 58)
- ✓ Mixed radiator

TECHNICAL DRAWINGS

- See p. 150

CONNECTION

- ✗ One-point connection for one-pipe system
- ✗ One-point connection for two-pipe system
- ✓ Two-point connection for one-pipe system (connection by way of the central connection) (see p. 312)
- ✓ Two-point connection for two-pipe system (standard) (see p. 312)
- ✗ Integrated valve
- Connections: ½" (inner thread)

NIVA VERTICAL LACQUERED

Pure technical class, pure design, pure ambience

The ultra-compact, stylized Niva is still a founding example for many designers and colleague manufacturers. Completely functional due to the optimum air flow and the extra high heat output that starts immediately. Completely design due to the integrity, pure design, the floating character – thanks to the underlying invisible suspension and the organically integrated towel rail.

RECOMMENDED CONNECTION (1188)

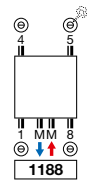

Other connection methods, see p. 149

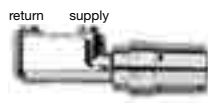

ref. nr. 1182 103 0000 0099

price € 218

Fittings, see p. 327

RECOMMENDED FOR BATHROOM AND KITCHEN IN OPTION



towel rail (chrome)
N1L1 ref. nr. see p. 146
price €187

N2L1 ref. nr. see p. 146
price €187

Other accessories, see p. 146



HOW TO ORDER NIVA VERTICAL LACQUERED

Delivery time 15 - 30 working days
(transport duration not included)

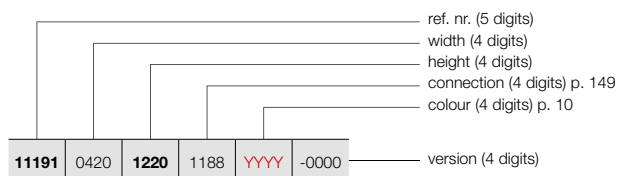

NIVA VERTICAL LACQUERED (N1L1, N2L1)

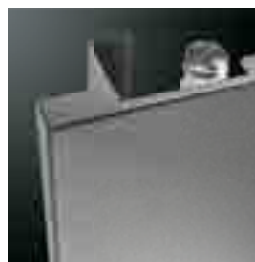

N1L1



N2L1

HOW TO ORDER STOCK RADIATOR NIVA VERTICAL LACQUERED

Delivery time 5 working days
(transport duration not included)

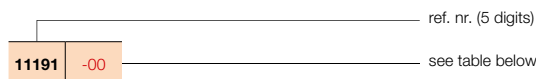

PRICE GROUP: VPG2 - STEEL DESIGN RADIATORS

REFERENCE CODE CUSTOM MADE NIVA VERTICAL LACQUERED	TECHNICAL DATA										STANDARD COLOUR		OTHER COLOURS	
	tubes	width (L mm)	height (H mm)	75/65/20 (Watt) (φ50K)	55/45/20 (Watt) (φ30K)	n-exp.	weight (kg)	water content (l)	electr. resistance (Watt)	price S600* (€)	short ref. nr. S600 stock	price colour (€)	short ref. nr. M301 stock	
REF. NR. NIVA VERTICAL LACQUERED N1L1 : 11191														
11191 0420 1220 1188 YYY -0000	-	420	1220	645	337	1,27	18,10	2,55	-	514	11191-02	591	-	
	-	420	1820	934	486	1,28	27,35	3,70	-	597	11191-03	687	11191-05	
	-	420	2020	1023	532	1,28	30,20	4,00	-	632	11191-06	727	-	
	-	420	2220	1070	559	1,27	33,20	4,50	-	681	-	783	-	
11191 0520 1220 1188 YYY -0000	-	520	1220	815	424	1,28	21,97	3,32	-	579	11191-21	666	-	
	-	520	1820	1128	587	1,28	33,67	4,61	-	672	11191-16	773	11191-01	
	-	520	2020	1257	654	1,28	37,12	5,05	-	711	11191-22	818	-	
	-	520	2220	1310	681	1,28	40,88	5,57	-	767	-	882	-	
11191 0620 1220 1188 YYY -0000	-	620	1220	985	510	1,29	25,83	3,85	-	602	11191-07	692	-	
	-	620	1820	1322	687	1,28	39,98	5,52	-	701	11191-17	806	11191-04	
	-	620	2020	1490	775	1,28	44,03	6,10	-	742	11191-20	853	-	
	-	620	2220	1550	806	1,28	48,57	6,63	-	804	-	925	-	
11191 0720 1820 1188 YYY -0000	-	720	1820	1515	784	1,29	46,30	6,43	-	728	11191-08	837	-	
	-	720	2020	1724	897	1,28	50,95	7,15	-	774	11191-09	890	-	
	-	720	2220	1790	926	1,29	56,25	7,70	-	841	-	967	-	
REF. NR. NIVA VERTICAL LACQUERED N2L1 : 11192														
11192 0420 1220 1188 YYY -0000	-	420	1220	988	506	1,31	26,50	4,90	-	770	-	886	-	
	-	420	1820	1330	681	1,31	42,23	7,28	-	894	11192-02	1028	-	
	-	420	2020	1438	736	1,31	46,75	8,00	-	928	11192-04	1067	-	
	-	420	2220	1543	823	1,23	51,40	8,90	-	982	-	1129	-	
11192 0520 1220 1188 YYY -0000	-	520	1220	1213	621	1,31	33,00	6,48	-	863	11192-05	992	-	
	-	520	1820	1633	836	1,31	51,68	9,07	-	1007	11192-31	1158	-	
	-	520	2020	1764	903	1,31	57,23	10,00	-	1045	11192-32	1202	-	
	-	520	2220	1893	995	1,26	62,73	11,00	-	1105	-	1271	-	
11192 0620 1220 1188 YYY -0000	-	620	1220	1437	732	1,32	39,50	7,02	-	902	11192-37	1037	-	
	-	620	1820	1935	991	1,31	61,14	10,86	-	1049	11192-33	1206	-	
	-	620	2020	2091	1071	1,31	67,72	12,00	-	1088	11192-34	1251	-	
	-	620	2220	2243	1160	1,29	74,07	13,10	-	1157	11192-39	1331	-	
11192 0720 1820 1188 YYY -0000	-	720	1820	2237	1146	1,31	70,60	12,65	-	1085	11192-07	1248	-	
	-	720	2020	2417	1238	1,31	78,20	14,00	-	1136	11192-35	1306	-	
	-	720	2220	2594	1322	1,32	85,40	15,20	-	1214	11192-36	1396	-	

In conformity with EN442-1: 2014: radiators and convectors

* RAL 9016: no extra charge 15%
For heat outputs in other regimes, see p. 320 (correction factors)
EXPORT. Prices in Euro (excl. VAT)

VASCO

NIVA VERTICAL STAINLESS STEEL (N1L1-ES, N2L1-ES)



TYPES

- Single (N1L1-ES) and double (N2L1-ES)

COLOURS

- Stainless steel type 316L, matt brushed with grain 360

SPECIAL

- The Niva Vertical Stainless Steel is available with a front plate in stainless steel (this means steel plate radiator + front plate in stainless steel).
- The Niva Vertical Stainless Steel can be cleaned with a stainless steel cleaner.

BRACKETS

- Wall brackets in the colour RAL 7016 (anthracite grey) standard. Also in option available in the colour S600 (see p. 146).

TECHNICAL

- Electrically welded by means of resistance welding robots (invisible weld seams)
- Standard operating pressure: 10 bar
- Maximum operating temperature: 110°C

ELECTRICAL

- ✗ Pure electrical radiator prefilled
- ✗ Mixed radiator

TECHNICAL DRAWINGS

- See p. 151

CONNECTION

- ✗ One-point connection for one-pipe system
- ✗ One-point connection for two-pipe system
- ✓ Two-point connection for one-pipe system (connection by way of the central connection) (see p. 312)
- ✓ Two-point connection for two-pipe system (standard) (see p. 312)
- ✗ Integrated valve
- Connections: 1/2" (inner thread)

NIVA VERTICAL STAINLESS STEEL

Pure class in all its glory

The Niva Vertical Stainless Steel combines steel plate construction with a stainless steel front plate which gives it a pure and clean design and its floating appearance gives the Niva 'extra shine'. The Niva Vertical Stainless Steel designer radiator is also available with an organically integrated stainless steel towel rail (optional).

RECOMMENDED CONNECTION (1188)

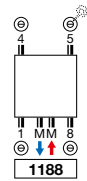

Other connection methods, see p. 149

RECOMMENDED FOR BATHROOM AND KITCHEN IN OPTION



towel rail (chrome)
N1L1 ref. nr. see p. 146
price €187

N2L1 ref. nr. see p. 146
price €187

Other accessories, see p. 146



HOW TO ORDER NIVA VERTICAL STAINLESS STEEL

Delivery time 15 - 30 working days
(transport duration not included)

NIVA VERTICAL STAINLESS STEEL (N1L1-ES, N2L1-ES)

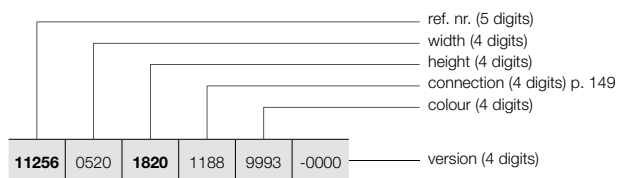

N1L1-ES



N2L1-ES

PRICE GROUP: VPG2 - STEEL DESIGN RADIATORS

REFERENCE CODE CUSTOM MADE NIVA VERTICAL STAINLESS STEEL	TECHNICAL DATA										STANDARD COLOUR				
	tubes	width (L mm)	height (H mm)	75/65/20 (Watt) (φ50K)	55/45/20 (Watt) (φ30K)	n-exp.	weight (kg)	water content (l)	electr. resistance (Watt)	price stainless steel (€)					
REF. NR. N1L1-ES : 11256															
11256	0520	1820	1188	9993	-0000	-	520	1820	1128	587	1,28	33,67	4,61	-	1243
		2020				-	520	2020	1257	654	1,28	37,12	5,05	-	1315
11256	0620	1820	1188	9993	-0000	-	620	1820	1322	687	1,28	39,98	5,52	-	1296
		2020				-	620	2020	1490	775	1,28	44,03	6,10	-	1372
REF. NR. N2L1-ES : 11257															
11257	0520	1820	1188	9993	-0000	-	520	1820	1633	836	1,31	51,68	9,07	-	1862
		2020				-	520	2020	1764	903	1,31	57,23	10,00	-	1931
11257	0620	1820	1188	9993	-0000	-	620	1820	1935	991	1,31	61,14	10,86	-	1939
		2020				-	620	2020	2091	1071	1,31	67,72	12,00	-	2013

In conformity with EN442-1: 2014: radiators and convectors

For heat outputs in other regimes, see p. 320 (correction factors)
EXPORT. Prices in Euro (excl. VAT)



NIVA HORIZONTAL LACQUERED (NH1L1, NH2L1, NH2L2)

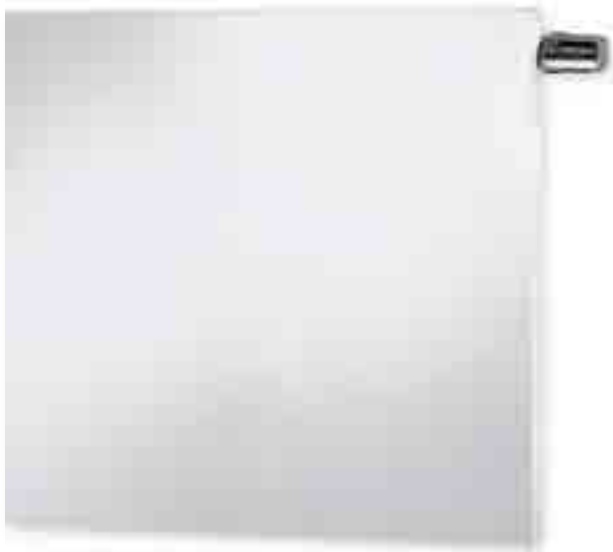

INTEGRATED VALVE NIVA HORIZONTAL LACQUERED

- Radiator in white: thermostatic head in white standard, included in the price
- Radiator in colour: thermostatic head in chrome plated standard, included in the price



TYPES

- NH1L1, NH2L1, NH2L2

COLOURS

- Standard colour S600 (fine texture white) (RAL 9016: no extra charge 15%)
- Extensive colour chart see p. 10

SPECIAL

- The Niva Horizontal Lacquered is available with 1 (NH1L1, NH2L1) or 2 rows (NH2L2) of steel fins at the back of the tubes in order to increase the heat output.
- NH1L1 also available as toilet radiator (520 x 450 mm)

BRACKETS

- Wall brackets in the colour RAL 7016 (anthracite grey) standard. Also in option available in the colour S600 (see p. 146).

TECHNICAL

- Electrically welded by means of resistance welding robots (invisible weld seams)
- KTL priming coat, powder coating
- Standard operating pressure: 10 bar
- Maximum operating temperature: 110°C

ELECTRICAL

- ✗ Pure electrical radiator prefilled
- ✗ Mixed radiator

TECHNICAL DRAWINGS

- See p. 151

CONNECTION

- ✗ One-point connection for one-pipe system
- ✗ One-point connection for two-pipe system
- ✓ Two-point connection for one-pipe system (connection by way of the integrated valve) (see p. 314)
- ✓ Two-point connection for two-pipe system (standard) (see p. 312)
- ✓ Integrated valve **(no extra charge)** (see p. 314)
- Connections: 4x1/2" side (inner thread), 2x3/4" Euro cones (50mm bottom right)

NIVA HORIZONTAL LACQUERED

Pure class in all its simplicity

Also in the horizontal version, the Niva remains an epitome of efficiently applied design. A successful combination of functionality and design, with the choice of one or two blades for a customised heat output. Also available in the toilet version. With optional towel rail in a chrome finish.

RECOMMENDED CONNECTION (0098) INTEGRATED VALVE

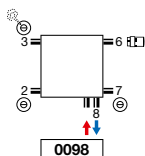

Other connection methods, see p. 149



ref. nr. 11823000000099

price € 147

Fittings, see p. 327

RECOMMENDED FOR BATHROOM AND KITCHEN IN OPTION



towel rail (chrome)
ref. nr. see p. 146

price € 187



HOW TO ORDER NIVA HORIZONTAL LACQUERED

Delivery time 15 - 30 working days
(transport duration not included)

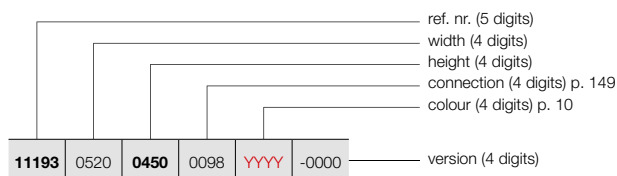

NIVA HORIZONTAL LACQUERED (NH1L1, NH2L1, NH2L2)



NH1L1 / NH2L1

HOW TO ORDER STOCK RADIATOR NIVA HORIZONTAL LACQUERED

Delivery time 5 working days
(transport duration not included)

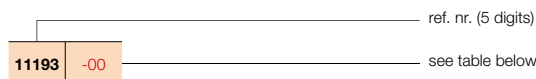

PRICE GROUP: VPG2 - STEEL DESIGN RADIATORS

REFERENCE CODE CUSTOM MADE NIVA HORIZONTAL LACQUERED	TECHNICAL DATA									STANDARD COLOUR		OTHER COLOURS
	tubes	width (L mm)	height (H mm)	75/65/20 (Watt) (φ50K)	55/45/20 (Watt) (φ30K)	n-exp.	weight (kg)	water content (l)	electr. resistance (Watt)	price S600* (€)	short ref. nr. S600 stock	price colour (€)
REF. NR. NIVA HORIZONTAL LACQUERED NH1L1 : 11193												
11193 0520 0450 0098 YYY -0000	-	520	450	301	158	1,26	7,50	1,19	-	469	11193-01	539
11193 0620 0550 0098 YYY -0000	-	620	550	425	223	1,26	11,11	1,66	-	527	-	606
	-	620	650	490	256	1,27	13,28	1,92	-	593	-	682
11193 0820 0550 0098 YYY -0000	-	820	550	562	295	1,26	14,69	2,20	-	610	-	702
	-	820	650	649	339	1,27	17,56	2,53	-	675	-	776
11193 1020 0550 0098 YYY -0000	-	1020	550	699	367	1,26	18,28	2,73	-	697	-	802
	-	1020	650	807	422	1,27	21,85	3,15	-	761	-	875
	-	1020	950	1124	585	1,28	31,85	4,40	-	940	-	1081
11193 1220 0550 0098 YYY -0000	-	1220	550	836	439	1,26	21,86	3,27	-	783	-	900
	-	1220	650	965	504	1,27	26,13	3,77	-	849	-	976
	-	1220	950	1344	699	1,28	38,10	5,26	-	1029	-	1183
REF. NR. NIVA HORIZONTAL LACQUERED NH2L1 : 11194												
11194 0620 0550 0098 YYY -0000	-	620	550	611	318	1,28	17,25	3,27	-	686	-	789
	-	620	650	708	370	1,27	20,70	3,83	-	804	-	925
11194 0820 0550 0098 YYY -0000	-	820	550	809	421	1,28	22,81	4,32	-	783	-	900
	-	820	650	936	489	1,27	27,37	5,07	-	902	-	1037
11194 1020 0550 0098 YYY -0000	-	1020	550	1006	523	1,28	28,38	5,38	-	881	-	1013
	-	1020	650	1165	609	1,27	34,05	6,30	-	997	11194-23	1147
	-	1020	950	1630	839	1,30	50,20	9,05	-	1198	-	1378
11194 1220 0550 0098 YYY -0000	-	1220	550	1203	626	1,28	33,94	6,43	-	976	-	1122
	-	1220	650	1393	728	1,27	40,72	7,54	-	1093	-	1257
	-	1220	950	1950	1004	1,30	60,05	10,82	-	1286	-	1479
11194 1420 0550 0098 YYY -0000	-	1420	550	1400	728	1,28	39,50	7,48	-	1136	-	1306
	-	1420	650	1622	848	1,27	47,40	8,78	-	1272	-	1463
11194 1620 0550 0098 YYY -0000	-	1620	550	1597	830	1,28	45,07	8,54	-	1296	-	1490
	-	1620	650	1850	967	1,27	54,08	10,01	-	1454	-	1672

In conformity with EN442-1: 2014: radiators and convectors

* RAL 9016: no extra charge 15%
For heat outputs in other regimes, see p. 320 (correction factors)
EXPORT. Prices in Euro (excl. VAT)

VASCO

NIVA HORIZONTAL LACQUERED (NH2L2)



NH2L2

HOW TO ORDER NIVA HORIZONTAL LACQUERED

Delivery time 15 - 30 working days
(transport duration not included)

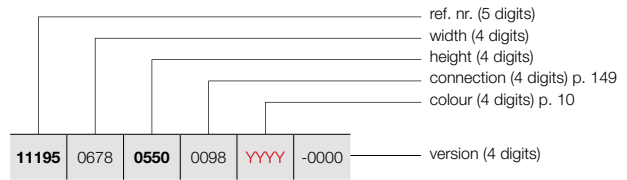

HOW TO ORDER STOCK RADIATOR NIVA HORIZONTAL LACQUERED

Delivery time 5 working days
(transport duration not included)

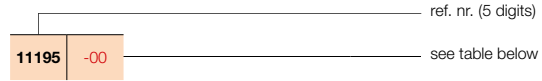

PRICE GROUP: VPG2 - STEEL DESIGN RADIATORS

REFERENCE CODE CUSTOM MADE NIVA HORIZONTAL LACQUERED	TECHNICAL DATA									STANDARD COLOUR		OTHER COLOURS
	tubes	width (L mm)	height (H mm)	75/65/20 (Watt) (φ50K)	55/45/20 (Watt) (φ30K)	n-exp.	weight (kg)	water content (l)	electr. resistance (Watt)	price S600* (€)	short ref. nr. S600 stock	price colour (€)
REF. NR. NIVA HORIZONTAL LACQUERED NH2L2 : 11195												
11195 0678 0550 0098 YYYY -0000	-	678	550	804	416	1,29	20,50	3,40	-	858	-	987
0650	-	678	650	941	487	1,29	24,28	3,93	-	1008	-	1159
11195 0878 0550 0098 YYYY -0000	-	878	550	1041	539	1,29	26,55	4,40	-	988	-	1136
0650	-	878	650	1219	631	1,29	31,44	5,09	-	1137	-	1308
11195 1078 0550 0098 YYYY -0000	-	1078	550	1279	662	1,29	32,60	5,40	-	1117	-	1285
0650	-	1078	650	1496	774	1,29	38,60	6,25	-	1266	11195-16	1456
0950	-	1078	950	2027	1043	1,30	57,90	9,00	-	1498	-	1723
11195 1278 0550 0098 YYYY -0000	-	1278	550	1516	784	1,29	38,65	6,40	-	1243	-	1429
0650	-	1278	650	1774	918	1,29	45,77	7,41	-	1393	-	1602
0950	-	1278	950	2403	1237	1,30	68,64	10,67	-	1626	-	1870
11195 1478 0550 0098 YYYY -0000	-	1478	550	1753	907	1,29	44,69	7,40	-	1440	-	1656
0650	-	1478	650	2051	1061	1,29	52,93	8,57	-	1614	-	1856
11195 1678 0550 0098 YYYY -0000	-	1678	550	1990	1030	1,29	50,74	8,41	-	1633	-	1878
0650	-	1678	650	2329	1205	1,29	60,09	9,73	-	1831	-	2106

In conformity with EN442-1: 2014: radiators and convectors

* RAL 9016: no extra charge 15%

For heat outputs in other regimes, see p. 320 (correction factors)
EXPORT. Prices in Euro (excl. VAT)

TYPES

- Single (NS1L1) and double (NS2L1)

COLOURS

- Standard colour S600 (fine texture white) (RAL 9016: no extra charge 15%)
- Extensive colour chart see p. 10

SPECIAL

- The Niva Soft Vertical is available with a lacquered front plate (this means steel plate radiator + lacquered front plate).
- With a flat front plate and rounded sides as a modern-day touch
- Thermostatic head at doorknob height in option (not for NS1L1) (see p. 314).



BRACKETS

- Wall brackets in the colour RAL 7016 (anthracite grey) standard. Also in option available in the colour S600 (see p. 146).

TECHNICAL

- Electrically welded by means of resistance welding robots (invisible weld seams)
- KTL priming coat, powder coating
- Standard operating pressure: 10 bar
- Maximum operating temperature: 110°C

ELECTRICAL

- ✗ Pure electrical radiator prefilled
- ✗ Mixed radiator

TECHNICAL DRAWINGS

- See p. 152

CONNECTION

- ✗ One-point connection for one-pipe system
- ✗ One-point connection for two-pipe system
- ✓ Two-point connection for one-pipe system (connection by way of the central connection) (see p. 312)
- ✓ Two-point connection for two-pipe system (standard) (see p. 312)
- ✓ Integrated valve (**extra charge €157**) (not for NS1L1) (see p. 314)
- Connections: 1/2" (inner thread)

RECOMMENDED CONNECTION NS1L1/NS2L1 (1188)

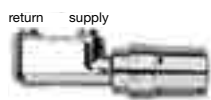
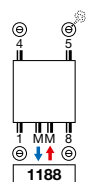

ref. nr. 1182 103 0000 0099
price € 218
 Fittings, see p. 327

RECOMMENDED FOR BATHROOM AND KITCHEN IN OPTION



towel rail (aluminium)
 NS1L1 ref. nr. see p. 146
price € 187

NS2L1 ref. nr. see p. 146
price € 187

Other accessories, see p. 146

OPTION: CONNECTION NS2L1 (0098) INTEGRATED VALVE (SUPPLEMENT)

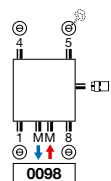

ref. nr. 1182 301 0000 0099
price € 147
 Fittings, see p. 327

Supplement: €157 (see p. 314)
Other connection methods, see p. 149



VASCO

NIVA SOFT VERTICAL

Pure class in all its creativity

The Niva in all its compact, stylish simplicity, but designed with softly rounded edges. A designer radiator that perfectly comes into its own with both a minimalist interior and a contemporary retro surround. Available with a thermostat knob at doorknob height.



NIVA SOFT VERTICAL (NS1L1, NS2L1)



NS1L1



NS2L1

HOW TO ORDER NIVA SOFT

Delivery time 15 - 30 working days
(transport duration not included)

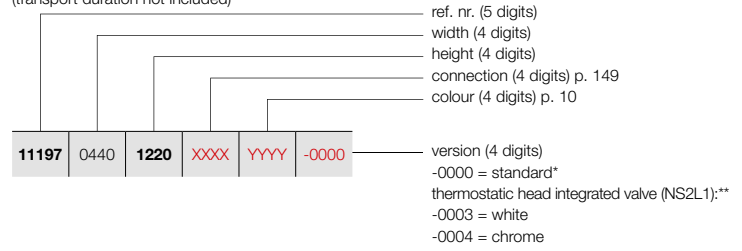

HOW TO ORDER STOCK RADIATOR NIVA SOFT

Delivery time 5 working days
(transport duration not included)

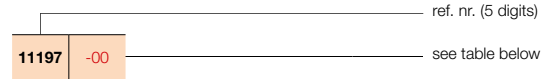

PRICE GROUP: VPG2 - STEEL DESIGN RADIATORS

REFERENCE CODE CUSTOM MADE NIVA SOFT VERTICAL						TECHNICAL DATA									STANDARD COLOUR		OTHER COLOURS	
						tubes	width (L mm)	height (H mm)	75/65/20 (Watt) (φ50K)	55/45/20 (Watt) (φ30K)	n-exp.	weight (kg)	water content (l)	electr. resistance (Watt)	price S600* (€)	short ref. nr. S600 stock	price colour (€)	
REF. NR. NIVA SOFT VERTICAL NS1L1 : 11197																		
11197	0440	1220	XXXX	YYYY	-0000	-	440	1220	645	337	1,27	18,10	2,55	-	514	11197-06	591	
		1820				-	440	1820	934	486	1,28	27,35	3,70	-	597	11197-07	687	
		2020				-	440	2020	1023	532	1,28	30,20	4,00	-	632	11197-08	727	
		2220				-	440	2220	1070	559	1,27	33,20	4,50	-	681	-	783	
11197	0540	1220	XXXX	YYYY	-0000	-	540	1220	815	424	1,28	21,97	3,32	-	579	11197-04	666	
		1820				-	540	1820	1128	587	1,28	33,67	4,61	-	672	11197-01	773	
		2020				-	540	2020	1257	654	1,28	37,12	5,05	-	711	11197-05	818	
		2220				-	540	2220	1310	681	1,28	40,88	5,57	-	767	-	882	
11197	0640	1220	XXXX	YYYY	-0000	-	640	1220	985	510	1,29	25,83	3,85	-	602	11197-09	692	
		1820				-	640	1820	1322	687	1,28	39,98	5,52	-	701	11197-02	806	
		2020				-	640	2020	1490	775	1,28	44,03	6,10	-	742	11197-03	853	
		2220				-	640	2220	1550	806	1,28	48,57	6,63	-	804	-	925	
11197	0740	1820	XXXX	YYYY	-0000	-	740	1820	1515	784	1,29	46,30	6,43	-	728	11197-10	837	
		2020				-	740	2020	1724	897	1,28	50,95	7,15	-	774	11197-11	890	
		2220				-	740	2220	1790	926	1,29	56,25	7,70	-	841	-	967	
REF. NR. NIVA SOFT VERTICAL NS2L1 : 11198																		
11198	0440	1220	XXXX	YYYY	-0000	-	440	1220	988	506	1,31	28,40	4,90	-	770	-	886	
		1820				-	440	1820	1330	681	1,31	42,23	7,28	-	894	11198-08	1028	
		2020				-	440	2020	1438	736	1,31	46,75	8,00	-	928	11198-09	1067	
		2220				-	440	2220	1543	823	1,23	51,40	8,90	-	982	-	1129	
11198	0540	1220	XXXX	YYYY	-0000	-	540	1220	1213	621	1,31	36,83	6,48	-	863	11198-10	992	
		1820				-	540	1820	1633	836	1,31	51,68	9,07	-	1007	11198-01	1158	
		2020				-	540	2020	1764	903	1,31	57,23	10,00	-	1045	11198-02	1202	
		2220				-	540	2220	1893	995	1,26	62,73	11,00	-	1105	-	1271	
11198	0640	1220	XXXX	YYYY	-0000	-	640	1220	1437	732	1,32	38,17	7,02	-	902	-	1037	
		1820				-	640	1820	1935	991	1,31	61,14	10,86	-	1049	11198-03	1206	
		2020				-	640	2020	2091	1071	1,31	67,72	12,00	-	1088	11198-04	1251	
		2220				-	640	2220	2243	1160	1,29	74,07	13,10	-	1157	-	1331	
11198	0740	1820	XXXX	YYYY	-0000	-	740	1820	2237	1146	1,31	70,60	12,65	-	1085	11198-11	1248	
		2020				-	740	2020	2417	1238	1,31	78,20	14,00	-	1136	11198-05	1306	
		2220				-	740	2220	2594	1322	1,32	85,40	15,20	-	1214	-	1396	

In conformity with EN442-1: 2014: radiators and convectors

* RAL 9016: no extra charge 15%

For heat outputs in other regimes, see p. 320 (correction factors)
EXPORT. Prices in Euro (excl. VAT)

VASCO



NOT AVAILABLE
OUTSIDE THE
EU

NIVA

FAN COIL UNIT

heating & cooling



NIVA FAN COIL UNIT

heating & cooling

Year after year, the heat pump gains more ground in new and existing houses. Experts agree: this is the energy source of the future. The end-user benefits twice, because a heat pump not only heats in an energy-efficient manner but also cools the house - certainly when combined with VASCO's brand-new Niva Fan Coil Unit! A fan coil unit is a heat exchanger including lamellas in which a fan blows hot or cold air into the room. This system, which functions at low water temperatures of 30 - 40°C, has great advantages when combined with a heat pump. The fan coil unit can be used in all the rooms of a house, but it is especially beneficial in bedrooms where we need both heating and cooling. The fan coil unit heats or cools a bedroom in no time from 18°C to 22°C or from 28°C to 24°C. In case of cooling water temperatures between 7 and 12°C are used.

The solution for cosy winters and cool summers!

- 2^{IN}1** the ideal 2-in-1 solution
the desired temperature at a fast speed
- ideal combined with a heat pump**
cooling is only possible using a heat pump with cooling function
- for low water temperature systems**
- superbly quiet operation**
- with modulating fan-regulation**
- includes a copper/aluminium heat exchanger**
- energy-efficient operation**
- touch display with intuitive control**
- recoatable**

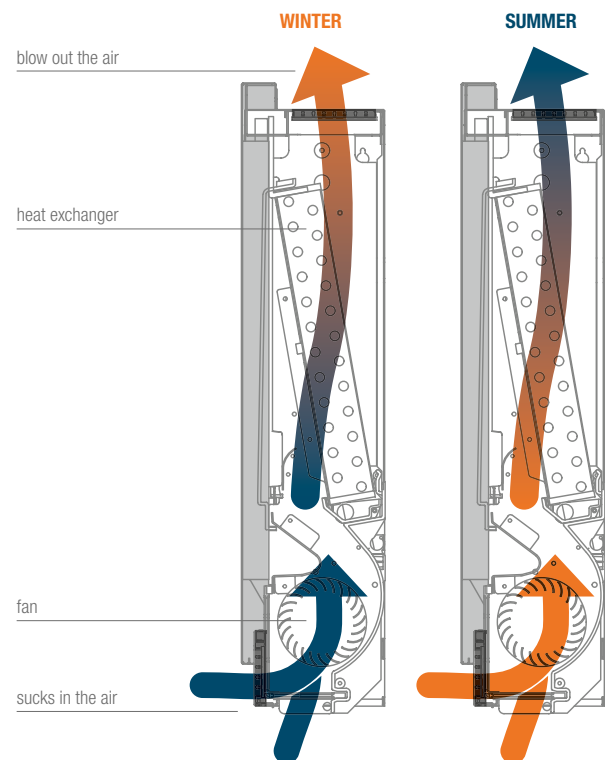

2-IN-1

The Niva fan coil unit generates a comfortable temperature level to each room in your house. The fan coil unit reheats your house in cold weather and provides highly needed cooling during warm days!



NOT AVAILABLE
OUTSIDE THE
EU

NIVA FAN COIL UNIT



PRICE GROUP: VPG8 - FAN COIL

TECHNICAL DATA						STANDARD COLOUR	
width (L mm)	height (H mm)	45/40/20 (Watt)	35/30/20 (Watt)	weight (kg)	water content (l)	price S600 (€)	short ref. nr. S600
TYPE: FC75							
750	610	1018	536	18,00	0,47	-	11600-01
TYPE: FC95							
950	610	2205	1165	21,00	0,80	-	11600-02
TYPE: FC115							
1150	610	3013	1639	24,00	1,13	-	11600-03

In conformity with EN442-1: 2014: radiators and convectors
For heat outputs in other regimes, see p. 320 (correction factors)
Prices on demand



TECHNICAL DATA

		FC75	FC95	FC115
General data				
Heating capacity at 45 / 40 / 20°C	W	1018	2205	3013
Water flow rate	l/h	146	294	438
Pressure loss	kPA	9,10	9,20	19,00
Heating capacity at 35 / 30 / 20°C	W	536	1165	1639
Total cooling capacity at 7 / 12 / 27°C 50% RV	W	955	2222	2914
Palpable cooling capacity	W	683	1483	2043
Water flow rate	l/h	164	381	499
Pressure loss	kPA	13,20	8,90	18,30
Maximum operating pressure	bar	10	10	10
Hydraulic connection		3/4" EK	3/4" EK	3/4" EK
Air technical data				
Maximum air flow rate	m ³ /h	146	294	438
Air flow rate at medium speed	m ³ /h	91	210	318
Air flow rate at minimum speed	m ³ /h	49	124	194
Electric data				
Supply voltage	V/ph/Hz	230/1/50	230/1/50	230/1/50
Maximum power consumption	W	11	19	20
Maximum current consumption	A	0,11	0,16	0,19
Power consumption at minimum speed	W	5	4	6
Noise data				
Sound pressure at maximum air flow *	dB(A)	41	42	44
Sound pressure at average air flow *	dB(A)	33	34	34
Sound pressure at minimum air flow *	dB(A)	24	25	26
Sound power at maximum speed *	dB(A)	54	53	54

* Measured at 1 metre according to ISO 7779

VASCO







BRACKETS		HEIGHT RADIATOR	COLOUR	REF. NR.
N1L1 / N1L1-ES / NS1L1*				
WALL BRACKET		1220 mm	S600	11871 04 1100 0600
		1820 mm	S600	11871 04 1700 0600
		2020 mm	S600	11871 04 1900 0600
		2220 mm	S600	11871 04 2100 0600
N2L1 / N2L1-ES / NS2L1				
WALL BRACKET		1220 mm	S600	11871 05 1100 0600
		1820 mm	S600	11871 05 1700 0600
		2020 mm	S600	11871 05 1900 0600
		2220 mm	S600	11871 05 2100 0600
NH1L1				
WALL BRACKET		450 mm	S600	11871 02 0400 0600
		550 mm	S600	11871 02 0500 0600
		650 mm	S600	11871 02 0600 0600
		950 mm	S600	11871 02 0900 0600
NH2L1 / NH2L2				
WALL BRACKET		550 mm	S600	11871 03 0500 0600
		650 mm	S600	11871 03 0600 0600
		950 mm	S600	11871 03 0900 0600

Prices: see price list "spare parts"

* not available for NS1L1 with integrated valve

PRICE GROUP: VPG10B - TOWEL RAILS

ACCESSORIES	WIDTH TOWEL RAIL	COLOUR*	REF. NR.	€
TOWEL RAIL MULTI+ RIGHT 	N1L1** / N2L1 / N1L1-ES / N2L1-ES / NS1L1** / NS2L1			
	600 mm	S600	1183 734 0000 0600	204
	600 mm	RAL 9005 ^S	1183 734 0000 9005	204
<ul style="list-style-type: none"> • h = 70 mm; b = 600 mm (b tablet = 194 mm); e = 176 mm; c = 170 mm; • Mounting on the wall, to the right of the radiator. 				
TOWEL RAIL MULTI+ LEFT 	N1L1** / N2L1 / N1L1-ES / N2L1-ES / NS1L1** / NS2L1			
	600 mm	S600	1183 735 0000 0600	204
	600 mm	RAL 9005 ^S	1183 735 0000 9005	204
<ul style="list-style-type: none"> • h = 70 mm; b = 600 mm (b tablet = 194 mm); e = 176 mm; c = 170 mm; • Mounting on the wall, to the left of the radiator. 				
SHORT TOWEL RAIL 	N1L1** / N1L1-ES / NS1L1**			
	240 mm	S600	1183 710 0000 0600	135
	240 mm	RAL 9005 ^S	1183 710 0000 9005	135
	N2L1 / N2L1-ES / NS2L1			
	240 mm	S600	1183 720 0000 0600	135
	240 mm	RAL 9005 ^S	1183 720 0000 9005	135
<ul style="list-style-type: none"> • N1L1 / N1L1-ES: d = 66,5 mm; a = 56,5 mm • NS1L1: d = 68 mm; a = 58 mm • N2L1 / N2L1-ES: d = 59,5 mm; a = 49,5 mm • NS2L1: d = 58 mm; a = 48 mm 				
LONG TOWEL RAIL 	N1L1** / N1L1-ES / NS1L1**			
	440 mm	S600	1183 711 0000 0600	135
	440 mm	RAL 9005 ^S	1183 711 0000 9005	135
	N2L1 / N2L1-ES / NS2L1			
	440 mm	S600	1183 721 0000 0600	135
	440 mm	RAL 9005 ^S	1183 721 0000 9005	135
<ul style="list-style-type: none"> • N1L1 / N1L1-ES: d = 66,5 mm; a = 56,5 mm • NS1L1: d = 68 mm; a = 58 mm • N2L1 / N2L1-ES: d = 59,5 mm; a = 49,5 mm • NS2L1: d = 58 mm; a = 48 mm 				

^S structure black

* Multi+ is available in the colour of the radiator, if ordered together. Extra charge +15%.

** Not possible for Niva Bath

Mounting instructions accessories: see www.vasco.eu

EXPORT. Prices in Euro (excl. VAT)

e = distance front of the accessory up to the wall
d = distance front of the accessory up to front of the radiator
c = distance between wall to back towel bar
a = distance accessory up to the radiator
available from stock

ACCESSORIES		WIDTH TOWEL RAIL	COLOUR	REF. NR.	€		
TOWEL RAIL		N1L1* / N1L1-ES / NS1L1*					
		372 mm	ALUMINIUM	1183 239 0000 0000	187		
		372 mm	CHROME	1183 239 0000 0099	187		
		372 mm	S600	1183 239 0000 0600	187		
		372 mm	RAL 9005 ^M	1183 239 0000 9005	187		
		526 mm	CHROME	1183 271 0000 0099	187		
		526 mm	S600	1183 271 0000 0600	187		
		526 mm	RAL 9005 ^M	1183 271 0000 9005	187		
<ul style="list-style-type: none"> Towel rail in aluminium h = 55 mm; b = 372, 526 mm; d = 56 mm; a = 50 mm; 							
TOWEL RAIL		N2L1 / N2L1-ES / NS2L1					
		372 mm	ALUMINIUM	1183 240 0000 0000	187		
		372 mm	CHROME	1183 240 0000 0099	187		
		372 mm	S600	1183 240 0000 0600	187		
		372 mm	RAL 9005 ^M	1183 240 0000 9005	187		
		526 mm	CHROME	1183 272 0000 0099	187		
		526 mm	S600	1183 272 0000 0600	187		
		526 mm	RAL 9005 ^M	1183 272 0000 9005	187		
<ul style="list-style-type: none"> Towel rail in aluminium h = 55 mm; b = 372, 526 mm; d = 56 mm; a = 50 mm; 							
TOWEL RAIL		WIDTH RADIATOR	COLOUR	REF. NR.	€		
		N1L1 / N1L1-ES / NIVA BATH					
		420 mm	CHROME	1183 213 0000 0099	187		
		520 mm	CHROME	1183 214 0000 0099	187		
		520 mm	STAINLESS STEEL	1183 214 0000 9993	187		
		620 mm	CHROME	1183 215 0000 0099	187		
		620 mm	STAINLESS STEEL	1183 215 0000 9993	187		
		720 mm	CHROME	1183 216 0000 0099	187		
		<ul style="list-style-type: none"> h = 25 mm; b = 440, 540, 640, 740 mm; d = 73 mm; a = 57 mm 					
		TOWEL RAIL		N2L1 / N2L1-ES			
420 mm	CHROME			1183 218 0000 0099	187		
520 mm	CHROME			1183 219 0000 0099	187		
520 mm	DISCONTINUED ITEM STAINLESS STEEL			1183 219 0000 9993	187		
620 mm	CHROME			1183 220 0000 0099	187		
620 mm	DISCONTINUED ITEM STAINLESS STEEL			1183 220 0000 9993	187		
720 mm	CHROME			1183 221 0000 0099	187		
<ul style="list-style-type: none"> h = 25 mm; b = 440, 540, 640, 740 mm; d = 73 mm; a = 57 mm 							
TOWEL RAIL		NH1L1 / NH2L1 / NH2L2					
			CHROME	1183 217 0000 0099	187		
<ul style="list-style-type: none"> h = 25 mm; b = 740 mm (easy adjustable); d = 73 mm; a = 57 mm 							
NIVA BATH		HEIGHT RADIATOR	COLOUR	REF. NR.	€		
		N1L1 / NS1L1					
		1820 mm	S600	1183 803 1820 0600	334		
		1820 mm	RAL 9005 ^S	1183 803 1820 9005	334		
		2020 mm	S600	1183 803 2020 0600	350		
2020 mm	RAL 9005 ^S	1183 803 2020 9005	350				
<ul style="list-style-type: none"> width radiator N1L1: 420 mm; width radiator NS1L1: 440 mm; 							

^S structure black
^M matt black
* Not possible for Niva Bath

d = distance front of the accessory up to front of the radiator
a = distance accessory up to the radiator
available from stock

Mounting instructions accessories: see www.vasco.eu
EXPORT. Prices in Euro (excl. VAT)

NIVA BATH: N1L1 / NS1L1

NIVA VERTICAL LACQUERED: N1L1 / N2L1

NIVA VERTICAL STAINLESS STEEL: N1L1-ES / N2L1-ES

NIVA SOFT VERTICAL: NS1L1 / NS2L1 (without integrated valve)

NIVA MIXED: N1L1-EL-MIX

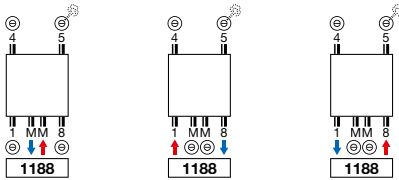

- **Attention:** MM with supply on the right.

NIVA SOFT VERTICAL: NS2L1

INTEGRATED VALVE

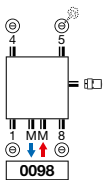

- **Supplement:** €157 (see p. 314)
- **Attention:** MM with supply on the right (on this connection, there is a flow tube at the back).

NIVA HORIZONTAL LACQUERED: NH1L1 / NH2L1 / NH2L2

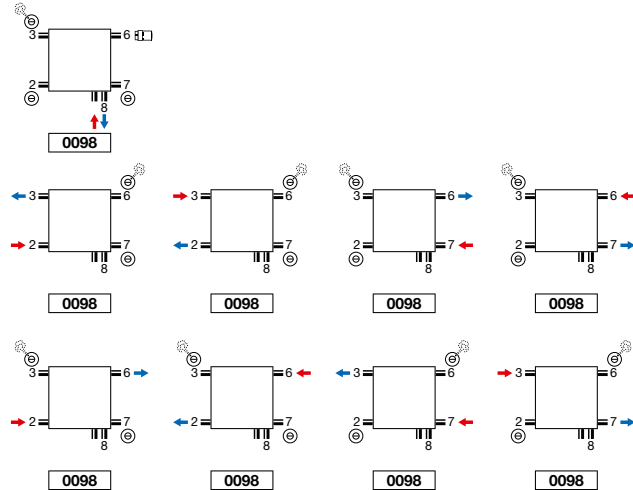

- **Integrated valve:** no extra charge (see p. 314)
- **Thermostatic head only to use with connection on the valve (supply left, return right). Other connections, eg. 23, take thermostatic head out of connection 6. Here the possibility to change the supply and the return.**

NIVA BATH (N1L1, NS1L1)

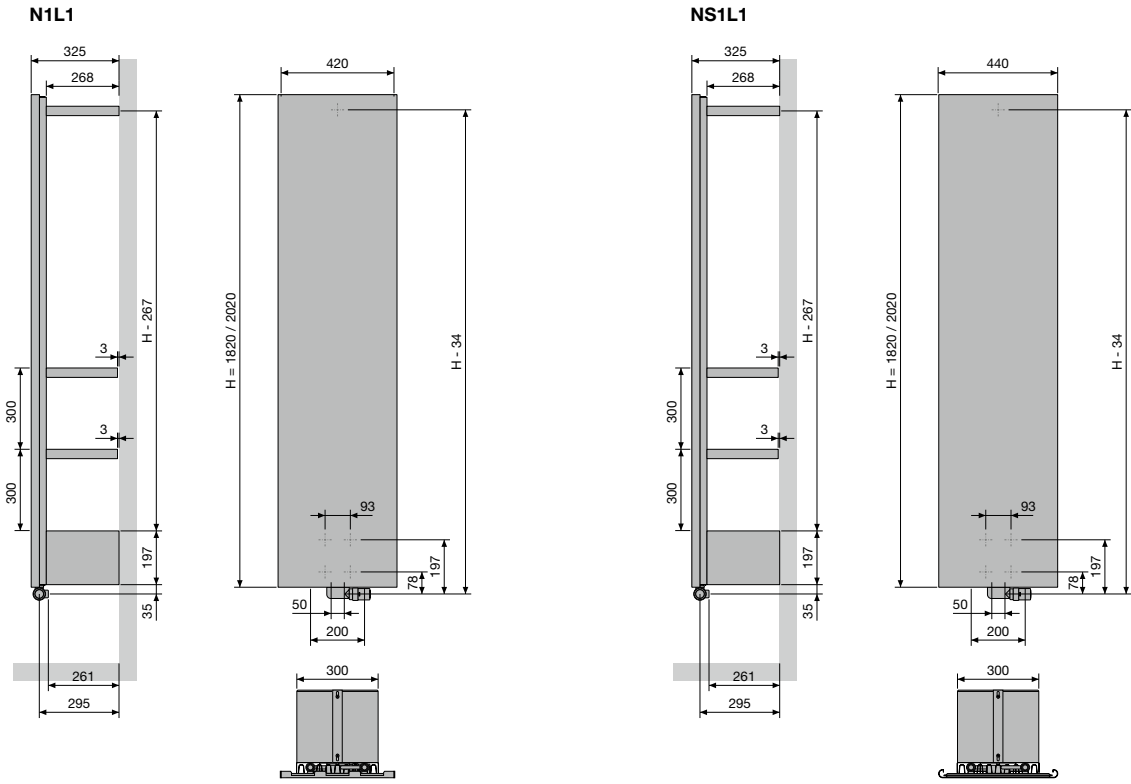

NIVA VERTICAL LACQUERED (N1L1, N2L1)

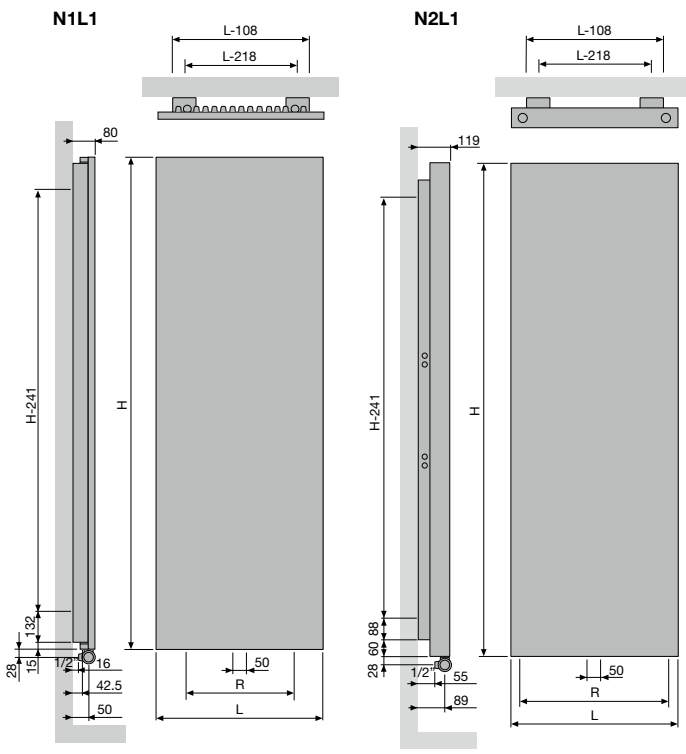

		N1L1			
Width (L)		420	520	620	720
Centre between the connections at the bottom	18 (R)	200	300	400	500
	Centre between the brackets	L-218	H-241		

		N2L1			
Width (L)		420	520	620	720
Centre between the connections at the bottom	18 (R)	338	438	538	638
	Centre between the brackets	L-218	H-241		

NIVA VERTICAL STAINLESS STEEL (N1L1-ES, N2L1-ES)

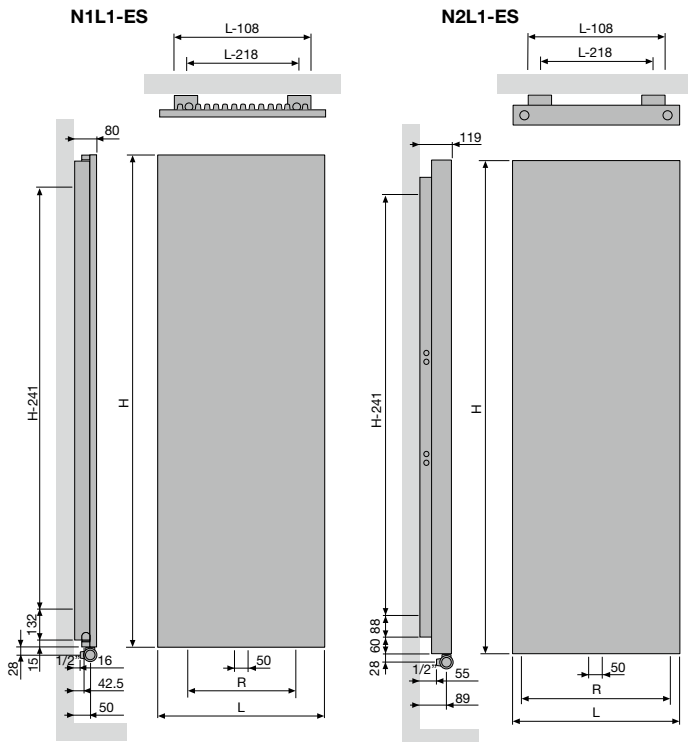

N1L1-ES			
Width (L)	520	620	
Centre between the connections at the bottom 18 (R)	300	400	
Centre between the brackets	L-218	H-241	

N2L1-ES			
Width (L)	520	620	
Centre between the connections at the bottom 18 (R)	438	538	
Centre between the brackets	L-218	H-241	

NIVA HORIZONTAL LACQUERED (NH1L1, NH2L1)

NH1L1 / NH2L1

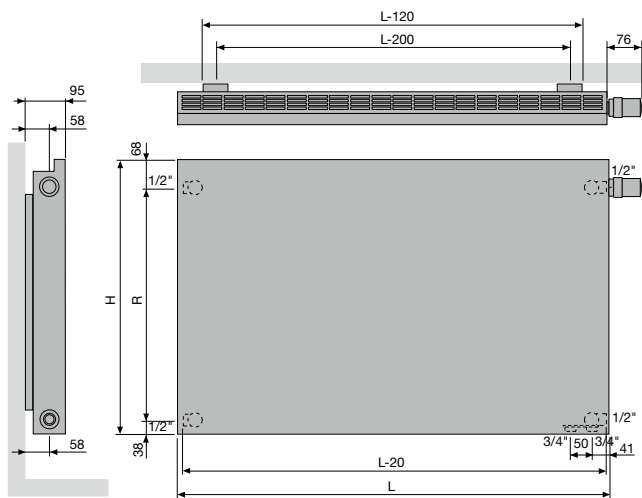

NH1L1				
Height (H)	450	550	650	950
Centre between the lateral connections 23/67 (R)	343	443	543	843
Centre between the brackets	L-200			

NIVA HORIZONTAL LACQUERED (NH2L2)

NH2L2

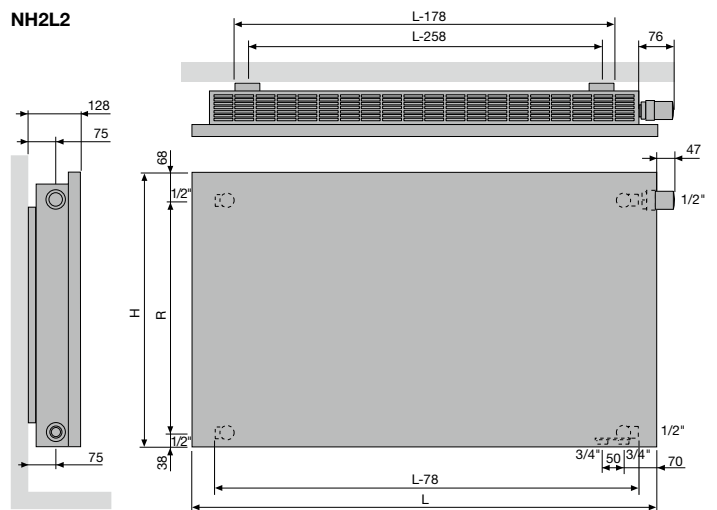

NH2L2			
Height (H)	550	650	950
Centre between the lateral connections 23/67 (R)	443	543	843
Centre between the brackets	L-258		

NH2L1			
Height (H)	550	650	950
Centre between the lateral connections 23/67 (R)	443	543	843
Centre between the brackets	L-200		

NIVA SOFT VERTICAL (NS1L1)

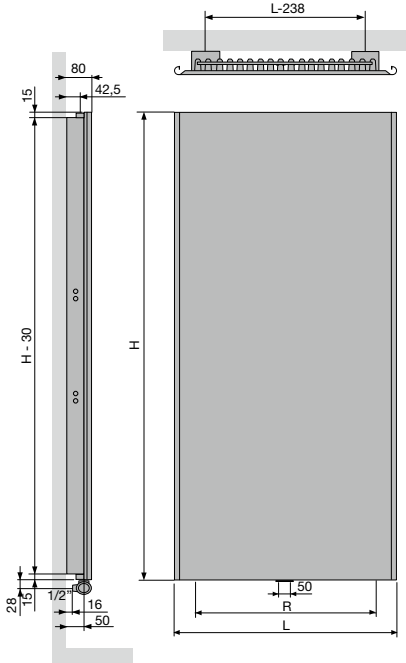

NS1L1				
Width (L)	440	540	640	740
Centre between the connections at the bottom (R)	200	300	400	500
Centre between the brackets	L-238	H-241		

NIVA SOFT VERTICAL (NS2L1)

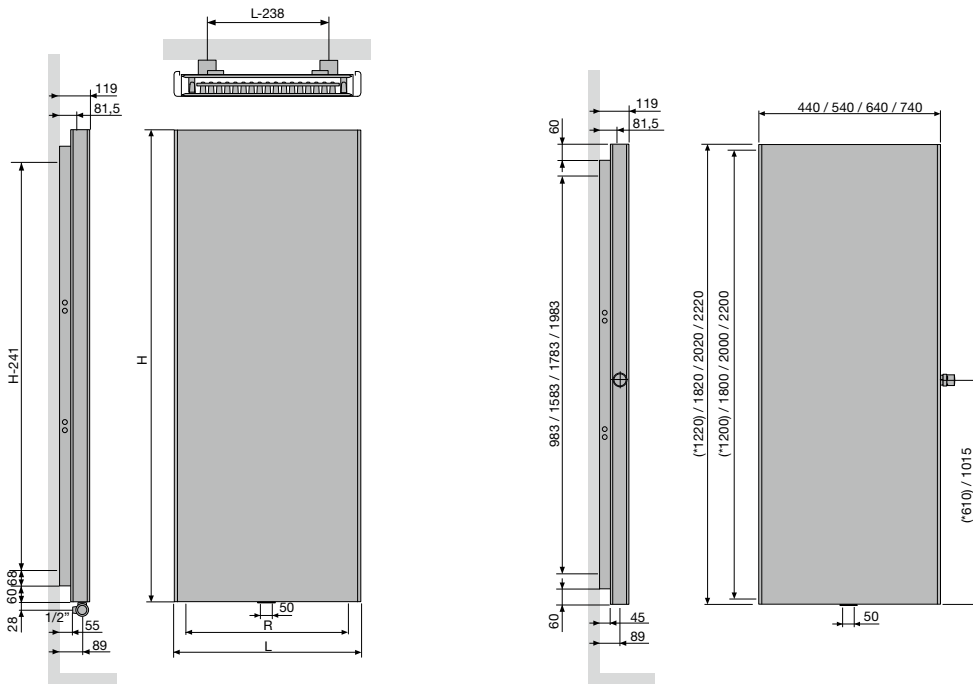

NS2L1				
Width (L)	440	540	640	740
Centre between the connections at the bottom (R)	338	438	538	638
Centre between the brackets	L-238	H-241		

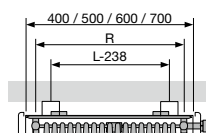



NOT AVAILABLE
OUTSIDE THE
EU

NIVA FAN COIL UNIT

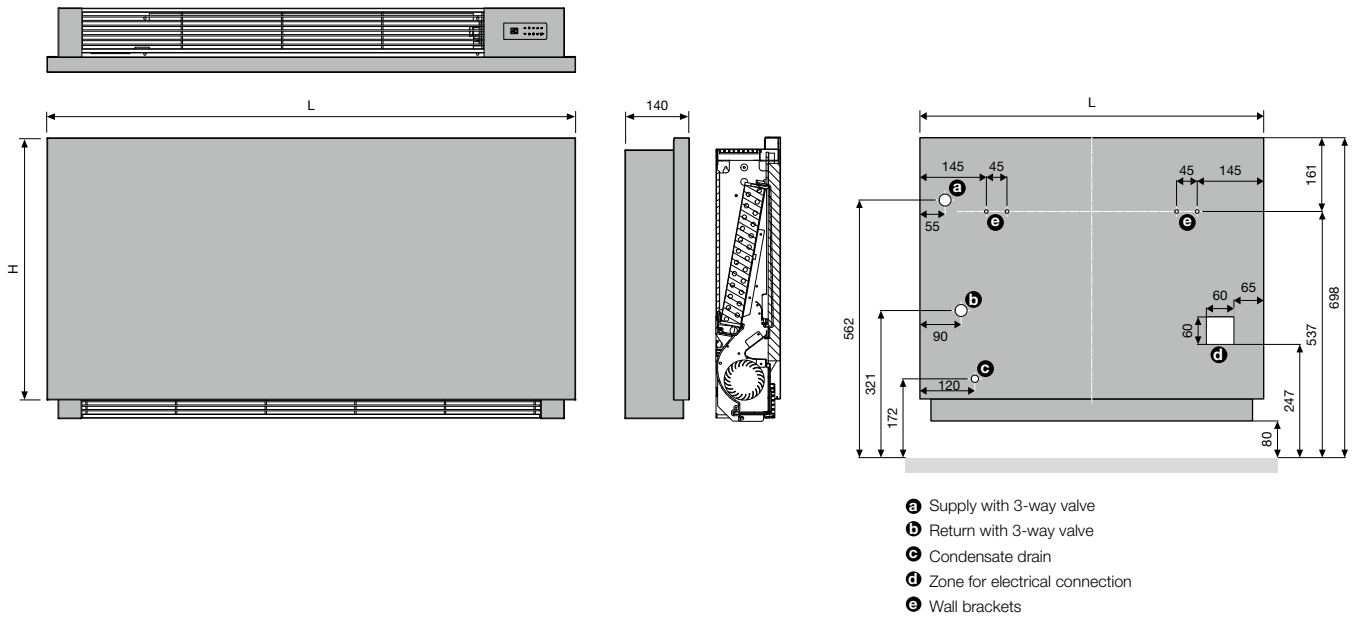

CARRÉ PLUS VERTICAL (CPVN-PLUS)



TYPES

- Vertical: Carré Plus (CPVN-PLUS)

TUBES

- Vertical, square 25 x 25 mm

COLLECTORS

- Horizontal, round Ø 35 mm

COLOURS

- Standard colour white RAL 9016
- Extensive colour chart see p. 10

BRACKETS

- Wall brackets standard

TECHNICAL

- Welded by means of resistance welding robots (invisible weld seams)
- KTL priming coat, powder coating
- Standard operating pressure: 10 bar
- Maximum operating temperature: 110°C

ELECTRICAL

- ✗ Pure electrical radiator prefilled
- ✗ Mixed radiator

TECHNICAL DRAWINGS

- See p. 170

CONNECTION

- ✓ One-point connection for one-pipe system (order as special radiator) **(on demand)** (see p. 313)
- ✓ One-point connection for two-pipe system (order as special radiator) **(on demand)** (see p. 313)
- ✓ Two-point connection for one-pipe system (connection by way of the central connection) (see p. 312)
- ✓ Two-point connection for two-pipe system (standard) (see p. 312)
- ✗ Integrated valve
- Connections: ½" (inner thread)

CARRÉ PLUS VERTICAL

Minimum clearance, maximum effect

An icon in the world of designer radiators. VASCO developed a whole new type of tube especially for the Carré with sharp corners for an austere design and with optimum thermal efficiency with a minimum clearance. The flat look creates a sense of calm, enhanced by the concealed, beautifully integrated collector. A highly praised designer radiator for which VASCO, as always, also developed the appropriate accessories.

RECOMMENDED CONNECTION (1188)

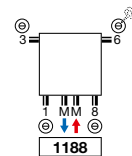

Other connection methods, see p. 169

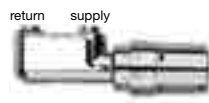

ref. nr. 1182 103 0000 0099
price € 218
 Fittings, see p. 327

RECOMMENDED FOR BATHROOM AND KITCHEN IN OPTION



towel rail straight (chrome)
 ref. nr. see p. 168
price € 187

Other accessories, see p. 168



HOW TO ORDER CARRÉ PLUS VERTICAL

Delivery time 15 - 30 working days
(transport duration not included)

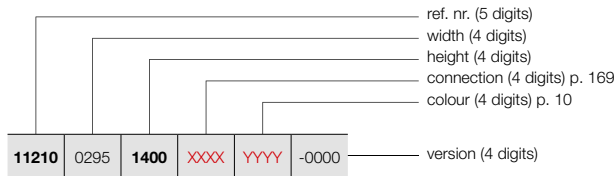

CARRÉ PLUS VERTICAL (CPVN-PLUS)



CPVN-PLUS

HOW TO ORDER STOCK RADIATOR CARRÉ PLUS VERTICAL

Delivery time 5 working days
(transport duration not included)

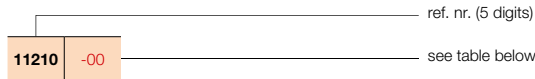

PRICE GROUP: VPG2 - STEEL DESIGN RADIATORS

REFERENCE CODE CUSTOM MADE CARRÉ PLUS VERTICAL	TECHNICAL DATA									STANDARD COLOUR		OTHER COLOURS
	tubes	width (L mm)	height (H mm)	75/65/20 (Watt) (φ50K)	55/45/20 (Watt) (φ30K)	n-exp.	weight (kg)	water content (l)	electr. resistance (Watt)	price RAL 9016 (€)	short ref. nr. RAL 9016 stock	price colour (€)
REF. NR. CARRÉ PLUS VERTICAL CPVN-PLUS : 11210												
11210 0295 1400 XXXX YYYY -0000	10	295	1400	871	443	1,31	19,70	8,40	-	485	-	558
	10	295	1600	986	505	1,31	21,60	9,40	-	531	-	611
	10	295	1800	1097	559	1,32	23,60	10,50	-	573	-	659
	10	295	2000	1206	614	1,32	26,20	12,00	-	619	-	712
	10	295	2200	1312	672	1,31	28,90	13,50	-	664	-	764
11210 0355 1400 XXXX YYYY -0000	12	355	1400	1026	521	1,31	23,16	10,08	-	584	-	672
	12	355	1600	1161	595	1,31	25,44	11,28	-	637	-	733
	12	355	1800	1293	659	1,32	27,72	12,48	-	691	11210-16	795
	12	355	2000	1421	724	1,32	30,96	14,40	-	743	-	854
	12	355	2200	1545	791	1,31	34,08	16,20	-	791	-	910
11210 0415 1400 XXXX YYYY -0000	14	415	1400	1179	599	1,31	26,46	11,76	-	677	-	779
	14	415	1600	1334	683	1,31	29,12	13,16	-	743	-	854
	14	415	1800	1485	757	1,32	31,64	14,56	-	807	-	928
	14	415	2000	1632	836	1,31	35,42	16,66	-	865	11210-05	995
	14	415	2200	1775	909	1,31	39,20	18,90	-	927	-	1066
11210 0475 1400 XXXX YYYY -0000	16	475	1400	1330	676	1,31	29,60	13,28	-	775	-	891
	16	475	1600	1505	771	1,31	32,48	14,88	-	851	-	979
	16	475	1800	1675	853	1,32	35,52	16,48	-	922	-	1060
	16	475	2000	1841	943	1,31	39,84	19,04	-	993	-	1142
	16	475	2200	2002	1025	1,31	44,00	21,60	-	1058	-	1217
11210 0535 1400 XXXX YYYY -0000	18	535	1400	1478	751	1,31	32,58	14,94	-	870	-	1001
	18	535	1600	1673	857	1,31	35,82	16,74	-	958	-	1102
	18	535	1800	1862	954	1,31	39,06	18,54	-	1037	11210-07	1193
	18	535	2000	2046	1048	1,31	43,92	21,42	-	1117	11210-09	1285
	18	535	2200	2226	1140	1,31	48,78	24,30	-	1190	-	1369
11210 0595 1400 XXXX YYYY -0000	20	595	1400	1625	826	1,31	35,20	16,60	-	969	-	1114
	20	595	1600	1839	942	1,31	39,00	18,60	-	1063	-	1222
	20	595	1800	2047	1048	1,31	42,60	20,40	-	1152	11210-11	1325
	20	595	2000	2250	1152	1,31	48,00	23,60	-	1239	11210-12	1425
	20	595	2200	2447	1260	1,30	53,40	27,00	-	1323	-	1521
11210 0655 1400 XXXX YYYY -0000	22	655	1400	1771	900	1,31	37,84	18,26	-	1068	-	1228
	22	655	1600	2004	1026	1,31	41,80	20,24	-	1169	-	1344
	22	655	1800	2231	1143	1,31	45,76	22,44	-	1267	-	1457
	22	655	2000	2451	1255	1,31	51,70	25,96	-	1365	-	1570
	22	655	2200	2666	1372	1,30	57,64	29,48	-	1455	-	1673
11210 0715 1400 XXXX YYYY -0000	24	715	1400	1915	973	1,31	40,32	19,68	-	1165	-	1340
	24	715	1600	2167	1110	1,31	44,64	22,08	-	1277	-	1469
	24	715	1800	2412	1235	1,31	48,96	24,24	-	1381	-	1588
	24	715	2000	2651	1365	1,30	55,44	28,32	-	1488	-	1711
	24	715	2200	2883	1484	1,30	61,92	32,16	-	1587	-	1825

In conformity with EN442-1: 2014: radiators and convectors

For heat outputs in other regimes, see p. 320 (correction factors)
EXPORT. Prices in Euro (excl. VAT)

CARRÉ PLUS VERTICAL (CPVN-PLUS)



CPVN-PLUS

HOW TO ORDER CARRÉ PLUS VERTICAL

Delivery time 15 - 30 working days
(transport duration not included)

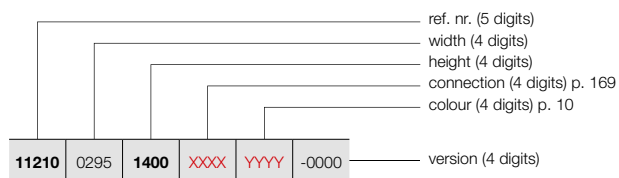

PRICE GROUP: VPG2 - STEEL DESIGN RADIATORS

REFERENCE CODE CUSTOM MADE CARRÉ PLUS VERTICAL	TECHNICAL DATA										STANDARD COLOUR		OTHER COLOURS				
	tubes	width (L mm)	height (H mm)	75/65/20 (Watt) (φ50K)	55/45/20 (Watt) (φ30K)	n-exp.	weight (kg)	water content (l)	electr. resistance (Watt)	price RAL 9016 (€)	short ref. nr. RAL 9016 stock	price colour (€)					
REF. NR. CARRÉ PLUS VERTICAL CPVN-PLUS : 11210																	
11210	0775	1400	XXXX	YYYY	-0000	26	775	1400	2058	1046	1,31	42,64	21,32	-	1263	-	1452
		1600				26	775	1600	2329	1193	1,31	47,32	23,92	-	1381	-	1588
		1800				26	775	1800	2592	1334	1,30	51,74	26,26	-	1497	-	1722
		2000				26	775	2000	2849	1467	1,30	58,76	30,68	-	1612	-	1854
		2200				26	775	2200	3098	1595	1,30	65,78	34,84	-	1719	-	1977
11210	0895	1400	XXXX	YYYY	-0000	30	895	1400	2341	1189	1,31	46,80	24,60	-	1455	-	1673
		1600				30	895	1600	2649	1357	1,31	51,90	27,30	-	1594	-	1833
		1800				30	895	1800	2949	1518	1,30	57,00	30,00	-	1727	-	1986
		2000				30	895	2000	3240	1668	1,30	65,10	35,10	-	1857	-	2136
		2200				30	895	2200	3524	1814	1,30	73,20	40,20	-	1983	-	2280

In conformity with EN442-1: 2014: radiators and convectors

For heat outputs in other regimes, see p. 320 (correction factors)
EXPORT. Prices in Euro (excl. VAT)

TYPES

- Two rows (CPVN2-ZB) of tubes

TUBES

- Vertical, square 25 x 25 mm

COLLECTORS

- Horizontal, round Ø 35 mm

COLOURS

- Standard colour white RAL 9016
- Extensive colour chart see p. 10

BRACKETS

- Wall brackets in the colour RAL 9016 standard. Also in option available in the colour RAL 7016 (see p. 167).

TECHNICAL

- Welded by means of resistance welding robots (invisible weld seams)
- KTL priming coat, powder coating
- Standard operating pressure: 10 bar
- Maximum operating temperature: 110°C

ELECTRICAL

- ✗ Pure electrical radiator prefilled
- ✗ Mixed radiator

TECHNICAL DRAWINGS

- See p. 170

CONNECTION

- ✓ One-point connection for one-pipe system (order as special radiator) **(on demand)** (see p. 313)
- ✓ One-point connection for two-pipe system (order as special radiator) **(on demand)** (see p. 313)
- ✓ Two-point connection for one-pipe system (connection by way of the central connection) (see p. 312)
- ✓ Two-point connection for two-pipe system (standard) (see p. 312)
- ✗ Integrated valve
- Connections: ½" (inner thread)



RECOMMENDED CONNECTION (1188)

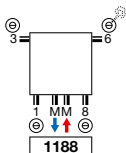

Other connection methods, see p. 169

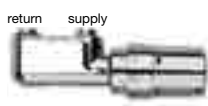

ref. nr. 1182 103 0000 0099
price € 218
 Fittings, see p. 327

RECOMMENDED FOR BATHROOM AND KITCHEN IN OPTION



towel rail straight (chrome)
 ref. nr. see p. 168
price € 187

Other accessories, see p. 168

CARRÉ VERTICAL

Top design with double heat capacity

The sleek, smooth look of the Carré Plus, which has a double row of pipes for maximum heat output. The Carré Vertical designer radiator continues to be its timeless, functional self, but the extra capacity ensures optimum efficiency, even in larger spaces.



CARRÉ VERTICAL (CPVN2-ZB)

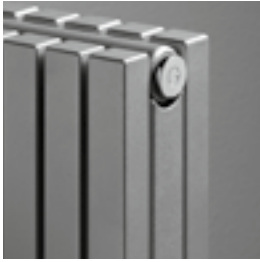

CPVN2-ZB

HOW TO ORDER CARRÉ VERTICAL

Delivery time 15 - 30 working days
(transport duration not included)

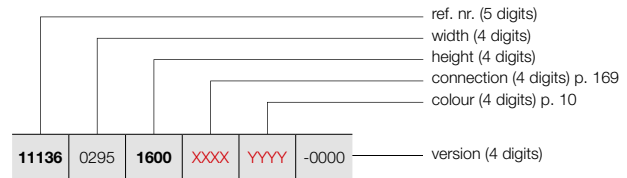

PRICE GROUP: VPG2 - STEEL DESIGN RADIATORS

REFERENCE CODE CUSTOM MADE CARRÉ VERTICAL						TECHNICAL DATA						STANDARD COLOUR	OTHER COLOURS			
						tubes	width (L mm)	height (H mm)	75/65/20 (Watt) (φ50K)	55/45/20 (Watt) (φ30K)	n-exp.	weight (kg)	water content (l)	electr. resistance (Watt)	price RAL 9016 (€)	price colour (€)
REF. NR. CARRÉ VERTICAL CPVN2-ZB : 11136																
11136	0295	1600	XXXX	YYYY	-0000	10	295	1600	1062	533	1,35	30,20	15,80	-	851	979
		1800				10	295	1800	1174	589	1,35	33,80	17,90	-	922	1060
		2000				10	295	2000	1279	642	1,35	37,30	20,10	-	993	1142
		2200				10	295	2200	1377	691	1,35	40,60	21,30	-	1058	1217
		2400				10	295	2400	1469	737	1,35	43,80	22,60	-	1123	1291
		2600				10	295	2600	1555	780	1,35	47,10	23,90	-	1186	1364
		2800				10	295	2800	1635	820	1,35	50,30	25,10	-	1248	1435
		3000				10	295	3000	1709	858	1,35	53,60	26,40	-	1309	1505
11136	0355	1600	XXXX	YYYY	-0000	12	355	1600	1275	640	1,35	36,24	18,96	-	1020	1173
		1800				12	355	1800	1409	707	1,35	40,56	21,48	-	1106	1272
		2000				12	355	2000	1534	770	1,35	44,76	24,12	-	1190	1369
		2200				12	355	2200	1652	829	1,35	48,72	25,56	-	1268	1458
		2400				12	355	2400	1763	885	1,35	52,56	27,12	-	1347	1549
		2600				12	355	2600	1866	936	1,35	56,52	28,68	-	1422	1635
		2800				12	355	2800	1962	984	1,35	60,36	30,12	-	1496	1720
		3000				12	355	3000	2050	1029	1,35	64,32	31,68	-	1569	1804
11136	0415	1600	XXXX	YYYY	-0000	14	415	1600	1487	746	1,35	42,28	22,12	-	1190	1369
		1800				14	415	1800	1643	824	1,35	47,32	25,06	-	1294	1488
		2000				14	415	2000	1790	898	1,35	52,22	28,14	-	1388	1596
		2200				14	415	2200	1928	967	1,35	56,84	29,82	-	1484	1707
		2400				14	415	2400	2057	1032	1,35	61,32	31,64	-	1569	1804
		2600				14	415	2600	2177	1092	1,35	65,94	33,46	-	1660	1909
		2800				14	415	2800	2289	1149	1,35	70,42	35,14	-	1749	2011
		3000				14	415	3000	2392	1200	1,35	75,04	36,96	-	1831	2106
11136	0475	1600	XXXX	YYYY	-0000	16	475	1600	1700	853	1,35	48,32	25,28	-	1362	1566
		1800				16	475	1800	1878	942	1,35	54,08	28,64	-	1474	1695
		2000				16	475	2000	2046	1027	1,35	59,68	32,16	-	1587	1825
		2200				16	475	2200	2203	1105	1,35	64,96	34,08	-	1691	1945
		2400				16	475	2400	2351	1180	1,35	70,08	36,16	-	1795	2064
		2600				16	475	2600	2488	1248	1,35	75,36	38,24	-	1900	2185
		2800				16	475	2800	2616	1313	1,35	80,48	40,16	-	1999	2299
		3000				16	475	3000	2734	1372	1,35	85,76	42,24	-	2095	2409
11136	0535	1600	XXXX	YYYY	-0000	18	535	1600	1912	959	1,35	54,36	28,44	-	1531	1761
		1800				18	535	1800	2113	1060	1,35	60,84	32,22	-	1660	1909
		2000				18	535	2000	2301	1155	1,35	67,14	36,18	-	1785	2053
		2200				18	535	2200	2479	1244	1,35	73,08	38,34	-	1904	2190
		2400				18	535	2400	2644	1327	1,35	78,84	40,68	-	2024	2328
		2600				18	535	2600	2799	1404	1,35	84,78	43,02	-	2137	2458
		2800				18	535	2800	2942	1476	1,35	90,54	45,18	-	2249	2586
		3000				18	535	3000	3075	1543	1,35	96,48	47,52	-	2353	2706

In conformity with EN442-1: 2014: radiators and convectors

For heat outputs in other regimes, see p. 320 (correction factors)
EXPORT. Prices in Euro (excl. VAT)

HOW TO ORDER CARRÉ VERTICAL
 Delivery time 15 - 30 working days
 (transport duration not included)

CARRÉ VERTICAL (CPVN2-ZB)

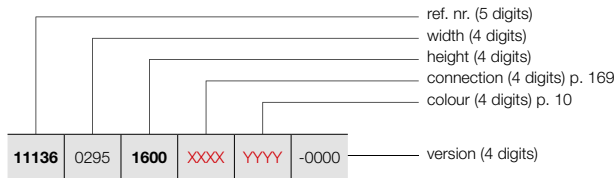

CPVN2-ZB

PRICE GROUP: VPG2 - STEEL DESIGN RADIATORS

REFERENCE CODE CUSTOM MADE CARRÉ VERTICAL	TECHNICAL DATA									STANDARD COLOUR	OTHER COLOURS					
	tubes	width (L mm)	height (H mm)	75/65/20 (Watt) (φ50K)	55/45/20 (Watt) (φ30K)	n-exp.	weight (kg)	water content (l)	electr. resistance (Watt)	price RAL 9016 (€)	price colour (€)					
REF. NR. CARRÉ VERTICAL CPVN2-ZB : 11136																
11136	0295	1600	XXXX	YYYY	-0000	20	595	1600	2125	1066	1,35	60,40	31,60	-	1700	1955
		1800				20	595	1800	2348	1178	1,35	67,60	35,80	-	1844	2121
		2000				20	595	2000	2557	1283	1,35	74,60	40,20	-	1982	2279
		2200				20	595	2200	2754	1382	1,35	81,20	42,60	-	2115	2432
		2400				20	595	2400	2938	1474	1,35	87,60	45,20	-	2247	2584
		2600				20	595	2600	3110	1561	1,35	94,20	47,80	-	2372	2728
		2800				20	595	2800	3269	1640	1,35	100,60	50,20	-	2495	2869
		3000				20	595	3000	3417	1715	1,35	107,20	52,80	-	2616	3008
11136	0655	1600	XXXX	YYYY	-0000	22	655	1600	2337	1173	1,35	66,44	34,76	-	1869	2149
		1800				22	655	1800	2582	1296	1,35	74,36	39,38	-	2027	2331
		2000				22	655	2000	2812	1411	1,35	82,06	44,22	-	2183	2510
		2200				22	655	2200	3029	1520	1,35	89,32	46,86	-	2327	2676
		2400				22	655	2400	3232	1622	1,35	96,36	49,72	-	2472	2843
		2600				22	655	2600	3421	1717	1,35	103,62	52,58	-	2610	3002
		2800				22	655	2800	3596	1804	1,35	110,66	55,22	-	2745	3157
		3000				22	655	3000	3759	1886	1,35	117,92	58,08	-	2878	3310
11136	0715	1600	XXXX	YYYY	-0000	24	715	1600	2550	1280	1,35	72,48	37,92	-	2041	2347
		1800				24	715	1800	2817	1413	1,35	81,12	42,96	-	2211	2543
		2000				24	715	2000	3069	1540	1,35	89,52	48,24	-	2378	2735
		2200				24	715	2200	3305	1658	1,35	97,44	51,12	-	2538	2919
		2400				24	715	2400	3526	1769	1,35	105,12	54,24	-	2696	3100
		2600				24	715	2600	3732	1873	1,35	113,04	57,36	-	2848	3275
		2800				24	715	2800	3923	1968	1,35	120,72	60,24	-	2994	3443
		3000				24	715	3000	4101	2058	1,35	128,64	63,36	-	3143	3614
11136	0775	1600	XXXX	YYYY	-0000	26	775	1600	2762	1386	1,35	78,52	41,08	-	2211	2543
		1800				26	775	1800	3052	1531	1,35	87,88	46,54	-	2395	2754
		2000				26	775	2000	3324	1668	1,35	96,98	52,26	-	2577	2964
		2200				26	775	2200	3580	1796	1,35	105,56	55,38	-	2751	3164
		2400				26	775	2400	3820	1917	1,35	113,88	58,76	-	2919	3357
		2600				26	775	2600	4043	2029	1,35	122,46	62,14	-	3086	3549
		2800				26	775	2800	4250	2133	1,35	130,78	65,26	-	3243	3729
		3000				26	775	3000	4442	2229	1,35	139,36	68,64	-	3402	3912
11136	0895	1600	XXXX	YYYY	-0000	30	895	1600	3187	1599	1,35	90,60	47,40	-	2550	2933
		1800				30	895	1800	3521	1767	1,35	101,40	53,70	-	2765	3180
		2000				30	895	2000	3836	1925	1,35	111,90	60,30	-	2970	3416
		2200				30	895	2200	4131	2073	1,35	121,80	63,90	-	3176	3652
		2400				30	895	2400	4407	2211	1,35	131,40	67,80	-	3365	3870
		2600				30	895	2600	4665	2341	1,35	141,30	71,70	-	3559	4093

In conformity with EN442-1: 2014: radiators and convectors

For heat outputs in other regimes, see p. 320 (correction factors)
 EXPORT. Prices in Euro (excl. VAT)

CARRÉ HORIZONTAL (CPHN1-RO, CPHN2-RO)



TYPES

- One (CPHN1-RO) or two rows (CPHN2-RO) of tubes

TUBES

- Horizontal, square 25 x 25 mm

COLLECTORS

- Vertical, round Ø 35 mm

COLOURS

- Standard colour white RAL 9016
- Extensive colour chart see p. 10

SPECIAL

- CPHN1-RO also available as toilet radiator (600 x 415 mm)

BRACKETS

- Wall brackets in the colour RAL 9016 standard. Also in option available in the colour RAL 7016 (see p. 167).

TECHNICAL

- Welded by means of resistance welding robots (invisible weld seams)
- KTL priming coat, powder coating
- Standard operating pressure: 10 bar
- Maximum operating temperature: 110°C

ELECTRICAL

- ✗ Pure electrical radiator prefilled
- ✗ Mixed radiator

TECHNICAL DRAWINGS

- See p. 171

CONNECTION

- ✓ One-point connection for one-pipe system (order as special radiator) **(on demand)** (see p. 313)
- ✓ One-point connection for two-pipe system (order as special radiator) **(on demand)** (see p. 313)
- ✗ Two-point connection for one-pipe system
- ✓ Two-point connection for two-pipe system (standard) (see p. 312)
- ✗ Integrated valve
- Connections: 1/2" (inner thread)

CARRÉ HORIZONTAL

Top design for all your heating requirements

The horizontal version of the Carré, with your choice of one or two rows of pipes, for customised heat emission in any room. A designer radiator that also in the horizontal version, stands out thanks to its sleek design and flat look, enhanced by the fully integrated collector.

RECOMMENDED CONNECTION (0018)

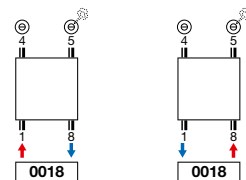

Other connection methods, see p. 169



ref. nr. 1182 101 0000 0099

price € 218

Fittings, see p. 327

RECOMMENDED FOR BATHROOM AND KITCHEN IN OPTION



towel rail straight (chrome)

ref. nr. see p. 168

price € 187

Other accessories, see p. 168



HOW TO ORDER CARRÉ HORIZONTAL

Delivery time 15 - 30 working days
(transport duration not included)

CARRÉ HORIZONTAL (CPHN1-RO)

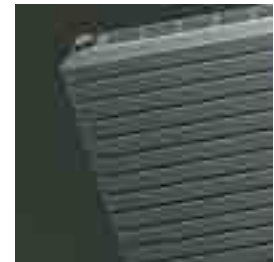
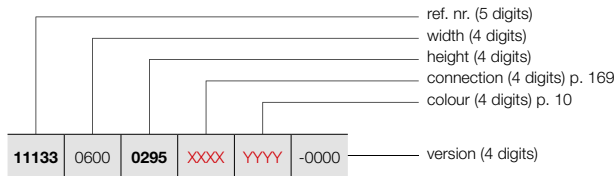

CPHN1-RO

PRICE GROUP: VPG2 - STEEL DESIGN RADIATORS

REFERENCE CODE CUSTOM MADE CARRÉ HORIZONTAL	TECHNICAL DATA									STANDARD COLOUR	OTHER COLOURS					
	tubes	width (L mm)	height (H mm)	75/65/20 (Watt) (φ50K)	55/45/20 (Watt) (φ30K)	n-exp.	weight (kg)	water content (l)	electr. resistance (Watt)	price RAL 9016 (€)	price colour (€)					
REF. NR. CARRÉ HORIZONTAL CPHN1-RO : 11133																
11133	0600	0295	XXXX	YYYY	-0000	10	600	295	221	117	1,25	6,19	2,85	-	231	266
		0355				12	600	355	259	137	1,25	7,41	3,60	-	280	322
		0415				14	600	415	296	156	1,25	8,63	4,35	-	324	373
		0475				16	600	475	333	176	1,25	9,86	5,10	-	373	429
		0535				18	600	535	369	195	1,25	11,08	5,85	-	419	482
		0595				20	600	595	404	213	1,25	12,30	6,60	-	464	534
		0655				22	600	655	439	231	1,26	13,42	6,94	-	512	589
		0775				26	600	775	507	266	1,26	15,67	7,63	-	604	695
		0895				30	600	895	574	302	1,26	17,91	8,31	-	697	802
11133	0800	0295	XXXX	YYYY	-0000	10	800	295	295	156	1,25	8,25	3,80	-	286	329
		0355				12	800	355	346	183	1,25	9,88	4,80	-	338	389
		0415				14	800	415	395	209	1,25	11,51	5,80	-	395	454
		0475				16	800	475	444	234	1,25	13,14	6,80	-	454	522
		0535				18	800	535	492	260	1,25	14,77	7,80	-	510	587
		0595				20	800	595	538	284	1,25	16,40	8,80	-	566	651
		0655				22	800	655	585	307	1,26	17,90	9,26	-	623	716
		0775				26	800	775	676	355	1,26	20,89	10,17	-	738	849
		0895				30	800	895	766	402	1,26	23,88	11,08	-	850	978
11133	1000	0295	XXXX	YYYY	-0000	10	1000	295	369	195	1,25	10,31	4,75	-	327	376
		0355				12	1000	355	432	228	1,25	12,35	6,00	-	395	454
		0415				14	1000	415	494	261	1,25	14,39	7,25	-	461	530
		0475				16	1000	475	555	293	1,25	16,43	8,50	-	529	608
		0535				18	1000	535	615	325	1,25	18,46	9,75	-	595	684
		0595				20	1000	595	673	355	1,25	20,50	11,00	-	661	760
		0655				22	1000	655	731	384	1,26	22,37	11,57	-	728	837
		0775				26	1000	775	845	444	1,26	26,11	12,71	-	858	987
		0895				30	1000	895	957	503	1,26	29,85	13,85	-	990	1139
11133	1200	0295	XXXX	YYYY	-0000	10	1200	295	443	234	1,25	12,37	5,70	-	374	430
		0355				12	1200	355	518	274	1,25	14,82	7,20	-	450	518
		0415				14	1200	415	593	313	1,25	17,27	8,70	-	524	603
		0475				16	1200	475	666	352	1,25	19,72	10,20	-	598	688
		0535				18	1200	535	738	390	1,25	22,15	11,70	-	674	775
		0595				20	1200	595	808	427	1,25	24,60	13,20	-	750	863
		0655				22	1200	655	877	461	1,26	26,84	13,88	-	823	946
		0775				26	1200	775	1014	533	1,26	31,33	15,25	-	974	1120
		0895				30	1200	895	1148	603	1,26	35,82	16,62	-	1121	1289
11133	1400	0295	XXXX	YYYY	-0000	10	1400	295	517	273	1,25	14,43	6,65	-	415	477
		0355				12	1400	355	605	319	1,25	17,29	8,40	-	498	573
		0415				14	1400	415	692	365	1,25	20,15	10,15	-	584	672
		0475				16	1400	475	777	410	1,25	23,00	11,90	-	666	766
		0535				18	1400	535	861	455	1,25	25,84	13,65	-	750	863
		0595				20	1400	595	942	497	1,25	28,70	15,40	-	832	957
		0655				22	1400	655	1023	537	1,26	31,32	16,20	-	916	1053
		0775				26	1400	775	1183	622	1,26	36,55	17,79	-	1081	1243
		0895				30	1400	895	1340	704	1,26	41,79	19,39	-	1245	1432

In conformity with EN442-1: 2014: radiators and convectors

For heat outputs in other regimes, see p. 320 (correction factors)
EXPORT. Prices in Euro (excl. VAT)

CARRÉ HORIZONTAL (CPHN1-RO)

HOW TO ORDER CARRÉ HORIZONTAL

Delivery time 15 - 30 working days
(transport duration not included)

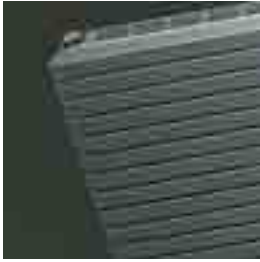

CPHN1-RO

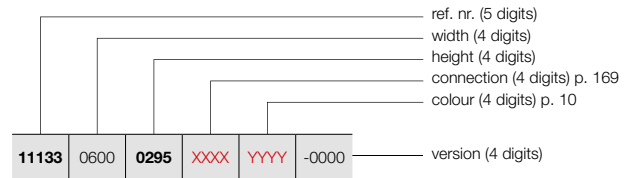

PRICE GROUP: VPG2 - STEEL DESIGN RADIATORS

REFERENCE CODE CUSTOM MADE CARRÉ HORIZONTAL							TECHNICAL DATA						STANDARD COLOUR	OTHER COLOURS		
ref. nr.	width (L mm)	height (H mm)	75/65/20 (Watt) (φ50K)	55/45/20 (Watt) (φ30K)	n-exp.	weight (kg)	water content (l)	electr. resistance (Watt)	price RAL 9016 (€)	price colour (€)						
REF. NR. CARRÉ HORIZONTAL CPHN1-RO : 11133																
11133	1600	0295	XXXX	YYYY	-0000	10	1600	295	590	312	1,25	16,50	7,60	-	456	524
						12	1600	355	691	365	1,25	19,76	9,60	-	544	626
						14	1600	415	790	417	1,25	23,02	11,60	-	637	733
						16	1600	475	888	469	1,25	26,29	13,60	-	730	840
						18	1600	535	984	520	1,25	29,54	15,60	-	821	944
						20	1600	595	1077	569	1,25	32,80	17,60	-	909	1045
						22	1600	655	1170	615	1,26	35,79	18,51	-	1001	1151
						26	1600	775	1352	710	1,26	41,78	20,34	-	1185	1363
						30	1600	895	1531	804	1,26	47,76	22,16	-	1367	1572
						11133	1800	0295	XXXX	YYYY	-0000	10	1800	295	664	351
12	1800	355	778	411	1,25							22,23	10,80	-	595	684
14	1800	415	889	469	1,25							25,90	13,05	-	691	795
16	1800	475	999	528	1,25							29,57	15,30	-	788	906
18	1800	535	1107	585	1,25							33,23	17,55	-	889	1022
20	1800	595	1211	639	1,25							36,90	19,80	-	989	1137
22	1800	655	1316	691	1,26							40,27	20,83	-	1084	1247
26	1800	775	1521	799	1,26							47,00	22,88	-	1284	1477
30	1800	895	1723	905	1,26							53,73	24,93	-	1483	1705
11133	2000	0295	XXXX	YYYY	-0000							10	2000	295	738	390
						12	2000	355	864	456	1,25	24,70	12,00	-	636	731
						14	2000	415	988	522	1,25	28,78	14,50	-	743	854
						16	2000	475	1110	586	1,25	32,86	17,00	-	850	978
						18	2000	535	1230	650	1,25	36,92	19,50	-	957	1101
						20	2000	595	1346	711	1,25	41,00	22,00	-	1062	1221
						22	2000	655	1462	768	1,26	44,74	23,14	-	1167	1342
						26	2000	775	1690	888	1,26	52,22	25,42	-	1380	1587
						30	2000	895	1914	1006	1,26	59,70	27,70	-	1593	1832
						11133	2200	0295	XXXX	YYYY	-0000	10	2200	295	812	429
12	2200	355	950	502	1,25							27,17	13,20	-	680	782
14	2200	415	1087	574	1,25							31,66	15,95	-	791	910
16	2200	475	1221	645	1,25							36,15	18,70	-	905	1041
18	2200	535	1353	714	1,25							40,61	21,45	-	1020	1173
20	2200	595	1481	782	1,25							45,10	24,20	-	1134	1304
22	2200	655	1608	845	1,26							49,21	25,45	-	1245	1432
26	2200	775	1859	977	1,26							57,44	27,96	-	1472	1693
30	2200	895	2105	1106	1,26							65,67	30,47	-	1700	1955
11133	2400	0295	XXXX	YYYY	-0000							10	2400	295	886	468
						12	2400	355	1037	548	1,25	29,64	14,40	-	720	828
						14	2400	415	1186	626	1,25	34,54	17,40	-	842	968
						16	2400	475	1332	703	1,25	39,43	20,40	-	961	1105
						18	2400	535	1476	779	1,25	44,30	23,40	-	1082	1244
						20	2400	595	1615	853	1,25	49,20	26,40	-	1204	1385
						22	2400	655	1754	922	1,26	53,69	27,77	-	1323	1521
						26	2400	775	2028	1065	1,26	62,66	30,50	-	1564	1799
						30	2400	895	2297	1207	1,26	71,64	33,24	-	1804	2075

In conformity with EN442-1: 2014: radiators and convectors

For heat outputs in other regimes, see p. 320 (correction factors)
EXPORT. Prices in Euro (excl. VAT)

HOW TO ORDER CARRÉ HORIZONTAL

Delivery time 15 - 30 working days
(transport duration not included)

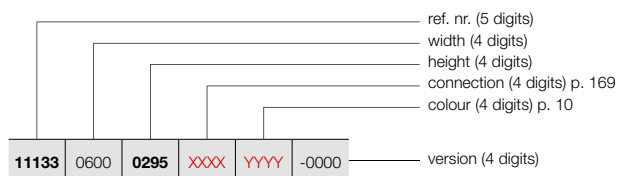

CARRÉ HORIZONTAL (CPHN1-RO)

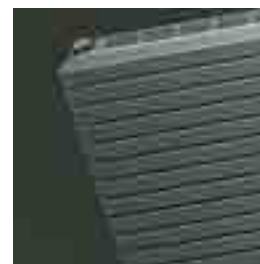

CPHN1-RO

PRICE GROUP: VPG2 - STEEL DESIGN RADIATORS

REFERENCE CODE CUSTOM MADE CARRÉ HORIZONTAL	TECHNICAL DATA									STANDARD COLOUR	OTHER COLOURS					
	tubes	width (L mm)	height (H mm)	75/65/20 (Watt) (φ50K)	55/45/20 (Watt) (φ30K)	n-exp.	weight (kg)	water content (l)	electr. resistance (Watt)	price RAL 9016 (€)	price colour (€)					
REF. NR. CARRÉ HORIZONTAL CPHN1-RO : 11133																
11133	2600	0295	XXXX	YYYY	-0000	10	2600	295	959	506	1,25	26,81	12,35	-	635	730
		0355				12	2600	355	1123	593	1,25	32,11	15,60	-	761	875
		0415				14	2600	415	1284	678	1,25	37,41	18,85	-	889	1022
		0475				16	2600	475	1443	762	1,25	42,72	22,10	-	1015	1167
		0535				18	2600	535	1599	844	1,25	48,00	25,35	-	1146	1318
		0595				20	2600	595	1750	924	1,25	53,30	28,60	-	1271	1462
		0655				22	2600	655	1901	999	1,26	58,16	30,08	-	1399	1609
		0775				26	2600	775	2197	1154	1,26	67,89	33,05	-	1651	1899
		0895				30	2600	895	2488	1307	1,26	77,61	36,01	-	1907	2193
11133		2800				0295	XXXX	YYYY	-0000	10	2800	295	1033	545	1,25	28,87
	0355		12	2800	355	1210				639	1,25	34,58	16,80	-	802	922
	0415		14	2800	415	1383				730	1,25	40,29	20,30	-	933	1073
	0475		16	2800	475	1554				821	1,25	46,00	23,80	-	1070	1231
	0535		18	2800	535	1722				909	1,25	51,69	27,30	-	1204	1385
	0595		20	2800	595	1884				995	1,25	57,40	30,80	-	1337	1538
	0655		22	2800	655	2047				1075	1,26	62,64	32,40	-	1471	1692
	0775		26	2800	775	2366				1243	1,26	73,11	35,59	-	1738	1999
	0895		30	2800	895	2680				1408	1,26	83,58	38,78	-	2007	2308
11133	3000		0295	XXXX	YYYY	-0000				10	3000	295	1107	585	1,25	30,93
		0355	12				3000	355	1296	684	1,25	37,05	18,00	-	841	967
		0415	14				3000	415	1482	783	1,25	43,17	21,75	-	982	1129
		0475	16				3000	475	1665	879	1,25	49,29	25,50	-	1121	1289
		0535	18				3000	535	1845	974	1,25	55,38	29,25	-	1264	1454
		0595	20				3000	595	2019	1066	1,25	61,50	33,00	-	1401	1611
		0655	22				3000	655	2193	1152	1,26	67,11	34,71	-	1542	1773
		0775	26				3000	775	2535	1332	1,26	78,33	38,13	-	1823	2096
		0895	30				3000	895	2871	1508	1,26	89,55	41,55	-	2105	2421

In conformity with EN442-1: 2014: radiators and convectors

For heat outputs in other regimes, see p. 320 (correction factors)
EXPORT. Prices in Euro (excl. VAT)

CARRÉ HORIZONTAL (CPHN2-RO)

HOW TO ORDER CARRÉ HORIZONTAL

Delivery time 15 - 30 working days
(transport duration not included)

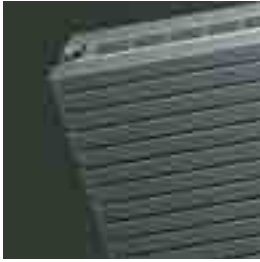

CPHN2-RO

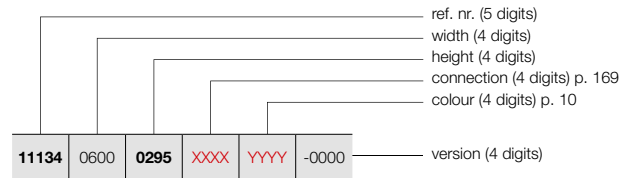

PRICE GROUP: VPG2 - STEEL DESIGN RADIATORS

REFERENCE CODE CUSTOM MADE CARRÉ HORIZONTAL						TECHNICAL DATA						STANDARD COLOUR	OTHER COLOURS			
tubes	width (L mm)	height (H mm)	75/65/20 (Watt) (φ50K)	55/45/20 (Watt) (φ30K)	n-exp.	weight (kg)	water content (l)	electr. resistance (Watt)	price RAL 9016 (€)	price colour (€)						
REF. NR. CARRÉ HORIZONTAL CPHN2-RO : 11134																
11134	0600	0295	XXXX	YYYY	-0000	10	600	295	377	200	1,24	11,94	6,06	-	455	523
			0355	12		600	355	459	242	1,25	14,26	7,27	-	542	623	
			0415	14		600	415	539	282	1,27	16,57	8,48	-	635	730	
			0475	16		600	475	617	321	1,28	18,89	9,70	-	726	835	
			0535	18		600	535	693	359	1,29	21,20	10,91	-	818	941	
			0595	20		600	595	766	394	1,30	23,52	12,12	-	905	1041	
			0655	22		600	655	836	430	1,30	25,85	13,39	-	997	1147	
			0775	26		600	775	967	498	1,30	30,50	15,94	-	1179	1356	
			0895	30		600	895	1087	560	1,30	35,16	18,48	-	1362	1566	
			11134	0800		0295	XXXX	YYYY	-0000	10	800	295	503	267	1,24	15,92
0355	12	800			355		612	323		1,25	19,01	9,70	-	664	764	
0415	14	800			415		719	376		1,27	22,10	11,31	-	773	889	
0475	16	800			475		823	428		1,28	25,18	12,93	-	883	1015	
0535	18	800			535		924	478		1,29	28,27	14,54	-	995	1144	
0595	20	800			595		1021	526		1,30	31,36	16,16	-	1106	1272	
0655	22	800			655		1114	573		1,30	34,46	17,86	-	1215	1397	
0775	26	800			775		1290	664		1,30	40,67	21,25	-	1435	1650	
0895	30	800			895		1449	746		1,30	46,88	24,64	-	1656	1904	
11134	1000	0295			XXXX		YYYY	-0000		10	1000	295	629	334	1,24	19,90
			0355	12	1000	355	765		404	1,25	23,76	12,12	-	773	889	
			0415	14	1000	415	899		470	1,27	27,62	14,14	-	901	1036	
			0475	16	1000	475	1029		535	1,28	31,48	16,16	-	1030	1185	
			0535	18	1000	535	1155		598	1,29	35,34	18,18	-	1156	1329	
			0595	20	1000	595	1276		657	1,30	39,20	20,20	-	1288	1481	
			0655	22	1000	655	1393		717	1,30	43,08	22,32	-	1418	1631	
			0775	26	1000	775	1612		830	1,30	50,84	26,56	-	1674	1925	
			0895	30	1000	895	1811		932	1,30	58,60	30,80	-	1930	2220	
			11134	1200	0295	XXXX	YYYY		-0000	10	1200	295	755	401	1,24	23,88
0355	12	1200				355	918	485		1,25	28,51	14,54	-	879	1011	
0415	14	1200				415	1079	564		1,27	33,14	16,97	-	1020	1173	
0475	16	1200				475	1235	642		1,28	37,78	19,39	-	1166	1341	
0535	18	1200				535	1386	717		1,29	42,41	21,82	-	1313	1510	
0595	20	1200				595	1531	788		1,30	47,04	24,24	-	1459	1678	
0655	22	1200				655	1672	861		1,30	51,70	26,78	-	1602	1842	
0775	26	1200				775	1934	996		1,30	61,01	31,87	-	1899	2184	
0895	30	1200				895	2173	1119		1,30	70,32	36,96	-	2187	2515	
11134	1400	0295				XXXX	YYYY	-0000		10	1400	295	881	468	1,24	27,86
			0355	12	1400	355	1071		566	1,25	33,26	16,97	-	974	1120	
			0415	14	1400	415	1259		658	1,27	38,67	19,80	-	1136	1306	
			0475	16	1400	475	1441		749	1,28	44,07	22,62	-	1297	1492	
			0535	18	1400	535	1617		837	1,29	49,48	25,45	-	1459	1678	
			0595	20	1400	595	1786		919	1,30	54,88	28,28	-	1621	1864	
			0655	22	1400	655	1950		1004	1,30	60,31	31,25	-	1783	2050	
			0775	26	1400	775	2257		1162	1,30	71,18	37,18	-	2109	2425	
			0895	30	1400	895	2535		1305	1,30	82,04	43,12	-	2430	2795	

In conformity with EN442-1: 2014: radiators and convectors

For heat outputs in other regimes, see p. 320 (correction factors)
EXPORT. Prices in Euro (excl. VAT)

HOW TO ORDER CARRÉ HORIZONTAL

Delivery time 15 - 30 working days
(transport duration not included)

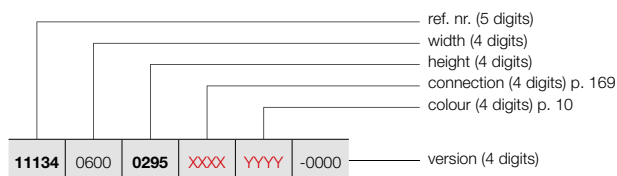

CARRÉ HORIZONTAL (CPHN2-RO)



CPHN2-RO

PRICE GROUP: VPG2 - STEEL DESIGN RADIATORS

REFERENCE CODE CUSTOM MADE CARRÉ HORIZONTAL	TECHNICAL DATA									STANDARD COLOUR	OTHER COLOURS
	tubes	width (L mm)	height (H mm)	75/65/20 (Watt) (φ50K)	55/45/20 (Watt) (φ30K)	n-exp.	weight (kg)	water content (l)	electr. resistance (Watt)	price RAL 9016 (€)	price colour (€)
REF. NR. CARRÉ HORIZONTAL CPHN2-RO : 11134											
11134 1600 0295 XXXX YYYY -0000	10	1600	295	1006	534	1,24	31,84	16,16	-	888	1021
	12	1600	355	1224	646	1,25	38,02	19,39	-	1066	1226
	14	1600	415	1438	752	1,27	44,19	22,62	-	1243	1429
	16	1600	475	1646	856	1,28	50,37	25,86	-	1422	1635
	18	1600	535	1848	956	1,29	56,54	29,09	-	1598	1838
	20	1600	595	2042	1051	1,30	62,72	32,32	-	1778	2045
	22	1600	655	2229	1147	1,30	68,93	35,71	-	1955	2248
	26	1600	775	2579	1328	1,30	81,34	42,50	-	2310	2657
	30	1600	895	2898	1492	1,30	93,76	49,28	-	2663	3062
11134 1800 0295 XXXX YYYY -0000	10	1800	295	1132	601	1,24	35,82	18,18	-	962	1106
	12	1800	355	1377	727	1,25	42,77	21,82	-	1156	1329
	14	1800	415	1618	846	1,27	49,72	25,45	-	1347	1549
	16	1800	475	1852	963	1,28	56,66	29,09	-	1541	1772
	18	1800	535	2079	1076	1,29	63,61	32,72	-	1732	1992
	20	1800	595	2297	1182	1,30	70,56	36,36	-	1928	2217
	22	1800	655	2507	1290	1,30	77,54	40,18	-	2116	2433
	26	1800	775	2902	1494	1,30	91,51	47,81	-	2505	2881
	30	1800	895	3260	1678	1,30	105,48	55,44	-	2888	3321
11134 2000 0295 XXXX YYYY -0000	10	2000	295	1258	668	1,24	39,80	20,20	-	1036	1191
	12	2000	355	1530	808	1,25	47,52	24,24	-	1240	1426
	14	2000	415	1798	940	1,27	55,24	28,28	-	1452	1670
	16	2000	475	2058	1070	1,28	62,96	32,32	-	1656	1904
	18	2000	535	2310	1195	1,29	70,68	36,36	-	1864	2144
	20	2000	595	2552	1314	1,30	78,40	40,40	-	2071	2382
	22	2000	655	2786	1434	1,30	86,16	44,64	-	2278	2620
	26	2000	775	3224	1660	1,30	101,68	53,12	-	2688	3091
	30	2000	895	3622	1864	1,30	117,20	61,60	-	3106	3572
11134 2200 0295 XXXX YYYY -0000	10	2200	295	1384	735	1,24	43,78	22,22	-	1106	1272
	12	2200	355	1683	889	1,25	52,27	26,66	-	1326	1525
	14	2200	415	1978	1034	1,27	60,76	31,11	-	1547	1779
	16	2200	475	2264	1177	1,28	69,26	35,55	-	1765	2030
	18	2200	535	2541	1315	1,29	77,75	40,00	-	1988	2286
	20	2200	595	2807	1445	1,30	86,24	44,44	-	2211	2543
	22	2200	655	3065	1578	1,30	94,78	49,10	-	2430	2795
	26	2200	775	3546	1825	1,30	111,85	58,43	-	2871	3302
	30	2200	895	3984	2051	1,30	128,92	67,76	-	3316	3813
11134 2400 0295 XXXX YYYY -0000	10	2400	295	1510	801	1,24	47,76	24,24	-	1171	1347
	12	2400	355	1836	970	1,25	57,02	29,09	-	1409	1620
	14	2400	415	2158	1128	1,27	66,29	33,94	-	1645	1892
	16	2400	475	2470	1284	1,28	75,55	38,78	-	1876	2157
	18	2400	535	2772	1434	1,29	84,82	43,63	-	2111	2428
	20	2400	595	3062	1576	1,30	94,08	48,48	-	2347	2699
	22	2400	655	3343	1721	1,30	103,39	53,57	-	2578	2965
26	2400	775	3869	1992	1,30	122,02	63,74	-	3050	3508	

In conformity with EN442-1: 2014: radiators and convectors

For heat outputs in other regimes, see p. 320 (correction factors)
EXPORT. Prices in Euro (excl. VAT)

VASCO

CARRÉ HORIZONTAL (CPHN2-RO)



CPHN2-RO

HOW TO ORDER CARRÉ HORIZONTAL

Delivery time 15 - 30 working days
(transport duration not included)

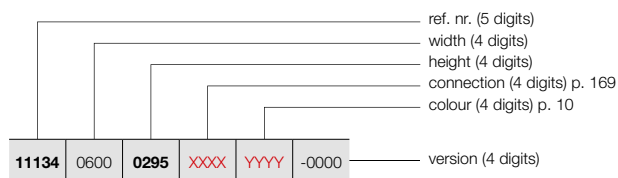

PRICE GROUP: VPG2 - STEEL DESIGN RADIATORS

REFERENCE CODE CUSTOM MADE CARRÉ HORIZONTAL							TECHNICAL DATA					STANDARD COLOUR	OTHER COLOURS			
tubes	width (L mm)	height (H mm)	75/65/20 (Watt) (φ50K)	55/45/20 (Watt) (φ30K)	n-exp.	weight (kg)	water content (l)	electr. resistance (Watt)	price RAL 9016 (€)	price colour (€)						
REF. NR. CARRÉ HORIZONTAL CPHN2-RO : 11134																
11134	2600	0295	XXXX	YYYY	-0000	10	2600	295	1635	868	1,24	51,74	26,26	-	1239	1425
		0355				12	2600	355	1989	1050	1,25	61,78	31,51	-	1487	1710
		0415				14	2600	415	2337	1222	1,27	71,81	36,76	-	1732	1992
		0475				16	2600	475	2675	1391	1,28	81,85	42,02	-	1981	2278
		0535				18	2600	535	3003	1554	1,29	91,88	47,27	-	2230	2565
		0595				20	2600	595	3318	1708	1,30	101,92	52,52	-	2480	2852
		0655				22	2600	655	3622	1864	1,30	112,01	58,03	-	2726	3135
		0775				26	2600	775	4191	2157	1,30	132,18	69,06	-	3223	3706
11134	2800	0295	XXXX	YYYY	-0000	10	2800	295	1761	935	1,24	55,72	28,28	-	1302	1497
		0355				12	2800	355	2142	1131	1,25	66,53	33,94	-	1564	1799
		0415				14	2800	415	2517	1316	1,27	77,34	39,59	-	1825	2099
		0475				16	2800	475	2881	1498	1,28	88,14	45,25	-	2084	2397
		0535				18	2800	535	3234	1673	1,29	98,95	50,90	-	2347	2699
		0595				20	2800	595	3573	1839	1,30	109,76	56,56	-	2607	2998
		0655				22	2800	655	3900	2008	1,30	120,62	62,50	-	2870	3301
11134	3000	0295	XXXX	YYYY	-0000	10	3000	295	1887	1002	1,24	59,70	30,30	-	1368	1573
		0355				12	3000	355	2295	1212	1,25	71,28	36,36	-	1642	1888
		0415				14	3000	415	2697	1410	1,27	82,86	42,42	-	1913	2200
		0475				16	3000	475	3087	1605	1,28	94,44	48,48	-	2187	2515
		0535				18	3000	535	3465	1793	1,29	106,02	54,54	-	2460	2829
		0595				20	3000	595	3828	1970	1,30	117,60	60,60	-	2731	3141
		0655				22	3000	655	4179	2151	1,30	129,24	66,96	-	3008	3459





In conformity with EN442-1: 2014: radiators and convectors

For heat outputs in other regimes, see p. 320 (correction factors)
EXPORT. Prices in Euro (excl. VAT)

PRICE GROUP: VPG10 - ACC.

BRACKETS	HEIGHT / WIDTH RADIATOR	COLOUR	REF. NR.	€
CPVN2-ZB / CPHN1-RO / CPHN2-RO				
WALL SETUP	≤ 2400 mm (4 brackets)	RAL 7016	1187 007 0000 7016	41
	≥ 2600 mm (6 brackets)	RAL 7016	1187 008 0000 7016	64

EXPORT. Prices in Euro (excl. VAT)

ACCESSORIES	WIDTH RADIATOR	COLOUR*	REF. NR.	€
CPVN-PLUS / CPVN2-ZB / CPHN1-RO / CPHN2-RO				
SQUARE HOOK 		CHROME	1183 500 0000 0099	68
<ul style="list-style-type: none"> h = 24 mm; b = 24 mm; d = 65 mm 				
CPVN-PLUS / CPVN2-ZB / CPHN1-RO / CPHN2-RO				
TOWEL RAIL STRAIGHT 		CHROME	1183 207 0000 0099	187
<ul style="list-style-type: none"> h = 24 mm; b = 720 mm (easy adjustable); d = 66 mm; a = 48 mm 				
CPVN-PLUS / CPVN2-ZB				
TOWEL RAIL MULTI+ RIGHT 	600 mm	S600	1183 734 0000 0600	204
	600 mm	RAL 9005 ^S	1183 734 0000 9005	204
<ul style="list-style-type: none"> h = 70 mm; b = 600 mm (b tablet = 194 mm); e = 176 mm; c = 170 mm; Mounting on the wall, to the right of the radiator. 				
CPVN-PLUS / CPVN2-ZB				
TOWEL RAIL MULTI+ LEFT 	600 mm	S600	1183 735 0000 0600	204
	600 mm	RAL 9005 ^S	1183 735 0000 9005	204
<ul style="list-style-type: none"> h = 70 mm; b = 600 mm (b tablet = 194 mm); e = 176 mm; c = 170 mm; Mounting on the wall, to the left of the radiator. 				

^S structure black

* Multi+ is available in the colour of the radiator, if ordered together. Extra charge +15%.

Mounting instructions accessories: see www.vasco.eu

EXPORT. Prices in Euro (excl. VAT)

e = distance front of the accessory up to the wall
d = distance front of the accessory up to front of the radiator
c = distance between wall to back towel bar
a = distance accessory up to the radiator
available from stock

CARRÉ PLUS VERTICAL: CPVN-PLUS (STOCK)

CARRÉ VERTICAL: CPVN2-ZB

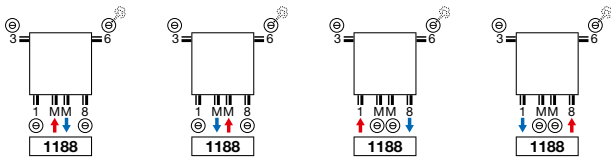

CARRÉ HORIZONTAL: CPHN1-RO / CPHN2-RO

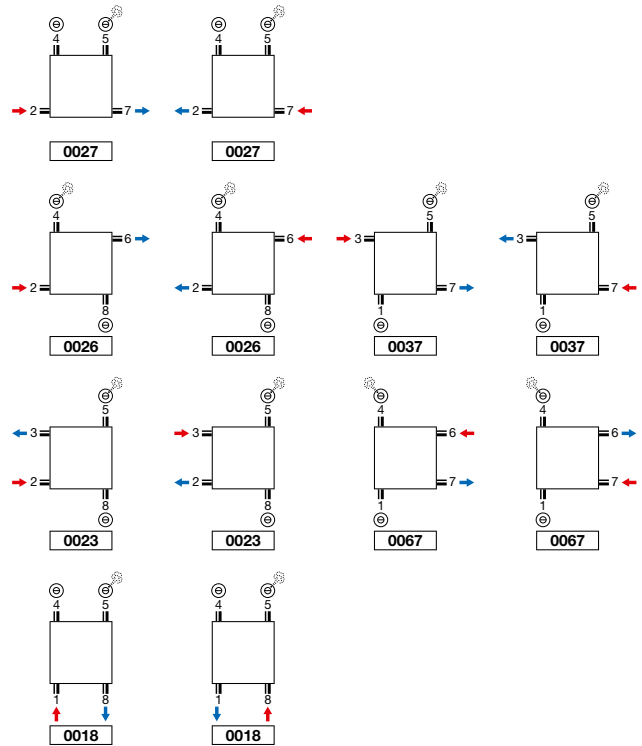

CARRÉ PLUS VERTICAL: CPVN-PLUS (NON STOCK)

CARRÉ VERTICAL: CPVN2-ZB

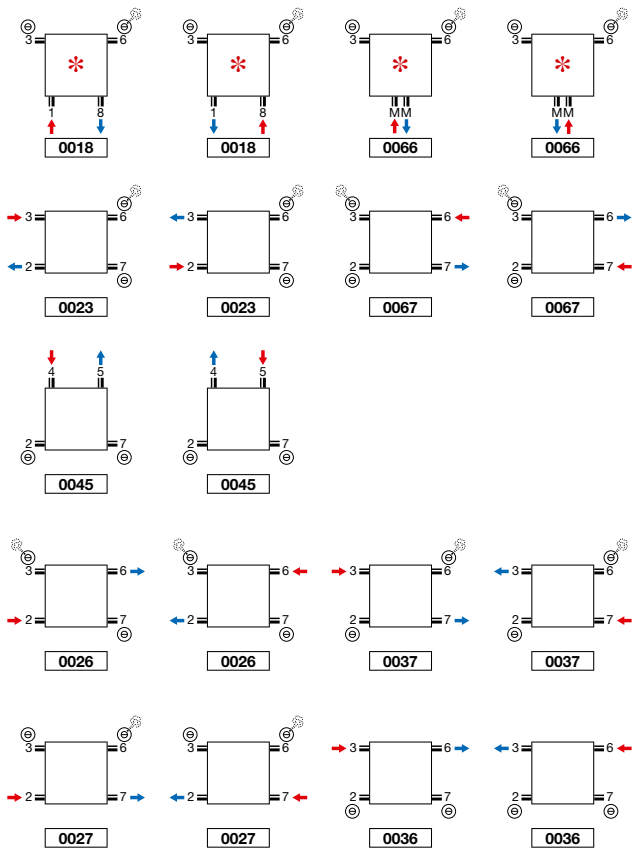

* Attention CPVN-PLUS/CPVN2-ZB 10 tubes: 2/3/6/7 always open.

Attention: connecting the radiator can only be as shown by the connecting icons. For any other connection method, we take no responsibility.

CARRÉ PLUS VERTICAL (CPVN-PLUS)

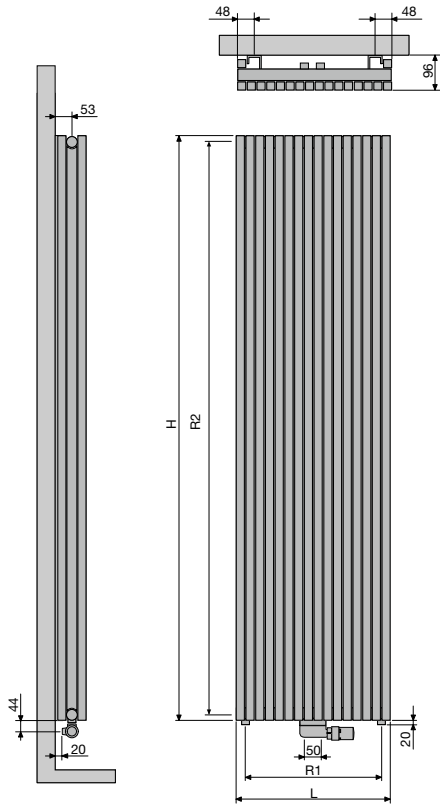

CPVN-PLUS

Number of tubes	10	12	14	16	18	20	22	26	30
Width (L)	295	355	415	475	535	595	655	775	895
Centre between the connections at the bottom 18 (R1)	240	300	360	420	480	540	600	720	840
Height (H)	1400	1600	1800	2000	2200				
Centre between the lateral connections 23/67 (R2)	1365	1565	1765	1965	2165				
Centre between the brackets	L-200	H-290							

CARRÉ VERTICAL (CPVN2-ZB)

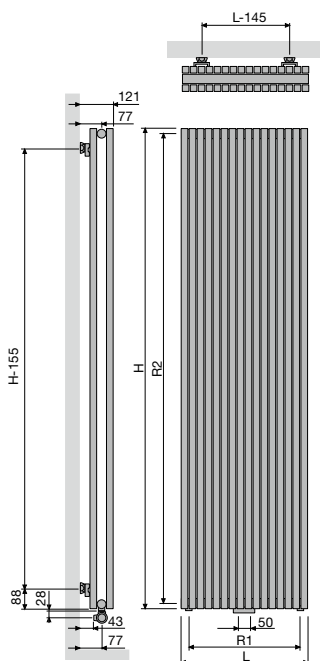

CPVN2-ZB

Number of tubes	10	12	14	16	18	20	22	26	30
Width (L)	295	355	415	475	535	595	655	775	895
Centre between the connections at the bottom 18 (R1)	240	300	360	420	480	540	600	720	840
Height (H)	1400	1600	1800	2000	2200	2400	2600	2800	3000
Centre between the lateral connections 23/67 (R2)	1365	1565	1765	1965	2165	2365	2565	2765	2965
Centre between the brackets	L-145	H-155							

CARRÉ HORIZONTAL (CPHN1-RO, CPHN2-RO)

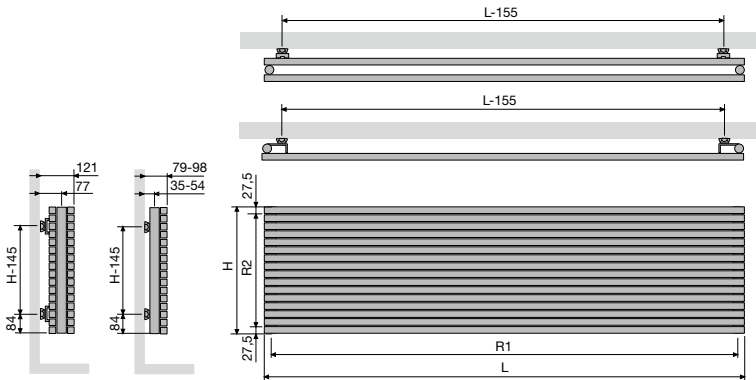

CPHN1-RO / CPHN2-RO

	600	800	1000	1200	1400	1600	1800	2000	2200	2400	2600	2800	3000
Width (L)	600	800	1000	1200	1400	1600	1800	2000	2200	2400	2600	2800	3000
Centre between the connections at the bottom 18 (R1)	565	765	965	1165	1365	1565	1765	1965	2165	2365	2565	2765	2965
Height (H)	295	355	415	475	535	595	655	715	775	835	895		
Centre between the lateral connections 23/67 (R2)	240	300	360	420	480	540	600	660	720	780	840		
Centre between the brackets	L-155	H-145											



TUBES

- Wv: Vertical, rectangular 45 x 20 mm

COLOURS

- Standard colour white RAL 9016
- Extensive colour chart see p. 10

SPECIAL

- The Arche is awarded with the Design Plus Award 2005, Reddot Design Award 2006, Silver Award Designpreis Deutschland 2006 and nominated for the Henry van de Velde prize 2005.

BRACKETS

- Wall brackets standard (telescopic)

TECHNICAL

- KTL priming coat, powder coating
- Standard operating pressure: 4 bar
- Maximum operating temperature: 110°C

ELECTRICAL

- ✗ Pure electrical radiator prefilled
- ✗ Mixed radiator

TECHNICAL DRAWINGS

- See p. 178

CONNECTION

- ✗ One-point connection for one-pipe system
- ✗ One-point connection for two-pipe system
- ✓ Two-point connection for one-pipe system (connection by way of the central connection) (see p. 312)
- ✓ Two-point connection for two-pipe system (standard) (see p. 312)
- ✗ Integrated valve
- Connections: 1/2" (inner thread)

ARCHE VERTICAL

Technology and aesthetics seamlessly united

A designer radiator concept, unique in its kind. The tubes are not mounted on top of each other but rather into each other and together for one seamless, flat structure. The accessories are also nicely integrated into the whole. The perfect relationship between technology and aesthetics provide a unique product that has since won almost all major design prizes, and is also available in a bathroom design with a centre connection.

RECOMMENDED CONNECTION (1188)

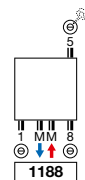

Other connection methods, see p. 177

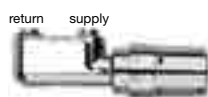

ref. nr. 1182 103 0000 0099
price € 218
 Fittings, see p. 327

RECOMMENDED FOR BATHROOM AND KITCHEN IN OPTION



towel rail (chrome)
 ref. nr. see p. 176
price € 187

Other accessories, see p. 176



HOW TO ORDER ARCHE VERTICAL

Delivery time 15 - 30 working days
(transport duration not included)

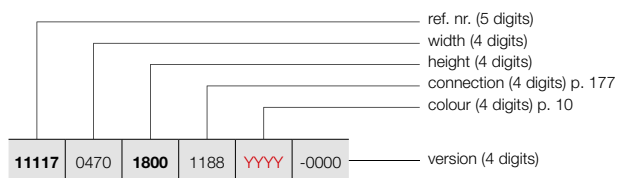

ARCHE VERTICAL (VV)



VV

HOW TO ORDER STOCK RADIATOR ARCHE VERTICAL

Delivery time 5 working days
(transport duration not included)

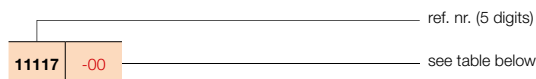

PRICE GROUP: VPG2 - STEEL DESIGN RADIATORS

REFERENCE CODE CUSTOM MADE ARCHE VERTICAL	TECHNICAL DATA									STANDARD COLOUR		OTHER COLOURS					
	tubes	width (L mm)	height (H mm)	75/65/20 (Watt (φ50K))	55/45/20 (Watt (φ30K))	n-exp.	weight (kg)	water content (l)	electr. resistance (Watt)	price RAL 9016 (€)	short ref. nr. RAL 9016 stock	price colour (€)					
REF. NR. ARCHE VERTICAL VV : 11117																	
11117	0470	1800	1188	YYY	-0000	10	470	1800	1050	560	1,23	22,90	13,94	-	541	11117-03	622
		2000				10	470	2000	1164	618	1,24	25,36	15,42	-	582	-	669
		2200				10	470	2200	1279	679	1,24	27,81	16,91	-	609	-	700
11117	0570	1800	1188	YYY	-0000	12	570	1800	1273	679	1,23	27,78	16,90	-	660	-	759
		2000				12	570	2000	1412	749	1,24	30,76	18,70	-	704	-	810
		2200				12	570	2200	1552	824	1,24	33,73	20,50	-	742	-	853
11117	0670	1800	1188	YYY	-0000	14	670	1800	1496	798	1,23	32,65	19,87	-	774	-	890
		2000				14	670	2000	1660	881	1,24	36,15	21,98	-	828	-	952
		2200				14	670	2200	1824	968	1,24	39,65	24,10	-	870	-	1001

In conformity with EN442-1: 2014: radiators and convectors

For heat outputs in other regimes, see p. 320 (correction factors)
EXPORT. Prices in Euro (excl. VAT)

ARCHE PLUS VERTICAL (VWL, VWR)



TYPES

- VWR (towel bar right), VWL (towel bar left)

TUBES

- Vertical, rectangular 45 x 20 mm

COLOURS

- Standard colour white RAL 9016
- Extensive colour chart see p. 10

SPECIAL

- Fixed towel bar, finished with the same powder coating as the radiator
- Attention: this towel bar does not heat!

BRACKETS

- Wall brackets standard (telescopic)

TECHNICAL

- KTL priming coat, powder coating
- Standard operating pressure: 4 bar
- Maximum operating temperature: 110°C

ELECTRICAL

- ✗ Pure electrical radiator prefilled
- ✗ Mixed radiator

TECHNICAL DRAWINGS

- See p. 178

CONNECTION

- ✗ One-point connection for one-pipe system
- ✗ One-point connection for two-pipe system
- ✓ Two-point connection for one-pipe system (connection by way of the central connection) (see p. 312)
- ✓ Two-point connection for two-pipe system (standard) (see p. 312)
- ✗ Integrated valve
- Connections: 1/2" (inner thread)

ARCHE PLUS VERTICAL

Functional beauty across the board

A designer radiator with the unique, flat design of the Arche complemented by a seamlessly welded-on towel rail. Together they form a beautiful whole, accentuated by the perfect relation between the Arche's design and its functionality.

RECOMMENDED CONNECTION (1188)

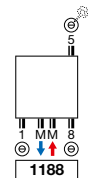

Other connection methods, see p. 177

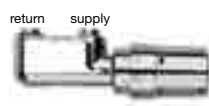

ref. nr. 1182 103 0000 0099

price € 218

Fittings, see p. 327



HOW TO ORDER ARCHE PLUS VERTICAL

Delivery time 15 - 30 working days
(transport duration not included)

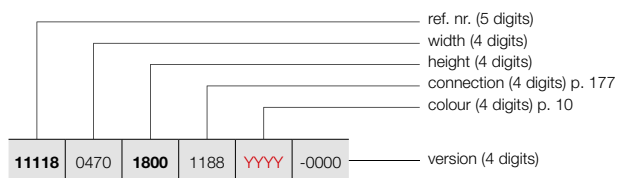

ARCHE PLUS VERTICAL (VL, VWR)



VL

VWR

HOW TO ORDER STOCK RADIATOR ARCHE PLUS VERTICAL

Delivery time 5 working days
(transport duration not included)

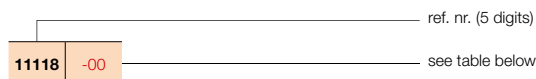

PRICE GROUP: VPG2 - STEEL DESIGN RADIATORS



REFERENCE CODE CUSTOM MADE ARCHE PLUS VERTICAL	TECHNICAL DATA									STANDARD COLOUR		OTHER COLOURS					
	tubes	width (L mm)	height (H mm)	75/65/20 (Watt) (φ50K)	55/45/20 (Watt) (φ30K)	n-exp.	weight (kg)	water content (l)	electr. resistance (Watt)	price RAL 9016 (€)	short ref. nr. RAL 9016 stock	price colour (€)					
REF. NR. ARCHE PLUS VERTICAL VL : 11118																	
11118	0470	1800	1188	YYYY	-0000	10	470	1800	1050	560	1,23	23,49	13,94	-	726	11118-01	835
		2000				10	470	2000	1164	618	1,24	25,95	15,42	-	775	-	891
		2200				10	470	2200	1279	679	1,24	28,40	16,91	-	816	-	938
11118	0570	1800	1188	YYYY	-0000	12	570	1800	1273	679	1,23	28,44	16,90	-	880	-	1012
		2000				12	570	2000	1412	749	1,24	31,42	18,70	-	937	-	1078
		2200				12	570	2200	1552	824	1,24	34,40	20,50	-	990	-	1139
11118	0670	1800	1188	YYYY	-0000	14	670	1800	1496	798	1,23	33,39	19,87	-	1031	-	1186
		2000				14	670	2000	1660	881	1,24	36,89	21,98	-	1105	-	1271
		2200				14	670	2200	1824	968	1,24	40,39	24,10	-	1161	-	1335
REF. NR. ARCHE PLUS VERTICAL VWR : 11119																	
11119	0470	1800	1188	YYYY	-0000	10	470	1800	1050	560	1,23	23,49	13,94	-	726	11119-01	835
		2000				10	470	2000	1164	618	1,24	25,95	15,42	-	775	-	891
		2200				10	470	2200	1279	679	1,24	28,40	16,91	-	816	-	938
11119	0570	1800	1188	YYYY	-0000	12	570	1800	1273	679	1,23	28,44	16,90	-	880	-	1012
		2000				12	570	2000	1412	749	1,24	31,42	18,70	-	937	-	1078
		2200				12	570	2200	1552	824	1,24	34,40	20,50	-	990	-	1139
11119	0670	1800	1188	YYYY	-0000	14	670	1800	1496	798	1,23	33,39	19,87	-	1031	-	1186
		2000				14	670	2000	1660	881	1,24	36,89	21,98	-	1105	-	1271
		2200				14	670	2200	1824	968	1,24	40,39	24,10	-	1161	-	1335

In conformity with EN442-1: 2014: radiators and convectors

For heat outputs in other regimes, see p. 320 (correction factors)
EXPORT. Prices in Euro (excl. VAT)

ARCHE ACCESSORIES
IN OPTION

PRICE GROUP: VPG10B - TOWEL RAILS

ACCESSORIES		COLOUR	REF. NR.	€
HOOK		WV / VWL / WVR		
		CHROME	118341000000099	87
TOWEL RAIL		WV		
		CHROME	118322800000099	187

- h = 70 mm; b = 70 mm; d = 59 mm; a = 51 mm;

- h = 22 mm; b = 720 mm (easy adjustable) d = 75 mm; a = 56 mm

Mounting instructions accessories: see www.vasco.eu
EXPORT. Prices in Euro (excl. VAT)

d = distance front of the accessory up to front of the radiator
a = distance accessory up to the radiator
available from stock

ARCHE VERTICAL: W
 ARCHE PLUS VERTICAL: WL / WR

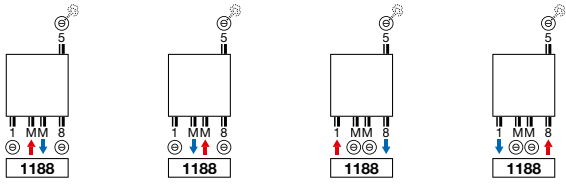

Attention: connecting the radiator can only be as shown by the connecting icons. For any other connection method, we take no responsibility.

ARCHE VERTICAL (VV)

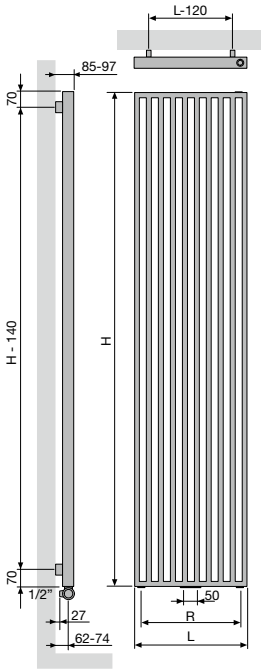

	VV		
Number of tubes	10	12	14
Width (L)	470	570	670
Centre between the connections at the bottom 18 (R)	370	470	570
Centre between the brackets	L-120	H-140	

VASCO

ARCHE PLUS VERTICAL (VWL, VWR)

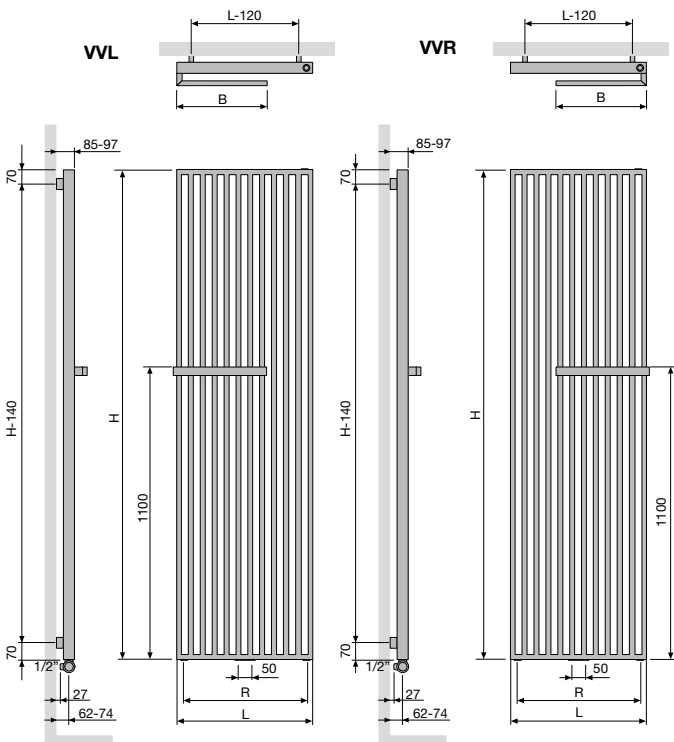

	VWL / VWR		
Number of tubes	10	12	14
Width (L)	470	570	670
Centre between the connections at the bottom 18 (R)	370	470	570
Width towel rail (B)	335	385	435
Centre between the brackets	L-120	H-140	

TYPES

- One (ZV-1) or two rows (ZV-2)

TUBES

- Vertical, rectangular 45 x 20 mm

COLLECTORS

- Horizontal, rear, round Ø 35 mm

COLOURS

- Standard colour white RAL 9016
- Extensive colour chart see p. 10

BRACKETS

- Wall brackets standard

TECHNICAL

- Electrically laser welded (invisible weld seams)
- KTL priming coat, powder coating
- Standard operating pressure: 4 bar
- Maximum operating temperature: 110°C

ELECTRICAL

- ✗ Pure electrical radiator prefilled
- ✗ Mixed radiator

TECHNICAL DRAWINGS

- See p. 191

CONNECTION

- ✓ One-point connection for one-pipe system (order as special radiator) **(on demand)** (see p. 313)
- ✓ One-point connection for two-pipe system (order as special radiator) **(on demand)** (see p. 313)
- ✓ Two-point connection for one-pipe system (connection by way of the central connection) (see p. 312)
- ✓ Two-point connection for two-pipe system (standard) (see p. 312)
- ✗ Integrated valve
- Connections: ½" (inner thread)



VASCO

RECOMMENDED CONNECTION (1188)

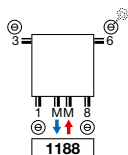

Other connection methods, see p. 190

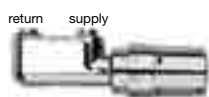

ref. nr. 1182 103 0000 0099

price € 218

Fittings, see p. 327

RECOMMENDED FOR BATHROOM AND KITCHEN IN OPTION



towel rail straight (chrome)

ref. nr. see p. 189

price € 187

Other accessories, see p. 189

ZANA VERTICAL

Tradition and trends in perfect harmony

The Zana combines an unbeatable power with timeless lines. A classic that remains captivating because of its power, class and comfort.

The retro feeling is never far away. Modernity is abounding in this unique range of designer radiators for every environment, every room, and every use.



ZANA VERTICAL (ZV-1)



ZV-1

HOW TO ORDER ZANA VERTICAL

Delivery time 15 - 30 working days
(transport duration not included)

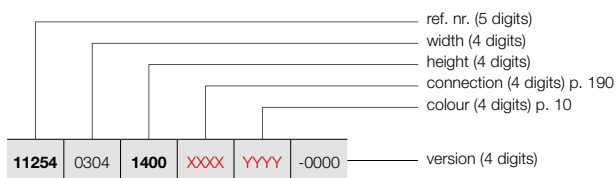

PRICE GROUP: VPG2 - STEEL DESIGN RADIATORS

REFERENCE CODE CUSTOM MADE ZANA VERTICAL						TECHNICAL DATA								STANDARD COLOUR		OTHER COLOURS					
						tubes	width (L mm)	height (H mm)	75/65/20 (Watt) (φ50K)	55/45/20 (Watt) (φ30K)	n-exp.	weight (kg)	water content (l)	electr. resistance (Watt)	price RAL 9016 (€)	short ref. nr. RAL 9016 stock	price colour (€)				
REF. NR. ZANA VERTICAL ZV-1 : 11254																					
11254	0304	1400	XXXX	YYYY	-0000	8	304	1400	680	359	1,27	18,16	8,24	-	456	-	524				
		1600				8	304	1600	769	406	1,27	20,72	9,44	-	495	-	569				
		1800				8	304	1800	859	454	1,28	23,20	10,64	-	535	-	615				
		2000				8	304	2000	950	502	1,28	25,68	11,68	-	572	-	658				
		2200				8	304	2200	1042	550	1,28	28,08	12,72	-	611	-	703				
		2400				8	304	2400	1136	600	1,29	30,56	13,76	-	656	-	754				
		2600				8	304	2600	1231	650	1,29	33,04	14,80	-	694	-	798				
		2800				8	304	2800	1327	701	1,29	35,44	15,84	-	732	-	842				
		3000			8	304	3000	1426	753	1,29	37,92	16,88	-	773	-	889					
11254	0384	1400	XXXX	YYYY	-0000	10	384	1400	850	449	1,27	22,70	10,30	-	544	-	626				
		1600				10	384	1600	962	508	1,27	25,90	11,80	-	597	-	687				
		1800				10	384	1800	1074	567	1,28	29,00	13,30	-	644	11254-03	741				
		2000				10	384	2000	1188	627	1,28	32,10	14,60	-	696	-	800				
		2200				10	384	2200	1303	688	1,28	35,10	15,90	-	745	-	857				
		2400				10	384	2400	1420	750	1,29	38,20	17,20	-	792	-	911				
		2600				10	384	2600	1539	813	1,29	41,30	18,50	-	847	-	974				
		2800				10	384	2800	1659	876	1,29	44,30	19,80	-	894	-	1028				
							3000			10	384	3000	1782	941	1,29	47,40	21,10	-	942	-	1083
		11254				0464	1400	XXXX	YYYY	-0000	12	464	1400	1020	539	1,27	27,24	12,36	-	637	-
1600	12		464	1600	1154		609				1,27	31,08	14,16	-	697	-	802				
1800	12		464	1800	1289		681				1,28	34,80	15,96	-	757	11254-12	871				
2000	12		464	2000	1425		752				1,28	38,52	17,52	-	818	11254-01	941				
2200	12		464	2200	1563		825				1,28	42,12	19,08	-	879	-	1011				
2400	12		464	2400	1704		900				1,29	45,84	20,64	-	933	-	1073				
2600	12		464	2600	1846		975				1,29	49,56	22,20	-	996	-	1145				
2800	12		464	2800	1991		1051				1,29	53,16	23,76	-	1054	-	1212				
			3000				12				464	3000	2139	1130	1,29	56,88	25,32	-	1117	-	1285
11254	0544		1400	XXXX	YYYY		-0000				14	544	1400	1190	628	1,27	31,78	14,42	-	730	-
		1600	14			544		1600	1346	711	1,27	36,26	16,52	-	799	-	919				
		1800	14			544		1800	1504	794	1,28	40,60	18,62	-	865	11254-07	995				
		2000	14			544		2000	1663	878	1,28	44,94	20,44	-	935	11254-08	1075				
		2200	14			544		2200	1824	963	1,28	49,14	22,26	-	1007	-	1158				
		2400	14			544		2400	1988	1050	1,29	53,48	24,08	-	1076	-	1237				
		2600	14			544		2600	2154	1137	1,29	57,82	25,90	-	1147	-	1319				
		2800	14			544		2800	2323	1227	1,29	62,02	27,72	-	1216	-	1398				
						3000				14	544	3000	2495	1318	1,29	66,36	29,54	-	1286	-	1479
		11254	0624			1400		XXXX	YYYY	-0000	16	624	1400	1360	718	1,27	36,32	16,48	-	822	-
1600	16			624	1600	1539	813				1,27	41,44	18,88	-	901	-	1036				
1800	16			624	1800	1719	908				1,28	46,40	21,28	-	980	11254-09	1127				
2000	16			624	2000	1900	1003				1,28	51,36	23,36	-	1059	11254-02	1218				
2200	16			624	2200	2085	1101				1,28	56,16	25,44	-	1139	-	1310				
2400	16			624	2400	2272	1200				1,29	61,12	27,52	-	1219	-	1402				
2600	16			624	2600	2462	1300				1,29	66,08	29,60	-	1298	-	1493				
2800	16			624	2800	2655	1402				1,29	70,88	31,68	-	1376	-	1582				
				3000			16				624	3000	2852	1506	1,29	75,84	33,76	-	1456	-	1674

In conformity with EN442-1: 2014: radiators and convectors

For heat outputs in other regimes, see p. 320 (correction factors)
EXPORT. Prices in Euro (excl. VAT)

HOW TO ORDER ZANA VERTICAL
 Delivery time 15 - 30 working days
 (transport duration not included)

ZANA VERTICAL (ZV-1)

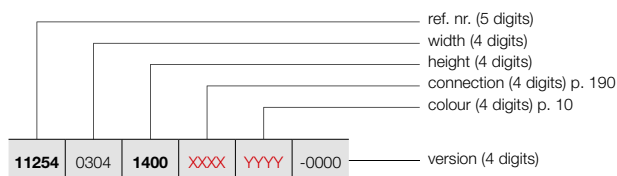

ZV-1

PRICE GROUP: VPG2 - STEEL DESIGN RADIATORS

REFERENCE CODE CUSTOM MADE ZANA VERTICAL	TECHNICAL DATA									STANDARD COLOUR		OTHER COLOURS					
	tubes	width (L mm)	height (H mm)	75/65/20 (Watt) (φ50K)	55/45/20 (Watt) (φ30K)	n-exp.	weight (kg)	water content (l)	electr. resistance (Watt)	price RAL 9016 (€)	short ref. nr. RAL 9016 stock	price colour (€)					
REF. NR. ZANA VERTICAL ZV-1 : 11254																	
11254	0304	1400	XXXX	YYYY	-0000	18	704	1400	1531	808	1,27	40,86	18,54	-	915	-	1052
		1600				18	704	1600	1731	914	1,27	46,62	21,24	-	1000	-	1150
		1800				18	704	1800	1933	1021	1,28	52,20	23,94	-	1089	-	1252
		2000				18	704	2000	2138	1129	1,28	57,78	26,28	-	1180	-	1357
		2200				18	704	2200	2345	1238	1,28	63,18	28,62	-	1269	-	1459
		2400				18	704	2400	2555	1349	1,29	68,76	30,96	-	1361	-	1565
		2600				18	704	2600	2769	1462	1,29	74,34	33,30	-	1447	-	1664
		2800				18	704	2800	2987	1577	1,29	79,74	35,64	-	1537	-	1768
		3000				18	704	3000	3208	1694	1,29	85,32	37,98	-	1626	-	1870
11254	0784	1400	XXXX	YYYY	-0000	20	784	1400	1701	898	1,27	45,40	20,60	-	1002	-	1152
		1600				20	784	1600	1923	1015	1,27	51,80	23,60	-	1104	-	1270
		1800				20	784	1800	2148	1134	1,28	58,00	26,60	-	1202	-	1382
		2000				20	784	2000	2375	1254	1,28	64,20	29,20	-	1300	-	1495
		2200				20	784	2200	2606	1376	1,28	70,20	31,80	-	1400	-	1610
		2400				20	784	2400	2839	1499	1,29	76,40	34,40	-	1500	-	1725
		2600				20	784	2600	3077	1625	1,29	82,60	37,00	-	1599	-	1839
		2800				20	784	2800	3319	1753	1,29	88,60	39,60	-	1697	-	1952
		3000				20	784	3000	3564	1882	1,29	94,80	42,20	-	1796	-	2065
11254	0864	1400	XXXX	YYYY	-0000	22	864	1400	1871	988	1,27	49,94	22,66	-	1094	-	1258
		1600				22	864	1600	2116	1117	1,27	56,98	25,96	-	1204	-	1385
		1800				22	864	1800	2363	1248	1,28	63,80	29,26	-	1313	-	1510
		2000				22	864	2000	2613	1380	1,28	70,62	32,12	-	1422	-	1635
		2200				22	864	2200	2866	1513	1,28	77,22	34,98	-	1531	-	1761
		2400				22	864	2400	3123	1649	1,29	84,04	37,84	-	1644	-	1891
		2600				22	864	2600	3385	1788	1,29	90,86	40,70	-	1752	-	2015
		2800				22	864	2800	3650	1927	1,29	97,46	43,56	-	1861	-	2140
		3000				22	864	3000	3921	2071	1,29	104,28	46,42	-	1968	-	2263
11254	0944	1400	XXXX	YYYY	-0000	24	944	1400	2041	1078	1,27	54,48	24,72	-	1186	-	1364
		1600				24	944	1600	2308	1219	1,27	62,16	28,32	-	1304	-	1500
		1800				24	944	1800	2578	1361	1,28	69,60	31,92	-	1425	-	1639
		2000				24	944	2000	2850	1505	1,28	77,04	35,04	-	1543	-	1774
		2200				24	944	2200	3127	1651	1,28	84,24	38,16	-	1662	-	1911
		2400				24	944	2400	3407	1799	1,29	91,68	41,28	-	1783	-	2050
		2600				24	944	2600	3692	1950	1,29	99,12	44,40	-	1902	-	2187
		2800				24	944	2800	3982	2103	1,29	106,32	47,52	-	2019	-	2322
		3000				24	944	3000	4277	2259	1,29	113,76	50,64	-	2142	-	2463
11254	1024	1400	XXXX	YYYY	-0000	26	1024	1400	2211	1168	1,27	59,02	26,78	-	1279	-	1471
		1600				26	1024	1600	2500	1320	1,27	67,34	30,68	-	1405	-	1616
		1800				26	1024	1800	2793	1475	1,28	75,40	34,58	-	1534	-	1764
		2000				26	1024	2000	3088	1631	1,28	83,46	37,96	-	1665	-	1915
		2200				26	1024	2200	3388	1789	1,28	91,26	41,34	-	1793	-	2062
		2400				26	1024	2400	3691	1949	1,29	99,32	44,72	-	1925	-	2214
		2600				26	1024	2600	4000	2112	1,29	107,38	48,10	-	2052	-	2360
		2800				26	1024	2800	4314	2278	1,29	115,18	51,48	-	2184	-	2512
		3000				26	1024	3000	4634	2447	1,29	123,24	54,86	-	2310	-	2657

In conformity with EN442-1: 2014: radiators and convectors

For heat outputs in other regimes, see p. 320 (correction factors)
 EXPORT. Prices in Euro (excl. VAT)

VASCO

ZANA VERTICAL (ZV-2)



ZV-2

HOW TO ORDER ZANA VERTICAL

Delivery time 15 - 30 working days
(transport duration not included)

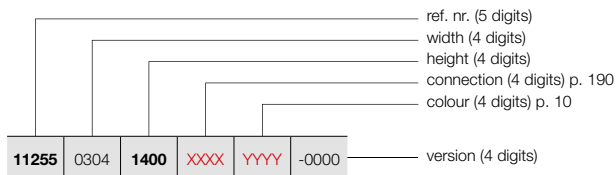

HOW TO ORDER STOCK RADIATOR ZANA VERTICAL

Delivery time 5 working days
(transport duration not included)

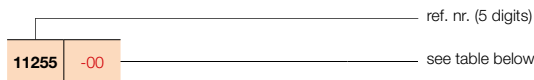

PRICE GROUP: VPG2 - STEEL DESIGN RADIATORS

REFERENCE CODE CUSTOM MADE ZANA VERTICAL						TECHNICAL DATA						STANDARD COLOUR		OTHER COLOURS			
tubes	width (L mm)	height (H mm)	75/65/20 (Watt) (φ50K)	55/45/20 (Watt) (φ30K)	n-exp.	weight (kg)	water content (l)	electr. resistance (Watt)	price RAL 9016 (€)	short ref. nr. RAL 9016 stock	price colour (€)						
REF. NR. ZANA VERTICAL ZV-2 : 11255																	
11255	0304	1400	XXXX	YYYY	-0000	8	304	1400	1105	584	1,30	35,20	16,16	-	774	-	890
		1600				8	304	1600	1242	656	1,30	40,16	18,40	-	839	-	965
		1800				8	304	1800	1379	728	1,30	45,12	20,64	-	908	-	1044
		2000				8	304	2000	1515	800	1,30	50,00	23,28	-	978	-	1125
		2200				8	304	2200	1651	872	1,30	54,80	25,92	-	1043	-	1199
		2400				8	304	2400	1788	944	1,30	59,68	28,56	-	1110	-	1277
		2600				8	304	2600	1925	1017	1,30	64,48	31,12	-	1180	-	1357
		2800				8	304	2800	2062	1089	1,30	69,36	33,76	-	1244	-	1431
		3000				8	304	3000	2200	1162	1,30	74,16	36,40	-	1313	-	1510
11255	0384	1400	XXXX	YYYY	-0000	10	384	1400	1381	729	1,30	44,00	20,20	-	929	-	1068
		1600				10	384	1600	1553	820	1,30	50,20	23,00	-	1014	-	1166
		1800				10	384	1800	1724	910	1,30	56,40	25,80	-	1096	-	1260
		2000				10	384	2000	1894	1000	1,30	62,50	29,10	-	1183	-	1360
		2200				10	384	2200	2064	1090	1,30	68,50	32,40	-	1267	-	1457
		2400				10	384	2400	2235	1180	1,30	74,60	35,70	-	1350	-	1553
		2600				10	384	2600	2406	1271	1,30	80,60	38,90	-	1437	-	1653
		2800				10	384	2800	2577	1361	1,30	86,70	42,20	-	1520	-	1748
		3000				10	384	3000	2750	1452	1,30	92,70	45,50	-	1602	-	1842
11255	0464	1400	XXXX	YYYY	-0000	12	464	1400	1657	875	1,30	52,80	24,24	-	1083	-	1245
		1600				12	464	1600	1863	984	1,30	60,24	27,60	-	1185	-	1363
		1800				12	464	1800	2068	1092	1,30	67,68	30,96	-	1288	-	1481
		2000				12	464	2000	2273	1200	1,30	75,00	34,92	-	1388	-	1596
		2200				12	464	2200	2477	1308	1,30	82,20	38,88	-	1490	-	1714
		2400				12	464	2400	2682	1416	1,30	89,52	42,84	-	1591	-	1830
		2600				12	464	2600	2887	1525	1,30	96,72	46,68	-	1691	-	1945
		2800				12	464	2800	3093	1633	1,30	104,04	50,64	-	1793	-	2062
		3000				12	464	3000	3300	1743	1,30	111,24	54,60	-	1895	-	2179
11255	0544	1400	XXXX	YYYY	-0000	14	544	1400	1933	1021	1,30	61,60	28,28	-	1240	-	1426
		1600				14	544	1600	2174	1148	1,30	70,28	32,20	-	1361	-	1565
		1800				14	544	1800	2413	1274	1,30	78,96	36,12	-	1474	-	1695
		2000				14	544	2000	2651	1400	1,30	87,50	40,74	-	1594	11255-02	1833
		2200				14	544	2200	2890	1526	1,30	95,90	45,36	-	1714	-	1971
		2400				14	544	2400	3129	1652	1,30	104,44	49,98	-	1831	-	2106
		2600				14	544	2600	3368	1779	1,30	112,84	54,46	-	1948	-	2240
		2800				14	544	2800	3608	1905	1,30	121,38	59,08	-	2068	-	2378
		3000				14	544	3000	3849	2033	1,30	129,78	63,70	-	2186	-	2514
11255	0624	1400	XXXX	YYYY	-0000	16	624	1400	2209	1167	1,30	70,40	32,32	-	1395	-	1604
		1600				16	624	1600	2484	1312	1,30	80,32	36,80	-	1529	-	1758
		1800				16	624	1800	2758	1456	1,30	90,24	41,28	-	1662	-	1911
		2000				16	624	2000	3030	1600	1,30	100,00	46,56	-	1801	-	2071
		2200				16	624	2200	3303	1744	1,30	109,60	51,84	-	1936	-	2226
		2400				16	624	2400	3576	1888	1,30	119,36	57,12	-	2071	-	2382
		2600				16	624	2600	3849	2033	1,30	128,96	62,24	-	2208	-	2539
		2800				16	624	2800	4124	2178	1,30	138,72	67,52	-	2339	-	2690
		3000				16	624	3000	4399	2323	1,30	148,32	72,80	-	2476	-	2847

In conformity with EN442-1: 2014: radiators and convectors

For heat outputs in other regimes, see p. 320 (correction factors)
EXPORT. Prices in Euro (excl. VAT)

HOW TO ORDER ZANA VERTICAL
 Delivery time 15 - 30 working days
 (transport duration not included)

ZANA VERTICAL (ZV-2)

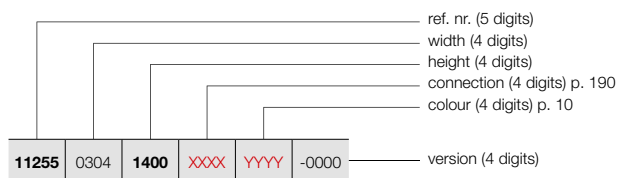

ZV-2

HOW TO ORDER STOCK RADIATOR ZANA VERTICAL

Delivery time 5 working days
 (transport duration not included)

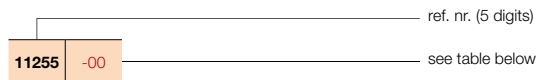

PRICE GROUP: VPG2 - STEEL DESIGN RADIATORS

REFERENCE CODE CUSTOM MADE ZANA VERTICAL	TECHNICAL DATA									STANDARD COLOUR		OTHER COLOURS					
	tubes	width (L mm)	height (H mm)	75/65/20 (Watt) (φ50K)	55/45/20 (Watt) (φ30K)	n-exp.	weight (kg)	water content (l)	electr. resistance (Watt)	price RAL 9016 (€)	short ref. nr. RAL 9016 stock	price colour (€)					
REF. NR. ZANA VERTICAL ZV-2 : 11255																	
11255	0704	1400	XXXX	YYYY	-0000	18	704	1400	2486	1313	1,30	79,20	36,36	-	1550	-	1783
		1600				18	704	1600	2795	1476	1,30	90,36	41,40	-	1700	-	1955
		1800				18	704	1800	3102	1638	1,30	101,52	46,44	-	1854	-	2132
		2000				18	704	2000	3409	1800	1,30	112,50	52,38	-	2007	11255-01	2308
		2200				18	704	2200	3716	1962	1,30	123,30	58,32	-	2158	-	2482
		2400				18	704	2400	4023	2124	1,30	134,28	64,26	-	2309	-	2655
		2600				18	704	2600	4330	2287	1,30	145,08	70,02	-	2462	-	2831
		2800				18	704	2800	4639	2450	1,30	156,06	75,96	-	2614	-	3006
11255	0784	1400	XXXX	YYYY	-0000	20	784	1400	2762	1459	1,30	88,00	40,40	-	1707	-	1963
		1600				20	784	1600	3105	1640	1,30	100,40	46,00	-	1875	-	2156
		1800				20	784	1800	3447	1820	1,30	112,80	51,60	-	2042	-	2348
		2000				20	784	2000	3788	2000	1,30	125,00	58,20	-	2212	-	2544
		2200				20	784	2200	4129	2180	1,30	137,00	64,80	-	2380	-	2737
		2400				20	784	2400	4470	2360	1,30	149,20	71,40	-	2551	-	2934
		2600				20	784	2600	4812	2541	1,30	161,20	77,80	-	2718	-	3126
		11255				0864	1400	XXXX	YYYY	-0000	22	864	1400	3038	1604	1,30	96,80
1600	22		864	1600	3416		1804				1,30	110,44	50,60	-	2046	-	2353
1800	22		864	1800	3792		2002				1,30	124,08	56,76	-	2231	-	2566
2000	22		864	2000	4167		2200				1,30	137,50	64,02	-	2419	-	2782
2200	22		864	2200	4541		2398				1,30	150,70	71,28	-	2605	-	2996
11255	0944	1400	XXXX	YYYY	-0000	24	944	1400	3314	1750	1,30	105,60	48,48	-	2015	-	2317
		1600				24	944	1600	3726	1968	1,30	120,48	55,20	-	2220	-	2553
		1800				24	944	1800	4136	2184	1,30	135,36	61,92	-	2422	-	2785
		2000				24	944	2000	4545	2400	1,30	150,00	69,84	-	2624	-	3018
11255	1024	1400	XXXX	YYYY	-0000	26	1024	1400	3590	1896	1,30	114,40	52,52	-	2174	-	2500
		1600				26	1024	1600	4037	2132	1,30	130,52	59,80	-	2392	-	2751
		1800				26	1024	1800	4481	2366	1,30	146,64	67,08	-	2610	-	3002

In conformity with EN442-1: 2014: radiators and convectors

For heat outputs in other regimes, see p. 320 (correction factors)
 EXPORT. Prices in Euro (excl. VAT)

VASCO

ZANA HORIZONTAL (ZH-1, ZH-2)



TYPES

- One (ZH-1) or two rows (ZH-2)

TUBES

- Vertical, rectangular 45 x 20 mm
- Attention: horizontal design, but always with vertical tubes !

COLLECTORS

- Horizontal, rear, round Ø 35 mm

COLOURS

- Standard colour white RAL 9016
- Extensive colour chart see p. 10

SPECIAL

- ZH-1 also available as toilet radiator (384 x 500 mm)

BRACKETS

- Wall brackets standard

TECHNICAL

- Electrically laser welded (invisible weld seams)
- KTL priming coat, powder coating
- Standard operating pressure: 4 bar
- Maximum operating temperature: 110°C

ELECTRICAL

- ✗ Pure electrical radiator prefilled
- ✗ Mixed radiator

TECHNICAL DRAWINGS

- See p. 191

CONNECTION

- ✓ One-point connection for one-pipe system (order as special radiator) **(on demand)** (see p. 313)
- ✓ One-point connection for two-pipe system (order as special radiator) **(on demand)** (see p. 313)
- ✗ Two-point connection for one-pipe system
- ✓ Two-point connection for two-pipe system (standard) (see p. 312)
- ✗ Integrated valve
- Connections: 1/2" (inner thread)

ZANA HORIZONTAL

Beautiful until the end of time

Also the horizontal version of the Zana designer radiator is a splendid example of class, power and comfort. Together, the vertical pipes and horizontal collectors form a nicely structured geometric whole and contribute to the specific Zana retro look. The Zana Horizontal is available with one or two rows of pipes and there is also a separate toilet version.

RECOMMENDED CONNECTION (0018)

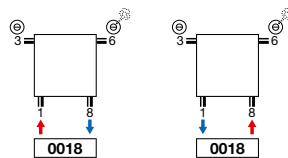

Other connection methods, see p. 190



ref. nr. 1182 101 0000 0099

price € 218

Fittings, see p. 327

RECOMMENDED FOR BATHROOM AND KITCHEN IN OPTION



towel rail straight (chrome)

ref. nr. see p. 189

price € 187

Other accessories, see p. 189



HOW TO ORDER ZANA HORIZONTAL

Delivery time 15 - 30 working days
(transport duration not included)

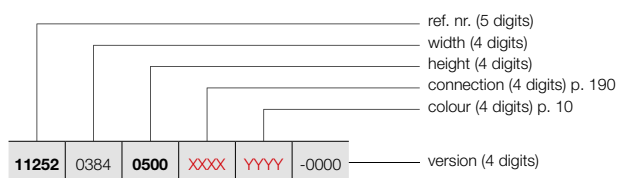

11252	0384	0500	XXXX	YYYY	-0000
-------	------	------	------	------	-------

ZANA HORIZONTAL (ZH-1)



ZH-1

PRICE GROUP: VPG2 - STEEL DESIGN RADIATORS

REFERENCE CODE CUSTOM MADE ZANA HORIZONTAL	TECHNICAL DATA										STANDARD COLOUR	OTHER COLOURS				
	tubes	width (L mm)	height (H mm)	75/65/20 (Watt) (φ50K)	55/45/20 (Watt) (φ30K)	n-exp.	weight (kg)	water content (l)	electr. resistance (Watt)	price RAL 9016 (€)	price colour (€)					
REF. NR. ZANA HORIZONTAL ZH-1 : 11252																
11252	0384	0500	XXXX	YYYY	-0000	10	384	500	347	183	1,25	9,00	4,10	-	322	370
11252	0704	0500	XXXX	YYYY	-0000	18	704	500	624	330	1,25	16,20	7,38	-	510	587
		18				600		728	384	1,25	18,90	8,46	-	554	637	
		18				700		831	439	1,25	21,60	9,72	-	598	688	
11252	0784	0500	XXXX	YYYY	-0000	20	784	500	694	366	1,25	18,00	8,20	-	556	639
		20				600		809	427	1,25	21,00	9,40	-	606	697	
		20				700		923	487	1,25	24,00	10,80	-	657	756	
11252	0864	0500	XXXX	YYYY	-0000	22	864	500	763	403	1,25	19,80	9,02	-	603	693
		22				600		890	470	1,25	23,10	10,34	-	658	757	
		22				700		1015	536	1,25	26,40	11,88	-	710	817	
11252	0944	0500	XXXX	YYYY	-0000	24	944	500	832	439	1,25	21,60	9,84	-	647	744
		24				600		971	513	1,25	25,20	11,28	-	706	812	
		24				700		1107	585	1,25	28,80	12,96	-	768	883	
11252	1024	0500	XXXX	YYYY	-0000	26	1024	500	902	476	1,25	23,40	10,66	-	696	800
		26				600		1052	556	1,25	27,30	12,22	-	760	874	
		26				700		1200	634	1,25	31,20	14,04	-	826	950	
11252	1104	0500	XXXX	YYYY	-0000	28	1104	500	971	513	1,25	25,20	11,48	-	742	853
		28				600		1133	598	1,25	29,40	13,16	-	813	935	
		28				700		1292	682	1,25	33,60	15,12	-	883	1015	
11252	1184	0500	XXXX	YYYY	-0000	30	1184	500	1040	549	1,25	27,00	12,30	-	787	905
		30				600		1214	641	1,25	31,50	14,10	-	861	990	
		30				700		1384	731	1,25	36,00	16,20	-	936	1076	
11252	1264	0500	XXXX	YYYY	-0000	32	1264	500	1110	586	1,25	28,80	13,12	-	834	959
		32				600		1295	684	1,25	33,60	15,04	-	917	1055	
		32				700		1476	779	1,25	38,40	17,28	-	995	1144	
11252	1424	0500	XXXX	YYYY	-0000	36	1424	500	1248	659	1,25	32,40	14,76	-	929	1068
		36				600		1457	769	1,25	37,80	16,92	-	1017	1170	
		36				700		1661	877	1,25	43,20	19,44	-	1107	1273	
11252	1584	0500	XXXX	YYYY	-0000	40	1584	500	1387	732	1,25	36,00	16,40	-	1022	1175
		40				600		1618	854	1,25	42,00	18,80	-	1121	1289	
		40				700		1846	975	1,25	48,00	21,60	-	1221	1404	
11252	1744	0500	XXXX	YYYY	-0000	44	1744	500	1526	806	1,25	39,60	18,04	-	1117	1285
		44				600		1780	940	1,25	46,20	20,68	-	1225	1409	
		44				700		2030	1072	1,25	52,80	23,76	-	1333	1533	
11252	1904	0500	XXXX	YYYY	-0000	48	1904	500	1665	879	1,25	43,20	19,68	-	1207	1388
		48				600		1942	1026	1,25	50,40	22,56	-	1327	1526	
		48				700		2215	1170	1,25	57,60	25,92	-	1446	1663	

In conformity with EN442-1: 2014: radiators and convectors

For heat outputs in other regimes, see p. 320 (correction factors)
EXPORT. Prices in Euro (excl. VAT)

VASCO

ZANA HORIZONTAL (ZH-1)



ZH-1

HOW TO ORDER ZANA HORIZONTAL

Delivery time 15 - 30 working days
(transport duration not included)

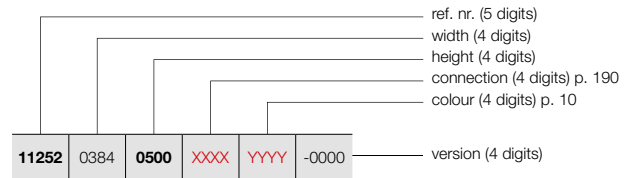

PRICE GROUP: VPG2 - STEEL DESIGN RADIATORS

REFERENCE CODE CUSTOM MADE ZANA HORIZONTAL							TECHNICAL DATA					STANDARD COLOUR	OTHER COLOURS			
							tubes	width (L mm)	height (H mm)	75/65/20 (Watt) (φ50K)	55/45/20 (Watt) (φ30K)	n-exp.	weight (kg)	water content (l)	electr. resistance (Watt)	price RAL 9016 (€)
REF. NR. ZANA HORIZONTAL ZH-1 : 11252																
11252	2064	0500	XXXX	YYYY	-0000	52	2064	500	1803	952	1,25	46,80	21,32	-	1300	1495
		0600				52	2064	600	2104	1111	1,25	54,60	24,44	-	1430	1645
		0700				52	2064	700	2399	1267	1,25	62,40	28,08	-	1561	1795
11252	2224	0500	XXXX	YYYY	-0000	56	2224	500	1942	1026	1,25	50,40	22,96	-	1395	1604
		0600				56	2224	600	2266	1197	1,25	58,80	26,32	-	1533	1763
		0700				56	2224	700	2584	1365	1,25	67,20	30,24	-	1674	1925
11252	2384	0500	XXXX	YYYY	-0000	60	2384	500	2081	1099	1,25	54,00	24,60	-	1489	1712
		0600				60	2384	600	2428	1282	1,25	63,00	28,20	-	1636	1881
		0700				60	2384	700	2768	1462	1,25	72,00	32,40	-	1787	2055
11252	2544	0500	XXXX	YYYY	-0000	64	2544	500	2220	1172	1,25	57,60	26,24	-	1581	1818
		0600				64	2544	600	2589	1367	1,25	67,20	30,08	-	1741	2002
		0700				64	2544	700	2953	1559	1,25	76,80	34,56	-	1900	2185
11252	2704	0500	XXXX	YYYY	-0000	68	2704	500	2358	1245	1,25	61,20	27,88	-	1675	1926
		0600				68	2704	600	2751	1453	1,25	71,40	31,96	-	1844	2121
		0700				68	2704	700	3138	1657	1,25	81,60	36,72	-	2012	2314
11252	2864	0500	XXXX	YYYY	-0000	72	2864	500	2497	1319	1,25	64,80	29,52	-	1765	2030
		0600				72	2864	600	2913	1538	1,25	75,60	33,84	-	1945	2237
		0700				72	2864	700	3322	1754	1,25	86,40	38,88	-	2125	2444

In conformity with EN442-1: 2014: radiators and convectors

For heat outputs in other regimes, see p. 320 (correction factors)
EXPORT. Prices in Euro (excl. VAT)

HOW TO ORDER ZANA HORIZONTAL

Delivery time 15 - 30 working days
(transport duration not included)

ZANA HORIZONTAL (ZH-2)

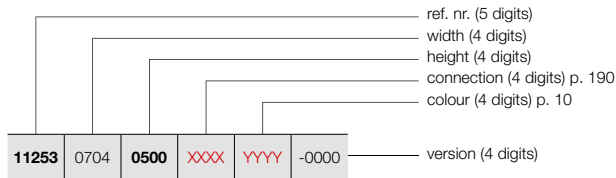

ZH-2

PRICE GROUP: VPG2 - STEEL DESIGN RADIATORS

REFERENCE CODE CUSTOM MADE ZANA HORIZONTAL							TECHNICAL DATA				STANDARD COLOUR		OTHER COLOURS			
							tubes	width (L mm)	height (H mm)	75/65/20 (Watt) (φ50K)	55/45/20 (Watt) (φ30K)	n-exp.	weight (kg)	water content (l)	electr. resistance (Watt)	price RAL 9016 (€)
REF. NR. ZANA HORIZONTAL ZH-2 : 11253																
11253	0704	0500	XXXX	YYYY	-0000	18	704	500	1035	547	1,28	30,42	13,50	-	863	992
		0600				18	704	600	1205	636	1,28	35,64	16,02	-	942	1083
		0700				18	704	700	1372	725	1,28	41,04	18,54	-	1015	1167
11253	0784	0500	XXXX	YYYY	-0000	20	784	500	1150	607	1,28	33,80	15,00	-	944	1086
		0600				20	784	600	1339	707	1,28	39,60	17,80	-	1030	1185
		0700				20	784	700	1525	805	1,28	45,60	20,60	-	1115	1282
11253	0864	0500	XXXX	YYYY	-0000	22	864	500	1265	668	1,28	37,18	16,50	-	1023	1176
		0600				22	864	600	1473	778	1,28	43,56	19,58	-	1118	1286
		0700				22	864	700	1677	886	1,28	50,16	22,66	-	1207	1388
11253	0944	0500	XXXX	YYYY	-0000	24	944	500	1380	729	1,28	40,56	18,00	-	1104	1270
		0600				24	944	600	1607	849	1,28	47,52	21,36	-	1204	1385
		0700				24	944	700	1830	966	1,28	54,72	24,72	-	1304	1500
11253	1024	0500	XXXX	YYYY	-0000	26	1024	500	1494	789	1,28	43,94	19,50	-	1183	1360
		0600				26	1024	600	1741	919	1,28	51,48	23,14	-	1295	1489
		0700				26	1024	700	1982	1047	1,28	59,28	26,78	-	1402	1612
11253	1104	0500	XXXX	YYYY	-0000	28	1104	500	1609	850	1,28	47,32	21,00	-	1263	1452
		0600				28	1104	600	1875	990	1,28	55,44	24,92	-	1380	1587
		0700				28	1104	700	2135	1127	1,28	63,84	28,84	-	1497	1722
11253	1184	0500	XXXX	YYYY	-0000	30	1184	500	1724	910	1,28	50,70	22,50	-	1339	1540
		0600				30	1184	600	2009	1061	1,28	59,40	26,70	-	1467	1687
		0700				30	1184	700	2287	1208	1,28	68,40	30,90	-	1595	1834
11253	1264	0500	XXXX	YYYY	-0000	32	1264	500	1839	971	1,28	54,08	24,00	-	1419	1632
		0600				32	1264	600	2143	1132	1,28	63,36	28,48	-	1558	1792
		0700				32	1264	700	2440	1288	1,28	72,96	32,96	-	1689	1942
11253	1424	0500	XXXX	YYYY	-0000	36	1424	500	2069	1093	1,28	60,84	27,00	-	1580	1817
		0600				36	1424	600	2411	1273	1,28	71,28	32,04	-	1729	1988
		0700				36	1424	700	2745	1450	1,28	82,08	37,08	-	1884	2167
11253	1584	0500	XXXX	YYYY	-0000	40	1584	500	2299	1214	1,28	67,60	30,00	-	1738	1999
		0600				40	1584	600	2678	1414	1,28	79,20	35,60	-	1907	2193
		0700				40	1584	700	3050	1611	1,28	91,20	41,20	-	2076	2387
11253	1744	0500	XXXX	YYYY	-0000	44	1744	500	2529	1335	1,28	74,36	33,00	-	1895	2179
		0600				44	1744	600	2946	1556	1,28	87,12	39,16	-	2082	2394
		0700				44	1744	700	3355	1772	1,28	100,32	45,32	-	2266	2606
11253	1904	0500	XXXX	YYYY	-0000	48	1904	500	2759	1457	1,28	81,12	36,00	-	2053	2361
		0600				48	1904	600	3214	1697	1,28	95,04	42,72	-	2257	2596
		0700				48	1904	700	3660	1933	1,28	109,44	49,44	-	2459	2828

In conformity with EN442-1: 2014: radiators and convectors

For heat outputs in other regimes, see p. 320 (correction factors)
EXPORT. Prices in Euro (excl. VAT)

VASCO

ZANA HORIZONTAL (ZH-2)



ZH-2

HOW TO ORDER ZANA HORIZONTAL

Delivery time 15 - 30 working days
(transport duration not included)

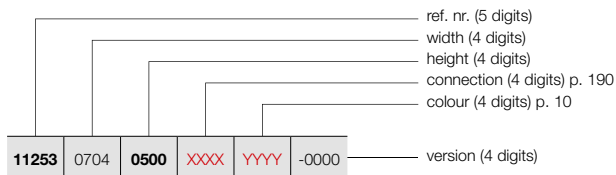





PRICE GROUP: VPG2 - STEEL DESIGN RADIATORS

REFERENCE CODE CUSTOM MADE ZANA HORIZONTAL							TECHNICAL DATA						STANDARD COLOUR	OTHER COLOURS		
tubes	width (L mm)	height (H mm)	75/65/20 (Watt (φ50K)	55/45/20 (Watt (φ30K)	n-exp.	weight (kg)	water content (l)	electr. resistance (Watt)	price RAL 9016 (€)	price colour (€)						
REF. NR. ZANA HORIZONTAL ZH-2 : 11253																
11253	2064	0500	XXXX	YYYY	-0000	52	2064	500	2989	1578	1,28	87,88	39,00	-	2212	2544
		0600				52	2064	600	3482	1839	1,28	102,96	46,28	-	2431	2796
		0700				52	2064	700	3964	2093	1,28	118,56	53,56	-	2650	3048
11253	2224	0500	XXXX	YYYY	-0000	56	2224	500	3219	1700	1,28	94,64	42,00	-	2374	2730
		0600				56	2224	600	3750	1980	1,28	110,88	49,84	-	2607	2998
		0700				56	2224	700	4269	2254	1,28	127,68	57,68	-	2843	3269
11253	2384	0500	XXXX	YYYY	-0000	60	2384	500	3449	1821	1,28	101,40	45,00	-	2530	2910
		0600				60	2384	600	4018	2122	1,28	118,80	53,40	-	2784	3202
		0700				60	2384	700	4574	2415	1,28	136,80	61,80	-	3036	3491
11253	2544	0500	XXXX	YYYY	-0000	64	2544	500	3679	1943	1,28	108,16	48,00	-	2687	3090
		0600				64	2544	600	4285	2263	1,28	126,72	56,96	-	2960	3404
		0700				64	2544	700	4879	2576	1,28	145,92	65,92	-	3227	3711
11253	2704	0500	XXXX	YYYY	-0000	68	2704	500	3909	2064	1,28	114,92	51,00	-	2848	3275
		0600				68	2704	600	4553	2404	1,28	134,64	60,52	-	3133	3603
		0700				68	2704	700	5184	2737	1,28	155,04	70,04	-	3420	3933
11253	2864	0500	XXXX	YYYY	-0000	72	2864	500	4139	2186	1,28	121,68	54,00	-	3006	3457
		0600				72	2864	600	4821	2546	1,28	142,56	64,08	-	3311	3808

In conformity with EN442-1: 2014: radiators and convectors

For heat outputs in other regimes, see p. 320 (correction factors)
EXPORT. Prices in Euro (excl. VAT)

PRICE GROUP: VPG10B - TOWEL RAILS

ACCESSORIES	WIDTH RADIATOR	COLOUR*	REF. NR.	€
ZV-1 / ZV-2 / ZH-1 / ZH-2				
TOWEL RAIL STRAIGHT 		CHROME	1183 228 0000 0099	187
<ul style="list-style-type: none"> h = 22 mm; b = 720 mm (easy adjustable); d = 75 mm; a = 56 mm 				
ZV-1 / ZV-2 / ZH-1 / ZH-2				
HOOK 		CHROME	1183 410 0000 0099	87
<ul style="list-style-type: none"> h = 70 mm; b = 70 mm; d = 59 mm; a = 51 mm; 				
ZV-1				
TOWEL RAIL MULTI+ RIGHT 	600 mm	S600	1183 734 0000 0600	204
	600 mm	RAL 9005 ^S	1183 734 0000 9005	204
<ul style="list-style-type: none"> h = 70 mm; b = 600 mm (b tablet = 194 mm); e = 176 mm; c = 170 mm; Mounting on the wall, to the right of the radiator. 				
ZV-1				
TOWEL RAIL MULTI+ LEFT 	600 mm	S600	1183 735 0000 0600	204
	600 mm	RAL 9005 ^S	1183 735 0000 9005	204
<ul style="list-style-type: none"> h = 70 mm; b = 600 mm (b tablet = 194 mm); e = 176 mm; c = 170 mm; Mounting on the wall, to the left of the radiator. 				

^S structure black

* Multi+ is available in the colour of the radiator, if ordered together. Extra charge +15%.

Mounting instructions accessories: see www.vasco.eu
EXPORT. Prices in Euro (excl. VAT)

e = distance front of the accessory up to the wall
d = distance front of the accessory up to front of the radiator
c = distance between wall to back towel bar
a = distance accessory up to the radiator
available from stock

ZANA VERTICAL: ZV-1 / ZV-2 (STOCK)

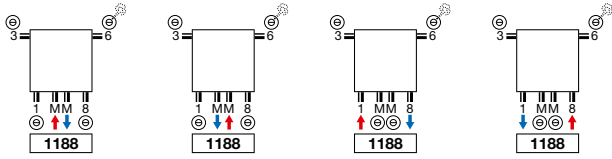

ZANA HORIZONTAL: ZH-1 / ZH-2

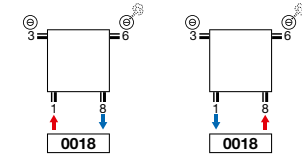

ZANA VERTICAL: ZV-1 / ZV-2 (NON STOCK)

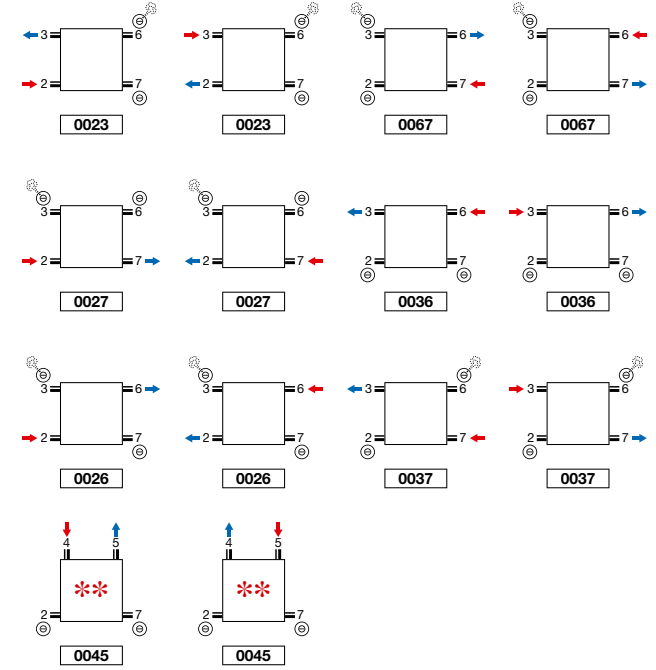
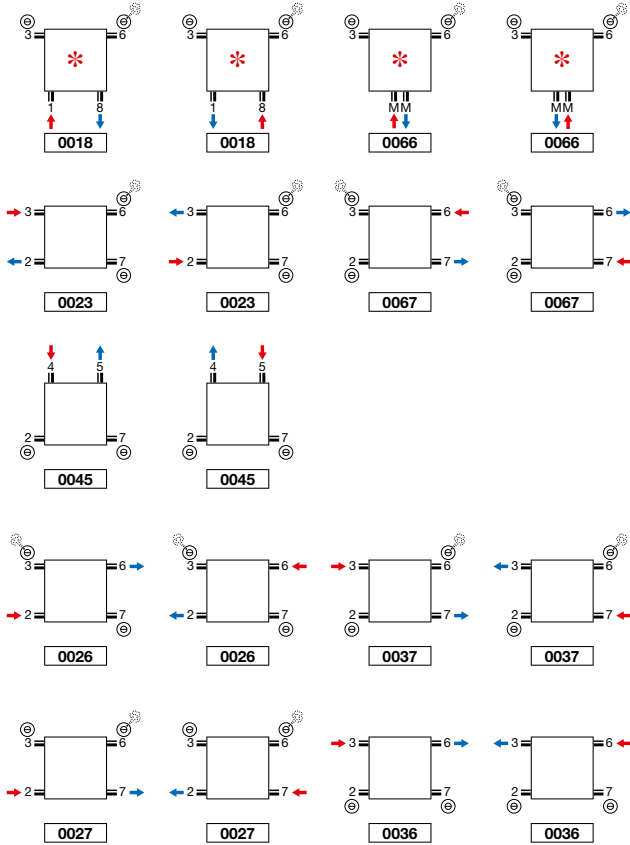

** Not for toilet radiator ZH-1.

* Attention ZV-1/ZV-2 8 tubes: 2/3/6/7 always open.

Attention: connecting the radiator can only be as shown by the connecting icons. For any other connection method, we take no responsibility.

ZANA VERTICAL (ZV-1, ZV-2)

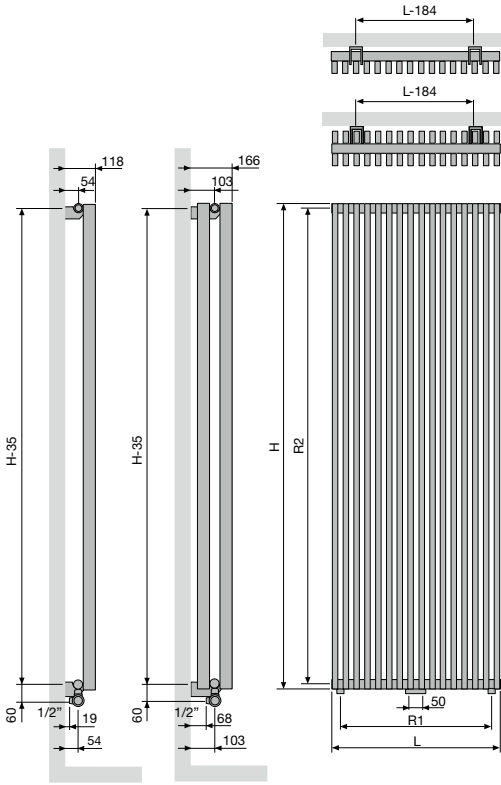

ZV-1 / ZV-2

Number of tubes	8	10	12	14	16	18	20	22	24	26
Width (L)	304	384	464	544	624	704	784	864	944	1024
Centre between the connections at the bottom 18 (R1)	240	320	400	480	560	640	720	800	880	960
Height (H)	1400	1600	1800	2000	2200	2400	2600	2800	3000	
Centre between the lateral connections 23/67 (R2)	1365	1565	1765	1965	2165	2365	2565	2765	2965	
Centre between the brackets	L-184	H-35								

ZANA HORIZONTAL (ZH-1, ZH-2)

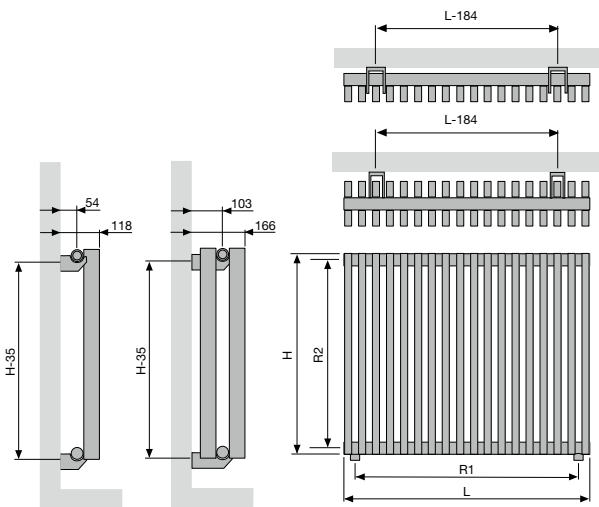

ZH-1 / ZH-2

Width (L)	384	704	784	864	944	1024	1104	1184	1264	1424	1584	1744	1904	2064	2224	2384	2544	2704	2864
Centre between the connections at the bottom 18 (R1)	320	640	720	800	880	960	1040	1120	1200	1360	1520	1680	1840	2000	2160	2320	2480	2640	2800
Height (H)	500	600	700																
Centre between the lateral connections 23/67 (R2)	465	565	665																
Centre between the brackets	L-184	H-35																	

VIOLA-A VERTICAL (V1-ZB-A, V1L1-ZB-A, V2-ZB-A)



TYPES

- V1-ZB-A single row of tubes, V2-ZB-A double row of tubes, V1L1-ZB-A with steel fins

TUBES

- Vertical, rectangular 77 x 10 mm

COLLECTORS

- V1-ZB-A: 35 x 43 mm
- V1L1-ZB-A: 35 x 43 mm
- V2-ZB-A: 35 x 41 mm

COLOURS

- Standard colour white RAL 9016
- Extensive colour chart see p. 10

SPECIAL

- Standard delivered with 2 lateral coverings.
- Connection mm only possible with even number of tubes.
- As to type V1L1-ZB-A, steel fins are welded at the back of the flat-oval tubes in order to increase the heat emission.

BRACKETS

- Wall brackets standard (included in packaging of radiator)
- Upper bracket in colour of radiator, bottom:
 - Distance keeper radiator white = distance keeper white.
 - Distance keeper radiator in colour = distance keeper RAL 7024.
- **V2-ZB-A:** Radiator with telescopic support feet + adjustable wall bracket: please indicate code **-0007** for "Finish" when ordering (see p. 221).

TECHNICAL

- Welded by means of resistance welding robots (invisible weld seams)
- ATL priming coat, powder coating
- Standard operating pressure: 4 bar. Extra charge for higher service pressures (10 bar): +10%.
- The delivery time of a radiator with a higher service pressure is 1 week extra.
- Maximum operating temperature: 110°C

ELECTRICAL

- ✗ Pure electrical radiator prefilled
- ✗ Mixed radiator

TECHNICAL DRAWINGS

- See p. 224

CONNECTION

- ✗ One-point connection for one-pipe system
- ✗ One-point connection for two-pipe system
- ✓ Two-point connection for one-pipe system (connection by way of the central connection) (see p. 312)
- ✓ Two-point connection for two-pipe system (standard) (see p. 312)
- ✗ Integrated valve
- Connections: ½" (inner thread)

VIOLA-A VERTICAL

The sobriety expresses class

A tubular radiator that blends seamlessly with any style of living, by its sober class and its natural design. The sleek front and the embedded side panels guarantee a uniform look and an optimum heat output. Viola-A. That is how simple, powerful and attractive heating can be.

RECOMMENDED CONNECTION (1008)

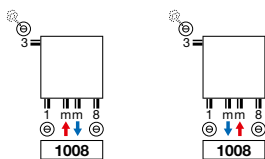

Connection mm only possible with even number of tubes

Other connection methods, see p. 223



ref. nr. 1182001 00009016
price €129
Fittings, see p. 327



ref. nr. 11911630102
price €44

RECOMMENDED FOR BATHROOM AND KITCHEN IN OPTION



towel rail (RAL 9005)
ref. nr. see p. 222

price €145
Other accessories, see p. 222



HOW TO ORDER VIOLA-A VERTICAL

Delivery time 15 - 30 working days
(transport duration not included)

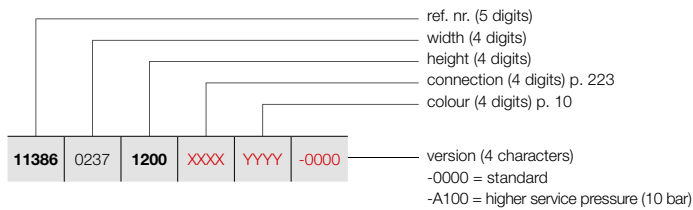

VIOLA-A VERTICAL (V1-ZB-A)



V1-ZB-A

HOW TO ORDER STOCK RADIATOR VIOLA-A VERTICAL

Delivery time 5 working days
(transport duration not included)

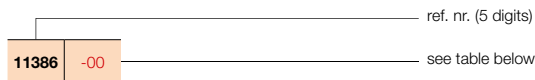

PRICE GROUP: VPG2 - STEEL DESIGN RADIATORS

REFERENCE CODE CUSTOM MADE VIOLA-A VERTICAL	TECHNICAL DATA									STANDARD COLOUR		OTHER COLOURS
	tubes	width (L mm)	height (H mm)	75/65/20 (Watt) (φ50K)	55/45/20 (Watt) (φ30K)	n-exp.	weight (kg)	water content (l)	electr. resistance (Watt)	price RAL 9016 (€)	short ref. nr. RAL 9016 stock	price colour (€)
REF. NR. VIOLA-A VERTICAL V1-ZB-A : 11386												
11386 0237 1200 XXXX YYYY -0000	3	237	1200	371	189	1,32	7,80	2,40	-	325	-	374
	3	237	1400	427	218	1,32	9,00	2,73	-	360	-	414
	3	237	1600	483	246	1,32	9,90	3,03	-	386	-	444
	3	237	1800	535	273	1,32	11,10	3,33	-	415	-	477
	3	237	2000	589	301	1,30	12,30	3,60	-	444	-	511
	3	237	2200	640	327	1,28	13,50	3,90	-	472	-	543
	3	237	2400	689	352	1,27	14,40	4,20	-	500	-	575
11386 0317 1200 XXXX YYYY -0000	4	317	1200	480	245	1,31	10,40	3,20	-	386	-	444
	4	317	1400	551	281	1,31	12,00	3,64	-	422	-	485
	4	317	1600	624	318	1,31	13,20	4,04	-	460	-	529
	4	317	1800	695	355	1,32	14,80	4,44	-	495	-	569
	4	317	2000	764	390	1,30	16,40	4,80	-	531	-	611
	4	317	2200	831	424	1,29	18,00	5,20	-	567	-	652
	4	317	2400	894	456	1,27	19,20	5,60	-	604	-	695
11386 0397 1200 XXXX YYYY -0000	5	397	1200	585	298	1,31	13,00	4,00	-	443	-	509
	5	397	1400	673	343	1,31	15,00	4,55	-	487	-	560
	5	397	1600	762	389	1,31	16,50	5,05	-	531	-	611
	5	397	1800	850	434	1,31	18,50	5,55	-	573	-	659
	5	397	2000	936	478	1,30	20,50	6,00	-	619	-	712
	5	397	2200	1017	519	1,29	22,50	6,50	-	664	-	764
	5	397	2400	1094	558	1,28	24,00	7,00	-	705	-	811
11386 0477 1200 XXXX YYYY -0000	6	477	1200	689	352	1,31	15,60	4,80	-	500	-	575
	6	477	1400	792	404	1,31	18,00	5,46	-	553	-	636
	6	477	1600	897	458	1,31	19,80	6,06	-	604	-	695
	6	477	1800	1003	512	1,31	22,20	6,66	-	657	-	756
	6	477	2000	1104	563	1,30	24,60	7,20	-	705	11386-01	811
	6	477	2200	1200	612	1,29	27,00	7,80	-	757	-	871
	6	477	2400	1291	659	1,28	28,80	8,40	-	808	-	929
11386 0557 1200 XXXX YYYY -0000	7	557	1200	790	403	1,30	18,20	5,60	-	561	-	645
	7	557	1400	909	464	1,31	21,00	6,37	-	619	-	712
	7	557	1600	1029	525	1,31	23,10	7,07	-	676	-	777
	7	557	1800	1154	589	1,31	25,90	7,77	-	738	-	849
	7	557	2000	1269	647	1,30	28,70	8,40	-	791	-	910
	7	557	2200	1380	704	1,29	31,50	9,10	-	852	-	980
	7	557	2400	1485	758	1,28	33,60	9,80	-	909	-	1045
11386 0637 1200 XXXX YYYY -0000	8	637	1200	891	455	1,30	20,80	6,40	-	618	-	711
	8	637	1400	1024	522	1,30	24,00	7,28	-	684	-	787
	8	637	1600	1159	591	1,31	26,40	8,08	-	752	-	865
	8	637	1800	1302	664	1,31	29,60	8,88	-	816	-	938
	8	637	2000	1433	731	1,30	32,80	9,60	-	883	-	1015
	8	637	2200	1557	794	1,29	36,00	10,40	-	946	-	1088
	8	637	2400	1676	855	1,29	38,40	11,20	-	1011	-	1163

In conformity with EN442-1: 2014: radiators and convectors

For heat outputs in other regimes, see p. 320 (correction factors)
EXPORT. Prices in Euro (excl. VAT)

VIOLA-A VERTICAL (V1-ZB-A)



V1-ZB-A

HOW TO ORDER VIOLA-A VERTICAL

Delivery time 15 - 30 working days
(transport duration not included)

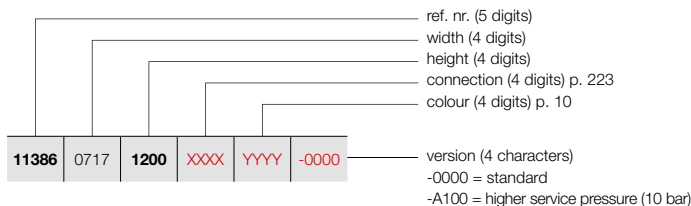

PRICE GROUP: VPG2 - STEEL DESIGN RADIATORS

REFERENCE CODE CUSTOM MADE VIOLA-A VERTICAL							TECHNICAL DATA					STANDARD COLOUR	OTHER COLOURS			
tubes	width (L mm)	height (H mm)	75/65/20 (Watt) (Φ50K)	55/45/20 (Watt) (Φ30K)	n-exp.	weight (kg)	water content (l)	electr. resistance (Watt)	price RAL 9016 (€)	price colour (€)						
REF. NR. VIOLA-A VERTICAL V1-ZB-A : 11386																
11386	0717	1200	XXXX	YYYY	-0000	9	717	1200	989	505	1,29	23,40	7,20	-	676	777
		1400				9	717	1400	1137	580	1,30	27,00	8,19	-	752	865
		1600				9	717	1600	1288	657	1,31	29,70	9,09	-	822	945
		1800				9	717	1800	1449	739	1,31	33,30	9,99	-	895	1029
		2000				9	717	2000	1594	813	1,30	36,90	10,80	-	968	1113
		2200				9	717	2200	1733	884	1,30	40,50	11,70	-	1043	1199
		2400				9	717	2400	1864	951	1,29	43,20	12,60	-	1115	1282
11386	0797	1200	XXXX	YYYY	-0000	10	797	1200	1087	555	1,29	26,00	8,00	-	734	844
		1400				10	797	1400	1249	637	1,30	30,00	9,10	-	816	938
		1600				10	797	1600	1414	721	1,30	33,00	10,10	-	895	1029
		1800				10	797	1800	1594	813	1,31	37,00	11,10	-	975	1121
		2000				10	797	2000	1754	895	1,31	41,00	12,00	-	1054	1212
		2200				10	797	2200	1906	972	1,30	45,00	13,00	-	1136	1306
		2400				10	797	2400	2051	1046	1,29	48,00	14,00	-	1216	1398
11386	0877	1200	XXXX	YYYY	-0000	11	877	1200	1183	604	1,28	28,60	8,80	-	791	910
		1400				11	877	1400	1360	694	1,29	33,00	10,01	-	881	1013
		1600				11	877	1600	1540	786	1,30	36,30	11,11	-	964	1109
		1800				11	877	1800	1738	887	1,31	40,70	12,21	-	1054	1212
		2000				11	877	2000	1912	976	1,31	45,10	13,20	-	1142	1313
		2200				11	877	2200	2078	1060	1,30	49,50	14,30	-	1229	1413
		2400				11	877	2400	2236	1141	1,29	52,80	15,40	-	1317	1515
11386	0957	1200	XXXX	YYYY	-0000	12	957	1200	1279	653	1,28	31,20	9,60	-	851	979
		1400				12	957	1400	1470	750	1,29	36,00	10,92	-	944	1086
		1600				12	957	1600	1664	849	1,30	39,60	12,12	-	1039	1195
		1800				12	957	1800	1881	960	1,31	44,40	13,32	-	1134	1304
		2000				12	957	2000	2069	1056	1,31	49,20	14,40	-	1229	1413
		2200				12	957	2200	2249	1147	1,30	54,00	15,60	-	1325	1524
		2400				12	957	2400	2420	1235	1,30	57,60	16,80	-	1420	1633
11386	1037	1200	XXXX	YYYY	-0000	13	1037	1200	1374	701	1,27	33,80	10,40	-	964	1109
		1400				13	1037	1400	1579	806	1,29	39,00	11,83	-	1075	1236
		1600				13	1037	1600	1788	912	1,30	42,90	13,13	-	1185	1363
		1800				13	1037	1800	2023	1032	1,31	48,10	14,43	-	1296	1490
		2000				13	1037	2000	2225	1135	1,31	53,30	15,60	-	1402	1612
		2200				13	1037	2200	2418	1234	1,30	58,50	16,90	-	1515	1742
		2400				13	1037	2400	2602	1328	1,30	62,40	18,20	-	1623	1866

In conformity with EN442-1: 2014: radiators and convectors

For heat outputs in other regimes, see p. 320 (correction factors)
EXPORT. Prices in Euro (excl. VAT)

VASCO

HOW TO ORDER VIOLA-A VERTICAL

Delivery time 15 - 30 working days
(transport duration not included)

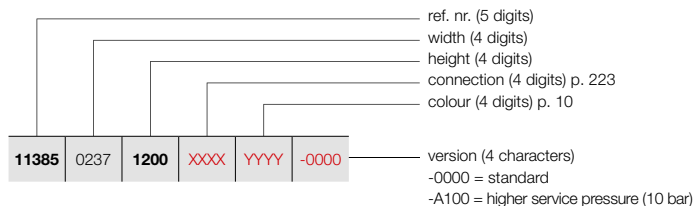

VIOLA-A VERTICAL (V1L1-ZB-A)



V1L1-ZB-A

PRICE GROUP: VPG2 - STEEL DESIGN RADIATORS

REFERENCE CODE CUSTOM MADE VIOLA-A VERTICAL							TECHNICAL DATA					STANDARD COLOUR	OTHER COLOURS			
tubes	width (L mm)	height (H mm)	75/65/20 (Watt) (Φ50K)	55/45/20 (Watt) (Φ30K)	n-exp.	weight (kg)	water content (l)	electr. resistance (Watt)	price RAL 9016 (€)	price colour (€)						
REF. NR. VIOLA-A VERTICAL V1L1-ZB-A : 11385																
11385	0237	1200	XXXX	YYYY	-0000	3	237	1200	464	237	1,28	10,50	2,40	-	408	469
		1400				3	237	1400	531	271	1,28	12,60	2,73	-	446	513
		1600				3	237	1600	597	305	1,29	14,40	3,03	-	483	555
		1800				3	237	1800	661	337	1,29	15,90	3,33	-	521	599
		2000				3	237	2000	723	369	1,30	18,30	3,60	-	556	639
		2200				3	237	2200	784	400	1,32	19,80	3,90	-	594	683
		2400				3	237	2400	843	430	1,33	21,60	4,20	-	630	725
11385	0317	1200	XXXX	YYYY	-0000	4	317	1200	605	309	1,28	14,00	3,20	-	483	555
		1400				4	317	1400	693	354	1,29	16,80	3,64	-	529	608
		1600				4	317	1600	778	397	1,29	19,20	4,04	-	572	658
		1800				4	317	1800	861	439	1,29	21,20	4,44	-	619	712
		2000				4	317	2000	943	481	1,31	24,40	4,80	-	665	765
		2200				4	317	2200	1022	521	1,32	26,40	5,20	-	708	814
		2400				4	317	2400	1099	561	1,33	28,80	5,60	-	756	869
11385	0397	1200	XXXX	YYYY	-0000	5	397	1200	743	379	1,29	17,50	4,00	-	554	637
		1400				5	397	1400	851	434	1,29	21,00	4,55	-	609	700
		1600				5	397	1600	956	488	1,29	24,00	5,05	-	665	765
		1800				5	397	1800	1058	540	1,30	26,50	5,55	-	718	826
		2000				5	397	2000	1158	591	1,31	30,50	6,00	-	774	890
		2200				5	397	2200	1255	640	1,32	33,00	6,50	-	828	952
		2400				5	397	2400	1350	689	1,33	36,00	7,00	-	886	1019
11385	0477	1200	XXXX	YYYY	-0000	6	477	1200	879	448	1,29	21,00	4,80	-	630	725
		1400				6	477	1400	1007	514	1,29	25,20	5,46	-	693	797
		1600				6	477	1600	1131	577	1,30	28,80	6,06	-	756	869
		1800				6	477	1800	1252	639	1,30	31,80	6,66	-	821	944
		2000				6	477	2000	1370	699	1,31	36,60	7,20	-	886	1019
		2200				6	477	2200	1485	758	1,32	39,60	7,80	-	947	1089
		2400				6	477	2400	1598	815	1,33	43,20	8,40	-	1011	1163
11385	0557	1200	XXXX	YYYY	-0000	7	557	1200	1013	517	1,29	24,50	5,60	-	701	806
		1400				7	557	1400	1160	592	1,30	29,40	6,37	-	774	890
		1600				7	557	1600	1303	665	1,30	33,60	7,07	-	848	975
		1800				7	557	1800	1443	736	1,31	37,10	7,77	-	920	1058
		2000				7	557	2000	1579	806	1,31	42,70	8,40	-	993	1142
		2200				7	557	2200	1712	873	1,32	46,20	9,10	-	1066	1226
		2400				7	557	2400	1841	939	1,33	50,40	9,80	-	1139	1310
11385	0637	1200	XXXX	YYYY	-0000	8	637	1200	1146	585	1,29	28,00	6,40	-	773	889
		1400				8	637	1400	1312	669	1,30	33,60	7,28	-	855	983
		1600				8	637	1600	1474	752	1,31	38,40	8,08	-	936	1076
		1800				8	637	1800	1632	833	1,31	42,40	8,88	-	1018	1171
		2000				8	637	2000	1786	911	1,32	48,80	9,60	-	1103	1268
		2200				8	637	2200	1936	988	1,32	52,80	10,40	-	1183	1360
		2400				8	637	2400	2083	1063	1,33	57,60	11,20	-	1266	1456

In conformity with EN442-1: 2014: radiators and convectors

For heat outputs in other regimes, see p. 320 (correction factors)
EXPORT. Prices in Euro (excl. VAT)

VASCO

VIOLA-A VERTICAL (V1L1-ZB-A)



V1L1-ZB-A

HOW TO ORDER VIOLA-A VERTICAL

Delivery time 15 - 30 working days
(transport duration not included)

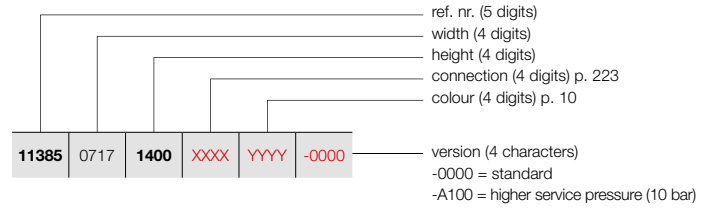

PRICE GROUP: VPG2 - STEEL DESIGN RADIATORS

REFERENCE CODE CUSTOM MADE VIOLA-A VERTICAL							TECHNICAL DATA					STANDARD COLOUR	OTHER COLOURS			
tubes	width (L mm)	height (H mm)	75/65/20 (Watt) (φ50K)	55/45/20 (Watt) (φ30K)	n-exp.	weight (kg)	water content (l)	electr. resistance (Watt)	price RAL 9016 (€)	price colour (€)						
REF. NR. VIOLA-A VERTICAL V1L1-ZB-A : 11385																
11385	0717	1400	XXXX	YYYY	-0000	9	717	1400	1462	746	1,30	37,80	8,19	-	936	1076
		1600				9	717	1600	1643	838	1,31	43,20	9,09	-	1027	1181
		1800				9	717	1800	1819	928	1,32	47,70	9,99	-	1119	1287
		2000				9	717	2000	1990	1015	1,32	54,90	10,80	-	1213	1395
		2200				9	717	2200	2158	1101	1,32	59,40	11,70	-	1300	1495
		2400				9	717	2400	2321	1184	1,33	64,80	12,60	-	1391	1600
11385	0797	1200	XXXX	YYYY	-0000	10	797	1200	1407	718	1,30	35,00	8,00	-	919	1057
		1400				10	797	1400	1611	822	1,31	42,00	9,10	-	1018	1171
		1600				10	797	1600	1810	923	1,31	48,00	10,10	-	1119	1287
		1800				10	797	1800	2004	1022	1,32	53,00	11,10	-	1220	1403
		2000				10	797	2000	2194	1119	1,32	61,00	12,00	-	1317	1515
		2200				10	797	2200	2387	1218	1,32	66,00	13,00	-	1420	1633
		2400				10	797	2400	2558	1305	1,33	72,00	14,00	-	1522	1750
11385	0877	1200	XXXX	YYYY	-0000	11	877	1200	1536	784	1,30	38,50	8,80	-	993	1142
		1400				11	877	1400	1759	897	1,31	46,20	10,01	-	1099	1264
		1600				11	877	1600	1976	1008	1,32	52,80	11,11	-	1211	1393
		1800				11	877	1800	2189	1117	1,32	58,30	12,21	-	1317	1515
		2000				11	877	2000	2394	1221	1,33	67,10	13,20	-	1427	1641
		2200				11	877	2200	2596	1324	1,33	72,60	14,30	-	1537	1768
		2400				11	877	2400	2792	1424	1,33	79,20	15,40	-	1648	1895
11385	0957	1200	XXXX	YYYY	-0000	12	957	1200	1665	849	1,31	42,00	9,60	-	1063	1222
		1400				12	957	1400	1907	973	1,31	50,40	10,92	-	1180	1357
		1600				12	957	1600	2142	1093	1,32	57,60	12,12	-	1299	1494
		1800				12	957	1800	2371	1210	1,33	63,60	13,32	-	1419	1632
		2000				12	957	2000	2595	1324	1,33	73,20	14,40	-	1537	1768
		2200				12	957	2200	2813	1435	1,33	79,20	15,60	-	1656	1904
		2400				12	957	2400	3026	1544	1,33	86,40	16,80	-	1777	2044
11385	1037	1200	XXXX	YYYY	-0000	13	1037	1200	1792	914	1,31	45,50	10,40	-	1211	1393
		1400				13	1037	1400	2052	1047	1,32	54,60	11,83	-	1345	1547
		1600				13	1037	1600	2306	1177	1,33	62,40	13,13	-	1484	1707
		1800				13	1037	1800	2552	1302	1,33	68,90	14,43	-	1618	1861
		2000				13	1037	2000	2793	1425	1,33	79,30	15,60	-	1755	2018
		2200				13	1037	2200	3028	1545	1,33	85,80	16,90	-	1892	2176
		2400				13	1037	2400	3257	1662	1,33	93,60	18,20	-	2031	2336

In conformity with EN442-1: 2014: radiators and convectors

For heat outputs in other regimes, see p. 320 (correction factors)
EXPORT. Prices in Euro (excl. VAT)

VASCO

HOW TO ORDER VIOLA-A VERTICAL

Delivery time 15 - 30 working days
(transport duration not included)

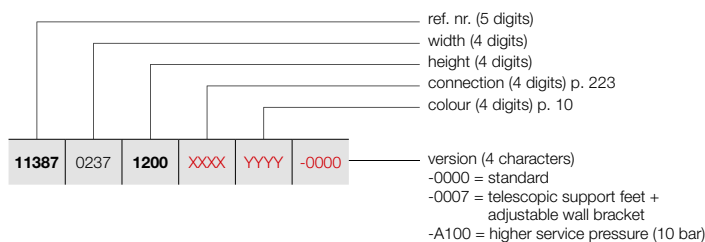

HOW TO ORDER STOCK RADIATOR VIOLA-A VERTICAL

Delivery time 5 working days
(transport duration not included)

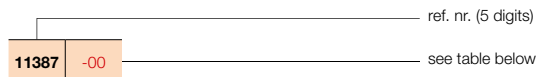

VIOLA-A VERTICAL (V2-ZB-A)



V2-ZB-A

PRICE GROUP: VPG2 - STEEL DESIGN RADIATORS

REFERENCE CODE CUSTOM MADE VIOLA-A VERTICAL							TECHNICAL DATA					STANDARD COLOUR		OTHER COLOURS			
							tubes	width (L mm)	height (H mm)	75/65/20 (Watt) (φ50K)	55/45/20 (Watt) (φ30K)	n-exp.	weight (kg)	water content (l)	electr. resistance (Watt)	price RAL 9016 (€)	short ref. nr. RAL 9016 stock
REF. NR. VIOLA-A VERTICAL V2-ZB-A : 11387																	
11387	0237	1200	XXXX	YYYY	-0000	3	237	1200	509	260	1,33	14,40	4,59	-	556	-	639
		1400				3	237	1400	587	299	1,34	16,80	5,04	-	607	-	698
		1600				3	237	1600	664	339	1,35	18,90	5,52	-	657	-	756
		1800				3	237	1800	743	379	1,35	21,30	5,97	-	704	-	810
		2000				3	237	2000	821	419	1,35	23,40	6,39	-	756	-	869
		2200				3	237	2200	900	459	1,34	25,80	6,81	-	806	-	927
		2400				3	237	2400	979	499	1,34	28,20	7,23	-	855	-	983
11387	0317	1200	XXXX	YYYY	-0000	4	317	1200	655	334	1,33	19,20	6,12	-	657	-	756
		1400				4	317	1400	755	385	1,34	22,40	6,72	-	718	-	826
		1600				4	317	1600	854	436	1,35	25,20	7,36	-	783	-	900
		1800				4	317	1800	952	486	1,35	28,40	7,96	-	841	-	967
		2000				4	317	2000	1050	536	1,35	31,20	8,52	-	903	-	1038
		2200				4	317	2200	1147	585	1,35	34,40	9,08	-	963	-	1107
		2400				4	317	2400	1244	635	1,34	37,60	9,64	-	1027	-	1181
11387	0397	1200	XXXX	YYYY	-0000	5	397	1200	802	409	1,33	24,00	7,65	-	755	-	868
		1400				5	397	1400	923	471	1,34	28,00	8,40	-	831	-	956
		1600				5	397	1600	1043	532	1,35	31,50	9,20	-	903	-	1038
		1800				5	397	1800	1162	593	1,36	35,50	9,95	-	980	-	1127
		2000				5	397	2000	1279	653	1,35	39,00	10,65	-	1053	-	1211
		2200				5	397	2200	1394	711	1,35	43,00	11,35	-	1125	-	1294
		2400				5	397	2400	1509	770	1,34	47,00	12,05	-	1202	-	1382
11387	0477	1200	XXXX	YYYY	-0000	6	477	1200	948	484	1,34	28,80	9,18	-	855	-	983
		1400				6	477	1400	1092	557	1,34	33,60	10,08	-	940	-	1081
		1600				6	477	1600	1232	629	1,35	37,80	11,04	-	1027	-	1181
		1800				6	477	1800	1371	699	1,36	42,60	11,94	-	1117	-	1285
		2000				6	477	2000	1507	769	1,35	46,80	12,78	-	1202	-	1382
		2200				6	477	2200	1642	838	1,35	51,60	13,62	-	1292	-	1486
		2400				6	477	2400	1775	906	1,34	56,40	14,46	-	1375	-	1581
11387	0557	1200	XXXX	YYYY	-0000	7	557	1200	1094	558	1,34	33,60	10,71	-	954	-	1097
		1400				7	557	1400	1260	643	1,34	39,20	11,76	-	1053	-	1211
		1600				7	557	1600	1422	726	1,35	44,10	12,88	-	1151	-	1324
		1800				7	557	1800	1580	806	1,36	49,70	13,93	-	1251	-	1439
		2000				7	557	2000	1736	886	1,36	54,60	14,91	-	1347	-	1549
		2200				7	557	2200	1889	964	1,35	60,20	15,89	-	1447	-	1664
		2400				7	557	2400	2040	1041	1,35	65,80	16,87	-	1549	-	1781
11387	0637	1200	XXXX	YYYY	-0000	8	637	1200	1240	633	1,34	38,40	12,24	-	1051	-	1209
		1400				8	637	1400	1428	729	1,35	44,80	13,44	-	1161	-	1335
		1600				8	637	1600	1611	822	1,35	50,40	14,72	-	1273	-	1464
		1800				8	637	1800	1790	913	1,36	56,80	15,92	-	1387	-	1595
		2000				8	637	2000	1965	1003	1,36	62,40	17,04	-	1496	11387-01	1720
		2200				8	637	2200	2136	1090	1,35	68,80	18,16	-	1609	-	1850
		2400				8	637	2400	2305	1176	1,35	75,20	19,28	-	1719	-	1977

In conformity with EN442-1: 2014: radiators and convectors

For heat outputs in other regimes, see p. 320 (correction factors)
EXPORT. Prices in Euro (excl. VAT)

VASCO

VIOLA-A VERTICAL (V2-ZB-A)

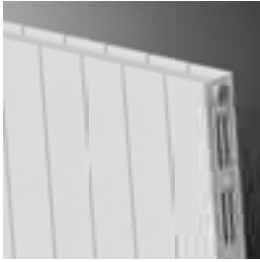

V2-ZB-A

HOW TO ORDER VIOLA-A VERTICAL

Delivery time 15 - 30 working days
(transport duration not included)

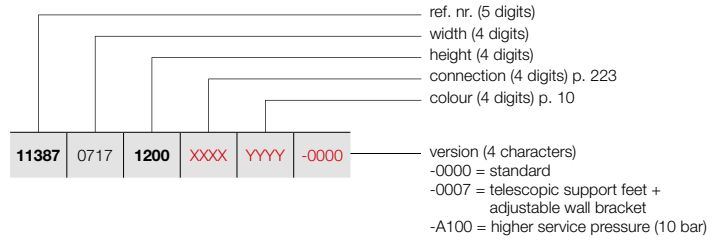

PRICE GROUP: VPG2 - STEEL DESIGN RADIATORS

REFERENCE CODE CUSTOM MADE VIOLA-A VERTICAL							TECHNICAL DATA					STANDARD COLOUR	OTHER COLOURS			
tubes	width (L mm)	height (H mm)	75/65/20 (Watt) (φ50K)	55/45/20 (Watt) (φ30K)	n-exp.	weight (kg)	water content (l)	electr. resistance (Watt)	price RAL 9016 (€)	price colour (€)						
REF. NR. VIOLA-A VERTICAL V2-ZB-A : 11387																
11387	0717	1200	XXXX	YYYY	-0000	9	717	1200	1387	708	1,34	43,20	13,77	-	1151	1324
		1400				9	717	1400	1596	814	1,35	50,40	15,12	-	1273	1464
		1600				9	717	1600	1801	919	1,36	56,70	16,56	-	1398	1608
		1800				9	717	1800	1999	1020	1,36	63,90	17,91	-	1523	1751
		2000				9	717	2000	2194	1119	1,36	70,20	19,17	-	1647	1894
		2200				9	717	2200	2384	1216	1,35	77,40	20,43	-	1769	2034
		2400				9	717	2400	2570	1311	1,35	84,60	21,69	-	1893	2177
11387	0797	1200	XXXX	YYYY	-0000	10	797	1200	1533	782	1,34	48,00	15,30	-	1245	1432
		1400				10	797	1400	1765	901	1,35	56,00	16,80	-	1387	1595
		1600				10	797	1600	1990	1015	1,36	63,00	18,40	-	1523	1751
		1800				10	797	1800	2209	1127	1,37	71,00	19,90	-	1658	1907
		2000				10	797	2000	2422	1236	1,36	78,00	21,30	-	1793	2062
		2200				10	797	2200	2631	1342	1,36	86,00	22,70	-	1930	2220
		2400				10	797	2400	2836	1447	1,35	94,00	24,10	-	2067	2377
11387	0877	1200	XXXX	YYYY	-0000	11	877	1200	1679	857	1,34	52,80	16,83	-	1347	1549
		1400				11	877	1400	1933	986	1,35	61,60	18,48	-	1494	1718
		1600				11	877	1600	2179	1112	1,36	69,30	20,24	-	1645	1892
		1800				11	877	1800	2418	1234	1,37	78,10	21,89	-	1793	2062
		2000				11	877	2000	2651	1353	1,36	85,80	23,43	-	1942	2233
		2200				11	877	2200	2878	1468	1,36	94,60	24,97	-	2090	2404
		2400				11	877	2400	3101	1582	1,35	103,40	26,51	-	2240	2576
11387	0957	1200	XXXX	YYYY	-0000	12	957	1200	1825	931	1,35	57,60	18,36	-	1445	1662
		1400				12	957	1400	2101	1072	1,35	67,20	20,16	-	1603	1843
		1600				12	957	1600	2369	1209	1,36	75,60	22,08	-	1765	2030
		1800				12	957	1800	2628	1341	1,37	85,20	23,88	-	1929	2218
		2000				12	957	2000	2880	1469	1,36	93,60	25,56	-	2090	2404
		2200				12	957	2200	3126	1595	1,36	103,20	27,24	-	2251	2589
		2400				12	957	2400	3366	1717	1,36	112,80	28,92	-	2414	2776
11387	1037	1200	XXXX	YYYY	-0000	13	1037	1200	1972	1006	1,35	62,40	19,89	-	1645	1892
		1400				13	1037	1400	2270	1158	1,36	72,80	21,84	-	1827	2101
		1600				13	1037	1600	2558	1305	1,36	81,90	23,92	-	2014	2316
		1800				13	1037	1800	2837	1447	1,37	92,30	25,87	-	2199	2529
		2000				13	1037	2000	3109	1586	1,37	101,40	27,69	-	2387	2745
		2200				13	1037	2200	3373	1721	1,36	111,80	29,51	-	2573	2959
		2400				13	1037	2400	3631	1853	1,36	122,20	31,33	-	2760	3174

In conformity with EN442-1: 2014: radiators and convectors

For heat outputs in other regimes, see p. 320 (correction factors)
EXPORT. Prices in Euro (excl. VAT)

VIOLA-A HORIZONTAL (H1-RO-A, H1L1-RO-A, H2-RO-A, H2L1-RO-A, H2L2-RO-A)

TYPES

- H1-RO-A single row of tubes, H2-RO-A double row of tubes, H1L1-RO-A, H2L1-RO-A, H2L2-RO-A (1 or 2 rows of steel fins)



TUBES

- Horizontal, rectangular 77 x 10 mm

COLLECTORS

- H1-RO-A and H1L1-RO-A: 35 x 43 mm
- H2-RO-A and H2L1-RO-A: 35 x 41 mm
- H2L2-RO-A: 35 x 81 mm

COLOURS

- Standard colour white RAL 9016
- Extensive colour chart see p. 10

SPECIAL

- As to type HL-RO, 1 or 2 steel fins are welded at the back of the flat-oval tubes in order to increase the heat emission.
- Standard with grill.
- H1L1-RO-A also available as toilet radiator (500 x 400 mm)

BRACKETS

- Wall brackets standard (included in packaging of radiator)
- Upper bracket in colour of radiator, bottom:
 - Distance keeper radiator white = distance keeper white.
 - Distance keeper radiator in colour = distance keeper RAL 7024.
- **H2-RO-A/H2L1-RO-A:** Radiator with telescopic support feet + adjustable wall bracket: please indicate code **-0007** for "Finish" when ordering (see p. 220).
- **H2-RO-A/H2L1-RO-A:** Also available as free-standing radiator (see p. 221)

TECHNICAL

- Welded by means of resistance welding robots (invisible weld seams)
- ATL priming coat, powder coating
- Standard operating pressure: 4 bar. Extra charge for higher service pressures (10 bar): +10%.
- The delivery time of a radiator with a higher service pressure is 1 week extra.
- Maximum operating temperature: 110°C

ELECTRICAL

- ✗ Pure electrical radiator prefilled
- ✗ Mixed radiator

TECHNICAL DRAWINGS

- See p. 225

CONNECTION

- ✗ One-point connection for one-pipe system
- ✗ One-point connection for two-pipe system
- ✓ Two-point connection for one-pipe system (connection by way of the integrated valve) (see p. 314)
- ✓ Two-point connection for two-pipe system (standard) (see p. 312)
- ✓ Integrated valve (**extra charge €113**) (order as special radiator) (see p. 314)
- Connections: ½" (inner thread)



VIOLA-A HORIZONTAL

Following a great tradition

Just like the Viola-A Vertical, the Viola-A Horizontal combines a sober, uniform look with optimal heat output. The radiator is available as a single or double. The simple design fits anywhere. It can also be installed as a free-standing model.

RECOMMENDED CONNECTION INTEGRATED VALVE (SUPPLEMENT)

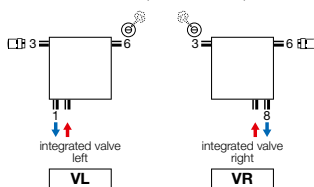

Supplement: **€113** (see p. 314)

Other connection methods, see p. 223

Thermostatic head to be ordered separately



ref. nr. 118230100000099

price **€147**

Fittings, see p. 327



ref. nr. 11911630102

price **€44**

Thermostatic head to be ordered separately

RECOMMENDED FOR BATHROOM AND KITCHEN IN OPTION



towel rail (RAL 9005)

ref. nr. see p. 222

price **€145**

Other accessories, see p. 222



H2-RO-A / H2L1-RO-A

VIOLA-A HORIZONTAL (H1-RO-A)



H1-RO-A
(thermostatic head to be ordered separately)

HOW TO ORDER VIOLA-A HORIZONTAL

Delivery time 15 - 30 working days
(transport duration not included)

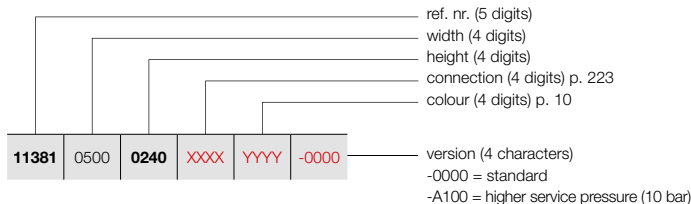

PRICE GROUP: VPG2 - STEEL DESIGN RADIATORS

REFERENCE CODE CUSTOM MADE VIOLA-A HORIZONTAL							TECHNICAL DATA					STANDARD COLOUR	OTHER COLOURS			
tubes	width (L mm)	height (H mm)	75/65/20 (Watt) (Φ50K)	55/45/20 (Watt) (Φ30K)	n-exp.	weight (kg)	water content (l)	electr. resistance (Watt)	price RAL 9016 (€)	price colour (€)						
REF. NR. VIOLA-A HORIZONTAL H1-RO-A : 11381																
11381	0500	0240	XXXX	YYYY	-0000	3	500	240	141	72	1,25	3,15	1,00	-	246	283
		0320				4	500	320	179	91	1,25	3,25	1,40	-	278	320
		0400				5	500	400	223	114	1,26	5,50	1,70	-	311	358
		0480				6	500	480	266	136	1,26	6,60	2,05	-	343	394
		0560				7	500	560	310	158	1,26	7,70	2,40	-	377	434
		0640				8	500	640	353	180	1,26	8,80	2,75	-	408	469
		0720				9	500	720	396	202	1,26	9,90	3,10	-	442	508
		0800				10	500	800	438	223	1,26	11,00	3,50	-	472	543
		0880				11	500	880	481	245	1,27	12,10	3,85	-	509	585
11381	0600	0240	XXXX	YYYY	-0000	3	600	240	169	86	1,25	3,78	1,20	-	262	301
		0320				4	600	320	215	110	1,25	3,90	1,68	-	301	346
		0400				5	600	400	267	136	1,26	6,60	2,04	-	337	388
		0480				6	600	480	319	163	1,26	7,92	2,46	-	375	431
		0560				7	600	560	371	189	1,26	9,24	2,88	-	410	472
		0640				8	600	640	423	216	1,26	10,56	3,30	-	446	513
		0720				9	600	720	475	242	1,26	11,88	3,72	-	483	555
		0800				10	600	800	526	268	1,26	13,20	4,20	-	522	600
		0880				11	600	880	577	294	1,27	14,52	4,62	-	556	639
11381	0700	0240	XXXX	YYYY	-0000	3	700	240	197	100	1,25	4,41	1,40	-	287	330
		0320				4	700	320	251	128	1,25	4,55	1,96	-	324	373
		0400				5	700	400	312	159	1,26	7,70	2,38	-	365	420
		0480				6	700	480	372	190	1,26	9,24	2,87	-	405	466
		0560				7	700	560	433	221	1,26	10,78	3,36	-	444	511
		0640				8	700	640	494	252	1,26	12,32	3,85	-	485	558
		0720				9	700	720	554	283	1,26	13,86	4,34	-	527	606
		0800				10	700	800	613	313	1,26	15,40	4,90	-	565	650
		0880				11	700	880	673	343	1,27	16,94	5,39	-	606	697
11381	0800	0240	XXXX	YYYY	-0000	3	800	240	225	115	1,25	5,04	1,60	-	307	353
		0320				4	800	320	286	146	1,25	5,20	2,24	-	351	404
		0400				5	800	400	356	182	1,26	8,80	2,72	-	392	451
		0480				6	800	480	426	217	1,26	10,56	3,28	-	437	503
		0560				7	800	560	495	253	1,26	12,32	3,84	-	480	552
		0640				8	800	640	564	288	1,26	14,08	4,40	-	524	603
		0720				9	800	720	633	323	1,26	15,84	4,96	-	567	652
		0800				10	800	800	701	358	1,26	17,60	5,60	-	609	700
		0880				11	800	880	769	392	1,27	19,36	6,16	-	656	754
11381	0900	0240	XXXX	YYYY	-0000	3	900	240	253	129	1,25	5,67	1,80	-	324	373
		0320				4	900	320	322	164	1,25	5,85	2,52	-	374	430
		0400				5	900	400	401	204	1,26	9,90	3,06	-	420	483
		0480				6	900	480	479	244	1,26	11,88	3,69	-	468	538
		0560				7	900	560	557	284	1,26	13,86	4,32	-	516	593
		0640				8	900	640	635	324	1,26	15,84	4,95	-	563	647
		0720				9	900	720	712	363	1,26	17,82	5,58	-	608	699
		0800				10	900	800	788	402	1,26	19,80	6,30	-	658	757
		0880				11	900	880	865	441	1,27	21,78	6,93	-	703	808

In conformity with EN442-1: 2014: radiators and convectors

For heat outputs in other regimes, see p. 320 (correction factors)
EXPORT. Prices in Euro (excl. VAT)

HOW TO ORDER VIOLA-A HORIZONTAL

Delivery time 15 - 30 working days
(transport duration not included)

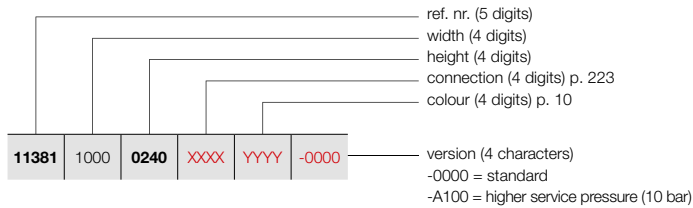

VIOLA-A HORIZONTAL (H1-RO-A)



H1-RO-A
(thermostatic head to be ordered separately)

PRICE GROUP: VPG2 - STEEL DESIGN RADIATORS

REFERENCE CODE CUSTOM MADE VIOLA-A HORIZONTAL	TECHNICAL DATA									STANDARD COLOUR	OTHER COLOURS	
	tubes	width (L mm)	height (H mm)	75/65/20 (Watt) (φ50K)	55/45/20 (Watt) (φ30K)	n-exp.	weight (kg)	water content (l)	electr. resistance (Watt)	price RAL 9016 (€)	price colour (€)	
REF. NR. VIOLA-A HORIZONTAL H1-RO-A : 11381												
11381 1000 0240 XXXX YYYY -0000	0320	3	1000	240	281	143	1,25	6,30	2,00	-	345	397
	0400	4	1000	320	358	183	1,25	6,50	2,80	-	394	453
	0480	5	1000	400	445	227	1,26	11,00	3,40	-	446	513
	0560	6	1000	480	532	271	1,26	13,20	4,10	-	497	572
	0640	7	1000	560	619	316	1,26	15,40	4,80	-	549	631
	0720	8	1000	640	705	360	1,26	17,60	5,50	-	600	690
	0800	9	1000	720	791	404	1,26	19,80	6,20	-	650	748
	0880	10	1000	800	876	447	1,26	22,00	7,00	-	702	807
		11	1000	880	961	490	1,27	24,20	7,70	-	754	867
	11381 1100 0240 XXXX YYYY -0000	0320	3	1100	240	309	158	1,25	6,93	2,20	-	365
0400		4	1100	320	394	201	1,25	7,15	3,08	-	420	483
0480		5	1100	400	490	250	1,26	12,10	3,74	-	472	543
0560		6	1100	480	585	299	1,26	14,52	4,51	-	530	610
0640		7	1100	560	681	347	1,26	16,94	5,28	-	585	673
0720		8	1100	640	776	396	1,26	19,36	6,05	-	637	733
0800		9	1100	720	870	444	1,26	21,78	6,82	-	694	798
0880		10	1100	800	964	492	1,26	24,20	7,70	-	750	863
		11	1100	880	1057	539	1,27	26,62	8,47	-	802	922
11381 1200 0240 XXXX YYYY -0000		0320	3	1200	240	337	172	1,25	7,56	2,40	-	384
	0400	4	1200	320	430	219	1,25	7,80	3,36	-	443	509
	0480	5	1200	400	534	272	1,26	13,20	4,08	-	500	575
	0560	6	1200	480	638	326	1,26	15,84	4,92	-	561	645
	0640	7	1200	560	743	379	1,26	18,48	5,76	-	619	712
	0720	8	1200	640	846	432	1,26	21,12	6,60	-	676	777
	0800	9	1200	720	949	484	1,26	23,76	7,44	-	738	849
	0880	10	1200	800	1051	536	1,26	26,40	8,40	-	791	910
		11	1200	880	1153	588	1,27	29,04	9,24	-	852	980
	11381 1400 0240 XXXX YYYY -0000	0320	3	1400	240	393	201	1,25	8,82	2,80	-	423
0400		4	1400	320	501	256	1,25	9,10	3,92	-	490	564
0480		5	1400	400	623	318	1,26	15,40	4,76	-	556	639
0560		6	1400	480	745	380	1,26	18,48	5,74	-	623	716
0640		7	1400	560	867	442	1,26	21,56	6,72	-	687	790
0720		8	1400	640	987	504	1,26	24,64	7,70	-	754	867
0800		9	1400	720	1107	565	1,26	27,72	8,68	-	819	942
0880		10	1400	800	1226	626	1,26	30,80	9,80	-	887	1020
		11	1400	880	1345	686	1,27	33,88	10,78	-	953	1096
11381 1600 0240 XXXX YYYY -0000		0320	3	1600	240	450	229	1,25	10,08	3,20	-	464
	0400	4	1600	320	573	292	1,25	10,40	4,48	-	537	618
	0480	5	1600	400	712	363	1,26	17,60	5,44	-	609	700
	0560	6	1600	480	851	434	1,26	21,12	6,56	-	684	787
	0640	7	1600	560	990	505	1,26	24,64	7,68	-	757	871
	0720	8	1600	640	1128	576	1,26	28,16	8,80	-	831	956
	0800	9	1600	720	1266	646	1,26	31,68	9,92	-	903	1038
	0880	10	1600	800	1402	715	1,26	35,20	11,20	-	976	1122
		11	1600	880	1538	784	1,27	38,72	12,32	-	1051	1209

In conformity with EN442-1: 2014: radiators and convectors

For heat outputs in other regimes, see p. 320 (correction factors)
EXPORT. Prices in Euro (excl. VAT)

VIOLA-A HORIZONTAL (H1-RO-A)



H1-RO-A
(thermostatic head to be ordered separately)

HOW TO ORDER VIOLA-A HORIZONTAL

Delivery time 15 - 30 working days
(transport duration not included)

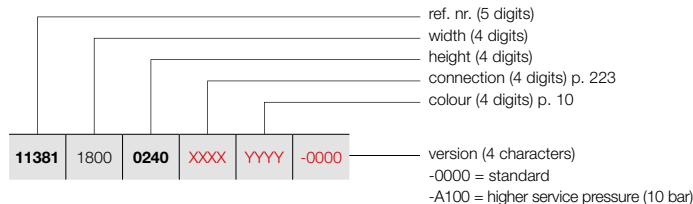

PRICE GROUP: VPG2 - STEEL DESIGN RADIATORS

REFERENCE CODE CUSTOM MADE VIOLA-A HORIZONTAL							TECHNICAL DATA				STANDARD COLOUR	OTHER COLOURS				
tubes	width (L mm)	height (H mm)	75/65/20 (Watt) (Ø50K)	55/45/20 (Watt) (Ø30K)	n-exp.	weight (kg)	water content (l)	electr. resistance (Watt)	price RAL 9016 (€)	price colour (€)						
REF. NR. VIOLA-A HORIZONTAL H1-RO-A : 11381																
11381	1800	0240	XXXX	YYYY	-0000	3	1800	240	506	258	1,25	11,34	3,60	-	505	581
		0320				4	1800	320	644	329	1,25	11,70	5,04	-	586	674
		0400				5	1800	400	801	409	1,26	19,80	6,12	-	667	767
		0480				6	1800	480	958	489	1,26	23,76	7,38	-	747	859
		0560				7	1800	560	1114	568	1,26	27,72	8,64	-	827	951
		0640				8	1800	640	1269	647	1,26	31,68	9,90	-	905	1041
		0720				9	1800	720	1424	726	1,26	35,64	11,16	-	989	1137
		0800				10	1800	800	1577	804	1,26	39,60	12,60	-	1068	1228
		0880				11	1800	880	1730	883	1,27	43,56	13,86	-	1149	1321
11381	2000	0240	XXXX	YYYY	-0000	3	2000	240	562	287	1,25	12,60	4,00	-	542	623
		0320				4	2000	320	716	365	1,25	13,00	5,60	-	632	727
		0400				5	2000	400	890	454	1,26	22,00	6,80	-	718	826
		0480				6	2000	480	1064	543	1,26	26,40	8,20	-	807	928
		0560				7	2000	560	1238	632	1,26	30,80	9,60	-	895	1029
		0640				8	2000	640	1410	719	1,26	35,20	11,00	-	982	1129
		0720				9	2000	720	1582	807	1,26	39,60	12,40	-	1070	1231
		0800				10	2000	800	1752	894	1,26	44,00	14,00	-	1157	1331
		0880				11	2000	880	1922	981	1,27	48,40	15,40	-	1244	1431
11381	2200	0240	XXXX	YYYY	-0000	3	2200	240	618	315	1,25	13,86	4,40	-	585	673
		0320				4	2200	320	788	402	1,25	14,30	6,16	-	680	782
		0400				5	2200	400	979	499	1,26	24,20	7,48	-	775	891
		0480				6	2200	480	1170	597	1,26	29,04	9,02	-	866	996
		0560				7	2200	560	1362	695	1,26	33,88	10,56	-	963	1107
		0640				8	2200	640	1551	791	1,26	38,72	12,10	-	1059	1218
		0720				9	2200	720	1740	888	1,26	43,56	13,64	-	1155	1328
		0800				10	2200	800	1927	983	1,26	48,40	15,40	-	1248	1435
		0880				11	2200	880	2114	1079	1,27	53,24	16,94	-	1345	1547
11381	2400	0240	XXXX	YYYY	-0000	3	2400	240	674	344	1,25	15,12	4,80	-	625	719
		0320				4	2400	320	859	438	1,25	15,60	6,72	-	729	838
		0400				5	2400	400	1068	545	1,26	26,40	8,16	-	831	956
		0480				6	2400	480	1277	651	1,26	31,68	9,84	-	931	1071
		0560				7	2400	560	1486	758	1,26	36,96	11,52	-	1032	1187
		0640				8	2400	640	1692	863	1,26	42,24	13,20	-	1136	1306
		0720				9	2400	720	1898	969	1,26	47,52	14,88	-	1238	1424
		0800				10	2400	800	2102	1073	1,26	52,80	16,80	-	1340	1541
		0880				11	2400	880	2306	1177	1,27	58,08	18,48	-	1444	1661
11381	2600	0240	XXXX	YYYY	-0000	3	2600	240	731	373	1,25	16,38	5,20	-	665	765
		0320				4	2600	320	931	475	1,25	16,90	7,28	-	774	890
		0400				5	2600	400	1157	590	1,26	28,60	8,84	-	886	1019
		0480				6	2600	480	1383	706	1,26	34,32	10,66	-	995	1144
		0560				7	2600	560	1609	821	1,26	40,04	12,48	-	1104	1270
		0640				8	2600	640	1833	935	1,26	45,76	14,30	-	1214	1396
		0720				9	2600	720	2057	1049	1,26	51,48	16,12	-	1323	1521
		0800				10	2600	800	2278	1162	1,26	57,20	18,20	-	1434	1649
		0880				11	2600	880	2499	1275	1,27	62,92	20,02	-	1542	1773

In conformity with EN442-1: 2014: radiators and convectors

For heat outputs in other regimes, see p. 320 (correction factors)
EXPORT. Prices in Euro (excl. VAT)

HOW TO ORDER VIOLA-A HORIZONTAL

Delivery time 15 - 30 working days
(transport duration not included)

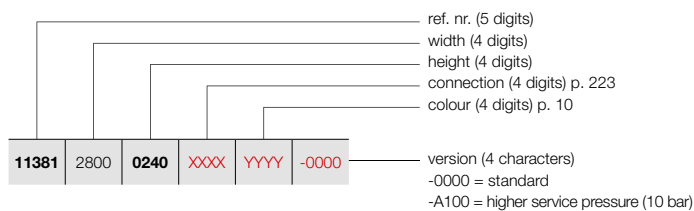

VIOLA-A HORIZONTAL (H1-RO-A)



H1-RO-A
(thermostatic head to be ordered separately)

PRICE GROUP: VPG2 - STEEL DESIGN RADIATORS

REFERENCE CODE CUSTOM MADE VIOLA-A HORIZONTAL	TECHNICAL DATA									STANDARD COLOUR	OTHER COLOURS					
	tubes	width (L mm)	height (H mm)	75/65/20 (Watt) (φ50K)	55/45/20 (Watt) (φ30K)	n-exp.	weight (kg)	water content (l)	electr. resistance (Watt)	price RAL 9016 (€)	price colour (€)					
REF. NR. VIOLA-A HORIZONTAL H1-RO-A : 11381																
11381	2800	0240	XXXX	YYYY	-0000	3	2800	240	787	401	1,25	17,64	5,60	-	703	808
		0320				4	2800	320	1002	511	1,25	18,20	7,84	-	822	945
		0400				5	2800	400	1246	636	1,26	30,80	9,52	-	936	1076
		0480				6	2800	480	1490	760	1,26	36,96	11,48	-	1056	1214
		0560				7	2800	560	1733	884	1,26	43,12	13,44	-	1171	1347
		0640				8	2800	640	1974	1007	1,26	49,28	15,40	-	1292	1486
		0720				9	2800	720	2215	1130	1,26	55,44	17,36	-	1405	1616
		0800				10	2800	800	2453	1251	1,26	61,60	19,60	-	1525	1754
		0880				11	2800	880	2691	1373	1,27	67,76	21,56	-	1642	1888
11381	3000	0240	XXXX	YYYY	-0000	3	3000	240	843	430	1,25	18,90	6,00	-	743	854
		0320				4	3000	320	1074	548	1,25	19,50	8,40	-	865	995
		0400				5	3000	400	1335	681	1,26	33,00	10,20	-	994	1143
		0480				6	3000	480	1596	814	1,26	39,60	12,30	-	1118	1286
		0560				7	3000	560	1857	947	1,26	46,20	14,40	-	1240	1426
		0640				8	3000	640	2115	1079	1,26	52,80	16,50	-	1367	1572
		0720				9	3000	720	2373	1211	1,26	59,40	18,60	-	1490	1714
		0800				10	3000	800	2628	1341	1,26	66,00	21,00	-	1615	1857
		0880				11	3000	880	2883	1471	1,27	72,60	23,10	-	1740	2001

In conformity with EN442-1: 2014: radiators and convectors

For heat outputs in other regimes, see p. 320 (correction factors)
EXPORT. Prices in Euro (excl. VAT)

VIOLA-A HORIZONTAL (H1L1-RO-A)

HOW TO ORDER VIOLA-A HORIZONTAL

Delivery time 15 - 30 working days
(transport duration not included)



H1L1-RO-A
(thermostatic head to be ordered separately)

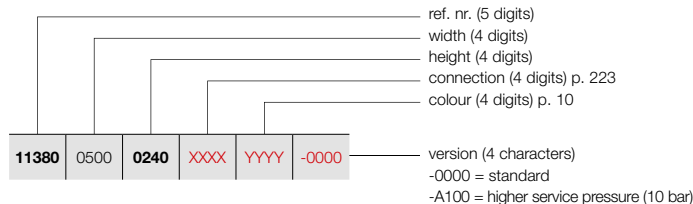

PRICE GROUP: VPG2 - STEEL DESIGN RADIATORS

REFERENCE CODE CUSTOM MADE VIOLA-A HORIZONTAL							TECHNICAL DATA					STANDARD COLOUR	OTHER COLOURS			
tubes	width (L mm)	height (H mm)	75/65/20 (Watt) (Φ50K)	55/45/20 (Watt) (Φ30K)	n-exp.	weight (kg)	water content (l)	electr. resistance (Watt)	price RAL 9016 (€)	price colour (€)						
REF. NR. VIOLA-A HORIZONTAL H1L1-RO-A : 11380																
11380	0500	0240	XXXX	YYYY	-0000	3	500	240	261	133	1,24	5,45	1,00	-	285	328
		0320				4	500	320	334	170	1,26	7,30	1,40	-	323	371
		0400				5	500	400	399	204	1,27	9,10	1,70	-	367	422
		0480				6	500	480	464	237	1,28	10,95	2,05	-	409	470
		0560				7	500	560	530	270	1,30	12,75	2,40	-	455	523
		0640				8	500	640	581	296	1,30	14,60	2,75	-	496	570
		0720				9	500	720	618	315	1,30	15,70	3,10	-	538	619
		0800				10	500	800	684	349	1,31	18,25	3,50	-	584	672
		0880				11	500	880	719	367	1,31	19,35	3,85	-	625	719
11380	0600	0240	XXXX	YYYY	-0000	3	600	240	313	160	1,24	6,54	1,20	-	310	357
		0320				4	600	320	401	204	1,26	8,76	1,68	-	360	414
		0400				5	600	400	479	244	1,27	10,92	2,04	-	407	468
		0480				6	600	480	557	284	1,28	13,14	2,46	-	456	524
		0560				7	600	560	635	324	1,30	15,30	2,88	-	500	575
		0640				8	600	640	697	356	1,30	17,52	3,30	-	552	635
		0720				9	600	720	741	378	1,30	18,84	3,72	-	600	690
		0800				10	600	800	821	419	1,31	21,90	4,20	-	646	743
		0880				11	600	880	863	440	1,31	23,22	4,62	-	697	802
11380	0700	0240	XXXX	YYYY	-0000	3	700	240	365	186	1,24	7,63	1,40	-	334	384
		0320				4	700	320	468	239	1,26	10,22	1,96	-	390	449
		0400				5	700	400	559	285	1,27	12,74	2,38	-	444	511
		0480				6	700	480	650	331	1,28	15,33	2,87	-	498	573
		0560				7	700	560	741	378	1,30	17,85	3,36	-	553	636
		0640				8	700	640	813	415	1,30	20,44	3,85	-	606	697
		0720				9	700	720	865	441	1,30	21,98	4,34	-	661	760
		0800				10	700	800	958	489	1,31	25,55	4,90	-	713	820
		0880				11	700	880	1007	514	1,31	27,09	5,39	-	768	883
11380	0800	0240	XXXX	YYYY	-0000	3	800	240	418	213	1,24	8,72	1,60	-	364	419
		0320				4	800	320	534	273	1,26	11,68	2,24	-	423	486
		0400				5	800	400	638	326	1,27	14,56	2,72	-	483	555
		0480				6	800	480	742	379	1,28	17,52	3,28	-	541	622
		0560				7	800	560	847	432	1,30	20,40	3,84	-	603	693
		0640				8	800	640	930	474	1,30	23,36	4,40	-	664	764
		0720				9	800	720	988	504	1,30	25,12	4,96	-	724	833
		0800				10	800	800	1094	558	1,31	29,20	5,60	-	783	900
		0880				11	800	880	1150	587	1,31	30,96	6,16	-	841	967
11380	0900	0240	XXXX	YYYY	-0000	3	900	240	470	240	1,24	9,81	1,80	-	392	451
		0320				4	900	320	601	307	1,26	13,14	2,52	-	458	527
		0400				5	900	400	718	366	1,27	16,38	3,06	-	523	601
		0480				6	900	480	835	426	1,28	19,71	3,69	-	588	676
		0560				7	900	560	953	486	1,30	22,95	4,32	-	652	750
		0640				8	900	640	1046	534	1,30	26,28	4,95	-	717	825
		0720				9	900	720	1112	567	1,30	28,26	5,58	-	784	902
		0800				10	900	800	1231	628	1,31	32,85	6,30	-	850	978
		0880				11	900	880	1294	660	1,31	34,83	6,93	-	916	1053

In conformity with EN442-1: 2014: radiators and convectors

For heat outputs in other regimes, see p. 320 (correction factors)
EXPORT. Prices in Euro (excl. VAT)

HOW TO ORDER VIOLA-A HORIZONTAL

Delivery time 15 - 30 working days
(transport duration not included)

VIOLA-A HORIZONTAL (H1L1-RO-A)

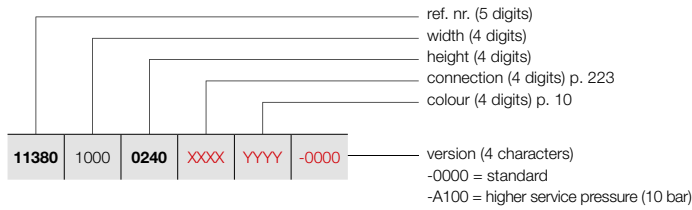

H1L1-RO-A
(thermostatic head to be ordered separately)

PRICE GROUP: VPG2 - STEEL DESIGN RADIATORS

REFERENCE CODE CUSTOM MADE VIOLA-A HORIZONTAL						TECHNICAL DATA					STANDARD COLOUR	OTHER COLOURS									
						tubes	width (L mm)	height (H mm)	75/65/20 (Watt) (φ50K)	55/45/20 (Watt) (φ30K)	n-exp.	weight (kg)	water content (l)	electr. resistance (Watt)	price RAL 9016 (€)	price colour (€)					
REF. NR. VIOLA-A HORIZONTAL H1L1-RO-A : 11380																					
11380	1000	0240	XXXX	YYYY	-0000	3	1000	240	522	266	1,24	10,90	2,00	-	420	483					
		0320				4	1000	320	668	341	1,26	14,60	2,80	-	489	562					
		0400				5	1000	400	798	407	1,27	18,20	3,40	-	563	647					
		0480				6	1000	480	928	473	1,28	21,90	4,10	-	632	727					
		0560				7	1000	560	1059	540	1,30	25,50	4,80	-	702	807					
		0640				8	1000	640	1162	593	1,30	29,20	5,50	-	774	890					
		0720				9	1000	720	1235	630	1,30	31,40	6,20	-	847	974					
		0800				10	1000	800	1368	698	1,31	36,50	7,00	-	916	1053					
		0880				11	1000	880	1438	734	1,31	38,70	7,70	-	988	1136					
		11380				1100	0240	XXXX	YYYY	-0000	3	1100	240	574	293	1,24	11,99	2,20	-	446	513
							0320				4	1100	320	735	375	1,26	16,06	3,08	-	524	603
0400	5		1100	400	878		448				1,27	20,02	3,74	-	600	690					
0480	6		1100	480	1021		521				1,28	24,09	4,51	-	676	777					
0560	7		1100	560	1165		594				1,30	28,05	5,28	-	754	867					
0640	8		1100	640	1278		652				1,30	32,12	6,05	-	831	956					
0720	9		1100	720	1359		693				1,30	34,54	6,82	-	904	1040					
0800	10		1100	800	1505		768				1,31	40,15	7,70	-	981	1128					
0880	11		1100	880	1582		807				1,31	42,57	8,47	-	1058	1217					
11380	1200		0240	XXXX	YYYY		-0000				3	1200	240	626	320	1,24	13,08	2,40	-	473	544
			0320								4	1200	320	802	409	1,26	17,52	3,36	-	556	639
		0400	5			1200		400	958	489	1,27	21,84	4,08	-	637	733					
		0480	6			1200		480	1114	568	1,28	26,28	4,92	-	720	828					
		0560	7			1200		560	1271	648	1,30	30,60	5,76	-	802	922					
		0640	8			1200		640	1394	711	1,30	35,04	6,60	-	886	1019					
		0720	9			1200		720	1482	756	1,30	37,68	7,44	-	964	1109					
		0800	10			1200		800	1642	838	1,31	43,80	8,40	-	1050	1208					
		0880	11			1200		880	1726	880	1,31	46,44	9,24	-	1129	1298					
		11380	1400			0240		XXXX	YYYY	-0000	3	1400	240	731	373	1,24	15,26	2,80	-	530	610
						0320					4	1400	320	935	477	1,26	20,44	3,92	-	625	719
0400	5			1400	400	1117	570				1,27	25,48	4,76	-	714	821					
0480	6			1400	480	1299	663				1,28	30,66	5,74	-	808	929					
0560	7			1400	560	1483	756				1,30	35,70	6,72	-	903	1038					
0640	8			1400	640	1627	830				1,30	40,88	7,70	-	996	1145					
0720	9			1400	720	1729	882				1,30	43,96	8,68	-	1085	1248					
0800	10			1400	800	1915	977				1,31	51,10	9,80	-	1183	1360					
0880	11			1400	880	2013	1027				1,31	54,18	10,78	-	1273	1464					
11380	1600			0240	XXXX	YYYY	-0000				3	1600	240	835	426	1,24	17,44	3,20	-	586	674
				0320							4	1600	320	1069	545	1,26	23,36	4,48	-	690	794
		0400	5	1600				400	1277	651	1,27	29,12	5,44	-	791	910					
		0480	6	1600				480	1485	758	1,28	35,04	6,56	-	899	1034					
		0560	7	1600				560	1694	864	1,30	40,80	7,68	-	1001	1151					
		0640	8	1600				640	1859	949	1,30	46,72	8,80	-	1106	1272					
		0720	9	1600				720	1976	1008	1,30	50,24	9,92	-	1213	1395					
		0800	10	1600				800	2189	1117	1,31	58,40	11,20	-	1314	1511					
		0880	11	1600				880	2301	1174	1,31	61,92	12,32	-	1420	1633					

In conformity with EN442-1: 2014: radiators and convectors

For heat outputs in other regimes, see p. 320 (correction factors)
EXPORT. Prices in Euro (excl. VAT)

VASCO

VIOLA-A HORIZONTAL (H1L1-RO-A)



H1L1-RO-A
(thermostatic head to be ordered separately)

HOW TO ORDER VIOLA-A HORIZONTAL

Delivery time 15 - 30 working days
(transport duration not included)

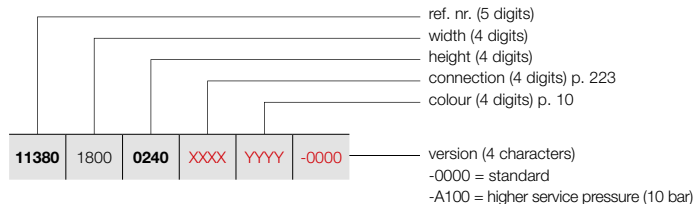

PRICE GROUP: VPG2 - STEEL DESIGN RADIATORS

REFERENCE CODE CUSTOM MADE VIOLA-A HORIZONTAL							TECHNICAL DATA					STANDARD COLOUR	OTHER COLOURS			
tubes	width (L mm)	height (H mm)	75/65/20 (Watt) (Φ50K)	55/45/20 (Watt) (Φ30K)	n-exp.	weight (kg)	water content (l)	electr. resistance (Watt)	price RAL 9016 (€)	price colour (€)						
REF. NR. VIOLA-A HORIZONTAL H1L1-RO-A : 11380																
11380	1800	0240	XXXX	YYYY	-0000	3	1800	240	940	479	1,24	19,62	3,60	-	638	734
		0320				4	1800	320	1202	613	1,26	26,28	5,04	-	756	869
		0400				5	1800	400	1436	733	1,27	32,76	6,12	-	868	998
		0480				6	1800	480	1670	852	1,28	39,42	7,38	-	988	1136
		0560				7	1800	560	1906	973	1,30	45,90	8,64	-	1104	1270
		0640				8	1800	640	2092	1067	1,30	52,56	9,90	-	1219	1402
		0720				9	1800	720	2223	1134	1,30	56,52	11,16	-	1332	1532
		0800				10	1800	800	2462	1256	1,31	65,70	12,60	-	1447	1664
		0880				11	1800	880	2588	1321	1,31	69,66	13,86	-	1563	1797
11380	2000	0240	XXXX	YYYY	-0000	3	2000	240	1044	533	1,24	21,80	4,00	-	696	800
		0320				4	2000	320	1336	682	1,26	29,20	5,60	-	822	945
		0400				5	2000	400	1596	814	1,27	36,40	6,80	-	951	1094
		0480				6	2000	480	1856	947	1,28	43,80	8,20	-	1075	1236
		0560				7	2000	560	2118	1081	1,30	51,00	9,60	-	1202	1382
		0640				8	2000	640	2324	1186	1,30	58,40	11,00	-	1329	1528
		0720				9	2000	720	2470	1260	1,30	62,80	12,40	-	1455	1673
		0800				10	2000	800	2736	1396	1,31	73,00	14,00	-	1581	1818
		0880				11	2000	880	2876	1467	1,31	77,40	15,40	-	1710	1967
11380	2200	0240	XXXX	YYYY	-0000	3	2200	240	1148	586	1,24	23,98	4,40	-	753	866
		0320				4	2200	320	1470	750	1,26	32,12	6,16	-	889	1022
		0400				5	2200	400	1756	896	1,27	40,04	7,48	-	1026	1180
		0480				6	2200	480	2042	1042	1,28	48,18	9,02	-	1165	1340
		0560				7	2200	560	2330	1189	1,30	56,10	10,56	-	1300	1495
		0640				8	2200	640	2556	1304	1,30	64,24	12,10	-	1440	1656
		0720				9	2200	720	2717	1386	1,30	69,08	13,64	-	1578	1815
		0800				10	2200	800	3010	1536	1,31	80,30	15,40	-	1716	1973
		0880				11	2200	880	3164	1614	1,31	85,14	16,94	-	1852	2130
11380	2400	0240	XXXX	YYYY	-0000	3	2400	240	1253	639	1,24	26,16	4,80	-	806	927
		0320				4	2400	320	1603	818	1,26	35,04	6,72	-	956	1099
		0400				5	2400	400	1915	977	1,27	43,68	8,16	-	1105	1271
		0480				6	2400	480	2227	1136	1,28	52,56	9,84	-	1254	1442
		0560				7	2400	560	2542	1297	1,30	61,20	11,52	-	1400	1610
		0640				8	2400	640	2789	1423	1,30	70,08	13,20	-	1550	1783
		0720				9	2400	720	2964	1512	1,30	75,36	14,88	-	1697	1952
		0800				10	2400	800	3283	1675	1,31	87,60	16,80	-	1848	2125
		0880				11	2400	880	3451	1761	1,31	92,88	18,48	-	1999	2299
11380	2600	0240	XXXX	YYYY	-0000	3	2600	240	1357	692	1,24	28,34	5,20	-	860	989
		0320				4	2600	320	1737	886	1,26	37,96	7,28	-	1020	1173
		0400				5	2600	400	2075	1059	1,27	47,32	8,84	-	1180	1357
		0480				6	2600	480	2413	1231	1,28	56,94	10,66	-	1340	1541
		0560				7	2600	560	2753	1405	1,30	66,30	12,48	-	1500	1725
		0640				8	2600	640	3021	1541	1,30	75,92	14,30	-	1660	1909
		0720				9	2600	720	3211	1638	1,30	81,64	16,12	-	1822	2095
		0800				10	2600	800	3557	1815	1,31	94,90	18,20	-	1981	2278
		0880				11	2600	880	3739	1908	1,31	100,62	20,02	-	2142	2463

In conformity with EN442-1: 2014: radiators and convectors

For heat outputs in other regimes, see p. 320 (correction factors)
EXPORT. Prices in Euro (excl. VAT)

HOW TO ORDER VIOLA-A HORIZONTAL

Delivery time 15 - 30 working days
(transport duration not included)

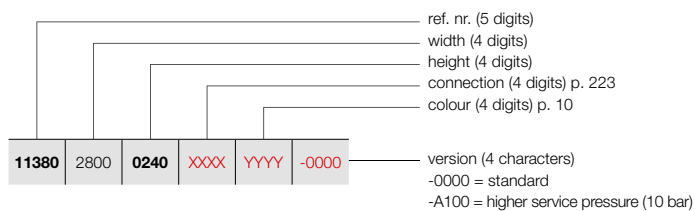

VIOLA-A HORIZONTAL (H1L1-RO-A)



H1L1-RO-A
(thermostatic head to be ordered separately)

PRICE GROUP: VPG2 - STEEL DESIGN RADIATORS

REFERENCE CODE CUSTOM MADE VIOLA-A HORIZONTAL	TECHNICAL DATA									STANDARD COLOUR	OTHER COLOURS					
	tubes	width (L mm)	height (H mm)	75/65/20 (Watt) (Φ50K)	55/45/20 (Watt) (Φ30K)	n-exp.	weight (kg)	water content (l)	electr. resistance (Watt)	price RAL 9016 (€)	price colour (€)					
REF. NR. VIOLA-A HORIZONTAL H1L1-RO-A : 11380																
11380	2800	0240	XXXX	YYYY	-0000	3	2800	240	1462	746	1,24	30,52	5,60	-	917	1055
		0320				4	2800	320	1870	954	1,26	40,88	7,84	-	1085	1248
		0400				5	2800	400	2234	1140	1,27	50,96	9,52	-	1259	1448
		0480				6	2800	480	2598	1326	1,28	61,32	11,48	-	1428	1642
		0560				7	2800	560	2965	1513	1,30	71,40	13,44	-	1601	1841
		0640				8	2800	640	3254	1660	1,30	81,76	15,40	-	1773	2039
		0720				9	2800	720	3458	1764	1,30	87,92	17,36	-	1943	2234
		0800				10	2800	800	3830	1954	1,31	102,20	19,60	-	2115	2432
		0880				11	2800	880	4026	2054	1,31	108,36	21,56	-	2286	2629
11380	3000	0240	XXXX	YYYY	-0000	3	3000	240	1566	799	1,24	32,70	6,00	-	973	1119
		0320				4	3000	320	2004	1022	1,26	43,80	8,40	-	1153	1326
		0400				5	3000	400	2394	1221	1,27	54,60	10,20	-	1337	1538
		0480				6	3000	480	2784	1420	1,28	65,70	12,30	-	1520	1748
		0560				7	3000	560	3177	1621	1,30	76,50	14,40	-	1700	1955
		0640				8	3000	640	3486	1779	1,30	87,60	16,50	-	1882	2164
		0720				9	3000	720	3705	1890	1,30	94,20	18,60	-	2067	2377
		0800				10	3000	800	4104	2094	1,31	109,50	21,00	-	2249	2586
		0880				11	3000	880	4314	2201	1,31	116,10	23,10	-	2429	2793

In conformity with EN442-1: 2014: radiators and convectors

For heat outputs in other regimes, see p. 320 (correction factors)
EXPORT. Prices in Euro (excl. VAT)

VIOLA-A HORIZONTAL (H2-RO-A)



H2-RO-A
(thermostatic head to be ordered separately)

HOW TO ORDER VIOLA-A HORIZONTAL

Delivery time 15 - 30 working days
(transport duration not included)

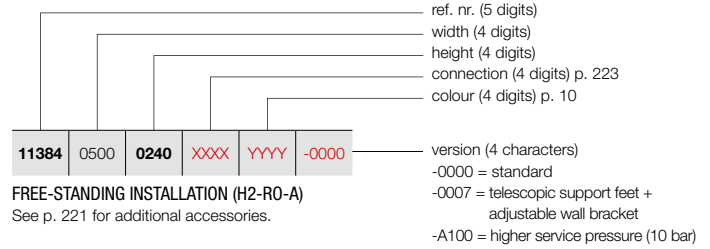

FREE-STANDING INSTALLATION (H2-RO-A)
See p. 221 for additional accessories.

PRICE GROUP: VPG2 - STEEL DESIGN RADIATORS

REFERENCE CODE CUSTOM MADE VIOLA-A HORIZONTAL							TECHNICAL DATA					STANDARD COLOUR	OTHER COLOURS			
tubes	width (L mm)	height (H mm)	75/65/20 (Watt) (Φ50K)	55/45/20 (Watt) (Φ30K)	n-exp.	weight (kg)	water content (l)	electr. resistance (Watt)	price RAL 9016 (€)	price colour (€)						
REF. NR. VIOLA-A HORIZONTAL H2-RO-A : 11384																
11384	0500	0240	XXXX	YYYY	-0000	3	500	240	218	111	1,23	6,10	1,70	-	464	534
		0320				4	500	320	273	139	1,22	8,15	2,25	-	530	610
		0400				5	500	400	329	168	1,23	10,15	2,85	-	596	685
		0480				6	500	480	389	198	1,25	12,20	3,45	-	661	760
		0560				7	500	560	454	231	1,26	14,25	4,05	-	728	837
		0640				8	500	640	523	267	1,27	16,25	4,65	-	789	907
		0720				9	500	720	600	306	1,28	18,30	5,25	-	856	984
		0800				10	500	800	663	338	1,28	20,35	5,70	-	922	1060
		0880				11	500	880	726	370	1,29	22,35	6,20	-	989	1137
11384	0600	0240	XXXX	YYYY	-0000	3	600	240	262	133	1,23	7,32	2,04	-	498	573
		0320				4	600	320	327	167	1,22	9,78	2,70	-	571	657
		0400				5	600	400	395	201	1,23	12,18	3,42	-	642	738
		0480				6	600	480	467	238	1,25	14,64	4,14	-	717	825
		0560				7	600	560	544	278	1,26	17,10	4,86	-	788	906
		0640				8	600	640	628	320	1,27	19,50	5,58	-	861	990
		0720				9	600	720	719	367	1,28	21,96	6,30	-	933	1073
		0800				10	600	800	795	406	1,28	24,42	6,84	-	1008	1159
		0880				11	600	880	871	444	1,29	26,82	7,44	-	1080	1242
11384	0700	0240	XXXX	YYYY	-0000	3	700	240	305	156	1,23	8,54	2,38	-	535	615
		0320				4	700	320	382	195	1,22	11,41	3,15	-	615	707
		0400				5	700	400	461	235	1,23	14,21	3,99	-	694	798
		0480				6	700	480	545	278	1,25	17,08	4,83	-	774	890
		0560				7	700	560	635	324	1,26	19,95	5,67	-	854	982
		0640				8	700	640	732	374	1,27	22,75	6,51	-	933	1073
		0720				9	700	720	839	428	1,28	25,62	7,35	-	1014	1166
		0800				10	700	800	928	473	1,28	28,49	7,98	-	1094	1258
		0880				11	700	880	1016	518	1,29	31,29	8,68	-	1173	1349
11384	0800	0240	XXXX	YYYY	-0000	3	800	240	349	178	1,23	9,76	2,72	-	569	654
		0320				4	800	320	436	222	1,22	13,04	3,60	-	657	756
		0400				5	800	400	526	269	1,23	16,24	4,56	-	743	854
		0480				6	800	480	622	318	1,25	19,52	5,52	-	832	957
		0560				7	800	560	726	370	1,26	22,80	6,48	-	919	1057
		0640				8	800	640	837	427	1,27	26,00	7,44	-	1004	1155
		0720				9	800	720	959	489	1,28	29,28	8,40	-	1093	1257
		0800				10	800	800	1060	541	1,28	32,56	9,12	-	1180	1357
		0880				11	800	880	1161	592	1,29	35,76	9,92	-	1267	1457
11384	0900	0240	XXXX	YYYY	-0000	3	900	240	392	200	1,23	10,98	3,06	-	603	693
		0320				4	900	320	491	250	1,22	14,67	4,05	-	700	805
		0400				5	900	400	592	302	1,23	18,27	5,13	-	791	910
		0480				6	900	480	700	357	1,25	21,96	6,21	-	888	1021
		0560				7	900	560	816	416	1,26	25,65	7,29	-	982	1129
		0640				8	900	640	941	480	1,27	29,25	8,37	-	1076	1237
		0720				9	900	720	1079	551	1,28	32,94	9,45	-	1170	1346
		0800				10	900	800	1193	608	1,28	36,63	10,26	-	1267	1457
		0880				11	900	880	1306	666	1,29	40,23	11,16	-	1364	1569

In conformity with EN442-1: 2014: radiators and convectors

For heat outputs in other regimes, see p. 320 (correction factors)
EXPORT. Prices in Euro (excl. VAT)

HOW TO ORDER VIOLA-A HORIZONTAL

Delivery time 15 - 30 working days
(transport duration not included)

11384	1000	0240	XXXX	YYYY	-0000
-------	------	------	------	------	-------

ref. nr. (5 digits)
width (4 digits)
height (4 digits)
connection (4 digits) p. 223
colour (4 digits) p. 10

version (4 characters)
-0000 = standard
-0007 = telescopic support feet +
adjustable wall bracket
-A100 = higher service pressure (10 bar)

FREE-STANDING INSTALLATION (H2-RO-A)
See p. 221 for additional accessories.

VIOLA-A HORIZONTAL (H2-RO-A)



H2-RO-A
(thermostatic head to be ordered separately)

PRICE GROUP: VPG2 - STEEL DESIGN RADIATORS

REFERENCE CODE CUSTOM MADE VIOLA-A HORIZONTAL	TECHNICAL DATA									STANDARD COLOUR	OTHER COLOURS										
	tubes	width (L mm)	height (H mm)	75/65/20 (Watt) (φ50K)	55/45/20 (Watt) (φ30K)	n-exp.	weight (kg)	water content (l)	electr. resistance (Watt)	price RAL 9016 (€)	price colour (€)										
REF. NR. VIOLA-A HORIZONTAL H2-RO-A : 11384																					
11384	1000	0240	XXXX	YYYY	-0000	3	1000	240	436	222	1,23	12,20	3,40	-	637	733					
		0320				4	1000	320	545	278	1,22	16,30	4,50	-	741	852					
		0400				5	1000	400	658	336	1,23	20,30	5,70	-	842	968					
		0480				6	1000	480	778	397	1,25	24,40	6,90	-	944	1086					
		0560				7	1000	560	907	463	1,26	28,50	8,10	-	1049	1206					
		0640				8	1000	640	1046	534	1,27	32,50	9,30	-	1150	1323					
		0720				9	1000	720	1199	612	1,28	36,60	10,50	-	1251	1439					
		0800				10	1000	800	1325	676	1,28	40,70	11,40	-	1350	1553					
		0880				11	1000	880	1451	740	1,29	44,70	12,40	-	1454	1672					
		11384				1100	0240	XXXX	YYYY	-0000	3	1100	240	480	245	1,23	13,42	3,74	-	674	775
							0320				4	1100	320	600	306	1,22	17,93	4,95	-	783	900
0400	5		1100	400	724		369				1,23	22,33	6,27	-	892	1026					
0480	6		1100	480	856		437				1,25	26,84	7,59	-	1000	1150					
0560	7		1100	560	998		509				1,26	31,35	8,91	-	1110	1277					
0640	8		1100	640	1151		587				1,27	35,75	10,23	-	1220	1403					
0720	9		1100	720	1319		673				1,28	40,26	11,55	-	1329	1528					
0800	10		1100	800	1458		744				1,28	44,77	12,54	-	1439	1655					
0880	11		1100	880	1596		814				1,29	49,17	13,64	-	1548	1780					
11384	1200		0240	XXXX	YYYY		-0000				3	1200	240	523	267	1,23	14,64	4,08	-	705	811
			0320								4	1200	320	654	334	1,22	19,56	5,40	-	823	946
		0400	5			1200		400	790	403	1,23	24,36	6,84	-	940	1081					
		0480	6			1200		480	934	476	1,25	29,28	8,28	-	1058	1217					
		0560	7			1200		560	1088	555	1,26	34,20	9,72	-	1173	1349					
		0640	8			1200		640	1255	640	1,27	39,00	11,16	-	1293	1487					
		0720	9			1200		720	1439	734	1,28	43,92	12,60	-	1405	1616					
		0800	10			1200		800	1590	811	1,28	48,84	13,68	-	1525	1754					
		0880	11			1200		880	1741	888	1,29	53,64	14,88	-	1642	1888					
		11384	1400			0240		XXXX	YYYY	-0000	3	1400	240	610	311	1,23	17,08	4,76	-	777	894
						0320					4	1400	320	763	389	1,22	22,82	6,30	-	906	1042
0400	5			1400	400	921	470				1,23	28,42	7,98	-	1038	1194					
0480	6			1400	480	1089	556				1,25	34,16	9,66	-	1170	1346					
0560	7			1400	560	1270	648				1,26	39,90	11,34	-	1300	1495					
0640	8			1400	640	1464	747				1,27	45,50	13,02	-	1434	1649					
0720	9			1400	720	1679	856				1,28	51,24	14,70	-	1564	1799					
0800	10			1400	800	1855	946				1,28	56,98	15,96	-	1695	1949					
0880	11			1400	880	2031	1036				1,29	62,58	17,36	-	1826	2100					
11384	1600			0240	XXXX	YYYY	-0000				3	1600	240	698	356	1,23	19,52	5,44	-	848	975
				0320							4	1600	320	872	445	1,22	26,08	7,20	-	994	1143
		0400	5	1600				400	1053	537	1,23	32,48	9,12	-	1137	1308					
		0480	6	1600				480	1245	635	1,25	39,04	11,04	-	1284	1477					
		0560	7	1600				560	1451	740	1,26	45,60	12,96	-	1428	1642					
		0640	8	1600				640	1674	854	1,27	52,00	14,88	-	1577	1814					
		0720	9	1600				720	1918	979	1,28	58,56	16,80	-	1720	1978					
		0800	10	1600				800	2120	1082	1,28	65,12	18,24	-	1867	2147					
		0880	11	1600				880	2322	1184	1,29	71,52	19,84	-	2013	2315					

In conformity with EN442-1: 2014: radiators and convectors

For heat outputs in other regimes, see p. 320 (correction factors)
EXPORT. Prices in Euro (excl. VAT)

VASCO

VIOLA-A HORIZONTAL (H2-RO-A)



H2-RO-A
(thermostatic head to be ordered separately)

HOW TO ORDER VIOLA-A HORIZONTAL

Delivery time 15 - 30 working days
(transport duration not included)

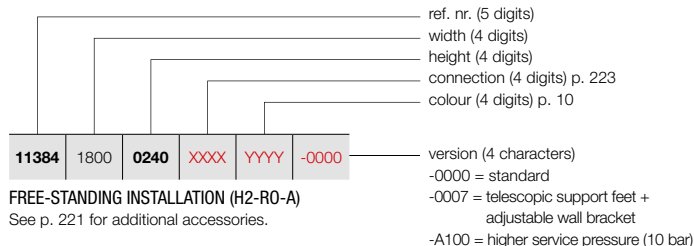

FREE-STANDING INSTALLATION (H2-RO-A)

See p. 221 for additional accessories.

PRICE GROUP: VPG2 - STEEL DESIGN RADIATORS

REFERENCE CODE CUSTOM MADE VIOLA-A HORIZONTAL							TECHNICAL DATA					STANDARD COLOUR	OTHER COLOURS			
tubes	width (L mm)	height (H mm)	75/65/20 (Watt) (Φ50K)	55/45/20 (Watt) (Φ30K)	n-exp.	weight (kg)	water content (l)	electr. resistance (Watt)	price RAL 9016 (€)	price colour (€)						
REF. NR. VIOLA-A HORIZONTAL H2-RO-A : 11384																
11384	1800	0240	XXXX	YYYY	-0000	3	1800	240	785	400	1,23	21,96	6,12	-	916	1053
		0320				4	1800	320	981	501	1,22	29,34	8,10	-	1075	1236
		0400				5	1800	400	1184	604	1,23	36,54	10,26	-	1236	1421
		0480				6	1800	480	1400	714	1,25	43,92	12,42	-	1398	1608
		0560				7	1800	560	1633	833	1,26	51,30	14,58	-	1558	1792
		0640				8	1800	640	1883	961	1,27	58,50	16,74	-	1718	1976
		0720				9	1800	720	2158	1101	1,28	65,88	18,90	-	1878	2160
		0800				10	1800	800	2385	1217	1,28	73,26	20,52	-	2040	2346
		0880				11	1800	880	2612	1333	1,29	80,46	22,32	-	2198	2528
11384	2000	0240	XXXX	YYYY	-0000	3	2000	240	872	445	1,23	24,40	6,80	-	986	1134
		0320				4	2000	320	1090	556	1,22	32,60	9,00	-	1158	1332
		0400				5	2000	400	1316	671	1,23	40,60	11,40	-	1336	1536
		0480				6	2000	480	1556	794	1,25	48,80	13,80	-	1512	1739
		0560				7	2000	560	1814	926	1,26	57,00	16,20	-	1687	1940
		0640				8	2000	640	2092	1067	1,27	65,00	18,60	-	1862	2141
		0720				9	2000	720	2398	1223	1,28	73,20	21,00	-	2036	2341
		0800				10	2000	800	2650	1352	1,28	81,40	22,80	-	2212	2544
		0880				11	2000	880	2902	1481	1,29	89,40	24,80	-	2387	2745
11384	2200	0240	XXXX	YYYY	-0000	3	2200	240	959	489	1,23	26,84	7,48	-	1053	1211
		0320				4	2200	320	1199	612	1,22	35,86	9,90	-	1241	1427
		0400				5	2200	400	1448	739	1,23	44,66	12,54	-	1435	1650
		0480				6	2200	480	1712	873	1,25	53,68	15,18	-	1623	1866
		0560				7	2200	560	1995	1018	1,26	62,70	17,82	-	1813	2085
		0640				8	2200	640	2301	1174	1,27	71,50	20,46	-	2006	2307
		0720				9	2200	720	2638	1346	1,28	80,52	23,10	-	2192	2521
		0800				10	2200	800	2915	1487	1,28	89,54	25,08	-	2385	2743
		0880				11	2200	880	3192	1629	1,29	98,34	27,28	-	2573	2959
11384	2400	0240	XXXX	YYYY	-0000	3	2400	240	1046	534	1,23	29,28	8,16	-	1123	1291
		0320				4	2400	320	1308	667	1,22	39,12	10,80	-	1327	1526
		0400				5	2400	400	1579	806	1,23	48,72	13,68	-	1531	1761
		0480				6	2400	480	1867	953	1,25	58,56	16,56	-	1738	1999
		0560				7	2400	560	2177	1111	1,26	68,40	19,44	-	1942	2233
		0640				8	2400	640	2510	1281	1,27	78,00	22,32	-	2146	2468
		0720				9	2400	720	2878	1468	1,28	87,84	25,20	-	2351	2704
		0800				10	2400	800	3180	1622	1,28	97,68	27,36	-	2554	2937
		0880				11	2400	880	3482	1777	1,29	107,28	29,76	-	2759	3173
11384	2600	0240	XXXX	YYYY	-0000	3	2600	240	1134	578	1,23	31,72	8,84	-	1191	1370
		0320				4	2600	320	1417	723	1,22	42,38	11,70	-	1413	1625
		0400				5	2600	400	1711	873	1,23	52,78	14,82	-	1631	1876
		0480				6	2600	480	2023	1032	1,25	63,44	17,94	-	1851	2129
		0560				7	2600	560	2358	1203	1,26	74,10	21,06	-	2071	2382
		0640				8	2600	640	2720	1388	1,27	84,50	24,18	-	2291	2635
		0720				9	2600	720	3117	1591	1,28	95,16	27,30	-	2507	2883
		0800				10	2600	800	3445	1758	1,28	105,82	29,64	-	2726	3135
		0880				11	2600	880	3773	1925	1,29	116,22	32,24	-	2944	3386

In conformity with EN442-1: 2014: radiators and convectors

For heat outputs in other regimes, see p. 320 (correction factors)
EXPORT. Prices in Euro (excl. VAT)

HOW TO ORDER VIOLA-A HORIZONTAL

Delivery time 15 - 30 working days
(transport duration not included)

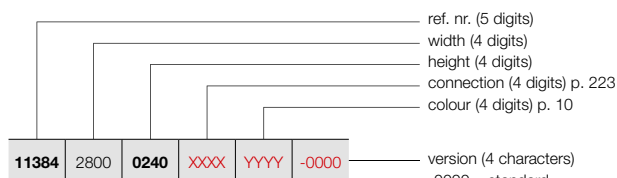

FREE-STANDING INSTALLATION (H2-RO-A)

See p. 221 for additional accessories.

- ref. nr. (5 digits)
- width (4 digits)
- height (4 digits)
- connection (4 digits) p. 223
- colour (4 digits) p. 10
- version (4 characters)
- 0000 = standard
- 0007 = telescopic support feet + adjustable wall bracket
- A100 = higher service pressure (10 bar)

VIOLA-A HORIZONTAL (H2-RO-A)



H2-RO-A
(thermostatic head to be ordered separately)

PRICE GROUP: VPG2 - STEEL DESIGN RADIATORS

REFERENCE CODE CUSTOM MADE VIOLA-A HORIZONTAL	TECHNICAL DATA									STANDARD COLOUR	OTHER COLOURS					
	tubes	width (L mm)	height (H mm)	75/65/20 (Watt) (Φ50K)	55/45/20 (Watt) (Φ30K)	n-exp.	weight (kg)	water content (l)	electr. resistance (Watt)	price RAL 9016 (€)	price colour (€)					
REF. NR. VIOLA-A HORIZONTAL H2-RO-A : 11384																
11384	2800	0240	XXXX	YYYY	-0000	3	2800	240	1221	623	1,23	34,16	9,52	-	1263	1452
		0320				4	2800	320	1526	779	1,22	45,64	12,60	-	1494	1718
		0400				5	2800	400	1842	940	1,23	56,84	15,96	-	1729	1988
		0480				6	2800	480	2178	1111	1,25	68,32	19,32	-	1965	2260
		0560				7	2800	560	2540	1296	1,26	79,80	22,68	-	2196	2525
		0640				8	2800	640	2929	1494	1,27	91,00	26,04	-	2430	2795
		0720				9	2800	720	3357	1713	1,28	102,48	29,40	-	2665	3065
		0800				10	2800	800	3710	1893	1,28	113,96	31,92	-	2900	3335
		0880				11	2800	880	4063	2073	1,29	125,16	34,72	-	3133	3603
11384	3000	0240	XXXX	YYYY	-0000	3	3000	240	1308	667	1,23	36,60	10,20	-	1331	1531
		0320				4	3000	320	1635	834	1,22	48,90	13,50	-	1580	1817
		0400				5	3000	400	1974	1007	1,23	60,90	17,10	-	1827	2101
		0480				6	3000	480	2334	1191	1,25	73,20	20,70	-	2077	2389
		0560				7	3000	560	2721	1388	1,26	85,50	24,30	-	2327	2676
		0640				8	3000	640	3138	1601	1,27	97,50	27,90	-	2573	2959
		0720				9	3000	720	3597	1835	1,28	109,80	31,50	-	2822	3245
		0800				10	3000	800	3975	2028	1,28	122,10	34,20	-	3072	3533
		0880				11	3000	880	4353	2221	1,29	134,10	37,20	-	3320	3818

In conformity with EN442-1: 2014: radiators and convectors

For heat outputs in other regimes, see p. 320 (correction factors)
EXPORT. Prices in Euro (excl. VAT)

VIOLA-A HORIZONTAL (H2L1-RO-A)



H2L1-RO-A
(thermostatic head to be ordered separately)

HOW TO ORDER VIOLA-A HORIZONTAL

Delivery time 15 - 30 working days
(transport duration not included)

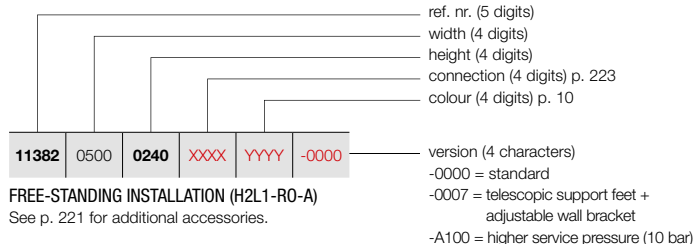

FREE-STANDING INSTALLATION (H2L1-RO-A)

See p. 221 for additional accessories.

PRICE GROUP: VPG2 - STEEL DESIGN RADIATORS

REFERENCE CODE CUSTOM MADE VIOLA-A HORIZONTAL							TECHNICAL DATA					STANDARD COLOUR	OTHER COLOURS			
tubes	width (L mm)	height (H mm)	75/65/20 (Watt) (Φ50K)	55/45/20 (Watt) (Φ30K)	n-exp.	weight (kg)	water content (l)	electr. resistance (Watt)	price RAL 9016 (€)	price colour (€)						
REF. NR. VIOLA-A HORIZONTAL H2L1-RO-A : 11382																
11382	0500	0240	XXXX	YYYY	-0000	3	500	240	322	164	1,28	7,75	1,70	-	518	596
		0320				4	500	320	399	204	1,30	10,35	2,25	-	598	688
		0400				5	500	400	474	242	1,32	12,90	2,85	-	681	783
		0480				6	500	480	550	280	1,34	15,50	3,45	-	764	879
		0560				7	500	560	625	319	1,36	18,10	4,05	-	849	976
		0640				8	500	640	677	345	1,36	20,65	4,65	-	929	1068
		0720				9	500	720	728	371	1,36	23,25	5,25	-	1011	1163
		0800				10	500	800	780	398	1,37	25,80	5,70	-	1094	1258
		0880				11	500	880	822	419	1,36	27,85	6,20	-	1178	1355
11382	0600	0240	XXXX	YYYY	-0000	3	600	240	386	197	1,28	9,30	2,04	-	556	639
		0320				4	600	320	479	244	1,30	12,42	2,70	-	646	743
		0400				5	600	400	569	290	1,32	15,48	3,42	-	740	851
		0480				6	600	480	659	336	1,34	18,60	4,14	-	832	957
		0560				7	600	560	749	382	1,36	21,72	4,86	-	922	1060
		0640				8	600	640	812	414	1,36	24,78	5,58	-	1012	1164
		0720				9	600	720	874	446	1,36	27,90	6,30	-	1106	1272
		0800				10	600	800	936	478	1,37	30,96	6,84	-	1197	1377
		0880				11	600	880	986	503	1,36	33,42	7,44	-	1288	1481
11382	0700	0240	XXXX	YYYY	-0000	3	700	240	450	230	1,28	10,85	2,38	-	597	687
		0320				4	700	320	559	285	1,30	14,49	3,15	-	697	802
		0400				5	700	400	664	339	1,32	18,06	3,99	-	798	918
		0480				6	700	480	769	393	1,34	21,70	4,83	-	899	1034
		0560				7	700	560	874	446	1,36	25,34	5,67	-	997	1147
		0640				8	700	640	947	483	1,36	28,91	6,51	-	1096	1260
		0720				9	700	720	1019	520	1,36	32,55	7,35	-	1198	1378
		0800				10	700	800	1092	557	1,37	36,12	7,98	-	1298	1493
		0880				11	700	880	1151	587	1,36	38,99	8,68	-	1399	1609
11382	0800	0240	XXXX	YYYY	-0000	3	800	240	514	262	1,28	12,40	2,72	-	637	733
		0320				4	800	320	638	326	1,30	16,56	3,60	-	747	859
		0400				5	800	400	758	387	1,32	20,64	4,56	-	855	983
		0480				6	800	480	879	449	1,34	24,80	5,52	-	962	1106
		0560				7	800	560	999	510	1,36	28,96	6,48	-	1074	1235
		0640				8	800	640	1082	552	1,36	33,04	7,44	-	1183	1360
		0720				9	800	720	1165	594	1,36	37,20	8,40	-	1293	1487
		0800				10	800	800	1248	637	1,37	41,28	9,12	-	1400	1610
		0880				11	800	880	1315	671	1,36	44,56	9,92	-	1510	1737
11382	0900	0240	XXXX	YYYY	-0000	3	900	240	579	295	1,28	13,95	3,06	-	677	779
		0320				4	900	320	718	366	1,30	18,63	4,05	-	794	913
		0400				5	900	400	853	435	1,32	23,22	5,13	-	915	1052
		0480				6	900	480	989	505	1,34	27,90	6,21	-	1030	1185
		0560				7	900	560	1124	574	1,36	32,58	7,29	-	1150	1323
		0640				8	900	640	1218	621	1,36	37,17	8,37	-	1267	1457
		0720				9	900	720	1310	669	1,36	41,85	9,45	-	1385	1593
		0800				10	900	800	1404	716	1,37	46,44	10,26	-	1500	1725
		0880				11	900	880	1480	755	1,36	50,13	11,16	-	1618	1861

In conformity with EN442-1: 2014: radiators and convectors

For heat outputs in other regimes, see p. 320 (correction factors)
EXPORT. Prices in Euro (excl. VAT)

HOW TO ORDER VIOLA-A HORIZONTAL

Delivery time 15 - 30 working days
(transport duration not included)

VIOLA-A HORIZONTAL (H2L1-RO-A)

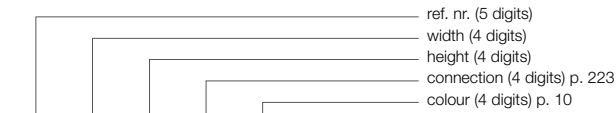

11382	1000	0240	XXXX	YYYY	-0000
-------	------	------	------	------	-------

- ref. nr. (5 digits)
- width (4 digits)
- height (4 digits)
- connection (4 digits) p. 223
- colour (4 digits) p. 10
- version (4 characters)
- 0000 = standard
- 0007 = telescopic support feet + adjustable wall bracket
- A100 = higher service pressure (10 bar)

FREE-STANDING INSTALLATION (H2L1-RO-A)
See p. 221 for additional accessories.



H2L1-RO-A
(thermostatic head to be ordered separately)

PRICE GROUP: VPG2 - STEEL DESIGN RADIATORS

REFERENCE CODE CUSTOM MADE VIOLA-A HORIZONTAL						TECHNICAL DATA						STANDARD COLOUR	OTHER COLOURS						
						tubes	width (L mm)	height (H mm)	75/65/20 (Watt) (φ50K)	55/45/20 (Watt) (φ30K)	n-exp.	weight (kg)	water content (l)	electr. resistance (Watt)	price RAL 9016 (€)	price colour (€)			
REF. NR. VIOLA-A HORIZONTAL H2L1-RO-A : 11382																			
11382	1000	0240	XXXX	YYYY	-0000	3	1000	240	643	328	1,28	15,50	3,40	-	717	825			
		0320				4	1000	320	798	407	1,30	20,70	4,50	-	847	974			
		0400				5	1000	400	948	484	1,32	25,80	5,70	-	973	1119			
		0480				6	1000	480	1099	561	1,34	31,00	6,90	-	1096	1260			
		0560				7	1000	560	1249	637	1,36	36,20	8,10	-	1224	1408			
		0640				8	1000	640	1353	690	1,36	41,30	9,30	-	1350	1553			
		0720				9	1000	720	1456	743	1,36	46,50	10,50	-	1476	1697			
		0800				10	1000	800	1560	796	1,37	51,60	11,40	-	1602	1842			
		0880				11	1000	880	1644	839	1,36	55,70	12,40	-	1731	1991			
		11382				1100	0240	XXXX	YYYY	-0000	3	1100	240	707	361	1,28	17,05	3,74	-
0320	4		1100	320	878		448				1,30	22,77	4,95	-	894	1028			
0400	5		1100	400	1043		532				1,32	28,38	6,27	-	1029	1183			
0480	6		1100	480	1209		617				1,34	34,10	7,59	-	1165	1340			
0560	7		1100	560	1374		701				1,36	39,82	8,91	-	1299	1494			
0640	8		1100	640	1488		759				1,36	45,43	10,23	-	1435	1650			
0720	9		1100	720	1602		817				1,36	51,15	11,55	-	1569	1804			
0800	10		1100	800	1716		876				1,37	56,76	12,54	-	1705	1961			
0880	11		1100	880	1808		923				1,36	61,27	13,64	-	1840	2116			
11382	1200		0240	XXXX	YYYY		-0000				3	1200	240	772	394	1,28	18,60	4,08	-
		0320	4			1200		320	958	489	1,30	24,84	5,40	-	942	1083			
		0400	5			1200		400	1138	580	1,32	30,96	6,84	-	1084	1247			
		0480	6			1200		480	1319	673	1,34	37,20	8,28	-	1230	1415			
		0560	7			1200		560	1499	765	1,36	43,44	9,72	-	1375	1581			
		0640	8			1200		640	1624	828	1,36	49,56	11,16	-	1520	1748			
		0720	9			1200		720	1747	891	1,36	55,80	12,60	-	1662	1911			
		0800	10			1200		800	1872	955	1,37	61,92	13,68	-	1809	2080			
		0880	11			1200		880	1973	1007	1,36	66,84	14,88	-	1952	2245			
		11382	1400			0240		XXXX	YYYY	-0000	3	1400	240	900	459	1,28	21,70	4,76	-
0320	4			1400	320	1117	570				1,30	28,98	6,30	-	1043	1199			
0400	5			1400	400	1327	677				1,32	36,12	7,98	-	1204	1385			
0480	6			1400	480	1539	785				1,34	43,40	9,66	-	1366	1571			
0560	7			1400	560	1749	892				1,36	50,68	11,34	-	1527	1756			
0640	8			1400	640	1894	966				1,36	57,82	13,02	-	1688	1941			
0720	9			1400	720	2038	1040				1,36	65,10	14,70	-	1850	2128			
0800	10			1400	800	2184	1114				1,37	72,24	15,96	-	2012	2314			
0880	11			1400	880	2302	1174				1,36	77,98	17,36	-	2174	2500			
11382	1600			0240	XXXX	YYYY	-0000				3	1600	240	1029	525	1,28	24,80	5,44	-
		0320	4	1600				320	1277	651	1,30	33,12	7,20	-	1139	1310			
		0400	5	1600				400	1517	774	1,32	41,28	9,12	-	1318	1516			
		0480	6	1600				480	1758	897	1,34	49,60	11,04	-	1497	1722			
		0560	7	1600				560	1998	1020	1,36	57,92	12,96	-	1679	1931			
		0640	8	1600				640	2165	1104	1,36	66,08	14,88	-	1857	2136			
		0720	9	1600				720	2330	1189	1,36	74,40	16,80	-	2036	2341			
		0800	10	1600				800	2496	1273	1,37	82,56	18,24	-	2217	2550			
		0880	11	1600				880	2630	1342	1,36	89,12	19,84	-	2393	2752			

In conformity with EN442-1: 2014: radiators and convectors

For heat outputs in other regimes, see p. 320 (correction factors)
EXPORT. Prices in Euro (excl. VAT)

VASCO

VIOLA-A HORIZONTAL (H2L1-RO-A)



H2L1-RO-A
(thermostatic head to be ordered separately)

HOW TO ORDER VIOLA-A HORIZONTAL

Delivery time 15 - 30 working days
(transport duration not included)

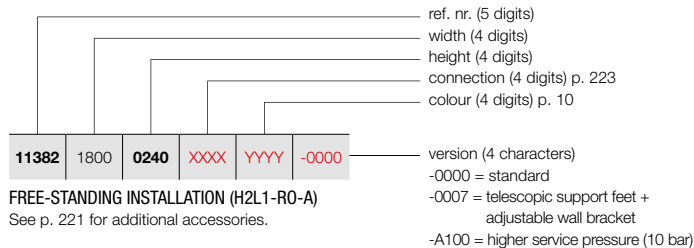

FREE-STANDING INSTALLATION (H2L1-RO-A)
See p. 221 for additional accessories.

PRICE GROUP: VPG2 - STEEL DESIGN RADIATORS

REFERENCE CODE CUSTOM MADE VIOLA-A HORIZONTAL							TECHNICAL DATA					STANDARD COLOUR	OTHER COLOURS			
tubes	width (L mm)	height (H mm)	75/65/20 (Watt) (Φ50K)	55/45/20 (Watt) (Φ30K)	n-exp.	weight (kg)	water content (l)	electr. resistance (Watt)	price RAL 9016 (€)	price colour (€)						
REF. NR. VIOLA-A HORIZONTAL H2L1-RO-A : 11382																
11382	1800	0240	XXXX	YYYY	-0000	3	1800	240	1157	591	1,28	27,90	6,12	-	1043	1199
		0320				4	1800	320	1436	733	1,30	37,26	8,10	-	1238	1424
		0400				5	1800	400	1706	871	1,32	46,44	10,26	-	1435	1650
		0480				6	1800	480	1978	1009	1,34	55,80	12,42	-	1633	1878
		0560				7	1800	560	2248	1147	1,36	65,16	14,58	-	1827	2101
		0640				8	1800	640	2435	1243	1,36	74,34	16,74	-	2025	2329
		0720				9	1800	720	2621	1337	1,36	83,70	18,90	-	2222	2555
		0800				10	1800	800	2808	1433	1,37	92,88	20,52	-	2419	2782
		0880				11	1800	880	2959	1510	1,36	100,26	22,32	-	2614	3006
11382	2000	0240	XXXX	YYYY	-0000	3	2000	240	1286	656	1,28	31,00	6,80	-	1121	1289
		0320				4	2000	320	1596	814	1,30	41,40	9,00	-	1337	1538
		0400				5	2000	400	1896	967	1,32	51,60	11,40	-	1550	1783
		0480				6	2000	480	2198	1121	1,34	62,00	13,80	-	1763	2027
		0560				7	2000	560	2498	1274	1,36	72,40	16,20	-	1979	2276
		0640				8	2000	640	2706	1381	1,36	82,60	18,60	-	2192	2521
		0720				9	2000	720	2912	1486	1,36	93,00	21,00	-	2407	2768
		0800				10	2000	800	3120	1592	1,37	103,20	22,80	-	2620	3013
		0880				11	2000	880	3288	1678	1,36	111,40	24,80	-	2835	3260
11382	2200	0240	XXXX	YYYY	-0000	3	2200	240	1415	722	1,28	34,10	7,48	-	1204	1385
		0320				4	2200	320	1756	896	1,30	45,54	9,90	-	1435	1650
		0400				5	2200	400	2086	1064	1,32	56,76	12,54	-	1665	1915
		0480				6	2200	480	2418	1234	1,34	68,20	15,18	-	1900	2185
		0560				7	2200	560	2748	1402	1,36	79,64	17,82	-	2130	2450
		0640				8	2200	640	2977	1519	1,36	90,86	20,46	-	2359	2713
		0720				9	2200	720	3203	1634	1,36	102,30	23,10	-	2596	2985
		0800				10	2200	800	3432	1751	1,37	113,52	25,08	-	2824	3248
		0880				11	2200	880	3617	1845	1,36	122,54	27,28	-	3055	3513
11382	2400	0240	XXXX	YYYY	-0000	3	2400	240	1543	787	1,28	37,20	8,16	-	1282	1474
		0320				4	2400	320	1915	977	1,30	49,68	10,80	-	1533	1763
		0400				5	2400	400	2275	1161	1,32	61,92	13,68	-	1783	2050
		0480				6	2400	480	2638	1346	1,34	74,40	16,56	-	2031	2336
		0560				7	2400	560	2998	1529	1,36	86,88	19,44	-	2281	2623
		0640				8	2400	640	3247	1657	1,36	99,12	22,32	-	2530	2910
		0720				9	2400	720	3494	1783	1,36	111,60	25,20	-	2781	3198
		0800				10	2400	800	3744	1910	1,37	123,84	27,36	-	3029	3483
		0880				11	2400	880	3946	2013	1,36	133,68	29,76	-	3279	3771
11382	2600	0240	XXXX	YYYY	-0000	3	2600	240	1672	853	1,28	40,30	8,84	-	1366	1571
		0320				4	2600	320	2075	1059	1,30	53,82	11,70	-	1631	1876
		0400				5	2600	400	2465	1258	1,32	67,08	14,82	-	1900	2185
		0480				6	2600	480	2857	1458	1,34	80,60	17,94	-	2164	2489
		0560				7	2600	560	3247	1657	1,36	94,12	21,06	-	2430	2795
		0640				8	2600	640	3518	1795	1,36	107,38	24,18	-	2701	3106
		0720				9	2600	720	3786	1931	1,36	120,90	27,30	-	2966	3411
		0800				10	2600	800	4056	2069	1,37	134,16	29,64	-	3235	3720
		0880				11	2600	880	4274	2181	1,36	144,82	32,24	-	3500	4025

In conformity with EN442-1: 2014: radiators and convectors

For heat outputs in other regimes, see p. 320 (correction factors)
EXPORT. Prices in Euro (excl. VAT)

HOW TO ORDER VIOLA-A HORIZONTAL

Delivery time 15 - 30 working days
(transport duration not included)

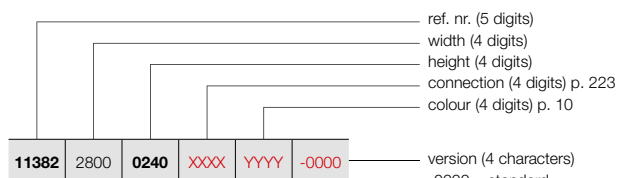

ref. nr. (5 digits)
width (4 digits)
height (4 digits)
connection (4 digits) p. 223
colour (4 digits) p. 10

11382 | 2800 | **0240** | **XXXX** | **YYYY** | **-0000**

version (4 characters)

-0000 = standard
-0007 = telescopic support feet + adjustable wall bracket
-A100 = higher service pressure (10 bar)

FREE-STANDING INSTALLATION (H2L1-RO-A)

See p. 221 for additional accessories.

VIOLA-A HORIZONTAL (H2L1-RO-A)



H2L1-RO-A
(thermostatic head to be ordered separately)

PRICE GROUP: VPG2 - STEEL DESIGN RADIATORS

REFERENCE CODE CUSTOM MADE VIOLA-A HORIZONTAL	TECHNICAL DATA									STANDARD COLOUR	OTHER COLOURS					
	tubes	width (L mm)	height (H mm)	75/65/20 (Watt) (Φ50K)	55/45/20 (Watt) (Φ30K)	n-exp.	weight (kg)	water content (l)	electr. resistance (Watt)	price RAL 9016 (€)	price colour (€)					
REF. NR. VIOLA-A HORIZONTAL H2L1-RO-A : 11382																
11382	2800	0240	XXXX	YYYY	-0000	3	2800	240	1800	919	1,28	43,40	9,52	-	1445	1662
		0320				4	2800	320	2234	1140	1,30	57,96	12,60	-	1729	1988
		0400				5	2800	400	2654	1354	1,32	72,24	15,96	-	2013	2315
		0480				6	2800	480	3077	1570	1,34	86,80	19,32	-	2298	2643
		0560				7	2800	560	3497	1784	1,36	101,36	22,68	-	2581	2968
		0640				8	2800	640	3788	1933	1,36	115,64	26,04	-	2867	3297
		0720				9	2800	720	4077	2080	1,36	130,20	29,40	-	3153	3626
		0800				10	2800	800	4368	2229	1,37	144,48	31,92	-	3435	3950
		0880				11	2800	880	4603	2349	1,36	155,96	34,72	-	3720	4278
11382	3000	0240	XXXX	YYYY	-0000	3	3000	240	1929	984	1,28	46,50	10,20	-	1526	1755
		0320				4	3000	320	2394	1221	1,30	62,10	13,50	-	1827	2101
		0400				5	3000	400	2844	1451	1,32	77,40	17,10	-	2130	2450
		0480				6	3000	480	3297	1682	1,34	93,00	20,70	-	2430	2795
		0560				7	3000	560	3747	1912	1,36	108,60	24,30	-	2731	3141
		0640				8	3000	640	4059	2071	1,36	123,90	27,90	-	3036	3491
		0720				9	3000	720	4368	2229	1,36	139,50	31,50	-	3338	3839
		0800				10	3000	800	4680	2388	1,37	154,80	34,20	-	3641	4187
		0880				11	3000	880	4932	2516	1,36	167,10	37,20	-	3942	4533

In conformity with EN442-1: 2014: radiators and convectors

For heat outputs in other regimes, see p. 320 (correction factors)
EXPORT. Prices in Euro (excl. VAT)

VIOLA-A HORIZONTAL (H2L2-RO-A)

HOW TO ORDER VIOLA-A HORIZONTAL

Delivery time 15 - 30 working days
(transport duration not included)



H2L2-RO-A
(thermostatic head to be ordered separately)

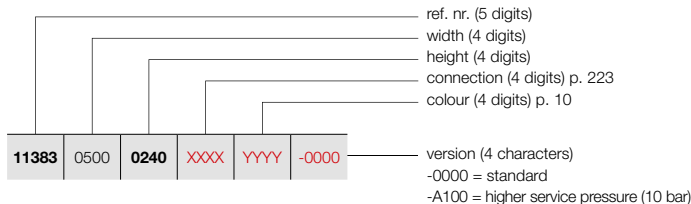

PRICE GROUP: VPG2 - STEEL DESIGN RADIATORS

REFERENCE CODE CUSTOM MADE VIOLA-A HORIZONTAL							TECHNICAL DATA				STANDARD COLOUR	OTHER COLOURS				
tubes	width (L mm)	height (H mm)	75/65/20 (Watt) (Φ50K)	55/45/20 (Watt) (Φ30K)	n-exp.	weight (kg)	water content (l)	electr. resistance (Watt)	price RAL 9016 (€)	price colour (€)						
REF. NR. VIOLA-A HORIZONTAL H2L2-RO-A : 11383																
11383	0500	0240	XXXX	YYYY	-0000	3	500	240	433	221	1,25	9,70	2,00	-	559	643
		0320				4	500	320	538	274	1,30	12,90	2,75	-	652	750
		0400				5	500	400	663	338	1,31	16,10	3,45	-	745	857
		0480				6	500	480	788	402	1,33	19,40	4,15	-	837	963
		0560				7	500	560	913	466	1,34	22,60	4,85	-	931	1071
		0640				8	500	640	993	507	1,34	25,85	5,50	-	1023	1176
		0720				9	500	720	1073	547	1,34	29,10	6,20	-	1119	1287
		0800				10	500	800	1153	588	1,36	32,30	6,90	-	1213	1395
		0880				11	500	880	1204	614	1,36	34,45	7,60	-	1304	1500
11383	0600	0240	XXXX	YYYY	-0000	3	600	240	519	265	1,25	11,64	2,40	-	607	698
		0320				4	600	320	645	329	1,30	15,48	3,30	-	710	817
		0400				5	600	400	796	406	1,31	19,32	4,14	-	816	938
		0480				6	600	480	946	482	1,33	23,28	4,98	-	921	1059
		0560				7	600	560	1096	559	1,34	27,12	5,82	-	1023	1176
		0640				8	600	640	1192	608	1,34	31,02	6,60	-	1128	1297
		0720				9	600	720	1287	657	1,34	34,92	7,44	-	1230	1415
		0800				10	600	800	1383	706	1,36	38,76	8,28	-	1337	1538
		0880				11	600	880	1445	737	1,36	41,34	9,12	-	1442	1658
11383	0700	0240	XXXX	YYYY	-0000	3	700	240	606	309	1,25	13,58	2,80	-	657	756
		0320				4	700	320	753	384	1,30	18,06	3,85	-	773	889
		0400				5	700	400	928	474	1,31	22,54	4,83	-	888	1021
		0480				6	700	480	1103	563	1,33	27,16	5,81	-	1001	1151
		0560				7	700	560	1278	652	1,34	31,64	6,79	-	1118	1286
		0640				8	700	640	1390	709	1,34	36,19	7,70	-	1230	1415
		0720				9	700	720	1502	766	1,34	40,74	8,68	-	1346	1548
		0800				10	700	800	1614	823	1,36	45,22	9,66	-	1460	1679
		0880				11	700	880	1686	860	1,36	48,23	10,64	-	1577	1814
11383	0800	0240	XXXX	YYYY	-0000	3	800	240	692	353	1,25	15,52	3,20	-	704	810
		0320				4	800	320	860	439	1,30	20,64	4,40	-	832	957
		0400				5	800	400	1061	541	1,31	25,76	5,52	-	958	1102
		0480				6	800	480	1261	643	1,33	31,04	6,64	-	1082	1244
		0560				7	800	560	1461	745	1,34	36,16	7,76	-	1211	1393
		0640				8	800	640	1589	811	1,34	41,36	8,80	-	1336	1536
		0720				9	800	720	1716	876	1,34	46,56	9,92	-	1460	1679
		0800				10	800	800	1844	941	1,36	51,68	11,04	-	1587	1825
		0880				11	800	880	1926	983	1,36	55,12	12,16	-	1714	1971
11383	0900	0240	XXXX	YYYY	-0000	3	900	240	779	397	1,25	17,46	3,60	-	755	868
		0320				4	900	320	968	494	1,30	23,22	4,95	-	891	1025
		0400				5	900	400	1193	609	1,31	28,98	6,21	-	1027	1181
		0480				6	900	480	1418	724	1,33	34,92	7,47	-	1165	1340
		0560				7	900	560	1643	838	1,34	40,68	8,73	-	1300	1495
		0640				8	900	640	1787	912	1,34	46,53	9,90	-	1439	1655
		0720				9	900	720	1931	985	1,34	52,38	11,16	-	1575	1811
		0800				10	900	800	2075	1058	1,36	58,14	12,42	-	1714	1971
		0880				11	900	880	2167	1106	1,36	62,01	13,68	-	1850	2128

In conformity with EN442-1: 2014: radiators and convectors

For heat outputs in other regimes, see p. 320 (correction factors)
EXPORT. Prices in Euro (excl. VAT)

HOW TO ORDER VIOLA-A HORIZONTAL

Delivery time 15 - 30 working days
(transport duration not included)

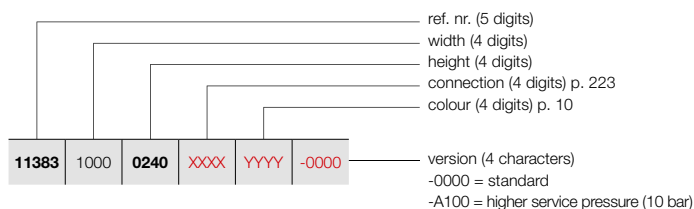

VIOLA-A HORIZONTAL (H2L2-RO-A)

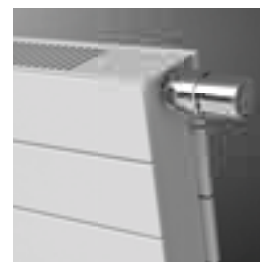

H2L2-RO-A
(thermostatic head to be ordered separately)

PRICE GROUP: VPG2 - STEEL DESIGN RADIATORS

REFERENCE CODE CUSTOM MADE VIOLA-A HORIZONTAL	TECHNICAL DATA									STANDARD COLOUR	OTHER COLOURS		
	tubes	width (L mm)	height (H mm)	75/65/20 (Watt) (φ50K)	55/45/20 (Watt) (φ30K)	n-exp.	weight (kg)	water content (l)	electr. resistance (Watt)	price RAL 9016 (€)	price colour (€)		
REF. NR. VIOLA-A HORIZONTAL H2L2-RO-A : 11383													
11383 1000 0240 XXXX YYYY -0000	0320	3	1000	240	865	441	1,25	19,40	4,00	-	802	922	
	0400	4	1000	320	1075	548	1,30	25,80	5,50	-	953	1096	
	0480	5	1000	400	1326	677	1,31	32,20	6,90	-	1096	1260	
	0560	6	1000	480	1576	804	1,33	38,80	8,30	-	1244	1431	
	0640	7	1000	560	1826	932	1,34	45,20	9,70	-	1393	1602	
	0720	8	1000	640	1986	1013	1,34	51,70	11,00	-	1541	1772	
	0800	9	1000	720	2145	1094	1,34	58,20	12,40	-	1689	1942	
	0880	10	1000	800	2305	1176	1,36	64,60	13,80	-	1836	2111	
			11	1000	880	2408	1229	1,36	68,90	15,20	-	1983	2280
	11383 1100 0240 XXXX YYYY -0000	0320	3	1100	240	952	485	1,25	21,34	4,40	-	852	980
		0400	4	1100	320	1183	603	1,30	28,38	6,05	-	1009	1160
0480		5	1100	400	1459	744	1,31	35,42	7,59	-	1169	1344	
0560		6	1100	480	1734	884	1,33	42,68	9,13	-	1327	1526	
0640		7	1100	560	2009	1025	1,34	49,72	10,67	-	1488	1711	
0720		8	1100	640	2185	1115	1,34	56,87	12,10	-	1646	1893	
0800		9	1100	720	2360	1204	1,34	64,02	13,64	-	1803	2073	
0880		10	1100	800	2536	1294	1,36	71,06	15,18	-	1963	2257	
			11	1100	880	2649	1351	1,36	75,79	16,72	-	2120	2438
11383 1200 0240 XXXX YYYY -0000		0320	3	1200	240	1038	530	1,25	23,28	4,80	-	902	1037
		0400	4	1200	320	1290	658	1,30	30,96	6,60	-	1070	1231
	0480	5	1200	400	1591	812	1,31	38,64	8,28	-	1239	1425	
	0560	6	1200	480	1891	965	1,33	46,56	9,96	-	1409	1620	
	0640	7	1200	560	2191	1118	1,34	54,24	11,64	-	1578	1815	
	0720	8	1200	640	2383	1216	1,34	62,04	13,20	-	1750	2013	
	0800	9	1200	720	2574	1313	1,34	69,84	14,88	-	1918	2206	
	0880	10	1200	800	2766	1411	1,36	77,52	16,56	-	2084	2397	
			11	1200	880	2890	1474	1,36	82,68	18,24	-	2256	2594
	11383 1400 0240 XXXX YYYY -0000	0320	3	1400	240	1211	618	1,25	27,16	5,60	-	998	1148
		0400	4	1400	320	1505	768	1,30	36,12	7,70	-	1190	1369
0480		5	1400	400	1856	947	1,31	45,08	9,66	-	1381	1588	
0560		6	1400	480	2206	1126	1,33	54,32	11,62	-	1571	1807	
0640		7	1400	560	2556	1304	1,34	63,28	13,58	-	1761	2025	
0720		8	1400	640	2780	1419	1,34	72,38	15,40	-	1955	2248	
0800		9	1400	720	3003	1532	1,34	81,48	17,36	-	2146	2468	
0880		10	1400	800	3227	1646	1,36	90,44	19,32	-	2336	2686	
			11	1400	880	3371	1720	1,36	96,46	21,28	-	2528	2907
11383 1600 0240 XXXX YYYY -0000		0320	3	1600	240	1384	706	1,25	31,04	6,40	-	1095	1259
		0400	4	1600	320	1720	878	1,30	41,28	8,80	-	1311	1508
	0480	5	1600	400	2122	1082	1,31	51,52	11,04	-	1523	1751	
	0560	6	1600	480	2522	1287	1,33	62,08	13,28	-	1737	1998	
	0640	7	1600	560	2922	1491	1,34	72,32	15,52	-	1948	2240	
	0720	8	1600	640	3178	1621	1,34	82,72	17,60	-	2160	2484	
	0800	9	1600	720	3432	1751	1,34	93,12	19,84	-	2375	2731	
	0880	10	1600	800	3688	1882	1,36	103,36	22,08	-	2587	2975	
			11	1600	880	3853	1966	1,36	110,24	24,32	-	2800	3220

In conformity with EN442-1: 2014: radiators and convectors

For heat outputs in other regimes, see p. 320 (correction factors)
EXPORT. Prices in Euro (excl. VAT)

VASCO

VIOLA-A HORIZONTAL (H2L2-RO-A)

HOW TO ORDER VIOLA-A HORIZONTAL

Delivery time 15 - 30 working days
(transport duration not included)



H2L2-RO-A
(thermostatic head to be ordered separately)

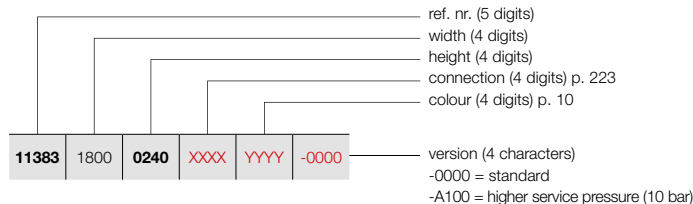

PRICE GROUP: VPG2 - STEEL DESIGN RADIATORS

REFERENCE CODE CUSTOM MADE VIOLA-A HORIZONTAL							TECHNICAL DATA					STANDARD COLOUR	OTHER COLOURS			
tubes	width (L mm)	height (H mm)	75/65/20 (Watt) (Φ50K)	55/45/20 (Watt) (Φ30K)	n-exp.	weight (kg)	water content (l)	electr. resistance (Watt)	price RAL 9016 (€)	price colour (€)						
REF. NR. VIOLA-A HORIZONTAL H2L2-RO-A : 11383																
11383	1800	0240	XXXX	YYYY	-0000	3	1800	240	1557	794	1,25	34,92	7,20	-	1192	1371
		0320				4	1800	320	1935	987	1,30	46,44	9,90	-	1427	1641
		0400				5	1800	400	2387	1218	1,31	57,96	12,42	-	1662	1911
		0480				6	1800	480	2837	1447	1,33	69,84	14,94	-	1900	2185
		0560				7	1800	560	3287	1677	1,34	81,36	17,46	-	2132	2452
		0640				8	1800	640	3575	1824	1,34	93,06	19,80	-	2368	2723
		0720				9	1800	720	3861	1970	1,34	104,76	22,32	-	2605	2996
		0800				10	1800	800	4149	2117	1,36	116,28	24,84	-	2837	3263
		0880				11	1800	880	4334	2211	1,36	124,02	27,36	-	3075	3536
11383	2000	0240	XXXX	YYYY	-0000	3	2000	240	1730	883	1,25	38,80	8,00	-	1293	1487
		0320				4	2000	320	2150	1097	1,30	51,60	11,00	-	1548	1780
		0400				5	2000	400	2652	1353	1,31	64,40	13,80	-	1804	2075
		0480				6	2000	480	3152	1608	1,33	77,60	16,60	-	2061	2370
		0560				7	2000	560	3652	1863	1,34	90,40	19,40	-	2320	2668
		0640				8	2000	640	3972	2027	1,34	103,40	22,00	-	2575	2961
		0720				9	2000	720	4290	2189	1,34	116,40	24,80	-	2831	3256
		0800				10	2000	800	4610	2352	1,36	129,20	27,60	-	3089	3552
		0880				11	2000	880	4816	2457	1,36	137,80	30,40	-	3345	3847
11383	2200	0240	XXXX	YYYY	-0000	3	2200	240	1903	971	1,25	42,68	8,80	-	1389	1597
		0320				4	2200	320	2365	1207	1,30	56,76	12,10	-	1666	1916
		0400				5	2200	400	2917	1488	1,31	70,84	15,18	-	1945	2237
		0480				6	2200	480	3467	1769	1,33	85,36	18,26	-	2225	2559
		0560				7	2200	560	4017	2050	1,34	99,44	21,34	-	2503	2878
		0640				8	2200	640	4369	2229	1,34	113,74	24,20	-	2782	3199
		0720				9	2200	720	4719	2408	1,34	128,04	27,28	-	3061	3520
		0800				10	2200	800	5071	2587	1,36	142,12	30,36	-	3339	3840
		0880				11	2200	880	5298	2703	1,36	151,58	33,44	-	3617	4160
11383	2400	0240	XXXX	YYYY	-0000	3	2400	240	2076	1059	1,25	46,56	9,60	-	1488	1711
		0320				4	2400	320	2580	1316	1,30	61,92	13,20	-	1788	2056
		0400				5	2400	400	3182	1624	1,31	77,28	16,56	-	2084	2397
		0480				6	2400	480	3782	1930	1,33	93,12	19,92	-	2389	2747
		0560				7	2400	560	4382	2236	1,34	108,48	23,28	-	2687	3090
		0640				8	2400	640	4766	2432	1,34	124,08	26,40	-	2987	3435
		0720				9	2400	720	5148	2627	1,34	139,68	29,76	-	3285	3778
		0800				10	2400	800	5532	2822	1,36	155,04	33,12	-	3586	4124
		0880				11	2400	880	5779	2949	1,36	165,36	36,48	-	3888	4471
11383	2600	0240	XXXX	YYYY	-0000	3	2600	240	2249	1147	1,25	50,44	10,40	-	1585	1823
		0320				4	2600	320	2795	1426	1,30	67,08	14,30	-	1907	2193
		0400				5	2600	400	3448	1759	1,31	83,72	17,94	-	2228	2562
		0480				6	2600	480	4098	2091	1,33	100,88	21,58	-	2551	2934
		0560				7	2600	560	4748	2422	1,34	117,52	25,22	-	2872	3303
		0640				8	2600	640	5164	2634	1,34	134,42	28,60	-	3194	3673
		0720				9	2600	720	5577	2845	1,34	151,32	32,24	-	3513	4040
		0800				10	2600	800	5993	3058	1,36	167,96	35,88	-	3839	4415
		0880				11	2600	880	6261	3194	1,36	179,14	39,52	-	4161	4785

In conformity with EN442-1: 2014: radiators and convectors

For heat outputs in other regimes, see p. 320 (correction factors)
EXPORT. Prices in Euro (excl. VAT)

HOW TO ORDER VIOLA-A HORIZONTAL

Delivery time 15 - 30 working days
(transport duration not included)

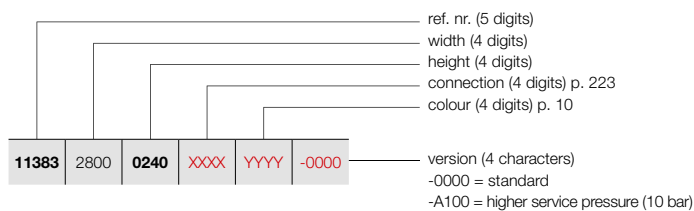

VIOLA-A HORIZONTAL (H2L2-RO-A)



H2L2-RO-A
(thermostatic head to be ordered separately)

PRICE GROUP: VPG2 - STEEL DESIGN RADIATORS

REFERENCE CODE CUSTOM MADE VIOLA-A HORIZONTAL	TECHNICAL DATA									STANDARD COLOUR	OTHER COLOURS
	tubes	width (L mm)	height (H mm)	75/65/20 (Watt) (Φ50K)	55/45/20 (Watt) (Φ30K)	n-exp.	weight (kg)	water content (l)	electr. resistance (Watt)	price RAL 9016 (€)	price colour (€)
REF. NR. VIOLA-A HORIZONTAL H2L2-RO-A : 11383											
11383 2800 0240 XXXX YYYY -0000	3	2800	240	2422	1236	1,25	54,32	11,20	-	1683	1935
	4	2800	320	3010	1536	1,30	72,24	15,40	-	2026	2330
	5	2800	400	3713	1894	1,31	90,16	19,32	-	2372	2728
	6	2800	480	4413	2251	1,33	108,64	23,24	-	2714	3121
	7	2800	560	5113	2609	1,34	126,56	27,16	-	3059	3518
	8	2800	640	5561	2837	1,34	144,76	30,80	-	3401	3911
	9	2800	720	6006	3064	1,34	162,96	34,72	-	3745	4307
	10	2800	800	6454	3293	1,36	180,88	38,64	-	4088	4701
11383 3000 0240 XXXX YYYY -0000	3	3000	240	2595	1324	1,25	58,20	12,00	-	1780	2047
	4	3000	320	3225	1645	1,30	77,40	16,50	-	2146	2468
	5	3000	400	3978	2030	1,31	96,60	20,70	-	2509	2885
	6	3000	480	4728	2412	1,33	116,40	24,90	-	2874	3305
	7	3000	560	5478	2795	1,34	135,60	29,10	-	3242	3728
	8	3000	640	5958	3040	1,34	155,10	33,00	-	3609	4150
	9	3000	720	6435	3283	1,34	174,60	37,20	-	3974	4570



In conformity with EN442-1: 2014: radiators and convectors

For heat outputs in other regimes, see p. 320 (correction factors)
EXPORT. Prices in Euro (excl. VAT)

VIOLA-A WALL BRACKETS





IN OPTION

PRICE GROUP: VPG10 - ACC.

WALL SETUP	WIDTH RADIATOR	COLOUR	REF. NR.	€
TELESCOPIC SUPPORT FEET + ADJUSTABLE WALL BRACKET 	V2-ZB-A			
	(2 feet)	RAL 9016	*	82
		COLOUR	*	94
	H2-RO-A, H2L1-RO-A			
	≤ 2000 mm (2 feet)	RAL 9016	*	82
		COLOUR	*	94
≥ 2200 mm (3 feet)	RAL 9016	*	125	
	COLOUR	*	144	
* Attention: Feet must be ordered at the same time as the radiator. Please indicate code -0007 for "Finish" when ordering.				
COVER ROSETTE FOOT SCREED 	V2-ZB-A			
		RAL 9016	11810390000	30
• 56 x 56 mm. Number of rosettes = number of feet				
COVER ROSETTE FOOT FINISHED FLOOR 	H2-RO-A, H2L1-RO-A			
		RAL 9016	11810400000	38
• 104 x 84 mm. Number of rosettes = number of feet				

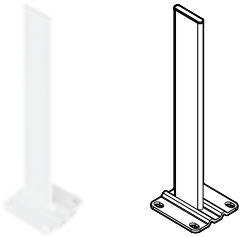
EXPORT. Prices in Euro (excl. VAT)

PRICE GROUP: VPG10 - ACC.



FREE-STANDING INSTALLATION	HEIGHT FOOT	COLOUR	REF. NR.	€
FOOT FREE-STANDING INSTALLATION 	H1-RO-A, H1L1-RO-A, H2-RO-A, H2L1-RO-A, H2L2-RO-A			
	H = 450 mm	RAL 9016	11810350450	61
		COLOUR	11810350450C	70
	H = 550 mm	RAL 9016	11810350550	61
		COLOUR	11810350550C	70
	H = 600 mm	RAL 9016	11810350600	61
		COLOUR	11810350600C	70
	H = 650 mm	RAL 9016	11810350650	61
		COLOUR	11810350650C	70
	H = 750 mm	RAL 9016	11810350750	61
		COLOUR	11810350750C	70
	H = 850 mm	RAL 9016	11810350850	75
		COLOUR	11810350850C	86
	H = 900 mm	RAL 9016	11810350900	75
	COLOUR	11810350900C	86	
H = 1050 mm	RAL 9016	11810351050	75	
	COLOUR	11810351050C	86	
H = 1200 mm	RAL 9016	11810351200	75	
	COLOUR	11810351200C	86	
<ul style="list-style-type: none"> Finished floor: height foot = height radiator + 150 mm Screed: height foot = height radiator + 300 mm Shorten yourself if necessary 				
BRACKET FOOT FREE-STANDING INSTALLATION 	H1-RO-A, H1L1-RO-A, H2-RO-A, H2L1-RO-A, H2L2-RO-A			
		RAL 9016	11810360000	49
	COLOUR	11810360000C	56	
COVER ROSETTE FOOT SCREED 	H1-RO-A, H1L1-RO-A, H2-RO-A, H2L1-RO-A, H2L2-RO-A			
		RAL 9016	11810370000	12
	COLOUR	11810370000C	14	
<ul style="list-style-type: none"> 100 x 40 mm. Number of rosettes = number of feet 				
COVER ROSETTE FOOT FINISHED FLOOR 	H1-RO-A, H1L1-RO-A, H2-RO-A, H2L1-RO-A, H2L2-RO-A			
		RAL 9016	11810380000	15
	COLOUR	11810380000C	17	
<ul style="list-style-type: none"> 115 x 110 mm. Number of rosettes = number of feet 				

height radiator (mm)	Length radiator (mm)	number of feet	number of brackets foot
240 - 880	500-2000	2x	2x
	2200-3000	3x	3x



EXPORT. Prices in Euro (excl. VAT)

VIOLA-A ACCESSORIES
IN OPTION

PRICE GROUP: VPG10 - ACC.

ACCESSORIES		COLOUR	REF. NR.	€
THERMOSTATIC HEAD		V1-ZB-A, V1L1-ZB-A, V2-ZB-A H1-RO-A, H1L1-RO-A, H2-RO-A, H2L1-RO-A, H2L2-RO-A		
		WHITE	11911630102	44
THERMOSTATIC HEAD		V1-ZB-A, V1L1-ZB-A, V2-ZB-A H1-RO-A, H1L1-RO-A, H2-RO-A, H2L1-RO-A, H2L2-RO-A		
		CHROME	11911631102	63

PRICE GROUP: VPG10B - TOWEL RAILS

ACCESSORIES	WIDTH TOWEL RAIL	COLOUR	REF. NR.	€	
HOOK		V1-ZB-A, V1L1-ZB-A, V2-ZB-A			
		CHROME	118341100000099	87	
TOWEL RAIL		V1-ZB-A, V1L1-ZB-A, V2-ZB-A H1-RO-A, H1L1-RO-A, H2-RO-A, H2L1-RO-A, H2L2-RO-A			
		500 mm	CHROME	118327000000099	145
		500 mm	RAL 9016	118327000009016	145
		500 mm	RAL 9005 ^{MB}	118327000009005	145

- h = 70 mm; b = 70 mm; d = 51 mm; a = 43 mm;

- h = 55 mm; b = 500 mm; d = 53 mm; a = 38 mm;

^{MB} matt black

Mounting instructions accessories: see www.vasco.eu
EXPORT. Prices in Euro (excl. VAT)

d = distance front of the accessory up to front of the radiator
a = distance accessory up to the radiator
available from stock

VIOLA-A VERTICAL: V1-ZB-A / V1L1-ZB-A / V2-ZB-A (STOCK)

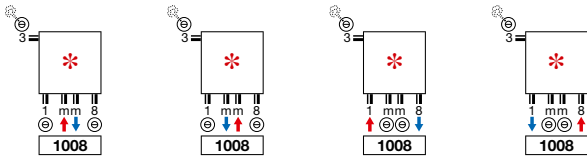

- * Inlet and outlet can be interchangeable
- Above connection for stock radiator with even number of tubes. Also available for non-stock radiators with even number of tubes.

VIOLA-A VERTICAL: V1-ZB-A / V1L1-ZB-A / V2-ZB-A (NON STOCK)

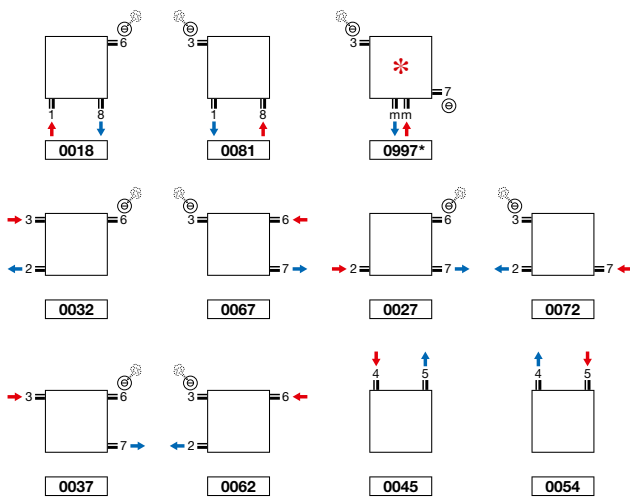

- * Inlet and outlet can be interchangeable
- Connection mm only possible with even number of tubes

VIOLA-A HORIZONTAL: H1-RO-A / H1L1-RO-A / H2-RO-A / H2L1-RO-A / H2L2-RO-A (NON STOCK)

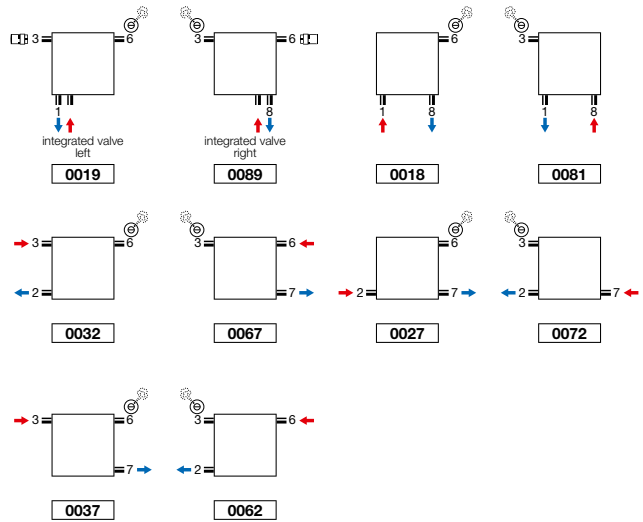

- Connection 0019 and 0089: thermostatic head to be ordered separately
- Integrated valve (extra charge) (see p. 314)

Attention: connecting the radiator can only be as shown by the connecting icons. For any other connection method, we take no responsibility.

VIOLA-A VERTICAL (V1-ZB-A, V1L1-ZB-A, V2-ZB-A)

V1-ZB-A

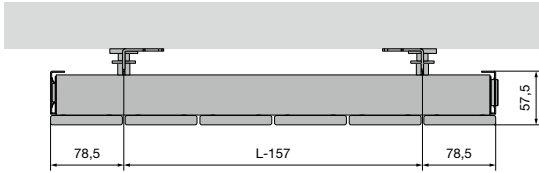

V1L1-ZB-A

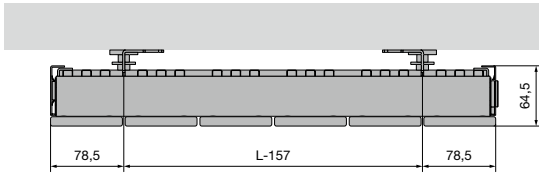

V2-ZB-A

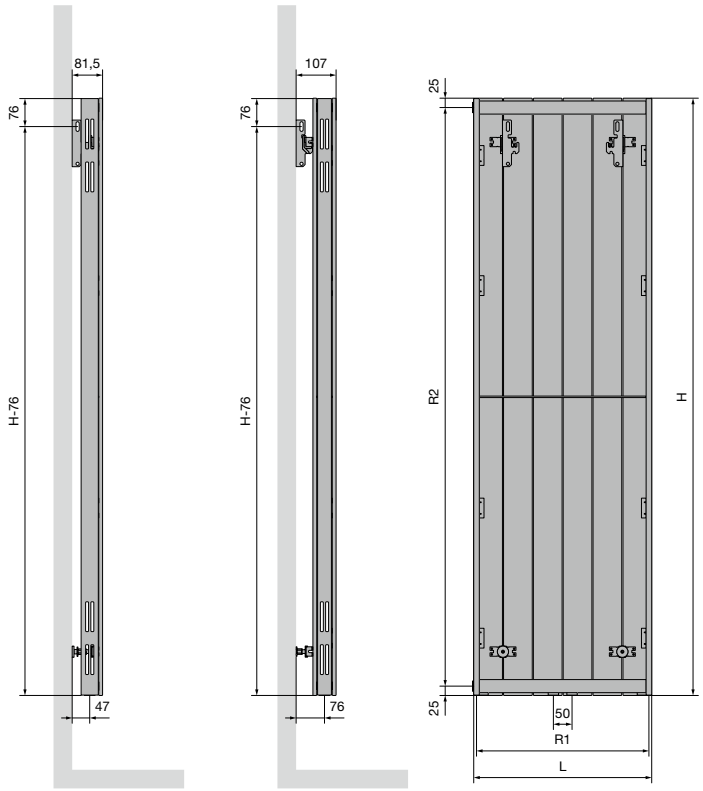
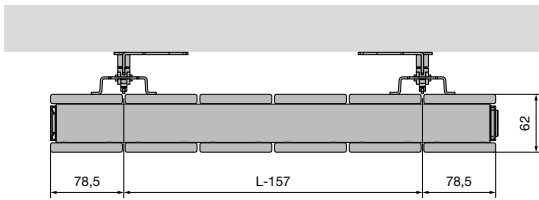

	V1-ZB-A / V1L1-ZB-A / V2-ZB-A											
Number of tubes	3	4	5	6	7	8	9	10	11	12	13	
Width (L)	237	317	397	477	557	637	717	797	877	957	1037	
Centre between the connections at the bottom 18 (R1)	187	267	347	427	507	587	667	747	827	907	987	
Height (H)	1200	1400	1600	1800	2000	2200	2400					
Centre between the lateral connections 23/67 (R2)	1150	1350	1550	1750	1950	2150	2350					
Centre between the brackets	L-157	H-76										

VIOLA-A HORIZONTAL (H1-RO-A, H1L1-RO-A, H2-RO-A, H2L1-RO-A, H2L2-RO-A)

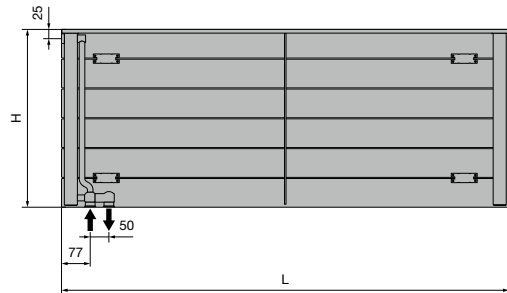
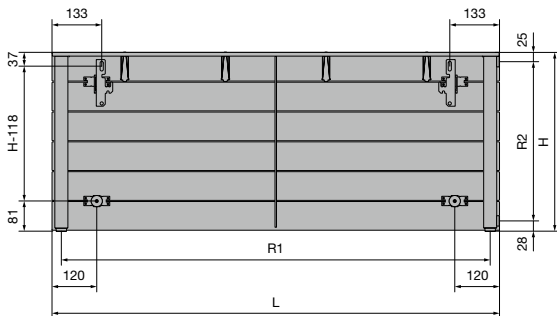
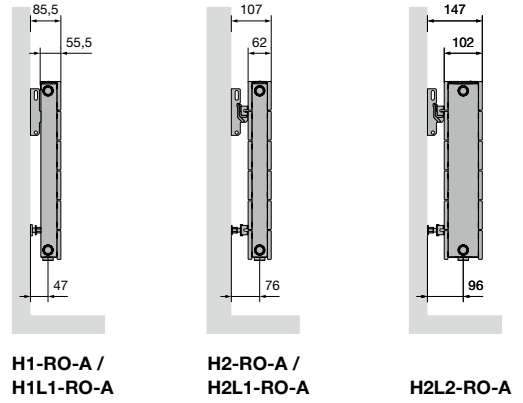
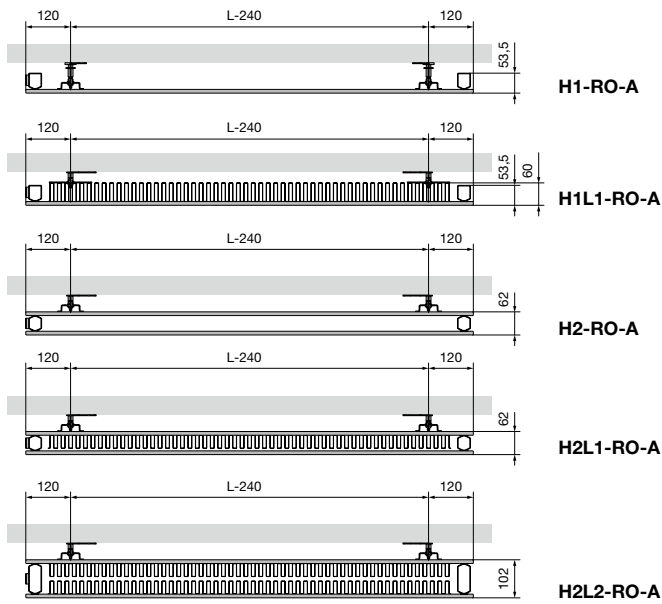

	H1-RO-A / H1L1-RO-A / H2-RO-A / H2L1-RO-A / H2L2-RO-A																
Width (L)	500	600	700	800	900	1000	1100	1200	1400	1600	1800	2000	2200	2400	2600	2800	3000
Centre between the connections at the bottom 18 (R1)	450	550	650	750	850	950	1050	1150	1350	1550	1750	1950	2150	2350	2550	2750	2950
Height (H)	240	320	400	480	560	640	720	800	880								
Centre between the lateral connections 23/67 (R2)	187	267	347	427	507	587	667	747	827								
Centre between the brackets	L-240	H-118															

TULIPA-A VERTICAL (TV1-A, TV2-A)



TYPES

- One (TV1-A) or two rows (TV2-A) of tubes

TUBES

- Vertical, flat-oval 60 x 10 mm

COLLECTORS

- Horizontal, rear, round Ø 32 mm

COLOURS

- Standard colour white RAL 9016
- Extensive colour chart see p. 10

SPECIAL

- Tulipa-A 6 and 8 tubes: connection 1mm8, 18, 81 not possible

BRACKETS

- Wall brackets standard (included in packaging of radiator)
- **TV1-A / TV2-A:** also available as free-standing radiator, see p. 240. Additional wall mounting support necessary for height radiator > 600 mm

TECHNICAL

- Welded by means of resistance welding robots (invisible weld seams)
- ATL priming coat, powder coating
- Standard operating pressure: 6 bar. Extra charge for higher service pressures (10 bar): +10%.
- The delivery time of a radiator with a higher service pressure is 1 week extra.
- Maximum operating temperature: 110°C

ELECTRICAL

- ✗ Pure electrical radiator prefilled
- ✗ Mixed radiator

TECHNICAL DRAWINGS

- See p. 243

CONNECTION

- ✗ One-point connection for one-pipe system
- ✗ One-point connection for two-pipe system
- ✓ Two-point connection for one-pipe system (connection by way of the central connection) (see p. 312)
- ✓ Two-point connection for two-pipe system (standard) (see p. 312)
- ✗ Integrated valve
- Connections: ½" (inner thread)

TULIPA-A VERTICAL

Heat in plain sight

A first generation designer radiator. Suitable for all areas and applications. Characterised by its classic open structure and the perpendicular connection of the pipes to the collector. The guarantee for an immaculate heating comfort, everywhere in house.

RECOMMENDED CONNECTION (1008)

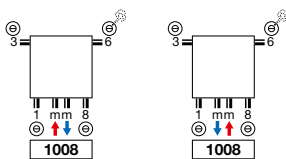

ref. nr. 1182.001.0000.9016
price €129
Fittings, see p. 327



ref. nr. 11911630102
price €44

RECOMMENDED FOR BATHROOM AND KITCHEN IN OPTION



towel rail (RAL 9005)
ref. nr. see p. 241
price €145

Other accessories, see p. 241

Other connection methods, see p. 242



TV1-A / TV2-A

HOW TO ORDER TULIPA-A VERTICAL

Delivery time 15 - 30 working days
(transport duration not included)

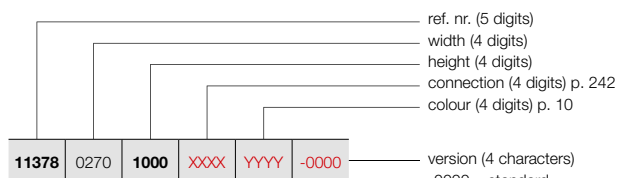

FREE-STANDING INSTALLATION (TV1-A)

See p. 240 for additional accessories.

version (4 characters)
-0000 = standard
-0006 = with fixed feet
-A100 = higher service pressure (10 bar)

HOW TO ORDER STOCK RADIATOR TULIPA-A VERTICAL

Delivery time 5 working days
(transport duration not included)

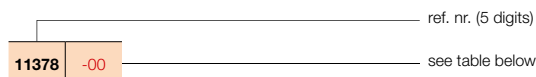

TULIPA-A VERTICAL (TV1-A)



TV1-A

PRICE GROUP: VPG2 - STEEL DESIGN RADIATORS

REFERENCE CODE CUSTOM MADE TULIPA-A VERTICAL	TECHNICAL DATA									STANDARD COLOUR		OTHER COLOURS price colour (€)					
	tubes	width (L mm)	height (H mm)	75/65/20 (Watt) (φ50K)	55/45/20 (Watt) (φ30K)	n-exp.	weight (kg)	water content (l)	electr. resistance (Watt)	price RAL 9016 (€)	short ref. nr. RAL 9016 stock						
REF. NR. TULIPA-A VERTICAL TV1-A : 11378																	
11378	0270	1000	XXXX	YYYY	-0000	6	270	1000	384	204	1,24	9,60	2,64	-	262	-	301
		1200				6	270	1200	456	240	1,24	11,40	3,12	-	291	-	335
		1500				6	270	1500	564	294	1,25	14,40	3,84	-	331	-	381
		1600				6	270	1600	600	312	1,26	15,00	4,08	-	343	-	394
		1800				6	270	1800	660	342	1,26	16,80	4,56	-	368	-	423
		2000				6	270	2000	738	384	1,27	18,60	4,98	-	394	-	453
		2200				6	270	2200	810	420	1,27	20,40	5,46	-	421	-	484
		2500				6	270	2500	912	474	1,28	23,40	6,18	-	495	-	569
		3000				6	270	3000	1092	558	1,29	27,60	7,32	-	527	-	606
11378	0360	1000	XXXX	YYYY	-0000	8	360	1000	512	272	1,24	12,80	3,52	-	325	-	374
		1200				8	360	1200	608	320	1,24	15,20	4,16	-	363	-	417
		1500				8	360	1500	752	392	1,25	19,20	5,12	-	414	-	476
		1600				8	360	1600	800	416	1,26	20,00	5,44	-	433	-	498
		1800				8	360	1800	880	456	1,26	22,40	6,08	-	467	-	537
		2000				8	360	2000	984	512	1,27	24,80	6,64	-	499	-	574
		2200				8	360	2200	1080	560	1,27	27,20	7,28	-	536	-	616
		2500				8	360	2500	1216	632	1,28	31,20	8,24	-	587	-	675
		3000				8	360	3000	1456	744	1,29	36,80	9,76	-	675	-	776
11378	0450	1000	XXXX	YYYY	-0000	10	450	1000	640	340	1,24	16,00	4,40	-	389	-	447
		1200				10	450	1200	760	400	1,24	19,00	5,20	-	434	-	499
		1500				10	450	1500	940	490	1,25	24,00	6,40	-	499	-	574
		1600				10	450	1600	1000	520	1,26	25,00	6,80	-	522	-	600
		1800				10	450	1800	1100	570	1,26	28,00	7,60	-	564	-	649
		2000				10	450	2000	1230	640	1,27	31,00	8,30	-	606	-	697
		2200				10	450	2200	1350	700	1,27	34,00	9,10	-	647	-	744
		2500				10	450	2500	1520	790	1,28	39,00	10,30	-	717	-	825
		3000				10	450	3000	1820	930	1,29	46,00	12,20	-	823	-	946
11378	0540	1000	XXXX	YYYY	-0000	12	540	1000	768	408	1,24	19,20	5,28	-	451	-	519
		1200				12	540	1200	912	480	1,24	22,80	6,24	-	505	-	581
		1500				12	540	1500	1128	588	1,25	28,80	7,68	-	582	-	669
		1600				12	540	1600	1200	624	1,26	30,00	8,16	-	607	-	698
		1800				12	540	1800	1320	684	1,26	33,60	9,12	-	661	11378-01	760
		2000				12	540	2000	1476	768	1,27	37,20	9,96	-	710	11378-02	817
		2200				12	540	2200	1620	840	1,27	40,80	10,92	-	764	-	879
		2500				12	540	2500	1824	948	1,28	46,80	12,36	-	842	-	968
		3000				12	540	3000	2184	1116	1,29	55,20	14,64	-	974	-	1120

In conformity with EN442-1: 2014: radiators and convectors

For heat outputs in other regimes, see p. 320 (correction factors)
EXPORT. Prices in Euro (excl. VAT)

TULIPA-A VERTICAL (TV1-A)



TV1-A

HOW TO ORDER TULIPA-A VERTICAL

Delivery time 15 - 30 working days
(transport duration not included)

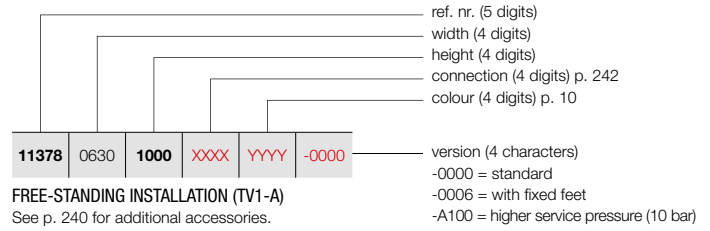

FREE-STANDING INSTALLATION (TV1-A)
See p. 240 for additional accessories.

PRICE GROUP: VPG2 - STEEL DESIGN RADIATORS

REFERENCE CODE CUSTOM MADE TULIPA-A VERTICAL						TECHNICAL DATA					STANDARD COLOUR	OTHER COLOURS				
tubes	width (L mm)	height (H mm)	75/65/20 (Watt) (Φ50K)	55/45/20 (Watt) (Φ30K)	n-exp.	weight (kg)	water content (l)	electr. resistance (Watt)	price RAL 9016 (€)	price colour (€)						
REF. NR. TULIPA-A VERTICAL TV1-A : 11378																
11378	0630	1000	XXXX	YYYY	-0000	14	630	1000	896	476	1,24	22,40	6,16	-	515	592
		1200				14	630	1200	1064	560	1,24	26,60	7,28	-	573	659
		1500				14	630	1500	1316	686	1,25	33,60	8,96	-	667	767
		1600				14	630	1600	1400	728	1,26	35,00	9,52	-	697	802
		1800				14	630	1800	1540	798	1,26	39,20	10,64	-	757	871
		2000				14	630	2000	1722	896	1,27	43,40	11,62	-	819	942
		2200				14	630	2200	1890	980	1,27	47,60	12,74	-	881	1013
		2500				14	630	2500	2128	1106	1,28	54,60	14,42	-	969	1114
		3000				14	630	3000	2548	1302	1,29	64,40	17,08	-	1121	1289
11378	0720	1000	XXXX	YYYY	-0000	16	720	1000	1024	544	1,24	25,60	7,04	-	578	665
		1200				16	720	1200	1216	640	1,24	30,40	8,32	-	644	741
		1500				16	720	1500	1504	784	1,25	38,40	10,24	-	750	863
		1600				16	720	1600	1600	832	1,26	40,00	10,88	-	785	903
		1800				16	720	1800	1760	912	1,26	44,80	12,16	-	854	982
		2000				16	720	2000	1968	1024	1,27	49,60	13,28	-	923	1061
		2200				16	720	2200	2160	1120	1,27	54,40	14,56	-	994	1143
		2500				16	720	2500	2432	1264	1,28	62,40	16,48	-	1098	1263
		3000				16	720	3000	2912	1488	1,29	73,60	19,52	-	1269	1459
11378	0810	1000	XXXX	YYYY	-0000	18	810	1000	1152	612	1,24	28,80	7,92	-	638	734
		1200				18	810	1200	1368	720	1,24	34,20	9,36	-	717	825
		1500				18	810	1500	1692	882	1,25	43,20	11,52	-	831	956
		1600				18	810	1600	1800	936	1,26	45,00	12,24	-	870	1001
		1800				18	810	1800	1980	1026	1,26	50,40	13,68	-	953	1096
		2000				18	810	2000	2214	1152	1,27	55,80	14,94	-	1029	1183
		2200				18	810	2200	2430	1260	1,27	61,20	16,38	-	1107	1273
		2500				18	810	2500	2736	1422	1,28	70,20	18,54	-	1225	1409
		3000				18	810	3000	3276	1674	1,29	82,80	21,96	-	1420	1633
11378	0900	1000	XXXX	YYYY	-0000	20	900	1000	1280	680	1,24	32,00	8,80	-	702	807
		1200				20	900	1200	1520	800	1,24	38,00	10,40	-	787	905
		1500				20	900	1500	1880	980	1,25	48,00	12,80	-	917	1055
		1600				20	900	1600	2000	1040	1,26	50,00	13,60	-	961	1105
		1800				20	900	1800	2200	1140	1,26	56,00	15,20	-	1050	1208
		2000				20	900	2000	2460	1280	1,27	62,00	16,60	-	1134	1304
		2200				20	900	2200	2700	1400	1,27	68,00	18,20	-	1223	1406
		2500				20	900	2500	3040	1580	1,28	78,00	20,60	-	1352	1555
		3000				20	900	3000	3640	1860	1,29	92,00	24,40	-	1566	1801

In conformity with EN442-1: 2014: radiators and convectors

For heat outputs in other regimes, see p. 320 (correction factors)
EXPORT. Prices in Euro (excl. VAT)

HOW TO ORDER TULIPA-A VERTICAL

Delivery time 15 - 30 working days
(transport duration not included)

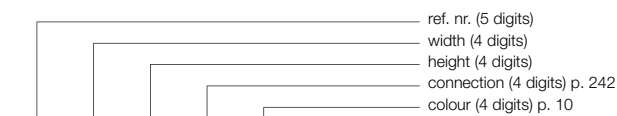

11378	0990	1000	XXXX	YYYY	-0000
-------	------	------	------	------	-------

version (4 characters)
-0000 = standard
-0006 = with fixed feet
-A100 = higher service pressure (10 bar)

FREE-STANDING INSTALLATION (TV1-A)

See p. 240 for additional accessories.

TULIPA-A VERTICAL (TV1-A)



TV1-A

PRICE GROUP: VPG2 - STEEL DESIGN RADIATORS

REFERENCE CODE CUSTOM MADE TULIPA-A VERTICAL	TECHNICAL DATA									STANDARD COLOUR	OTHER COLOURS
	tubes	width (L mm)	height (H mm)	75/65/20 (Watt) (φ50K)	55/45/20 (Watt) (φ30K)	n-exp.	weight (kg)	water content (l)	electr. resistance (Watt)	price RAL 9016 (€)	price colour (€)
REF. NR. TULIPA-A VERTICAL TV1-A : 11378											
11378 0990 1000 XXXX YYYY -0000	22	990	1000	1408	748	1,24	35,20	9,68	-	764	879
	22	990	1200	1672	880	1,24	41,80	11,44	-	859	988
	22	990	1500	2068	1078	1,25	52,80	14,08	-	1004	1155
	22	990	1600	2200	1144	1,26	55,00	14,96	-	1051	1209
	22	990	1800	2420	1254	1,26	61,60	16,72	-	1147	1319
	22	990	2000	2706	1408	1,27	68,20	18,26	-	1240	1426
	22	990	2200	2970	1540	1,27	74,80	20,02	-	1337	1538
	22	990	2500	3344	1738	1,28	85,80	22,66	-	1479	1701
11378 1080 1000 XXXX YYYY -0000	24	1080	1000	1536	816	1,24	38,40	10,56	-	827	951
	24	1080	1200	1824	960	1,24	45,60	12,48	-	929	1068
	24	1080	1500	2256	1176	1,25	57,60	15,36	-	1086	1249
	24	1080	1600	2400	1248	1,26	60,00	16,32	-	1139	1310
	24	1080	1800	2640	1368	1,26	67,20	18,24	-	1241	1427
	24	1080	2000	2952	1536	1,27	74,40	19,92	-	1346	1548
	24	1080	2200	3240	1680	1,27	81,60	21,84	-	1452	1670
11378 1170 1000 XXXX YYYY -0000	26	1170	1000	1664	884	1,24	41,60	11,44	-	889	1022
	26	1170	1200	1976	1040	1,24	49,40	13,52	-	1001	1151
	26	1170	1500	2444	1274	1,25	62,40	16,64	-	1171	1347
	26	1170	1600	2600	1352	1,26	65,00	17,68	-	1227	1411
	26	1170	1800	2860	1482	1,26	72,80	19,76	-	1339	1540
	26	1170	2000	3198	1664	1,27	80,60	21,58	-	1453	1671
11378 1260 1000 XXXX YYYY -0000	28	1260	1000	1792	952	1,24	44,80	12,32	-	953	1096
	28	1260	1200	2128	1120	1,24	53,20	14,56	-	1072	1233
	28	1260	1500	2632	1372	1,25	67,20	17,92	-	1253	1441
	28	1260	1600	2800	1456	1,26	70,00	19,04	-	1314	1511
	28	1260	1800	3080	1596	1,26	78,40	21,28	-	1437	1653

In conformity with EN442-1: 2014: radiators and convectors

For heat outputs in other regimes, see p. 320 (correction factors)
EXPORT. Prices in Euro (excl. VAT)

VASCO

TULIPA-A VERTICAL (TV2-A)



TV2-A

HOW TO ORDER TULIPA-A VERTICAL

Delivery time 15 - 30 working days
(transport duration not included)

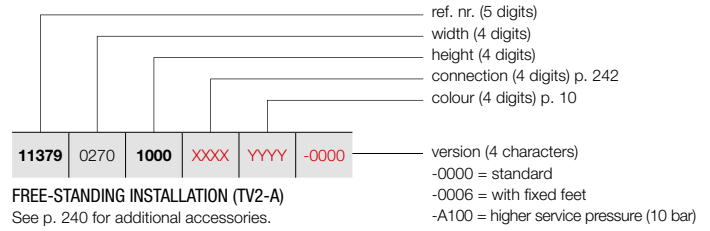

FREE-STANDING INSTALLATION (TV2-A)

See p. 240 for additional accessories.

HOW TO ORDER STOCK RADIATOR VIOLA-A VERTICAL

Delivery time 5 working days
(transport duration not included)

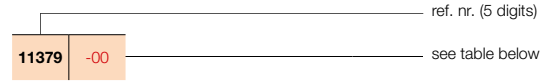

PRICE GROUP: VPG2 - STEEL DESIGN RADIATORS

REFERENCE CODE CUSTOM MADE TULIPA-A VERTICAL							TECHNICAL DATA					STANDARD COLOUR		OTHER COLOURS			
tubes	width (L mm)	height (H mm)	75/65/20 (Watt) (Φ50K)	55/45/20 (Watt) (Φ30K)	n-exp.	weight (kg)	water content (l)	electr. resistance (Watt)	price RAL 9016 (€)	short ref. nr. RAL 9016 stock	price colour (€)						
REF. NR. TULIPA-A VERTICAL TV2-A : 11379																	
11379	0270	1000	XXXX	YYYY	-0000	6	270	1000	636	330	1,26	18,60	4,98	-	464	-	534
		1200				6	270	1200	750	390	1,26	22,20	5,94	-	510	-	587
		1500				6	270	1500	924	480	1,27	27,60	7,32	-	577	-	664
		1600				6	270	1600	984	504	1,28	29,40	7,80	-	600	-	690
		1800				6	270	1800	1134	582	1,28	33,00	8,70	-	642	-	738
		2000				6	270	2000	1212	624	1,29	36,60	9,66	-	693	-	797
		2200				6	270	2200	1326	684	1,29	40,20	10,56	-	739	-	850
		2500				6	270	2500	1500	768	1,30	45,60	12,00	-	807	-	928
		3000				6	270	3000	1788	906	1,31	54,60	14,34	-	920	-	1058
11379	0360	1000	XXXX	YYYY	-0000	8	360	1000	848	440	1,26	24,80	6,64	-	571	-	657
		1200				8	360	1200	1000	520	1,26	29,60	7,92	-	633	-	728
		1500				8	360	1500	1232	640	1,27	36,80	9,76	-	726	-	835
		1600				8	360	1600	1312	672	1,28	39,20	10,40	-	755	-	868
		1800				8	360	1800	1512	776	1,28	44,00	11,60	-	816	-	938
		2000				8	360	2000	1616	832	1,29	48,80	12,88	-	880	-	1012
		2200				8	360	2200	1768	912	1,29	53,60	14,08	-	936	-	1076
		2500				8	360	2500	2000	1024	1,30	60,80	16,00	-	1028	-	1182
		3000				8	360	3000	2384	1208	1,31	72,80	19,12	-	1180	-	1357
11379	0450	1000	XXXX	YYYY	-0000	10	450	1000	1060	550	1,26	31,00	8,30	-	681	-	783
		1200				10	450	1200	1250	650	1,26	37,00	9,90	-	756	-	869
		1500				10	450	1500	1540	800	1,27	46,00	12,20	-	872	-	1003
		1600				10	450	1600	1640	840	1,28	49,00	13,00	-	909	-	1045
		1800				10	450	1800	1890	970	1,28	55,00	14,50	-	988	-	1136
		2000				10	450	2000	2020	1040	1,29	61,00	16,10	-	1062	-	1221
		2200				10	450	2200	2210	1140	1,29	67,00	17,60	-	1136	-	1306
		2500				10	450	2500	2500	1280	1,30	76,00	20,00	-	1254	-	1442
		3000				10	450	3000	2980	1510	1,31	91,00	23,90	-	1442	-	1658
11379	0540	1000	XXXX	YYYY	-0000	12	540	1000	1272	660	1,26	37,20	9,96	-	788	-	906
		1200				12	540	1200	1500	780	1,26	44,40	11,88	-	885	-	1018
		1500				12	540	1500	1848	960	1,27	55,20	14,64	-	1020	-	1173
		1600				12	540	1600	1968	1008	1,28	58,80	15,60	-	1064	-	1224
		1800				12	540	1800	2268	1164	1,28	66,00	17,40	-	1156	-	1329
		2000				12	540	2000	2424	1248	1,29	73,20	19,32	-	1244	11379-01	1431
		2200				12	540	2200	2652	1368	1,29	80,40	21,12	-	1337	-	1538
		2500				12	540	2500	3000	1536	1,30	91,20	24,00	-	1474	-	1695
		3000				12	540	3000	3576	1812	1,31	109,20	28,68	-	1703	-	1958

In conformity with EN442-1: 2014: radiators and convectors

For heat outputs in other regimes, see p. 320 (correction factors)
EXPORT. Prices in Euro (excl. VAT)

HOW TO ORDER TULIPA-A VERTICAL

Delivery time 15 - 30 working days
(transport duration not included)

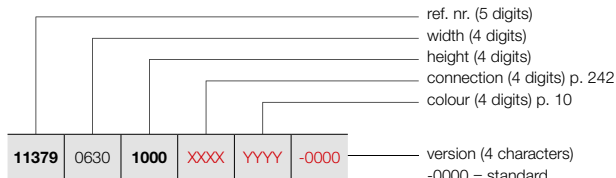

FREE-STANDING INSTALLATION (TV2-A)

See p. 240 for additional accessories.

- version (4 characters)
- 0000 = standard
- 0006 = with fixed feet
- A100 = higher service pressure (10 bar)

HOW TO ORDER STOCK RADIATOR VIOLA-A VERTICAL

Delivery time 5 working days
(transport duration not included)

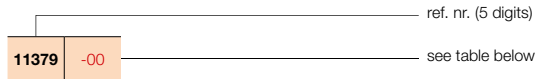

TULIPA-A VERTICAL (TV2-A)



TV2-A

PRICE GROUP: VPG2 - STEEL DESIGN RADIATORS

REFERENCE CODE CUSTOM MADE TULIPA-A VERTICAL	TECHNICAL DATA									STANDARD COLOUR		OTHER COLOURS
	tubes	width (L mm)	height (H mm)	75/65/20 (Watt) (Φ50K)	55/45/20 (Watt) (Φ30K)	n-exp.	weight (kg)	water content (l)	electr. resistance (Watt)	price RAL 9016 (€)	short ref. nr. RAL 9016 stock	price colour (€)
REF. NR. TULIPA-A VERTICAL TV2-A : 11379												
11379	0630	1000	XXXX	YYYY	-0000							
		1200										
		1500										
		1600										
		1800										
		2000										
		2200										
		2500										
		3000										
11379	0720	1000	XXXX	YYYY	-0000							
		1200										
		1500										
		1600										
		1800										
		2000										
		2200										
		2500										
		3000										
11379	0810	1000	XXXX	YYYY	-0000							
		1200										
		1500										
		1600										
		1800										
		2000										
		2200										
		2500										
		3000										
11379	0900	1000	XXXX	YYYY	-0000							
		1200										
		1500										
		1600										
		1800										
		2000										
		2200										
		2500										
		3000										

In conformity with EN442-1: 2014: radiators and convectors

For heat outputs in other regimes, see p. 320 (correction factors)
EXPORT. Prices in Euro (excl. VAT)

TULIPA-A VERTICAL (TV2-A)



TV2-A

HOW TO ORDER TULIPA-A VERTICAL

Delivery time 15 - 30 working days
(transport duration not included)

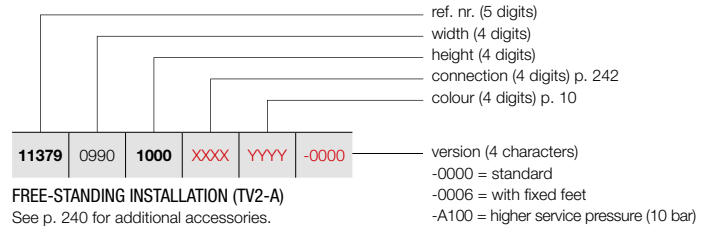

FREE-STANDING INSTALLATION (TV2-A)

See p. 240 for additional accessories.

PRICE GROUP: VPG2 - STEEL DESIGN RADIATORS

REFERENCE CODE CUSTOM MADE TULIPA-A VERTICAL							TECHNICAL DATA					STANDARD COLOUR	OTHER COLOURS			
tubes	width (L mm)	height (H mm)	75/65/20 (Watt) (Φ50K)	55/45/20 (Watt) (Φ30K)	n-exp.	weight (kg)	water content (l)	electr. resistance (Watt)	price RAL 9016 (€)	price colour (€)						
REF. NR. TULIPA-A VERTICAL TV2-A : 11379																
11379	0990	1000	XXXX	YYYY	-0000	22	990	1000	2332	1210	1,26	68,20	18,26	-	1337	1538
		1200				22	990	1200	2750	1430	1,26	81,40	21,78	-	1502	1727
		1500				22	990	1500	3388	1760	1,27	101,20	26,84	-	1753	2016
		1600				22	990	1600	3608	1848	1,28	107,80	28,60	-	1837	2113
		1800				22	990	1800	4158	2134	1,28	121,00	31,90	-	2007	2308
		2000				22	990	2000	4444	2288	1,29	134,20	35,42	-	2174	2500
		2200				22	990	2200	4862	2508	1,29	147,40	38,72	-	2339	2690
		2500				22	990	2500	5500	2816	1,30	167,20	44,00	-	2589	2977
11379	1080	1000	XXXX	YYYY	-0000	24	1080	1000	2544	1320	1,26	74,40	19,92	-	1446	1663
		1200				24	1080	1200	3000	1560	1,26	88,80	23,76	-	1626	1870
		1500				24	1080	1500	3696	1920	1,27	110,40	29,28	-	1904	2190
		1600				24	1080	1600	3936	2016	1,28	117,60	31,20	-	1997	2297
		1800				24	1080	1800	4536	2328	1,28	132,00	34,80	-	2175	2501
		2000				24	1080	2000	4848	2496	1,29	146,40	38,64	-	2355	2708
		2200				24	1080	2200	5304	2736	1,29	160,80	42,24	-	2539	2920
11379	1170	1000	XXXX	YYYY	-0000	26	1170	1000	2756	1430	1,26	80,60	21,58	-	1554	1787
		1200				26	1170	1200	3250	1690	1,26	96,20	25,74	-	1754	2017
		1500				26	1170	1500	4004	2080	1,27	119,60	31,72	-	2048	2355
		1600				26	1170	1600	4264	2184	1,28	127,40	33,80	-	2147	2469
		1800				26	1170	1800	4914	2522	1,28	143,00	37,70	-	2346	2698
		2000				26	1170	2000	5252	2704	1,29	158,60	41,86	-	2541	2922
11379	1260	1000	XXXX	YYYY	-0000	28	1260	1000	2968	1540	1,26	86,80	23,24	-	1662	1911
		1200				28	1260	1200	3500	1820	1,26	103,60	27,72	-	1876	2157
		1500				28	1260	1500	4312	2240	1,27	128,80	34,16	-	2194	2523
		1600				28	1260	1600	4592	2352	1,28	137,20	36,40	-	2299	2644
		1800				28	1260	1800	5292	2716	1,28	154,00	40,60	-	2511	2888

In conformity with EN442-1: 2014: radiators and convectors

For heat outputs in other regimes, see p. 320 (correction factors)
EXPORT. Prices in Euro (excl. VAT)

TYPES

- One (TH1-A) or two rows (TH2-A) of tubes

TUBES

- Vertical, flat-oval 60 x 10 mm

COLLECTORS

- Horizontal, rear, round Ø 32 mm

COLOURS

- Standard colour white RAL 9016
- Extensive colour chart see p. 10

SPECIAL

- TH1-A also available as toilet radiator (540 x 500 mm)

BRACKETS

- Wall brackets standard (included in packaging of radiator)
- **TH1-A / TH2-A:** also available as free-standing radiator, see p. 240. Additional wall mounting support necessary for height radiator > 600 mm.

TECHNICAL

- Welded by means of resistance welding robots (invisible weld seams)
- ATL priming coat, powder coating
- Standard operating pressure: 6 bar. Extra charge for higher service pressures (10 bar): +10%.
- The delivery time of a radiator with a higher service pressure is 1 week extra.
- Maximum operating temperature: 110°C

ELECTRICAL

- ✗ Pure electrical radiator prefilled
- ✗ Mixed radiator

TECHNICAL DRAWINGS

- See p. 243

CONNECTION

- ✗ One-point connection for one-pipe system
- ✗ One-point connection for two-pipe system
- ✓ Two-point connection for one-pipe system (connection by way of the central connection) (see p. 312)
- ✓ Two-point connection for two-pipe system (standard) (see p. 312)
- ✗ Integrated valve
- Connections: ½" (inner thread)



TULIPA-A HORIZONTAL

Eternal charm, timeless class

The horizontal version of the Tulipa-A. The textbook example of a designer radiator in its most authentic form. Characterised by its classic open structure and the perpendicular connection of the pipes to the collector. A designer radiator which continues to charm. A classic that fits anywhere.

RECOMMENDED CONNECTION (0018)

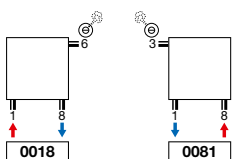

ref. nr. 1182 101 0000 0099
price €218
 Fittings, see p. 327

Other connection methods, see p. 242

RECOMMENDED FOR BATHROOM AND KITCHEN IN OPTION



towel rail (RAL 9005)
 ref. nr. see p. 241
price €145
 Other accessories, see p. 241



TULIPA-A HORIZONTAL (TH1-A)

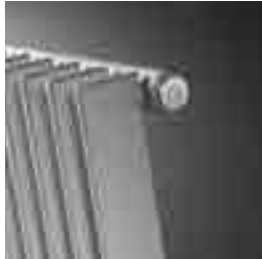

TH1-A

HOW TO ORDER TULIPA-A HORIZONTAL

Delivery time 15 - 30 working days
(transport duration not included)

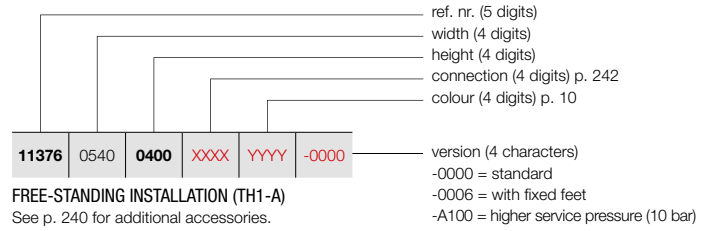

FREE-STANDING INSTALLATION (TH1-A)

See p. 240 for additional accessories.

PRICE GROUP: VPG2 - STEEL DESIGN RADIATORS

REFERENCE CODE CUSTOM MADE TULIPA-A HORIZONTAL							TECHNICAL DATA					STANDARD COLOUR	OTHER COLOURS			
tubes	width (L mm)	height (H mm)	75/65/20 (Watt) (Φ50K)	55/45/20 (Watt) (Φ30K)	n-exp.	weight (kg)	water content (l)	electr. resistance (Watt)	price RAL 9016 (€)	price colour (€)						
REF. NR. TULIPA-A HORIZONTAL TH1-A : 11376																
11376	0540	0400	XXXX	YYYY	-0000	12	540	400	348	180	1,22	9,60	2,52	-	296	340
		0500				12	540	500	420	216	1,23	10,80	3,00	-	322	370
		0600				12	540	600	492	264	1,23	12,00	3,48	-	350	403
		0700				12	540	700	564	300	1,23	14,40	3,96	-	374	430
		0800				12	540	800	636	336	1,23	15,60	4,44	-	400	460
		0900				12	540	900	696	372	1,24	18,00	4,92	-	426	490
11376	0630	0400	XXXX	YYYY	-0000	14	630	400	406	210	1,22	11,20	2,94	-	329	378
		0500				14	630	500	490	252	1,23	12,60	3,50	-	363	417
		0600				14	630	600	574	308	1,23	15,40	4,06	-	392	451
		0700				14	630	700	658	350	1,23	16,80	4,62	-	422	485
		0800				14	630	800	742	392	1,23	18,20	5,18	-	455	523
		0900				14	630	900	812	434	1,24	21,00	5,74	-	483	555
11376	0720	0400	XXXX	YYYY	-0000	16	720	400	464	240	1,22	12,80	3,36	-	368	423
		0500				16	720	500	560	288	1,23	14,40	4,00	-	403	463
		0600				16	720	600	656	352	1,23	17,60	4,64	-	438	504
		0700				16	720	700	752	400	1,23	19,20	5,28	-	471	542
		0800				16	720	800	848	448	1,23	20,80	5,92	-	509	585
		0900				16	720	900	928	496	1,24	24,00	6,56	-	541	622
11376	0810	0400	XXXX	YYYY	-0000	18	810	400	522	270	1,22	14,40	3,78	-	405	466
		0500				18	810	500	630	324	1,23	16,20	4,50	-	443	509
		0600				18	810	600	738	396	1,23	19,80	5,22	-	483	555
		0700				18	810	700	846	450	1,23	21,60	5,94	-	523	601
		0800				18	810	800	954	504	1,23	23,40	6,66	-	563	647
		0900				18	810	900	1044	558	1,24	27,00	7,38	-	600	690
11376	0900	0400	XXXX	YYYY	-0000	20	900	400	580	300	1,22	16,00	4,20	-	442	508
		0500				20	900	500	700	360	1,23	18,00	5,00	-	485	558
		0600				20	900	600	820	440	1,23	22,00	5,80	-	529	608
		0700				20	900	700	940	500	1,23	24,00	6,60	-	570	656
		0800				20	900	800	1060	560	1,23	26,00	7,40	-	615	707
		0900				20	900	900	1160	620	1,24	30,00	8,20	-	660	759
11376	0990	0400	XXXX	YYYY	-0000	22	990	400	638	330	1,22	17,60	4,62	-	475	546
		0500				22	990	500	770	396	1,23	19,80	5,50	-	527	606
		0600				22	990	600	902	484	1,23	24,20	6,38	-	571	657
		0700				22	990	700	1034	550	1,23	26,40	7,26	-	622	715
		0800				22	990	800	1166	616	1,23	28,60	8,14	-	670	771
		0900				22	990	900	1276	682	1,24	33,00	9,02	-	714	821
11376	1080	0400	XXXX	YYYY	-0000	24	1080	400	696	360	1,22	19,20	5,04	-	515	592
		0500				24	1080	500	840	432	1,23	21,60	6,00	-	566	651
		0600				24	1080	600	984	528	1,23	26,40	6,96	-	618	711
		0700				24	1080	700	1128	600	1,23	28,80	7,92	-	671	772
		0800				24	1080	800	1272	672	1,23	31,20	8,88	-	724	833
		0900				24	1080	900	1392	744	1,24	36,00	9,84	-	774	890

In conformity with EN442-1: 2014: radiators and convectors

For heat outputs in other regimes, see p. 320 (correction factors)
EXPORT. Prices in Euro (excl. VAT)

HOW TO ORDER TULIPA-A HORIZONTAL

Delivery time 15 - 30 working days
(transport duration not included)

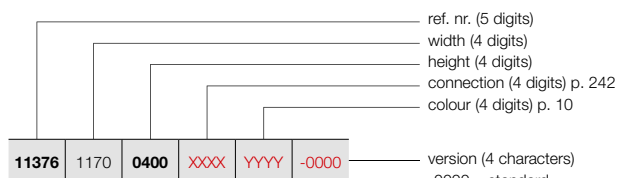

ref. nr. (5 digits)
width (4 digits)
height (4 digits)
connection (4 digits) p. 242
colour (4 digits) p. 10

version (4 characters)
-0000 = standard
-0006 = with fixed feet
-A100 = higher service pressure (10 bar)

FREE-STANDING INSTALLATION (TH1-A)

See p. 240 for additional accessories.

TULIPA-A HORIZONTAL (TH1-A)

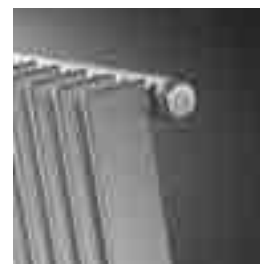

TH1-A

PRICE GROUP: VPG2 - STEEL DESIGN RADIATORS

REFERENCE CODE CUSTOM MADE TULIPA-A HORIZONTAL	TECHNICAL DATA									STANDARD COLOUR	OTHER COLOURS					
	tubes	width (L mm)	height (H mm)	75/65/20 (Watt) (φ50K)	55/45/20 (Watt) (φ30K)	n-exp.	weight (kg)	water content (l)	electr. resistance (Watt)	price RAL 9016 (€)	price colour (€)					
REF. NR. TULIPA-A HORIZONTAL TH1-A : 11376																
11376	1170	0400	XXXX	YYYY	-0000	26	1170	400	754	390	1,22	20,80	5,46	-	550	633
		0500				26	1170	500	910	468	1,23	23,40	6,50	-	606	697
		0600				26	1170	600	1066	572	1,23	28,60	7,54	-	665	765
		0700				26	1170	700	1222	650	1,23	28,80	8,58	-	718	826
		0800				26	1170	800	1378	728	1,23	31,20	9,62	-	775	891
		0900				26	1170	900	1508	806	1,24	36,00	10,66	-	833	958
11376	1260	0400	XXXX	YYYY	-0000	28	1260	400	812	420	1,22	22,40	5,88	-	588	676
		0500				28	1260	500	980	504	1,23	25,20	7,00	-	646	743
		0600				28	1260	600	1148	616	1,23	30,80	8,12	-	706	812
		0700				28	1260	700	1316	700	1,23	33,60	9,24	-	768	883
		0800				28	1260	800	1484	784	1,23	36,40	10,36	-	831	956
		0900				28	1260	900	1624	868	1,24	42,00	11,48	-	891	1025
11376	1440	0400	XXXX	YYYY	-0000	32	1440	400	928	480	1,22	25,60	6,72	-	660	759
		0500				32	1440	500	1120	576	1,23	28,80	8,00	-	730	840
		0600				32	1440	600	1312	704	1,23	35,20	9,28	-	798	918
		0700				32	1440	700	1504	800	1,23	38,40	10,56	-	865	995
		0800				32	1440	800	1696	896	1,23	41,60	11,84	-	935	1075
		0900				32	1440	900	1856	992	1,24	48,00	13,12	-	1007	1158
11376	1620	0400	XXXX	YYYY	-0000	36	1620	400	1044	540	1,22	28,80	7,56	-	732	842
		0500				36	1620	500	1260	648	1,23	32,40	9,00	-	810	932
		0600				36	1620	600	1476	792	1,23	39,60	10,44	-	889	1022
		0700				36	1620	700	1692	900	1,23	43,20	11,88	-	964	1109
		0800				36	1620	800	1908	1008	1,23	46,80	13,32	-	1048	1205
		0900				36	1620	900	2088	1116	1,24	54,00	14,76	-	1121	1289
11376	1800	0400	XXXX	YYYY	-0000	40	1800	400	1160	600	1,22	32,00	8,40	-	804	925
		0500				40	1800	500	1400	720	1,23	36,00	10,00	-	892	1026
		0600				40	1800	600	1640	880	1,23	44,00	11,60	-	978	1125
		0700				40	1800	700	1880	1000	1,23	48,00	13,20	-	1064	1224
		0800				40	1800	800	2120	1120	1,23	52,00	14,80	-	1152	1325
		0900				40	1800	900	2320	1240	1,24	60,00	16,40	-	1238	1424
11376	1980	0400	XXXX	YYYY	-0000	44	1980	400	1276	660	1,22	35,20	9,24	-	880	1012
		0500				44	1980	500	1540	792	1,23	39,60	11,00	-	974	1120
		0600				44	1980	600	1804	968	1,23	48,40	12,76	-	1069	1229
		0700				44	1980	700	2068	1100	1,23	52,80	14,52	-	1161	1335
		0800				44	1980	800	2332	1232	1,23	57,20	16,28	-	1259	1448
		0900				44	1980	900	2552	1364	1,24	66,00	18,04	-	1352	1555
11376	2160	0400	XXXX	YYYY	-0000	48	2160	400	1392	720	1,22	38,40	10,08	-	953	1096
		0500				48	2160	500	1680	864	1,23	43,20	12,00	-	1054	1212
		0600				48	2160	600	1968	1056	1,23	52,80	13,92	-	1157	1331
		0700				48	2160	700	2256	1200	1,23	57,60	15,84	-	1264	1454
		0800				48	2160	800	2544	1344	1,23	62,40	17,76	-	1367	1572
		0900				48	2160	900	2784	1488	1,24	72,00	19,68	-	1471	1692

In conformity with EN442-1: 2014: radiators and convectors

For heat outputs in other regimes, see p. 320 (correction factors)
EXPORT. Prices in Euro (excl. VAT)

VASCO

TULIPA-A HORIZONTAL (TH1-A)

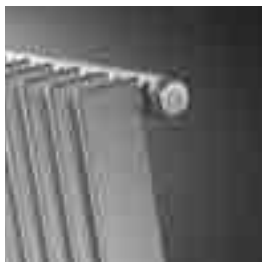

TH1-A

HOW TO ORDER TULIPA-A HORIZONTAL

Delivery time 15 - 30 working days
(transport duration not included)

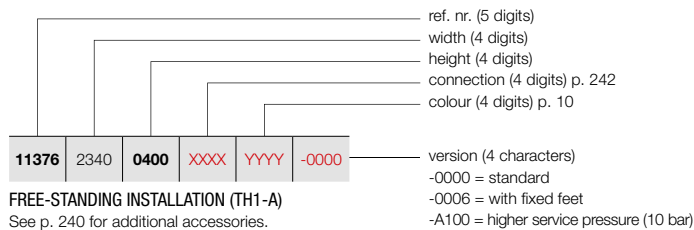

FREE-STANDING INSTALLATION (TH1-A)

See p. 240 for additional accessories.

PRICE GROUP: VPG2 - STEEL DESIGN RADIATORS

REFERENCE CODE CUSTOM MADE TULIPA-A HORIZONTAL							TECHNICAL DATA					STANDARD COLOUR	OTHER COLOURS			
tubes	width (L mm)	height (H mm)	75/65/20 (Watt) (Φ50K)	55/45/20 (Watt) (Φ30K)	n-exp.	weight (kg)	water content (l)	electr. resistance (Watt)	price RAL 9016 (€)	price colour (€)						
REF. NR. TULIPA-A HORIZONTAL TH1-A : 11376																
11376	2340	0400	XXXX	YYYY	-0000	52	2340	400	1508	780	1,22	41,60	10,92	-	1022	1175
						52	2340	500	1820	936	1,23	46,80	13,00	-	1136	1306
						52	2340	600	2132	1144	1,23	57,20	15,08	-	1245	1432
						52	2340	700	2444	1300	1,23	62,40	17,16	-	1364	1569
						52	2340	800	2756	1456	1,23	67,60	19,24	-	1474	1695
						52	2340	900	3016	1612	1,24	78,00	21,32	-	1587	1825
11376	2520	0400	XXXX	YYYY	-0000	56	2520	400	1624	840	1,22	44,80	11,76	-	1095	1259
						56	2520	500	1960	1008	1,23	50,40	14,00	-	1219	1402
						56	2520	600	2296	1232	1,23	61,60	16,24	-	1338	1539
						56	2520	700	2632	1400	1,23	67,20	18,48	-	1459	1678
						56	2520	800	2968	1568	1,23	72,80	20,72	-	1581	1818
						56	2520	900	3248	1736	1,24	84,00	22,96	-	1701	1956
11376	2700	0400	XXXX	YYYY	-0000	60	2700	400	1740	900	1,22	48,00	12,60	-	1167	1342
						60	2700	500	2100	1080	1,23	54,00	15,00	-	1298	1493
						60	2700	600	2460	1320	1,23	66,00	17,40	-	1427	1641
						60	2700	700	2820	1500	1,23	72,00	19,80	-	1560	1794
						60	2700	800	3180	1680	1,23	78,00	22,20	-	1688	1941
						60	2700	900	3540	1860	1,24	90,00	24,60	-	1817	2088
11376	2880	0400	XXXX	YYYY	-0000	64	2880	400	1856	960	1,22	51,20	13,44	-	1240	1426
						64	2880	500	2240	1152	1,23	57,60	16,00	-	1380	1587
						64	2880	600	2624	1408	1,23	70,40	18,56	-	1520	1748
						64	2880	700	3008	1600	1,23	76,80	21,12	-	1658	1907
11376	3060	0400	XXXX	YYYY	-0000	68	3060	400	1972	1020	1,22	54,40	14,28	-	1313	1510
						68	3060	500	2380	1224	1,23	61,20	17,00	-	1460	1679
						68	3060	600	2788	1496	1,23	74,80	19,72	-	1609	1850
						68	3060	700	3196	1700	1,23	81,60	22,44	-	1755	2018

In conformity with EN442-1: 2014: radiators and convectors

For heat outputs in other regimes, see p. 320 (correction factors)
EXPORT. Prices in Euro (excl. VAT)

VASCO

HOW TO ORDER TULIPA-A HORIZONTAL

Delivery time 15 - 30 working days
(transport duration not included)

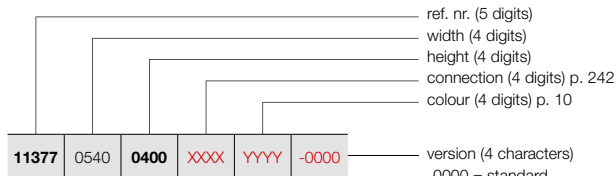

FREE-STANDING INSTALLATION (TH2-A)

See p. 240 for additional accessories.

TULIPA-A HORIZONTAL (TH2-A)



TH2-A

PRICE GROUP: VPG2 - STEEL DESIGN RADIATORS

REFERENCE CODE CUSTOM MADE TULIPA-A HORIZONTAL	TECHNICAL DATA									STANDARD COLOUR	OTHER COLOURS
	tubes	width (L mm)	height (H mm)	75/65/20 (Watt) (φ50K)	55/45/20 (Watt) (φ30K)	n-exp.	weight (kg)	water content (l)	electr. resistance (Watt)	price RAL 9016 (€)	price colour (€)
REF. NR. TULIPA-A HORIZONTAL TH2-A : 11377											
11377 0540 0400 XXXX YYYY -0000	0500	540	400	588	312	1,24	16,80	4,32	-	522	600
	0600	540	500	648	372	1,25	20,40	5,28	-	565	650
	0700	540	600	816	432	1,25	24,00	6,24	-	608	699
	0800	540	700	936	492	1,25	26,40	7,20	-	656	754
	0900	540	800	1044	552	1,25	30,00	8,16	-	701	806
		540	900	1164	600	1,26	33,60	9,00	-	745	857
11377 0630 0400 XXXX YYYY -0000	0500	630	400	686	364	1,24	19,60	5,04	-	582	669
	0600	630	500	756	434	1,25	23,80	6,16	-	633	728
	0700	630	600	952	504	1,25	28,00	7,28	-	687	790
	0800	630	700	1092	574	1,25	30,80	8,40	-	741	852
	0900	630	800	1218	644	1,25	35,00	9,52	-	791	910
		630	900	1358	700	1,26	39,20	10,50	-	848	975
11377 0720 0400 XXXX YYYY -0000	0500	720	400	784	416	1,24	22,40	5,76	-	642	738
	0600	720	500	864	496	1,25	27,20	7,04	-	705	811
	0700	720	600	1088	576	1,25	32,00	8,32	-	767	882
	0800	720	700	1248	656	1,25	35,20	9,60	-	827	951
	0900	720	800	1392	736	1,25	40,00	10,88	-	889	1022
		720	900	1552	800	1,26	44,80	12,00	-	951	1094
11377 0810 0400 XXXX YYYY -0000	0500	810	400	882	468	1,24	25,20	6,48	-	708	814
	0600	810	500	972	558	1,25	30,60	7,92	-	777	894
	0700	810	600	1224	648	1,25	36,00	9,36	-	848	975
	0800	810	700	1404	738	1,25	39,60	10,80	-	915	1052
	0900	810	800	1566	828	1,25	45,00	12,24	-	982	1129
		810	900	1746	900	1,26	50,40	13,50	-	1051	1209
11377 0900 0400 XXXX YYYY -0000	0500	900	400	980	520	1,24	28,00	7,20	-	774	890
	0600	900	500	1080	620	1,25	34,00	8,80	-	850	978
	0700	900	600	1360	720	1,25	40,00	10,40	-	923	1061
	0800	900	700	1560	820	1,25	44,00	12,00	-	1000	1150
	0900	900	800	1740	920	1,25	50,00	13,60	-	1075	1236
		900	900	1940	1000	1,26	56,00	15,00	-	1153	1326
11377 0990 0400 XXXX YYYY -0000	0500	990	400	1078	572	1,24	30,80	7,92	-	834	959
	0600	990	500	1188	682	1,25	37,40	9,68	-	920	1058
	0700	990	600	1496	792	1,25	44,00	11,44	-	1001	1151
	0800	990	700	1716	902	1,25	48,40	13,20	-	1084	1247
	0900	990	800	1914	1012	1,25	55,00	14,96	-	1169	1344
		990	900	2134	1100	1,26	61,60	16,50	-	1255	1443
11377 1080 0400 XXXX YYYY -0000	0500	1080	400	1176	624	1,24	33,60	8,64	-	901	1036
	0600	1080	500	1296	744	1,25	40,80	10,56	-	993	1142
	0700	1080	600	1632	864	1,25	48,00	12,48	-	1080	1242
	0800	1080	700	1872	984	1,25	52,80	14,40	-	1171	1347
	0900	1080	800	2088	1104	1,25	60,00	16,32	-	1266	1456
		1080	900	2328	1200	1,26	67,20	18,00	-	1352	1555

In conformity with EN442-1: 2014: radiators and convectors

For heat outputs in other regimes, see p. 320 (correction factors)
EXPORT. Prices in Euro (excl. VAT)

TULIPA-A HORIZONTAL (TH2-A)



TH2-A

HOW TO ORDER TULIPA-A HORIZONTAL

Delivery time 15 - 30 working days
(transport duration not included)

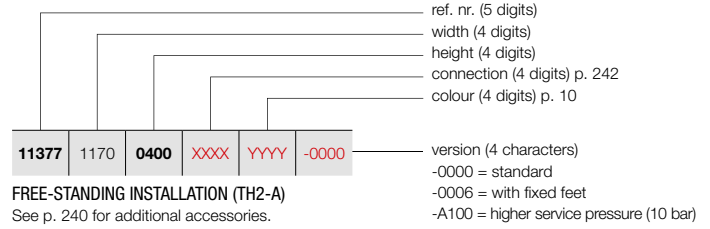

FREE-STANDING INSTALLATION (TH2-A)
See p. 240 for additional accessories.

PRICE GROUP: VPG2 - STEEL DESIGN RADIATORS

REFERENCE CODE CUSTOM MADE TULIPA-A HORIZONTAL							TECHNICAL DATA					STANDARD COLOUR	OTHER COLOURS			
tubes	width (L mm)	height (H mm)	75/65/20 (Watt) (Φ50K)	55/45/20 (Watt) (Φ30K)	n-exp.	weight (kg)	water content (l)	electr. resistance (Watt)	price RAL 9016 (€)	price colour (€)						
REF. NR. TULIPA-A HORIZONTAL TH2-A : 11377																
11377	1170	0400	XXXX	YYYY	-0000	26	1170	400	1274	676	1,24	36,40	9,36	-	962	1106
			0500	26		1170	500	1404	806	1,25	44,20	11,44	-	1062	1221	
			0600	26		1170	600	1768	936	1,25	52,00	13,52	-	1160	1334	
			0700	26		1170	700	2028	1066	1,25	57,20	15,60	-	1259	1448	
			0800	26		1170	800	2262	1196	1,25	65,00	17,68	-	1361	1565	
			0900	26		1170	900	2522	1300	1,26	72,80	19,50	-	1458	1677	
11377	1260	0400	XXXX	YYYY	-0000	28	1260	400	1372	728	1,24	39,20	10,08	-	1027	1181
			0500	28		1260	500	1512	868	1,25	47,60	12,32	-	1134	1304	
			0600	28		1260	600	1904	1008	1,25	56,00	14,56	-	1239	1425	
			0700	28		1260	700	2184	1148	1,25	61,60	16,80	-	1346	1548	
			0800	28		1260	800	2436	1288	1,25	70,00	19,04	-	1453	1671	
			0900	28		1260	900	2716	1400	1,26	78,40	21,00	-	1560	1794	
11377	1440	0400	XXXX	YYYY	-0000	32	1440	400	1568	832	1,24	44,80	11,52	-	1153	1326
			0500	32		1440	500	1728	992	1,25	54,40	14,08	-	1277	1469	
			0600	32		1440	600	2176	1152	1,25	64,00	16,64	-	1395	1604	
			0700	32		1440	700	2496	1312	1,25	70,40	19,20	-	1520	1748	
			0800	32		1440	800	2784	1472	1,25	80,00	21,76	-	1637	1883	
			0900	32		1440	900	3104	1600	1,26	89,60	24,00	-	1760	2024	
11377	1620	0400	XXXX	YYYY	-0000	36	1620	400	1764	936	1,24	50,40	12,96	-	1281	1473
			0500	36		1620	500	1944	1116	1,25	61,20	15,84	-	1419	1632	
			0600	36		1620	600	2448	1296	1,25	72,00	18,72	-	1554	1787	
			0700	36		1620	700	2808	1476	1,25	79,20	21,60	-	1691	1945	
			0800	36		1620	800	3132	1656	1,25	90,00	24,48	-	1827	2101	
			0900	36		1620	900	3492	1800	1,26	100,80	27,00	-	1963	2257	
11377	1800	0400	XXXX	YYYY	-0000	40	1800	400	1960	1040	1,24	56,00	14,40	-	1405	1616
			0500	40		1800	500	2160	1240	1,25	68,00	17,60	-	1561	1795	
			0600	40		1800	600	2720	1440	1,25	80,00	20,80	-	1714	1971	
			0700	40		1800	700	3120	1640	1,25	88,00	24,00	-	1862	2141	
			0800	40		1800	800	3480	1840	1,25	100,00	27,20	-	2015	2317	
			0900	40		1800	900	3880	2000	1,26	112,00	30,00	-	2166	2491	
11377	1980	0400	XXXX	YYYY	-0000	44	1980	400	2156	1144	1,24	61,60	15,84	-	1536	1766
			0500	44		1980	500	2376	1364	1,25	74,80	19,36	-	1703	1958	
			0600	44		1980	600	2992	1584	1,25	88,00	22,88	-	1869	2149	
			0700	44		1980	700	3432	1804	1,25	96,80	26,40	-	2036	2341	
			0800	44		1980	800	3828	2024	1,25	110,00	29,92	-	2201	2531	
			0900	44		1980	900	4268	2200	1,26	123,20	33,00	-	2372	2728	
11377	2160	0400	XXXX	YYYY	-0000	48	2160	400	2352	1248	1,24	67,20	17,28	-	1662	1911
			0500	48		2160	500	2592	1488	1,25	81,60	21,12	-	1847	2124	
			0600	48		2160	600	3264	1728	1,25	96,00	24,96	-	2027	2331	
			0700	48		2160	700	3744	1968	1,25	105,60	28,80	-	2210	2542	
			0800	48		2160	800	4176	2208	1,25	120,00	32,64	-	2390	2749	
			0900	48		2160	900	4656	2400	1,26	134,40	36,00	-	2575	2961	

In conformity with EN442-1: 2014: radiators and convectors

For heat outputs in other regimes, see p. 320 (correction factors)
EXPORT. Prices in Euro (excl. VAT)

HOW TO ORDER TULIPA-A HORIZONTAL

Delivery time 15 - 30 working days
(transport duration not included)

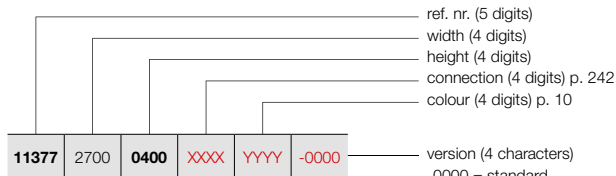

FREE-STANDING INSTALLATION (TH2-A)

See p. 240 for additional accessories.

TULIPA-A HORIZONTAL (TH2-A)



TH2-A

PRICE GROUP: VPG2 - STEEL DESIGN RADIATORS

REFERENCE CODE CUSTOM MADE TULIPA-A HORIZONTAL	TECHNICAL DATA									STANDARD COLOUR	OTHER COLOURS					
	tubes	width (L mm)	height (H mm)	75/65/20 (Watt) (φ50K)	55/45/20 (Watt) (φ30K)	n-exp.	weight (kg)	water content (l)	electr. resistance (Watt)	price RAL 9016 (€)	price colour (€)					
REF. NR. TULIPA-A HORIZONTAL TH2-A : 11377																
11377	2340	0400	XXXX	YYYY	-0000	52	2340	400	2548	1352	1,24	72,80	18,72	-	1791	2060
						52	2340	500	2808	1612	1,25	88,40	22,88	-	1986	2284
						52	2340	600	3536	1872	1,25	104,00	27,04	-	2185	2513
						52	2340	700	4056	2132	1,25	114,40	31,20	-	2382	2739
						52	2340	800	4524	2392	1,25	130,00	35,36	-	2579	2966
						52	2340	900	5044	2600	1,26	145,60	39,00	-	2777	3194
11377	2520	0400	XXXX	YYYY	-0000	56	2520	400	2744	1456	1,24	78,40	20,16	-	1918	2206
						56	2520	500	3024	1736	1,25	95,20	24,64	-	2130	2450
						56	2520	600	3808	2016	1,25	112,00	29,12	-	2343	2694
						56	2520	700	4368	2296	1,25	123,20	33,60	-	2553	2936
						56	2520	800	4872	2576	1,25	140,00	38,08	-	2765	3180
						56	2520	900	5432	2800	1,26	156,80	42,00	-	2976	3422
11377	2700	0400	XXXX	YYYY	-0000	60	2700	400	2940	1560	1,24	84,00	21,60	-	2042	2348
						60	2700	500	3240	1860	1,25	102,00	26,40	-	2273	2614
						60	2700	600	4080	2160	1,25	120,00	31,20	-	2497	2872
						60	2700	700	4680	2460	1,25	132,00	36,00	-	2726	3135
						60	2700	800	5220	2760	1,25	150,00	40,80	-	2956	3399
11377	2880	0400	XXXX	YYYY	-0000	64	2880	400	3136	1664	1,24	89,60	23,04	-	2174	2500
						64	2880	500	3456	1984	1,25	108,80	28,16	-	2415	2777
						64	2880	600	4352	2304	1,25	128,00	33,28	-	2655	3053
						64	2880	700	4992	2624	1,25	140,80	38,40	-	2900	3335
11377	3060	0400	XXXX	YYYY	-0000	68	3060	400	3332	1768	1,24	95,20	24,48	-	2297	2642
						68	3060	500	3672	2108	1,25	115,60	29,92	-	2555	2938
						68	3060	600	4624	2448	1,25	136,00	35,36	-	2814	3236
						68	3060	700	5304	2788	1,25	149,60	40,80	-	3072	3533

In conformity with EN442-1: 2014: radiators and convectors

For heat outputs in other regimes, see p. 320 (correction factors)
EXPORT. Prices in Euro (excl. VAT)

TULIPA-A FREE-STANDING INSTALLATION
IN OPTION

PRICE GROUP: VPG10 - ACC.



FREE-STANDING INSTALLATION		COLOUR	REF. NR.	€	
FIXED FOOT		TV1-A / TH1-A			
		150 mm (no lateral support)	RAL 9016	*	71
			COLOUR	*	82
		TV2-A / TH2-A			
		150 mm (no lateral support)	RAL 9016	*	143
			COLOUR	*	164

- Additional wall mounting support necessary for height radiator > 600 mm (included).
- Please indicate code **-0006** for "Finish" when ordering (fixed foot included in the price).
- No rosettes available.

	TV1-A / TV2-A	TH1-A / TH2-A		
length radiator (mm)		540 - 1440	1620 - 2340	> 2340
number of feet	2x	2x	3x	4x

EXPORT. Prices in Euro (excl. VAT)

PRICE GROUP: VPG10 - ACC.

ACCESSORIES		COLOUR	REF. NR.	€
THERMOSTATIC HEAD		TV1-A / TV2-A		
		WHITE	11911630102	44
THERMOSTATIC HEAD		TV1-A / TV2-A		
		CHROME	11911631102	63

PRICE GROUP: VPG10B - TOWEL RAILS

ACCESSORIES	WIDTH TOWEL RAIL	COLOUR	REF. NR.	€	
TOWEL RAIL		TV1-A / TV2-A / TH1-A / TH2-A			
		500 mm	CHROME	1183 269 0000 0099	145
		500 mm	RAL 9016	1183 269 0000 9016	145
		500 mm	RAL 9005 ^M	1183 269 0000 9005	145

- h = 55 mm; b = 500 mm; d = 58 mm; a = 43 mm;

^M matt black

Mounting instructions accessories: see www.vasco.eu
EXPORT. Prices in Euro (excl. VAT)

d = distance front of the accessory up to front of the radiator
a = distance accessory up to the radiator
available from stock

TULIPA-A CONNECTIONS

TULIPA-A VERTICAL: TV1-A / TV2-A (STOCK)

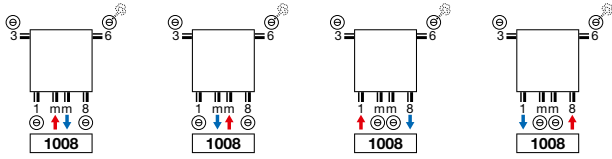

TULIPA-A HORIZONTAL: TH1-A / TH2-A (NON STOCK)

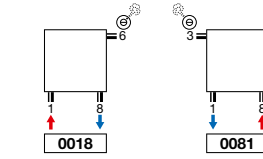

TULIPA-A VERTICAL: TV1-A / TV2-A (NON STOCK)

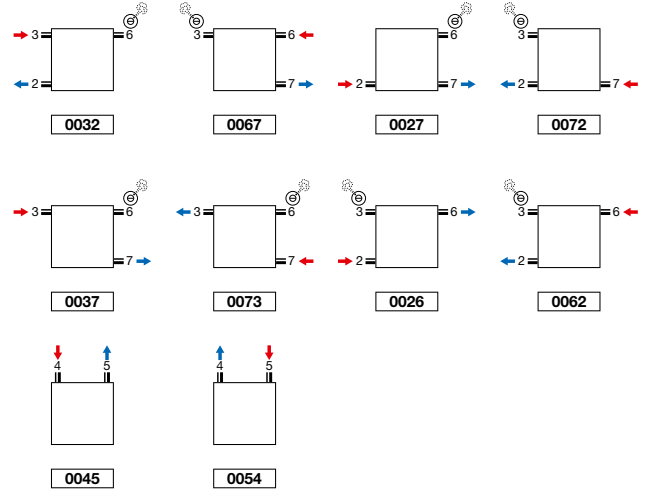
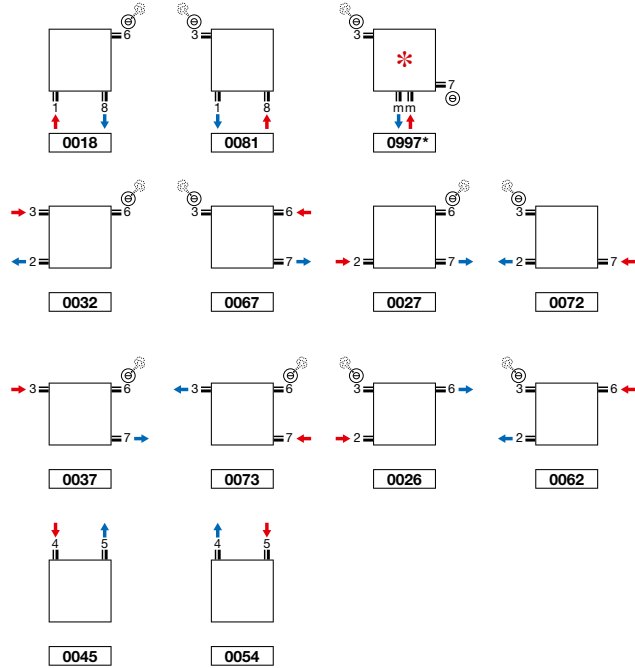

- * Connection 0997: inlet has to be on the right side!
- Tulipa-A 6 and 8 tubes: connection 1mm8, 18, 81 not possible

Attention: connecting the radiator can only be as shown by the connecting icons. For any other connection method, we take no responsibility.

TULIPA-A VERTICAL (TV1-A, TV2-A)

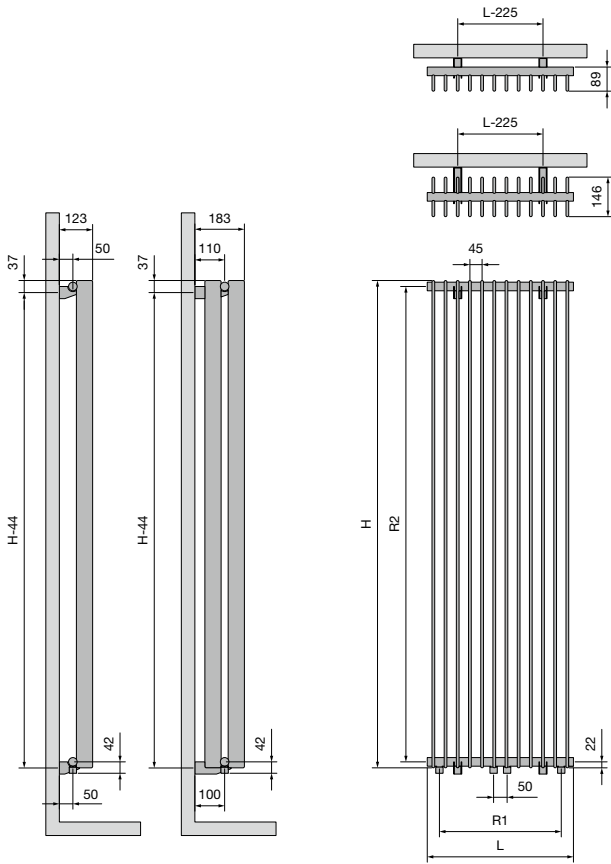

TV1-A / TV2-A

	Width (L)	270	360	450	540	630	720	810	900	990	1080	1170	1260
	Centre between the connections at the bottom 18 (R1)	180	270	360	450	540	630	720	810	900	990	1080	1170
	Height (H)	1000	1200	1500	1600	1800	2000	2200	2500	3000			
	Centre between the lateral connections 23/67 (R2)	956	1156	1456	1556	1756	1956	2156	2456	2956			
	Centre between the brackets	H-44											

TULIPA-A HORIZONTAL (TH1-A, TH2-A)

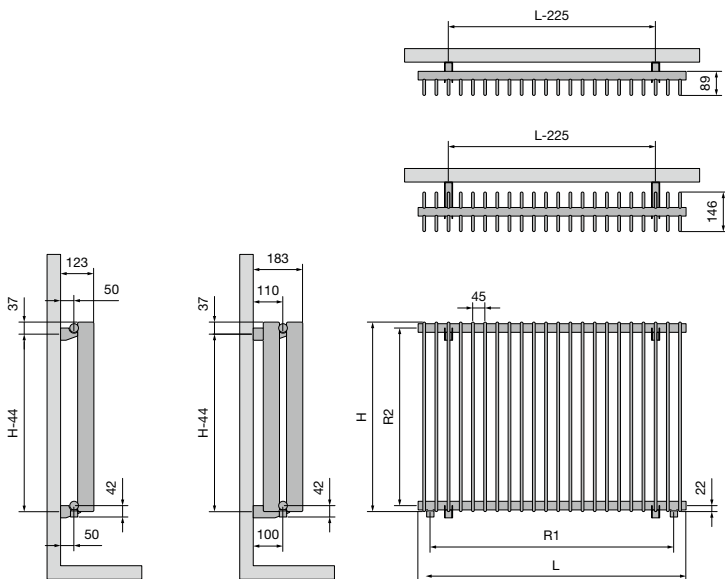

TH1-A / TH2-A

	Width (L)	540	630	720	810	900	990	1080	1170	1260	1440	1620	1800	1980	2160	2340	2520	2700	2880	3060	
	Centre between the connections at the bottom 18 (R1)	450	540	630	720	810	900	990	1080	1170	1350	1530	1710	1890	2070	2250	2430	2610	2790	2970	
	Height (H)	400	500	600	700	800	900														
	Centre between the lateral connections 23/67 (R2)	356	456	556	656	756	856														
	Centre between the brackets	H-44																			