

Staal designradiatoren



VASCO staalradiatoren verenigen een optimaal eigentijds warmtecomfort met een doordachte, tijdloze vormgeving.

Elke collectie is een unieke demonstratie van warmte op haar efficiëntst én op haar mooist.

Op maat van elke woonruimte. Geschikt voor elke toepassing. Stuk voor stuk meesterwerkjes van technisch vernuft en creativiteit, bekroond met vele internationale designprijzen.

Ervaren technici, innovatieve ontwerpers en wetenschappelijke specialisten creëren samen oplossingen waarin de details het verschil maken.

Staalradiatoren die zich steeds weer onderscheiden door hun zuivere vormgeving en gebruiksgemak.

Staal designradiatoren

Niva	140
Niva Ventilo-Convactor	150
Carré	160
Arche	177
Zana	183
Viola-A	196
Tulipa-A	230

NIVA LAK VERTICAAL (N1L1, N2L1)



TYPES

- Enkel (N1L1) en dubbel (N2L1)

KLEUREN

- Standaardkleur S600 (witte fijn structuurlak) (RAL 9016: geen meerprijs 15%)
- Uitgebreide kleurenkaart zie p. 12

SPECIAAL

- De Niva Lak Verticaal is beschikbaar met een gelakte voorplaat (dwz. plaatradiator + gelakte voorplaat).

BEVESTIGINGEN

- Muurbevestigingen in de kleur RAL 7016 (antraciet grijs) standaard. Ook in optie verkrijgbaar in de kleur S600 (zie p. 152).

TECHNISCH

- Elektrisch weerstandsgelast (onzichtbare lasnaden) en rolnaadgelast
- KTL-grondlaag, poedercoating
- Standaardwerkdruk: 10 bar
- Maximale bedrijfstemperatuur: 110°C

ELEKTRISCH (beschikbare uitvoeringen: zie hoofdstuk elektrische radiatoren)

- ✓ Zuiver elektrische radiator (zie p. 62)
- ✓ Gemengde radiator (zie p. 92)

TECHNISCHE TEKENINGEN

- Zie p. 156

AANSLUITING

- ✗ Eénpuntsaansluiting voor éénpijpsysteem
- ✗ Eénpuntsaansluiting voor tweepijpsysteem
- ✓ Tweepuntsaansluiting voor éénpijpsysteem (aansluiting via de middenaansluiting) (zie p. 340)
- ✓ Tweepuntsaansluiting voor tweepijpsysteem (standaard) (zie p. 340)
- ✗ Geïntegreerd ventiel
- Aansluitingen: 1/2" (binnendraad)

NIVA LAK VERTICAAL

Puur technische klasse, puur design, puur sfeer

De ultracompacte, gestyleerde Niva is nog steeds een stichtend voorbeeld voor heel wat ontwerpers en collega-producenten. Eén en al functionaliteit door de optimale luchtdoorstroming en de extra hoge warmteafgifte die meteen op gang komt. Eén en al design door de integere, zuivere vormgeving, het zwevend karakter –dankzij de achterliggende, onzichtbare ophanging- en de organisch geïntegreerde handdoekbeugel.

AANBEVOLEN AANSLUITING (LB)

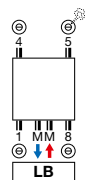

Andere aansluitmogelijkheden, zie p. 155

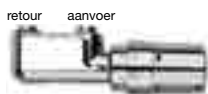

art. nr. 1182 103 0000 0099

prijs € 175

Koppelingen, zie p. 353

AANBEVOLEN VOOR BADKAMER EN KEUKEN IN OPTIE



handdoekbeugel (chrom) N1L1 art. nr. zie p. 153

prijs € 185

N2L1 art. nr. zie p. 153

prijs € 185

Andere accessoires, zie p. 153



HOE NIVA LAK VERTICAAL BESTELLEN

Leveringstermijn 15 - 30 werkdagen
(zonder transportduur)

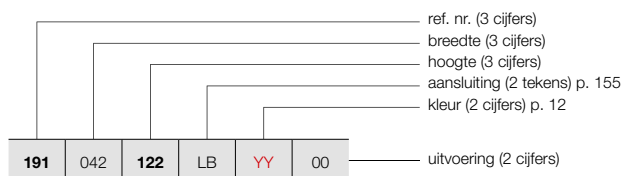

NIVA LAK VERTICAAL (N1L1, N2L1)



N1L1

N2L1

HOE VOORRAADRADIATOR NIVA LAK VERTICAAL BESTELLEN

Leveringstermijn 5 werkdagen
(zonder transportduur)

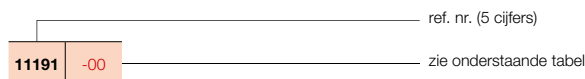

PRIJSGROEP: VPG2 - STAAL DESIGNRADIATOREN

BESTELCODE MAATWERK NIVA LAK VERTICAAL	TECHNISCHE GEGEVENS									STANDAARDKLEUR		ANDERE KLEUREN	
	buizen	breedte (L mm)	hoogte (H mm)	75/65/20 (Watt) (Φ50K)	55/45/20 (Watt) (Φ30K)	n-exp.	gewicht (kg)	inhoud (l)	el. weerst. (Watt)	prijs S600* (€)	verkorte ref. nr. S600 voorraad	prijs kleur (€)	verkorte ref. nr. M301 voorraad
REF. NR. NIVA LAK VERTICAAL N1L1 : 191													
191 042 122 LB YY 00	-	420	1220	645	337	1,27	18,10	2,55	-	564	11191-02	649	-
	-	420	1820	934	486	1,28	27,35	3,70	-	657	11191-03	756	11191-05
	-	420	2020	1023	532	1,28	30,20	4,00	-	694	11191-06	798	-
	-	420	2220	1070	559	1,27	33,20	4,50	-	753	-	866	-
191 052 122 LB YY 00	-	520	1220	815	424	1,28	21,97	3,32	-	635	11191-21	730	-
	-	520	1820	1128	587	1,28	33,67	4,61	-	740	11191-16	851	11191-01
	-	520	2020	1257	654	1,28	37,12	5,05	-	782	11191-22	899	-
	-	520	2220	1310	681	1,28	40,88	5,57	-	848	-	975	-
191 062 122 LB YY 00	-	620	1220	985	510	1,29	25,83	3,85	-	662	11191-07	761	-
	-	620	1820	1322	687	1,28	39,98	5,52	-	768	11191-17	883	11191-04
	-	620	2020	1490	775	1,28	44,03	6,10	-	818	11191-20	941	-
	-	620	2220	1550	806	1,28	48,57	6,63	-	886	-	1019	-
191 072 182 LB YY 00	-	720	1820	1515	784	1,29	46,30	6,43	-	801	11191-08	921	-
	-	720	2020	1724	897	1,28	50,95	7,15	-	851	11191-09	979	-
	-	720	2220	1790	926	1,29	56,25	7,70	-	927	-	1066	-
REF. NR. NIVA LAK VERTICAAL N2L1 : 192													
192 042 122 LB YY 00	-	420	1220	988	506	1,31	26,50	4,90	-	846	-	973	-
	-	420	1820	1330	681	1,31	42,23	7,28	-	984	11192-02	1132	-
	-	420	2020	1438	736	1,31	46,75	8,00	-	1020	11192-04	1173	-
	-	420	2220	1543	823	1,23	51,40	8,90	-	1088	-	1251	-
192 052 122 LB YY 00	-	520	1220	1213	621	1,31	33,00	6,48	-	953	11192-05	1096	-
	-	520	1820	1633	836	1,31	51,68	9,07	-	1105	11192-31	1271	-
	-	520	2020	1764	903	1,31	57,23	10,00	-	1147	11192-32	1319	-
	-	520	2220	1893	995	1,26	62,73	11,00	-	1224	-	1408	-
192 062 122 LB YY 00	-	620	1220	1437	732	1,32	39,50	7,02	-	989	11192-37	1137	-
	-	620	1820	1935	991	1,31	61,14	10,86	-	1147	11192-33	1319	-
	-	620	2020	2091	1071	1,31	67,72	12,00	-	1199	11192-34	1379	-
	-	620	2220	2243	1160	1,29	74,07	13,10	-	1278	11192-39	1470	-
192 072 182 LB YY 00	-	720	1820	2237	1146	1,31	70,60	12,65	-	1199	11192-07	1379	-
	-	720	2020	2417	1238	1,31	78,20	14,00	-	1252	11192-35	1440	-
	-	720	2220	2594	1322	1,32	85,40	15,20	-	1335	11192-36	1535	-

Conform EN442-1: 2014: radiatoren en convectoren

* RAL 9016: geen meerprijs 15%

Voor meer details over onze artikel-data, zie artikel-database: <https://www.2ba.nl>

Voor de warmteafgiftes van andere regimes, kijkt u op p. 346 (correctiefactoren)
NETERLAND. Prijzen in euro (excl. BTW)

NIVA INOX VERTICAAL (N1L1-ES, N2L1-ES)



TYPES

- Enkel (N1L1-ES) en dubbel (N2L1-ES)

KLEUREN

- Inox / RVS type 316L, mat geborsteld met korrel 360

SPECIAAL

- De Niva Inox Verticaal is beschikbaar met een inox voorplaat (dwz. stalen plaatradiator + inox-voorplaat).
- De Niva Inox Verticaal is te reinigen met een inox cleaner.

BEVESTIGINGEN

- Muurbevestigingen in de kleur RAL 7016 (antraciet grijs) standaard. Ook in optie verkrijgbaar in de kleur S600 (zie p. 152).

TECHNISCH

- Elektrisch weerstandsgelast (onzichtbare lasnaden) en rolnaadgelast
- Standaardwerkdruk: 10 bar
- Maximale bedrijfstemperatuur: 110°C

ELEKTRISCH

- ✗ Zuiver elektrische radiator
- ✗ Gemengde radiator

TECHNISCHE TEKENINGEN

- Zie p. 156

AANSLUITING

- ✗ Eénpuntsaansluiting voor éénpijpsysteem
- ✗ Eénpuntsaansluiting voor tweepijpsysteem
- ✓ Tweepuntsaansluiting voor éénpijpsysteem (aansluiting via de middenaansluiting) (zie p. 340)
- ✓ Tweepuntsaansluiting voor tweepijpsysteem (standaard) (zie p. 340)
- ✗ Geïntegreerd ventiel
- Aansluitingen: 1/2" (binnendraad)

NIVA INOX VERTICAAL

Pure klasse in al haar pracht

De Niva Inox Verticaal combineert een stalen plaatradiator met een inox voorplaat, die de integere, zuivere vormgeving en het zwevende karakter van de Niva letterlijk 'extra glans' geeft. De Niva Inox Verticaal designradiator is ook leverbaar met organisch geïntegreerde inox handdoekbeugel (in optie).

AANBEVOLEN AANSLUITING (LB)

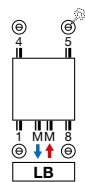

Andere aansluitmogelijkheden, zie p. 155

AANBEVOLEN VOOR BADKAMER EN KEUKEN IN OPTIE



handdoekbeugel (chrom) N1L1 art. nr. zie p. 153
prijs €185

N2L1 art. nr. zie p. 153
prijs €185

Andere accessoires, zie p. 153



HOE NIVA INOX VERTICAAL BESTELLEN

Leveringstermijn 15 - 30 werkdagen
(zonder transportduur)

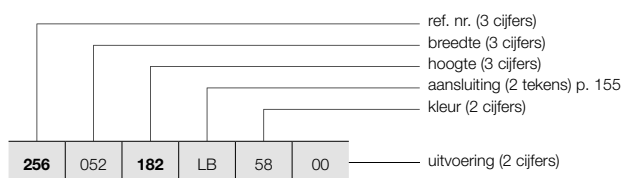

NIVA INOX VERTICAAL (N1L1-ES, N2L1-ES)

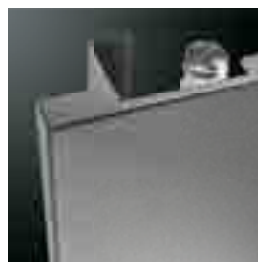

N1L1-ES



N2L1-ES

PRIJSGROEP: VPG2 - STAAL DESIGNRADIATOREN

BESTELCODE MAATWERK NIVA INOX VERTICAAL	TECHNISCHE GEGEVENS									STANDAARDKLEUR					
	buizen	breedte (L mm)	hoogte (H mm)	75/65/20 (Watt) (Φ50K)	55/45/20 (Watt) (Φ30K)	n-exp.	gewicht (kg)	inhoud (l)	el. weerst. (Watt)	prijs inox (€)					
REF. NR. NIVA INOX VERTICAAL N1L1-ES : 256															
256	052	182	LB	58	00	-	520	1820	1128	587	1,28	33,67	4,61	-	1329
		202				-	520	2020	1257	654	1,28	37,12	5,05	-	1409
256	062	182	LB	58	00	-	620	1820	1322	687	1,28	39,98	5,52	-	1381
		202				-	620	2020	1490	775	1,28	44,03	6,10	-	1471
REF. NR. NIVA INOX VERTICAAL N2L1-ES : 257															
257	052	182	LB	58	00	-	520	1820	1633	836	1,31	51,68	9,07	-	1990
		202				-	520	2020	1764	903	1,31	57,23	10,00	-	2067
257	062	182	LB	58	00	-	620	1820	1935	991	1,31	61,14	10,86	-	2068
		202				-	620	2020	2091	1071	1,31	67,72	12,00	-	2157

Conform EN442-1: 2014: radiatoren en convectoren

Voor meer details over onze artikel-data, zie artikel-database: <https://www.2ba.nl>

Voor de warmteafgiftes van andere regimes, kijkt u op p. 346 (correctiefactoren)
NEDERLAND. Prijzen in euro (excl. BTW)

NIVA LAK HORIZONTAAL (NH1L1, NH2L1, NH2L2)

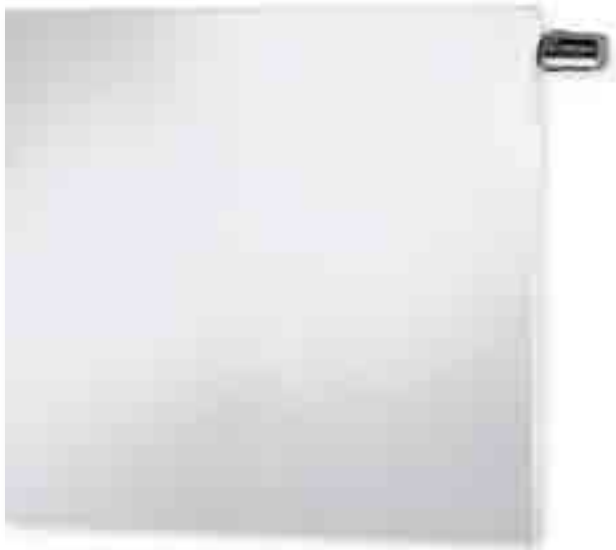

GEÏNTEGREERD VENTIEL

NIVA LAK HORIZONTAAL

- Radiator in wit: thermostaatkop in wit standaard, in de prijs inbegrepen
- Radiator in kleur: thermostaatkop in chroom standaard, in de prijs inbegrepen



TYPES

- NH1L1, NH2L1, NH2L2

KLEUREN

- Standaardkleur S600 (witte fijn structuurlak) (RAL 9016: geen meerprijs 15%)
- Uitgebreide kleurenkaart zie p. 12

SPECIAAL

- De Niva Lak Horizontaal is verkrijgbaar met 1 (NH1L1, NH2L1) of 2 rijen (NH2L2) lamellen ter verhoging van de warmteafgifte.
- NH1L1 ook verkrijgbaar als toiletradiator (520 x 450 mm)

BEVESTIGINGEN

- Muurbevestigingen in de kleur RAL 7016 (antraciet grijs) standaard. Ook in optie verkrijgbaar in de kleur S600 (zie p. 152).

TECHNISCH

- Elektrisch weerstandsgelast (onzichtbare lasnaden) en rolnaadgelast
- KTL-grondlaag, poedercoating
- Standaardwerkdruk: 10 bar
- Maximale bedrijfstemperatuur: 110°C

ELEKTRISCH

- ✗ Zuiver elektrische radiator
- ✗ Gemengde radiator

TECHNISCHE TEKENINGEN

- Zie p. 157

AANSLUITING

- ✗ Eénpuntsaansluiting voor éénpijpssysteem
- ✗ Eénpuntsaansluiting voor tweepijpssysteem
- ✓ Tweepuntsaansluiting voor éénpijpssysteem (aansluiting via het geïntegreerd ventiel) (zie p. 341)
- ✓ Tweepuntsaansluiting voor tweepijpssysteem (standaard) (zie p. 340)
- ✓ Geïntegreerd ventiel (**geen meerprijs**) (zie p. 341)
- Aansluitingen: 4x½" zijdelings (binnendraad), 2x¾" Euroconus (50mm rechtsonder)

NIVA LAK HORIZONTAAL

Pure klasse in al haar eenvoud

Ook in de horizontale versie is en blijft de Niva een toonbeeld van efficiënte toegepaste vormgeving. Een geslaagde combinatie van functionaliteit en design, met de keuze uit 1 of 2 lamellen voor een aangepaste warmteafgifte, ook beschikbaar in toiletversie. Met optionele handdoekbeugel in chroomuitvoering.

AANBEVOLEN AANSLUITING (VR) GEÏNTEGREERD VENTIEL

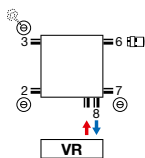

Andere aansluitmogelijkheden, zie p. 155



art. nr. 1182 300 0000 0099

prijs € 159

Koppelingen, zie p. 353

AANBEVOLEN VOOR BADKAMER EN KEUKEN IN OPTIE



handdoekbeugel (chroom)

art. nr. zie p. 153

prijs € 185



HOE NIVA LAK HORIZONTAAL BESTELLEN

Leveringstermijn 15 - 30 werkdagen
(zonder transportduur)

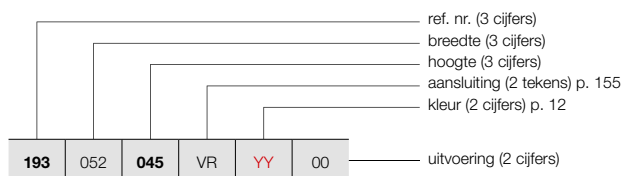

NIVA LAK HORIZONTAAL (NH1L1, NH2L1, NH2L2)



NH1L1 / NH2L1

HOE VOORRAADRADIATOR NIVA LAK HORIZONTAAL BESTELLEN

Leveringstermijn 5 werkdagen
(zonder transportduur)

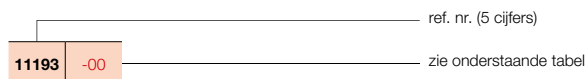

PRIJSGROEP: VPG2 - STAAL DESIGNRADIATOREN

BESTELCODE MAATWERK NIVA LAK HORIZONTAAL	TECHNISCHE GEGEVENS							STANDAARDKLEUR		ANDERE KLEUREN		
	buizen	breedte (L mm)	hoogte (H mm)	75/65/20 (Watt) (Φ50K)	55/45/20 (Watt) (Φ30K)	n-exp.	gewicht (kg)	inhoud (l)	el. weerst. (Watt)		prijs S600* (€)	verkorte ref. nr. S600 voorraad
REF. NR. NIVA LAK HORIZONTAAL NH1L1 : 193												
193 052 045 VR YY 00	-	520	450	301	158	1,26	7,50	1,19	-	477	11193-01	549
193 062 055 065 VR YY 00	-	620	550	425	223	1,26	11,11	1,66	-	529	-	608
	-	620	650	490	256	1,27	13,28	1,92	-	625	-	719
193 082 055 065 VR YY 00	-	820	550	562	295	1,26	14,69	2,20	-	616	-	708
	-	820	650	649	339	1,27	17,56	2,53	-	710	-	817
193 102 055 065 095 VR YY 00	-	1020	550	699	367	1,26	18,28	2,73	-	700	-	805
	-	1020	650	807	422	1,27	21,85	3,15	-	797	-	917
	-	1020	950	1124	585	1,28	31,85	4,40	-	950	-	1093
193 122 055 065 095 VR YY 00	-	1220	550	836	439	1,26	21,86	3,27	-	783	-	900
	-	1220	650	965	504	1,27	26,13	3,77	-	882	-	1014
	-	1220	950	1344	699	1,28	38,10	5,26	-	1037	-	1193
REF. NR. NIVA LAK HORIZONTAAL NH2L1 : 194												
194 062 055 065 VR YY 00	-	620	550	611	318	1,28	17,25	3,27	-	735	-	845
	-	620	650	708	370	1,27	20,70	3,83	-	882	-	1014
194 082 055 065 VR YY 00	-	820	550	809	421	1,28	22,81	4,32	-	826	-	950
	-	820	650	936	489	1,27	27,37	5,07	-	977	-	1124
194 102 055 065 095 VR YY 00	-	1020	550	1006	523	1,28	28,38	5,38	-	922	-	1060
	-	1020	650	1165	609	1,27	34,05	6,30	-	1070	11194-23	1231
	-	1020	950	1630	839	1,30	50,20	9,05	-	1273	-	1464
194 122 055 065 095 VR YY 00	-	1220	550	1203	626	1,28	33,94	6,43	-	1018	-	1171
	-	1220	650	1393	728	1,27	40,72	7,54	-	1169	-	1344
	-	1220	950	1950	1004	1,30	60,05	10,82	-	1377	-	1584
194 142 055 065 VR YY 00	-	1420	550	1400	728	1,28	39,50	7,48	-	1185	-	1363
	-	1420	650	1622	848	1,27	47,40	8,78	-	1360	-	1564
194 162 055 065 VR YY 00	-	1620	550	1597	830	1,28	45,07	8,54	-	1352	-	1555
	-	1620	650	1850	967	1,27	54,08	10,01	-	1549	-	1781

Conform EN442-1: 2014: radiatoren en convectoren

* RAL 9016: geen meerprijs 15%

Voor meer details over onze artikel-data, zie artikel-database: <https://www.2ba.nl>

Voor de warmteafgiftes van andere regimes, kijkt u op p. 346 (correctiefactoren)
NEDERLAND. Prijzen in euro (excl. BTW)

NIVA LAK HORIZONTAAL (NH2L2)



NH2L2

HOE NIVA LAK HORIZONTAAL BESTELLEN

Leveringstermijn 15 - 30 werkdagen
(zonder transportduur)

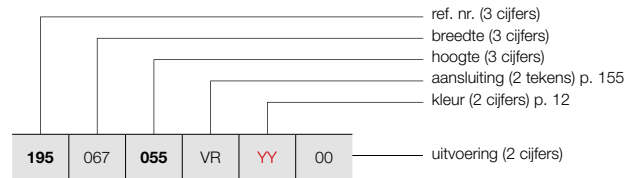

HOE VOORRAADRADIATOR NIVA LAK HORIZONTAAL BESTELLEN

Leveringstermijn 5 werkdagen
(zonder transportduur)

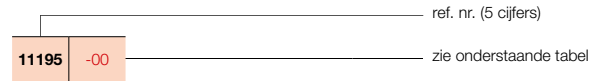

PRIJSGROEP: VPG2 - STAAL DESIGNRADIATOREN

BESTELCODE MAATWERK NIVA LAK HORIZONTAAL	TECHNISCHE GEGEVENS									STANDAARDKLEUR		ANDERE KLEUREN prijs kleur (€)
	buizen	breedte (L mm)	hoogte (H mm)	75/65/20 (Watt Ø50K)	55/45/20 (Watt Ø30K)	n-exp.	gewicht (kg)	inhoud (l)	el. weerst. (Watt)	prijs S600* (€)	verkorte ref. nr. S600 voorraad	
REF. NR. NIVA LAK HORIZONTAAL NH2L2 : 195												
195 067 055 VR YY 00	-	678	550	804	416	1,29	20,50	3,40	-	903	-	1038
065	-	678	650	941	487	1,29	24,28	3,93	-	1018	-	1171
195 087 055 VR YY 00	-	878	550	1041	539	1,29	26,55	4,40	-	1030	-	1185
065	-	878	650	1219	631	1,29	31,44	5,09	-	1145	-	1317
195 107 055 VR YY 00	-	1078	550	1279	662	1,29	32,60	5,40	-	1159	-	1333
065	-	1078	650	1496	774	1,29	38,60	6,25	-	1275	11195-16	1466
095	-	1078	950	2027	1043	1,30	57,90	9,00	-	1483	-	1705
195 127 055 VR YY 00	-	1278	550	1516	784	1,29	38,65	6,40	-	1283	-	1475
065	-	1278	650	1774	918	1,29	45,77	7,41	-	1401	-	1611
095	-	1278	950	2403	1237	1,30	68,64	10,67	-	1610	-	1852
195 147 055 VR YY 00	-	1478	550	1753	907	1,29	44,69	7,40	-	1484	-	1707
065	-	1478	650	2051	1061	1,29	52,93	8,57	-	1620	-	1863
195 167 055 VR YY 00	-	1678	550	1990	1030	1,29	50,74	8,41	-	1686	-	1939
065	-	1678	650	2329	1205	1,29	60,09	9,73	-	1837	-	2113

Conform EN442-1: 2014: radiatoren en convectoren

* RAL 9016: geen meerprijs 15%
Voor meer details over onze artikel-data, zie artikel-database: <https://www.2ba.nl>
Voor de warmteafgiftes van andere regimes, kijkt u op p. 346 (correctiefactoren)
NEDERLAND. Prijzen in euro (excl. BTW)

TYPES

- Enkel (NS1L1) en dubbel (NS2L1)

KLEUREN

- Standaardkleur S600 (witte fijn structuurlak) (RAL 9016: geen meerprijs 15%)
- Uitgebreide kleurenkaart zie p. 12

SPECIAAL

- De Niva Soft Verticaal is beschikbaar met een gelakte voorplaat (dwz. stalen plaatradiator + gelakte voorplaat).
- Vlakke voorplaat en afgeronde zijkanen als hedendaagse troef
- Thermostaatkop op deurknophoogte in optie (niet bij NS1L1) (zie p. 341).



BEVESTIGINGEN

- Muurbevestigingen in de kleur RAL 7016 (antraciet grijs) standaard. Ook in optie verkrijgbaar in de kleur S600 (zie p. 152).

TECHNISCH

- Elektrisch weerstandsgelast (onzichtbare lasnaden) en rolnaadgelast
- KTL-grondlaag, poedercoating
- Standaardwerkdruk: 10 bar
- Maximale bedrijfstemperatuur: 110°C

ELEKTRISCH

- ✗ Zuiver elektrische radiator
- ✗ Gemengde radiator

TECHNISCHE TEKENINGEN

- Zie p. 158

AANSLUITING

- ✗ Eénpuntsaansluiting voor éénpijpsysteem
- ✗ Eénpuntsaansluiting voor tweepijpsysteem
- ✓ Tweepuntsaansluiting voor éénpijpsysteem (aansluiting via de middenaansluiting) (zie p. 340)
- ✓ Tweepuntsaansluiting voor tweepijpsysteem (standaard) (zie p. 340)
- ✓ Geïntegreerd ventiel (**meerprijs €157**) (niet bij NS1L1) (zie p. 341)
- Aansluitingen: 1/2" (binnendraad)

AANBEVOLEN AANSLUITING NS1L1/NS2L1 (LB)

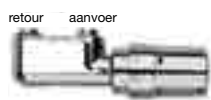
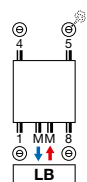

art. nr. 1182 103 0000 0099
prijs € 175
 Koppelingen, zie p. 353

AANBEVOLEN VOOR BADKAMER EN KEUKEN IN OPTIE



handdoekbeugel (aluminium)
 NS1L1 art. nr. zie p. 153
prijs € 185

NS2L1 art. nr. zie p. 153
prijs € 185

Andere accessoires, zie p. 153

OPTIE: AANSLUITING NS2L1 (VR) GEÏNTEGREERD VENTIEL (MEERPRIJS)

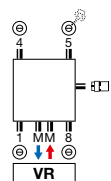

art. nr. 1182 301 0000 0099
prijs € 159
 Koppelingen, zie p. 353

Meerprijs: €157 (zie p. 341)

Andere aansluitmogelijkheden, zie p. 155



NIVA SOFT VERTICAAL

Pure klasse in al haar creativiteit

De Niva in al zijn compacte, gestyleerde eenvoud, maar nu in een uitvoering met zacht afgeronde zijkanen. Een designradiator die uitstekend tot zijn recht komt zowel in een minimalistisch interieur als in een eigentijdse retro-omgeving. Leverbaar met thermostaatkop op deurknophoogte.



NIVA SOFT VERTICAAL (NS1L1, NS2L1)

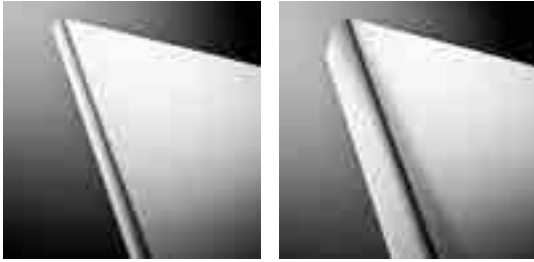

NS1L1

NS2L1

HOE NIVA SOFT BESTELLEN

Leveringstermijn 15 - 30 werkdagen
(zonder transportduur)

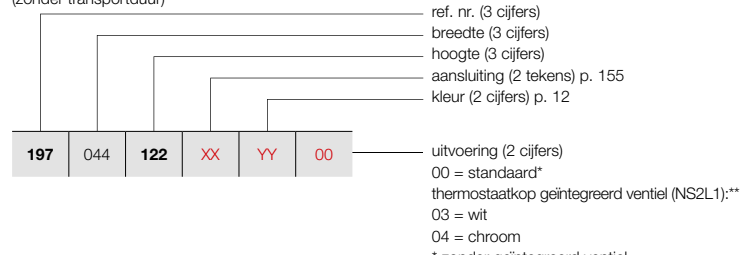

HOE VOORRAADRADIATOR NIVA SOFT BESTELLEN

Leveringstermijn 5 werkdagen
(zonder transportduur)

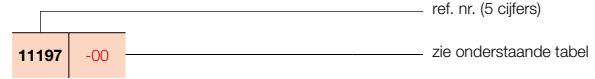

PRIJSGROEP: VPG2 - STAAL DESIGNRADIATOREN

BESTELCODE MAATWERK NIVA SOFT VERTICAAL	TECHNISCHE GEGEVENS									STANDAARDKLEUR		ANDERE KLEUREN prijs kleur (€)					
	buizen	breedte (L mm)	hoogte (H mm)	75/65/20 (Watt) (Φ50K)	55/45/20 (Watt) (Φ30K)	n-exp.	gewicht (kg)	inhoud (l)	el. weerst. (Watt)	prijs S600* (€)	verkorte ref. nr. S600 voorraad						
REF. NR. NIVA SOFT VERTICAAL NS1L1 : 197																	
197	044	122	XX	YY	00	-	440	1220	645	337	1,27	18,10	2,55	-	564	11197-06	649
		182				-	440	1820	934	486	1,28	27,35	3,70	-	657	11197-07	756
		202				-	440	2020	1023	532	1,28	30,20	4,00	-	694	11197-08	798
		222				-	440	2220	1070	559	1,27	33,20	4,50	-	753	-	866
197	054	122	XX	YY	00	-	540	1220	815	424	1,28	21,97	3,32	-	635	11197-04	730
		182				-	540	1820	1128	587	1,28	33,67	4,61	-	740	11197-01	851
		202				-	540	2020	1257	654	1,28	37,12	5,05	-	782	11197-05	899
		222				-	540	2220	1310	681	1,28	40,88	5,57	-	848	-	975
197	064	122	XX	YY	00	-	640	1220	985	510	1,29	25,83	3,85	-	662	11197-09	761
		182				-	640	1820	1322	687	1,28	39,98	5,52	-	768	11197-02	883
		202				-	640	2020	1490	775	1,28	44,03	6,10	-	818	11197-03	941
		222				-	640	2220	1550	806	1,28	48,57	6,63	-	886	-	1019
197	074	182	XX	YY	00	-	740	1820	1515	784	1,29	46,30	6,43	-	801	11197-10	921
		202				-	740	2020	1724	897	1,28	50,95	7,15	-	851	11197-11	979
		222				-	740	2220	1790	926	1,29	56,25	7,70	-	927	-	1066
REF. NR. NIVA SOFT VERTICAAL NS2L1 : 198																	
198	044	122	XX	YY	00	-	440	1220	988	506	1,31	28,40	4,90	-	846	-	973
		182				-	440	1820	1330	681	1,31	42,23	7,28	-	984	11198-08	1132
		202				-	440	2020	1438	736	1,31	46,75	8,00	-	1020	11198-09	1173
		222				-	440	2220	1543	823	1,23	51,40	8,90	-	1088	-	1251
198	054	122	XX	YY	00	-	540	1220	1213	621	1,31	36,83	6,48	-	953	11198-10	1096
		182				-	540	1820	1633	836	1,31	51,68	9,07	-	1105	11198-01	1271
		202				-	540	2020	1764	903	1,31	57,23	10,00	-	1147	11198-02	1319
		222				-	540	2220	1893	995	1,26	62,73	11,00	-	1224	-	1408
198	064	122	XX	YY	00	-	640	1220	1437	732	1,32	38,17	7,02	-	989	-	1137
		182				-	640	1820	1935	991	1,31	61,14	10,86	-	1147	11198-03	1319
		202				-	640	2020	2091	1071	1,31	67,72	12,00	-	1199	11198-04	1379
		222				-	640	2220	2243	1160	1,29	74,07	13,10	-	1278	-	1470
198	074	182	XX	YY	00	-	740	1820	2237	1146	1,31	70,60	12,65	-	1199	11198-11	1379
		202				-	740	2020	2417	1238	1,31	78,20	14,00	-	1252	11198-05	1440
		222				-	740	2220	2594	1322	1,32	85,40	15,20	-	1335	-	1535

Conform EN442-1: 2014: radiatoren en convectoren

* RAL 9016: geen meerprijs 15%

Voor meer details over onze artikel-data, zie artikel-database: <https://www.2ba.nl>

Voor de warmteafgiftes van andere regimes, kijkt u op p. 346 (correctiefactoren)
NEDERLAND. Prijzen in euro (excl. BTW)

NIVA

VENTILO CONVECTOR

verwarmen &
koelen



verwarmen & koelen

De warmtepomp wint jaar na jaar terrein in nieuwe en bestaande woningen. Specialisten zijn het er dan ook over eens: dit is dé energiebron van de toekomst. De eindgebruiker profiteert twee keer. Want met een warmtepomp kan hij niet alleen energie-efficiënt verwarmen, maar ook koelen. Zeker in combinatie met de gloednieuwe Niva Ventilo-Convector van VASCO! Een ventilo-convector is een warmtewisselaar met lamellen waarbij een geïntegreerde ventilator warme of koele lucht de ruimte in brengt. Dit systeem, dat werkt op lage watertemperaturen van 30 tot 40°C, is zeer interessant in combinatie met een warmtepomp. De ventilo-convector kan in alle ruimtes van de woning toegepast worden, maar vormt vooral in de slaapkamer een absolute meerwaarde, omdat we daar behoefte hebben aan zowel verwarming als aan koeling. De ventilo-convector verwarmt of koelt de ruimte in korte tijd van 18 naar 22°C of van 28 naar 24°C. Bij toepassing van koeling worden er watertemperaturen gebruikt van 7 tot 12°C.

Dé oplossing tijdens koele winters en warme zomers!

-  **de ideale 2-in-1 oplossing**
in sneltempo de gewenste temperatuur
-  **ideaal in combinatie met warmtepomp**
koeling enkel mogelijk met warmtepomp met koelfunctie
-  **voor lage watertemperatuursystemen**
-  **fluïsterstille werking**
-  **met modulerende ventilator-regeling**
-  **met koper/aluminium warmtewisselaar**
-  **energie-efficiënte werking**
-  **touch display met intuïtieve bediening**
-  **overschilderbaar**

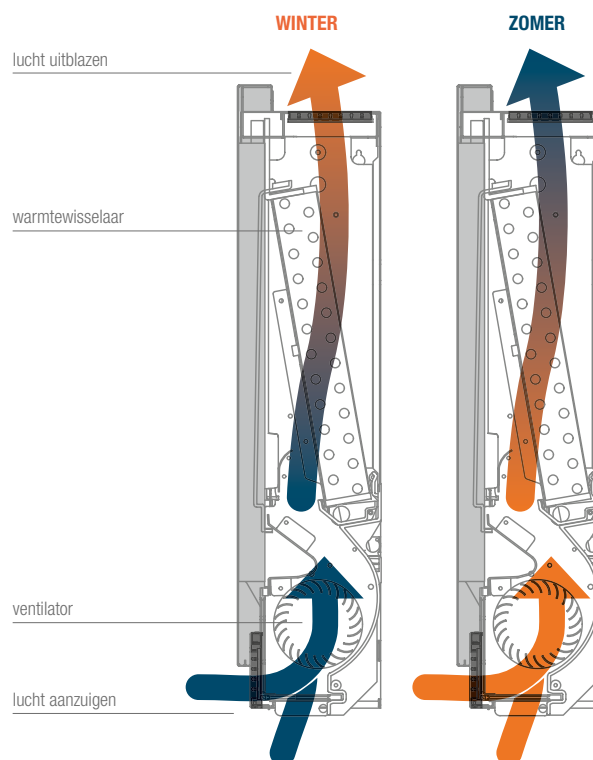

2-IN-1

De Niva ventilo-convector brengt iedere ruimte in uw woning op de gewenste comforttemperatuur. De convector warmt bij koud weer snel op en zorgt bij warme dagen voor de nodige verkoeling!



PRIJSGROEP: VPG8 - VENILO

TECHNISCHE GEGEVENS						STANDAARDKLEUR	
breedte (L mm)	hoogte (H mm)	45/40/20 (Watt)	35/30/20 (Watt)	gewicht (kg)	inhoud (l)	prijs S600 (€)	verkorte ref. nr. S600
TYPE: FC75							
750	610	1018	536	18,00	0,47	1248	11600-01
TYPE: FC95							
950	610	2205	1165	21,00	0,80	1367	11600-02
TYPE: FC115							
1150	610	3013	1639	24,00	1,13	1470	11600-03

Conform EN442-1: 2014: radiatoren en convectoren
 Voor meer details over onze artikel-data, zie artikel-database: <https://www.2ba.nl>
Voor de warmteafgiftes van andere regimes, kijkt u op p. 346 (correctiefactoren)
NEDERLAND. Prijzen in euro (excl. BTW)

TECHNISCHE GEGEVENS

		FC75	FC95	FC115
Algemene gegevens				
Verwarmingsvermogen bij	W	1018	2205	3013
Waterdebiet	l/h	146	294	438
Drukverlies	kPA	9,10	9,20	19,00
Verwarmingsvermogen bij 35/30/20°C	W	536	1165	1639
Totaal koelvermogen bij 7/12/27°C 50% RV	W	955	2222	2914
Voelbaar koelvermogen	W	683	1483	2043
Waterdebiet	l/h	164	381	499
Drukverlies	kPA	13,20	8,90	18,30
Maximale werkdruk	bar	10	10	10
Hydraulische aansluiting		3/4" EK	3/4" EK	3/4" EK
Ventilator gegevens				
Maximaal luchtdebiet	m ³ /h	146	294	438
Medium luchtdebiet	m ³ /h	91	210	318
Minimum luchtdebiet	m ³ /h	49	124	194
Elektrische gegevens				
Voedingsspanning	V/ph/Hz	230/1/50	230/1/50	230/1/50
Maximaal opgenomen vermogen	W	11	19	20
Maximale opgenomen stroom	A	0,11	0,16	0,19
Opgenomen vermogen bij minimum snelheid	W	5	4	6
Geluidsgegevens				
Geluidsdruk bij maximaal luchtdebiet *	dB(A)	41	42	44
Geluidsdruk bij medium luchtdebiet *	dB(A)	33	34	34
Geluidsdruk bij minimum luchtdebiet *	dB(A)	24	25	26
Geluidsdruk bij maximale snelheid *	dB(A)	54	53	54

* Gemeten op 1 meter afstand volgens ISO 7779







BEVESTIGINGEN		HOOGTE RADIATOR	KLEUR	ART. NR.
		N1L1 / N1L1-ES / NS1L1*		
MUURBEVESTIGING		1220 mm	S600	1187 104 1100 0600
		1820 mm	S600	1187 104 1700 0600
		2020 mm	S600	1187 104 1900 0600
		2220 mm	S600	1187 104 2100 0600
		N2L1 / N2L1-ES / NS2L1		
MUURBEVESTIGING		1220 mm	S600	1187 105 1100 0600
		1820 mm	S600	1187 105 1700 0600
		2020 mm	S600	1187 105 1900 0600
		2220 mm	S600	1187 105 2100 0600
		NH1L1		
MUURBEVESTIGING		450 mm	S600	1187 102 0400 0600
		550 mm	S600	1187 102 0500 0600
		650 mm	S600	1187 102 0600 0600
		950 mm	S600	1187 102 0900 0600
		NH2L1 / NH2L2		
MUURBEVESTIGING		550 mm	S600	1187 103 0500 0600
		650 mm	S600	1187 103 0600 0600
		950 mm	S600	1187 103 0900 0600

Prijzen: zie prijslijst "spare parts"

* niet beschikbaar voor NS1L1 met geïntegreerd ventiel





PRIJSGROEP: VPG10B - HANDDOEKBEUGELS

ACCESSOIRES	BREEDTE HANDDOEKBEUGEL	KLEUR	ART. NR.	€
HANDDOEKBEUGEL MULTI+ RECHTS 	N1L1 / N2L1 / N1L1-ES / N2L1-ES / NS1L1 / NS2L1			
	600 mm	S600	1183 734 0000 0600	201
	600 mm	RAL 9005 ^S	1183 734 0000 9005	201
<ul style="list-style-type: none"> • h = 70 mm; b = 600 mm (b tablet = 194 mm); e = 176 mm; c = 170 mm; • Bevestiging aan de muur, rechts van de radiator. 				
HANDDOEKBEUGEL MULTI+ LINKS 	N1L1 / N2L1 / N1L1-ES / N2L1-ES / NS1L1 / NS2L1			
	600 mm	S600	1183 735 0000 0600	201
	600 mm	RAL 9005 ^S	1183 735 0000 9005	201
<ul style="list-style-type: none"> • h = 70 mm; b = 600 mm (b tablet = 194 mm); e = 176 mm; c = 170 mm; • Bevestiging aan de muur, links van de radiator. 				
KORTE BEUGEL 	N1L1 / N1L1-ES / NS1L1			
	240 mm	S600	1183 710 0000 0600	133
	240 mm	RAL 9005 ^S	1183 710 0000 9005	133
	N2L1 / N2L1-ES / NS2L1			
	240 mm	S600	1183 720 0000 0600	133
	240 mm	RAL 9005 ^S	1183 720 0000 9005	133
<ul style="list-style-type: none"> • N1L1 / N1L1-ES: d = 66,5 mm; a = 56,5 mm • NS1L1: d = 68 mm; a = 58 mm • N2L1 / N2L1-ES: d = 59,5 mm; a = 49,5 mm • NS2L1: d = 58 mm; a = 48 mm 				
LANGE BEUGEL 	N1L1 / N1L1-ES / NS1L1			
	440 mm	S600	1183 711 0000 0600	133
	440 mm	RAL 9005 ^S	1183 711 0000 9005	133
	N2L1 / N2L1-ES / NS2L1			
	440 mm	S600	1183 721 0000 0600	133
	440 mm	RAL 9005 ^S	1183 721 0000 9005	133
<ul style="list-style-type: none"> • N1L1 / N1L1-ES: d = 66,5 mm; a = 56,5 mm • NS1L1: d = 68 mm; a = 58 mm • N2L1 / N2L1-ES: d = 59,5 mm; a = 49,5 mm • NS2L1: d = 58 mm; a = 48 mm 				

^S structuur zwart

**Montagevoorschriften accessoires: zie www.vasco.eu
NEDERLAND. Prijzen in euro (excl. BTW)**

e = afstand voorkant accessoire tot wand
d = afstand voorkant accessoire tot voorkant radiator
c = afstand wand tot achterkant beugel
a = afstand accessoire tot radiator
uit voorraad leverbaar

ACCESSOIRES	BREEDTE HANDDOEKBEUGEL	KLEUR	ART. NR.	€	
HANDDOEKBEUGEL 	N1L1 / N1L1-ES / NS1L1				
	372 mm	ALUMINIUM	1183 239 0000 0000	185	
	372 mm	UITLOPEND KOPER	1183 239 0000 0029	185	
	372 mm	CHROOM	1183 239 0000 0099	185	
	372 mm	S600	1183 239 0000 0600	185	
	372 mm	RAL 9005 ^M	1183 239 0000 9005	185	
	526 mm	CHROOM	1183 271 0000 0099	185	
	526 mm	S600	1183 271 0000 0600	185	
	526 mm	RAL 9005 ^M	1183 271 0000 9005	185	
<ul style="list-style-type: none"> Handdoekbeugel in geanodiseerd aluminium h = 55 mm; b = 372, 526 mm; d = 56 mm; a = 50 mm; 					
HANDDOEKBEUGEL 	N2L1 / N2L1-ES / NS2L1				
	372 mm	ALUMINIUM	1183 240 0000 0000	185	
	372 mm	UITLOPEND KOPER	1183 240 0000 0029	185	
	372 mm	CHROOM	1183 240 0000 0099	185	
	372 mm	S600	1183 240 0000 0600	185	
	372 mm	RAL 9005 ^M	1183 240 0000 9005	185	
	526 mm	CHROOM	1183 272 0000 0099	185	
	526 mm	S600	1183 272 0000 0600	185	
	526 mm	RAL 9005 ^M	1183 272 0000 9005	185	
<ul style="list-style-type: none"> Handdoekbeugel in geanodiseerd aluminium h = 55 mm; b = 372, 526 mm; d = 56 mm; a = 50 mm; 					
HANDDOEKBEUGEL 	BREEDTE RADIATOR	KLEUR	ART. NR.	€	
	N1L1 / N1L1-ES				
	420 mm	CHROOM	1183 213 0000 0099	185	
	520 mm	CHROOM	1183 214 0000 0099	185	
	520 mm	INOX/RVS	1183 214 0000 9993	185	
	620 mm	CHROOM	1183 215 0000 0099	185	
	620 mm	INOX/RVS	1183 215 0000 9993	185	
	720 mm	CHROOM	1183 216 0000 0099	185	
	<ul style="list-style-type: none"> h = 25 mm; b = 440, 540, 640, 740 mm; d = 73 mm; a = 57 mm 				
	HANDDOEKBEUGEL 	N2L1 / N2L1-ES			
		420 mm	CHROOM	1183 218 0000 0099	185
		520 mm	CHROOM	1183 219 0000 0099	185
		520 mm	UITLOPEND INOX/RVS	1183 219 0000 9993	185
		620 mm	CHROOM	1183 220 0000 0099	185
		620 mm	UITLOPEND INOX/RVS	1183 220 0000 9993	185
720 mm		CHROOM	1183 221 0000 0099	185	
<ul style="list-style-type: none"> h = 25 mm; b = 440, 540, 640, 740 mm; d = 73 mm; a = 57 mm 					
HANDDOEKBEUGEL 	NH1L1 / NH2L1 / NH2L2				
		CHROOM	1183 217 0000 0099	185	
<ul style="list-style-type: none"> h = 25 mm; b = 740 mm (zelf in te korten); d = 73 mm; a = 57 mm 					

^M mat zwart

Montagevoorschriften accessoires: zie www.vasco.eu
 NEDERLAND. Prijzen in euro (excl. BTW)

d = afstand voorkant accessoire tot voorkant radiator
 a = afstand accessoire tot radiator
uit voorraad leverbaar

NIVA LAK VERTICAAL: N1L1 / N2L1

NIVA INOX VERTICAAL: N1L1-ES / N2L1-ES

NIVA SOFT VERTICAAL: NS1L1 / NS2L1 (zonder geïntegreerd ventiel)

NIVA MIXED HYBRIDE: N1L1-EL-MIX

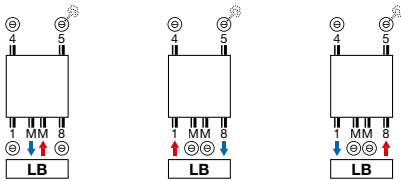

- **Opmerking:** MM met aanvoer rechts.

NIVA SOFT VERTICAAL: NS2L1

GEÏNTEGREERD VENTIEL

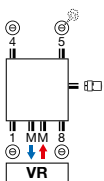

- **Meerprijs:** €157 (zie p. 341)
- **Opmerking:** MM met aanvoer rechts (op deze aansluiting bevindt zich op de achterzijde een stijgbuis).

NIVA LAK HORIZONTAAL: NH1L1 / NH2L1 / NH2L2

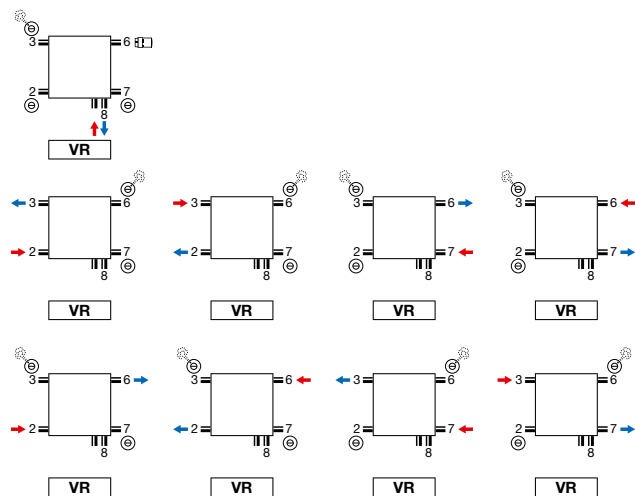

- **Geïntegreerd ventiel:** geen meerprijs (zie p. 341)
- **Thermostaatkop** enkel te gebruiken bij aansluiting op het ventiel (aanvoer links, retour rechts). Andere aansluitingen, vb. SL, thermostaatkop uit de aansluiting 6 nemen. Hier is wel de mogelijkheid om aanvoer en retour te wisselen.

Opmerking: het aansluiten van de radiator kan enkel volgens de getoonde aansluiticonen. Voor elke andere aansluitwijze nemen wij geen verantwoordelijkheid.

NIVA LAK VERTICAAL (N1L1, N2L1)

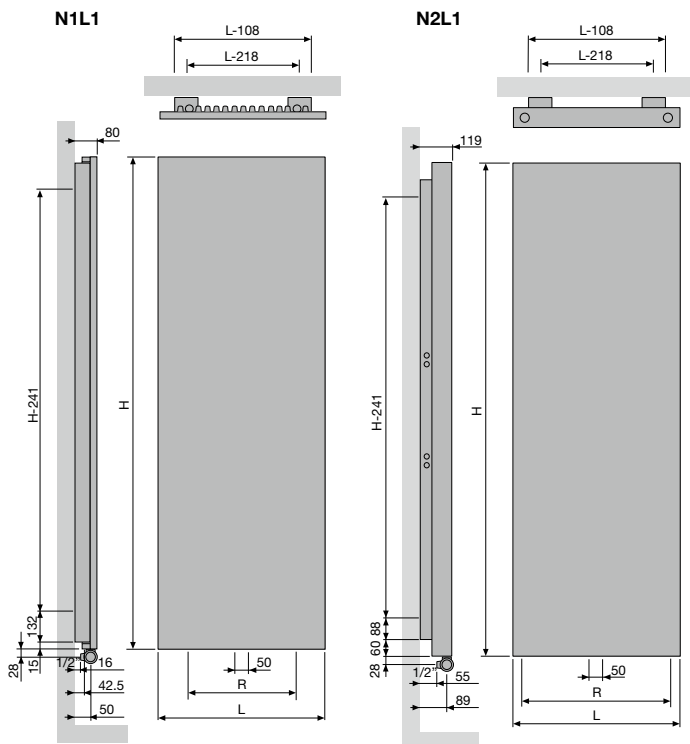

N1L1				
Breedte (L)	420	520	620	720
Hartafstand tussen de onderaansluitingen 18 (R)	200	300	400	500
Hartafstand tussen de ophangingen	L-218	H-241		

N2L1				
Breedte (L)	420	520	620	720
Hartafstand tussen de onderaansluitingen 18 (R)	338	438	538	638
Hartafstand tussen de ophangingen	L-218	H-241		

NIVA INOX VERTICAAL (N1L1-ES, N2L1-ES)

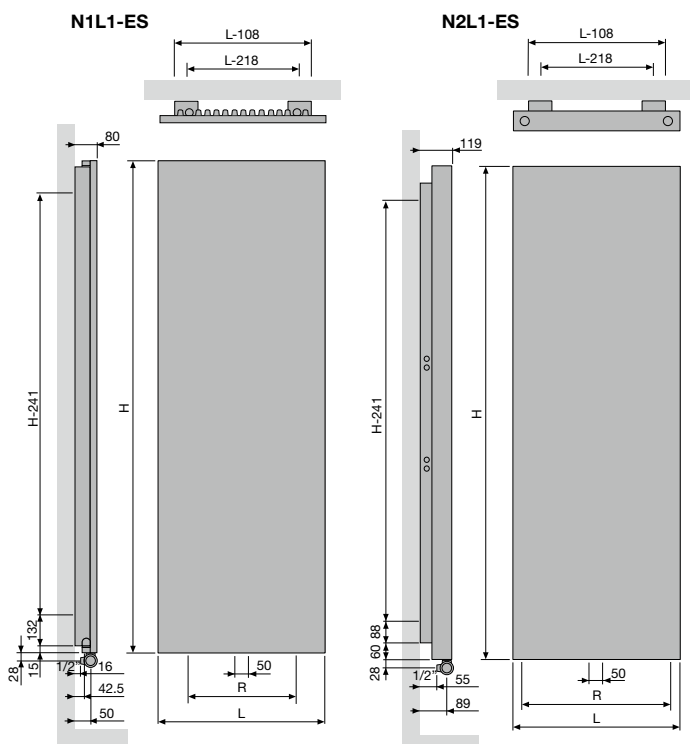

N1L1-ES				
Breedte (L)	520	620		
Hartafstand tussen de onderaansluitingen 18 (R)	300	400		
Hartafstand tussen de ophangingen	L-218	H-241		

N2L1-ES				
Breedte (L)	520	620		
Hartafstand tussen de onderaansluitingen 18 (R)	438	538		
Hartafstand tussen de ophangingen	L-218	H-241		

NIVA LAK HORIZONTAAL (NH1L1, NH2L1)

NH1L1 / NH2L1

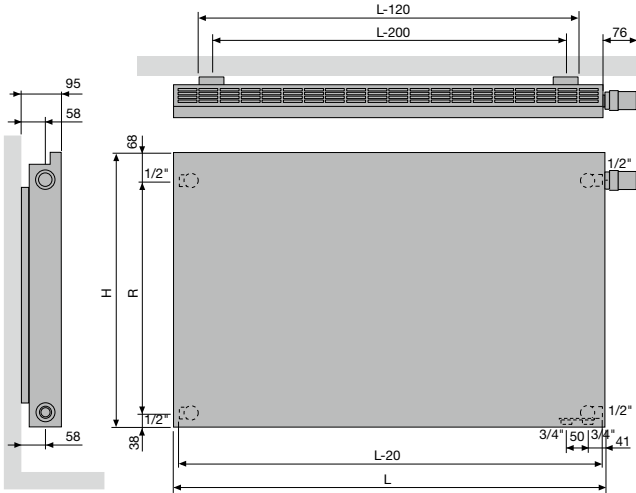

NH1L1				
hoogte (H)	450	550	650	950
Hartafstand tussen de zijaansluitingen SL/SR (R)	343	443	543	843
Hartafstand tussen de ophangingen	L-200			

NH2L1			
hoogte (H)	550	650	950
Hartafstand tussen de zijaansluitingen SL/SR (R)	443	543	843
Hartafstand tussen de ophangingen	L-200		

NIVA LAK HORIZONTAAL (NH2L2)

NH2L2

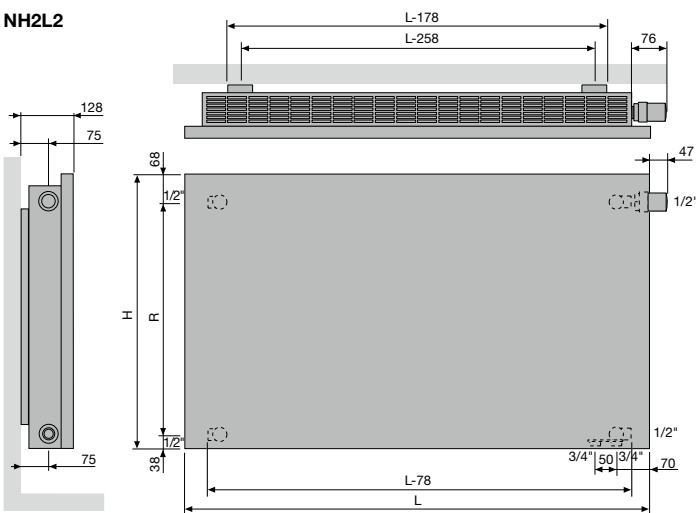

NH2L2			
hoogte (H)	550	650	950
Hartafstand tussen de zijaansluitingen SL/SR (R)	443	543	843
Hartafstand tussen de ophangingen	L-258		

NIVA SOFT VERTICAAL (NS1L1)

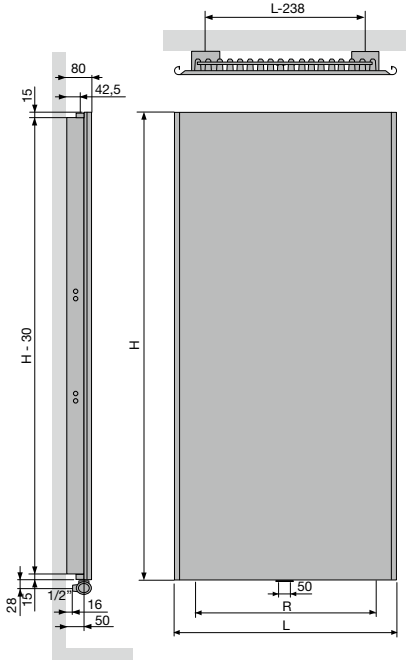

NS1L1				
Breedte (L)	440	540	640	740
Hartafstand tussen de onderaansluitingen 18 (R)	200	300	400	500
Hartafstand tussen de ophangingen	L-238	H-241		

NIVA SOFT VERTICAAL (NS2L1)

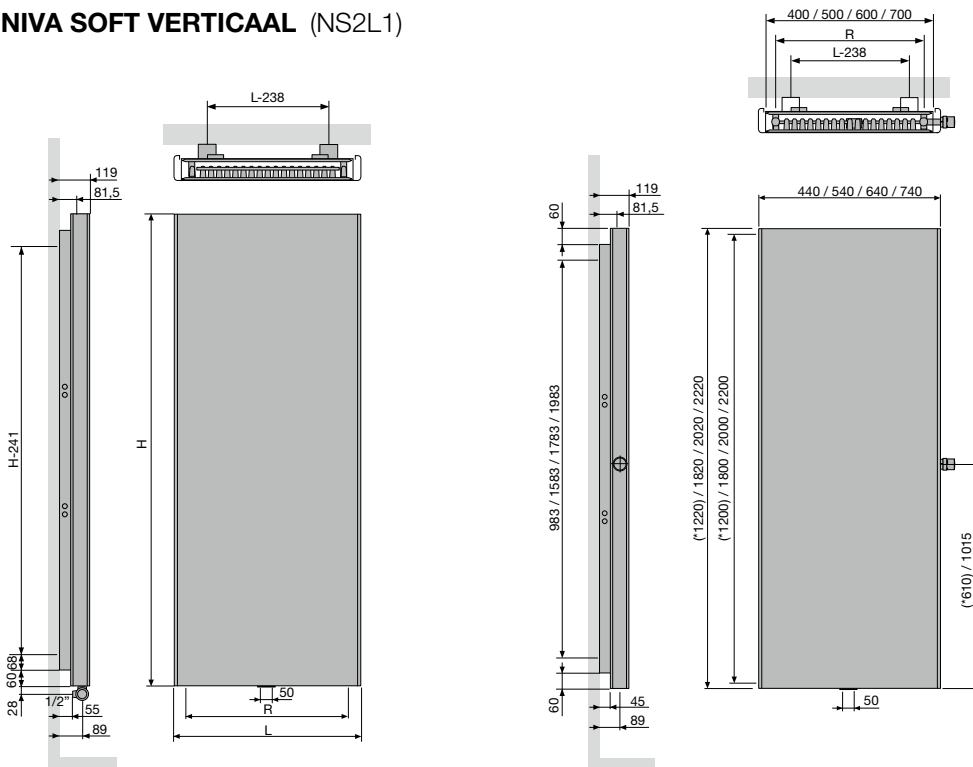

NS2L1				
Breedte (L)	440	540	640	740
Hartafstand tussen de onderaansluitingen 18 (R)	338	438	538	638
Hartafstand tussen de ophangingen	L-238	H-241		

NIVA VENTILO

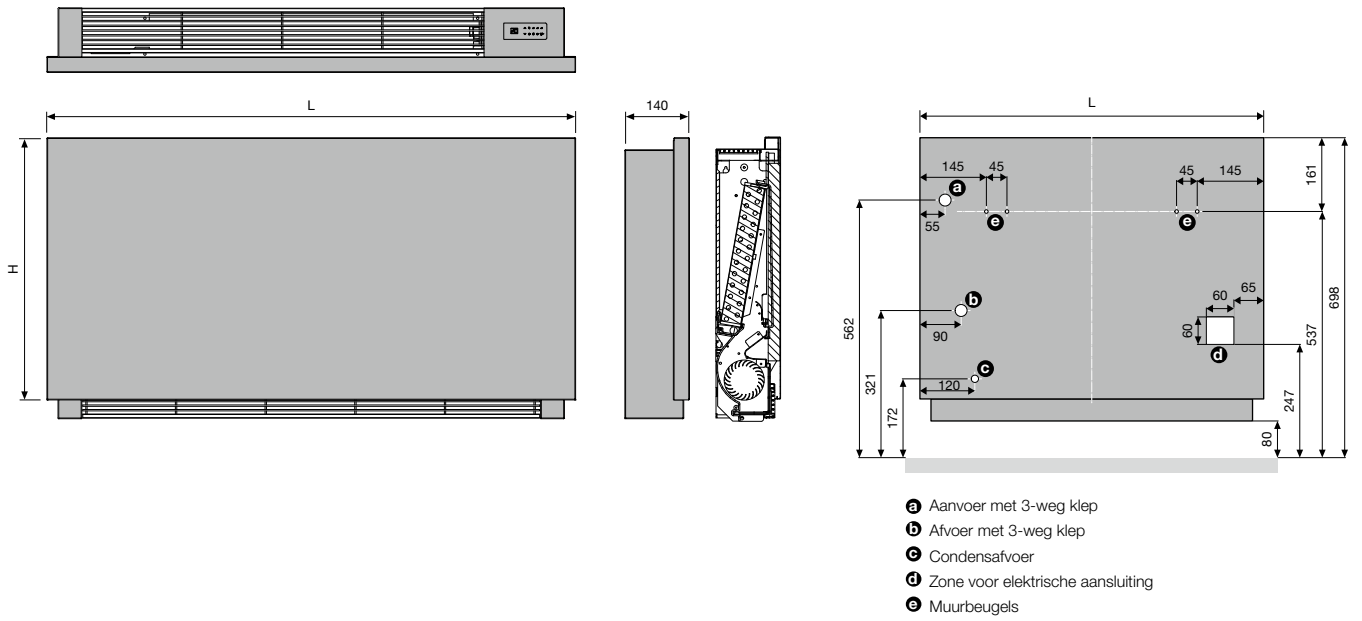

CARRÉ PLUS VERTICAAL (CPVN-PLUS)



TYPES

- Verticaal: Carré Plus (CPVN-PLUS)

BUIZEN

- Verticaal, vierkant 25 x 25 mm

COLLECTOREN

- Horizontaal, rond Ø 35 mm

KLEUREN

- Standaardkleur wit RAL 9016
- Uitgebreide kleurenkaart zie p. 12

BEVESTIGINGEN

- Muurbevestigingen standaard

TECHNISCH

- Weerstandsgelast (onzichtbare lasnaden)
- KTL-grondlaag, poedercoating
- Standaardwerkdruk: 10 bar
- Maximale bedrijfstemperatuur: 110°C

ELEKTRISCH

- ✗ Zuiver elektrische radiator in de fabriek vorgevuld
- ✗ Gemengde radiator

TECHNISCHE TEKENINGEN

- Zie p. 175

AANSLUITING

- ✗ Eénpuntsaansluiting voor éénpijpssysteem
- ✗ Eénpuntsaansluiting voor tweepijpssysteem
- ✓ Tweepuntsaansluiting voor éénpijpssysteem (aansluiting via de middenaansluiting) (zie p. 340)
- ✓ Tweepuntsaansluiting voor tweepijpssysteem (standaard) (zie p. 340)
- ✗ Geïntegreerd ventiel
- Aansluitingen: ½" (binnendraad)

CARRÉ PLUS VERTICAAL

Minimale tussenruimte, maximaal effect

Een icoon in de wereld van de designradiatoren. Speciaal voor de Carré ontwikkelde VASCO een heel nieuw type buis met scherpe hoeken voor een strakker design en met een optimaal warmerendement bij een minimale tussenruimte. De vlakke look creëert een gevoel van rust, versterkt door de weggewerkte, mooi in het geheel geïntegreerde collector. Een veel gelauwerde designradiator, waarvoor VASCO, zoals steeds, ook de passende accessoires ontwikkelde.

AANBEVOLEN AANSLUITING (LB)

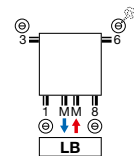

Andere aansluitmogelijkheden, zie p. 174

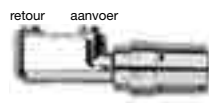

art. nr. 1182 103 0000 0099
prijs € 175
Koppelingen, zie p. 353

AANBEVOLEN VOOR BADKAMER EN KEUKEN IN OPTIE



handdoekbeugel recht (chrom) art. nr. zie p. 173
prijs € 185

Andere accessoires, zie p. 173



HOE CARRÉ PLUS VERTICAAL BESTELLEN

Leveringstermijn 15 - 30 werkdagen
(zonder transportduur)

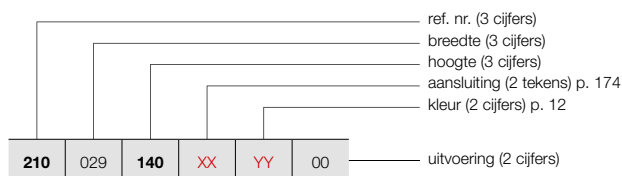

CARRÉ PLUS VERTICAAL (CPVN-PLUS)



CPVN-PLUS

HOE VOORRAADRADIATOR CARRÉ PLUS VERTICAAL BESTELLEN

Leveringstermijn 5 werkdagen
(zonder transportduur)

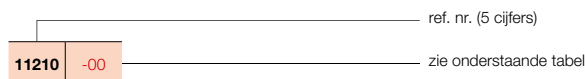

PRIJSGROEP: VPG2 - STAAL DESIGNRADIATOREN

BESTELCODE MAATWERK CARRÉ PLUS VERTICAAL	TECHNISCHE GEGEVENS							STANDAARDKLEUR		ANDERE KLEUREN		
	buizen	breedte (L mm)	hoogte (H mm)	75/65/20 (Watt) (Φ50K)	55/45/20 (Watt) (Φ30K)	n-exp.	gewicht (kg)	inhoud (l)	el. weerst. (Watt)		prijs RAL 9016 (€)	verkorte ref. nr. RAL 9016 voorraad
REF. NR. CARRÉ PLUS VERTICAAL CPVN-PLUS : 210												
210 029 140 XX YY 00	10	295	1400	871	443	1,31	19,70	8,40	-	521	-	599
	10	295	1600	986	505	1,31	21,60	9,40	-	568	-	653
	10	295	1800	1097	559	1,32	23,60	10,50	-	616	-	708
	10	295	2000	1206	614	1,32	26,20	12,00	-	663	-	762
	10	295	2200	1312	672	1,31	28,90	13,50	-	706	-	812
	10	295	2200	1312	672	1,31	28,90	13,50	-	706	-	812
210 035 140 XX YY 00	12	355	1400	1026	521	1,31	23,16	10,08	-	621	-	714
	12	355	1600	1161	595	1,31	25,44	11,28	-	684	-	787
	12	355	1800	1293	659	1,32	27,72	12,48	-	741	11210-16	852
	12	355	2000	1421	724	1,32	30,96	14,40	-	797	-	917
	12	355	2200	1545	791	1,31	34,08	16,20	-	848	-	975
210 041 140 XX YY 00	14	415	1400	1179	599	1,31	26,46	11,76	-	726	-	835
	14	415	1600	1334	683	1,31	29,12	13,16	-	798	-	918
	14	415	1800	1485	757	1,32	31,64	14,56	-	860	-	989
	14	415	2000	1632	836	1,31	35,42	16,66	-	929	11210-05	1068
	14	415	2200	1775	909	1,31	39,20	18,90	-	991	-	1140
210 047 140 XX YY 00	16	475	1400	1330	676	1,31	29,60	13,28	-	833	-	958
	16	475	1600	1505	771	1,31	32,48	14,88	-	912	-	1049
	16	475	1800	1675	853	1,32	35,52	16,48	-	987	-	1135
	16	475	2000	1841	943	1,31	39,84	19,04	-	1061	-	1220
	16	475	2200	2002	1025	1,31	44,00	21,60	-	1133	-	1303
210 053 140 XX YY 00	18	535	1400	1478	751	1,31	32,58	14,94	-	933	-	1073
	18	535	1600	1673	857	1,31	35,82	16,74	-	1024	-	1178
	18	535	1800	1862	954	1,31	39,06	18,54	-	1108	11210-07	1274
	18	535	2000	2046	1048	1,31	43,92	21,42	-	1194	11210-09	1373
	18	535	2200	2226	1140	1,31	48,78	24,30	-	1275	-	1466
210 059 140 XX YY 00	20	595	1400	1625	826	1,31	35,20	16,60	-	1038	-	1194
	20	595	1600	1839	942	1,31	39,00	18,60	-	1137	-	1308
	20	595	1800	2047	1048	1,31	42,60	20,40	-	1231	11210-11	1416
	20	595	2000	2250	1152	1,31	48,00	23,60	-	1325	11210-12	1524
	20	595	2200	2447	1260	1,30	53,40	27,00	-	1414	-	1626
210 065 140 XX YY 00	22	655	1400	1771	900	1,31	37,84	18,26	-	1142	-	1313
	22	655	1600	2004	1026	1,31	41,80	20,24	-	1253	-	1441
	22	655	1800	2231	1143	1,31	45,76	22,44	-	1358	-	1562
	22	655	2000	2451	1255	1,31	51,70	25,96	-	1458	-	1677
	22	655	2200	2666	1372	1,30	57,64	29,48	-	1557	-	1791
210 071 140 XX YY 00	24	715	1400	1915	973	1,31	40,32	19,68	-	1246	-	1433
	24	715	1600	2167	1110	1,31	44,64	22,08	-	1365	-	1570
	24	715	1800	2412	1235	1,31	48,96	24,24	-	1480	-	1702
	24	715	2000	2651	1365	1,30	55,44	28,32	-	1591	-	1830
	24	715	2200	2883	1484	1,30	61,92	32,16	-	1699	-	1954

Conform EN442-1: 2014: radiatoren en convectoren

Voor meer details over onze artikel-data, zie artikel-database: <https://www.2ba.nl>

Voor de warmteafgiftes van andere regimes, kijkt u op p. 346 (correctiefactoren)
NEDERLAND. Prijzen in euro (excl. BTW)

CARRÉ PLUS VERTICAAL (CPVN-PLUS)



CPVN-PLUS

HOE CARRÉ PLUS VERTICAAL BESTELLEN

Leveringstermijn 15 - 30 werkdagen
(zonder transportduur)

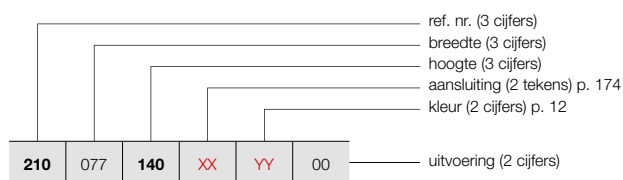

PRIJSGROEP: VPG2 - STAAL DESIGNRADIATOREN

BESTELCODE MAATWERK CARRÉ PLUS VERTICAAL	TECHNISCHE GEGEVENS									STANDAARDKLEUR	ANDERE KLEUREN
	buizen	breedte (L mm)	hoogte (H mm)	75/65/20 (Watt) (Ø50K)	55/45/20 (Watt) (Ø30K)	n-exp.	gewicht (kg)	inhoud (l)	el. weerst. (Watt)	prijs RAL 9016 (€)	prijs kleur (€)
REF. NR. CARRÉ PLUS VERTICAAL CPVN-PLUS : 210											
210	077	140	XX	YY	00						
		160								1351	1554
		180								1480	1702
		200								1604	1845
		220								1726	1985
										1840	2116
210	089	140	XX	YY	00						
		160								1557	1791
		180								1705	1961
		200								1850	2128
		220								1988	2286
										2122	2440

Conform EN442-1: 2014: radiatoren en convectoren

Voor meer details over onze artikel-data, zie artikel-database: <https://www.2ba.nl>

Voor de warmteafgifte van andere regimes, kijkt u op p. 346 (correctiefactoren)
NEDERLAND. Prijzen in euro (excl. BTW)

TYPES

- Twee rijen buizen (CPVN2-ZB)

BUIZEN

- Verticaal, vierkant 25 x 25 mm

COLLECTOREN

- Horizontaal, rond Ø 35 mm

KLEUREN

- Standaardkleur wit RAL 9016
- Uitgebreide kleurenkaart zie p. 12

BEVESTIGINGEN

- Muurbevestigingen in de kleur RAL 9016 standaard. Ook in optie verkrijgbaar in de kleur RAL 7016 (zie p. 173).

TECHNISCH

- Weerstandsgelast (onzichtbare lasnaden)
- KTL-grondlaag, poedercoating
- Standaardwerkdruk: 10 bar
- Maximale bedrijfstemperatuur: 110°C

ELEKTRISCH

- ✗ Zuiver elektrische radiator in de fabriek vorgevuld
- ✗ Gemengde radiator

TECHNISCHE TEKENINGEN

- Zie p. 175

AANSLUITING

- ✗ Eénpuntsaansluiting voor éénpijpsysteem
- ✗ Eénpuntsaansluiting voor tweepijpsysteem
- ✓ Tweepuntsaansluiting voor éénpijpsysteem (aansluiting via de middenaansluiting) (zie p. 340)
- ✓ Tweepuntsaansluiting voor tweepijpsysteem (standaard) (zie p. 340)
- ✗ Geïntegreerd ventiel
- Aansluitingen: ½" (binnendraad)



AANBEVOLEN AANSLUITING (LB)

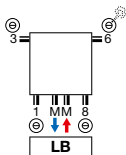

Andere aansluitmogelijkheden, zie p. 174

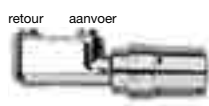

art. nr. 1182 103 0000 0099

prijs € 175

Koppelingen, zie p. 353

**AANBEVOLEN VOOR BADKAMER EN KEUKEN
IN OPTIE**



handdoekbeugel recht (chrom) art. nr. zie p. 173

prijs € 185

Andere accessoires, zie p. 173

CARRÉ VERTICAAL

Topdesign met dubbele warmtecapaciteit

De strakke, vlakke look van de Carré Plus, voorzien van een dubbele buizenrij voor een maximale warmteafgifte. De Carré Verticaal designradiator blijft in alles zijn tijdloze, functionele zelf, maar garandeert door die extra capaciteit ook in grotere ruimten een optimaal rendement.



CARRÉ VERTICAAL (CPVN2-ZB)



CPVN2-ZB

HOE CARRÉ VERTICAAL BESTELLEN

Leveringstermijn 15 - 30 werkdagen
(zonder transportduur)

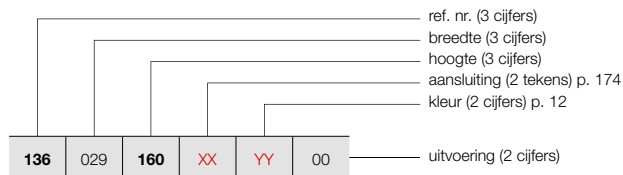

PRIJSGROEP: VPG2 - STAAL DESIGNRADIATOREN

BESTELCODE MAATWERK CARRÉ VERTICAAL	TECHNISCHE GEGEVENS									STANDAARDKLEUR	ANDERE KLEUREN
	buizen	breedte (L mm)	hoogte (H mm)	75/65/20 (Watt) (Φ50K)	55/45/20 (Watt) (Φ30K)	n-exp.	gewicht (kg)	inhoud (l)	el. weerst. (Watt)	prijs RAL 9016 (€)	prijs kleur (€)
REF. NR. CARRÉ VERTICAAL CPVN2-ZB : 136											
136 029 160 XX YY 00	10	295	1600	1062	533	1,35	30,20	15,80	-	912	1049
	10	295	1800	1174	589	1,35	33,80	17,90	-	986	1134
	10	295	2000	1279	642	1,35	37,30	20,10	-	1063	1222
	10	295	2200	1377	691	1,35	40,60	21,30	-	1133	1303
	10	295	2400	1469	737	1,35	43,80	22,60	-	1202	1382
	10	295	2600	1555	780	1,35	47,10	23,90	-	1271	1462
	10	295	2800	1635	820	1,35	50,30	25,10	-	1335	1535
	10	295	3000	1709	858	1,35	53,60	26,40	-	1401	1611
136 035 160 XX YY 00	12	355	1600	1275	640	1,35	36,24	18,96	-	1092	1256
	12	355	1800	1409	707	1,35	40,56	21,48	-	1184	1362
	12	355	2000	1534	770	1,35	44,76	24,12	-	1273	1464
	12	355	2200	1652	829	1,35	48,72	25,56	-	1359	1563
	12	355	2400	1763	885	1,35	52,56	27,12	-	1443	1659
	12	355	2600	1866	936	1,35	56,52	28,68	-	1523	1751
	12	355	2800	1962	984	1,35	60,36	30,12	-	1604	1845
	12	355	3000	2050	1029	1,35	64,32	31,68	-	1684	1937
136 041 160 XX YY 00	14	415	1600	1487	746	1,35	42,28	22,12	-	1277	1469
	14	415	1800	1643	824	1,35	47,32	25,06	-	1379	1586
	14	415	2000	1790	898	1,35	52,22	28,14	-	1486	1709
	14	415	2200	1928	967	1,35	56,84	29,82	-	1587	1825
	14	415	2400	2057	1032	1,35	61,32	31,64	-	1684	1937
	14	415	2600	2177	1092	1,35	65,94	33,46	-	1778	2045
	14	415	2800	2289	1149	1,35	70,42	35,14	-	1871	2152
	14	415	3000	2392	1200	1,35	75,04	36,96	-	1962	2256
136 047 160 XX YY 00	16	475	1600	1700	853	1,35	48,32	25,28	-	1456	1674
	16	475	1800	1878	942	1,35	54,08	28,64	-	1578	1815
	16	475	2000	2046	1027	1,35	59,68	32,16	-	1697	1952
	16	475	2200	2203	1105	1,35	64,96	34,08	-	1810	2082
	16	475	2400	2351	1180	1,35	70,08	36,16	-	1921	2209
	16	475	2600	2488	1248	1,35	75,36	38,24	-	2033	2338
	16	475	2800	2616	1313	1,35	80,48	40,16	-	2136	2456
	16	475	3000	2734	1372	1,35	85,76	42,24	-	2238	2574
136 053 160 XX YY 00	18	535	1600	1912	959	1,35	54,36	28,44	-	1637	1883
	18	535	1800	2113	1060	1,35	60,84	32,22	-	1776	2042
	18	535	2000	2301	1155	1,35	67,14	36,18	-	1908	2194
	18	535	2200	2479	1244	1,35	73,08	38,34	-	2038	2344
	18	535	2400	2644	1327	1,35	78,84	40,68	-	2162	2486
	18	535	2600	2799	1404	1,35	84,78	43,02	-	2283	2625
	18	535	2800	2942	1476	1,35	90,54	45,18	-	2403	2763
	18	535	3000	3075	1543	1,35	96,48	47,52	-	2521	2899

Conform EN442-1: 2014: radiatoren en convectoren

Voor meer details over onze artikel-data, zie artikel-database: <https://www.2ba.nl>

Voor de warmteafgiftes van andere regimes, kijkt u op p. 346 (correctiefactoren)
NEDERLAND. Prijzen in euro (excl. BTW)

HOE CARRÉ VERTICAAL BESTELLEN

Leveringstermijn 15 - 30 werkdagen
(zonder transportduur)

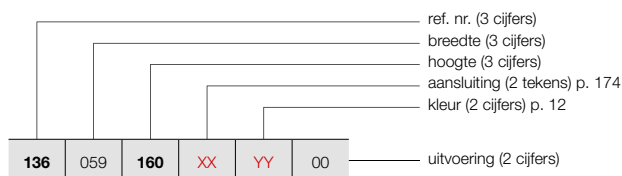

CARRÉ VERTICAAL (CPVN2-ZB)



CPVN2-ZB

PRIJSGROEP: VPG2 - STAAL DESIGNRADIATOREN

BESTELCODE MAATWERK CARRÉ VERTICAAL	TECHNISCHE GEGEVENS							STANDAARDKLEUR	ANDERE KLEUREN							
	buizen	breedte (L mm)	hoogte (H mm)	75/65/20 (Watt) (Φ50K)	55/45/20 (Watt) (Φ30K)	n-exp.	gewicht (kg)			inhoud (l)	el. weerst. (Watt)	prijs RAL 9016 (€)	prijs kleur (€)			
REF. NR. CARRÉ VERTICAAL CPVN2-ZB : 136																
136	059	160	XX	YY	00	20	595	1600	2125	1066	1,35	60,40	31,60	-	1819	2092
		180				20	595	1800	2348	1178	1,35	67,60	35,80	-	1973	2269
		200				20	595	2000	2557	1283	1,35	74,60	40,20	-	2121	2439
		220				20	595	2200	2754	1382	1,35	81,20	42,60	-	2266	2606
		240				20	595	2400	2938	1474	1,35	87,60	45,20	-	2401	2761
		260				20	595	2600	3110	1561	1,35	94,20	47,80	-	2541	2922
		280				20	595	2800	3269	1640	1,35	100,60	50,20	-	2674	3075
		300				20	595	3000	3417	1715	1,35	107,20	52,80	-	2802	3222
136	065	160	XX	YY	00	22	655	1600	2337	1173	1,35	66,44	34,76	-	2001	2301
		180				22	655	1800	2582	1296	1,35	74,36	39,38	-	2171	2497
		200				22	655	2000	2812	1411	1,35	82,06	44,22	-	2332	2682
		220				22	655	2200	3029	1520	1,35	89,32	46,86	-	2494	2868
		240				22	655	2400	3232	1622	1,35	96,36	49,72	-	2644	3041
		260				22	655	2600	3421	1717	1,35	103,62	52,58	-	2791	3210
		280				22	655	2800	3596	1804	1,35	110,66	55,22	-	2939	3380
		300				22	655	3000	3759	1886	1,35	117,92	58,08	-	3082	3544
136	071	160	XX	YY	00	24	715	1600	2550	1280	1,35	72,48	37,92	-	2184	2512
		180				24	715	1800	2817	1413	1,35	81,12	42,96	-	2365	2720
		200				24	715	2000	3069	1540	1,35	89,52	48,24	-	2546	2928
		220				24	715	2200	3305	1658	1,35	97,44	51,12	-	2716	3123
		240				24	715	2400	3526	1769	1,35	105,12	54,24	-	2883	3315
		260				24	715	2600	3732	1873	1,35	113,04	57,36	-	3050	3508
		280				24	715	2800	3923	1968	1,35	120,72	60,24	-	3207	3688
		300				24	715	3000	4101	2058	1,35	128,64	63,36	-	3361	3865
136	077	160	XX	YY	00	26	775	1600	2762	1386	1,35	78,52	41,08	-	2365	2720
		180				26	775	1800	3052	1531	1,35	87,88	46,54	-	2563	2947
		200				26	775	2000	3324	1668	1,35	96,98	52,26	-	2758	3172
		220				26	775	2200	3580	1796	1,35	105,56	55,38	-	2943	3384
		240				26	775	2400	3820	1917	1,35	113,88	58,76	-	3128	3597
		260				26	775	2600	4043	2029	1,35	122,46	62,14	-	3302	3797
		280				26	775	2800	4250	2133	1,35	130,78	65,26	-	3474	3995
		300				26	775	3000	4442	2229	1,35	139,36	68,64	-	3641	4187
136	089	160	XX	YY	00	30	895	1600	3187	1599	1,35	90,60	47,40	-	2730	3140
		180				30	895	1800	3521	1767	1,35	101,40	53,70	-	2958	3402
		200				30	895	2000	3836	1925	1,35	111,90	60,30	-	3183	3660
		220				30	895	2200	4131	2073	1,35	121,80	63,90	-	3396	3905
		240				30	895	2400	4407	2211	1,35	131,40	67,80	-	3607	4148
		260				30	895	2600	4665	2341	1,35	141,30	71,70	-	3809	4380

Conform EN442-1: 2014: radiatoren en convectoren

Voor meer details over onze artikel-data, zie artikel-database: <https://www.2ba.nl>
Voor de warmteafgiftes van andere regimes, kijkt u op p. 346 (correctiefactoren)
NETERLAND. Prijzen in euro (excl. BTW)

CARRÉ HORIZONTAAL (CPHN1-RO, CPHN2-RO)



TYPES

- Eén (CPHN1-RO) of twee rijen buizen (CPHN2-RO)

BUIZEN

- Horizontaal, vierkant 25 x 25 mm

COLLECTOREN

- Verticaal, rond Ø 35 mm

KLEUREN

- Standaardkleur wit RAL 9016
- Uitgebreide kleurenkaart zie p. 12

SPECIAAL

- CPHN1-RO ook verkrijgbaar als toileradiator (600 x 415 mm)

BEVESTIGINGEN

- Muurbevestigingen in de kleur RAL 9016 standaard. Ook in optie verkrijgbaar in de kleur RAL 7016 (zie p. 173).

TECHNISCH

- Weerstandsgelast (onzichtbare lasnaden)
- KTL-grondlaag, poedercoating
- Standaardwerkdruk: 10 bar
- Maximale bedrijfstemperatuur: 110°C

ELEKTRISCH

- ✗ Zuiver elektrische radiator in de fabriek voorgevuld
- ✗ Gemengde radiator

TECHNISCHE TEKENINGEN

- Zie p. 176

AANSLUITING

- ✗ Eénpuntsaansluiting voor éénpijpsysteem
- ✗ Eénpuntsaansluiting voor tweepijpsysteem
- ✗ Tweepuntsaansluiting voor éénpijpsysteem
- ✓ Tweepuntsaansluiting voor tweepijpsysteem (standaard) (zie p. 340)
- ✗ Geïntegreerd ventiel
- Aansluitingen: ½" (binnendraad)

CARRÉ HORIZONTAAL

Topdesign voor elke warmtebehoefte

De horizontale versie van de Carré, met keuze uit één of twee buizenrijen voor een warmteafgifte op maat in elke ruimte. Een designradiator die ook in de horizontale uitvoering uitblinkt door zijn strak design en zijn vlakke look, nog versterkt door de in het geheel geïntegreerde collector.

AANBEVOLEN AANSLUITING (18)

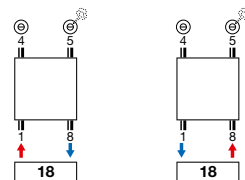

Andere aansluitmogelijkheden, zie p. 174



art. nr. 1182 101 0000 0099

prijs € 215

Koppelingen, zie p. 353

AANBEVOLEN VOOR BADKAMER EN KEUKEN IN OPTIE



handdoekbeugel recht (chrom) art. nr. zie p. 173

prijs € 185

Andere accessoires, zie p. 173



HOE CARRÉ HORIZONTAAL BESTELLEN

Leveringstermijn 15 - 30 werkdagen
(zonder transportduur)

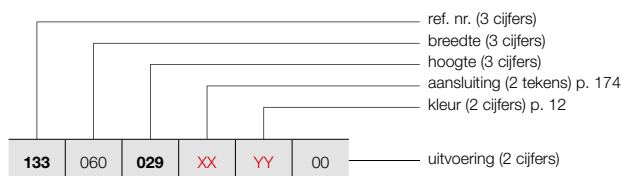

CARRÉ HORIZONTAAL (CPHN1-RO)



CPHN1-RO

PRIJSGROEP: VPG2 - STAAL DESIGNRADIATOREN

BESTELCODE MAATWERK CARRÉ HORIZONTAAL	TECHNISCHE GEGEVENS							STANDAARDKLEUR		ANDERE KLEUREN	
	buizen	breedte (L mm)	hoogte (H mm)	75/65/20 (Watt) (φ50K)	55/45/20 (Watt) (φ30K)	n-exp.	gewicht (kg)	inhoud (l)	el. weerst. (Watt)	prijs RAL 9016 (€)	prijs kleur (€)
REF. NR. CARRÉ HORIZONTAAL CPHN1-RO : 133											
133 060 029 XX YY 00	10	600	295	221	117	1,25	6,19	2,85	-	247	284
	12	600	355	259	137	1,25	7,41	3,60	-	298	343
	14	600	415	296	156	1,25	8,63	4,35	-	348	400
	16	600	475	333	176	1,25	9,86	5,10	-	397	457
	18	600	535	369	195	1,25	11,08	5,85	-	446	513
	20	600	595	404	213	1,25	12,30	6,60	-	499	574
	22	600	655	439	231	1,26	13,42	6,94	-	549	631
	26	600	775	507	266	1,26	15,67	7,63	-	647	744
	30	600	895	574	302	1,26	17,91	8,31	-	745	857
	133 080 029 XX YY 00	10	800	295	295	156	1,25	8,25	3,80	-	301
12		800	355	346	183	1,25	9,88	4,80	-	364	419
14		800	415	395	209	1,25	11,51	5,80	-	427	491
16		800	475	444	234	1,25	13,14	6,80	-	482	554
18		800	535	492	260	1,25	14,77	7,80	-	545	627
20		800	595	538	284	1,25	16,40	8,80	-	607	698
22		800	655	585	307	1,26	17,90	9,26	-	666	766
26		800	775	676	355	1,26	20,89	10,17	-	786	904
30		800	895	766	402	1,26	23,88	11,08	-	908	1044
133 100 029 XX YY 00		10	1000	295	369	195	1,25	10,31	4,75	-	355
	12	1000	355	432	228	1,25	12,35	6,00	-	427	491
	14	1000	415	494	261	1,25	14,39	7,25	-	494	568
	16	1000	475	555	293	1,25	16,43	8,50	-	565	650
	18	1000	535	615	325	1,25	18,46	9,75	-	635	730
	20	1000	595	673	355	1,25	20,50	11,00	-	705	811
	22	1000	655	731	384	1,26	22,37	11,57	-	775	891
	26	1000	775	845	444	1,26	26,11	12,71	-	918	1056
	30	1000	895	957	503	1,26	29,85	13,85	-	1059	1218
	133 120 029 XX YY 00	10	1200	295	443	234	1,25	12,37	5,70	-	399
12		1200	355	518	274	1,25	14,82	7,20	-	478	550
14		1200	415	593	313	1,25	17,27	8,70	-	559	643
16		1200	475	666	352	1,25	19,72	10,20	-	642	738
18		1200	535	738	390	1,25	22,15	11,70	-	721	829
20		1200	595	808	427	1,25	24,60	13,20	-	800	920
22		1200	655	877	461	1,26	26,84	13,88	-	882	1014
26		1200	775	1014	533	1,26	31,33	15,25	-	1041	1197
30		1200	895	1148	603	1,26	35,82	16,62	-	1202	1382
133 140 029 XX YY 00		10	1400	295	517	273	1,25	14,43	6,65	-	444
	12	1400	355	605	319	1,25	17,29	8,40	-	531	611
	14	1400	415	692	365	1,25	20,15	10,15	-	621	714
	16	1400	475	777	410	1,25	23,00	11,90	-	710	817
	18	1400	535	861	455	1,25	25,84	13,65	-	801	921
	20	1400	595	942	497	1,25	28,70	15,40	-	891	1025
	22	1400	655	1023	537	1,26	31,32	16,20	-	980	1127
	26	1400	775	1183	622	1,26	36,55	17,79	-	1159	1333
	30	1400	895	1340	704	1,26	41,79	19,39	-	1334	1534

Conform EN442-1: 2014: radiatoren en convectoren

Voor meer details over onze artikel-data, zie artikel-database: <https://www.2ba.nl>

Voor de warmteafgiftes van andere regimes, kijkt u op p. 346 (correctiefactoren)
 NEDERLAND. Prijzen in euro (excl. BTW)

CARRÉ HORIZONTAAL (CPHN1-RO)

HOE CARRÉ HORIZONTAAL BESTELLEN

Leveringstermijn 15 - 30 werkdagen
(zonder transportduur)

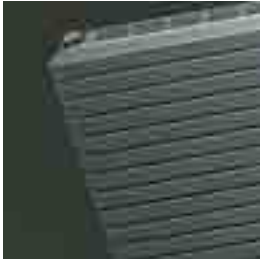

CPHN1-RO

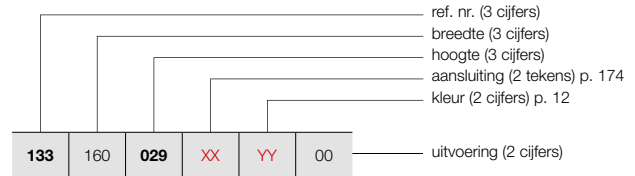

PRIJSGROEP: VPG2 - STAAL DESIGNRADIATOREN

BESTELCODE MAATWERK CARRÉ HORIZONTAAL							TECHNISCHE GEGEVENS				STANDAARDKLEUR	ANDERE KLEUREN				
buizen	breedte (L mm)	hoogte (H mm)	75/65/20 (Watt) (Ø50K)	55/45/20 (Watt) (Ø30K)	n-exp.	gewicht (kg)	inhoud (l)	el. weerst. (Watt)	prijs RAL 9016 (€)	prijs kleur (€)						
REF. NR. CARRÉ HORIZONTAAL CPHN1-RO : 133																
133	160	029	XX	YY	00	10	1600	295	590	312	1,25	16,50	7,60	-	485	558
		035				12	1600	355	691	365	1,25	19,76	9,60	-	585	673
		041				14	1600	415	790	417	1,25	23,02	11,60	-	684	787
		047				16	1600	475	888	469	1,25	26,29	13,60	-	779	896
		053				18	1600	535	984	520	1,25	29,54	15,60	-	879	1011
		059				20	1600	595	1077	569	1,25	32,80	17,60	-	974	1120
		065				22	1600	655	1170	615	1,26	35,79	18,51	-	1071	1232
		077				26	1600	775	1352	710	1,26	41,78	20,34	-	1267	1457
		089				30	1600	895	1531	804	1,26	47,76	22,16	-	1461	1680
133	180	029	XX	YY	00	10	1800	295	664	351	1,25	18,56	8,55	-	528	607
		035				12	1800	355	778	411	1,25	22,23	10,80	-	634	729
		041				14	1800	415	889	469	1,25	25,90	13,05	-	741	852
		047				16	1800	475	999	528	1,25	29,57	15,30	-	846	973
		053				18	1800	535	1107	585	1,25	33,23	17,55	-	953	1096
		059				20	1800	595	1211	639	1,25	36,90	19,80	-	1056	1214
		065				22	1800	655	1316	691	1,26	40,27	20,83	-	1164	1339
		077				26	1800	775	1521	799	1,26	47,00	22,88	-	1374	1580
		089				30	1800	895	1723	905	1,26	53,73	24,93	-	1587	1825
133	200	029	XX	YY	00	10	2000	295	738	390	1,25	20,62	9,50	-	568	653
		035				12	2000	355	864	456	1,25	24,70	12,00	-	684	787
		041				14	2000	415	988	522	1,25	28,78	14,50	-	797	917
		047				16	2000	475	1110	586	1,25	32,86	17,00	-	908	1044
		053				18	2000	535	1230	650	1,25	36,92	19,50	-	1022	1175
		059				20	2000	595	1346	711	1,25	41,00	22,00	-	1137	1308
		065				22	2000	655	1462	768	1,26	44,74	23,14	-	1252	1440
		077				26	2000	775	1690	888	1,26	52,22	25,42	-	1477	1699
		089				30	2000	895	1914	1006	1,26	59,70	27,70	-	1703	1958
133	220	029	XX	YY	00	10	2200	295	812	429	1,25	22,68	10,45	-	607	698
		035				12	2200	355	950	502	1,25	27,17	13,20	-	728	837
		041				14	2200	415	1087	574	1,25	31,66	15,95	-	848	975
		047				16	2200	475	1221	645	1,25	36,15	18,70	-	971	1117
		053				18	2200	535	1353	714	1,25	40,61	21,45	-	1092	1256
		059				20	2200	595	1481	782	1,25	45,10	24,20	-	1215	1397
		065				22	2200	655	1608	845	1,26	49,21	25,45	-	1334	1534
		077				26	2200	775	1859	977	1,26	57,44	27,96	-	1577	1814
		089				30	2200	895	2105	1106	1,26	65,67	30,47	-	1819	2092
133	240	029	XX	YY	00	10	2400	295	886	468	1,25	24,74	11,40	-	644	741
		035				12	2400	355	1037	548	1,25	29,64	14,40	-	771	887
		041				14	2400	415	1186	626	1,25	34,54	17,40	-	901	1036
		047				16	2400	475	1332	703	1,25	39,43	20,40	-	1030	1185
		053				18	2400	535	1476	779	1,25	44,30	23,40	-	1160	1334
		059				20	2400	595	1615	853	1,25	49,20	26,40	-	1285	1478
		065				22	2400	655	1754	922	1,26	53,69	27,77	-	1414	1626
		077				26	2400	775	2028	1065	1,26	62,66	30,50	-	1672	1923
		089				30	2400	895	2297	1207	1,26	71,64	33,24	-	1932	2222

Conform EN442-1: 2014: radiatoren en convectoren

Voor meer details over onze artikel-data, zie artikel-database: <https://www.2ba.nl>

Voor de warmteafgiftes van andere regimes, kijkt u op p. 346 (correctiefactoren)
NEDERLAND. Prijzen in euro (excl. BTW)

HOE CARRÉ HORIZONTAAL BESTELLEN

Leveringstermijn 15 - 30 werkdagen
(zonder transportduur)

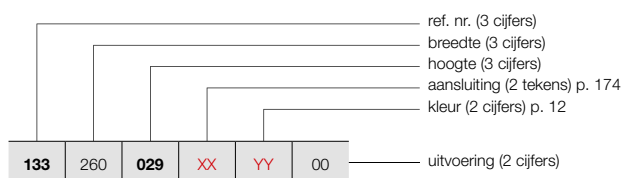

CARRÉ HORIZONTAAL (CPHN1-RO)



CPHN1-RO

PRIJSGROEP: VPG2 - STAAL DESIGNRADIATOREN

BESTELCODE MAATWERK CARRÉ HORIZONTAAL	TECHNISCHE GEGEVENS							STANDAARDKLEUR		ANDERE KLEUREN						
	buizen	breedte (L mm)	hoogte (H mm)	75/65/20 (Watt) (Φ50K)	55/45/20 (Watt) (Φ30K)	n-exp.	gewicht (kg)	inhoud (l)	el. weerst. (Watt)	prijs RAL 9016 (€)	prijs kleur (€)					
REF. NR. CARRÉ HORIZONTAAL CPHN1-RO : 133																
133	260	029	XX	YY	00	10	2600	295	959	506	1,25	26,81	12,35	-	680	782
						12	2600	355	1123	593	1,25	32,11	15,60	-	818	941
						14	2600	415	1284	678	1,25	37,41	18,85	-	953	1096
						16	2600	475	1443	762	1,25	42,72	22,10	-	1088	1251
						18	2600	535	1599	844	1,25	48,00	25,35	-	1224	1408
						20	2600	595	1750	924	1,25	53,30	28,60	-	1361	1565
						22	2600	655	1901	999	1,26	58,16	30,08	-	1497	1722
						26	2600	775	2197	1154	1,26	67,89	33,05	-	1770	2036
						30	2600	895	2488	1307	1,26	77,61	36,01	-	2040	2346
						133	280	029	XX	YY	00	10	2800	295	1033	545
12	2800	355	1210	639	1,25							34,58	16,80	-	856	984
14	2800	415	1383	730	1,25							40,29	20,30	-	1002	1152
16	2800	475	1554	821	1,25							46,00	23,80	-	1144	1316
18	2800	535	1722	909	1,25							51,69	27,30	-	1286	1479
20	2800	595	1884	995	1,25							57,40	30,80	-	1431	1646
22	2800	655	2047	1075	1,26							62,64	32,40	-	1576	1812
26	2800	775	2366	1243	1,26							73,11	35,59	-	1861	2140
30	2800	895	2680	1408	1,26							83,58	38,78	-	2148	2470
133	300	029	XX	YY	00							10	3000	295	1107	585
						12	3000	355	1296	684	1,25	37,05	18,00	-	901	1036
						14	3000	415	1482	783	1,25	43,17	21,75	-	1052	1210
						16	3000	475	1665	879	1,25	49,29	25,50	-	1200	1380
						18	3000	535	1845	974	1,25	55,38	29,25	-	1351	1554
						20	3000	595	2019	1066	1,25	61,50	33,00	-	1500	1725
						22	3000	655	2193	1152	1,26	67,11	34,71	-	1652	1900
						26	3000	775	2535	1332	1,26	78,33	38,13	-	1949	2241
						30	3000	895	2871	1508	1,26	89,55	41,55	-	2252	2590

Conform EN442-1: 2014: radiatoren en convectoren

Voor meer details over onze artikel-data, zie artikel-database: <https://www.2ba.nl>

Voor de warmteafgifte van andere regimes, kijkt u op p. 346 (correctiefactoren)
NEDERLAND. Prijzen in euro (excl. BTW)

CARRÉ HORIZONTAAL (CPHN2-RO)

HOE CARRÉ HORIZONTAAL BESTELLEN

Leveringstermijn 15 - 30 werkdagen
(zonder transportduur)

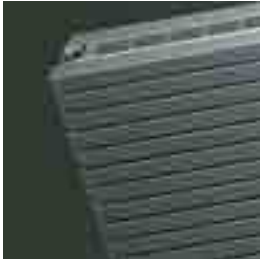

CPHN2-RO

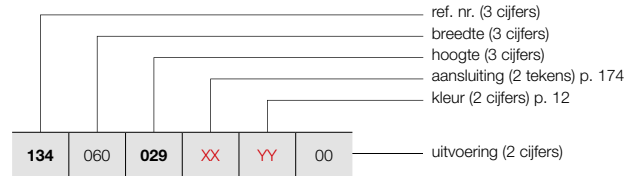

PRIJSGROEP: VPG2 - STAAL DESIGNRADIATOREN

BESTELCODE MAATWERK CARRÉ HORIZONTAAL							TECHNISCHE GEGEVENS				STANDAARDKLEUR	ANDERE KLEUREN					
134	060	029	XX	YY	00	buizen	breedte (L mm)	hoogte (H mm)	75/65/20 (Watt) (Φ50K)	55/45/20 (Watt) (Φ30K)	n-exp.	gewicht (kg)	inhoud (l)	el. weerst. (Watt)	prijs RAL 9016 (€)	prijs kleur (€)	
REF. NR. CARRÉ HORIZONTAAL CPHN2-RO : 134																	
134	060	029	XX	YY	00	10	600	295	377	200	1,24	11,94	6,06	-	482	554	
		035				12	600	355	459	242	1,25	14,26	7,27	-	581	668	
		041				14	600	415	539	282	1,27	16,57	8,48	-	679	781	
		047				16	600	475	617	321	1,28	18,89	9,70	-	775	891	
		053				18	600	535	693	359	1,29	21,20	10,91	-	874	1005	
		059				20	600	595	766	394	1,30	23,52	12,12	-	972	1118	
		065				22	600	655	836	430	1,30	25,85	13,39	-	1066	1226	
		077				26	600	775	967	498	1,30	30,50	15,94	-	1260	1449	
		089				30	600	895	1087	560	1,30	35,16	18,48	-	1456	1674	
134	080	029	XX	YY	00	10	800	295	503	267	1,24	15,92	8,08	-	593	682	
		035				12	800	355	612	323	1,25	19,01	9,70	-	706	812	
		041				14	800	415	719	376	1,27	22,10	11,31	-	826	950	
		047				16	800	475	823	428	1,28	25,18	12,93	-	946	1088	
		053				18	800	535	924	478	1,29	28,27	14,54	-	1064	1224	
		059				20	800	595	1021	526	1,30	31,36	16,16	-	1182	1359	
		065				22	800	655	1114	573	1,30	34,46	17,86	-	1299	1494	
		077				26	800	775	1290	664	1,30	40,67	21,25	-	1537	1768	
		089				30	800	895	1449	746	1,30	46,88	24,64	-	1773	2039	
134	100	029	XX	YY	00	10	1000	295	629	334	1,24	19,90	10,10	-	689	792	
		035				12	1000	355	765	404	1,25	23,76	12,12	-	826	950	
		041				14	1000	415	899	470	1,27	27,62	14,14	-	966	1111	
		047				16	1000	475	1029	535	1,28	31,48	16,16	-	1102	1267	
		053				18	1000	535	1155	598	1,29	35,34	18,18	-	1241	1427	
		059				20	1000	595	1276	657	1,30	39,20	20,20	-	1377	1584	
		065				22	1000	655	1393	717	1,30	43,08	22,32	-	1514	1741	
		077				26	1000	775	1612	830	1,30	50,84	26,56	-	1790	2059	
		089				30	1000	895	1811	932	1,30	58,60	30,80	-	2064	2374	
134	120	029	XX	YY	00	10	1200	295	755	401	1,24	23,88	12,12	-	779	896	
		035				12	1200	355	918	485	1,25	28,51	14,54	-	933	1073	
		041				14	1200	415	1079	564	1,27	33,14	16,97	-	1094	1258	
		047				16	1200	475	1235	642	1,28	37,78	19,39	-	1248	1435	
		053				18	1200	535	1386	717	1,29	42,41	21,82	-	1406	1617	
		059				20	1200	595	1531	788	1,30	47,04	24,24	-	1561	1795	
		065				22	1200	655	1672	861	1,30	51,70	26,78	-	1717	1975	
		077				26	1200	775	1934	996	1,30	61,01	31,87	-	2027	2331	
		089				30	1200	895	2173	1119	1,30	70,32	36,96	-	2345	2697	
134	140	029	XX	YY	00	10	1400	295	881	468	1,24	27,86	14,14	-	867	997	
		035				12	1400	355	1071	566	1,25	33,26	16,97	-	1041	1197	
		041				14	1400	415	1259	658	1,27	38,67	19,80	-	1215	1397	
		047				16	1400	475	1441	749	1,28	44,07	22,62	-	1386	1594	
		053				18	1400	535	1617	837	1,29	49,48	25,45	-	1563	1797	
		059				20	1400	595	1786	919	1,30	54,88	28,28	-	1737	1998	
		065				22	1400	655	1950	1004	1,30	60,31	31,25	-	1908	2194	
		077				26	1400	775	2257	1162	1,30	71,18	37,18	-	2255	2593	
		089				30	1400	895	2535	1305	1,30	82,04	43,12	-	2603	2993	

Conform EN442-1: 2014: radiatoren en convectoren

Voor meer details over onze artikel-data, zie artikel-database: <https://www.2ba.nl>

Voor de warmteafgifte van andere regimes, kijkt u op p. 346 (correctiefactoren)
NEDERLAND. Prijzen in euro (excl. BTW)

HOE CARRÉ HORIZONTAAL BESTELLEN

Leveringstermijn 15 - 30 werkdagen
(zonder transportduur)

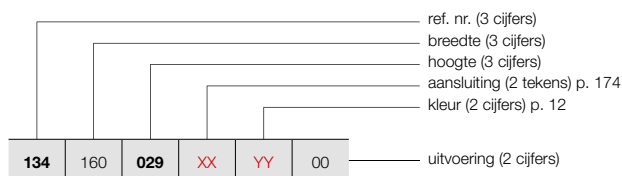

CARRÉ HORIZONTAAL (CPHN2-RO)



CPHN2-RO

PRIJSGROEP: VPG2 - STAAL DESIGNRADIATOREN

BESTELCODE MAATWERK CARRÉ HORIZONTAAL	TECHNISCHE GEGEVENS							STANDAARDKLEUR		ANDERE KLEUREN	
	buizen	breedte (L mm)	hoogte (H mm)	75/65/20 (Watt) (φ50K)	55/45/20 (Watt) (φ30K)	n-exp.	gewicht (kg)	inhoud (l)	el. weerst. (Watt)	prijs RAL 9016 (€)	prijs kleur (€)
REF. NR. CARRÉ HORIZONTAAL CPHN2-RO : 134											
134 160 029 XX YY 00	10	1600	295	1006	534	1,24	31,84	16,16	-	950	1093
	12	1600	355	1224	646	1,25	38,02	19,39	-	1142	1313
	14	1600	415	1438	752	1,27	44,19	22,62	-	1329	1528
	16	1600	475	1646	856	1,28	50,37	25,86	-	1522	1750
	18	1600	535	1848	956	1,29	56,54	29,09	-	1710	1967
	20	1600	595	2042	1051	1,30	62,72	32,32	-	1901	2186
	22	1600	655	2229	1147	1,30	68,93	35,71	-	2093	2407
	26	1600	775	2579	1328	1,30	81,34	42,50	-	2472	2843
	30	1600	895	2898	1492	1,30	93,76	49,28	-	2848	3275
	134 180 029 XX YY 00	10	1800	295	1132	601	1,24	35,82	18,18	-	1031
12		1800	355	1377	727	1,25	42,77	21,82	-	1237	1423
14		1800	415	1618	846	1,27	49,72	25,45	-	1444	1661
16		1800	475	1852	963	1,28	56,66	29,09	-	1651	1899
18		1800	535	2079	1076	1,29	63,61	32,72	-	1854	2132
20		1800	595	2297	1182	1,30	70,56	36,36	-	2063	2372
22		1800	655	2507	1290	1,30	77,54	40,18	-	2268	2608
26		1800	775	2902	1494	1,30	91,51	47,81	-	2679	3081
30		1800	895	3260	1678	1,30	105,48	55,44	-	3091	3555
134 200 029 XX YY 00		10	2000	295	1258	668	1,24	39,80	20,20	-	1106
	12	2000	355	1530	808	1,25	47,52	24,24	-	1329	1528
	14	2000	415	1798	940	1,27	55,24	28,28	-	1549	1781
	16	2000	475	2058	1070	1,28	62,96	32,32	-	1773	2039
	18	2000	535	2310	1195	1,29	70,68	36,36	-	1995	2294
	20	2000	595	2552	1314	1,30	78,40	40,40	-	2217	2550
	22	2000	655	2786	1434	1,30	86,16	44,64	-	2439	2805
	26	2000	775	3224	1660	1,30	101,68	53,12	-	2880	3312
	30	2000	895	3622	1864	1,30	117,20	61,60	-	3320	3818
	134 220 029 XX YY 00	10	2200	295	1384	735	1,24	43,78	22,22	-	1182
12		2200	355	1683	889	1,25	52,27	26,66	-	1420	1633
14		2200	415	1978	1034	1,27	60,76	31,11	-	1656	1904
16		2200	475	2264	1177	1,28	69,26	35,55	-	1890	2174
18		2200	535	2541	1315	1,29	77,75	40,00	-	2129	2448
20		2200	595	2807	1445	1,30	86,24	44,44	-	2365	2720
22		2200	655	3065	1578	1,30	94,78	49,10	-	2603	2993
26		2200	775	3546	1825	1,30	111,85	58,43	-	3075	3536
30		2200	895	3984	2051	1,30	128,92	67,76	-	3546	4078
134 240 029 XX YY 00		10	2400	295	1510	801	1,24	47,76	24,24	-	1256
	12	2400	355	1836	970	1,25	57,02	29,09	-	1508	1734
	14	2400	415	2158	1128	1,27	66,29	33,94	-	1756	2019
	16	2400	475	2470	1284	1,28	75,55	38,78	-	2009	2310
	18	2400	535	2772	1434	1,29	84,82	43,63	-	2258	2597
	20	2400	595	3062	1576	1,30	94,08	48,48	-	2508	2884
	22	2400	655	3343	1721	1,30	103,39	53,57	-	2762	3176
	26	2400	775	3869	1992	1,30	122,02	63,74	-	3264	3754

Conform EN442-1: 2014: radiatoren en convectoren

Voor meer details over onze artikel-data, zie artikel-database: <https://www.2ba.nl>

Voor de warmteafgiftes van andere regimes, kijkt u op p. 346 (correctiefactoren)
NEDERLAND. Prijzen in euro (excl. BTW)

CARRÉ HORIZONTAAL (CPHN2-RO)



CPHN2-RO

HOE CARRÉ HORIZONTAAL BESTELLEN

Leveringstermijn 15 - 30 werkdagen
(zonder transportduur)

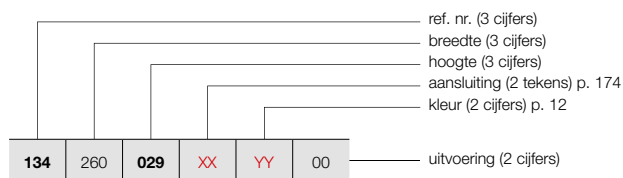

PRIJSGROEP: VPG2 - STAAL DESIGNRADIATOREN

BESTELCODE MAATWERK CARRÉ HORIZONTAAL							TECHNISCHE GEGEVENS				STANDAARDKLEUR	ANDERE KLEUREN					
134	260	029	XX	YY	00	buizen	breedte (L mm)	hoogte (H mm)	75/65/20 (Watt) (Φ50K)	55/45/20 (Watt) (Φ30K)	n-exp.	gewicht (kg)	inhoud (l)	el. weerst. (Watt)	prijs RAL 9016 (€)	prijs kleur (€)	
REF. NR. CARRÉ HORIZONTAAL CPHN2-RO : 134																	
134	260	029	XX	YY	00	10	2600	295	1635	868	1,24	51,74	26,26	-	1327	1526	
		035				12	2600	355	1989	1050	1,25	61,78	31,51	-	1591	1830	
		041				14	2600	415	2337	1222	1,27	71,81	36,76	-	1854	2132	
		047				16	2600	475	2675	1391	1,28	81,85	42,02	-	2122	2440	
		053				18	2600	535	3003	1554	1,29	91,88	47,27	-	2389	2747	
		059				20	2600	595	3318	1708	1,30	101,92	52,52	-	2655	3053	
		065				22	2600	655	3622	1864	1,30	112,01	58,03	-	2919	3357	
		077				26	2600	775	4191	2157	1,30	132,18	69,06	-	3448	3965	
134	280	029	XX	YY	00	10	2800	295	1761	935	1,24	55,72	28,28	-	1398	1608	
		035				12	2800	355	2142	1131	1,25	66,53	33,94	-	1672	1923	
		041				14	2800	415	2517	1316	1,27	77,34	39,59	-	1953	2246	
		047				16	2800	475	2881	1498	1,28	88,14	45,25	-	2232	2567	
		053				18	2800	535	3234	1673	1,29	98,95	50,90	-	2512	2889	
		059				20	2800	595	3573	1839	1,30	109,76	56,56	-	2790	3209	
		065				22	2800	655	3900	2008	1,30	120,62	62,50	-	3072	3533	
134	300	029	XX	YY	00	10	3000	295	1887	1002	1,24	59,70	30,30	-	1466	1686	
		035				12	3000	355	2295	1212	1,25	71,28	36,36	-	1756	2019	
		041				14	3000	415	2697	1410	1,27	82,86	42,42	-	2050	2358	
		047				16	3000	475	3087	1605	1,28	94,44	48,48	-	2343	2694	
		053				18	3000	535	3465	1793	1,29	106,02	54,54	-	2631	3026	
		059				20	3000	595	3828	1970	1,30	117,60	60,60	-	2924	3363	
		065				22	3000	655	4179	2151	1,30	129,24	66,96	-	3218	3701	

Conform EN442-1: 2014: radiatoren en convectoren

Voor meer details over onze artikel-data, zie artikel-database: <https://www.2ba.nl>

Voor de warmteafgifte van andere regimes, kijkt u op p. 346 (correctiefactoren)
NEDERLAND. Prijzen in euro (excl. BTW)



PRIJSGROEP: VPG10 - ACC.

BEVESTIGINGEN	HOOGTE / BREEDTE RADIATOR	KLEUR	ART. NR.	€
CPVN2-ZB / CPHN1-RO / CPHN2-RO				
WANDOPSTELLING	≤ 2400 mm (4 bevestigingen)	RAL 7016	1187 007 0000 7016	40
	≥ 2600 mm (6 bevestigingen)	RAL 7016	1187 008 0000 7016	58

NEDERLAND. Prijzen in euro (excl. BTW)

CARRÉ ACCESSOIRES
IN OPTIE

PRIJSGROEP: VPG10B - HANDDOEKBEUGELS

ACCESSOIRES	BREEDTE RADIATOR	KLEUR	ART. NR.	€
CPVN-PLUS / CPVN2-ZB / CPHN1-RO / CPHN2-RO				
KNOP VIERKANT 		CHROOM	1183 500 0000 0099	68
	<ul style="list-style-type: none"> h = 24 mm; b = 24 mm; d = 65 mm 			
CPVN-PLUS / CPVN2-ZB / CPHN1-RO / CPHN2-RO				
HANDDOEKBEUGEL RECHT 		CHROOM	1183 207 0000 0099	185
	<ul style="list-style-type: none"> h = 24 mm; b = 720 mm (zelf in te korten); d = 66 mm; a = 48 mm 			
CPVN-PLUS / CPVN2-ZB				
HANDDOEKBEUGEL MULTI+ RECHTS 	600 mm	S600	1183 734 0000 0600	201
	600 mm	RAL 9005 ^S	1183 734 0000 9005	201
<ul style="list-style-type: none"> h = 70 mm; b = 600 mm (b tablet = 194 mm); e = 176 mm; c = 170 mm; Bevestiging aan de muur, rechts van de radiator. 				
CPVN-PLUS / CPVN2-ZB				
HANDDOEKBEUGEL MULTI+ LINKS 	600 mm	S600	1183 735 0000 0600	201
	600 mm	RAL 9005 ^S	1183 735 0000 9005	201
<ul style="list-style-type: none"> h = 70 mm; b = 600 mm (b tablet = 194 mm); e = 176 mm; c = 170 mm; Bevestiging aan de muur, links van de radiator. 				

^S structuur zwart

Montagevoorschriften accessoires: zie www.vasco.eu

NEDERLAND. Prijzen in euro (excl. BTW)

e = afstand voorkant accessoire tot wand
d = afstand voorkant accessoire tot voorkant radiator
c = afstand wand tot achterkant beugel
a = afstand accessoire tot radiator
uit voorraad leverbaar

CARRÉ AANSLUITINGEN

CARRÉ PLUS VERTICAAL: CPVN-PLUS (VOORRAAD)

CARRÉ VERTICAAL: CPVN2-ZB

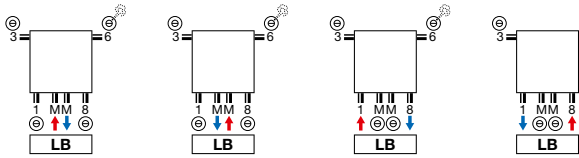

CARRÉ PLUS VERTICAAL: CPVN-PLUS (NIET-VOORRAAD)

CARRÉ VERTICAAL: CPVN2-ZB

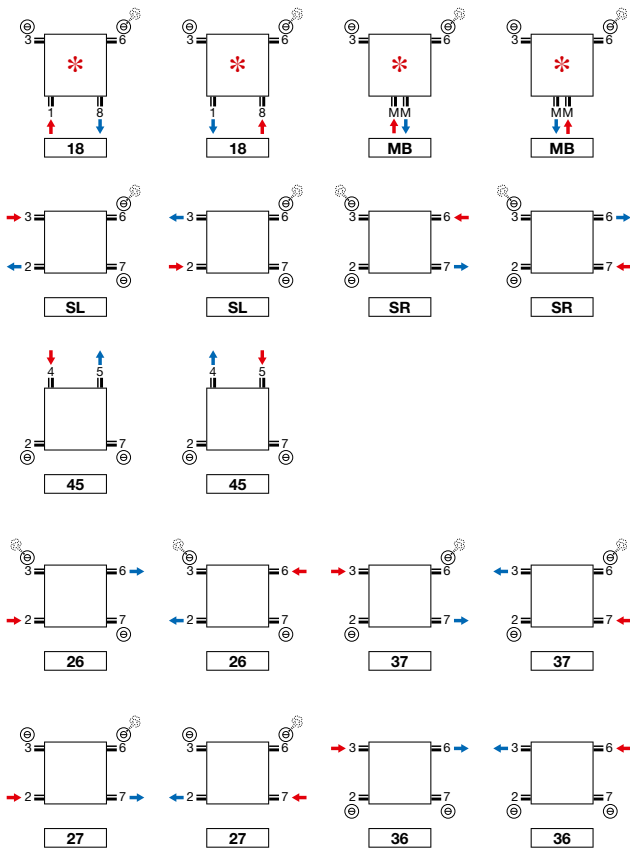

* **Opmerking CPVN-PLUS/CPVN2-ZB 10 buizen:** 2/3/6/7 altijd open.

CARRÉ HORIZONTAAL: CPHN1-RO / CPHN2-RO

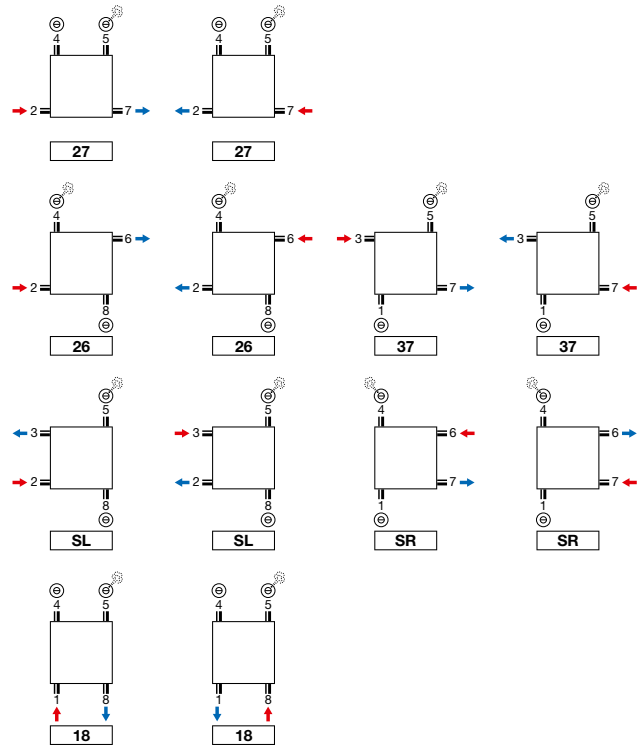

Opmerking: het aansluiten van de radiator kan enkel volgens de getoonde aansluiticonen. Voor elke andere aansluitwijze nemen wij geen verantwoordelijkheid.

CARRÉ PLUS VERTICAAL (CPVN-PLUS)

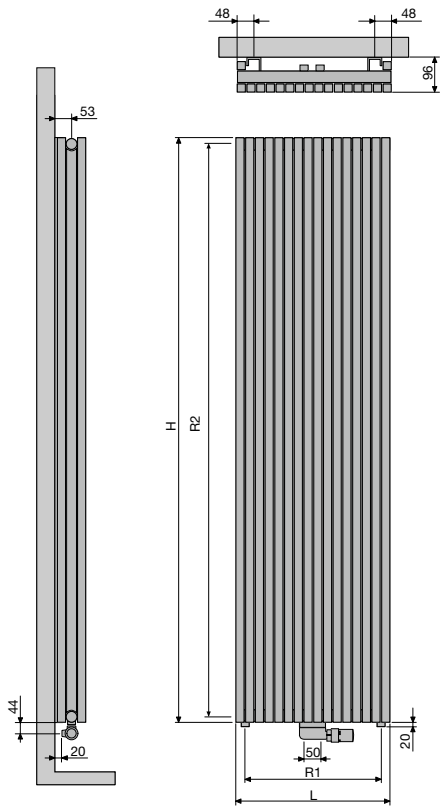

	CPVN-PLUS									
aantal buizen	10	12	14	16	18	20	22	26	30	
Breedte (L)	295	355	415	475	535	595	655	775	895	
Hartafstand tussen de onderaansluitingen 18 (R1)	240	300	360	420	480	540	600	720	840	
hoogte (H)	1400	1600	1800	2000	2200					
Hartafstand tussen de zijansluitingen SL/SR (R2)	1365	1565	1765	1965	2165					
Hartafstand tussen de ophangingen	L-200	H-290								

CARRÉ VERTICAAL (CPVN2-ZB)

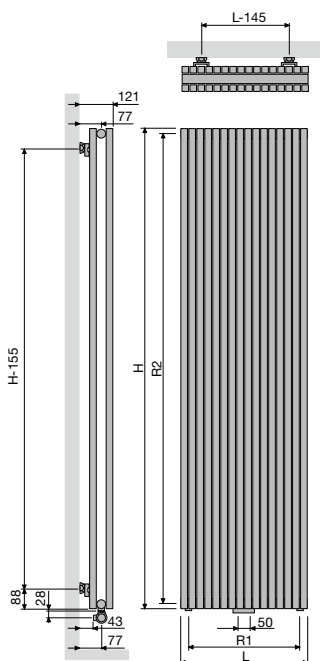

	CPVN2-ZB									
aantal buizen	10	12	14	16	18	20	22	26	30	
Breedte (L)	295	355	415	475	535	595	655	775	895	
Hartafstand tussen de onderaansluitingen 18 (R1)	240	300	360	420	480	540	600	720	840	
hoogte (H)	1400	1600	1800	2000	2200	2400	2600	2800	3000	
Hartafstand tussen de zijansluitingen SL/SR (R2)	1365	1565	1765	1965	2165	2365	2565	2765	2965	
Hartafstand tussen de ophangingen	L-145	H-155								

CARRÉ HORIZONTAAL (CPHN1-RO, CPHN2-RO)

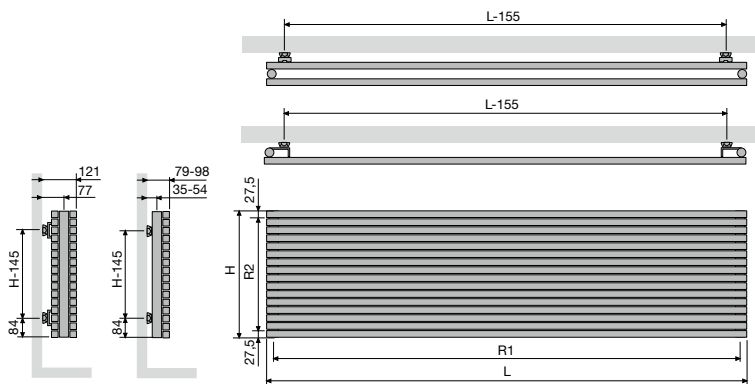

CPHN1-RO / CPHN2-RO

	600	800	1000	1200	1400	1600	1800	2000	2200	2400	2600	2800	3000
Breedte (L)	600	800	1000	1200	1400	1600	1800	2000	2200	2400	2600	2800	3000
Hartafstand tussen de onderaansluitingen 18 (R1)	565	765	965	1165	1365	1565	1765	1965	2165	2365	2565	2765	2965
hoogte (H)	295	355	415	475	535	595	655	715	775	835			
Hartafstand tussen de zijaansluitingen SL/SR (R2)	240	300	360	420	480	540	600	660	720	780			
Hartafstand tussen de ophangingen	L-155	H-145											

BUIZEN

- VV: Verticaal, rechthoekig 45 x 20 mm

KLEUREN

- Standaardkleur wit RAL 9016
- Uitgebreide kleurenkaart zie p. 12

SPECIAAL

- De Arche is bekroond met Design Plus Award 2005, Reddot Design Award 2006, Silver Award Designpreis Deutschland 2006 en genomineerd voor de Henry van de Velde prijs 2005.

BEVESTIGINGEN

- Muurbevestigingen standaard (telescopisch)

TECHNISCH

- KTL-grondlaag, poedercoating
- Standaardwerkdruk: 4 bar
- Maximale bedrijfstemperatuur: 110°C

ELEKTRISCH

- ✗ Zuiver elektrische radiator in de fabriek vorgevuld
- ✗ Gemengde radiator

TECHNISCHE TEKENINGEN

- Zie p. 182

AANSLUITING

- ✗ Eénpuntsaansluiting voor éénpijpsysteem
- ✗ Eénpuntsaansluiting voor tweepijpsysteem
- ✓ Tweepuntsaansluiting voor éénpijpsysteem (aansluiting via de middenaansluiting) (zie p. 340)
- ✓ Tweepuntsaansluiting voor tweepijpsysteem (standaard) (zie p. 340)
- ✗ Geïntegreerd ventiel
- Aansluitingen: ½" (binnendraad)

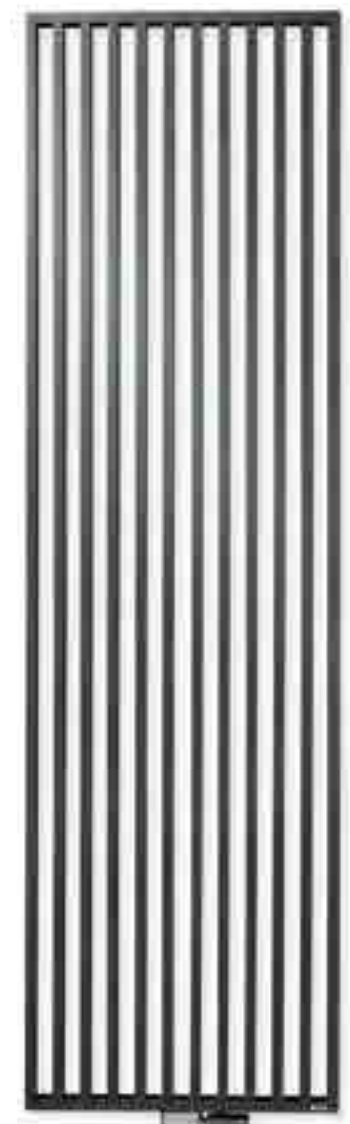

AANBEVOLEN AANSLUITING (LB)

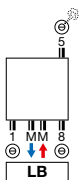

Andere aansluitmogelijkheden, zie p. 181

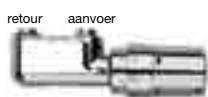

art. nr. 1182 103 0000 0099

prijs € 175

Koppelingen, zie p. 353

**AANBEVOLEN VOOR BADKAMER EN KEUKEN
IN OPTIE**



handdoekbeugel (chrom) art. nr. zie p. 181

prijs € 185

Andere accessoires, zie p. 181

ARCHE VERTICAAL

Techniek en esthetiek naadloos verenigd

Een designradiatorconcept, enig in zijn soort. De buizen zijn niet op, maar in elkaar gemonteerd en vormen samen één naadloze, vlakke structuur. Ook de accessoires zijn mooi in het geheel geïntegreerd. Die perfecte verstandhouding tussen techniek en esthetiek leveren een uniek product op dat inmiddels zowat alle belangrijke designprijzen heeft weggekaapt en ook beschikbaar is in een badkameruitvoering met middenaansluiting.



ARCHE VERTICAAL (W)



W

HOE ARCHE VERTICAAL BESTELLEN

Leveringstermijn 15 - 30 werkdagen
(zonder transportduur)

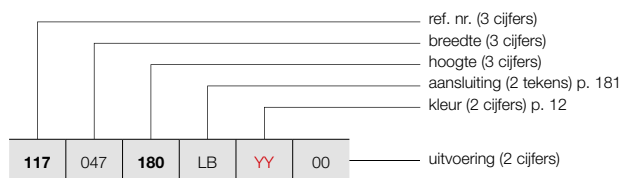

HOE VOORRAADRADIATOR ARCHE VERTICAAL BESTELLEN

Leveringstermijn 5 werkdagen
(zonder transportduur)

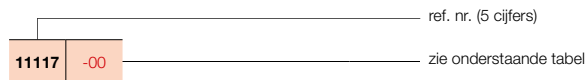

PRIJSGROEP: VPG2 - STAAL DESIGNRADIATOREN

BESTELCODE MAATWERK ARCHE VERTICAAL	TECHNISCHE GEGEVENS									STANDAARDKLEUR		ANDERE KLEUREN					
	buizen	breedte (L mm)	hoogte (H mm)	75/65/20 (Watt Ø50K)	55/45/20 (Watt Ø30K)	n-exp.	gewicht (kg)	inhoud (l)	el. weerst. (Watt)	prijs RAL 9016 (€)	verkorte ref. nr. RAL 9016 voorraad	prijs kleur (€)					
REF. NR. ARCHE VERTICAAL W : 117																	
117	047	180 200 220	LB	YY	00	10	470	1800	1050	560	1,23	22,90	13,94	-	580	11117-03	667
						10	470	2000	1164	618	1,24	25,36	15,42	-	619	-	712
						10	470	2200	1279	679	1,24	27,81	16,91	-	656	-	754
117	057	180 200 220	LB	YY	00	12	570	1800	1273	679	1,23	27,78	16,90	-	702	-	807
						12	570	2000	1412	749	1,24	30,76	18,70	-	751	-	864
						12	570	2200	1552	824	1,24	33,73	20,50	-	794	-	913
117	067	180 200 220	LB	YY	00	14	670	1800	1496	798	1,23	32,65	19,87	-	826	-	950
						14	670	2000	1660	881	1,24	36,15	21,98	-	885	-	1018
						14	670	2200	1824	968	1,24	39,65	24,10	-	931	-	1071

Conform EN442-1: 2014: radiatoren en convectoren

Voor meer details over onze artikel-data, zie artikel-database: <https://www.2ba.nl>
Voor de warmteafgiftes van andere regimes, kijkt u op p. 346 (correctiefactoren)
NEDERLAND. Prijzen in euro (excl. BTW)

TYPES

- VVR (beugel rechts), VL (beugel links)

BUIZEN

- Verticaal, rechthoekig 45 x 20 mm

KLEUREN

- Standaardkleur wit RAL 9016
- Uitgebreide kleurenkaart zie p. 12

SPECIAAL

- Vaste handdoekbeugel in de kleur van de radiator
- Opgelet: deze beugel wordt niet warm!

BEVESTIGINGEN

- Muurbevestigingen standaard (telescopisch)

TECHNISCH

- KTL-grondlaag, poedercoating
- Standaardwerkdruk: 4 bar
- Maximale bedrijfstemperatuur: 110°C

ELEKTRISCH

- ✗ Zuiver elektrische radiator in de fabriek voorgevuld
- ✗ Gemengde radiator

TECHNISCHE TEKENINGEN

- Zie p. 182

AANSLUITING

- ✗ Eénpuntsaansluiting voor éénpijpsysteem
- ✗ Eénpuntsaansluiting voor tweepijpsysteem
- ✓ Tweepuntsaansluiting voor éénpijpsysteem (aansluiting via de middenaansluiting) (zie p. 340)
- ✓ Tweepuntsaansluiting voor tweepijpsysteem (standaard) (zie p. 340)
- ✗ Geïntegreerd ventiel
- Aansluitingen: 1/2" (binnendraad)



AANBEVOLEN AANSLUITING (LB)

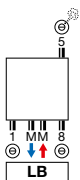

Andere aansluitmogelijkheden, zie p. 181

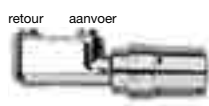

art. nr. 1182 103 0000 0099

prijs € 175

Koppelingen, zie p. 353

ARCHE PLUS VERTICAAL

Functioneel mooi over de hele lijn

Een designradiator waarbij de unieke, vlakke vormgeving van de Arche wordt aangevuld met een naadloos op de structuur gelaste handdoekbeugel. Samen vormen ze een mooi afgewerkt geheel dat de perfecte verstandhouding tussen de Arche vormgeving en functionaliteit extra benadrukt.



ARCHE PLUS VERTICAAL (VWL, VVR)



VWL

VVR

HOE ARCHE PLUS VERTICAAL BESTELLEN

Leveringstermijn 15 - 30 werkdagen
(zonder transportduur)

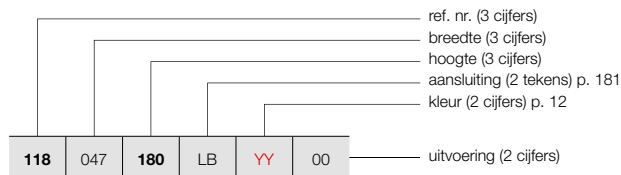

HOE VOORRAADRADIATOR ARCHE PLUS VERTICAAL BESTELLEN

Leveringstermijn 5 werkdagen
(zonder transportduur)

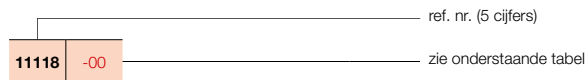

PRIJSGROEP: VPG2 - STAAL DESIGNRADIATOREN



BESTELCODE MAATWERK ARCHE PLUS VERTICAAL	TECHNISCHE GEGEVENS										STANDAARDKLEUR		ANDERE KLEUREN prijs kleur (€)
	buizen	breedte (L mm)	hoogte (H mm)	75/65/20 (Watt (Φ50K))	55/45/20 (Watt (Φ30K))	n-exp.	gewicht (kg)	inhoud (l)	el. weerst. (Watt)	prijs RAL 9016 (€)	verkorte ref. nr. RAL 9016 voorraad		
REF. NR. ARCHE PLUS VERTICAAL VWL : 118													
118 047 180 200 220 LB YY 00	10	470	1800	1050	560	1,23	23,49	13,94	-	773	11118-01	889	
	10	470	2000	1164	618	1,24	25,95	15,42	-	826	-	950	
	10	470	2200	1279	679	1,24	28,40	16,91	-	875	-	1006	
118 057 180 200 220 LB YY 00	12	570	1800	1273	679	1,23	28,44	16,90	-	935	-	1075	
	12	570	2000	1412	749	1,24	31,42	18,70	-	1002	-	1152	
	12	570	2200	1552	824	1,24	34,40	20,50	-	1056	-	1214	
118 067 180 200 220 LB YY 00	14	670	1800	1496	798	1,23	33,39	19,87	-	1101	-	1266	
	14	670	2000	1660	881	1,24	36,89	21,98	-	1178	-	1355	
	14	670	2200	1824	968	1,24	40,39	24,10	-	1243	-	1429	
REF. NR. ARCHE PLUS VERTICAAL VVR : 119													
119 047 180 200 220 LB YY 00	10	470	1800	1050	560	1,23	23,49	13,94	-	773	11119-01	889	
	10	470	2000	1164	618	1,24	25,95	15,42	-	826	-	950	
	10	470	2200	1279	679	1,24	28,40	16,91	-	875	-	1006	
119 057 180 200 220 LB YY 00	12	570	1800	1273	679	1,23	28,44	16,90	-	935	-	1075	
	12	570	2000	1412	749	1,24	31,42	18,70	-	1002	-	1152	
	12	570	2200	1552	824	1,24	34,40	20,50	-	1056	-	1214	
119 067 180 200 220 LB YY 00	14	670	1800	1496	798	1,23	33,39	19,87	-	1101	-	1266	
	14	670	2000	1660	881	1,24	36,89	21,98	-	1178	-	1355	
	14	670	2200	1824	968	1,24	40,39	24,10	-	1243	-	1429	

Conform EN442-1: 2014: radiatoren en convectoren

Voor meer details over onze artikel-data, zie artikel-database: <https://www.2ba.nl>

Voor de warmteafgiftes van andere regimes, kijkt u op p. 346 (correctiefactoren)
NEDERLAND. Prijzen in euro (excl. BTW)

PRIJSGROEP: VPG10B - HANDDOEKBEUGELS

ACCESSOIRES		KLEUR	ART. NR.	€
KNOP		VV / VWL / VWR		
		CHROOM	11834100000099	87
HANDDOEKBEUGEL		W		
		CHROOM	11832280000099	185

- h = 70 mm; b = 70 mm; d = 59 mm; a = 51 mm;

- h = 22 mm; b = 720 mm (zelf in te korten) d = 75 mm; a = 56 mm

Montagevoorschriften accessoires: zie www.vasco.eu
NEDERLAND. Prijzen in euro (excl. BTW)

d = afstand voorkant accessoire tot voorkant radiator
a = afstand accessoire tot radiator
uit voorraad leverbaar

ARCHE AANSLUITINGEN

ARCHE VERTICAAL: W
ARCHE PLUS VERTICAAL: WL / VWR

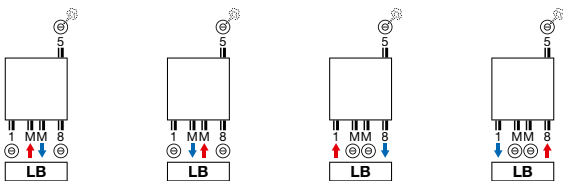

Opmerking: het aansluiten van de radiator kan enkel volgens de getoonde aansluiticonen. Voor elke andere aansluitwijze nemen wij geen verantwoordelijkheid.

ARCHE VERTICAAL (VV)

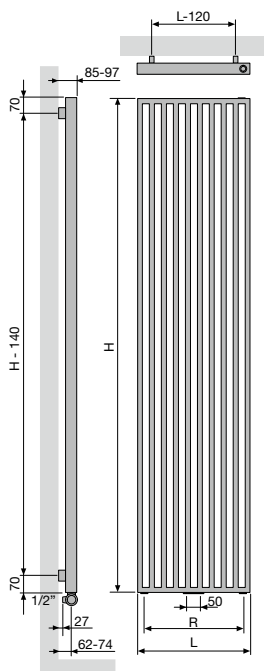

	VV		
aantal buizen	10	12	14
Breedte (L)	470	570	670
Hartafstand tussen de onderaansluitingen 18 (R)	370	470	570
Hartafstand tussen de ophangingen	L-120	H-140	

ARCHE PLUS VERTICAAL (VWL, VWR)

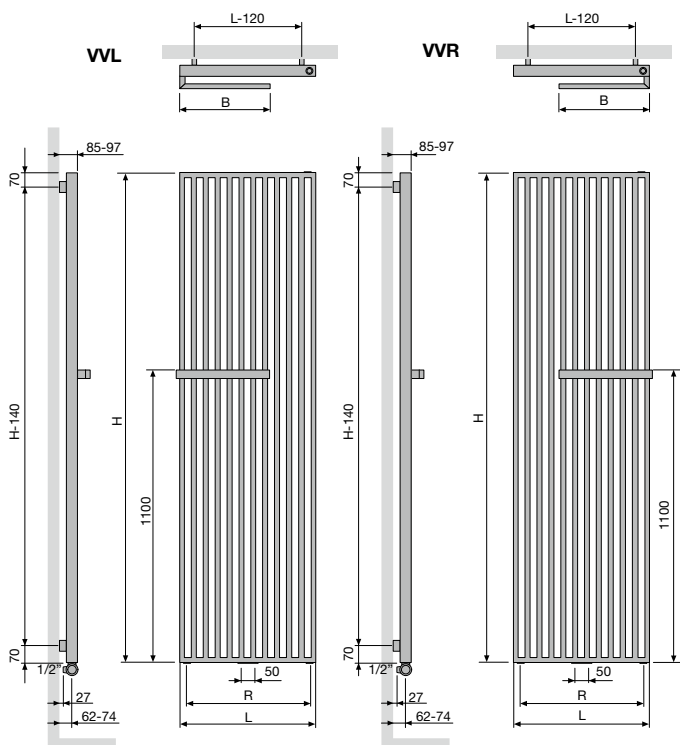

	VWL / VWR		
aantal buizen	10	12	14
Breedte (L)	470	570	670
Hartafstand tussen de onderaansluitingen 18 (R)	370	470	570
Breedte handdoekbeugel (B)	335	385	435
Hartafstand tussen de ophangingen	L-120	H-140	

TYPES

- Eén (ZV-1) of twee rijen buizen (ZV-2)

BUIZEN

- Verticaal, rechthoekig 45 x 20 mm

COLLECTOREN

- Horizontaal, achterliggend, rond Ø 35 mm

KLEUREN

- Standaardkleur wit RAL 9016
- Uitgebreide kleurenkaart zie p. 12

BEVESTIGINGEN

- Muurbevestigingen standaard

TECHNISCH

- Elektrisch lasergelast (onzichtbare lasnaden)
- KTL-grondlaag, poedercoating
- Standaardwerkdruk: 4 bar
- Maximale bedrijfstemperatuur: 110°C

ELEKTRISCH

- ✗ Zuiver elektrische radiator in de fabriek vorgevuld
- ✗ Gemengde radiator

TECHNISCHE TEKENINGEN

- Zie p. 195

AANSLUITING

- ✗ Eénpuntsaansluiting voor éénpijpsysteem
- ✗ Eénpuntsaansluiting voor tweepijpsysteem
- ✓ Tweepuntsaansluiting voor éénpijpsysteem (aansluiting via de middenaansluiting) (zie p. 340)
- ✓ Tweepuntsaansluiting voor tweepijpsysteem (standaard) (zie p. 340)
- ✗ Geïntegreerd ventiel
- Aansluitingen: 1/2" (binnendraad)



AANBEVOLEN AANSLUITING (LB)

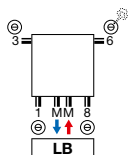

Andere aansluitmogelijkheden, zie p. 194

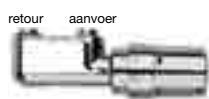

art. nr. 1182 103 0000 0099
prijs € 175
 Koppelingen, zie p. 353

**AANBEVOLEN VOOR BADKAMER EN KEUKEN
 IN OPTIE**



handdoekbeugel recht (chrom) art. nr. zie p. 193
prijs € 185

Andere accessoires, zie p. 193

ZANA VERTICAAL

Traditie en trends in perfecte harmonie

De Zana combineert een onklopbaar vermogen met een tijdloze lijnvoering. Een klassieker die blijft bekoren door zijn kracht, zijn klasse en zijn comfort. Het retrogevoel is nooit ver weg. Maar ook de moderniteit is volop aanwezig in dit unieke gamma designradiatoren voor elke woonomgeving, elke ruimte, elke toepassing.



ZANA VERTICAAL (ZV-1)



ZV-1

HOE ZANA VERTICAAL BESTELLEN
Leveringstermijn 15 - 30 werkdagen
(zonder transportduur)

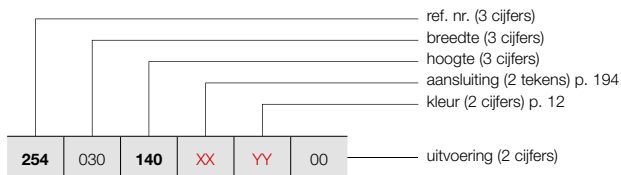

HOE VOORRAADRADIATOR ZANA VERTICAAL BESTELLEN
Leveringstermijn 5 werkdagen
(zonder transportduur)

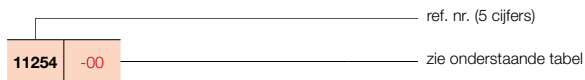

PRIJSGROEP: VPG2 - STAAL DESIGNRADIATOREN

BESTELCODE MAATWERK ZANA VERTICAAL	TECHNISCHE GEGEVENS									STANDAARDKLEUR		ANDERE KLEUREN prijs kleur (€)
	buizen	breedte (L mm)	hoogte (H mm)	75/65/20 (Watt) (Φ50K)	55/45/20 (Watt) (Φ30K)	n-exp.	gewicht (kg)	inhoud (l)	el. weerst. (Watt)	prijs RAL 9016 (€)	verkorte ref. nr. RAL 9016 voorraad	
REF. NR. ZANA VERTICAAL ZV-1 : 254												
254 030 140 XX YY 00	8	304	1400	680	359	1,27	18,16	8,24	-	527	-	606
	8	304	1600	769	406	1,27	20,72	9,44	-	573	-	659
	8	304	1800	859	454	1,28	23,20	10,64	-	618	-	711
	8	304	2000	950	502	1,28	25,68	11,68	-	665	-	765
	8	304	2200	1042	550	1,28	28,08	12,72	-	710	-	817
	8	304	2400	1136	600	1,29	30,56	13,76	-	758	-	872
	8	304	2600	1231	650	1,29	33,04	14,80	-	802	-	922
	8	304	2800	1327	701	1,29	35,44	15,84	-	848	-	975
	8	304	3000	1426	753	1,29	37,92	16,88	-	897	-	1032
254 038 140 XX YY 00	10	384	1400	850	449	1,27	22,70	10,30	-	631	-	726
	10	384	1600	962	508	1,27	25,90	11,80	-	691	-	795
	10	384	1800	1074	567	1,28	29,00	13,30	-	747	11254-03	859
	10	384	2000	1188	627	1,28	32,10	14,60	-	806	-	927
	10	384	2200	1303	688	1,28	35,10	15,90	-	860	-	989
	10	384	2400	1420	750	1,29	38,20	17,20	-	921	-	1059
	10	384	2600	1539	813	1,29	41,30	18,50	-	980	-	1127
	10	384	2800	1659	876	1,29	44,30	19,80	-	1037	-	1193
	10	384	3000	1782	941	1,29	47,40	21,10	-	1094	-	1258
254 046 140 XX YY 00	12	464	1400	1020	539	1,27	27,24	12,36	-	740	-	851
	12	464	1600	1154	609	1,27	31,08	14,16	-	808	-	929
	12	464	1800	1289	681	1,28	34,80	15,96	-	877	11254-12	1009
	12	464	2000	1425	752	1,28	38,52	17,52	-	947	11254-01	1089
	12	464	2200	1563	825	1,28	42,12	19,08	-	1016	-	1168
	12	464	2400	1704	900	1,29	45,84	20,64	-	1084	-	1247
	12	464	2600	1846	975	1,29	49,56	22,20	-	1150	-	1323
	12	464	2800	1991	1051	1,29	53,16	23,76	-	1221	-	1404
	12	464	3000	2139	1130	1,29	56,88	25,32	-	1293	-	1487
254 054 140 XX YY 00	14	544	1400	1190	628	1,27	31,78	14,42	-	843	-	969
	14	544	1600	1346	711	1,27	36,26	16,52	-	924	-	1063
	14	544	1800	1504	794	1,28	40,60	18,62	-	1004	11254-07	1155
	14	544	2000	1663	878	1,28	44,94	20,44	-	1085	11254-08	1248
	14	544	2200	1824	963	1,28	49,14	22,26	-	1169	-	1344
	14	544	2400	1988	1050	1,29	53,48	24,08	-	1247	-	1434
	14	544	2600	2154	1137	1,29	57,82	25,90	-	1328	-	1527
	14	544	2800	2323	1227	1,29	62,02	27,72	-	1409	-	1620
	14	544	3000	2495	1318	1,29	66,36	29,54	-	1489	-	1712
254 062 140 XX YY 00	16	624	1400	1360	718	1,27	36,32	16,48	-	950	-	1093
	16	624	1600	1539	813	1,27	41,44	18,88	-	1043	-	1199
	16	624	1800	1719	908	1,28	46,40	21,28	-	1136	11254-09	1306
	16	624	2000	1900	1003	1,28	51,36	23,36	-	1226	11254-02	1410
	16	624	2200	2085	1101	1,28	56,16	25,44	-	1320	-	1518
	16	624	2400	2272	1200	1,29	61,12	27,52	-	1410	-	1622
	16	624	2600	2462	1300	1,29	66,08	29,60	-	1504	-	1730
	16	624	2800	2655	1402	1,29	70,88	31,68	-	1595	-	1834
	16	624	3000	2852	1506	1,29	75,84	33,76	-	1687	-	1940

Conform EN442-1: 2014: radiatoren en convectoren

Voor meer details over onze artikel-data, zie artikel-database: <https://www.2ba.nl>

Voor de warmteafgiftes van andere regimes, kijkt u op p. 346 (correctiefactoren)
NEDERLAND. Prijzen in euro (excl. BTW)

HOE ZANA VERTICAAL BESTELLEN
Leveringstermijn 15 - 30 werkdagen
(zonder transportduur)

ZANA VERTICAAL (ZV-1)

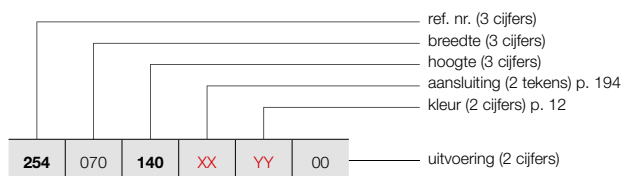

ZV-1

PRIJSGROEP: VPG2 - STAAL DESIGNRADIATOREN

BESTELCODE MAATWERK ZANA VERTICAAL						TECHNISCHE GEGEVENS							STANDAARDKLEUR	ANDERE KLEUREN		
						buizen	breedte (L mm)	hoogte (H mm)	75/65/20 (Watt) (φ50K)	55/45/20 (Watt) (φ30K)	n-exp.	gewicht (kg)	inhoud (l)	el. weerst. (Watt)	prijs RAL 9016 (€)	prijs kleur (€)
REF. NR. ZANA VERTICAAL ZV-1 : 254																
254	070	140	XX	YY	00	18	704	1400	1531	808	1,27	40,86	18,54	-	1055	1213
		160				18	704	1600	1731	914	1,27	46,62	21,24	-	1161	1335
		180				18	704	1800	1933	1021	1,28	52,20	23,94	-	1265	1455
		200				18	704	2000	2138	1129	1,28	57,78	26,28	-	1366	1571
		220				18	704	2200	2345	1238	1,28	63,18	28,62	-	1471	1692
		240				18	704	2400	2555	1349	1,29	68,76	30,96	-	1576	1812
		260				18	704	2600	2769	1462	1,29	74,34	33,30	-	1677	1929
		280				18	704	2800	2987	1577	1,29	79,74	35,64	-	1782	2049
		300				18	704	3000	3208	1694	1,29	85,32	37,98	-	1887	2170
		254				078	140	XX	YY	00	20	784	1400	1701	898	1,27
160	20		784	1600	1923		1015				1,27	51,80	23,60	-	1279	1471
180	20		784	1800	2148		1134				1,28	58,00	26,60	-	1393	1602
200	20		784	2000	2375		1254				1,28	64,20	29,20	-	1509	1735
220	20		784	2200	2606		1376				1,28	70,20	31,80	-	1622	1865
240	20		784	2400	2839		1499				1,29	76,40	34,40	-	1738	1999
260	20		784	2600	3077		1625				1,29	82,60	37,00	-	1852	2130
280	20		784	2800	3319		1753				1,29	88,60	39,60	-	1969	2264
300	20		784	3000	3564		1882				1,29	94,80	42,20	-	2084	2397
254	086		140	XX	YY		00				22	864	1400	1871	988	1,27
		160	22			864		1600	2116	1117	1,27	56,98	25,96	-	1394	1603
		180	22			864		1800	2363	1248	1,28	63,80	29,26	-	1522	1750
		200	22			864		2000	2613	1380	1,28	70,62	32,12	-	1651	1899
		220	22			864		2200	2866	1513	1,28	77,22	34,98	-	1776	2042
		240	22			864		2400	3123	1649	1,29	84,04	37,84	-	1903	2188
		260	22			864		2600	3385	1788	1,29	90,86	40,70	-	2027	2331
		280	22			864		2800	3650	1927	1,29	97,46	43,56	-	2155	2478
		300	22			864		3000	3921	2071	1,29	104,28	46,42	-	2281	2623
		254	094			140		XX	YY	00	24	944	1400	2041	1078	1,27
160	24			944	1600	2308	1219				1,27	62,16	28,32	-	1512	1739
180	24			944	1800	2578	1361				1,28	69,60	31,92	-	1652	1900
200	24			944	2000	2850	1505				1,28	77,04	35,04	-	1788	2056
220	24			944	2200	3127	1651				1,28	84,24	38,16	-	1926	2215
240	24			944	2400	3407	1799				1,29	91,68	41,28	-	2066	2376
260	24			944	2600	3692	1950				1,29	99,12	44,40	-	2202	2532
280	24			944	2800	3982	2103				1,29	106,32	47,52	-	2344	2696
300	24			944	3000	4277	2259				1,29	113,76	50,64	-	2479	2851
254	102			140	XX	YY	00				26	1024	1400	2211	1168	1,27
		160	26	1024				1600	2500	1320	1,27	67,34	30,68	-	1628	1872
		180	26	1024				1800	2793	1475	1,28	75,40	34,58	-	1779	2046
		200	26	1024				2000	3088	1631	1,28	83,46	37,96	-	1930	2220
		220	26	1024				2200	3388	1789	1,28	91,26	41,34	-	2079	2391
		240	26	1024				2400	3691	1949	1,29	99,32	44,72	-	2229	2563
		260	26	1024				2600	4000	2112	1,29	107,38	48,10	-	2378	2735
		280	26	1024				2800	4314	2278	1,29	115,18	51,48	-	2530	2910
		300	26	1024				3000	4634	2447	1,29	123,24	54,86	-	2677	3079

Conform EN442-1: 2014: radiatoren en convectoren

Voor meer details over onze artikel-data, zie artikel-database: <https://www.2ba.nl>

Voor de warmteafgiftes van andere regimes, kijkt u op p. 346 (correctiefactoren)
NEDERLAND. Prijzen in euro (excl. BTW)

ZANA VERTICAAL (ZV-2)



ZV-2

HOE ZANA VERTICAAL BESTELLEN

Leveringstermijn 15 - 30 werkdagen
(zonder transportduur)

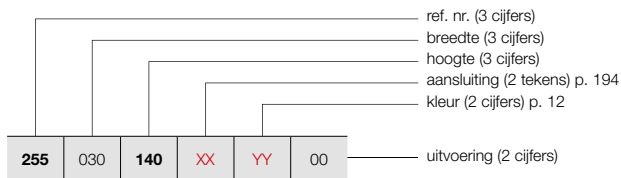

HOE VOORRAADRADIATOR ZANA VERTICAAL BESTELLEN

Leveringstermijn 5 werkdagen
(zonder transportduur)

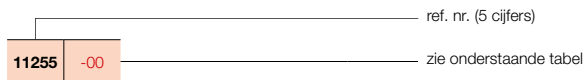

PRIJSGROEP: VPG2 - STAAL DESIGNRADIATOREN

BESTELCODE MAATWERK ZANA VERTICAAL	TECHNISCHE GEGEVENS									STANDAARDKLEUR		ANDERE KLEUREN
	buizen	breedte (L mm)	hoogte (H mm)	75/65/20 (Watt) (Φ50K)	55/45/20 (Watt) (Φ30K)	n-exp.	gewicht (kg)	inhoud (l)	el. weerst. (Watt)	prijs RAL 9016 (€)	verkorte ref. nr. RAL 9016 voorraad	
REF. NR. ZANA VERTICAAL ZV-2 : 255												
255 030 140 XX YY 00	8	304	1400	1105	584	1,30	35,20	16,16	-	897	-	1032
	8	304	1600	1242	656	1,30	40,16	18,40	-	974	-	1120
	8	304	1800	1379	728	1,30	45,12	20,64	-	1053	-	1211
	8	304	2000	1515	800	1,30	50,00	23,28	-	1132	-	1302
	8	304	2200	1651	872	1,30	54,80	25,92	-	1211	-	1393
	8	304	2400	1788	944	1,30	59,68	28,56	-	1285	-	1478
	8	304	2600	1925	1017	1,30	64,48	31,12	-	1365	-	1570
	8	304	2800	2062	1089	1,30	69,36	33,76	-	1444	-	1661
	8	304	3000	2200	1162	1,30	74,16	36,40	-	1524	-	1753
255 038 140 XX YY 00	10	384	1400	1381	729	1,30	44,00	20,20	-	1076	-	1237
	10	384	1600	1553	820	1,30	50,20	23,00	-	1176	-	1352
	10	384	1800	1724	910	1,30	56,40	25,80	-	1273	-	1464
	10	384	2000	1894	1000	1,30	62,50	29,10	-	1369	-	1574
	10	384	2200	2064	1090	1,30	68,50	32,40	-	1467	-	1687
	10	384	2400	2235	1180	1,30	74,60	35,70	-	1566	-	1801
	10	384	2600	2406	1271	1,30	80,60	38,90	-	1663	-	1912
	10	384	2800	2577	1361	1,30	86,70	42,20	-	1759	-	2023
	10	384	3000	2750	1452	1,30	92,70	45,50	-	1861	-	2140
255 046 140 XX YY 00	12	464	1400	1657	875	1,30	52,80	24,24	-	1256	-	1444
	12	464	1600	1863	984	1,30	60,24	27,60	-	1373	-	1579
	12	464	1800	2068	1092	1,30	67,68	30,96	-	1489	-	1712
	12	464	2000	2273	1200	1,30	75,00	34,92	-	1607	-	1848
	12	464	2200	2477	1308	1,30	82,20	38,88	-	1729	-	1988
	12	464	2400	2682	1416	1,30	89,52	42,84	-	1845	-	2122
	12	464	2600	2887	1525	1,30	96,72	46,68	-	1962	-	2256
	12	464	2800	3093	1633	1,30	104,04	50,64	-	2079	-	2391
	12	464	3000	3300	1743	1,30	111,24	54,60	-	2197	-	2527
255 054 140 XX YY 00	14	544	1400	1933	1021	1,30	61,60	28,28	-	1434	-	1649
	14	544	1600	2174	1148	1,30	70,28	32,20	-	1575	-	1811
	14	544	1800	2413	1274	1,30	78,96	36,12	-	1706	-	1962
	14	544	2000	2651	1400	1,30	87,50	40,74	-	1847	11255-02	2124
	14	544	2200	2890	1526	1,30	95,90	45,36	-	1984	-	2282
	14	544	2400	3129	1652	1,30	104,44	49,98	-	2121	-	2439
	14	544	2600	3368	1779	1,30	112,84	54,46	-	2258	-	2597
	14	544	2800	3608	1905	1,30	121,38	59,08	-	2397	-	2757
	14	544	3000	3849	2033	1,30	129,78	63,70	-	2533	-	2913
255 062 140 XX YY 00	16	624	1400	2209	1167	1,30	70,40	32,32	-	1616	-	1858
	16	624	1600	2484	1312	1,30	80,32	36,80	-	1773	-	2039
	16	624	1800	2758	1456	1,30	90,24	41,28	-	1931	-	2221
	16	624	2000	3030	1600	1,30	100,00	46,56	-	2088	-	2401
	16	624	2200	3303	1744	1,30	109,60	51,84	-	2243	-	2579
	16	624	2400	3576	1888	1,30	119,36	57,12	-	2399	-	2759
	16	624	2600	3849	2033	1,30	128,96	62,24	-	2554	-	2937
	16	624	2800	4124	2178	1,30	138,72	67,52	-	2711	-	3118
	16	624	3000	4399	2323	1,30	148,32	72,80	-	2868	-	3298

Conform EN442-1: 2014: radiatoren en convectoren

Voor meer details over onze artikel-data, zie artikel-database: <https://www.2ba.nl>

Voor de warmteafgiftes van andere regimes, kijkt u op p. 346 (correctiefactoren)
NEDERLAND. Prijzen in euro (excl. BTW)

HOE ZANA VERTICAAL BESTELLEN

Leveringstermijn 15 - 30 werkdagen
(zonder transportduur)

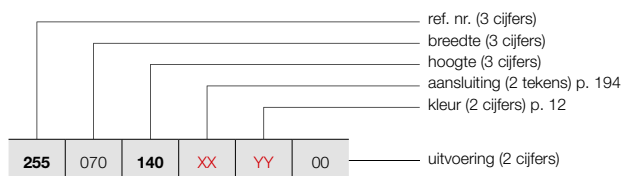

ZANA VERTICAAL (ZV-2)



ZV-2

HOE VOORRAADRADIATOR ZANA VERTICAAL BESTELLEN

Leveringstermijn 5 werkdagen
(zonder transportduur)

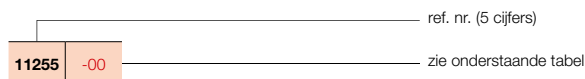

PRIJSGROEP: VPG2 - STAAL DESIGNRADIATOREN

BESTELCODE MAATWERK ZANA VERTICAAL	TECHNISCHE GEGEVENS							STANDAARDKLEUR		ANDERE KLEUREN		
	buizen	breedte (L mm)	hoogte (H mm)	75/65/20 (Watt) (φ50K)	55/45/20 (Watt) (φ30K)	n-exp.	gewicht (kg)	inhoud (l)	el. weerst. (Watt)		prijs RAL 9016 (€)	verkorte ref. nr. RAL 9016 voorraad
REF. NR. ZANA VERTICAAL ZV-2 : 255												
255 070 140 XX YY 00	18	704	1400	2486	1313	1,30	79,20	36,36	-	1793	-	2062
160	18	704	1600	2795	1476	1,30	90,36	41,40	-	1972	-	2268
180	18	704	1800	3102	1638	1,30	101,52	46,44	-	2150	-	2473
200	18	704	2000	3409	1800	1,30	112,50	52,38	-	2321	11255-01	2669
220	18	704	2200	3716	1962	1,30	123,30	58,32	-	2500	-	2875
240	18	704	2400	4023	2124	1,30	134,28	64,26	-	2678	-	3080
260	18	704	2600	4330	2287	1,30	145,08	70,02	-	2850	-	3278
280	18	704	2800	4639	2450	1,30	156,06	75,96	-	3029	-	3483
255 078 140 XX YY 00	20	784	1400	2762	1459	1,30	88,00	40,40	-	1975	-	2271
160	20	784	1600	3105	1640	1,30	100,40	46,00	-	2173	-	2499
180	20	784	1800	3447	1820	1,30	112,80	51,60	-	2367	-	2722
200	20	784	2000	3788	2000	1,30	125,00	58,20	-	2562	-	2946
220	20	784	2200	4129	2180	1,30	137,00	64,80	-	2758	-	3172
240	20	784	2400	4470	2360	1,30	149,20	71,40	-	2955	-	3398
260	20	784	2600	4812	2541	1,30	161,20	77,80	-	3149	-	3621
255 086 140 XX YY 00	22	864	1400	3038	1604	1,30	96,80	44,44	-	2157	-	2481
160	22	864	1600	3416	1804	1,30	110,44	50,60	-	2370	-	2726
180	22	864	1800	3792	2002	1,30	124,08	56,76	-	2587	-	2975
200	22	864	2000	4167	2200	1,30	137,50	64,02	-	2802	-	3222
220	22	864	2200	4541	2398	1,30	150,70	71,28	-	3016	-	3468
255 094 140 XX YY 00	24	944	1400	3314	1750	1,30	105,60	48,48	-	2339	-	2690
160	24	944	1600	3726	1968	1,30	120,48	55,20	-	2574	-	2960
180	24	944	1800	4136	2184	1,30	135,36	61,92	-	2804	-	3225
200	24	944	2000	4545	2400	1,30	150,00	69,84	-	3039	-	3495
255 102 140 XX YY 00	26	1024	1400	3590	1896	1,30	114,40	52,52	-	2516	-	2893
160	26	1024	1600	4037	2132	1,30	130,52	59,80	-	2768	-	3183
180	26	1024	1800	4481	2366	1,30	146,64	67,08	-	3023	-	3476

Conform EN442-1: 2014: radiatoren en convectoren

Voor meer details over onze artikel-data, zie artikel-database: <https://www.2ba.nl>

Voor de warmteafgiftes van andere regimes, kijkt u op p. 346 (correctiefactoren)
NEDERLAND. Prijzen in euro (excl. BTW)

ZANA HORIZONTAAL (ZH-1, ZH-2)



TYPES

- Eén (ZH-1) of twee rijen buizen (ZH-2)

BUIZEN

- Verticaal, rechthoekig 45 x 20 mm
- Opgelet: horizontale vormgeving, maar steeds met verticale buizen!

COLLECTOREN

- Horizontaal, achterliggend, rond Ø 35 mm

KLEUREN

- Standaardkleur wit RAL 9016
- Uitgebreide kleurenkaart zie p. 12

SPECIAAL

- ZH-1 ook verkrijgbaar als toiletradiator (384 x 500 mm)

BEVESTIGINGEN

- Muurbevestigingen standaard

TECHNISCH

- Elektrisch lasergelast (onzichtbare lasnaden)
- KTL-grondlaag, poedercoating
- Standaardwerkdruk: 4 bar
- Maximale bedrijfstemperatuur: 110°C

ELEKTRISCH

- ✗ Zuiver elektrische radiator in de fabriek voorgevuld
- ✗ Gemengde radiator

TECHNISCHE TEKENINGEN

- Zie p. 195

AANSLUITING

- ✗ Eénpuntsaansluiting voor éénpijpsysteem
- ✗ Eénpuntsaansluiting voor tweepijpsysteem
- ✗ Tweepuntsaansluiting voor éénpijpsysteem
- ✓ Tweepuntsaansluiting voor tweepijpsysteem (standaard) (zie p. 340)
- ✗ Geïntegreerd ventiel
- Aansluitingen: ½" (binnendraad)

ZANA HORIZONTAAL

Mooi tot in lengte van dagen

Ook in de horizontale uitvoering is de Zana designradiator een toonbeeld van klasse, kracht en comfort. De verticale buizen en de horizontale collectoren vormen samen een mooi gestructureerd geometrisch geheel en dragen bij tot de specifieke Zana retro-look. De Zana Horizontaal is verkrijgbaar met 1 of 2 rijen buizen en in een aparte toiletversie.

AANBEVOLEN AANSLUITING (18)

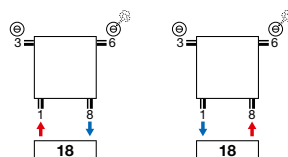

Andere aansluitmogelijkheden, zie p. 194



art. nr. 1182 101 0000 0099

prijs € 215

Koppelingen, zie p. 353

AANBEVOLEN VOOR BADKAMER EN KEUKEN IN OPTIE



handdoekbeugel recht (chrom) art. nr. zie p. 193

prijs € 185

Andere accessoires, zie p. 193



HOE ZANA HORIZONTAAL BESTELLEN

Leveringstermijn 15 - 30 werkdagen
(zonder transportduur)

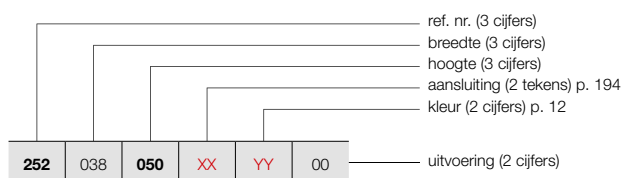

ZANA HORIZONTAAL (ZH-1)



ZH-1

PRIJSGROEP: VPG2 - STAAL DESIGNRADIATOREN

BESTELCODE MAATWERK ZANA HORIZONTAAL	TECHNISCHE GEGEVENS							STANDAARDKLEUR		ANDERE KLEUREN						
	buizen	breedte (L mm)	hoogte (H mm)	75/65/20 (Watt) (Φ50K)	55/45/20 (Watt) (Φ30K)	n-exp.	gewicht (kg)	inhoud (l)	el. weerst. (Watt)	prijs RAL 9016 (€)	prijs kleur (€)					
REF. NR. ZANA HORIZONTAAL ZH-1 : 252																
252	038	050	XX	YY	00	10	384	500	347	183	1,25	9,00	4,10	-	375	431
252	070	050	XX	YY	00	18	704	500	624	330	1,25	16,20	7,38	-	592	681
		060				18	704	600	728	384	1,25	18,90	8,46	-	643	739
		070				18	704	700	831	439	1,25	21,60	9,72	-	693	797
252	078	050	XX	YY	00	20	784	500	694	366	1,25	18,00	8,20	-	644	741
		060				20	784	600	809	427	1,25	21,00	9,40	-	701	806
		070				20	784	700	923	487	1,25	24,00	10,80	-	759	873
252	086	050	XX	YY	00	22	864	500	763	403	1,25	19,80	9,02	-	696	800
		060				22	864	600	890	470	1,25	23,10	10,34	-	761	875
		070				22	864	700	1015	536	1,25	26,40	11,88	-	823	946
252	094	050	XX	YY	00	24	944	500	832	439	1,25	21,60	9,84	-	752	865
		060				24	944	600	971	513	1,25	25,20	11,28	-	821	944
		070				24	944	700	1107	585	1,25	28,80	12,96	-	891	1025
252	102	050	XX	YY	00	26	1024	500	902	476	1,25	23,40	10,66	-	806	927
		060				26	1024	600	1052	556	1,25	27,30	12,22	-	882	1014
		070				26	1024	700	1200	634	1,25	31,20	14,04	-	956	1099
252	110	050	XX	YY	00	28	1104	500	971	513	1,25	25,20	11,48	-	858	987
		060				28	1104	600	1133	598	1,25	29,40	13,16	-	941	1082
		070				28	1104	700	1292	682	1,25	33,60	15,12	-	1020	1173
252	118	050	XX	YY	00	30	1184	500	1040	549	1,25	27,00	12,30	-	914	1051
		060				30	1184	600	1214	641	1,25	31,50	14,10	-	1000	1150
		070				30	1184	700	1384	731	1,25	36,00	16,20	-	1085	1248
252	126	050	XX	YY	00	32	1264	500	1110	586	1,25	28,80	13,12	-	969	1114
		060				32	1264	600	1295	684	1,25	33,60	15,04	-	1061	1220
		070				32	1264	700	1476	779	1,25	38,40	17,28	-	1149	1321
252	142	050	XX	YY	00	36	1424	500	1248	659	1,25	32,40	14,76	-	1076	1237
		060				36	1424	600	1457	769	1,25	37,80	16,92	-	1179	1356
		070				36	1424	700	1661	877	1,25	43,20	19,44	-	1283	1475
252	158	050	XX	YY	00	40	1584	500	1387	732	1,25	36,00	16,40	-	1184	1362
		060				40	1584	600	1618	854	1,25	42,00	18,80	-	1299	1494
		070				40	1584	700	1846	975	1,25	48,00	21,60	-	1413	1625
252	174	050	XX	YY	00	44	1744	500	1526	806	1,25	39,60	18,04	-	1293	1487
		060				44	1744	600	1780	940	1,25	46,20	20,68	-	1420	1633
		070				44	1744	700	2030	1072	1,25	52,80	23,76	-	1545	1777
252	190	050	XX	YY	00	48	1904	500	1665	879	1,25	43,20	19,68	-	1401	1611
		060				48	1904	600	1942	1026	1,25	50,40	22,56	-	1539	1770
		070				48	1904	700	2215	1170	1,25	57,60	25,92	-	1676	1927

Conform EN442-1: 2014: radiatoren en convectoren

Voor meer details over onze artikel-data, zie artikel-database: <https://www.2ba.nl>

Voor de warmteafgiftes van andere regimes, kijkt u op p. 346 (correctiefactoren)
 NEDERLAND. Prijzen in euro (excl. BTW)

ZANA HORIZONTAAL (ZH-1)



ZH-1

HOE ZANA HORIZONTAAL BESTELLEN

Leveringstermijn 15 - 30 werkdagen
(zonder transportduur)

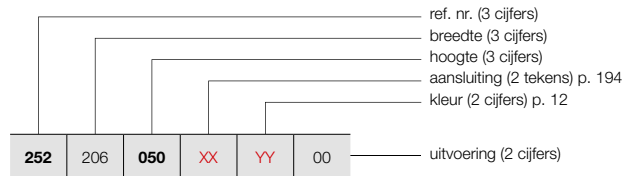

PRIJSGROEP: VPG2 - STAAL DESIGNRADIATOREN

BESTELCODE MAATWERK ZANA HORIZONTAAL	TECHNISCHE GEGEVENS									STANDAARDKLEUR	ANDERE KLEUREN	
	buizen	breedte (L mm)	hoogte (H mm)	75/65/20 (Watt) (Φ50K)	55/45/20 (Watt) (Φ30K)	n-exp.	gewicht (kg)	inhoud (l)	el. weerst. (Watt)	prijs RAL 9016 (€)	prijs kleur (€)	
REF. NR. ZANA HORIZONTAAL ZH-1 : 252												
252 206 050 XX YY 00	060	52	2064	500	1803	952	1,25	46,80	21,32	-	1509	1735
	070	52	2064	600	2104	1111	1,25	54,60	24,44	-	1658	1907
		52	2064	700	2399	1267	1,25	62,40	28,08	-	1808	2079
252 222 050 XX YY 00	060	56	2224	500	1942	1026	1,25	50,40	22,96	-	1618	1861
	070	56	2224	600	2266	1197	1,25	58,80	26,32	-	1778	2045
		56	2224	700	2584	1365	1,25	67,20	30,24	-	1939	2230
252 238 050 XX YY 00	060	60	2384	500	2081	1099	1,25	54,00	24,60	-	1726	1985
	070	60	2384	600	2428	1282	1,25	63,00	28,20	-	1896	2180
		60	2384	700	2768	1462	1,25	72,00	32,40	-	2069	2379
252 254 050 XX YY 00	060	64	2544	500	2220	1172	1,25	57,60	26,24	-	1833	2108
	070	64	2544	600	2589	1367	1,25	67,20	30,08	-	2017	2320
		64	2544	700	2953	1559	1,25	76,80	34,56	-	2200	2530
252 270 050 XX YY 00	060	68	2704	500	2358	1245	1,25	61,20	27,88	-	1940	2231
	070	68	2704	600	2751	1453	1,25	71,40	31,96	-	2135	2455
		68	2704	700	3138	1657	1,25	81,60	36,72	-	2331	2681
252 286 050 XX YY 00	060	72	2864	500	2497	1319	1,25	64,80	29,52	-	2049	2356
	070	72	2864	600	2913	1538	1,25	75,60	33,84	-	2255	2593
		72	2864	700	3322	1754	1,25	86,40	38,88	-	2462	2831

Conform EN442-1: 2014: radiatoren en convectoren

Voor meer details over onze artikel-data, zie artikel-database: <https://www.2ba.nl>

**Voor de warmteafgiftes van andere regimes, kijkt u op p. 346 (correctiefactoren)
NEDERLAND. Prijzen in euro (excl. BTW)**

HOE ZANA HORIZONTAAL BESTELLEN

Leveringstermijn 15 - 30 werkdagen
(zonder transportduur)

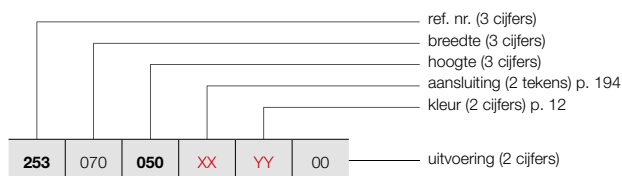

ZANA HORIZONTAAL (ZH-2)



ZH-2

PRIJSGROEP: VPG2 - STAAL DESIGNRADIATOREN

BESTELCODE MAATWERK ZANA HORIZONTAAL	TECHNISCHE GEGEVENS							STANDAARDKLEUR	ANDERE KLEUREN		
	buizen	breedte (L mm)	hoogte (H mm)	75/65/20 (Watt) (Φ50K)	55/45/20 (Watt) (Φ30K)	n-exp.	gewicht (kg)			inhoud (l)	el. weerst. (Watt)
REF. NR. ZANA HORIZONTAAL ZH-2 : 253											
253 070 050 XX YY 00	18	704	500	1035	547	1,28	30,42	13,50	-	1003	1153
	18	704	600	1205	636	1,28	35,64	16,02	-	1092	1256
	18	704	700	1372	725	1,28	41,04	18,54	-	1179	1356
253 078 050 XX YY 00	20	784	500	1150	607	1,28	33,80	15,00	-	1094	1258
	20	784	600	1339	707	1,28	39,60	17,80	-	1194	1373
	20	784	700	1525	805	1,28	45,60	20,60	-	1292	1486
253 086 050 XX YY 00	22	864	500	1265	668	1,28	37,18	16,50	-	1185	1363
	22	864	600	1473	778	1,28	43,56	19,58	-	1295	1489
	22	864	700	1677	886	1,28	50,16	22,66	-	1404	1615
253 094 050 XX YY 00	24	944	500	1380	729	1,28	40,56	18,00	-	1280	1472
	24	944	600	1607	849	1,28	47,52	21,36	-	1398	1608
	24	944	700	1830	966	1,28	54,72	24,72	-	1513	1740
253 102 050 XX YY 00	26	1024	500	1494	789	1,28	43,94	19,50	-	1369	1574
	26	1024	600	1741	919	1,28	51,48	23,14	-	1499	1724
	26	1024	700	1982	1047	1,28	59,28	26,78	-	1624	1868
253 110 050 XX YY 00	28	1104	500	1609	850	1,28	47,32	21,00	-	1461	1680
	28	1104	600	1875	990	1,28	55,44	24,92	-	1601	1841
	28	1104	700	2135	1127	1,28	63,84	28,84	-	1736	1996
253 118 050 XX YY 00	30	1184	500	1724	910	1,28	50,70	22,50	-	1552	1785
	30	1184	600	2009	1061	1,28	59,40	26,70	-	1701	1956
	30	1184	700	2287	1208	1,28	68,40	30,90	-	1847	2124
253 126 050 XX YY 00	32	1264	500	1839	971	1,28	54,08	24,00	-	1646	1893
	32	1264	600	2143	1132	1,28	63,36	28,48	-	1804	2075
	32	1264	700	2440	1288	1,28	72,96	32,96	-	1958	2252
253 142 050 XX YY 00	36	1424	500	2069	1093	1,28	60,84	27,00	-	1828	2102
	36	1424	600	2411	1273	1,28	71,28	32,04	-	2006	2307
	36	1424	700	2745	1450	1,28	82,08	37,08	-	2183	2510
253 158 050 XX YY 00	40	1584	500	2299	1214	1,28	67,60	30,00	-	2015	2317
	40	1584	600	2678	1414	1,28	79,20	35,60	-	2211	2543
	40	1584	700	3050	1611	1,28	91,20	41,20	-	2402	2762
253 174 050 XX YY 00	44	1744	500	2529	1335	1,28	74,36	33,00	-	2197	2527
	44	1744	600	2946	1556	1,28	87,12	39,16	-	2411	2773
	44	1744	700	3355	1772	1,28	100,32	45,32	-	2628	3022
253 190 050 XX YY 00	48	1904	500	2759	1457	1,28	81,12	36,00	-	2382	2739
	48	1904	600	3214	1697	1,28	95,04	42,72	-	2615	3007
	48	1904	700	3660	1933	1,28	109,44	49,44	-	2848	3275

Conform EN442-1: 2014: radiatoren en convectoren

Voor meer details over onze artikel-data, zie artikel-database: <https://www.2ba.nl>

Voor de warmteafgiftes van andere regimes, kijkt u op p. 346 (correctiefactoren)
NEDERLAND. Prijzen in euro (excl. BTW)

ZANA HORIZONTAAL (ZH-2)



ZH-2

HOE ZANA HORIZONTAAL BESTELLEN

Leveringstermijn 15 - 30 werkdagen
(zonder transportduur)

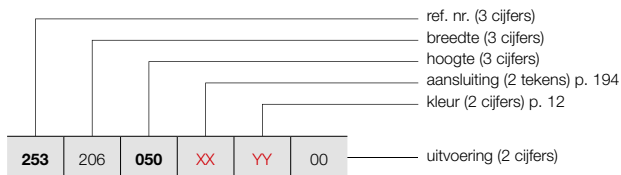

PRIJSGROEP: VPG2 - STAAL DESIGNRADIATOREN

BESTELCODE MAATWERK ZANA HORIZONTAAL	TECHNISCHE GEGEVENS									STANDAARDKLEUR	ANDERE KLEUREN
	buizen	breedte (L mm)	hoogte (H mm)	75/65/20 (Watt) (Φ50K)	55/45/20 (Watt) (Φ30K)	n-exp.	gewicht (kg)	inhoud (l)	el. weerst. (Watt)	prijs RAL 9016 (€)	prijs kleur (€)
REF. NR. ZANA HORIZONTAAL ZH-2 : 253											
253	206	050	XX	YY	00						
		060								2562	2946
		070								2821	3244
										3073	3534
253	222	050	XX	YY	00						
		060								2750	3163
		070								3021	3474
										3296	3790
253	238	050	XX	YY	00						
		060								2931	3371
		070								3226	3710
										3522	4050
253	254	050	XX	YY	00						
		060								3115	3582
		070								3430	3945
										3741	4302
253	270	050	XX	YY	00						
		060								3299	3794
		070								3631	4176
										3966	4561
253	286	050	XX	YY	00						
		060								3483	4005
										3834	4409

Conform EN442-1: 2014: radiatoren en convectoren

Voor meer details over onze artikel-data, zie artikel-database: <https://www.2ba.nl>

Voor de warmteafgifte van andere regimes, kijkt u op p. 346 (correctiefactoren)
NEDERLAND. Prijzen in euro (excl. BTW)

PRIJSGROEP: VPG10B - HANDDOEKBEUGELS

ACCESSOIRES	BREEDTE RADIATOR	KLEUR	ART. NR.	€
ZV-1 / ZV-2 / ZH-1 / ZH-2				
HANDDOEKBEUGEL RECHT		CHROOM	1183 228 0000 0099	185
<ul style="list-style-type: none"> h = 22 mm; b = 720 mm (zelf in te korten); d = 75 mm; a = 56 mm 				
ZV-1 / ZV-2 / ZH-1 / ZH-2				
KNOP		CHROOM	1183 410 0000 0099	87
<ul style="list-style-type: none"> h = 70 mm; b = 70 mm; d = 59 mm; a = 51 mm; 				
ZV-1				
HANDDOEKBEUGEL MULTI+ RECHTS	600 mm	S600	1183 734 0000 0600	201
	600 mm	RAL 9005 ^S	1183 734 0000 9005	201
<ul style="list-style-type: none"> h = 70 mm; b = 600 mm (b tablet = 194 mm); e = 176 mm; c = 170 mm; Bevestiging aan de muur, rechts van de radiator. 				
ZV-1				
HANDDOEKBEUGEL MULTI+ LINKS	600 mm	S600	1183 735 0000 0600	201
	600 mm	RAL 9005 ^S	1183 735 0000 9005	201
<ul style="list-style-type: none"> h = 70 mm; b = 600 mm (b tablet = 194 mm); e = 176 mm; c = 170 mm; Bevestiging aan de muur, links van de radiator. 				

^S structuur zwart

Montagevoorschriften accessoires: zie www.vasco.eu
NEDERLAND. Prijzen in euro (excl. BTW)

e = afstand voorkant accessoire tot wand
d = afstand voorkant accessoire tot voorkant radiator
c = afstand wand tot achterkant beugel
a = afstand accessoire tot radiator
uit voorraad leverbaar

ZANA VERTICAAL: ZV-1 / ZV-2 (VOORRAAD)

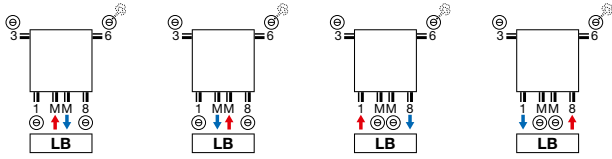

ZANA HORIZONTAAL: ZH-1 / ZH-2

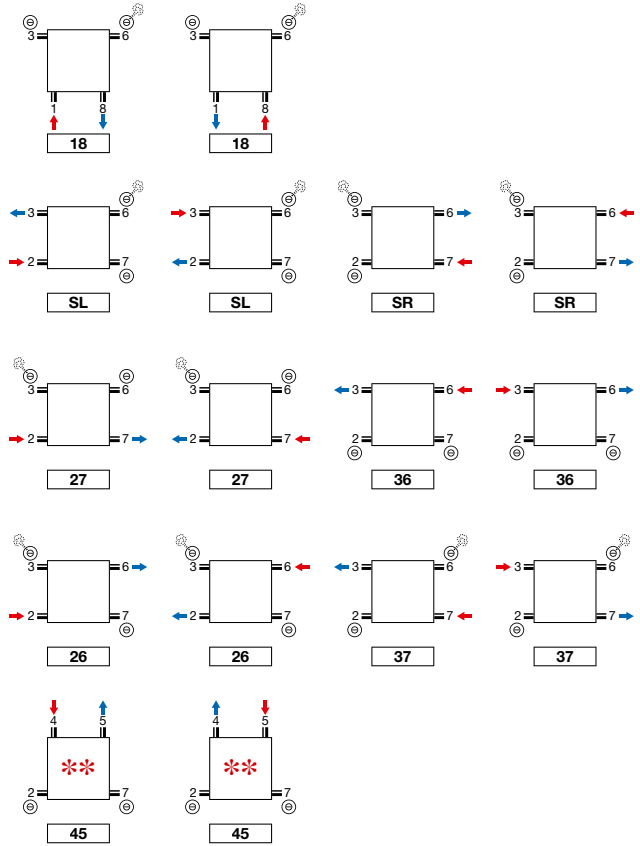

** Niet voor ZH-1 toiletradiator.

ZANA VERTICAAL: ZV-1 / ZV-2 (NIET-VOORRAAD)

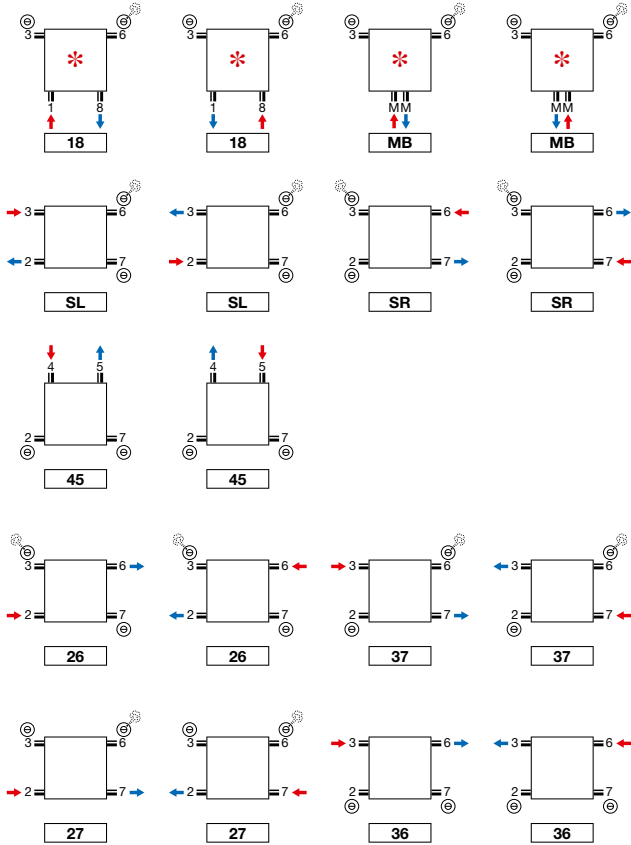

* Opmerking ZV-1/ZV-2 8 buizen: 2/3/6/7 altijd open.

Opmerking: het aansluiten van de radiator kan enkel volgens de getoonde aansluiticonen. Voor elke andere aansluitwijze nemen wij geen verantwoordelijkheid.

ZANA VERTICAAL (ZV-1, ZV-2)

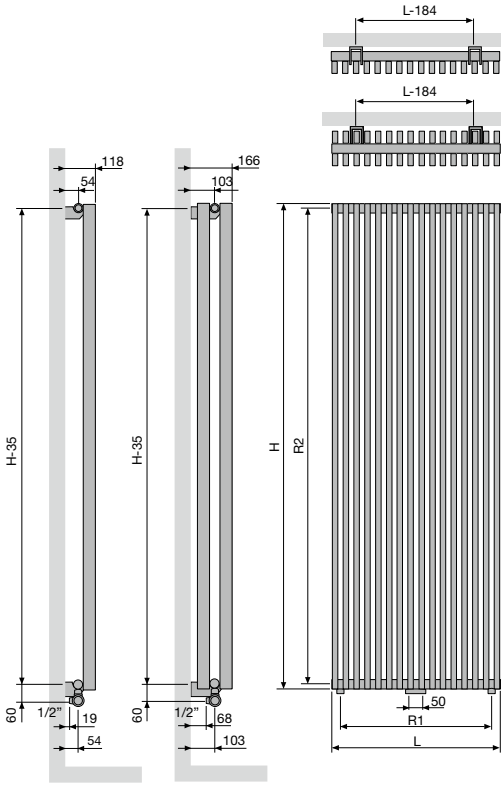

ZV-1 / ZV-2

aantal buizen	8	10	12	14	16	18	20	22	24	26
Breedte (L)	304	384	464	544	624	704	784	864	944	1024
Hartafstand tussen de onderaansluitingen 18 (R1)	240	320	400	480	560	640	720	800	880	960
hoogte (H)	1400	1600	1800	2000	2200	2400	2600	2800	3000	
Hartafstand tussen de zijaansluitingen SL/SR (R2)	1365	1565	1765	1965	2165	2365	2565	2765	2965	
Hartafstand tussen de ophangingen	L-184	H-35								

ZANA HORIZONTAAL (ZH-1, ZH-2)

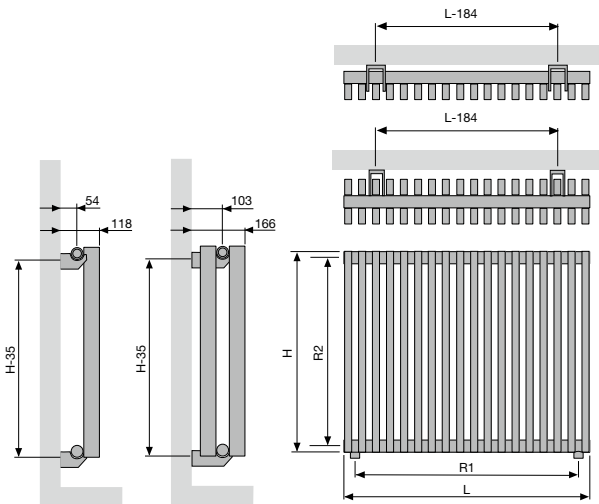

ZH-1 / ZH-2

Breedte (L)	384	704	784	864	944	1024	1104	1184	1264	1424	1584	1744	1904	2064	2224	2384	2544	2704	2864
Hartafstand tussen de onderaansluitingen 18 (R1)	320	640	720	800	880	960	1040	1120	1200	1360	1520	1680	1840	2000	2160	2320	2480	2640	2800
hoogte (H)	500	600	700																
Hartafstand tussen de zijaansluitingen SL/SR (R2)	465	565	665																
Hartafstand tussen de ophangingen	L-184	H-35																	

VIOLA-A VERTICAAL (V1-ZB-A, V1L1-ZB-A, V2-ZB-A)

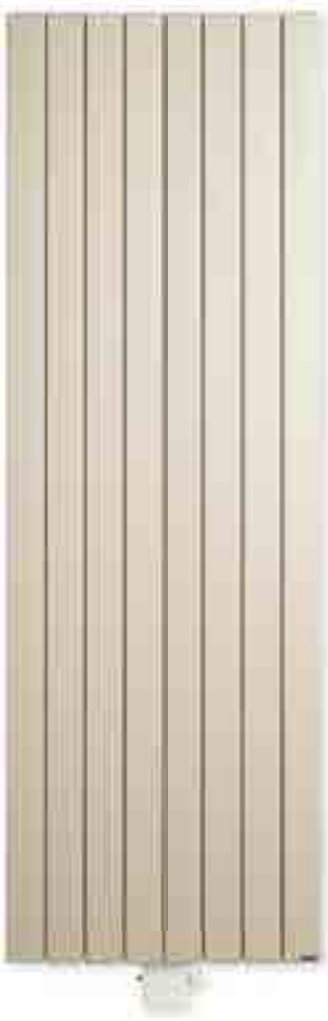

TYPES

- V1-ZB-A enkele rij buizen, V2-ZB-A dubbele rij buizen, V1L1-ZB-A met lamellen

BUIZEN

- Verticaal, rechthoekig 77 x 10 mm

COLLECTOREN

- V1-ZB-A: 35 x 43 mm
- V1L1-ZB-A: 35 x 43 mm
- V2-ZB-A: 35 x 41 mm

KLEUREN

- Standaardkleur wit RAL 9016
- Uitgebreide kleurenkaart zie p. 12

SPECIAAL

- Wordt standaard geleverd met 2 zijbekledingen.
- mm aansluiting alleen mogelijk bij even aantal buizen.
- Bij type V1L1-ZB-A is 1 rij stalen lamellen ter verhoging van de warmteafgifte op de platovale buizen gepuntlast.

BEVESTIGINGEN

- Muurbevestigingen standaard (inbegrepen in de verpakking van de radiator)
- Bovenste beugel in kleur van de radiator, onderaan:
 - Afstandshouder radiator wit = afstandshouder wit.
 - Afstandshouder radiator in kleur = afstandshouder RAL 7024.
- **V2-ZB-A:** Radiator met telescopische steunvoeten + variabele muurbevestiging: gelieve bij bestelling code **07** aan te geven bij "Afwerking" (zie p. 225).

TECHNISCH

- Weerstandsgelast (onzichtbare lasnaden)
- ATL-grondlaag, poedercoating
- Standaardwerkdruk: 4 bar. Meerprijs hogere werkdruk (10 bar): +10%
- De leveringstermijn van radiator met een hogere werkdruk is 1 week extra.
- Maximale bedrijfstemperatuur: 110°C

ELEKTRISCH

- ✗ Zuiver elektrische radiator in de fabriek vorgevuld
- ✗ Gemengde radiator

TECHNISCHE TEKENINGEN

- Zie p. 228

AANSLUITING

- ✗ Eénpuntsaansluiting voor éénpijpsysteem
- ✗ Eénpuntsaansluiting voor tweepijpsysteem
- ✓ Tweepuntsaansluiting voor éénpijpsysteem (aansluiting via de middenaansluiting) (zie p. 340)
- ✓ Tweepuntsaansluiting voor tweepijpsysteem (standaard) (zie p. 340)
- ✗ Geïntegreerd ventiel
- Aansluitingen: ½" (binnendraad)

VIOLA-A VERTICAAL

In de soberheid toont zich de klasse

Een buizenradiator die naadloos combineert met elke woonstijl, door zijn sobere klasse en zijn vanzelfsprekend design. De strak gelijkende voorkant en de ingewerkte zijpanelen staan borg voor een uniforme look en een optimale warmteafgifte. Viola-A, zo simpel, krachtig en aantrekkelijk kan verwarmingscomfort zijn.

AANBEVOLEN AANSLUITING (LM)

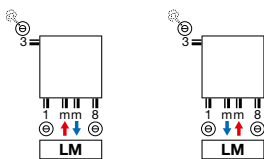

mm aansluiting alleen mogelijk bij even aantal buizen.
Andere aansluitmogelijkheden, zie p. 227



art. nr. 118200100009016
prijs €138
 Koppelingen, zie p. 353



art. nr. 11911630102
prijs €50

AANBEVOLEN VOOR BADKAMER EN KEUKEN IN OPTIE



handdoekbeugel (RAL 9005)
 art. nr. zie p. 226
prijs €145
Andere accessoires, zie p. 226



HOE VIOLA-A VERTICAAL BESTELLEN

Leveringstermijn 15 - 30 werkdagen
(zonder transportduur)

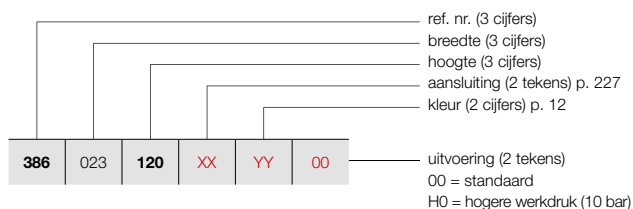

HOE VOORRAADRADIATOR VIOLA-A VERTICAAL BESTELLEN

Leveringstermijn 5 werkdagen
(zonder transportduur)

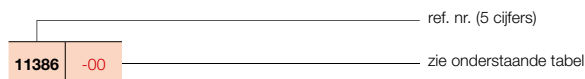

VIOLA-A VERTICAAL (V1-ZB-A)



V1-ZB-A

PRIJSGROEP: VPG2 - STAAL DESIGNRADIATOREN

BESTELCODE MAATWERK VIOLA-A VERTICAAL	TECHNISCHE GEGEVENS									STANDAARDKLEUR		ANDERE KLEUREN					
	buizen	breedte (L mm)	hoogte (H mm)	75/65/20 (Watt) (Φ50K)	55/45/20 (Watt) (Φ30K)	n-exp.	gewicht (kg)	inhoud (l)	el. weerst. (Watt)	prijs RAL 9016 (€)	verkorte ref. nr. RAL 9016 voorraad		prijs kleur (€)				
REF. NR. VIOLA-A VERTICAAL V1-ZB-A : 386																	
386	023	120	XX	YY	00	3	237	1200	371	189	1,32	7,80	2,40	-	369	-	424
		140				3	237	1400	427	218	1,32	9,00	2,73	-	403	-	463
		160				3	237	1600	483	246	1,32	9,90	3,03	-	436	-	501
		180				3	237	1800	535	273	1,32	11,10	3,33	-	471	-	542
		200				3	237	2000	589	301	1,30	12,30	3,60	-	503	-	578
		220				3	237	2200	640	327	1,28	13,50	3,90	-	531	-	611
		240				3	237	2400	689	352	1,27	14,40	4,20	-	567	-	652
386	031	120	XX	YY	00	4	317	1200	480	245	1,31	10,40	3,20	-	436	-	501
		140				4	317	1400	551	281	1,31	12,00	3,64	-	476	-	547
		160				4	317	1600	624	318	1,31	13,20	4,04	-	519	-	597
		180				4	317	1800	695	355	1,32	14,80	4,44	-	558	-	642
		200				4	317	2000	764	390	1,30	16,40	4,80	-	602	-	692
		220				4	317	2200	831	424	1,29	18,00	5,20	-	642	-	738
		240				4	317	2400	894	456	1,27	19,20	5,60	-	684	-	787
386	039	120	XX	YY	00	5	397	1200	585	298	1,31	13,00	4,00	-	503	-	578
		140				5	397	1400	673	343	1,31	15,00	4,55	-	552	-	635
		160				5	397	1600	762	389	1,31	16,50	5,05	-	602	-	692
		180				5	397	1800	850	434	1,31	18,50	5,55	-	649	-	746
		200				5	397	2000	936	478	1,30	20,50	6,00	-	699	-	804
		220				5	397	2200	1017	519	1,29	22,50	6,50	-	747	-	859
		240				5	397	2400	1094	558	1,28	24,00	7,00	-	798	-	918
386	047	120	XX	YY	00	6	477	1200	689	352	1,31	15,60	4,80	-	567	-	652
		140				6	477	1400	792	404	1,31	18,00	5,46	-	622	-	715
		160				6	477	1600	897	458	1,31	19,80	6,06	-	684	-	787
		180				6	477	1800	1003	512	1,31	22,20	6,66	-	741	-	852
		200				6	477	2000	1104	563	1,30	24,60	7,20	-	798	11386-01	918
		220				6	477	2200	1200	612	1,29	27,00	7,80	-	854	-	982
		240				6	477	2400	1291	659	1,28	28,80	8,40	-	913	-	1050
386	055	120	XX	YY	00	7	557	1200	790	403	1,30	18,20	5,60	-	631	-	726
		140				7	557	1400	909	464	1,31	21,00	6,37	-	696	-	800
		160				7	557	1600	1029	525	1,31	23,10	7,07	-	766	-	881
		180				7	557	1800	1154	589	1,31	25,90	7,77	-	833	-	958
		200				7	557	2000	1269	647	1,30	28,70	8,40	-	897	-	1032
		220				7	557	2200	1380	704	1,29	31,50	9,10	-	961	-	1105
		240				7	557	2400	1485	758	1,28	33,60	9,80	-	1029	-	1183
386	063	120	XX	YY	00	8	637	1200	891	455	1,30	20,80	6,40	-	696	-	800
		140				8	637	1400	1024	522	1,30	24,00	7,28	-	771	-	887
		160				8	637	1600	1159	591	1,31	26,40	8,08	-	846	-	973
		180				8	637	1800	1302	664	1,31	29,60	8,88	-	919	-	1057
		200				8	637	2000	1433	731	1,30	32,80	9,60	-	995	-	1144
		220				8	637	2200	1557	794	1,29	36,00	10,40	-	1067	-	1227
		240				8	637	2400	1676	855	1,29	38,40	11,20	-	1143	-	1314

Conform EN442-1: 2014: radiatoren en convectoren

Voor meer details over onze artikel-data, zie artikel-database: <https://www.2ba.nl>

Voor de warmteafgiftes van andere regimes, kijkt u op p. 346 (correctiefactoren)
NEDERLAND. Prijzen in euro (excl. BTW)

VIOLA-A VERTICAAL (V1-ZB-A)



V1-ZB-A

HOE VIOLA-A VERTICAAL BESTELLEN

Leveringstermijn 15 - 30 werkdagen
(zonder transportduur)

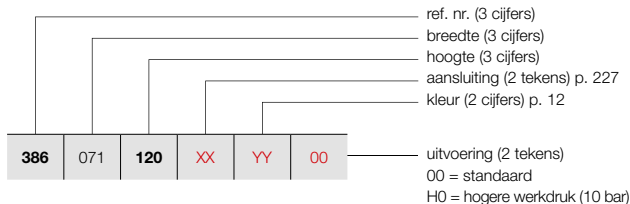

PRIJSGROEP: VPG2 - STAAL DESIGNRADIATOREN

BESTELCODE MAATWERK VIOLA-A VERTICAAL	TECHNISCHE GEGEVENS									STANDAARDKLEUR	ANDERE KLEUREN					
	buizen	breedte (L mm)	hoogte (H mm)	75/65/20 (Watt) (Φ50K)	55/45/20 (Watt) (Φ30K)	n-exp.	gewicht (kg)	inhoud (l)	el. weerst. (Watt)	prijs RAL 9016 (€)	prijs kleur (€)					
REF. NR. VIOLA-A VERTICAAL V1-ZB-A : 386																
386	071	120	XX	YY	00	9	717	1200	989	505	1,29	23,40	7,20	-	766	881
		140				9	717	1400	1137	580	1,30	27,00	8,19	-	846	973
		160				9	717	1600	1288	657	1,31	29,70	9,09	-	929	1068
		180				9	717	1800	1449	739	1,31	33,30	9,99	-	1008	1159
		200				9	717	2000	1594	813	1,30	36,90	10,80	-	1094	1258
		220				9	717	2200	1733	884	1,30	40,50	11,70	-	1176	1352
		240				9	717	2400	1864	951	1,29	43,20	12,60	-	1258	1447
386	079	120	XX	YY	00	10	797	1200	1087	555	1,29	26,00	8,00	-	832	957
		140				10	797	1400	1249	637	1,30	30,00	9,10	-	919	1057
		160				10	797	1600	1414	721	1,30	33,00	10,10	-	1008	1159
		180				10	797	1800	1594	813	1,31	37,00	11,10	-	1101	1266
		200				10	797	2000	1754	895	1,31	41,00	12,00	-	1191	1370
		220				10	797	2200	1906	972	1,30	45,00	13,00	-	1282	1474
		240				10	797	2400	2051	1046	1,29	48,00	14,00	-	1373	1579
386	087	120	XX	YY	00	11	877	1200	1183	604	1,28	28,60	8,80	-	896	1030
		140				11	877	1400	1360	694	1,29	33,00	10,01	-	995	1144
		160				11	877	1600	1540	786	1,30	36,30	11,11	-	1093	1257
		180				11	877	1800	1738	887	1,31	40,70	12,21	-	1191	1370
		200				11	877	2000	1912	976	1,31	45,10	13,20	-	1293	1487
		220				11	877	2200	2078	1060	1,30	49,50	14,30	-	1388	1596
		240				11	877	2400	2236	1141	1,29	52,80	15,40	-	1488	1711
386	095	120	XX	YY	00	12	957	1200	1279	653	1,28	31,20	9,60	-	961	1105
		140				12	957	1400	1470	750	1,29	36,00	10,92	-	1066	1226
		160				12	957	1600	1664	849	1,30	39,60	12,12	-	1175	1351
		180				12	957	1800	1881	960	1,31	44,40	13,32	-	1281	1473
		200				12	957	2000	2069	1056	1,31	49,20	14,40	-	1388	1596
		220				12	957	2200	2249	1147	1,30	54,00	15,60	-	1496	1720
		240				12	957	2400	2420	1235	1,30	57,60	16,80	-	1604	1845
386	103	120	XX	YY	00	13	1037	1200	1374	701	1,27	33,80	10,40	-	1093	1257
		140				13	1037	1400	1579	806	1,29	39,00	11,83	-	1216	1398
		160				13	1037	1600	1788	912	1,30	42,90	13,13	-	1336	1536
		180				13	1037	1800	2023	1032	1,31	48,10	14,43	-	1462	1681
		200				13	1037	2000	2225	1135	1,31	53,30	15,60	-	1587	1825
		220				13	1037	2200	2418	1234	1,30	58,50	16,90	-	1710	1967
		240				13	1037	2400	2602	1328	1,30	62,40	18,20	-	1834	2109

Conform EN442-1: 2014: radiatoren en convectoren

Voor meer details over onze artikel-data, zie artikel-database: <https://www.2ba.nl>

Voor de warmteafgifte van andere regimes, kijkt u op p. 346 (correctiefactoren)
NEDERLAND. Prijzen in euro (excl. BTW)

HOE VIOLA-A VERTICAAL BESTELLEN

Leveringstermijn 15 - 30 werkdagen
(zonder transportduur)

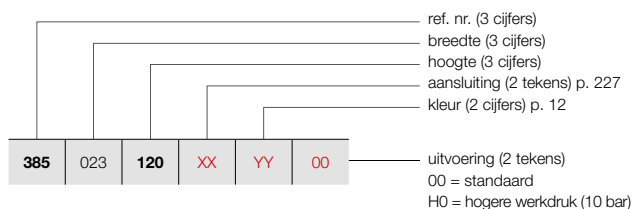

VIOLA-A VERTICAAL (V1L1-ZB-A)



V1L1-ZB-A

PRIJSGROEP: VPG2 - STAAL DESIGNRADIATOREN

BESTELCODE MAATWERK VIOLA-A VERTICAAL	TECHNISCHE GEGEVENS								STANDAARDKLEUR	ANDERE KLEUREN						
	buizen	breedte (L mm)	hoogte (H mm)	75/65/20 (Watt) (Φ50K)	55/45/20 (Watt) (Φ30K)	n-exp.	gewicht (kg)	inhoud (l)			el. weerst. (Watt)	prijs RAL 9016 (€)	prijs kleur (€)			
REF. NR. VIOLA-A VERTICAAL V1L1-ZB-A : 385																
385	023	120	XX	YY	00	3	237	1200	464	237	1,28	10,50	2,40	-	462	531
		140				3	237	1400	531	271	1,28	12,60	2,73	-	507	583
		160				3	237	1600	597	305	1,29	14,40	3,03	-	542	623
		180				3	237	1800	661	337	1,29	15,90	3,33	-	585	673
		200				3	237	2000	723	369	1,30	18,30	3,60	-	623	716
		220				3	237	2200	784	400	1,32	19,80	3,90	-	669	769
		240				3	237	2400	843	430	1,33	21,60	4,20	-	706	812
385	031	120	XX	YY	00	4	317	1200	605	309	1,28	14,00	3,20	-	542	623
		140				4	317	1400	693	354	1,29	16,80	3,64	-	596	685
		160				4	317	1600	778	397	1,29	19,20	4,04	-	647	744
		180				4	317	1800	861	439	1,29	21,20	4,44	-	699	804
		200				4	317	2000	943	481	1,31	24,40	4,80	-	750	863
		220				4	317	2200	1022	521	1,32	26,40	5,20	-	801	921
		240				4	317	2400	1099	561	1,33	28,80	5,60	-	851	979
385	039	120	XX	YY	00	5	397	1200	743	379	1,29	17,50	4,00	-	623	716
		140				5	397	1400	851	434	1,29	21,00	4,55	-	689	792
		160				5	397	1600	956	488	1,29	24,00	5,05	-	750	863
		180				5	397	1800	1058	540	1,30	26,50	5,55	-	813	935
		200				5	397	2000	1158	591	1,31	30,50	6,00	-	876	1007
		220				5	397	2200	1255	640	1,32	33,00	6,50	-	934	1074
		240				5	397	2400	1350	689	1,33	36,00	7,00	-	996	1145
385	047	120	XX	YY	00	6	477	1200	879	448	1,29	21,00	4,80	-	706	812
		140				6	477	1400	1007	514	1,29	25,20	5,46	-	779	896
		160				6	477	1600	1131	577	1,30	28,80	6,06	-	851	979
		180				6	477	1800	1252	639	1,30	31,80	6,66	-	924	1063
		200				6	477	2000	1370	699	1,31	36,60	7,20	-	996	1145
		220				6	477	2200	1485	758	1,32	39,60	7,80	-	1068	1228
		240				6	477	2400	1598	815	1,33	43,20	8,40	-	1142	1313
385	055	120	XX	YY	00	7	557	1200	1013	517	1,29	24,50	5,60	-	791	910
		140				7	557	1400	1160	592	1,30	29,40	6,37	-	875	1006
		160				7	557	1600	1303	665	1,30	33,60	7,07	-	955	1098
		180				7	557	1800	1443	736	1,31	37,10	7,77	-	1039	1195
		200				7	557	2000	1579	806	1,31	42,70	8,40	-	1121	1289
		220				7	557	2200	1712	873	1,32	46,20	9,10	-	1202	1382
		240				7	557	2400	1841	939	1,33	50,40	9,80	-	1283	1475
385	063	120	XX	YY	00	8	637	1200	1146	585	1,29	28,00	6,40	-	875	1006
		140				8	637	1400	1312	669	1,30	33,60	7,28	-	964	1109
		160				8	637	1600	1474	752	1,31	38,40	8,08	-	1056	1214
		180				8	637	1800	1632	833	1,31	42,40	8,88	-	1148	1320
		200				8	637	2000	1786	911	1,32	48,80	9,60	-	1245	1432
		220				8	637	2200	1936	988	1,32	52,80	10,40	-	1334	1534
		240				8	637	2400	2083	1063	1,33	57,60	11,20	-	1429	1643

Conform EN442-1: 2014: radiatoren en convectoren

Voor meer details over onze artikel-data, zie artikel-database: <https://www.2ba.nl>

Voor de warmteafgiftes van andere regimes, kijkt u op p. 346 (correctiefactoren)
 NEDERLAND. Prijzen in euro (excl. BTW)

VIOLA-A VERTICAAL (V1L1-ZB-A)



V1L1-ZB-A

HOE VIOLA-A VERTICAAL BESTELLEN

Leveringstermijn 15 - 30 werkdagen
(zonder transportduur)

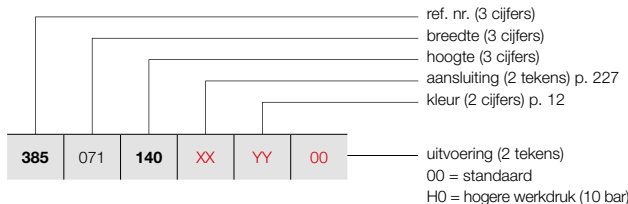

PRIJSGROEP: VPG2 - STAAL DESIGNRADIATOREN

BESTELCODE MAATWERK VIOLA-A VERTICAAL							TECHNISCHE GEGEVENS					STANDAARDKLEUR	ANDERE KLEUREN				
385	071	140	XX	YY	00	buizen	breedte (L mm)	hoogte (H mm)	75/65/20 (Watt) (Φ50K)	55/45/20 (Watt) (Φ30K)	n-exp.	gewicht (kg)	inhoud (l)	el. weerst. (Watt)	prijs RAL 9016 (€)	prijs kleur (€)	
REF. NR. VIOLA-A VERTICAAL V1L1-ZB-A : 385																	
385	071	140	XX	YY	00	9	717	1400	1462	746	1,30	37,80	8,19	-	1056	1214	
		160				9	717	1600	1643	838	1,31	43,20	9,09	-	1161	1335	
		180				9	717	1800	1819	928	1,32	47,70	9,99	-	1261	1450	
		200				9	717	2000	1990	1015	1,32	54,90	10,80	-	1366	1571	
		220				9	717	2200	2158	1101	1,32	59,40	11,70	-	1470	1691	
		240				9	717	2400	2321	1184	1,33	64,80	12,60	-	1572	1808	
385	079	120	XX	YY	00	10	797	1200	1407	718	1,30	35,00	8,00	-	1037	1193	
		140				10	797	1400	1611	822	1,31	42,00	9,10	-	1148	1320	
		160				10	797	1600	1810	923	1,31	48,00	10,10	-	1261	1450	
		180				10	797	1800	2004	1022	1,32	53,00	11,10	-	1377	1584	
		200				10	797	2000	2194	1119	1,32	61,00	12,00	-	1489	1712	
		220				10	797	2200	2387	1218	1,32	66,00	13,00	-	1604	1845	
		240				10	797	2400	2558	1305	1,33	72,00	14,00	-	1717	1975	
385	087	120	XX	YY	00	11	877	1200	1536	784	1,30	38,50	8,80	-	1120	1288	
		140				11	877	1400	1759	897	1,31	46,20	10,01	-	1245	1432	
		160				11	877	1600	1976	1008	1,32	52,80	11,11	-	1365	1570	
		180				11	877	1800	2189	1117	1,32	58,30	12,21	-	1489	1712	
		200				11	877	2000	2394	1221	1,33	67,10	13,20	-	1616	1858	
		220				11	877	2200	2596	1324	1,33	72,60	14,30	-	1737	1998	
		240				11	877	2400	2792	1424	1,33	79,20	15,40	-	1861	2140	
385	095	120	XX	YY	00	12	957	1200	1665	849	1,31	42,00	9,60	-	1202	1382	
		140				12	957	1400	1907	973	1,31	50,40	10,92	-	1333	1533	
		160				12	957	1600	2142	1093	1,32	57,60	12,12	-	1468	1688	
		180				12	957	1800	2371	1210	1,33	63,60	13,32	-	1602	1842	
		200				12	957	2000	2595	1324	1,33	73,20	14,40	-	1737	1998	
		220				12	957	2200	2813	1435	1,33	79,20	15,60	-	1871	2152	
		240				12	957	2400	3026	1544	1,33	86,40	16,80	-	2003	2303	
385	103	120	XX	YY	00	13	1037	1200	1792	914	1,31	45,50	10,40	-	1365	1570	
		140				13	1037	1400	2052	1047	1,32	54,60	11,83	-	1521	1749	
		160				13	1037	1600	2306	1177	1,33	62,40	13,13	-	1672	1923	
		180				13	1037	1800	2552	1302	1,33	68,90	14,43	-	1831	2106	
		200				13	1037	2000	2793	1425	1,33	79,30	15,60	-	1983	2280	
		220				13	1037	2200	3028	1545	1,33	85,80	16,90	-	2137	2458	
		240				13	1037	2400	3257	1662	1,33	93,60	18,20	-	2295	2639	

Conform EN442-1: 2014: radiatoren en convectoren

Voor meer details over onze artikel-data, zie artikel-database: <https://www.2ba.nl>

Voor de warmteafgifte van andere regimes, kijkt u op p. 346 (correctiefactoren)
NEDERLAND. Prijzen in euro (excl. BTW)

HOE VIOLA-A VERTICAAL BESTELLEN

Leveringstermijn 15 - 30 werkdagen
(zonder transportduur)

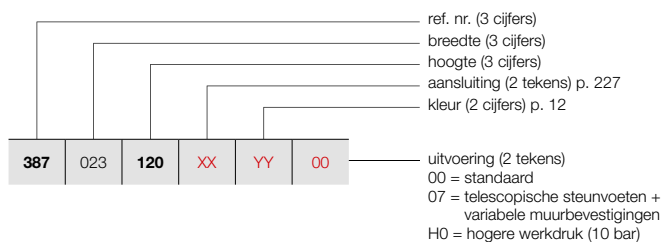

HOE VOORRAADRADIATOR VIOLA-A VERTICAAL BESTELLEN

Leveringstermijn 5 werkdagen
(zonder transportduur)

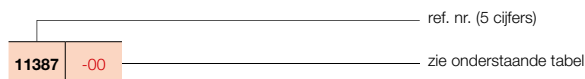

VIOLA-A VERTICAAL (V2-ZB-A)



V2-ZB-A

PRIJSGROEP: VPG2 - STAAL DESIGNRADIATOREN

BESTELCODE MAATWERK VIOLA-A VERTICAAL	TECHNISCHE GEGEVENS							STANDAARDKLEUR		ANDERE KLEUREN		
	buizen	breedte (L mm)	hoogte (H mm)	75/65/20 (Watt) (Φ50K)	55/45/20 (Watt) (Φ30K)	n-exp.	gewicht (kg)	inhoud (l)	el. weerst. (Watt)		prijs RAL 9016 (€)	verkorte ref. nr. RAL 9016 voorraad
REF. NR. VIOLA-A VERTICAAL V2-ZB-A : 387												
387 023 120 XX YY 00	3	237	1200	509	260	1,33	14,40	4,59	-	627	-	721
	3	237	1400	587	299	1,34	16,80	5,04	-	687	-	790
	3	237	1600	664	339	1,35	18,90	5,52	-	741	-	852
	3	237	1800	743	379	1,35	21,30	5,97	-	798	-	918
	3	237	2000	821	419	1,35	23,40	6,39	-	850	-	978
	3	237	2200	900	459	1,34	25,80	6,81	-	907	-	1043
	3	237	2400	979	499	1,34	28,20	7,23	-	962	-	1106
387 031 120 XX YY 00	4	317	1200	655	334	1,33	19,20	6,12	-	741	-	852
	4	317	1400	755	385	1,34	22,40	6,72	-	809	-	930
	4	317	1600	854	436	1,35	25,20	7,36	-	882	-	1014
	4	317	1800	952	486	1,35	28,40	7,96	-	950	-	1093
	4	317	2000	1050	536	1,35	31,20	8,52	-	1018	-	1171
	4	317	2200	1147	585	1,35	34,40	9,08	-	1090	-	1254
	4	317	2400	1244	635	1,34	37,60	9,64	-	1160	-	1334
387 039 120 XX YY 00	5	397	1200	802	409	1,33	24,00	7,65	-	850	-	978
	5	397	1400	923	471	1,34	28,00	8,40	-	934	-	1074
	5	397	1600	1043	532	1,35	31,50	9,20	-	1018	-	1171
	5	397	1800	1162	593	1,36	35,50	9,95	-	1102	-	1267
	5	397	2000	1279	653	1,35	39,00	10,65	-	1188	-	1366
	5	397	2200	1394	711	1,35	43,00	11,35	-	1273	-	1464
	5	397	2400	1509	770	1,34	47,00	12,05	-	1358	-	1562
387 047 120 XX YY 00	6	477	1200	948	484	1,34	28,80	9,18	-	962	-	1106
	6	477	1400	1092	557	1,34	33,60	10,08	-	1061	-	1220
	6	477	1600	1232	629	1,35	37,80	11,04	-	1160	-	1334
	6	477	1800	1371	699	1,36	42,60	11,94	-	1258	-	1447
	6	477	2000	1507	769	1,35	46,80	12,78	-	1358	-	1562
	6	477	2200	1642	838	1,35	51,60	13,62	-	1454	-	1672
	6	477	2400	1775	906	1,34	56,40	14,46	-	1549	-	1781
387 055 120 XX YY 00	7	557	1200	1094	558	1,34	33,60	10,71	-	1076	-	1237
	7	557	1400	1260	643	1,34	39,20	11,76	-	1185	-	1363
	7	557	1600	1422	726	1,35	44,10	12,88	-	1299	-	1494
	7	557	1800	1580	806	1,36	49,70	13,93	-	1410	-	1622
	7	557	2000	1736	886	1,36	54,60	14,91	-	1524	-	1753
	7	557	2200	1889	964	1,35	60,20	15,89	-	1632	-	1877
	7	557	2400	2040	1041	1,35	65,80	16,87	-	1746	-	2008
387 063 120 XX YY 00	8	637	1200	1240	633	1,34	38,40	12,24	-	1185	-	1363
	8	637	1400	1428	729	1,35	44,80	13,44	-	1311	-	1508
	8	637	1600	1611	822	1,35	50,40	14,72	-	1437	-	1653
	8	637	1800	1790	913	1,36	56,80	15,92	-	1564	-	1799
	8	637	2000	1965	1003	1,36	62,40	17,04	-	1692	11387-01	1946
	8	637	2200	2136	1090	1,35	68,80	18,16	-	1818	-	2091
	8	637	2400	2305	1176	1,35	75,20	19,28	-	1942	-	2233

Conform EN442-1: 2014: radiatoren en convectoren

Voor meer details over onze artikel-data, zie artikel-database: <https://www.2ba.nl>

Voor de warmteafgiftes van andere regimes, kijkt u op p. 346 (correctiefactoren)
NEDERLAND. Prijzen in euro (excl. BTW)

VIOLA-A VERTICAAL (V2-ZB-A)



V2-ZB-A

HOE VIOLA-A VERTICAAL BESTELLEN

Leveringstermijn 15 - 30 werkdagen
(zonder transportduur)

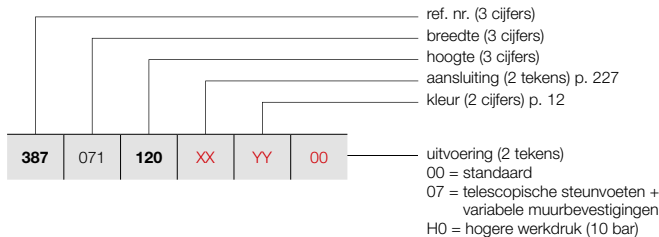

PRIJSGROEP: VPG2 - STAAL DESIGNRADIATOREN

BESTELCODE MAATWERK VIOLA-A VERTICAAL							TECHNISCHE GEGEVENS					STANDAARDKLEUR	ANDERE KLEUREN			
387	071	120	XX	YY	00	buizen	breedte (L mm)	hoogte (H mm)	75/65/20 (Watt) (Φ50K)	55/45/20 (Watt) (Φ30K)	n-exp.	gewicht (kg)	inhoud (l)	el. weerst. (Watt)	prijs RAL 9016 (€)	prijs kleur (€)
REF. NR. VIOLA-A VERTICAAL V2-ZB-A : 387																
387	071	120	XX	YY	00	9	717	1200	1387	708	1,34	43,20	13,77	-	1299	1494
		140				9	717	1400	1596	814	1,35	50,40	15,12	-	1437	1653
		160				9	717	1600	1801	919	1,36	56,70	16,56	-	1578	1815
		180				9	717	1800	1999	1020	1,36	63,90	17,91	-	1717	1975
		200				9	717	2000	2194	1119	1,36	70,20	19,17	-	1858	2137
		220				9	717	2200	2384	1216	1,35	77,40	20,43	-	1999	2299
		240				9	717	2400	2570	1311	1,35	84,60	21,69	-	2137	2458
387	079	120	XX	YY	00	10	797	1200	1533	782	1,34	48,00	15,30	-	1409	1620
		140				10	797	1400	1765	901	1,35	56,00	16,80	-	1564	1799
		160				10	797	1600	1990	1015	1,36	63,00	18,40	-	1717	1975
		180				10	797	1800	2209	1127	1,37	71,00	19,90	-	1873	2154
		200				10	797	2000	2422	1236	1,36	78,00	21,30	-	2025	2329
		220				10	797	2200	2631	1342	1,36	86,00	22,70	-	2179	2506
		240				10	797	2400	2836	1447	1,35	94,00	24,10	-	2332	2682
387	087	120	XX	YY	00	11	877	1200	1679	857	1,34	52,80	16,83	-	1522	1750
		140				11	877	1400	1933	986	1,35	61,60	18,48	-	1692	1946
		160				11	877	1600	2179	1112	1,36	69,30	20,24	-	1854	2132
		180				11	877	1800	2418	1234	1,37	78,10	21,89	-	2025	2329
		200				11	877	2000	2651	1353	1,36	85,80	23,43	-	2197	2527
		220				11	877	2200	2878	1468	1,36	94,60	24,97	-	2361	2715
		240				11	877	2400	3101	1582	1,35	103,40	26,51	-	2532	2912
387	095	120	XX	YY	00	12	957	1200	1825	931	1,35	57,60	18,36	-	1632	1877
		140				12	957	1400	2101	1072	1,35	67,20	20,16	-	1811	2083
		160				12	957	1600	2369	1209	1,36	75,60	22,08	-	1997	2297
		180				12	957	1800	2628	1341	1,37	85,20	23,88	-	2177	2504
		200				12	957	2000	2880	1469	1,36	93,60	25,56	-	2361	2715
		220				12	957	2200	3126	1595	1,36	103,20	27,24	-	2543	2924
		240				12	957	2400	3366	1717	1,36	112,80	28,92	-	2726	3135
387	103	120	XX	YY	00	13	1037	1200	1972	1006	1,35	62,40	19,89	-	1854	2132
		140				13	1037	1400	2270	1158	1,36	72,80	21,84	-	2066	2376
		160				13	1037	1600	2558	1305	1,36	81,90	23,92	-	2276	2617
		180				13	1037	1800	2837	1447	1,37	92,30	25,87	-	2487	2860
		200				13	1037	2000	3109	1586	1,37	101,40	27,69	-	2696	3100
		220				13	1037	2200	3373	1721	1,36	111,80	29,51	-	2908	3344
		240				13	1037	2400	3631	1853	1,36	122,20	31,33	-	3117	3585

Conform EN442-1: 2014: radiatoren en convectoren

Voor meer details over onze artikel-data, zie artikel-database: <https://www.2ba.nl>
Voor de warmteafgifte van andere regimes, kijkt u op p. 346 (correctiefactoren)
NEDERLAND. Prijzen in euro (excl. BTW)

VIOLA-A HORIZONTAAL (H1-RO-A, H1L1-RO-A, H2-RO-A, H2L1-RO-A, H2L2-RO-A)

TYPES

- H1-RO-A enkele rij buizen, H2-RO-A dubbele rij buizen, H1L1-RO-A, H2L1-RO-A, H2L2-RO-A (1 of 2 rijen stalen lamellen)

BUIZEN

- Horizontaal, rechthoekig 77 x 10 mm

COLLECTOREN

- H1-RO-A en H1L1-RO-A: 35 x 43 mm
- H2-RO-A en H2L1-RO-A: 35 x 41 mm
- H2L2-RO-A: 35 x 81 mm

KLEUREN

- Standaardkleur wit RAL 9016
- Uitgebreide kleurenkaart zie p. 12

SPECIAAL

- Bij types H1L1-RO-A / H2L1-RO-A en H2L2-RO-A zijn 1 of 2 rijen stalen lamellen ter verhoging van de warmteafgifte op de platovale buizen gepuntlast.
- Standaard met rooster.
- H1L1-RO-A ook verkrijgbaar als toiletradiator (500 x 400 mm)

BEVESTIGINGEN

- Muurbevestigingen standaard (inbegrepen in de verpakking van de radiator)
- Bovenste beugel in kleur van de radiator, onderaan:
 - Afstandshouder radiator wit = afstandshouder wit.
 - Afstandshouder radiator in kleur = afstandshouder RAL 7024.
- **H2-RO-A/H2L1-RO-A:** Radiator met telescopische steunvoeten + variabele muurbevestiging: gelieve bij bestelling code **07** aan te geven bij "Afwerking" (zie p. 224).
- **H2-RO-A/H2L1-RO-A:** Ook verkrijgbaar als vrijstaande radiator (zie p. 225)

TECHNISCH

- Weerstandsgelast (onzichtbare lasnaden)
- ATL-grondlaag, poedercoating
- Standaardwerkdruk: 4 bar. Meerprijs hogere werkdruk (10 bar): +10%.
- De leveringstermijn van radiator met een hogere werkdruk is 1 week extra.
- Maximale bedrijfstemperatuur: 110°C

ELEKTRISCH

- ✗ Zuiver elektrische radiator in de fabriek voorgevuld
- ✗ Gemengde radiator

TECHNISCHE TEKENINGEN

- Zie p. 229

AANSLUITING

- ✗ Eénpuntsaansluiting voor éénpijpsysteem
- ✗ Eénpuntsaansluiting voor tweepijpsysteem
- ✓ Tweepuntsaansluiting voor éénpijpsysteem (aansluiting via het geïntegreerd ventiel) (zie p. 341)
- ✓ Tweepuntsaansluiting voor tweepijpsysteem (standaard) (zie p. 340)
- ✓ Geïntegreerd ventiel (**meerprijs €110**) (radiator speciaal te bestellen) (zie p. 341)
- Aansluitingen: ½" (binnendraad)

AANBEVOLEN AANSLUITING

GEÏNTEGREERD VENTIEL (MEERPRIJS)

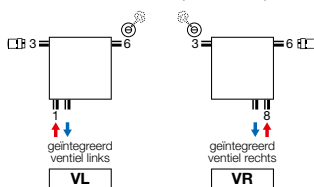

Meerprijs: €110 (zie p. 341)

Andere aansluitmogelijkheden, zie p. 227
Thermostaatkop apart te bestellen



art. nr. 1182 301 0000 0099

prijs €159

Koppelingen, zie p. 353



art. nr. 11911630102

prijs €50

Thermostaatkop apart te bestellen

AANBEVOLEN VOOR BADKAMER EN KEUKEN IN OPTIE

handdoekbeugel (RAL 9005)

art. nr. zie p. 226

prijs €145

Andere accessoires, zie p. 226



VIOLA-A HORIZONTAAL

In het verlengde van een grote traditie

Ook de Viola-A Horizontaal combineert, net als de Viola-A Verticaal een sobere, uniforme look met een optimale warmteafgifte. De radiator is beschikbaar in enkele en dubbele uitvoering. Het design is sober en overal toepasbaar. Kan ook in een vrijstaande opstelling worden geïnstalleerd.



H2-RO-A / H2L1-RO-A

VIOLA-A HORIZONTAAL (H1-RO-A)



H1-RO-A
(thermostaatkop apart te bestellen)

HOE VIOLA-A HORIZONTAAL BESTELLEN

Leveringstermijn 15 - 30 werkdagen
(zonder transportduur)

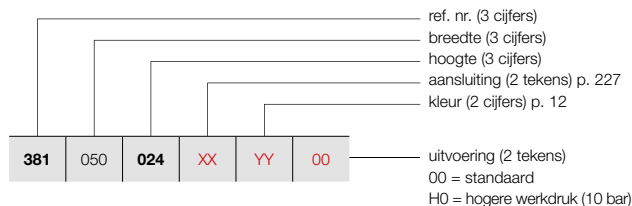

PRIJSGROEP: VPG2 - STAAL DESIGNRADIATOREN

BESTELCODE MAATWERK VIOLA-A HORIZONTAAL							TECHNISCHE GEGEVENS					STANDAARDKLEUR	ANDERE KLEUREN			
buizen	breedte (L mm)	hoogte (H mm)	75/65/20 (Watt) (Φ50K)	55/45/20 (Watt) (Φ30K)	n-exp.	gewicht (kg)	inhoud (l)	el. weerst. (Watt)	prijs RAL 9016 (€)	prijs kleur (€)						
REF. NR. VIOLA-A HORIZONTAAL H1-RO-A : 381																
381	050	024	XX	YY	00	3	500	240	141	72	1,25	3,15	1,00	-	278	320
		032				4	500	320	179	91	1,25	3,25	1,40	-	315	362
		040				5	500	400	223	114	1,26	5,50	1,70	-	351	404
		048				6	500	480	266	136	1,26	6,60	2,05	-	387	445
		056				7	500	560	310	158	1,26	7,70	2,40	-	427	491
		064				8	500	640	353	180	1,26	8,80	2,75	-	461	530
		072				9	500	720	396	202	1,26	9,90	3,10	-	499	574
		080				10	500	800	438	223	1,26	11,00	3,50	-	535	615
		088				11	500	880	481	245	1,27	12,10	3,85	-	572	658
381	060	024	XX	YY	00	3	600	240	169	86	1,25	3,78	1,20	-	298	343
		032				4	600	320	215	110	1,25	3,90	1,68	-	339	390
		040				5	600	400	267	136	1,26	6,60	2,04	-	379	436
		048				6	600	480	319	163	1,26	7,92	2,46	-	422	485
		056				7	600	560	371	189	1,26	9,24	2,88	-	462	531
		064				8	600	640	423	216	1,26	10,56	3,30	-	509	585
		072				9	600	720	475	242	1,26	11,88	3,72	-	545	627
		080				10	600	800	526	268	1,26	13,20	4,20	-	588	676
		088				11	600	880	577	294	1,27	14,52	4,62	-	627	721
381	070	024	XX	YY	00	3	700	240	197	100	1,25	4,41	1,40	-	322	370
		032				4	700	320	251	128	1,25	4,55	1,96	-	366	421
		040				5	700	400	312	159	1,26	7,70	2,38	-	409	470
		048				6	700	480	372	190	1,26	9,24	2,87	-	456	524
		056				7	700	560	433	221	1,26	10,78	3,36	-	504	580
		064				8	700	640	494	252	1,26	12,32	3,85	-	549	631
		072				9	700	720	554	283	1,26	13,86	4,34	-	593	682
		080				10	700	800	613	313	1,26	15,40	4,90	-	636	731
		088				11	700	880	673	343	1,27	16,94	5,39	-	686	789
381	080	024	XX	YY	00	3	800	240	225	115	1,25	5,04	1,60	-	346	398
		032				4	800	320	286	146	1,25	5,20	2,24	-	393	452
		040				5	800	400	356	182	1,26	8,80	2,72	-	442	508
		048				6	800	480	426	217	1,26	10,56	3,28	-	490	564
		056				7	800	560	495	253	1,26	12,32	3,84	-	539	620
		064				8	800	640	564	288	1,26	14,08	4,40	-	592	681
		072				9	800	720	633	323	1,26	15,84	4,96	-	640	736
		080				10	800	800	701	358	1,26	17,60	5,60	-	690	794
		088				11	800	880	769	392	1,27	19,36	6,16	-	740	851
381	090	024	XX	YY	00	3	900	240	253	129	1,25	5,67	1,80	-	366	421
		032				4	900	320	322	164	1,25	5,85	2,52	-	420	483
		040				5	900	400	401	204	1,26	9,90	3,06	-	474	545
		048				6	900	480	479	244	1,26	11,88	3,69	-	527	606
		056				7	900	560	557	284	1,26	13,86	4,32	-	579	666
		064				8	900	640	635	324	1,26	15,84	4,95	-	631	726
		072				9	900	720	712	363	1,26	17,82	5,58	-	688	791
		080				10	900	800	788	402	1,26	19,80	6,30	-	741	852
		088				11	900	880	865	441	1,27	21,78	6,93	-	795	914

Conform EN442-1: 2014: radiatoren en convectoren

Voor meer details over onze artikel-data, zie artikel-database: <https://www.2ba.nl>

Voor de warmteafgifte van andere regimes, kijkt u op p. 346 (correctiefactoren)
NETERLAND. Prijzen in euro (excl. BTW)

HOE VIOLA-A HORIZONTAAL BESTELLEN

Leveringstermijn 15 - 30 werkdagen
(zonder transportduur)

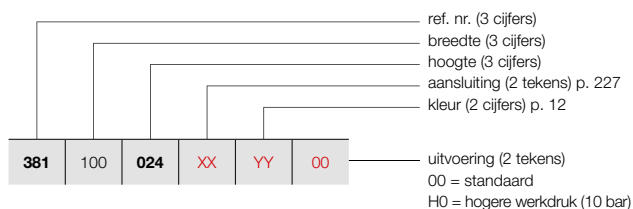

VIOLA-A HORIZONTAAL (H1-RO-A)



H1-RO-A
(thermostaatkop apart te bestellen)

PRIJSGROEP: VPG2 - STAAL DESIGNRADIATOREN

BESTELCODE MAATWERK VIOLA-A HORIZONTAAL	TECHNISCHE GEGEVENS							STANDAARDKLEUR		ANDERE KLEUREN	
	buizen	breedte (L mm)	hoogte (H mm)	75/65/20 (Watt) (Φ50K)	55/45/20 (Watt) (Φ30K)	n-exp.	gewicht (kg)	inhoud (l)	el. weerst. (Watt)	prijs RAL 9016 (€)	prijs kleur (€)
REF. NR. VIOLA-A HORIZONTAAL H1-RO-A : 381											
381	100	024	XX	YY	00						
		032								389	447
		040								444	511
		048								507	583
		056								561	645
		064								618	711
		072								675	776
		080								737	848
		088								794	913
										848	975
381	110	024	XX	YY	00						
		032								408	469
		040								473	544
		048								531	611
		056								596	685
		064								660	759
		072								721	829
		080								781	898
		088								842	968
										904	1040
381	120	024	XX	YY	00						
		032								433	498
		040								499	574
		048								565	650
		056								630	725
		064								694	798
		072								761	875
		080								832	957
		088								896	1030
										961	1105
381	140	024	XX	YY	00						
		032								476	547
		040								554	637
		048								625	719
		056								700	805
		064								774	890
		072								848	975
		080								923	1061
		088								998	1148
										1070	1231
381	160	024	XX	YY	00						
		032								523	601
		040								605	696
		048								688	791
		056								770	886
		064								851	979
		072								933	1073
		080								1017	1170
		088								1099	1264
										1180	1357

Conform EN442-1: 2014: radiatoren en convectoren

Voor meer details over onze artikel-data, zie artikel-database: <https://www.2ba.nl>

Voor de warmteafgiftes van andere regimes, kijkt u op p. 346 (correctiefactoren)
 NEDERLAND. Prijzen in euro (excl. BTW)

VIOLA-A HORIZONTAAL (H1-RO-A)



H1-RO-A
(thermostaatkop apart te bestellen)

HOE VIOLA-A HORIZONTAAL BESTELLEN

Leveringstermijn 15 - 30 werkdagen
(zonder transportduur)

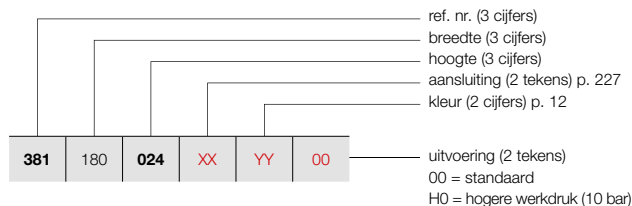

PRIJSGROEP: VPG2 - STAAL DESIGNRADIATOREN

BESTELCODE MAATWERK VIOLA-A HORIZONTAAL							TECHNISCHE GEGEVENS					STANDAARDKLEUR	ANDERE KLEUREN			
buizen	breedte (L mm)	hoogte (H mm)	75/65/20 (Watt) (Ø50K)	55/45/20 (Watt) (Ø30K)	n-exp.	gewicht (kg)	inhoud (l)	el. weerst. (Watt)	prijs RAL 9016 (€)	prijs kleur (€)						
REF. NR. VIOLA-A HORIZONTAAL H1-RO-A : 381																
381	180	024	XX	YY	00	3	1800	240	506	258	1,25	11,34	3,60	-	567	652
		032				4	1800	320	644	329	1,25	11,70	5,04	-	660	759
		040				5	1800	400	801	409	1,26	19,80	6,12	-	747	859
		048				6	1800	480	958	489	1,26	23,76	7,38	-	840	966
		056				7	1800	560	1114	568	1,26	27,72	8,64	-	930	1070
		064				8	1800	640	1269	647	1,26	31,68	9,90	-	1020	1173
		072				9	1800	720	1424	726	1,26	35,64	11,16	-	1111	1278
		080				10	1800	800	1577	804	1,26	39,60	12,60	-	1204	1385
		088				11	1800	880	1730	883	1,27	43,56	13,86	-	1295	1489
381	200	024	XX	YY	00	3	2000	240	562	287	1,25	12,60	4,00	-	611	703
		032				4	2000	320	716	365	1,25	13,00	5,60	-	710	817
		040				5	2000	400	890	454	1,26	22,00	6,80	-	809	930
		048				6	2000	480	1064	543	1,26	26,40	8,20	-	908	1044
		056				7	2000	560	1238	632	1,26	30,80	9,60	-	1007	1158
		064				8	2000	640	1410	719	1,26	35,20	11,00	-	1105	1271
		072				9	2000	720	1582	807	1,26	39,60	12,40	-	1207	1388
		080				10	2000	800	1752	894	1,26	44,00	14,00	-	1305	1501
		088				11	2000	880	1922	981	1,27	48,40	15,40	-	1406	1617
381	220	024	XX	YY	00	3	2200	240	618	315	1,25	13,86	4,40	-	657	756
		032				4	2200	320	788	402	1,25	14,30	6,16	-	766	881
		040				5	2200	400	979	499	1,26	24,20	7,48	-	874	1005
		048				6	2200	480	1170	597	1,26	29,04	9,02	-	980	1127
		056				7	2200	560	1362	695	1,26	33,88	10,56	-	1085	1248
		064				8	2200	640	1551	791	1,26	38,72	12,10	-	1194	1373
		072				9	2200	720	1740	888	1,26	43,56	13,64	-	1300	1495
		080				10	2200	800	1927	983	1,26	48,40	15,40	-	1408	1619
		088				11	2200	880	2114	1079	1,27	53,24	16,94	-	1514	1741
381	240	024	XX	YY	00	3	2400	240	674	344	1,25	15,12	4,80	-	700	805
		032				4	2400	320	859	438	1,25	15,60	6,72	-	818	941
		040				5	2400	400	1068	545	1,26	26,40	8,16	-	932	1072
		048				6	2400	480	1277	651	1,26	31,68	9,84	-	1048	1205
		056				7	2400	560	1486	758	1,26	36,96	11,52	-	1164	1339
		064				8	2400	640	1692	863	1,26	42,24	13,20	-	1280	1472
		072				9	2400	720	1898	969	1,26	47,52	14,88	-	1398	1608
		080				10	2400	800	2102	1073	1,26	52,80	16,80	-	1511	1738
		088				11	2400	880	2306	1177	1,27	58,08	18,48	-	1625	1869
381	260	024	XX	YY	00	3	2600	240	731	373	1,25	16,38	5,20	-	744	856
		032				4	2600	320	931	475	1,25	16,90	7,28	-	872	1003
		040				5	2600	400	1157	590	1,26	28,60	8,84	-	994	1143
		048				6	2600	480	1383	706	1,26	34,32	10,66	-	1119	1287
		056				7	2600	560	1609	821	1,26	40,04	12,48	-	1243	1429
		064				8	2600	640	1833	935	1,26	45,76	14,30	-	1365	1570
		072				9	2600	720	2057	1049	1,26	51,48	16,12	-	1489	1712
		080				10	2600	800	2278	1162	1,26	57,20	18,20	-	1614	1856
		088				11	2600	880	2499	1275	1,27	62,92	20,02	-	1738	1999

Conform EN442-1: 2014: radiatoren en convectoren

Voor meer details over onze artikel-data, zie artikel-database: <https://www.2ba.nl>

Voor de warmteafgiftes van andere regimes, kijkt u op p. 346 (correctiefactoren)
 NEDERLAND. Prijzen in euro (excl. BTW)

HOE VIOLA-A HORIZONTAAL BESTELLEN

Leveringstermijn 15 - 30 werkdagen
(zonder transportduur)

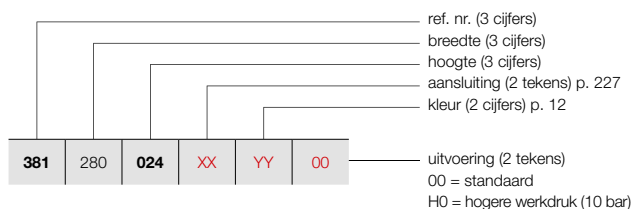

VIOLA-A HORIZONTAAL (H1-RO-A)



H1-RO-A
(thermostaatkop apart te bestellen)

PRIJSGROEP: VPG2 - STAAL DESIGNRADIATOREN

BESTELCODE MAATWERK VIOLA-A HORIZONTAAL	TECHNISCHE GEGEVENS							STANDAARDKLEUR		ANDERE KLEUREN	
	buizen	breedte (L mm)	hoogte (H mm)	75/65/20 (Watt) (Φ50K)	55/45/20 (Watt) (Φ30K)	n-exp.	gewicht (kg)	inhoud (l)	el. weerst. (Watt)	prijs RAL 9016 (€)	prijs kleur (€)
REF. NR. VIOLA-A HORIZONTAAL H1-RO-A : 381											
381	280	024	XX	YY	00						
		032								788	906
		040								922	1060
		048								1054	1212
		056								1187	1365
		064								1320	1518
		072								1453	1671
		080								1585	1823
		088								1716	1973
										1849	2126
381	300	024	XX	YY	00						
		032								836	961
		040								977	1124
		048								1118	1286
		056								1257	1446
		064								1399	1609
		072								1538	1769
		080								1677	1929
		088								1819	2092
										1960	2254

Conform EN442-1: 2014: radiatoren en convectoren

Voor meer details over onze artikel-data, zie artikel-database: <https://www.2ba.nl>

Voor de warmteafgiftes van andere regimes, kijkt u op p. 346 (correctiefactoren)
NETERLAND. Prijzen in euro (excl. BTW)

VIOLA-A HORIZONTAAL (H1L1-RO-A)



H1L1-RO-A
(thermostaatkop apart te bestellen)

HOE VIOLA-A HORIZONTAAL BESTELLEN

Leveringstermijn 15 - 30 werkdagen
(zonder transportduur)

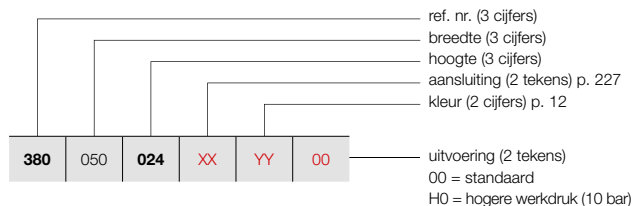

PRIJSGROEP: VPG2 - STAAL DESIGNRADIATOREN

BESTELCODE MAATWERK VIOLA-A HORIZONTAAL							TECHNISCHE GEGEVENS					STANDAARDKLEUR	ANDERE KLEUREN			
buizen	breedte (L mm)	hoogte (H mm)	75/65/20 (Watt) (Φ50K)	55/45/20 (Watt) (Φ30K)	n-exp.	gewicht (kg)	inhoud (l)	el. weerst. (Watt)	prijs RAL 9016 (€)	prijs kleur (€)						
REF. NR. VIOLA-A HORIZONTAAL H1L1-RO-A : 380																
380	050	024	XX	YY	00	3	500	240	261	133	1,24	5,45	1,00	-	318	366
		032				4	500	320	334	170	1,26	7,30	1,40	-	366	421
		040				5	500	400	399	204	1,27	9,10	1,70	-	414	476
		048				6	500	480	464	237	1,28	10,95	2,05	-	462	531
		056				7	500	560	530	270	1,30	12,75	2,40	-	513	590
		064				8	500	640	581	296	1,30	14,60	2,75	-	558	642
		072				9	500	720	618	315	1,30	15,70	3,10	-	609	700
		080				10	500	800	684	349	1,31	18,25	3,50	-	657	756
		088				11	500	880	719	367	1,31	19,35	3,85	-	702	807
380	060	024	XX	YY	00	3	600	240	313	160	1,24	6,54	1,20	-	348	400
		032				4	600	320	401	204	1,26	8,76	1,68	-	403	463
		040				5	600	400	479	244	1,27	10,92	2,04	-	457	526
		048				6	600	480	557	284	1,28	13,14	2,46	-	513	590
		056				7	600	560	635	324	1,30	15,30	2,88	-	567	652
		064				8	600	640	697	356	1,30	17,52	3,30	-	621	714
		072				9	600	720	741	378	1,30	18,84	3,72	-	675	776
		080				10	600	800	821	419	1,31	21,90	4,20	-	733	843
		088				11	600	880	863	440	1,31	23,22	4,62	-	785	903
380	070	024	XX	YY	00	3	700	240	365	186	1,24	7,63	1,40	-	378	435
		032				4	700	320	468	239	1,26	10,22	1,96	-	441	507
		040				5	700	400	559	285	1,27	12,74	2,38	-	503	578
		048				6	700	480	650	331	1,28	15,33	2,87	-	561	645
		056				7	700	560	741	378	1,30	17,85	3,36	-	622	715
		064				8	700	640	813	415	1,30	20,44	3,85	-	686	789
		072				9	700	720	865	441	1,30	21,98	4,34	-	744	856
		080				10	700	800	958	489	1,31	25,55	4,90	-	806	927
		088				11	700	880	1007	514	1,31	27,09	5,39	-	866	996
380	080	024	XX	YY	00	3	800	240	418	213	1,24	8,72	1,60	-	408	469
		032				4	800	320	534	273	1,26	11,68	2,24	-	476	547
		040				5	800	400	638	326	1,27	14,56	2,72	-	542	623
		048				6	800	480	742	379	1,28	17,52	3,28	-	612	704
		056				7	800	560	847	432	1,30	20,40	3,84	-	679	781
		064				8	800	640	930	474	1,30	23,36	4,40	-	745	857
		072				9	800	720	988	504	1,30	25,12	4,96	-	815	937
		080				10	800	800	1094	558	1,31	29,20	5,60	-	882	1014
		088				11	800	880	1150	587	1,31	30,96	6,16	-	949	1091
380	090	024	XX	YY	00	3	900	240	470	240	1,24	9,81	1,80	-	441	507
		032				4	900	320	601	307	1,26	13,14	2,52	-	515	592
		040				5	900	400	718	366	1,27	16,38	3,06	-	589	677
		048				6	900	480	835	426	1,28	19,71	3,69	-	662	761
		056				7	900	560	953	486	1,30	22,95	4,32	-	738	849
		064				8	900	640	1046	534	1,30	26,28	4,95	-	809	930
		072				9	900	720	1112	567	1,30	28,26	5,58	-	883	1015
		080				10	900	800	1231	628	1,31	32,85	6,30	-	956	1099
		088				11	900	880	1294	660	1,31	34,83	6,93	-	1031	1186

Conform EN442-1: 2014: radiatoren en convectoren

Voor meer details over onze artikel-data, zie artikel-database: <https://www.2ba.nl>

Voor de warmteafgiftes van andere regimes, kijkt u op p. 346 (correctiefactoren)
 NEDERLAND. Prijzen in euro (excl. BTW)

HOE VIOLA-A HORIZONTAAL BESTELLEN

Leveringstermijn 15 - 30 werkdagen
(zonder transportduur)

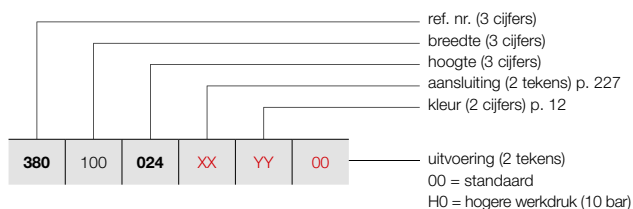

VIOLA-A HORIZONTAAL (H1L1-RO-A)



H1L1-RO-A
(thermostaatkop apart te bestellen)

PRIJSGROEP: VPG2 - STAAL DESIGNRADIATOREN

BESTELCODE MAATWERK VIOLA-A HORIZONTAAL	TECHNISCHE GEGEVENS							STANDAARDKLEUR	ANDERE KLEUREN			
	buizen	breedte (L mm)	hoogte (H mm)	75/65/20 (Watt) (φ50K)	55/45/20 (Watt) (φ30K)	n-exp.	gewicht (kg)			inhoud (l)	el. weerst. (Watt)	prijs RAL 9016 (€)
REF. NR. VIOLA-A HORIZONTAAL H1L1-RO-A : 380												
380 100 024 XX YY 00	032	3	1000	240	522	266	1,24	10,90	2,00	-	473	544
	040	4	1000	320	668	341	1,26	14,60	2,80	-	554	637
	048	5	1000	400	798	407	1,27	18,20	3,40	-	630	725
	056	6	1000	480	928	473	1,28	21,90	4,10	-	711	818
	064	7	1000	560	1059	540	1,30	25,50	4,80	-	794	913
	072	8	1000	640	1162	593	1,30	29,20	5,50	-	874	1005
	080	9	1000	720	1235	630	1,30	31,40	6,20	-	953	1096
	088	10	1000	800	1368	698	1,31	36,50	7,00	-	1031	1186
		11	1000	880	1438	734	1,31	38,70	7,70	-	1111	1278
	380 110 024 XX YY 00	032	3	1100	240	574	293	1,24	11,99	2,20	-	504
040		4	1100	320	735	375	1,26	16,06	3,08	-	589	677
048		5	1100	400	878	448	1,27	20,02	3,74	-	674	775
056		6	1100	480	1021	521	1,28	24,09	4,51	-	760	874
064		7	1100	560	1165	594	1,30	28,05	5,28	-	847	974
072		8	1100	640	1278	652	1,30	32,12	6,05	-	933	1073
080		9	1100	720	1359	693	1,30	34,54	6,82	-	1018	1171
088		10	1100	800	1505	768	1,31	40,15	7,70	-	1105	1271
		11	1100	880	1582	807	1,31	42,57	8,47	-	1194	1373
380 120 024 XX YY 00		032	3	1200	240	626	320	1,24	13,08	2,40	-	531
	040	4	1200	320	802	409	1,26	17,52	3,36	-	625	719
	048	5	1200	400	958	489	1,27	21,84	4,08	-	719	827
	056	6	1200	480	1114	568	1,28	26,28	4,92	-	813	935
	064	7	1200	560	1271	648	1,30	30,60	5,76	-	904	1040
	072	8	1200	640	1394	711	1,30	35,04	6,60	-	996	1145
	080	9	1200	720	1482	756	1,30	37,68	7,44	-	1090	1254
	088	10	1200	800	1642	838	1,31	43,80	8,40	-	1180	1357
		11	1200	880	1726	880	1,31	46,44	9,24	-	1275	1466
	380 140 024 XX YY 00	032	3	1400	240	731	373	1,24	15,26	2,80	-	595
040		4	1400	320	935	477	1,26	20,44	3,92	-	700	805
048		5	1400	400	1117	570	1,27	25,48	4,76	-	806	927
056		6	1400	480	1299	663	1,28	30,66	5,74	-	912	1049
064		7	1400	560	1483	756	1,30	35,70	6,72	-	1016	1168
072		8	1400	640	1627	830	1,30	40,88	7,70	-	1121	1289
080		9	1400	720	1729	882	1,30	43,96	8,68	-	1225	1409
088		10	1400	800	1915	977	1,31	51,10	9,80	-	1331	1531
		11	1400	880	2013	1027	1,31	54,18	10,78	-	1434	1649
380 160 024 XX YY 00		032	3	1600	240	835	426	1,24	17,44	3,20	-	660
	040	4	1600	320	1069	545	1,26	23,36	4,48	-	774	890
	048	5	1600	400	1277	651	1,27	29,12	5,44	-	893	1027
	056	6	1600	480	1485	758	1,28	35,04	6,56	-	1008	1159
	064	7	1600	560	1694	864	1,30	40,80	7,68	-	1129	1298
	072	8	1600	640	1859	949	1,30	46,72	8,80	-	1247	1434
	080	9	1600	720	1976	1008	1,30	50,24	9,92	-	1363	1567
	088	10	1600	800	2189	1117	1,31	58,40	11,20	-	1482	1704
		11	1600	880	2301	1174	1,31	61,92	12,32	-	1601	1841

Conform EN442-1: 2014: radiatoren en convectoren

Voor meer details over onze artikel-data, zie artikel-database: <https://www.2ba.nl>

Voor de warmteafgiftes van andere regimes, kijkt u op p. 346 (correctiefactoren)
NEDERLAND. Prijzen in euro (excl. BTW)

VIOLA-A HORIZONTAAL (H1L1-RO-A)



H1L1-RO-A
(thermostaatkop apart te bestellen)

HOE VIOLA-A HORIZONTAAL BESTELLEN

Leveringstermijn 15 - 30 werkdagen
(zonder transportduur)

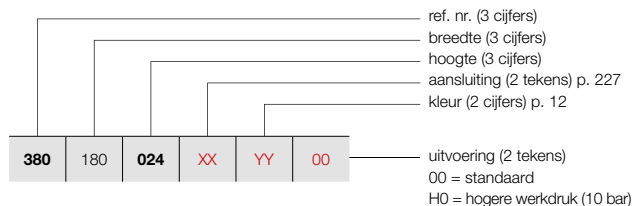

PRIJSGROEP: VPG2 - STAAL DESIGNRADIATOREN

BESTELCODE MAATWERK VIOLA-A HORIZONTAAL	TECHNISCHE GEGEVENS									STANDAARDKLEUR	ANDERE KLEUREN
	buizen	breedte (L mm)	hoogte (H mm)	75/65/20 (Watt) (Ø50K)	55/45/20 (Watt) (Ø30K)	n-exp.	gewicht (kg)	inhoud (l)	el. weerst. (Watt)	prijs RAL 9016 (€)	prijs kleur (€)
REF. NR. VIOLA-A HORIZONTAAL H1L1-RO-A : 380											
380	180	024	XX	YY	00						
		032								721	829
		040								848	975
		048								981	1128
		056								1111	1278
		064								1242	1428
		072								1372	1578
		080								1503	1728
		088								1630	1875
										1761	2025
380	200	024	XX	YY	00						
		032								781	898
		040								924	1063
		048								1066	1226
		056								1213	1395
		064								1354	1557
		072								1496	1720
		080								1642	1888
		088								1782	2049
										1926	2215
380	220	024	XX	YY	00						
		032								842	968
		040								999	1149
		048								1150	1323
		056								1310	1507
		064								1467	1687
		072								1621	1864
		080								1778	2045
		088								1932	2222
										2090	2404
380	240	024	XX	YY	00						
		032								904	1040
		040								1071	1232
		048								1243	1429
		056								1409	1620
		064								1578	1815
		072								1744	2006
		080								1914	2201
		088								2082	2394
										2252	2590
380	260	024	XX	YY	00						
		032								968	1113
		040								1146	1318
		048								1328	1527
		056								1510	1737
		064								1692	1946
		072								1871	2152
		080								2053	2361
		088								2232	2567
										2415	2777

Conform EN442-1: 2014: radiatoren en convectoren

Voor meer details over onze artikel-data, zie artikel-database: <https://www.2ba.nl>

Voor de warmteafgifte van andere regimes, kijkt u op p. 346 (correctiefactoren)
NEDERLAND. Prijzen in euro (excl. BTW)

HOE VIOLA-A HORIZONTAAL BESTELLEN

Leveringstermijn 15 - 30 werkdagen
(zonder transportduur)

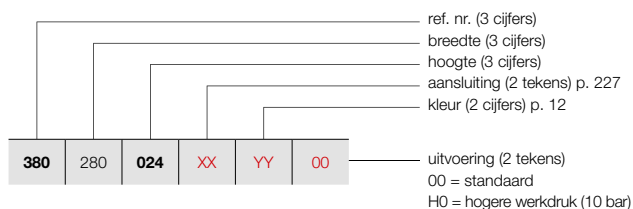

VIOLA-A HORIZONTAAL (H1L1-RO-A)



H1L1-RO-A
(thermostaatkop apart te bestellen)

PRIJSGROEP: VPG2 - STAAL DESIGNRADIATOREN

BESTELCODE MAATWERK VIOLA-A HORIZONTAAL	TECHNISCHE GEGEVENS							STANDAARDKLEUR		ANDERE KLEUREN	
	buizen	breedte (L mm)	hoogte (H mm)	75/65/20 (Watt) (Φ50K)	55/45/20 (Watt) (Φ30K)	n-exp.	gewicht (kg)	inhoud (l)	el. weerst. (Watt)	prijs RAL 9016 (€)	prijs kleur (€)
REF. NR. VIOLA-A HORIZONTAAL H1L1-RO-A : 380											
380	280	024	XX	YY	00						
		032								1030	1185
		040								1220	1403
		048								1414	1626
		056								1609	1850
		064								1804	2075
		072								1997	2297
		080								2188	2516
		088								2385	2743
										2577	2964
380	300	024	XX	YY	00						
		032								1092	1256
		040								1297	1492
		048								1504	1730
		056								1706	1962
		064								1914	2201
		072								2121	2439
		080								2324	2673
		088								2534	2914
										2739	3150

Conform EN442-1: 2014: radiatoren en convectoren

Voor meer details over onze artikel-data, zie artikel-database: <https://www.2ba.nl>

Voor de warmteafgiftes van andere regimes, kijkt u op p. 346 (correctiefactoren)
NEDERLAND. Prijzen in euro (excl. BTW)

VIOLA-A HORIZONTAAL (H2-RO-A)



H2-RO-A
(thermostaatkop apart te bestellen)

HOE VIOLA-A HORIZONTAAL BESTELLEN

Leveringstermijn 15 - 30 werkdagen
(zonder transportduur)

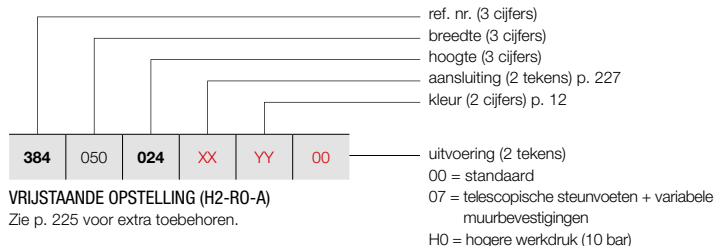

VRIJSTAANDE OPSTELLING (H2-RO-A)

Zie p. 225 voor extra toebehoren.

PRIJSGROEP: VPG2 - STAAL DESIGNRADIATOREN

BESTELCODE MAATWERK VIOLA-A HORIZONTAAL	TECHNISCHE GEGEVENS									STANDAARDKLEUR	ANDERE KLEUREN
	buizen	breedte (L mm)	hoogte (H mm)	75/65/20 (Watt) (Φ50K)	55/45/20 (Watt) (Φ30K)	n-exp.	gewicht (kg)	inhoud (l)	el. weerst. (Watt)	prijs RAL 9016 (€)	prijs kleur (€)
REF. NR. VIOLA-A HORIZONTAAL H2-RO-A : 384											
384	050	024	XX	YY	00						
		032								524	603
		040								599	689
		048								672	773
		056								745	857
		064								821	944
		072								893	1027
		080								968	1113
		088								1043	1199
										1118	1286
384	060	024	XX	YY	00						
		032								564	649
		040								646	743
		048								728	837
		056								809	930
		064								892	1026
		072								974	1120
		080								1055	1213
		088								1138	1309
										1219	1402
384	070	024	XX	YY	00						
		032								604	695
		040								692	796
		048								782	899
		056								876	1007
		064								964	1109
		072								1054	1212
		080								1145	1317
		088								1234	1419
										1325	1524
384	080	024	XX	YY	00						
		032								642	738
		040								741	852
		048								839	965
		056								935	1075
		064								1038	1194
		072								1136	1306
		080								1231	1416
		088								1331	1531
										1431	1646
384	090	024	XX	YY	00						
		032								680	782
		040								786	904
		048								896	1030
		056								1000	1150
		064								1106	1272
		072								1216	1398
		080								1323	1521
		088								1430	1645
										1538	1769

Conform EN442-1: 2014: radiatoren en convectoren

Voor meer details over onze artikel-data, zie artikel-database: <https://www.2ba.nl>

Voor de warmteafgifte van andere regimes, kijkt u op p. 346 (correctiefactoren)
NETERLAND. Prijzen in euro (excl. BTW)

HOE VIOLA-A HORIZONTAAL BESTELLEN

Leveringstermijn 15 - 30 werkdagen
(zonder transportduur)

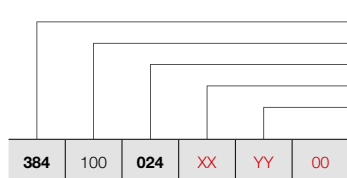

ref. nr. (3 cijfers)
breedte (3 cijfers)
hoogte (3 cijfers)
aansluiting (2 tekens) p. 227
kleur (2 cijfers) p. 12

uitvoering (2 tekens)
00 = standaard
07 = telescopische steunvoeten + variabele
muurbevestigingen
H0 = hogere werkdruk (10 bar)

VRIJSTAANDE OPSTELLING (H2-RO-A)

Zie p. 225 voor extra toebehoren.

VIOLA-A HORIZONTAAL (H2-RO-A)



H2-RO-A
(thermostaatkop apart te bestellen)

PRIJSGROEP: VPG2 - STAAL DESIGNRADIATOREN

BESTELCODE MAATWERK VIOLA-A HORIZONTAAL	TECHNISCHE GEGEVENS							STANDAARDKLEUR	ANDERE KLEUREN			
	buizen	breedte (L mm)	hoogte (H mm)	75/65/20 (Watt) (Φ50K)	55/45/20 (Watt) (Φ30K)	n-exp.	gewicht (kg)			inhoud (l)	el. weerst. (Watt)	prijs RAL 9016 (€)
REF. NR. VIOLA-A HORIZONTAAL H2-RO-A : 384												
384 100 024 XX YY 00	3	1000	240	436	222	1,23	12,20	3,40	-	721	829	
	4	1000	320	545	278	1,22	16,30	4,50	-	836	961	
	5	1000	400	658	336	1,23	20,30	5,70	-	950	1093	
	6	1000	480	778	397	1,25	24,40	6,90	-	1065	1225	
	7	1000	560	907	463	1,26	28,50	8,10	-	1179	1356	
	8	1000	640	1046	534	1,27	32,50	9,30	-	1296	1490	
	9	1000	720	1199	612	1,28	36,60	10,50	-	1410	1622	
	10	1000	800	1325	676	1,28	40,70	11,40	-	1525	1754	
	11	1000	880	1451	740	1,29	44,70	12,40	-	1643	1889	
	384 110 024 XX YY 00	3	1100	240	480	245	1,23	13,42	3,74	-	758	872
		4	1100	320	600	306	1,22	17,93	4,95	-	883	1015
5		1100	400	724	369	1,23	22,33	6,27	-	1004	1155	
6		1100	480	856	437	1,25	26,84	7,59	-	1129	1298	
7		1100	560	998	509	1,26	31,35	8,91	-	1254	1442	
8		1100	640	1151	587	1,27	35,75	10,23	-	1375	1581	
9		1100	720	1319	673	1,28	40,26	11,55	-	1500	1725	
10		1100	800	1458	744	1,28	44,77	12,54	-	1623	1866	
11		1100	880	1596	814	1,29	49,17	13,64	-	1746	2008	
384 120 024 XX YY 00		3	1200	240	523	267	1,23	14,64	4,08	-	798	918
		4	1200	320	654	334	1,22	19,56	5,40	-	929	1068
	5	1200	400	790	403	1,23	24,36	6,84	-	1061	1220	
	6	1200	480	934	476	1,25	29,28	8,28	-	1194	1373	
	7	1200	560	1088	555	1,26	34,20	9,72	-	1324	1523	
	8	1200	640	1255	640	1,27	39,00	11,16	-	1457	1676	
	9	1200	720	1439	734	1,28	43,92	12,60	-	1588	1826	
	10	1200	800	1590	811	1,28	48,84	13,68	-	1720	1978	
	11	1200	880	1741	888	1,29	53,64	14,88	-	1852	2130	
	384 140 024 XX YY 00	3	1400	240	610	311	1,23	17,08	4,76	-	876	1007
		4	1400	320	763	389	1,22	22,82	6,30	-	1022	1175
5		1400	400	921	470	1,23	28,42	7,98	-	1171	1347	
6		1400	480	1089	556	1,25	34,16	9,66	-	1322	1520	
7		1400	560	1270	648	1,26	39,90	11,34	-	1470	1691	
8		1400	640	1464	747	1,27	45,50	13,02	-	1619	1862	
9		1400	720	1679	856	1,28	51,24	14,70	-	1767	2032	
10		1400	800	1855	946	1,28	56,98	15,96	-	1914	2201	
11		1400	880	2031	1036	1,29	62,58	17,36	-	2063	2372	
384 160 024 XX YY 00		3	1600	240	698	356	1,23	19,52	5,44	-	954	1097
		4	1600	320	872	445	1,22	26,08	7,20	-	1119	1287
	5	1600	400	1053	537	1,23	32,48	9,12	-	1282	1474	
	6	1600	480	1245	635	1,25	39,04	11,04	-	1447	1664	
	7	1600	560	1451	740	1,26	45,60	12,96	-	1614	1856	
	8	1600	640	1674	854	1,27	52,00	14,88	-	1779	2046	
	9	1600	720	1918	979	1,28	58,56	16,80	-	1942	2233	
	10	1600	800	2120	1082	1,28	65,12	18,24	-	2107	2423	
	11	1600	880	2322	1184	1,29	71,52	19,84	-	2271	2612	

Conform EN442-1: 2014: radiatoren en convectoren

Voor meer details over onze artikel-data, zie artikel-database: <https://www.2ba.nl>

Voor de warmteafgiftes van andere regimes, kijkt u op p. 346 (correctiefactoren)
NEDERLAND. Prijzen in euro (excl. BTW)

VIOLA-A HORIZONTAAL (H2-RO-A)



H2-RO-A
(thermostaatkop apart te bestellen)

HOE VIOLA-A HORIZONTAAL BESTELLEN

Leveringstermijn 15 - 30 werkdagen
(zonder transportduur)

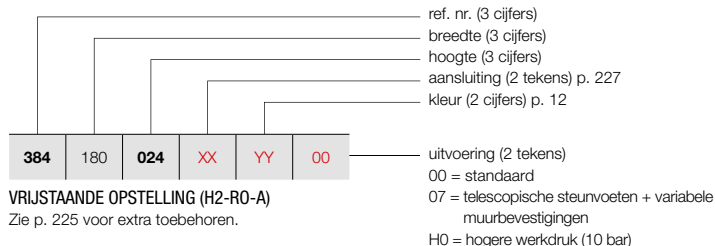

VRIJSTAANDE OPSTELLING (H2-RO-A)

Zie p. 225 voor extra toebehoren.

PRIJSGROEP: VPG2 - STAAL DESIGNRADIATOREN

BESTELCODE MAATWERK VIOLA-A HORIZONTAAL							TECHNISCHE GEGEVENS					STANDAARDKLEUR	ANDERE KLEUREN				
384	180	024	XX	YY	00	buizen	breedte (L mm)	hoogte (H mm)	75/65/20 (Watt) (Φ50K)	55/45/20 (Watt) (Φ30K)	n-exp.	gewicht (kg)	inhoud (l)	el. weerst. (Watt)	prijs RAL 9016 (€)	prijs kleur (€)	
REF. NR. VIOLA-A HORIZONTAAL H2-RO-A : 384																	
384	180	024	XX	YY	00	3	1800	240	785	400	1,23	21,96	6,12	-	1031	1186	
		032				4	1800	320	981	501	1,22	29,34	8,10	-	1214	1396	
		040				5	1800	400	1184	604	1,23	36,54	10,26	-	1393	1602	
		048				6	1800	480	1400	714	1,25	43,92	12,42	-	1576	1812	
		056				7	1800	560	1633	833	1,26	51,30	14,58	-	1755	2018	
		064				8	1800	640	1883	961	1,27	58,50	16,74	-	1939	2230	
		072				9	1800	720	2158	1101	1,28	65,88	18,90	-	2121	2439	
		080				10	1800	800	2385	1217	1,28	73,26	20,52	-	2305	2651	
		088				11	1800	880	2612	1333	1,29	80,46	22,32	-	2482	2854	
384	200	024	XX	YY	00	3	2000	240	872	445	1,23	24,40	6,80	-	1106	1272	
		032				4	2000	320	1090	556	1,22	32,60	9,00	-	1306	1502	
		040				5	2000	400	1316	671	1,23	40,60	11,40	-	1506	1732	
		048				6	2000	480	1556	794	1,25	48,80	13,80	-	1702	1957	
		056				7	2000	560	1814	926	1,26	57,00	16,20	-	1903	2188	
		064				8	2000	640	2092	1067	1,27	65,00	18,60	-	2098	2413	
		072				9	2000	720	2398	1223	1,28	73,20	21,00	-	2298	2643	
		080				10	2000	800	2650	1352	1,28	81,40	22,80	-	2497	2872	
		088				11	2000	880	2902	1481	1,29	89,40	24,80	-	2694	3098	
384	220	024	XX	YY	00	3	2200	240	959	489	1,23	26,84	7,48	-	1185	1363	
		032				4	2200	320	1199	612	1,22	35,86	9,90	-	1404	1615	
		040				5	2200	400	1448	739	1,23	44,66	12,54	-	1618	1861	
		048				6	2200	480	1712	873	1,25	53,68	15,18	-	1832	2107	
		056				7	2200	560	1995	1018	1,26	62,70	17,82	-	2047	2354	
		064				8	2200	640	2301	1174	1,27	71,50	20,46	-	2262	2601	
		072				9	2200	720	2638	1346	1,28	80,52	23,10	-	2474	2845	
		080				10	2200	800	2915	1487	1,28	89,54	25,08	-	2691	3095	
		088				11	2200	880	3192	1629	1,29	98,34	27,28	-	2906	3342	
384	240	024	XX	YY	00	3	2400	240	1046	534	1,23	29,28	8,16	-	1265	1455	
		032				4	2400	320	1308	667	1,22	39,12	10,80	-	1495	1719	
		040				5	2400	400	1579	806	1,23	48,72	13,68	-	1729	1988	
		048				6	2400	480	1867	953	1,25	58,56	16,56	-	1958	2252	
		056				7	2400	560	2177	1111	1,26	68,40	19,44	-	2188	2516	
		064				8	2400	640	2510	1281	1,27	78,00	22,32	-	2421	2784	
		072				9	2400	720	2878	1468	1,28	87,84	25,20	-	2654	3052	
		080				10	2400	800	3180	1622	1,28	97,68	27,36	-	2883	3315	
		088				11	2400	880	3482	1777	1,29	107,28	29,76	-	3115	3582	
384	260	024	XX	YY	00	3	2600	240	1134	578	1,23	31,72	8,84	-	1341	1542	
		032				4	2600	320	1417	723	1,22	42,38	11,70	-	1589	1827	
		040				5	2600	400	1711	873	1,23	52,78	14,82	-	1836	2111	
		048				6	2600	480	2023	1032	1,25	63,44	17,94	-	2088	2401	
		056				7	2600	560	2358	1203	1,26	74,10	21,06	-	2332	2682	
		064				8	2600	640	2720	1388	1,27	84,50	24,18	-	2581	2968	
		072				9	2600	720	3117	1591	1,28	95,16	27,30	-	2831	3256	
		080				10	2600	800	3445	1758	1,28	105,82	29,64	-	3078	3540	
		088				11	2600	880	3773	1925	1,29	116,22	32,24	-	3324	3823	

Conform EN442-1: 2014: radiatoren en convectoren

Voor meer details over onze artikel-data, zie artikel-database: <https://www.2ba.nl>

Voor de warmteafgifte van andere regimes, kijkt u op p. 346 (correctiefactoren)
 NEDERLAND. Prijzen in euro (excl. BTW)

HOE VIOLA-A HORIZONTAAL BESTELLEN

Leveringstermijn 15 - 30 werkdagen
(zonder transportduur)

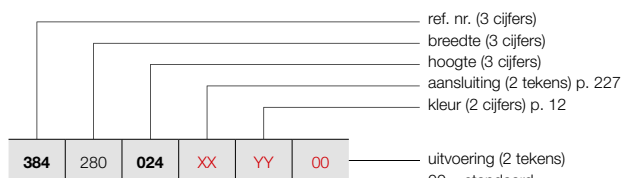

VRIJSTAANDE OPSTELLING (H2-RO-A)

Zie p. 225 voor extra toebehoren.

- 00 = standaard
- 07 = telescopische steunvoeten + variabele muurbevestigingen
- H0 = hogere werkdruk (10 bar)

VIOLA-A HORIZONTAAL (H2-RO-A)



H2-RO-A
(thermostaatkop apart te bestellen)

PRIJSGROEP: VPG2 - STAAL DESIGNRADIATOREN

BESTELCODE MAATWERK VIOLA-A HORIZONTAAL	TECHNISCHE GEGEVENS								STANDAARDKLEUR		ANDERE KLEUREN
	buizen	breedte (L mm)	hoogte (H mm)	75/65/20 (Watt) (φ50K)	55/45/20 (Watt) (φ30K)	n-exp.	gewicht (kg)	inhoud (l)	el. weerst. (Watt)	prijs RAL 9016 (€)	prijs kleur (€)
REF. NR. VIOLA-A HORIZONTAAL H2-RO-A : 384											
384	280	024	XX	YY	00						
		032								1420	1633
		040								1685	1938
		048								1948	2240
		056								2213	2545
		064								2476	2847
		072								2744	3156
		080								3008	3459
		088								3271	3762
										3535	4065
384	300	024	XX	YY	00						
		032								1497	1722
		040								1779	2046
		048								2058	2367
		056								2343	2694
		064								2622	3015
		072								2905	3341
		080								3187	3665
		088								3465	3985
										3747	4309

Conform EN442-1: 2014: radiatoren en convectoren

Voor meer details over onze artikel-data, zie artikel-database: <https://www.2ba.nl>

Voor de warmteafgiftes van andere regimes, kijkt u op p. 346 (correctiefactoren)
NETERLAND. Prijzen in euro (excl. BTW)

VIOLA-A HORIZONTAAL (H2L1-RO-A)



H2L1-RO-A
(thermostaatkop apart te bestellen)

HOE VIOLA-A HORIZONTAAL BESTELLEN

Leveringstermijn 15 - 30 werkdagen
(zonder transportduur)

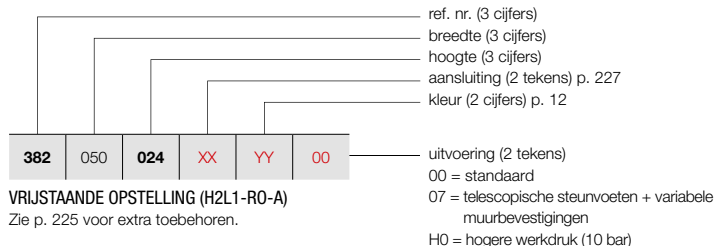

VRIJSTAANDE OPSTELLING (H2L1-RO-A)

Zie p. 225 voor extra toebehoren.

PRIJSGROEP: VPG2 - STAAL DESIGNRADIATOREN

BESTELCODE MAATWERK VIOLA-A HORIZONTAAL							TECHNISCHE GEGEVENS					STANDAARDKLEUR	ANDERE KLEUREN			
382	050	024	XX	YY	00	buizen	breedte (L mm)	hoogte (H mm)	75/65/20 (Watt) (Φ50K)	55/45/20 (Watt) (Φ30K)	n-exp.	gewicht (kg)	inhoud (l)	el. weerst. (Watt)	prijs RAL 9016 (€)	prijs kleur (€)
REF. NR. VIOLA-A HORIZONTAAL H2L1-RO-A : 382																
382	050	024	XX	YY	00	3	500	240	322	164	1,28	7,75	1,70	-	581	668
		032				4	500	320	399	204	1,30	10,35	2,25	-	674	775
		040				5	500	400	474	242	1,32	12,90	2,85	-	769	884
		048				6	500	480	550	280	1,34	15,50	3,45	-	859	988
		056				7	500	560	625	319	1,36	18,10	4,05	-	955	1098
		064				8	500	640	677	345	1,36	20,65	4,65	-	1051	1209
		072				9	500	720	728	371	1,36	23,25	5,25	-	1143	1314
		080				10	500	800	780	398	1,37	25,80	5,70	-	1234	1419
		088				11	500	880	822	419	1,36	27,85	6,20	-	1328	1527
382	060	024	XX	YY	00	3	600	240	386	197	1,28	9,30	2,04	-	627	721
		032				4	600	320	479	244	1,30	12,42	2,70	-	733	843
		040				5	600	400	569	290	1,32	15,48	3,42	-	835	960
		048				6	600	480	659	336	1,34	18,60	4,14	-	935	1075
		056				7	600	560	749	382	1,36	21,72	4,86	-	1041	1197
		064				8	600	640	812	414	1,36	24,78	5,58	-	1144	1316
		072				9	600	720	874	446	1,36	27,90	6,30	-	1247	1434
		080				10	600	800	936	478	1,37	30,96	6,84	-	1352	1555
		088				11	600	880	986	503	1,36	33,42	7,44	-	1454	1672
382	070	024	XX	YY	00	3	700	240	450	230	1,28	10,85	2,38	-	672	773
		032				4	700	320	559	285	1,30	14,49	3,15	-	785	903
		040				5	700	400	664	339	1,32	18,06	3,99	-	900	1035
		048				6	700	480	769	393	1,34	21,70	4,83	-	1010	1162
		056				7	700	560	874	446	1,36	25,34	5,67	-	1126	1295
		064				8	700	640	947	483	1,36	28,91	6,51	-	1241	1427
		072				9	700	720	1019	520	1,36	32,55	7,35	-	1354	1557
		080				10	700	800	1092	557	1,37	36,12	7,98	-	1466	1686
		088				11	700	880	1151	587	1,36	38,99	8,68	-	1578	1815
382	080	024	XX	YY	00	3	800	240	514	262	1,28	12,40	2,72	-	719	827
		032				4	800	320	638	326	1,30	16,56	3,60	-	841	967
		040				5	800	400	758	387	1,32	20,64	4,56	-	964	1109
		048				6	800	480	879	449	1,34	24,80	5,52	-	1088	1251
		056				7	800	560	999	510	1,36	28,96	6,48	-	1213	1395
		064				8	800	640	1082	552	1,36	33,04	7,44	-	1333	1533
		072				9	800	720	1165	594	1,36	37,20	8,40	-	1457	1676
		080				10	800	800	1248	637	1,37	41,28	9,12	-	1579	1816
		088				11	800	880	1315	671	1,36	44,56	9,92	-	1702	1957
382	090	024	XX	YY	00	3	900	240	579	295	1,28	13,95	3,06	-	766	881
		032				4	900	320	718	366	1,30	18,63	4,05	-	897	1032
		040				5	900	400	853	435	1,32	23,22	5,13	-	1030	1185
		048				6	900	480	989	505	1,34	27,90	6,21	-	1164	1339
		056				7	900	560	1124	574	1,36	32,58	7,29	-	1296	1490
		064				8	900	640	1218	621	1,36	37,17	8,37	-	1429	1643
		072				9	900	720	1310	669	1,36	41,85	9,45	-	1563	1797
		080				10	900	800	1404	716	1,37	46,44	10,26	-	1696	1950
		088				11	900	880	1480	755	1,36	50,13	11,16	-	1828	2102

Conform EN442-1: 2014: radiatoren en convectoren

Voor meer details over onze artikel-data, zie artikel-database: <https://www.2ba.nl>

Voor de warmteafgifte van andere regimes, kijkt u op p. 346 (correctiefactoren)
NETERLAND. Prijzen in euro (excl. BTW)

HOE VIOLA-A HORIZONTAAL BESTELLEN

Leveringstermijn 15 - 30 werkdagen
(zonder transportduur)

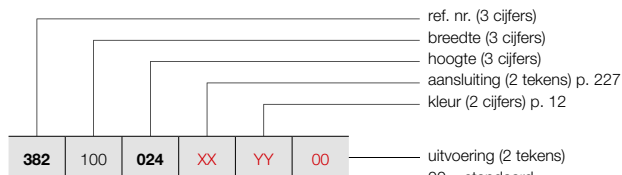

VRIJSTAANDE OPSTELLING (H2L1-RO-A)

Zie p. 225 voor extra toebehoren.

VIOLA-A HORIZONTAAL (H2L1-RO-A)



H2L1-RO-A
(thermostaatkop apart te bestellen)

PRIJSGROEP: VPG2 - STAAL DESIGNRADIATOREN

BESTELCODE MAATWERK VIOLA-A HORIZONTAAL						TECHNISCHE GEGEVENS							STANDAARDKLEUR	ANDERE KLEUREN							
						buizen	breedte (L mm)	hoogte (H mm)	75/65/20 (Watt) (φ50K)	55/45/20 (Watt) (φ30K)	n-exp.	gewicht (kg)	inhoud (l)	el. weerst. (Watt)	prijs RAL 9016 (€)	prijs kleur (€)					
REF. NR. VIOLA-A HORIZONTAAL H2L1-RO-A : 382																					
382	100	024	XX	YY	00	3	1000	240	643	328	1,28	15,50	3,40	-	809	930					
		032				4	1000	320	798	407	1,30	20,70	4,50	-	953	1096					
		040				5	1000	400	948	484	1,32	25,80	5,70	-	1095	1259					
		048				6	1000	480	1099	561	1,34	31,00	6,90	-	1238	1424					
		056				7	1000	560	1249	637	1,36	36,20	8,10	-	1379	1586					
		064				8	1000	640	1353	690	1,36	41,30	9,30	-	1523	1751					
		072				9	1000	720	1456	743	1,36	46,50	10,50	-	1666	1916					
		080				10	1000	800	1560	796	1,37	51,60	11,40	-	1809	2080					
		088				11	1000	880	1644	839	1,36	55,70	12,40	-	1950	2243					
		382				110	024	XX	YY	00	3	1100	240	707	361	1,28	17,05	3,74	-	853	981
							032				4	1100	320	878	448	1,30	22,77	4,95	-	1005	1156
040	5		1100	400	1043		532				1,32	28,38	6,27	-	1161	1335					
048	6		1100	480	1209		617				1,34	34,10	7,59	-	1312	1509					
056	7		1100	560	1374		701				1,36	39,82	8,91	-	1467	1687					
064	8		1100	640	1488		759				1,36	45,43	10,23	-	1620	1863					
072	9		1100	720	1602		817				1,36	51,15	11,55	-	1773	2039					
080	10		1100	800	1716		876				1,37	56,76	12,54	-	1925	2214					
088	11		1100	880	1808		923				1,36	61,27	13,64	-	2077	2389					
382	120		024	XX	YY		00				3	1200	240	772	394	1,28	18,60	4,08	-	900	1035
			032								4	1200	320	958	489	1,30	24,84	5,40	-	1063	1222
		040	5			1200		400	1138	580	1,32	30,96	6,84	-	1224	1408					
		048	6			1200		480	1319	673	1,34	37,20	8,28	-	1388	1596					
		056	7			1200		560	1499	765	1,36	43,44	9,72	-	1549	1781					
		064	8			1200		640	1624	828	1,36	49,56	11,16	-	1713	1970					
		072	9			1200		720	1747	891	1,36	55,80	12,60	-	1877	2159					
		080	10			1200		800	1872	955	1,37	61,92	13,68	-	2039	2345					
		088	11			1200		880	1973	1007	1,36	66,84	14,88	-	2201	2531					
		382	140			024		XX	YY	00	3	1400	240	900	459	1,28	21,70	4,76	-	991	1140
						032					4	1400	320	1117	570	1,30	28,98	6,30	-	1172	1348
040	5			1400	400	1327	677				1,32	36,12	7,98	-	1358	1562					
048	6			1400	480	1539	785				1,34	43,40	9,66	-	1539	1770					
056	7			1400	560	1749	892				1,36	50,68	11,34	-	1720	1978					
064	8			1400	640	1894	966				1,36	57,82	13,02	-	1904	2190					
072	9			1400	720	2038	1040				1,36	65,10	14,70	-	2088	2401					
080	10			1400	800	2184	1114				1,37	72,24	15,96	-	2268	2608					
088	11			1400	880	2302	1174				1,36	77,98	17,36	-	2453	2821					
382	160			024	XX	YY	00				3	1600	240	1029	525	1,28	24,80	5,44	-	1082	1244
				032							4	1600	320	1277	651	1,30	33,12	7,20	-	1282	1474
		040	5	1600				400	1517	774	1,32	41,28	9,12	-	1486	1709					
		048	6	1600				480	1758	897	1,34	49,60	11,04	-	1690	1944					
		056	7	1600				560	1998	1020	1,36	57,92	12,96	-	1890	2174					
		064	8	1600				640	2165	1104	1,36	66,08	14,88	-	2094	2408					
		072	9	1600				720	2330	1189	1,36	74,40	16,80	-	2297	2642					
		080	10	1600				800	2496	1273	1,37	82,56	18,24	-	2498	2873					
		088	11	1600				880	2630	1342	1,36	89,12	19,84	-	2701	3106					

Conform EN442-1: 2014: radiatoren en convectoren

Voor meer details over onze artikel-data, zie artikel-database: <https://www.2ba.nl>

Voor de warmteafgiftes van andere regimes, kijkt u op p. 346 (correctiefactoren)
NEDERLAND. Prijzen in euro (excl. BTW)

VIOLA-A HORIZONTAAL (H2L1-RO-A)



H2L1-RO-A
(thermostaatkop apart te bestellen)

HOE VIOLA-A HORIZONTAAL BESTELLEN

Leveringstermijn 15 - 30 werkdagen
(zonder transportduur)

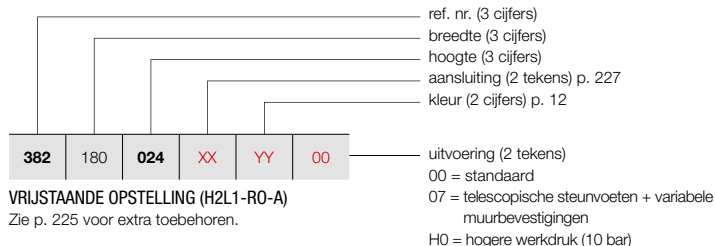

VRIJSTAANDE OPSTELLING (H2L1-RO-A)
 Zie p. 225 voor extra toebehoren.

PRIJSGROEP: VPG2 - STAAL DESIGNRADIATOREN

BESTELCODE MAATWERK VIOLA-A HORIZONTAAL	TECHNISCHE GEGEVENS									STANDAARDKLEUR	ANDERE KLEUREN	
	buizen	breedte (L mm)	hoogte (H mm)	75/65/20 (Watt) (Φ50K)	55/45/20 (Watt) (Φ30K)	n-exp.	gewicht (kg)	inhoud (l)	el. weerst. (Watt)	prijs RAL 9016 (€)	prijs kleur (€)	
REF. NR. VIOLA-A HORIZONTAAL H2L1-RO-A : 382												
382 180 024 XX YY 00	032	180	240	1157	591	1,28	27,90	6,12	-	1172	1348	
	040	180	320	1436	733	1,30	37,26	8,10	-	1398	1608	
	048	180	400	1706	871	1,32	46,44	10,26	-	1618	1861	
	056	180	480	1978	1009	1,34	55,80	12,42	-	1837	2113	
	064	180	560	2248	1147	1,36	65,16	14,58	-	2062	2371	
	072	180	640	2435	1243	1,36	74,34	16,74	-	2282	2624	
	080	180	720	2621	1337	1,36	83,70	18,90	-	2506	2882	
	088	180	800	2808	1433	1,37	92,88	20,52	-	2727	3136	
		180	880	2959	1510	1,36	100,26	22,32	-	2952	3395	
		200	240	1286	656	1,28	31,00	6,80	-	1261	1450	
	382 200 024 XX YY 00	032	200	320	1596	814	1,30	41,40	9,00	-	1508	1734
040		200	400	1896	967	1,32	51,60	11,40	-	1746	2008	
048		200	480	2198	1121	1,34	62,00	13,80	-	1988	2286	
056		200	560	2498	1274	1,36	72,40	16,20	-	2231	2566	
064		200	640	2706	1381	1,36	82,60	18,60	-	2473	2844	
072		200	720	2912	1486	1,36	93,00	21,00	-	2716	3123	
080		200	800	3120	1592	1,37	103,20	22,80	-	2957	3401	
088		200	880	3288	1678	1,36	111,40	24,80	-	3200	3680	
		220	240	1415	722	1,28	34,10	7,48	-	1355	1558	
382 220 024 XX YY 00		032	220	320	1756	896	1,30	45,54	9,90	-	1618	1861
		040	220	400	2086	1064	1,32	56,76	12,54	-	1880	2162
	048	220	480	2418	1234	1,34	68,20	15,18	-	2142	2463	
	056	220	560	2748	1402	1,36	79,64	17,82	-	2401	2761	
	064	220	640	2977	1519	1,36	90,86	20,46	-	2662	3061	
	072	220	720	3203	1634	1,36	102,30	23,10	-	2924	3363	
	080	220	800	3432	1751	1,37	113,52	25,08	-	3188	3666	
	088	220	880	3617	1845	1,36	122,54	27,28	-	3450	3968	
		240	240	1543	787	1,28	37,20	8,16	-	1444	1661	
	382 240 024 XX YY 00	032	240	320	1915	977	1,30	49,68	10,80	-	1729	1988
		040	240	400	2275	1161	1,32	61,92	13,68	-	2009	2310
048		240	480	2638	1346	1,34	74,40	16,56	-	2292	2636	
056		240	560	2998	1529	1,36	86,88	19,44	-	2574	2960	
064		240	640	3247	1657	1,36	99,12	22,32	-	2850	3278	
072		240	720	3494	1783	1,36	111,60	25,20	-	3134	3604	
080		240	800	3744	1910	1,37	123,84	27,36	-	3417	3930	
088		240	880	3946	2013	1,36	133,68	29,76	-	3696	4250	
		260	240	1672	853	1,28	40,30	8,84	-	1537	1768	
382 260 024 XX YY 00		032	260	320	2075	1059	1,30	53,82	11,70	-	1836	2111
		040	260	400	2465	1258	1,32	67,08	14,82	-	2137	2458
	048	260	480	2857	1458	1,34	80,60	17,94	-	2440	2806	
	056	260	560	3247	1657	1,36	94,12	21,06	-	2742	3153	
	064	260	640	3518	1795	1,36	107,38	24,18	-	3047	3504	
	072	260	720	3786	1931	1,36	120,90	27,30	-	3347	3849	
	080	260	800	4056	2069	1,37	134,16	29,64	-	3645	4192	
	088	260	880	4274	2181	1,36	144,82	32,24	-	3950	4543	

Conform EN442-1: 2014: radiatoren en convectoren

Voor meer details over onze artikel-data, zie artikel-database: <https://www.2ba.nl>

Voor de warmteafgifte van andere regimes, kijkt u op p. 346 (correctiefactoren)
 NEDERLAND. Prijzen in euro (excl. BTW)

HOE VIOLA-A HORIZONTAAL BESTELLEN

Leveringstermijn 15 - 30 werkdagen
(zonder transportduur)

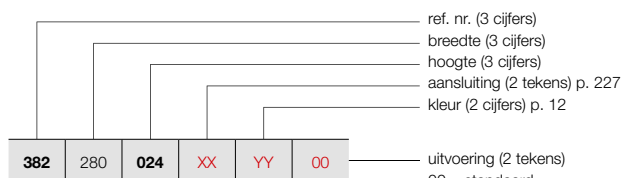

VRIJSTAANDE OPSTELLING (H2L1-RO-A)

Zie p. 225 voor extra toebehoren.

00 = standaard
07 = telescopische steunvoeten + variabele muurbevestigingen
H0 = hogere werkdruk (10 bar)

VIOLA-A HORIZONTAAL (H2L1-RO-A)



H2L1-RO-A
(thermostaatkop apart te bestellen)

PRIJSGROEP: VPG2 - STAAL DESIGNRADIATOREN

BESTELCODE MAATWERK VIOLA-A HORIZONTAAL	TECHNISCHE GEGEVENS							STANDAARDKLEUR		ANDERE KLEUREN	
	buizen	breedte (L mm)	hoogte (H mm)	75/65/20 (Watt) (Φ50K)	55/45/20 (Watt) (Φ30K)	n-exp.	gewicht (kg)	inhoud (l)	el. weerst. (Watt)	prijs RAL 9016 (€)	prijs kleur (€)
REF. NR. VIOLA-A HORIZONTAAL H2L1-RO-A : 382											
382	280	024	XX	YY	00						
		032								1624	1868
		040								1947	2239
		048								2269	2609
		056								2589	2977
		064								2914	3351
		072								3235	3720
		080								3554	4087
		088								3877	4459
										4198	4828
382	300	024	XX	YY	00						
		032								1717	1975
		040								2057	2366
		048								2399	2759
		056								2740	3151
		064								3083	3545
		072								3426	3940
		080								3764	4329
		088								4106	4722
										4446	5113

Conform EN442-1: 2014: radiatoren en convectoren

Voor meer details over onze artikel-data, zie artikel-database: <https://www.2ba.nl>

Voor de warmteafgiftes van andere regimes, kijkt u op p. 346 (correctiefactoren)
NEDERLAND. Prijzen in euro (excl. BTW)

VIOLA-A HORIZONTAAL (H2L2-RO-A)



H2L2-RO-A
(thermostaatkop apart te bestellen)

HOE VIOLA-A HORIZONTAAL BESTELLEN

Leveringstermijn 15 - 30 werkdagen
(zonder transportduur)

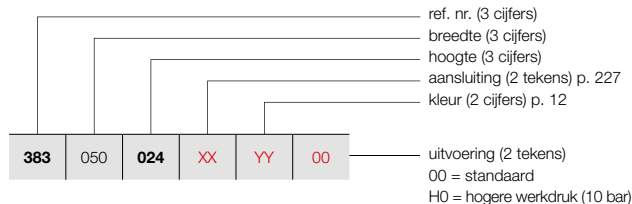

PRIJSGROEP: VPG2 - STAAL DESIGNRADIATOREN

BESTELCODE MAATWERK VIOLA-A HORIZONTAAL							TECHNISCHE GEGEVENS					STANDAARDKLEUR	ANDERE KLEUREN			
buizen	breedte (L mm)	hoogte (H mm)	75/65/20 (Watt) (Φ50K)	55/45/20 (Watt) (Φ30K)	n-exp.	gewicht (kg)	inhoud (l)	el. weerst. (Watt)	prijs RAL 9016 (€)	prijs kleur (€)						
REF. NR. VIOLA-A HORIZONTAAL H2L2-RO-A : 383																
383	050	024	XX	YY	00	3	500	240	433	221	1,25	9,70	2,00	-	629	723
		032				4	500	320	538	274	1,30	12,90	2,75	-	738	849
		040				5	500	400	663	338	1,31	16,10	3,45	-	841	967
		048				6	500	480	788	402	1,33	19,40	4,15	-	947	1089
		056				7	500	560	913	466	1,34	22,60	4,85	-	1052	1210
		064				8	500	640	993	507	1,34	25,85	5,50	-	1159	1333
		072				9	500	720	1073	547	1,34	29,10	6,20	-	1261	1450
		080				10	500	800	1153	588	1,36	32,30	6,90	-	1366	1571
		088				11	500	880	1204	614	1,36	34,45	7,60	-	1472	1693
383	060	024	XX	YY	00	3	600	240	519	265	1,25	11,64	2,40	-	687	790
		032				4	600	320	645	329	1,30	15,48	3,30	-	802	922
		040				5	600	400	796	406	1,31	19,32	4,14	-	919	1057
		048				6	600	480	946	482	1,33	23,28	4,98	-	1039	1195
		056				7	600	560	1096	559	1,34	27,12	5,82	-	1152	1325
		064				8	600	640	1192	608	1,34	31,02	6,60	-	1275	1466
		072				9	600	720	1287	657	1,34	34,92	7,44	-	1390	1599
		080				10	600	800	1383	706	1,36	38,76	8,28	-	1510	1737
		088				11	600	880	1445	737	1,36	41,34	9,12	-	1624	1868
383	070	024	XX	YY	00	3	700	240	606	309	1,25	13,58	2,80	-	741	852
		032				4	700	320	753	384	1,30	18,06	3,85	-	872	1003
		040				5	700	400	928	474	1,31	22,54	4,83	-	999	1149
		048				6	700	480	1103	563	1,33	27,16	5,81	-	1131	1301
		056				7	700	560	1278	652	1,34	31,64	6,79	-	1259	1448
		064				8	700	640	1390	709	1,34	36,19	7,70	-	1388	1596
		072				9	700	720	1502	766	1,34	40,74	8,68	-	1521	1749
		080				10	700	800	1614	823	1,36	45,22	9,66	-	1651	1899
		088				11	700	880	1686	860	1,36	48,23	10,64	-	1779	2046
383	080	024	XX	YY	00	3	800	240	692	353	1,25	15,52	3,20	-	797	917
		032				4	800	320	860	439	1,30	20,64	4,40	-	935	1075
		040				5	800	400	1061	541	1,31	25,76	5,52	-	1081	1243
		048				6	800	480	1261	643	1,33	31,04	6,64	-	1220	1403
		056				7	800	560	1461	745	1,34	36,16	7,76	-	1363	1567
		064				8	800	640	1589	811	1,34	41,36	8,80	-	1508	1734
		072				9	800	720	1716	876	1,34	46,56	9,92	-	1649	1896
		080				10	800	800	1844	941	1,36	51,68	11,04	-	1791	2060
		088				11	800	880	1926	983	1,36	55,12	12,16	-	1934	2224
383	090	024	XX	YY	00	3	900	240	779	397	1,25	17,46	3,60	-	848	975
		032				4	900	320	968	494	1,30	23,22	4,95	-	1003	1153
		040				5	900	400	1193	609	1,31	28,98	6,21	-	1160	1334
		048				6	900	480	1418	724	1,33	34,92	7,47	-	1312	1509
		056				7	900	560	1643	838	1,34	40,68	8,73	-	1468	1688
		064				8	900	640	1787	912	1,34	46,53	9,90	-	1622	1865
		072				9	900	720	1931	985	1,34	52,38	11,16	-	1778	2045
		080				10	900	800	2075	1058	1,36	58,14	12,42	-	1932	2222
		088				11	900	880	2167	1106	1,36	62,01	13,68	-	2088	2401

Conform EN442-1: 2014: radiatoren en convectoren

Voor meer details over onze artikel-data, zie artikel-database: <https://www.2ba.nl>

Voor de warmteafgiftes van andere regimes, kijkt u op p. 346 (correctiefactoren)
NEDERLAND. Prijzen in euro (excl. BTW)

HOE VIOLA-A HORIZONTAAL BESTELLEN

Leveringstermijn 15 - 30 werkdagen
(zonder transportduur)

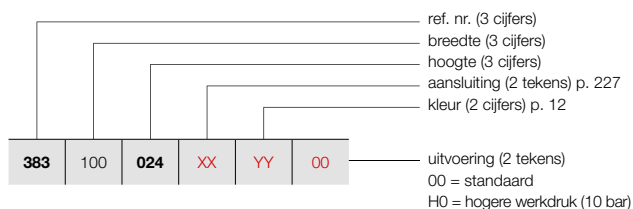

VIOLA-A HORIZONTAAL (H2L2-RO-A)



H2L2-RO-A
(thermostaatkop apart te bestellen)

PRIJSGROEP: VPG2 - STAAL DESIGNRADIATOREN

BESTELCODE MAATWERK VIOLA-A HORIZONTAAL	TECHNISCHE GEGEVENS							STANDAARDKLEUR	ANDERE KLEUREN			
	buizen	breedte (L mm)	hoogte (H mm)	75/65/20 (Watt) (Φ50K)	55/45/20 (Watt) (Φ30K)	n-exp.	gewicht (kg)			inhoud (l)	el. weerst. (Watt)	prijs RAL 9016 (€)
REF. NR. VIOLA-A HORIZONTAAL H2L2-RO-A : 383												
383 100 024 XX YY 00	3	1000	240	865	441	1,25	19,40	4,00	-	904	1040	
	4	1000	320	1075	548	1,30	25,80	5,50	-	1070	1231	
	5	1000	400	1326	677	1,31	32,20	6,90	-	1241	1427	
	6	1000	480	1576	804	1,33	38,80	8,30	-	1406	1617	
	7	1000	560	1826	932	1,34	45,20	9,70	-	1572	1808	
	8	1000	640	1986	1013	1,34	51,70	11,00	-	1739	2000	
	9	1000	720	2145	1094	1,34	58,20	12,40	-	1906	2192	
	10	1000	800	2305	1176	1,36	64,60	13,80	-	2071	2382	
	11	1000	880	2408	1229	1,36	68,90	15,20	-	2238	2574	
	383 110 024 XX YY 00	3	1100	240	952	485	1,25	21,34	4,40	-	960	1104
		4	1100	320	1183	603	1,30	28,38	6,05	-	1139	1310
5		1100	400	1459	744	1,31	35,42	7,59	-	1319	1517	
6		1100	480	1734	884	1,33	42,68	9,13	-	1497	1722	
7		1100	560	2009	1025	1,34	49,72	10,67	-	1676	1927	
8		1100	640	2185	1115	1,34	56,87	12,10	-	1854	2132	
9		1100	720	2360	1204	1,34	64,02	13,64	-	2036	2341	
10		1100	800	2536	1294	1,36	71,06	15,18	-	2214	2546	
11		1100	880	2649	1351	1,36	75,79	16,72	-	2392	2751	
383 120 024 XX YY 00		3	1200	240	1038	530	1,25	23,28	4,80	-	1015	1167
		4	1200	320	1290	658	1,30	30,96	6,60	-	1207	1388
	5	1200	400	1591	812	1,31	38,64	8,28	-	1400	1610	
	6	1200	480	1891	965	1,33	46,56	9,96	-	1589	1827	
	7	1200	560	2191	1118	1,34	54,24	11,64	-	1781	2048	
	8	1200	640	2383	1216	1,34	62,04	13,20	-	1973	2269	
	9	1200	720	2574	1313	1,34	69,84	14,88	-	2163	2487	
	10	1200	800	2766	1411	1,36	77,52	16,56	-	2355	2708	
	11	1200	880	2890	1474	1,36	82,68	18,24	-	2546	2928	
	383 140 024 XX YY 00	3	1400	240	1211	618	1,25	27,16	5,60	-	1126	1295
		4	1400	320	1505	768	1,30	36,12	7,70	-	1341	1542
5		1400	400	1856	947	1,31	45,08	9,66	-	1557	1791	
6		1400	480	2206	1126	1,33	54,32	11,62	-	1774	2040	
7		1400	560	2556	1304	1,34	63,28	13,58	-	1988	2286	
8		1400	640	2780	1419	1,34	72,38	15,40	-	2204	2535	
9		1400	720	3003	1532	1,34	81,48	17,36	-	2421	2784	
10		1400	800	3227	1646	1,36	90,44	19,32	-	2636	3031	
11		1400	880	3371	1720	1,36	96,46	21,28	-	2850	3278	
383 160 024 XX YY 00		3	1600	240	1384	706	1,25	31,04	6,40	-	1231	1416
		4	1600	320	1720	878	1,30	41,28	8,80	-	1474	1695
	5	1600	400	2122	1082	1,31	51,52	11,04	-	1716	1973	
	6	1600	480	2522	1287	1,33	62,08	13,28	-	1957	2251	
	7	1600	560	2922	1491	1,34	72,32	15,52	-	2198	2528	
	8	1600	640	3178	1621	1,34	82,72	17,60	-	2439	2805	
	9	1600	720	3432	1751	1,34	93,12	19,84	-	2678	3080	
	10	1600	800	3688	1882	1,36	103,36	22,08	-	2920	3358	
	11	1600	880	3853	1966	1,36	110,24	24,32	-	3160	3634	

Conform EN442-1: 2014: radiatoren en convectoren

Voor meer details over onze artikel-data, zie artikel-database: <https://www.2ba.nl>

Voor de warmteafgiftes van andere regimes, kijkt u op p. 346 (correctiefactoren)
NEDERLAND. Prijzen in euro (excl. BTW)

VIOLA-A HORIZONTAAL (H2L2-RO-A)



H2L2-RO-A
(thermostaatkop apart te bestellen)

HOE VIOLA-A HORIZONTAAL BESTELLEN

Leveringstermijn 15 - 30 werkdagen
(zonder transportduur)

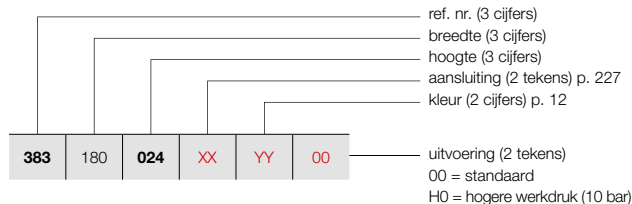

PRIJSGROEP: VPG2 - STAAL DESIGNRADIATOREN

BESTELCODE MAATWERK VIOLA-A HORIZONTAAL							TECHNISCHE GEGEVENS					STANDAARDKLEUR	ANDERE KLEUREN								
buizen	breedte (L mm)	hoogte (H mm)	75/65/20 (Watt) (Φ50K)	55/45/20 (Watt) (Φ30K)	n-exp.	gewicht (kg)	inhoud (l)	el. weerst. (Watt)	prijs RAL 9016 (€)	prijs kleur (€)											
REF. NR. VIOLA-A HORIZONTAAL H2L2-RO-A : 383																					
383	180	024	XX	YY	00	3	1800	240	1557	794	1,25	34,92	7,20	-	1348	1550					
		032				4	1800	320	1935	987	1,30	46,44	9,90	-	1610	1852					
		040				5	1800	400	2387	1218	1,31	57,96	12,42	-	1875	2156					
		048				6	1800	480	2837	1447	1,33	69,84	14,94	-	2142	2463					
		056				7	1800	560	3287	1677	1,34	81,36	17,46	-	2403	2763					
		064				8	1800	640	3575	1824	1,34	93,06	19,80	-	2674	3075					
		072				9	1800	720	3861	1970	1,34	104,76	22,32	-	2937	3378					
		080				10	1800	800	4149	2117	1,36	116,28	24,84	-	3202	3682					
		088				11	1800	880	4334	2211	1,36	124,02	27,36	-	3466	3986					
		383				200	024	XX	YY	00	3	2000	240	1730	883	1,25	38,80	8,00	-	1456	1674
							032				4	2000	320	2150	1097	1,30	51,60	11,00	-	1743	2004
040	5		2000	400	2652		1353				1,31	64,40	13,80	-	2036	2341					
048	6		2000	480	3152		1608				1,33	77,60	16,60	-	2323	2671					
056	7		2000	560	3652		1863				1,34	90,40	19,40	-	2614	3006					
064	8		2000	640	3972		2027				1,34	103,40	22,00	-	2905	3341					
072	9		2000	720	4290		2189				1,34	116,40	24,80	-	3197	3677					
080	10		2000	800	4610		2352				1,36	129,20	27,60	-	3484	4007					
088	11		2000	880	4816		2457				1,36	137,80	30,40	-	3772	4338					
383	220		024	XX	YY		00				3	2200	240	1903	971	1,25	42,68	8,80	-	1564	1799
			032								4	2200	320	2365	1207	1,30	56,76	12,10	-	1881	2163
		040	5			2200		400	2917	1488	1,31	70,84	15,18	-	2196	2525					
		048	6			2200		480	3467	1769	1,33	85,36	18,26	-	2507	2883					
		056	7			2200		560	4017	2050	1,34	99,44	21,34	-	2824	3248					
		064	8			2200		640	4369	2229	1,34	113,74	24,20	-	3140	3611					
		072	9			2200		720	4719	2408	1,34	128,04	27,28	-	3452	3970					
		080	10			2200		800	5071	2587	1,36	142,12	30,36	-	3766	4331					
		088	11			2200		880	5298	2703	1,36	151,58	33,44	-	4082	4694					
		383	240			024		XX	YY	00	3	2400	240	2076	1059	1,25	46,56	9,60	-	1673	1924
						032					4	2400	320	2580	1316	1,30	61,92	13,20	-	2015	2317
040	5			2400	400	3182	1624				1,31	77,28	16,56	-	2353	2706					
048	6			2400	480	3782	1930				1,33	93,12	19,92	-	2692	3096					
056	7			2400	560	4382	2236				1,34	108,48	23,28	-	3032	3487					
064	8			2400	640	4766	2432				1,34	124,08	26,40	-	3370	3876					
072	9			2400	720	5148	2627				1,34	139,68	29,76	-	3710	4267					
080	10			2400	800	5532	2822				1,36	155,04	33,12	-	4049	4656					
088	11			2400	880	5779	2949				1,36	165,36	36,48	-	4385	5043					
383	260			024	XX	YY	00				3	2600	240	2249	1147	1,25	50,44	10,40	-	1785	2053
				032							4	2600	320	2795	1426	1,30	67,08	14,30	-	2149	2471
		040	5	2600				400	3448	1759	1,31	83,72	17,94	-	2512	2889					
		048	6	2600				480	4098	2091	1,33	100,88	21,58	-	2876	3307					
		056	7	2600				560	4748	2422	1,34	117,52	25,22	-	3240	3726					
		064	8	2600				640	5164	2634	1,34	134,42	28,60	-	3601	4141					
		072	9	2600				720	5577	2845	1,34	151,32	32,24	-	3968	4563					
		080	10	2600				800	5993	3058	1,36	167,96	35,88	-	4332	4982					
		088	11	2600				880	6261	3194	1,36	179,14	39,52	-	4697	5402					

Conform EN442-1: 2014: radiatoren en convectoren

Voor meer details over onze artikel-data, zie artikel-database: <https://www.2ba.nl>

Voor de warmteafgiftes van andere regimes, kijkt u op p. 346 (correctiefactoren)
 NEDERLAND. Prijzen in euro (excl. BTW)

HOE VIOLA-A HORIZONTAAL BESTELLEN

Leveringstermijn 15 - 30 werkdagen
(zonder transportduur)

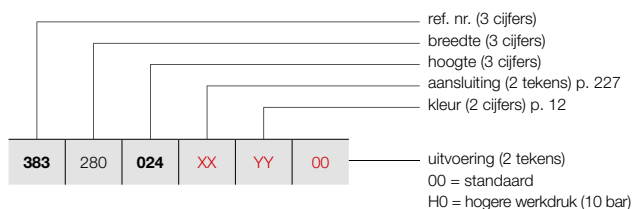

VIOLA-A HORIZONTAAL (H2L2-RO-A)



H2L2-RO-A
(thermostaatkop apart te bestellen)

PRIJSGROEP: VPG2 - STAAL DESIGNRADIATOREN

BESTELCODE MAATWERK VIOLA-A HORIZONTAAL	TECHNISCHE GEGEVENS							STANDAARDKLEUR		ANDERE KLEUREN	
	buizen	breedte (L mm)	hoogte (H mm)	75/65/20 (Watt) (Φ50K)	55/45/20 (Watt) (Φ30K)	n-exp.	gewicht (kg)	inhoud (l)	el. weerst. (Watt)	prijs RAL 9016 (€)	prijs kleur (€)
REF. NR. VIOLA-A HORIZONTAAL H2L2-RO-A : 383											
383	280	024	XX	YY	00						
		032								1892	2176
		040								2281	2623
		048								2673	3074
		056								3061	3520
		064								3450	3968
		072								3836	4411
		080								4224	4858
										4613	5305
383	300	024	XX	YY	00						
		032								2003	2303
		040								2418	2781
		048								2831	3256
		056								3243	3729
		064								3659	4208
		072								4067	4677
										4484	5157



Conform EN442-1: 2014: radiatoren en convectoren

Voor meer details over onze artikel-data, zie artikel-database: <https://www.2ba.nl>
Voor de warmteafgiftes van andere regimes, kijkt u op p. 346 (correctiefactoren)
NEDERLAND. Prijzen in euro (excl. BTW)

VIOLA-A WANDBEVESTIGING

IN OPTIE

PRIJSGROEP: VPG10 - ACC.

WANDOPSTELLING	BREEDTE RADIATOR	KLEUR	ART. NR.	€
TELESCOPISCHE STEUNVOETEN + VARIABLE MUURBEVESTIGINGEN 	V2-ZB-A			
	(2 voeten)	RAL 9016	*	90
		KLEUR	*	104
	H2-RO-A, H2L1-RO-A			
	≤ 2000 mm (2 voeten)	RAL 9016	*	90
		KLEUR	*	104
≥ 2200 mm (3 voeten)	RAL 9016	*	137	
	KLEUR	*	158	
* Opgelet: Voeten moeten gelijktijdig met de radiator besteld worden. Gelieve bij bestelling code 07 aan te geven bij "Afwerking".				
AFDEKROZET STANDVOET CHAPE 	V2-ZB-A			
		RAL 9016	11810390000	29
• 56 x 56 mm. Aantal rozetten = aantal standvoeten				
AFDEKROZET STANDVOET AFGEWERKTE VLOER 	H2-RO-A, H2L1-RO-A			
		RAL 9016	11810400000	37
• 104 x 84 mm. Aantal rozetten = aantal standvoeten				

NEDERLAND. Prijzen in euro (excl. BTW)

PRIJSGROEP: VPG10 - ACC.

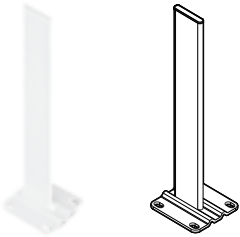
VRIJSTAANDE OPSTELLING	HOOGTE VOET	KLEUR	ART. NR.	€
STANDVOET VRIJSTAANDE OPSTELLING 	H1-RO-A, H1L1-RO-A, H2-RO-A, H2L1-RO-A, H2L2-RO-A			
	H = 450 mm	RAL 9016	11810350450	60
		KLEUR	11810350450C	69
	H = 550 mm	RAL 9016	11810350550	60
		KLEUR	11810350550C	69
	H = 600 mm	RAL 9016	11810350600	60
		KLEUR	11810350600C	69
	H = 650 mm	RAL 9016	11810350650	60
		KLEUR	11810350650C	69
	H = 750 mm	RAL 9016	11810350750	60
		KLEUR	11810350750C	69
	H = 850 mm	RAL 9016	11810350850	74
		KLEUR	11810350850C	85
	H = 900 mm	RAL 9016	11810350900	74
	KLEUR	11810350900C	85	
H = 1050 mm	RAL 9016	11810351050	74	
	KLEUR	11810351050C	85	
H = 1200 mm	RAL 9016	11810351200	74	
	KLEUR	11810351200C	85	
<ul style="list-style-type: none"> Afgewerkte vloer: hoogte voet = hoogte radiator + 150 mm Chape: hoogte voet = hoogte radiator + 300 mm Zelf in te korten indien nodig 				

BEVESTIGING STANDVOET VRIJSTAANDE OPSTELLING 	H1-RO-A, H1L1-RO-A, H2-RO-A, H2L1-RO-A, H2L2-RO-A			
		RAL 9016	11810360000	48
		KLEUR	11810360000C	55

AFDEKROZET STANDVOET CHAPE 	H1-RO-A, H1L1-RO-A, H2-RO-A, H2L1-RO-A, H2L2-RO-A			
		RAL 9016	11810370000	12
		KLEUR	11810370000C	14
<ul style="list-style-type: none"> 100 x 40 mm. Aantal rozetten = aantal standvoeten 				



AFDEKROZET STANDVOET AFGEWERKTE VLOER 	H1-RO-A, H1L1-RO-A, H2-RO-A, H2L1-RO-A, H2L2-RO-A			
		RAL 9016	11810380000	15
		KLEUR	11810380000C	17
<ul style="list-style-type: none"> 115 x 110 mm. Aantal rozetten = aantal standvoeten 				

hoogte radiator (mm)	Lengte radiator (mm)	aantal standvoeten	aantal bevestigingen standvoet
240 - 880	500-2000	2x	2x
	2200-3000	3x	3x

NEDERLAND. Prijzen in euro (excl. BTW)

VIOLA-A ACCESSOIRES
IN OPTIE

PRIJSGROEP: VPG10 - ACC.

ACCESSOIRES		KLEUR	ART. NR.	€
THERMOSTAATKOP		V1-ZB-A, V1L1-ZB-A, V2-ZB-A H1-RO-A, H1L1-RO-A, H2-RO-A, H2L1-RO-A, H2L2-RO-A		
		WIT	11911630102	50
THERMOSTAATKOP		V1-ZB-A, V1L1-ZB-A, V2-ZB-A H1-RO-A, H1L1-RO-A, H2-RO-A, H2L1-RO-A, H2L2-RO-A		
		CHROOM	11911631102	64

PRIJSGROEP: VPG10B - HANDDOEKBEUGELS

ACCESSOIRES	BREEDTE HANDDOEKBEUGEL	KLEUR	ART. NR.	€	
KNOP		V1-ZB-A, V1L1-ZB-A, V2-ZB-A			
		CHROOM	118341100000099	87	
• h = 70 mm; b = 70 mm; d = 51 mm; a = 43 mm;					
HANDDOEKBEUGEL		V1-ZB-A, V1L1-ZB-A, V2-ZB-A H1-RO-A, H1L1-RO-A, H2-RO-A, H2L1-RO-A, H2L2-RO-A			
		500 mm	CHROOM	118327000000099	145
		500 mm	RAL 9016	118327000009016	145
		500 mm	RAL 9005 ^{mat}	118327000009005	145
• h = 55 mm; b = 500 mm; d = 53 mm; a = 38 mm;					

^{mat} mat zwart

d = afstand voorkant accessoire tot voorkant radiator
a = afstand accessoire tot radiator
uit voorraad leverbaar

Montagevoorschriften accessoires: zie www.vasco.eu
NEDERLAND. Prijzen in euro (excl. BTW)

VIOLA-A VERTICAAL: V1-ZB-A / V1L1-ZB-A / V2-ZB-A (VOORRAAD)

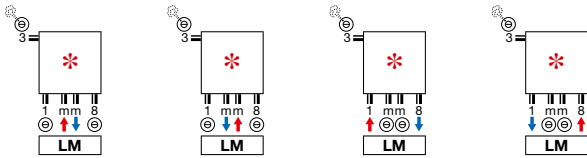

- * Aanvoer en retour kunnen verwisseld worden
- Bovenvermelde aansluiting voor voorraad radiator met even aantal buizen. Ook beschikbaar voor niet-voorraadradiatoren met even aantal buizen.

VIOLA-A VERTICAAL: V1-ZB-A / V1L1-ZB-A / V2-ZB-A (NIET-VOORRAAD)

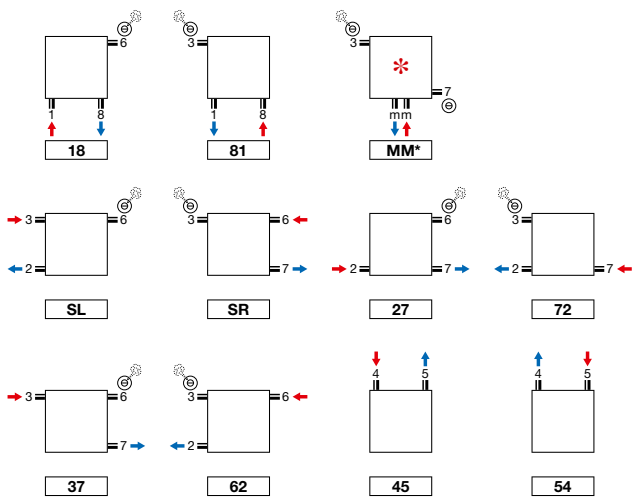

- * Aanvoer en retour kunnen verwisseld worden
- mm aansluiting alleen mogelijk bij even aantal buizen.

VIOLA-A HORIZONTAAL: H1-RO-A / H1L1-RO-A / H2-RO-A / H2L1-RO-A / H2L2-RO-A (NIET-VOORRAAD)

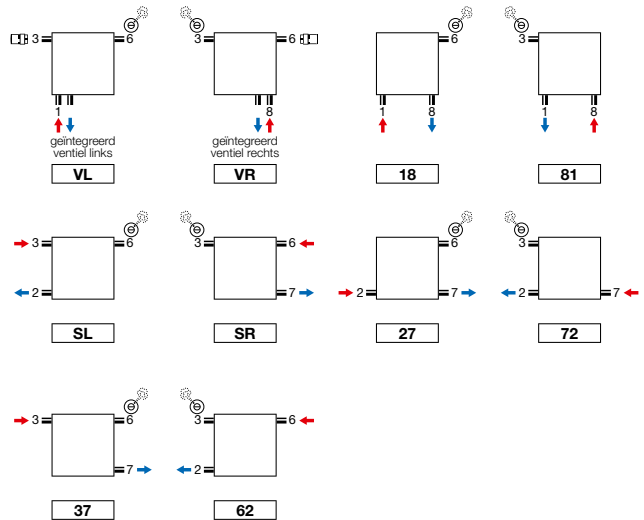

- Aansluiting VL en VR: thermostaatkop apart te bestellen
- Geïntegreerd ventiel (meerprijs) (zie p. 341)

Opmerking: het aansluiten van de radiator kan enkel volgens de getoonde aansluiticonen. Voor elke andere aansluitwijze nemen wij geen verantwoordelijkheid.

VIOLA-A VERTICAAL (V1-ZB-A, V1L1-ZB-A, V2-ZB-A)

V1-ZB-A

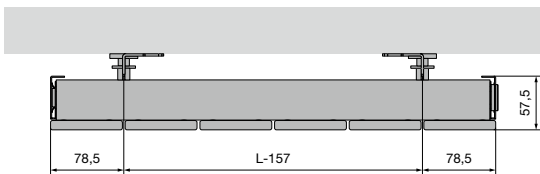

V1L1-ZB-A

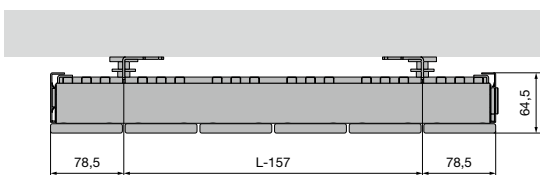

V2-ZB-A

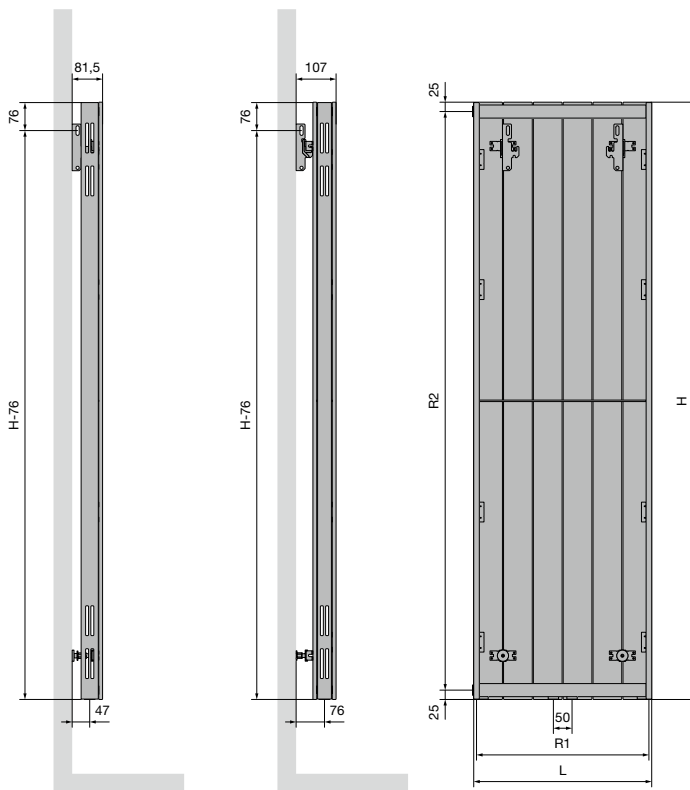
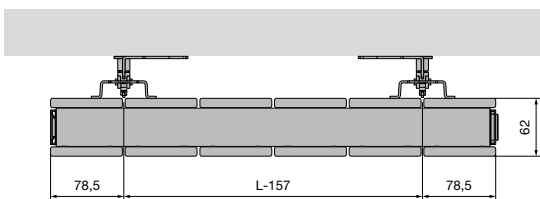

	V1-ZB-A / V1L1-ZB-A / V2-ZB-A										
aantal buizen	3	4	5	6	7	8	9	10	11	12	13
Breedte (L)	237	317	397	477	557	637	717	797	877	957	1037
Hartafstand tussen de onderaansluitingen 18 (R1)	187	267	347	427	507	587	667	747	827	907	987
hoogte (H)	1200	1400	1600	1800	2000	2200	2400				
Hartafstand tussen de zijaansluitingen SL/SR (R2)	1150	1350	1550	1750	1950	2150	2350				
Hartafstand tussen de ophangingen	L-157	H-76									

VIOLA-A HORIZONTAAL (H1-RO-A, H1L1-RO-A, H2-RO-A, H2L1-RO-A, H2L2-RO-A)

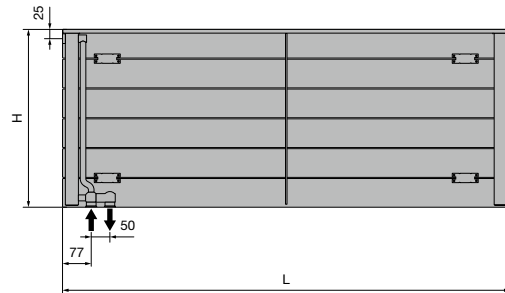
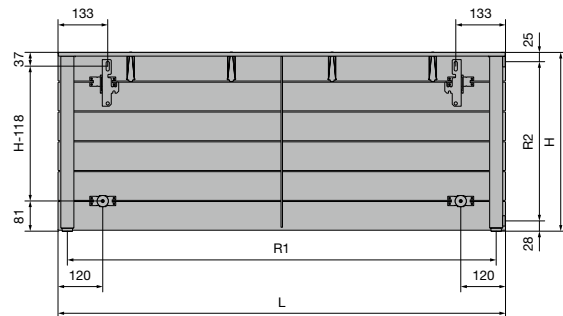
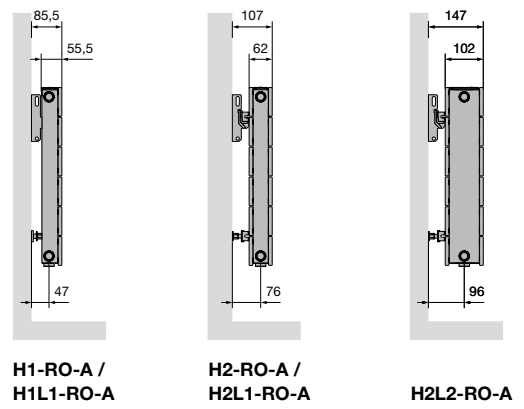
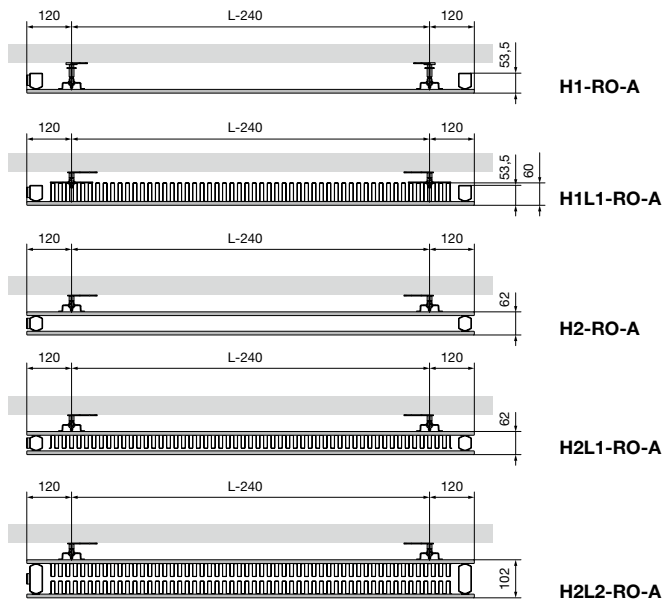

	H1-RO-A / H1L1-RO-A / H2-RO-A / H2L1-RO-A / H2L2-RO-A																
Breedte (L)	500	600	700	800	900	1000	1100	1200	1400	1600	1800	2000	2200	2400	2600	2800	3000
Hartafstand tussen de onderaansluitingen R1	450	550	650	750	850	950	1050	1150	1350	1550	1750	1950	2150	2350	2550	2750	2950
hoogte (H)	240	320	400	480	560	640	720	800	880								
Hartafstand tussen de zijaansluitingen SL/SR (R2)	187	267	347	427	507	587	667	747	827								
Hartafstand tussen de ophangingen	L-240	H-118															

TULIPA-A VERTICAAL (TV1-A, TV2-A)



TULIPA-A VERTICAAL

Warmte in alle openheid

Een designradiator van de eerste generatie. Geschikt voor alle ruimten en toepassingen. Gekenmerkt door de klassieke open structuur en de loodrechte aansluiting van de buizen op de collector. De waarborg voor een smetteloos verwarmingscomfort waar dan ook in huis.

TYPES

- Eén (TV1-A) of twee rijen buizen (TV2-A)

BUIZEN

- Verticaal, platvaal 60 x 10 mm

COLLECTOREN

- Horizontaal, achterliggend, rond Ø 32 mm

KLEUREN

- Standaardkleur wit RAL 9016
- Uitgebreide kleurenkaart zie p. 12

SPECIAAL

- Tulipa-A 6 en 8 buizen: aansluiting 1mm8, 18, 81 niet mogelijk

BEVESTIGINGEN

- Muurbevestigingen standaard (inbegrepen in de verpakking van de radiator)
- **TV1-A / TV2-A:** ook verkrijgbaar als vrijstaande opstelling, zie p. 244. Extra muurbevestigingssteun nodig voor hoogte radiator > 600 mm

TECHNISCH

- Weerstandsgelast (onzichtbare lasnaden)
- ATL-grondlaag, poedercoating
- Standaardwerkdruk: 6 bar. Meerprijs hogere werkdruk (10 bar): +10%.
- De leveringstermijn van radiator met een hogere werkdruk is 1 week extra.
- Maximale bedrijfstemperatuur: 110°C

ELEKTRISCH

- ✗ Zuiver elektrische radiator in de fabriek voorgevuld
- ✗ Gemengde radiator

TECHNISCHE TEKENINGEN

- Zie p. 247

AANSLUITING

- ✗ Eénpuntsaansluiting voor éénpijpssysteem
- ✗ Eénpuntsaansluiting voor tweepijpssysteem
- ✓ Tweepuntsaansluiting voor éénpijpssysteem (aansluiting via de middenaansluiting) (zie p. 340)
- ✓ Tweepuntsaansluiting voor tweepijpssysteem (standaard) (zie p. 340)
- ✗ Geïntegreerd ventiel
- Aansluitingen: ½" (binnendraad)

AANBEVOLEN AANSLUITING (LM)

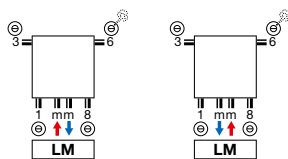

art. nr. 1182 001 0000 9016
prijs €138
Koppelingen, zie p. 353



art. nr. 11911630102
prijs €50

AANBEVOLEN VOOR BADKAMER EN KEUKEN IN OPTIE



handdoekbeugel (RAL 9005)
art. nr. zie p. 245
prijs €145
Andere accessoires, zie p. 245

Andere aansluitmogelijkheden, zie p. 246



TV1-A / TV2-A

HOE TULIPA-A VERTICAAL BESTELLEN

Leveringstermijn 15 - 30 werkdagen
(zonder transportduur)

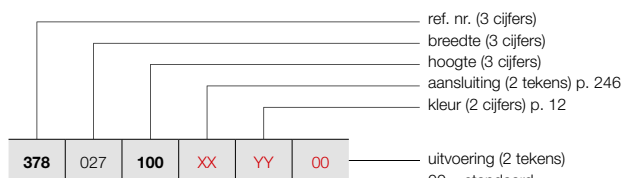

VRIJSTAANDE OPSTELLING (TV1-A)

Zie p. 244 voor extra toebehoren.

HOE VOORRAADRADIATOR TULIPA-A VERTICAAL BESTELLEN

Leveringstermijn 5 werkdagen
(zonder transportduur)

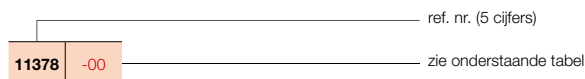

TULIPA-A VERTICAAL (TV1-A)



TV1-A

PRIJSGROEP: VPG2 - STAAL DESIGNRADIATOREN

BESTELCODE MAATWERK TULIPA-A VERTICAAL	TECHNISCHE GEGEVENS								STANDAARDKLEUR		ANDERE KLEUREN	
	buizen	breedte (L mm)	hoogte (H mm)	75/65/20 (Watt) (Φ50K)	55/45/20 (Watt) (Φ30K)	n-exp.	gewicht (kg)	inhoud (l)	el. weerst. (Watt)	prijs RAL 9016 (€)		verkorte ref. nr. RAL 9016 voorraad
REF. NR. TULIPA-A VERTICAAL TV1-A : 378												
378 027 100 XX YY 00	6	270	1000	384	204	1,24	9,60	2,64	-	278	-	320
	6	270	1200	456	240	1,24	11,40	3,12	-	305	-	351
	6	270	1500	564	294	1,25	14,40	3,84	-	345	-	397
	6	270	1600	600	312	1,26	15,00	4,08	-	361	-	415
	6	270	1800	660	342	1,26	16,80	4,56	-	382	-	439
	6	270	2000	738	384	1,27	18,60	4,98	-	414	-	476
	6	270	2200	810	420	1,27	20,40	5,46	-	441	-	507
	6	270	2500	912	474	1,28	23,40	6,18	-	481	-	553
	6	270	3000	1092	558	1,29	27,60	7,32	-	551	-	634
378 036 100 XX YY 00	8	360	1000	512	272	1,24	12,80	3,52	-	342	-	393
	8	360	1200	608	320	1,24	15,20	4,16	-	378	-	435
	8	360	1500	752	392	1,25	19,20	5,12	-	435	-	500
	8	360	1600	800	416	1,26	20,00	5,44	-	453	-	521
	8	360	1800	880	456	1,26	22,40	6,08	-	485	-	558
	8	360	2000	984	512	1,27	24,80	6,64	-	524	-	603
	8	360	2200	1080	560	1,27	27,20	7,28	-	558	-	642
	8	360	2500	1216	632	1,28	31,20	8,24	-	613	-	705
	8	360	3000	1456	744	1,29	36,80	9,76	-	702	-	807
378 045 100 XX YY 00	10	450	1000	640	340	1,24	16,00	4,40	-	406	-	467
	10	450	1200	760	400	1,24	19,00	5,20	-	454	-	522
	10	450	1500	940	490	1,25	24,00	6,40	-	518	-	596
	10	450	1600	1000	520	1,26	25,00	6,80	-	540	-	621
	10	450	1800	1100	570	1,26	28,00	7,60	-	589	-	677
	10	450	2000	1230	640	1,27	31,00	8,30	-	631	-	726
	10	450	2200	1350	700	1,27	34,00	9,10	-	679	-	781
	10	450	2500	1520	790	1,28	39,00	10,30	-	748	-	860
	10	450	3000	1820	930	1,29	46,00	12,20	-	858	-	987
378 054 100 XX YY 00	12	540	1000	768	408	1,24	19,20	5,28	-	473	-	544
	12	540	1200	912	480	1,24	22,80	6,24	-	527	-	606
	12	540	1500	1128	588	1,25	28,80	7,68	-	608	-	699
	12	540	1600	1200	624	1,26	30,00	8,16	-	635	-	730
	12	540	1800	1320	684	1,26	33,60	9,12	-	690	11378-01	794
	12	540	2000	1476	768	1,27	37,20	9,96	-	743	11378-02	854
	12	540	2200	1620	840	1,27	40,80	10,92	-	799	-	919
	12	540	2500	1824	948	1,28	46,80	12,36	-	879	-	1011
	12	540	3000	2184	1116	1,29	55,20	14,64	-	1016	-	1168

Conform EN442-1: 2014: radiatoren en convectoren

Voor meer details over onze artikel-data, zie artikel-database: <https://www.2ba.nl>
Voor de warmteafgiftes van andere regimes, kijkt u op p. 346 (correctiefactoren)
NEDERLAND. Prijzen in euro (excl. BTW)

TULIPA-A VERTICAAL (TV1-A)



TV1-A

HOE TULIPA-A VERTICAAL BESTELLEN

Leveringstermijn 15 - 30 werkdagen
(zonder transportduur)

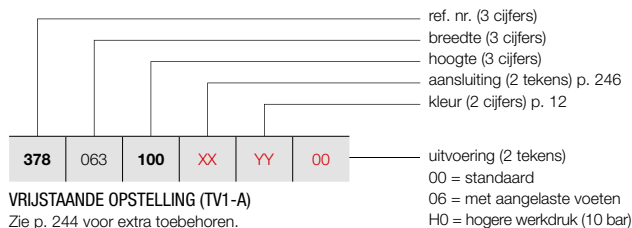

VRIJSTAANDE OPSTELLING (TV1-A)

Zie p. 244 voor extra toebehoren.

PRIJSGROEP: VPG2 - STAAL DESIGNRADIATOREN

BESTELCODE MAATWERK TULIPA-A VERTICAAL							TECHNISCHE GEGEVENS					STANDAARDKLEUR	ANDERE KLEUREN			
378	063	100	XX	YY	00	buizen	breedte (L mm)	hoogte (H mm)	75/65/20 (Watt) (Φ50K)	55/45/20 (Watt) (Φ30K)	n-exp.	gewicht (kg)	inhoud (l)	el. weerst. (Watt)	prijs RAL 9016 (€)	prijs kleur (€)
REF. NR. TULIPA-A VERTICAAL TV1-A : 378																
378	063	100	XX	YY	00	14	630	1000	896	476	1,24	22,40	6,16	-	537	618
		120				14	630	1200	1064	560	1,24	26,60	7,28	-	603	693
		150				14	630	1500	1316	686	1,25	33,60	8,96	-	697	802
		160				14	630	1600	1400	728	1,26	35,00	9,52	-	728	837
		180				14	630	1800	1540	798	1,26	39,20	10,64	-	791	910
		200				14	630	2000	1722	896	1,27	43,40	11,62	-	853	981
		220				14	630	2200	1890	980	1,27	47,60	12,74	-	918	1056
		250				14	630	2500	2128	1106	1,28	54,60	14,42	-	1015	1167
		300				14	630	3000	2548	1302	1,29	64,40	17,08	-	1171	1347
378	072	100	XX	YY	00	16	720	1000	1024	544	1,24	25,60	7,04	-	604	695
		120				16	720	1200	1216	640	1,24	30,40	8,32	-	674	775
		150				16	720	1500	1504	784	1,25	38,40	10,24	-	784	902
		160				16	720	1600	1600	832	1,26	40,00	10,88	-	821	944
		180				16	720	1800	1760	912	1,26	44,80	12,16	-	892	1026
		200				16	720	2000	1968	1024	1,27	49,60	13,28	-	964	1109
		220				16	720	2200	2160	1120	1,27	54,40	14,56	-	1038	1194
		250				16	720	2500	2432	1264	1,28	62,40	16,48	-	1144	1316
		300				16	720	3000	2912	1488	1,29	73,60	19,52	-	1327	1526
378	081	100	XX	YY	00	18	810	1000	1152	612	1,24	28,80	7,92	-	669	769
		120				18	810	1200	1368	720	1,24	34,20	9,36	-	750	863
		150				18	810	1500	1692	882	1,25	43,20	11,52	-	873	1004
		160				18	810	1600	1800	936	1,26	45,00	12,24	-	913	1050
		180				18	810	1800	1980	1026	1,26	50,40	13,68	-	995	1144
		200				18	810	2000	2214	1152	1,27	55,80	14,94	-	1074	1235
		220				18	810	2200	2430	1260	1,27	61,20	16,38	-	1159	1333
		250				18	810	2500	2736	1422	1,28	70,20	18,54	-	1281	1473
		300				18	810	3000	3276	1674	1,29	82,80	21,96	-	1483	1705
378	090	100	XX	YY	00	20	900	1000	1280	680	1,24	32,00	8,80	-	735	845
		120				20	900	1200	1520	800	1,24	38,00	10,40	-	823	946
		150				20	900	1500	1880	980	1,25	48,00	12,80	-	959	1103
		160				20	900	1600	2000	1040	1,26	50,00	13,60	-	1003	1153
		180				20	900	1800	2200	1140	1,26	56,00	15,20	-	1095	1259
		200				20	900	2000	2460	1280	1,27	62,00	16,60	-	1185	1363
		220				20	900	2200	2700	1400	1,27	68,00	18,20	-	1278	1470
		250				20	900	2500	3040	1580	1,28	78,00	20,60	-	1412	1624
		300				20	900	3000	3640	1860	1,29	92,00	24,40	-	1637	1883

Conform EN442-1: 2014: radiatoren en convectoren

Voor meer details over onze artikel-data, zie artikel-database: <https://www.2ba.nl>

Voor de warmteafgifte van andere regimes, kijkt u op p. 346 (correctiefactoren)
NEDERLAND. Prijzen in euro (excl. BTW)

HOE TULIPA-A VERTICAAL BESTELLEN

Leveringstermijn 15 - 30 werkdagen
(zonder transportduur)

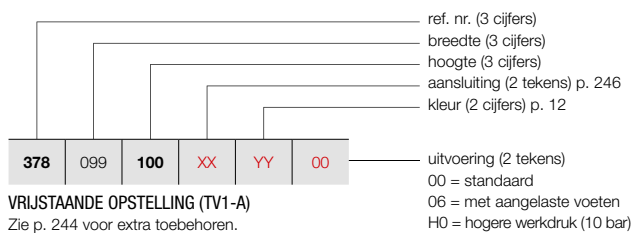

VRIJSTAANDE OPSTELLING (TV1-A)

Zie p. 244 voor extra toebehoren.

TULIPA-A VERTICAAL (TV1-A)



TV1-A

PRIJSGROEP: VPG2 - STAAL DESIGNRADIATOREN

BESTELCODE MAATWERK TULIPA-A VERTICAAL	TECHNISCHE GEGEVENS							STANDAARDKLEUR	ANDERE KLEUREN		
	buizen	breedte (L mm)	hoogte (H mm)	75/65/20 (Watt) (Φ50K)	55/45/20 (Watt) (Φ30K)	n-exp.	gewicht (kg)			inhoud (l)	el. weerst. (Watt)
REF. NR. TULIPA-A VERTICAAL TV1-A : 378											
378	099	100	XX	YY	00						
		120								799	919
		150								899	1034
		160								1047	1204
		180								1096	1260
		200								1198	1378
		220								1296	1490
		250								1398	1608
										1546	1778
378	108	100	XX	YY	00						
		120								860	989
		150								972	1118
		160								1135	1305
		180								1188	1366
		200								1297	1492
		220								1407	1618
										1514	1741
378	117	100	XX	YY	00						
		120								929	1068
		150								1047	1204
		160								1223	1406
		180								1281	1473
		200								1401	1611
										1515	1742
378	126	100	XX	YY	00						
		120								994	1143
		150								1121	1289
		160								1310	1507
		180								1373	1579
										1503	1728

Conform EN442-1: 2014: radiatoren en convectoren

Voor meer details over onze artikel-data, zie artikel-database: <https://www.2ba.nl>

Voor de warmteafgiftes van andere regimes, kijkt u op p. 346 (correctiefactoren)
NEDERLAND. Prijzen in euro (excl. BTW)

TULIPA-A VERTICAAL (TV2-A)



TV2-A

HOE TULIPA-A VERTICAAL BESTELLEN

Leveringstermijn 15 - 30 werkdagen
(zonder transportduur)

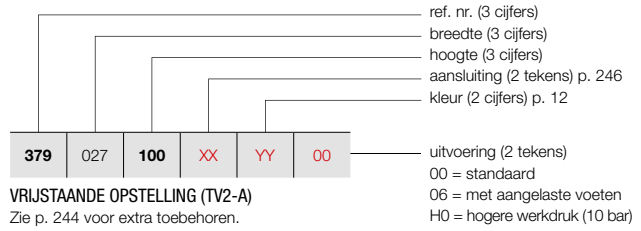

VRIJSTAANDE OPSTELLING (TV2-A)

Zie p. 244 voor extra toebehoren.

HOE VOORRAADRADIATOR VIOLA-A VERTICAAL BESTELLEN

Leveringstermijn 5 werkdagen
(zonder transportduur)

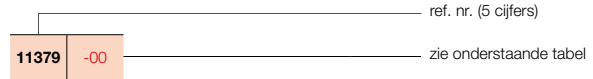

PRIJSGROEP: VPG2 - STAAL DESIGNRADIATOREN

BESTELCODE MAATWERK TULIPA-A VERTICAAL	TECHNISCHE GEGEVENS									STANDAARDKLEUR		ANDERE KLEUREN					
	buizen	breedte (L mm)	hoogte (H mm)	75/65/20 (Watt) (Φ50K)	55/45/20 (Watt) (Φ30K)	n-exp.	gewicht (kg)	inhoud (l)	el. weerst. (Watt)	prijs RAL 9016 (€)	verkorte ref. nr. RAL 9016 voorraad		prijs kleur (€)				
REF. NR. TULIPA-A VERTICAAL TV2-A : 379																	
379	027	100	XX	YY	00	6	270	1000	636	330	1,26	18,60	4,98	-	481	-	553
		120				6	270	1200	750	390	1,26	22,20	5,94	-	531	-	611
		150				6	270	1500	924	480	1,27	27,60	7,32	-	603	-	693
		160				6	270	1600	984	504	1,28	29,40	7,80	-	625	-	719
		180				6	270	1800	1134	582	1,28	33,00	8,70	-	673	-	774
		200				6	270	2000	1212	624	1,29	36,60	9,66	-	725	-	834
		220				6	270	2200	1326	684	1,29	40,20	10,56	-	770	-	886
		250				6	270	2500	1500	768	1,30	45,60	12,00	-	841	-	967
		300				6	270	3000	1788	906	1,31	54,60	14,34	-	961	-	1105
379	036	100	XX	YY	00	8	360	1000	848	440	1,26	24,80	6,64	-	602	-	692
		120				8	360	1200	1000	520	1,26	29,60	7,92	-	663	-	762
		150				8	360	1500	1232	640	1,27	36,80	9,76	-	759	-	873
		160				8	360	1600	1312	672	1,28	39,20	10,40	-	791	-	910
		180				8	360	1800	1512	776	1,28	44,00	11,60	-	853	-	981
		200				8	360	2000	1616	832	1,29	48,80	12,88	-	916	-	1053
		220				8	360	2200	1768	912	1,29	53,60	14,08	-	980	-	1127
		250				8	360	2500	2000	1024	1,30	60,80	16,00	-	1074	-	1235
		300				8	360	3000	2384	1208	1,31	72,80	19,12	-	1229	-	1413
379	045	100	XX	YY	00	10	450	1000	1060	550	1,26	31,00	8,30	-	714	-	821
		120				10	450	1200	1250	650	1,26	37,00	9,90	-	794	-	913
		150				10	450	1500	1540	800	1,27	46,00	12,20	-	911	-	1048
		160				10	450	1600	1640	840	1,28	49,00	13,00	-	950	-	1093
		180				10	450	1800	1890	970	1,28	55,00	14,50	-	1031	-	1186
		200				10	450	2000	2020	1040	1,29	61,00	16,10	-	1106	-	1272
		220				10	450	2200	2210	1140	1,29	67,00	17,60	-	1188	-	1366
		250				10	450	2500	2500	1280	1,30	76,00	20,00	-	1309	-	1505
		300				10	450	3000	2980	1510	1,31	91,00	23,90	-	1508	-	1734
379	054	100	XX	YY	00	12	540	1000	1272	660	1,26	37,20	9,96	-	824	-	948
		120				12	540	1200	1500	780	1,26	44,40	11,88	-	923	-	1061
		150				12	540	1500	1848	960	1,27	55,20	14,64	-	1066	-	1226
		160				12	540	1600	1968	1008	1,28	58,80	15,60	-	1115	-	1282
		180				12	540	1800	2268	1164	1,28	66,00	17,40	-	1209	-	1390
		200				12	540	2000	2424	1248	1,29	73,20	19,32	-	1300	11379-01	1495
		220				12	540	2200	2652	1368	1,29	80,40	21,12	-	1400	-	1610
		250				12	540	2500	3000	1536	1,30	91,20	24,00	-	1539	-	1770
		300				12	540	3000	3576	1812	1,31	109,20	28,68	-	1779	-	2046

Conform EN442-1: 2014: radiatoren en convectoren

Voor meer details over onze artikel-data, zie artikel-database: <https://www.2ba.nl>

Voor de warmteafgiftes van andere regimes, kijkt u op p. 346 (correctiefactoren)
NEDERLAND. Prijzen in euro (excl. BTW)

HOE TULIPA-A VERTICAAL BESTELLEN

Leveringstermijn 15 - 30 werkdagen
(zonder transportduur)

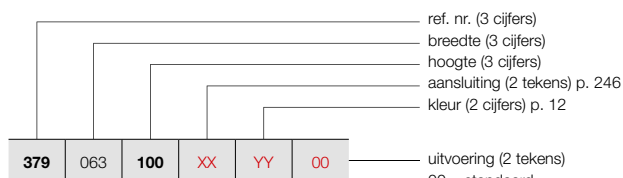

VRIJSTAANDE OPSTELLING (TV2-A)

Zie p. 244 voor extra toebehoren.

HOE VOORRAADRADIATOR VIOLA-A VERTICAAL BESTELLEN

Leveringstermijn 5 werkdagen
(zonder transportduur)

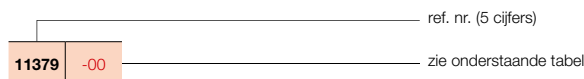

TULIPA-A VERTICAAL (TV2-A)



TV2-A

PRIJSGROEP: VPG2 - STAAL DESIGNRADIATOREN

BESTELCODE MAATWERK TULIPA-A VERTICAAL	TECHNISCHE GEGEVENS							STANDAARDKLEUR		ANDERE KLEUREN							
	buizen	breedte (L mm)	hoogte (H mm)	75/65/20 (Watt) (Φ50K)	55/45/20 (Watt) (Φ30K)	n-exp.	gewicht (kg)	inhoud (l)	el. weerst. (Watt)		prijs RAL 9016 (€)	verkorte ref. nr. RAL 9016 voorraad	prijs kleur (€)				
REF. NR. TULIPA-A VERTICAAL TV2-A : 379																	
379	063	100	XX	YY	00	14	630	1000	1484	770	1,26	43,40	11,62	-	942	-	1083
		120				14	630	1200	1750	910	1,26	51,80	13,86	-	1053	-	1211
		150				14	630	1500	2156	1120	1,27	64,40	17,08	-	1220	-	1403
		160				14	630	1600	2296	1176	1,28	68,60	18,20	-	1275	-	1466
		180				14	630	1800	2646	1358	1,28	77,00	20,30	-	1382	-	1589
		200				14	630	2000	2828	1456	1,29	85,40	22,54	-	1495	11379-02	1719
		220				14	630	2200	3094	1596	1,29	93,80	24,64	-	1609	-	1850
		250				14	630	2500	3500	1792	1,30	106,40	28,00	-	1775	-	2041
		300				14	630	3000	4172	2114	1,31	127,40	33,46	-	2050	-	2358
		379				072	100	XX	YY	00	16	720	1000	1696	880	1,26	49,60
120	16		720	1200	2000		1040				1,26	59,20	15,84	-	1180	-	1357
150	16		720	1500	2464		1280				1,27	73,60	19,52	-	1372	-	1578
160	16		720	1600	2624		1344				1,28	78,40	20,80	-	1434	-	1649
180	16		720	1800	3024		1552				1,28	88,00	23,20	-	1562	-	1796
200	16		720	2000	3232		1664				1,29	97,60	25,76	-	1687	-	1940
220	16		720	2200	3536		1824				1,29	107,20	28,16	-	1815	-	2087
250	16		720	2500	4000		2048				1,30	121,60	32,00	-	2005	-	2306
300	16		720	3000	4768		2416				1,31	145,60	38,24	-	2321	-	2669
379	081		100	XX	YY		00				18	810	1000	1908	990	1,26	55,80
		120	18			810		1200	2250	1170	1,26	66,60	17,82	-	1311	-	1508
		150	18			810		1500	2772	1440	1,27	82,80	21,96	-	1525	-	1754
		160	18			810		1600	2952	1512	1,28	88,20	23,40	-	1596	-	1835
		180	18			810		1800	3402	1746	1,28	99,00	26,10	-	1740	-	2001
		200	18			810		2000	3636	1872	1,29	109,80	28,98	-	1884	-	2167
		220	18			810		2200	3978	2052	1,29	120,60	31,68	-	2023	-	2326
		250	18			810		2500	4500	2304	1,30	136,80	36,00	-	2240	-	2576
		300	18			810		3000	5364	2718	1,31	163,80	43,02	-	2596	-	2985
		379	090			100		XX	YY	00	20	900	1000	2120	1100	1,26	62,00
120	20			900	1200	2500	1300				1,26	74,00	19,80	-	1443	-	1659
150	20			900	1500	3080	1600				1,27	92,00	24,40	-	1676	-	1927
160	20			900	1600	3280	1680				1,28	98,00	26,00	-	1755	-	2018
180	20			900	1800	3780	1940				1,28	110,00	29,00	-	1918	-	2206
200	20			900	2000	4040	2080				1,29	122,00	32,20	-	2073	-	2384
220	20			900	2200	4420	2280				1,29	134,00	35,20	-	2233	-	2568
250	20			900	2500	5000	2560				1,30	152,00	40,00	-	2470	-	2841
300	20			900	3000	5960	3020				1,31	182,00	47,80	-	2868	-	3298

Conform EN442-1: 2014: radiatoren en convectoren

Voor meer details over onze artikel-data, zie artikel-database: <https://www.2ba.nl>
Voor de warmteafgiftes van andere regimes, kijkt u op p. 346 (correctiefactoren)
NEDERLAND. Prijzen in euro (excl. BTW)

TULIPA-A VERTICAAL (TV2-A)



TV2-A

HOE TULIPA-A VERTICAAL BESTELLEN

Leveringstermijn 15 - 30 werkdagen
(zonder transportduur)

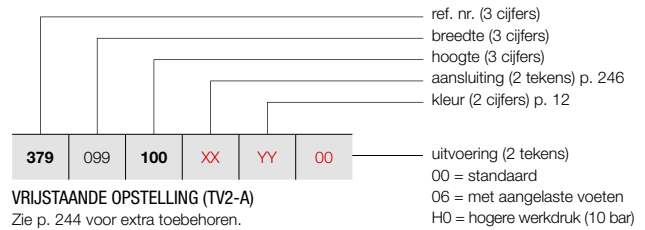

VRIJSTAANDE OPSTELLING (TV2-A)

Zie p. 244 voor extra toebehoren.

PRIJSGROEP: VPG2 - STAAL DESIGNRADIATOREN

BESTELCODE MAATWERK TULIPA-A VERTICAAL							TECHNISCHE GEGEVENS					STANDAARDKLEUR	ANDERE KLEUREN				
379	099	100	XX	YY	00	buizen	breedte (L mm)	hoogte (H mm)	75/65/20 (Watt Ø50K)	55/45/20 (Watt Ø30K)	n-exp.	gewicht (kg)	inhoud (l)	el. weerst. (Watt)	prijs RAL 9016 (€)	prijs kleur (€)	
REF. NR. TULIPA-A VERTICAAL TV2-A : 379																	
379	099	100	XX	YY	00	22	990	1000	2332	1210	1,26	68,20	18,26	-	1400	1610	
		120				22	990	1200	2750	1430	1,26	81,40	21,78	-	1572	1808	
		150				22	990	1500	3388	1760	1,27	101,20	26,84	-	1832	2107	
		160				22	990	1600	3608	1848	1,28	107,80	28,60	-	1919	2207	
		180				22	990	1800	4158	2134	1,28	121,00	31,90	-	2095	2409	
		200				22	990	2000	4444	2288	1,29	134,20	35,42	-	2268	2608	
		220				22	990	2200	4862	2508	1,29	147,40	38,72	-	2442	2808	
		250				22	990	2500	5500	2816	1,30	167,20	44,00	-	2706	3112	
379	108	100	XX	YY	00	24	1080	1000	2544	1320	1,26	74,40	19,92	-	1511	1738	
		120				24	1080	1200	3000	1560	1,26	88,80	23,76	-	1701	1956	
		150				24	1080	1500	3696	1920	1,27	110,40	29,28	-	1966	2284	
		160				24	1080	1600	3936	2016	1,28	117,60	31,20	-	2081	2393	
		180				24	1080	1800	4536	2328	1,28	132,00	34,80	-	2270	2611	
		200				24	1080	2000	4848	2496	1,29	146,40	38,64	-	2461	2830	
		220				24	1080	2200	5304	2736	1,29	160,80	42,24	-	2652	3050	
379	117	100	XX	YY	00	26	1170	1000	2756	1430	1,26	80,60	21,58	-	1623	1866	
		120				26	1170	1200	3250	1690	1,26	96,20	25,74	-	1832	2107	
		150				26	1170	1500	4004	2080	1,27	119,60	31,72	-	2140	2461	
		160				26	1170	1600	4264	2184	1,28	127,40	33,80	-	2243	2579	
		180				26	1170	1800	4914	2522	1,28	143,00	37,70	-	2451	2819	
		200				26	1170	2000	5252	2704	1,29	158,60	41,86	-	2655	3053	
379	126	100	XX	YY	00	28	1260	1000	2968	1540	1,26	86,80	23,24	-	1738	1999	
		120				28	1260	1200	3500	1820	1,26	103,60	27,72	-	1962	2256	
		150				28	1260	1500	4312	2240	1,27	128,80	34,16	-	2292	2636	
		160				28	1260	1600	4592	2352	1,28	137,20	36,40	-	2402	2762	
		180				28	1260	1800	5292	2716	1,28	154,00	40,60	-	2627	3021	

Conform EN442-1: 2014: radiatoren en convectoren

Voor meer details over onze artikel-data, zie artikel-database: <https://www.2ba.nl>
Voor de warmteafgiftes van andere regimes, kijkt u op p. 346 (correctiefactoren)
NEDERLAND. Prijzen in euro (excl. BTW)

TYPES

- Eén (TH1-A) of twee rijen buizen (TH2-A)

BUIZEN

- Verticaal, platovaal 60 x 10 mm

COLLECTOREN

- Horizontaal, achterliggend, rond Ø 32 mm

KLEUREN

- Standaardkleur wit RAL 9016
- Uitgebreide kleurenkaart zie p. 12

SPECIAAL

- TH1-A ook verkrijgbaar als toiletradiator (540 x 500 mm)

BEVESTIGINGEN

- Muurbevestigingen standaard (inbegrepen in de verpakking van de radiator)
- **TH1-A / TH2-A:** ook verkrijgbaar als vrijstaande opstelling, zie p. 244. Extra muurbevestigingssteun nodig voor hoogte radiator > 600 mm.

TECHNISCH

- Weerstandsgelast (onzichtbare lasnaden)
- ATL-grondlaag, poedercoating
- Standaardwerkdruk: 6 bar. Meerprijs hogere werkdruk (10 bar): +10%.
- De leveringstermijn van radiator met een hogere werkdruk is 1 week extra.
- Maximale bedrijfstemperatuur: 110°C

ELEKTRISCH

- ✗ Zuiver elektrische radiator in de fabriek voorgevuld
- ✗ Gemengde radiator

TECHNISCHE TEKENINGEN

- Zie p. 247

AANSLUITING

- ✗ Eénpuntsaansluiting voor éénpijpssysteem
 - ✗ Eénpuntsaansluiting voor tweepijpssysteem
 - ✓ Tweepuntsaansluiting voor éénpijpssysteem (aansluiting via de middenaansluiting) (zie p. 340)
 - ✓ Tweepuntsaansluiting voor tweepijpssysteem (standaard) (zie p. 340)
 - ✗ Geïntegreerd ventiel
- Aansluitingen: ½" (binnendraad)



TULIPA-A HORIZONTAAL

Eeuwige charme, tijdloze klasse

De horizontale versie van de Tulipa-A. Het schoolvoorbeeld van een designradiator in zijn meest authentieke vorm. Gekenmerkt door de klassieke open structuur en de loodrechte aansluiting van de buizen op de collector. Een designradiator die blijft charmeren. Trendoverstijgend en overall toepasbaar.

AANBEVOLEN AANSLUITING (18)

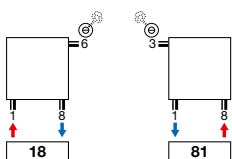

Andere aansluitmogelijkheden, zie p. 246



art. nr. 1182 101 0000 0099
prijs €215
 Koppelingen, zie p. 353

AANBEVOLEN VOOR BADKAMER EN KEUKEN IN OPTIE



handdoekbeugel (RAL 9005)
 art. nr. zie p. 245
prijs €145
 Andere accessoires, zie p. 245



TH1-A / TH2-A

TULIPA-A HORIZONTAAL (TH1-A)

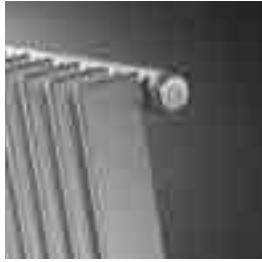

TH1-A

HOE TULIPA-A HORIZONTAAL BESTELLEN

Leveringstermijn 15 - 30 werkdagen
(zonder transportduur)

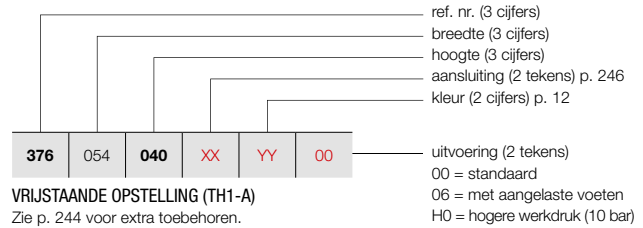

VRIJSTAANDE OPSTELLING (TH1-A)
Zie p. 244 voor extra toebehoren.

PRIJSGROEP: VPG2 - STAAL DESIGNRADIATOREN

BESTELCODE MAATWERK TULIPA-A HORIZONTAAL	TECHNISCHE GEGEVENS									STANDAARDKLEUR	ANDERE KLEUREN
	buizen	breedte (L mm)	hoogte (H mm)	75/65/20 (Watt) (Φ50K)	55/45/20 (Watt) (Φ30K)	n-exp.	gewicht (kg)	inhoud (l)	el. weerst. (Watt)	prijs RAL 9016 (€)	prijs kleur (€)
REF. NR. TULIPA-A HORIZONTAAL TH1-A : 376											
376 054 040 XX YY 00	12	540	400	348	180	1,22	9,60	2,52	-	310	357
050	12	540	500	420	216	1,23	10,80	3,00	-	335	385
060	12	540	600	492	264	1,23	12,00	3,48	-	364	419
070	12	540	700	564	300	1,23	14,40	3,96	-	392	451
080	12	540	800	636	336	1,23	15,60	4,44	-	419	482
090	12	540	900	696	372	1,24	18,00	4,92	-	444	511
376 063 040 XX YY 00	14	630	400	406	210	1,22	11,20	2,94	-	348	400
050	14	630	500	490	252	1,23	12,60	3,50	-	378	435
060	14	630	600	574	308	1,23	15,40	4,06	-	408	469
070	14	630	700	658	350	1,23	16,80	4,62	-	442	508
080	14	630	800	742	392	1,23	18,20	5,18	-	474	545
090	14	630	900	812	434	1,24	21,00	5,74	-	509	585
376 072 040 XX YY 00	16	720	400	464	240	1,22	12,80	3,36	-	382	439
050	16	720	500	560	288	1,23	14,40	4,00	-	422	485
060	16	720	600	656	352	1,23	17,60	4,64	-	457	526
070	16	720	700	752	400	1,23	19,20	5,28	-	492	566
080	16	720	800	848	448	1,23	20,80	5,92	-	529	608
090	16	720	900	928	496	1,24	24,00	6,56	-	567	652
376 081 040 XX YY 00	18	810	400	522	270	1,22	14,40	3,78	-	426	490
050	18	810	500	630	324	1,23	16,20	4,50	-	463	532
060	18	810	600	738	396	1,23	19,80	5,22	-	509	585
070	18	810	700	846	450	1,23	21,60	5,94	-	545	627
080	18	810	800	954	504	1,23	23,40	6,66	-	585	673
090	18	810	900	1044	558	1,24	27,00	7,38	-	625	719
376 090 040 XX YY 00	20	900	400	580	300	1,22	16,00	4,20	-	461	530
050	20	900	500	700	360	1,23	18,00	5,00	-	510	587
060	20	900	600	820	440	1,23	22,00	5,80	-	554	637
070	20	900	700	940	500	1,23	24,00	6,60	-	596	685
080	20	900	800	1060	560	1,23	26,00	7,40	-	643	739
090	20	900	900	1160	620	1,24	30,00	8,20	-	689	792
376 099 040 XX YY 00	22	990	400	638	330	1,22	17,60	4,62	-	499	574
050	22	990	500	770	396	1,23	19,80	5,50	-	551	634
060	22	990	600	902	484	1,23	24,20	6,38	-	599	689
070	22	990	700	1034	550	1,23	26,40	7,26	-	649	746
080	22	990	800	1166	616	1,23	28,60	8,14	-	696	800
090	22	990	900	1276	682	1,24	33,00	9,02	-	747	859
376 108 040 XX YY 00	24	1080	400	696	360	1,22	19,20	5,04	-	536	616
050	24	1080	500	840	432	1,23	21,60	6,00	-	593	682
060	24	1080	600	984	528	1,23	26,40	6,96	-	646	743
070	24	1080	700	1128	600	1,23	28,80	7,92	-	700	805
080	24	1080	800	1272	672	1,23	31,20	8,88	-	753	866
090	24	1080	900	1392	744	1,24	36,00	9,84	-	808	929

Conform EN442-1: 2014: radiatoren en convectoren

Voor meer details over onze artikel-data, zie artikel-database: <https://www.2ba.nl>

Voor de warmteafgiftes van andere regimes, kijkt u op p. 346 (correctiefactoren)
NEDERLAND. Prijzen in euro (excl. BTW)

HOE TULIPA-A HORIZONTAAL BESTELLEN

Leveringstermijn 15 - 30 werkdagen
(zonder transportduur)



376 117 **040** **XX** **YY** **00**
uitvoering (2 tekens)
00 = standaard
06 = met aangelaste voeten
H0 = hogere werkdruk (10 bar)

VRIJSTAANDE OPSTELLING (TH1-A)
Zie p. 244 voor extra toebehoren.

TULIPA-A HORIZONTAAL (TH1-A)

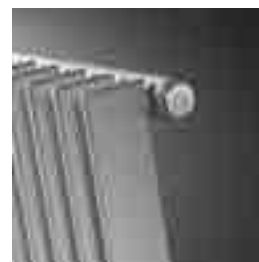

TH1-A

PRIJSGROEP: VPG2 - STAAL DESIGNRADIATOREN

BESTELCODE MAATWERK TULIPA-A HORIZONTAAL	TECHNISCHE GEGEVENS							STANDAARDKLEUR		ANDERE KLEUREN	
	buizen	breedte (L mm)	hoogte (H mm)	75/65/20 (Watt) (Φ50K)	55/45/20 (Watt) (Φ30K)	n-exp.	gewicht (kg)	inhoud (l)	el. weerst. (Watt)	prijs RAL 9016 (€)	prijs kleur (€)
REF. NR. TULIPA-A HORIZONTAAL TH1-A : 376											
376 117 040 XX YY 00	26	1170	400	754	390	1,22	20,80	5,46	-	576	662
050	26	1170	500	910	468	1,23	23,40	6,50	-	634	729
060	26	1170	600	1066	572	1,23	28,60	7,54	-	692	796
070	26	1170	700	1222	650	1,23	28,80	8,58	-	751	864
080	26	1170	800	1378	728	1,23	31,20	9,62	-	813	935
090	26	1170	900	1508	806	1,24	36,00	10,66	-	872	1003
376 126 040 XX YY 00	28	1260	400	812	420	1,22	22,40	5,88	-	612	704
050	28	1260	500	980	504	1,23	25,20	7,00	-	675	776
060	28	1260	600	1148	616	1,23	30,80	8,12	-	741	852
070	28	1260	700	1316	700	1,23	33,60	9,24	-	802	922
080	28	1260	800	1484	784	1,23	36,40	10,36	-	866	996
090	28	1260	900	1624	868	1,24	42,00	11,48	-	930	1070
376 144 040 XX YY 00	32	1440	400	928	480	1,22	25,60	6,72	-	689	792
050	32	1440	500	1120	576	1,23	28,80	8,00	-	760	874
060	32	1440	600	1312	704	1,23	35,20	9,28	-	835	960
070	32	1440	700	1504	800	1,23	38,40	10,56	-	905	1041
080	32	1440	800	1696	896	1,23	41,60	11,84	-	980	1127
090	32	1440	900	1856	992	1,24	48,00	13,12	-	1052	1210
376 162 040 XX YY 00	36	1620	400	1044	540	1,22	28,80	7,56	-	767	882
050	36	1620	500	1260	648	1,23	32,40	9,00	-	846	973
060	36	1620	600	1476	792	1,23	39,60	10,44	-	929	1068
070	36	1620	700	1692	900	1,23	43,20	11,88	-	1007	1158
080	36	1620	800	1908	1008	1,23	46,80	13,32	-	1092	1256
090	36	1620	900	2088	1116	1,24	54,00	14,76	-	1172	1348
376 180 040 XX YY 00	40	1800	400	1160	600	1,22	32,00	8,40	-	841	967
050	40	1800	500	1400	720	1,23	36,00	10,00	-	931	1071
060	40	1800	600	1640	880	1,23	44,00	11,60	-	1020	1173
070	40	1800	700	1880	1000	1,23	48,00	13,20	-	1115	1282
080	40	1800	800	2120	1120	1,23	52,00	14,80	-	1204	1385
090	40	1800	900	2320	1240	1,24	60,00	16,40	-	1295	1489
376 198 040 XX YY 00	44	1980	400	1276	660	1,22	35,20	9,24	-	916	1053
050	44	1980	500	1540	792	1,23	39,60	11,00	-	1016	1168
060	44	1980	600	1804	968	1,23	48,40	12,76	-	1118	1286
070	44	1980	700	2068	1100	1,23	52,80	14,52	-	1216	1398
080	44	1980	800	2332	1232	1,23	57,20	16,28	-	1317	1515
090	44	1980	900	2552	1364	1,24	66,00	18,04	-	1413	1625
376 216 040 XX YY 00	48	2160	400	1392	720	1,22	38,40	10,08	-	994	1143
050	48	2160	500	1680	864	1,23	43,20	12,00	-	1101	1266
060	48	2160	600	1968	1056	1,23	52,80	13,92	-	1213	1395
070	48	2160	700	2256	1200	1,23	57,60	15,84	-	1319	1517
080	48	2160	800	2544	1344	1,23	62,40	17,76	-	1428	1642
090	48	2160	900	2784	1488	1,24	72,00	19,68	-	1537	1768

Conform EN442-1: 2014: radiatoren en convectoren

Voor meer details over onze artikel-data, zie artikel-database: <https://www.2ba.nl>
Voor de warmteafgiftes van andere regimes, kijkt u op p. 346 (correctiefactoren)
NEDERLAND. Prijzen in euro (excl. BTW)

TULIPA-A HORIZONTAAL (TH1-A)



TH1-A

HOE TULIPA-A HORIZONTAAL BESTELLEN

Leveringstermijn 15 - 30 werkdagen
(zonder transportduur)

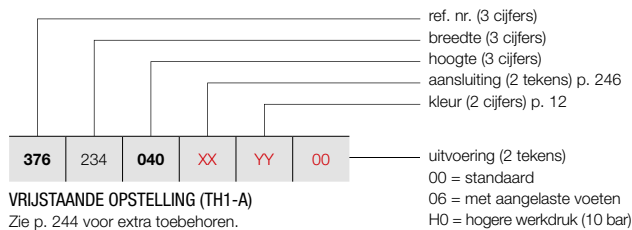

VRIJSTAANDE OPSTELLING (TH1-A)
 Zie p. 244 voor extra toebehoren.

PRIJSGROEP: VPG2 - STAAL DESIGNRADIATOREN

BESTELCODE MAATWERK TULIPA-A HORIZONTAAL	TECHNISCHE GEGEVENS									STANDAARDKLEUR	ANDERE KLEUREN
	buizen	breedte (L mm)	hoogte (H mm)	75/65/20 (Watt) (Φ50K)	55/45/20 (Watt) (Φ30K)	n-exp.	gewicht (kg)	inhoud (l)	el. weerst. (Watt)	prijs RAL 9016 (€)	prijs kleur (€)
REF. NR. TULIPA-A HORIZONTAAL TH1-A : 376											
376	234	040	XX	YY	00						
		050								1067	1227
		060								1187	1365
		070								1302	1497
		080								1425	1639
		090								1539	1770
										1658	1907
376	252	040	XX	YY	00						
		050								1144	1316
		060								1271	1462
		070								1400	1610
		080								1524	1753
		090								1652	1900
										1779	2046
376	270	040	XX	YY	00						
		050								1219	1402
		060								1358	1562
		070								1490	1714
		080								1625	1869
										1761	2025
376	288	040	XX	YY	00						
		050								1296	1490
		060								1442	1658
		070								1587	1825
										1733	1993
376	306	040	XX	YY	00						
		050								1372	1578
		060								1525	1754
		070								1679	1931
										1834	2109

Conform EN442-1: 2014: radiatoren en convectoren

Voor meer details over onze artikel-data, zie artikel-database: <https://www.2ba.nl>

Voor de warmteafgifte van andere regimes, kijkt u op p. 346 (correctiefactoren)
NEDERLAND. Prijzen in euro (excl. BTW)

HOE TULIPA-A HORIZONTAAL BESTELLEN

Leveringstermijn 15 - 30 werkdagen
(zonder transportduur)

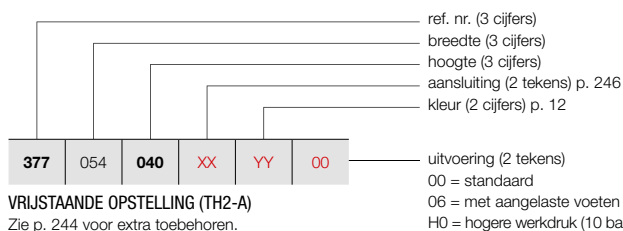

VRIJSTAANDE OPSTELLING (TH2-A)

Zie p. 244 voor extra toebehoren.

TULIPA-A HORIZONTAAL (TH2-A)



TH2-A

PRIJSGROEP: VPG2 - STAAL DESIGNRADIATOREN

BESTELCODE MAATWERK TULIPA-A HORIZONTAAL	TECHNISCHE GEGEVENS							STANDAARDKLEUR		ANDERE KLEUREN	
	buizen	breedte (L mm)	hoogte (H mm)	75/65/20 (Watt) (Φ50K)	55/45/20 (Watt) (Φ30K)	n-exp.	gewicht (kg)	inhoud (l)	el. weerst. (Watt)	prijs RAL 9016 (€)	prijs kleur (€)
REF. NR. TULIPA-A HORIZONTAAL TH2-A : 377											
377	054	040	XX	YY	00						
		050								539	620
		060								589	677
		070								635	730
		080								687	790
		090								735	845
										779	896
377	063	040	XX	YY	00						
		050								609	700
		060								663	762
		070								719	827
		080								773	889
		090								832	957
										885	1018
377	072	040	XX	YY	00						
		050								673	774
		060								739	850
		070								801	921
		080								863	992
		090								929	1068
										991	1140
377	081	040	XX	YY	00						
		050								741	852
		060								814	936
		070								885	1018
		080								956	1099
		090								1024	1178
										1096	1260
377	090	040	XX	YY	00						
		050								806	927
		060								888	1021
		070								968	1113
		080								1045	1202
		090								1125	1294
										1206	1387
377	099	040	XX	YY	00						
		050								875	1006
		060								961	1105
		070								1047	1204
		080								1136	1306
		090								1220	1403
										1310	1507
377	108	040	XX	YY	00						
		050								940	1081
		060								1037	1193
		070								1131	1301
		080								1225	1409
		090								1322	1520
										1413	1625

Conform EN442-1: 2014: radiatoren en convectoren

Voor meer details over onze artikel-data, zie artikel-database: <https://www.2ba.nl>

Voor de warmteafgiftes van andere regimes, kijkt u op p. 346 (correctiefactoren)
NEDERLAND. Prijzen in euro (excl. BTW)

TULIPA-A HORIZONTAAL (TH2-A)

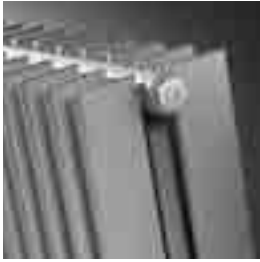

TH2-A

HOE TULIPA-A HORIZONTAAL BESTELLEN

Leveringstermijn 15 - 30 werkdagen
(zonder transportduur)

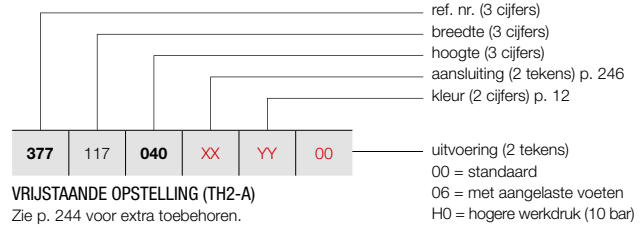

VRIJSTAANDE OPSTELLING (TH2-A)
Zie p. 244 voor extra toebehoren.

PRIJSGROEP: VPG2 - STAAL DESIGNRADIATOREN

BESTELCODE MAATWERK TULIPA-A HORIZONTAAL	TECHNISCHE GEGEVENS									STANDAARDKLEUR	ANDERE KLEUREN
	buizen	breedte (L mm)	hoogte (H mm)	75/65/20 (Watt) (Φ50K)	55/45/20 (Watt) (Φ30K)	n-exp.	gewicht (kg)	inhoud (l)	el. weerst. (Watt)	prijs RAL 9016 (€)	prijs kleur (€)
REF. NR. TULIPA-A HORIZONTAAL TH2-A : 377											
377 117 040 XX YY 00	26	1170	400	1274	676	1,24	36,40	9,36	-	1004	1155
050	26	1170	500	1404	806	1,25	44,20	11,44	-	1111	1278
060	26	1170	600	1768	936	1,25	52,00	13,52	-	1214	1396
070	26	1170	700	2028	1066	1,25	57,20	15,60	-	1317	1515
080	26	1170	800	2262	1196	1,25	65,00	17,68	-	1422	1635
090	26	1170	900	2522	1300	1,26	72,80	19,50	-	1522	1750
377 126 040 XX YY 00	28	1260	400	1372	728	1,24	39,20	10,08	-	1070	1231
050	28	1260	500	1512	868	1,25	47,60	12,32	-	1185	1363
060	28	1260	600	1904	1008	1,25	56,00	14,56	-	1296	1490
070	28	1260	700	2184	1148	1,25	61,60	16,80	-	1407	1618
080	28	1260	800	2436	1288	1,25	70,00	19,04	-	1515	1742
090	28	1260	900	2716	1400	1,26	78,40	21,00	-	1625	1869
377 144 040 XX YY 00	32	1440	400	1568	832	1,24	44,80	11,52	-	1206	1387
050	32	1440	500	1728	992	1,25	54,40	14,08	-	1331	1531
060	32	1440	600	2176	1152	1,25	64,00	16,64	-	1458	1677
070	32	1440	700	2496	1312	1,25	70,40	19,20	-	1587	1825
080	32	1440	800	2784	1472	1,25	80,00	21,76	-	1712	1969
090	32	1440	900	3104	1600	1,26	89,60	24,00	-	1840	2116
377 162 040 XX YY 00	36	1620	400	1764	936	1,24	50,40	12,96	-	1338	1539
050	36	1620	500	1944	1116	1,25	61,20	15,84	-	1481	1703
060	36	1620	600	2448	1296	1,25	72,00	18,72	-	1623	1866
070	36	1620	700	2808	1476	1,25	79,20	21,60	-	1766	2031
080	36	1620	800	3132	1656	1,25	90,00	24,48	-	1907	2193
090	36	1620	900	3492	1800	1,26	100,80	27,00	-	2053	2361
377 180 040 XX YY 00	40	1800	400	1960	1040	1,24	56,00	14,40	-	1472	1693
050	40	1800	500	2160	1240	1,25	68,00	17,60	-	1629	1873
060	40	1800	600	2720	1440	1,25	80,00	20,80	-	1787	2055
070	40	1800	700	3120	1640	1,25	88,00	24,00	-	1947	2239
080	40	1800	800	3480	1840	1,25	100,00	27,20	-	2104	2420
090	40	1800	900	3880	2000	1,26	112,00	30,00	-	2266	2606
377 198 040 XX YY 00	44	1980	400	2156	1144	1,24	61,60	15,84	-	1606	1847
050	44	1980	500	2376	1364	1,25	74,80	19,36	-	1779	2046
060	44	1980	600	2992	1584	1,25	88,00	22,88	-	1950	2243
070	44	1980	700	3432	1804	1,25	96,80	26,40	-	2129	2448
080	44	1980	800	3828	2024	1,25	110,00	29,92	-	2304	2650
090	44	1980	900	4268	2200	1,26	123,20	33,00	-	2474	2845
377 216 040 XX YY 00	48	2160	400	2352	1248	1,24	67,20	17,28	-	1738	1999
050	48	2160	500	2592	1488	1,25	81,60	21,12	-	1930	2220
060	48	2160	600	3264	1728	1,25	96,00	24,96	-	2119	2437
070	48	2160	700	3744	1968	1,25	105,60	28,80	-	2308	2654
080	48	2160	800	4176	2208	1,25	120,00	32,64	-	2497	2872
090	48	2160	900	4656	2400	1,26	134,40	36,00	-	2688	3091

Conform EN442-1: 2014: radiatoren en convectoren

Voor meer details over onze artikel-data, zie artikel-database: <https://www.2ba.nl>

Voor de warmteafgiftes van andere regimes, kijkt u op p. 346 (correctiefactoren)
NEDERLAND. Prijzen in euro (excl. BTW)

HOE TULIPA-A HORIZONTAAL BESTELLEN

Leveringstermijn 15 - 30 werkdagen
(zonder transportduur)

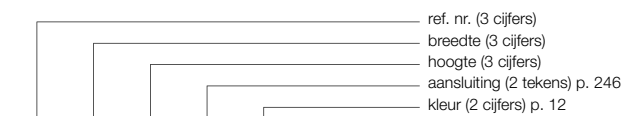

377	270	040	XX	YY	00
-----	-----	-----	----	----	----

VRIJSTAANDE OPSTELLING (TH2-A)

Zie p. 244 voor extra toebehoren.

uitvoering (2 tekens)
00 = standaard
06 = met aangelaste voeten
H0 = hogere werkdruk (10 bar)

TULIPA-A HORIZONTAAL (TH2-A)



TH2-A

PRIJSGROEP: VPG2 - STAAL DESIGNRADIATOREN

BESTELCODE MAATWERK TULIPA-A HORIZONTAAL	TECHNISCHE GEGEVENS								STANDAARDKLEUR	ANDERE KLEUREN						
	buizen	breedte (L mm)	hoogte (H mm)	75/65/20 (Watt) (φ50K)	55/45/20 (Watt) (φ30K)	n-exp.	gewicht (kg)	inhoud (l)			el. weerst. (Watt)	prijs RAL 9016 (€)	prijs kleur (€)			
REF. NR. TULIPA-A HORIZONTAAL TH2-A : 377																
377	234	040	XX	YY	00	52	2340	400	2548	1352	1,24	72,80	18,72	-	1871	2152
		050				52	2340	500	2808	1612	1,25	88,40	22,88	-	2077	2389
		060				52	2340	600	3536	1872	1,25	104,00	27,04	-	2281	2623
		070				52	2340	700	4056	2132	1,25	114,40	31,20	-	2488	2861
		080				52	2340	800	4524	2392	1,25	130,00	35,36	-	2692	3096
		090				52	2340	900	5044	2600	1,26	145,60	39,00	-	2902	3337
377	252	040	XX	YY	00	56	2520	400	2744	1456	1,24	78,40	20,16	-	2001	2301
		050				56	2520	500	3024	1736	1,25	95,20	24,64	-	2225	2559
		060				56	2520	600	3808	2016	1,25	112,00	29,12	-	2449	2816
		070				56	2520	700	4368	2296	1,25	123,20	33,60	-	2671	3072
		080				56	2520	800	4872	2576	1,25	140,00	38,08	-	2888	3321
		090				56	2520	900	5432	2800	1,26	156,80	42,00	-	3113	3580
377	270	040	XX	YY	00	60	2700	400	2940	1560	1,24	84,00	21,60	-	2135	2455
		050				60	2700	500	3240	1860	1,25	102,00	26,40	-	2372	2728
		060				60	2700	600	4080	2160	1,25	120,00	31,20	-	2611	3003
		070				60	2700	700	4680	2460	1,25	132,00	36,00	-	2845	3272
		080				60	2700	800	5220	2760	1,25	150,00	40,80	-	3086	3549
377	288	040	XX	YY	00	64	2880	400	3136	1664	1,24	89,60	23,04	-	2268	2608
		050				64	2880	500	3456	1984	1,25	108,80	28,16	-	2523	2901
		060				64	2880	600	4352	2304	1,25	128,00	33,28	-	2777	3194
		070				64	2880	700	4992	2624	1,25	140,80	38,40	-	3030	3485
377	306	040	XX	YY	00	68	3060	400	3332	1768	1,24	95,20	24,48	-	2400	2760
		050				68	3060	500	3672	2108	1,25	115,60	29,92	-	2673	3074
		060				68	3060	600	4624	2448	1,25	136,00	35,36	-	2939	3380
		070				68	3060	700	5304	2788	1,25	149,60	40,80	-	3211	3693

Conform EN442-1: 2014: radiatoren en convectoren

Voor meer details over onze artikel-data, zie artikel-database: <https://www.2ba.nl>

Voor de warmteafgiftes van andere regimes, kijkt u op p. 346 (correctiefactoren)
NEDERLAND. Prijzen in euro (excl. BTW)

TULIPA-A VRIJSTAANDE OPSTELLING IN OPTIE

PRIJSGROEP: VPG10 - ACC.



VRIJSTAANDE OPSTELLING		KLEUR	ART. NR.	€
VASTE VOET 	TV1-A / TH1-A			
	150 mm (geen zijbevestiging)	RAL 9016	*	83
		KLEUR	*	95
	TV2-A / TH2-A			
	150 mm (geen zijbevestiging)	RAL 9016	*	168
		KLEUR	*	193

- Extra muurbevestigingssteun nodig voor hoogte radiator > 600 mm (meegeleverd).
- Gelieve bij bestelling code **06** aan te geven bij "Afwerking" (vaste voet in de prijs inbegrepen).
- Geen rozetten beschikbaar.

lengte radiator (mm)	TV1-A / TV2-A	TH1-A / TH2-A		
		540 - 1440	1620 - 2340	> 2340
aantal voeten	2x	2x	3x	4x

NEDERLAND. Prijzen in euro (excl. BTW)

PRIJSGROEP: VPG10 - ACC.

ACCESSOIRES		KLEUR	ART. NR.	€
THERMOSTAATKOP		TV1-A / TV2-A		
		WIT	11911630102	50
THERMOSTAATKOP		TV1-A / TV2-A		
		CHROOM	11911631102	64

PRIJSGROEP: VPG10B - HANDDOEKBEUGELS

ACCESSOIRES	BREEDTE HANDDOEKBEUGEL	KLEUR	ART. NR.	€	
HANDDOEKBEUGEL		TV1-A / TV2-A / TH1-A / TH2-A			
		500 mm	CHROOM	1183 269 0000 0099	145
		500 mm	RAL 9016	1183 269 0000 9016	145
		500 mm	RAL 9005 ^M	1183 269 0000 9005	145

- h = 55 mm; b = 500 mm; d = 58 mm; a = 43 mm;

^M mat zwart

Montagevoorschriften accessoires: zie www.vasco.eu
NEDERLAND. Prijzen in euro (excl. BTW)

d = afstand voorkant accessoire tot voorkant radiator

a = afstand accessoire tot radiator

uit voorraad leverbaar

TULIPA-A AANSLUITINGEN

TULIPA-A VERTICAAL: TV1-A / TV2-A (VOORRAAD)

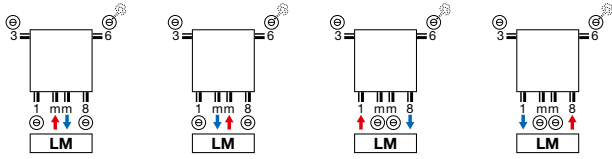

TULIPA-A HORIZONTAAL: TH1-A / TH2-A (NIET-VOORRAAD)

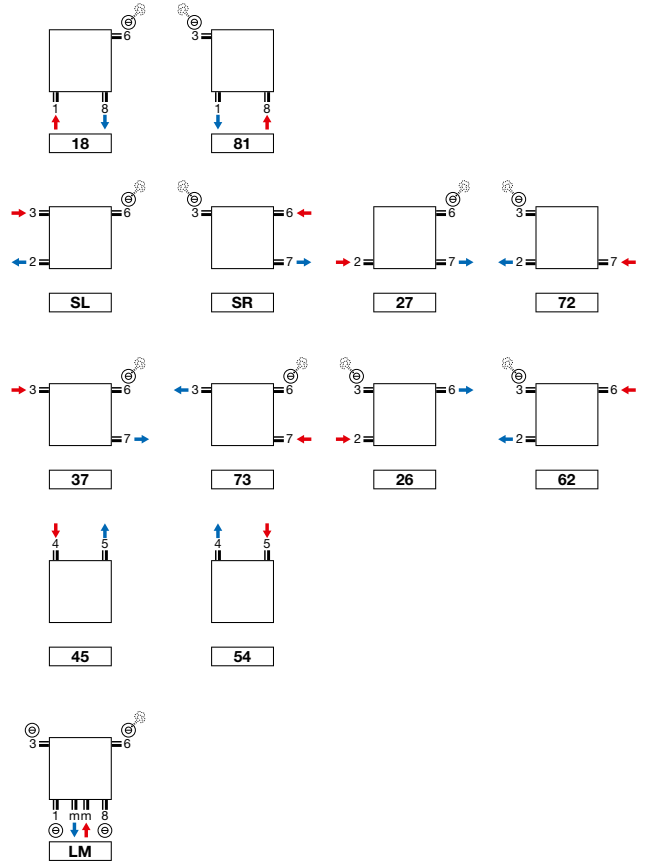

TULIPA-A VERTICAAL: TV1-A / TV2-A (NIET-VOORRAAD)

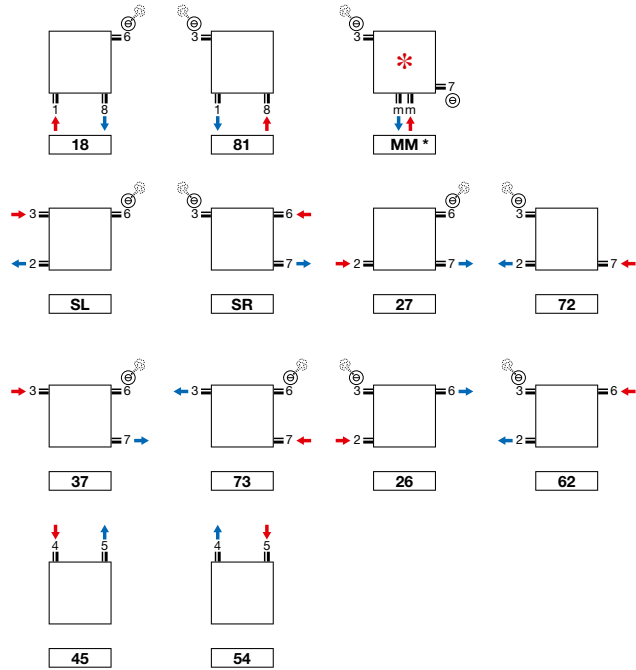

- * Aansluiting MM: aanvoer moet aan de rechterkant!
- Tulipa-A 6 en 8 buizen: aansluiting 1mm8, 18, 81 niet mogelijk

Opmerking: het aansluiten van de radiator kan enkel volgens de getoonde aansluiticonen. Voor elke andere aansluitwijze nemen wij geen verantwoordelijkheid.

TULIPA-A VERTICAAL (TV1-A, TV2-A)

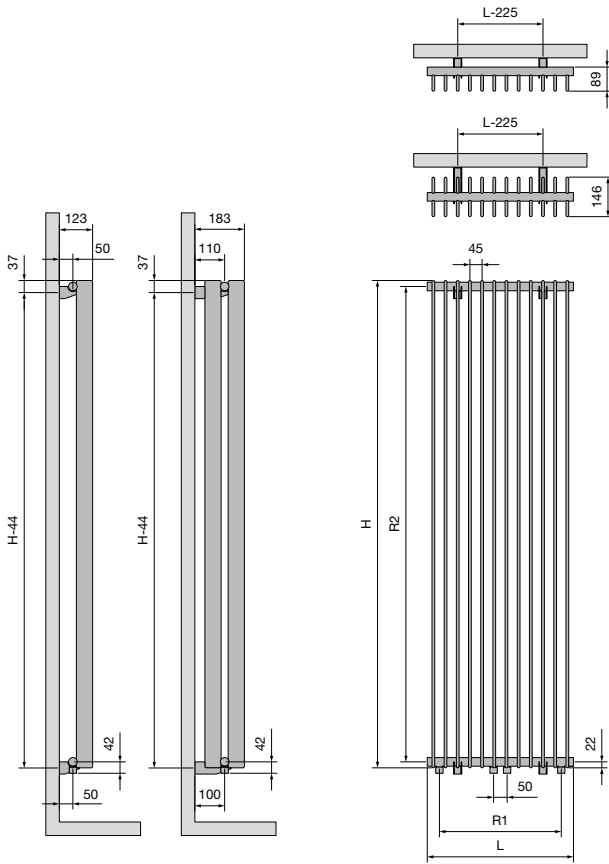

TV1-A / TV2-A

Breedte (L)	270	360	450	540	630	720	810	900	990	1080	1170	1260
Hartafstand tussen de onderaansluitingen 18 (R1)	180	270	360	450	540	630	720	810	900	990	1080	1170
hoogte (H)	1000	1200	1500	1600	1800	2000	2200	2500	3000			
Hartafstand tussen de zijaansluitingen SL/SR (R2)	956	1156	1456	1556	1756	1956	2156	2456	2956			
Hartafstand tussen de ophangingen	H-44											

TULIPA-A HORIZONTAAL (TH1-A, TH2-A)

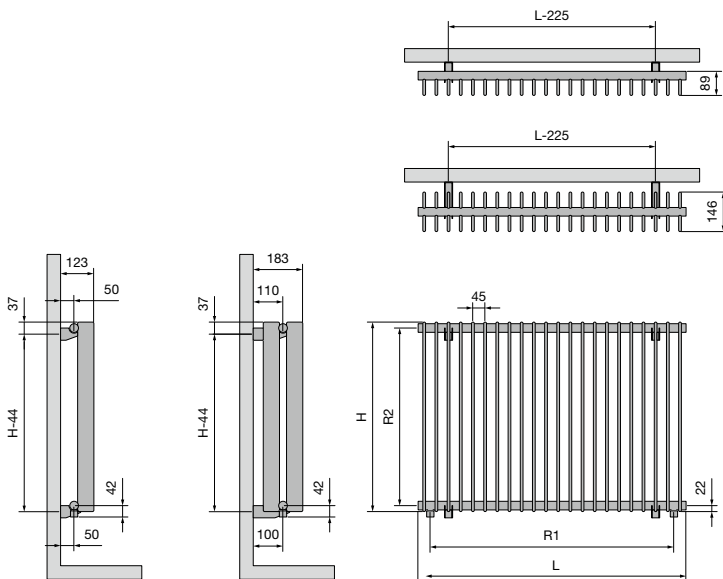

TH1-A / TH2-A

Breedte (L)	540	630	720	810	900	990	1080	1170	1260	1440	1620	1800	1980	2160	2340	2520	2700	2880	3060
Hartafstand tussen de onderaansluitingen 18 (R1)	450	540	630	720	810	900	990	1080	1170	1350	1530	1710	1890	2070	2250	2430	2610	2790	2970
hoogte (H)	400	500	600	700	800	900													
Hartafstand tussen de zijaansluitingen SL/SR (R2)	356	456	556	656	756	856													
Hartafstand tussen de ophangingen	H-44																		