





Staal designradiatoren

De kracht van staal, de finesse van design.

VASCO staal designradiatoren combineren eigentijds warmtecomfort met een doordachte, tijdloze vormgeving.

Elke collectie is een verfijnde balans tussen efficiëntie en esthetiek, ontworpen op maat van elke woonruimte en geschikt voor uiteenlopende toepassingen.

Het samenspel van ervaren technici, innovatieve ontwerpers en wetenschappelijke specialisten resulteert in radiatoren waarin elk detail telt.

Stuk voor stuk meesterwerken van technisch vernuft en creativiteit, bekroond met internationale designprijzen en herkenbaar aan hun zuivere vormgeving en optimaal gebruiksgemak.

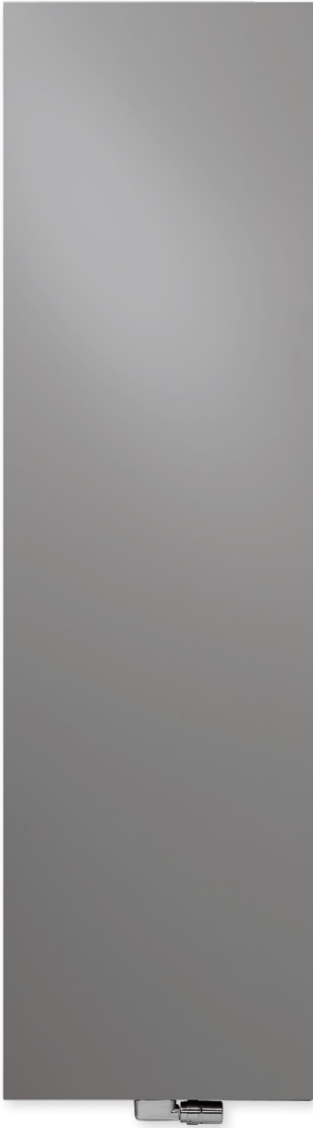

TYPES

- Enkel (N1L1) en dubbel (N2L1)

KLEUREN

- Standaardkleur S600 (witte fijn structuurlak) (RAL 9016: geen meerprijs 15%)
- Uitgebreide kleurenkaart zie p. 12

SPECIAAL

- De Niva Lak Verticaal is beschikbaar met een gelakte voorplaat (dwz. plaatradiator + gelakte voorplaat).

BEVESTIGINGEN

- Muurbevestigingen in de kleur RAL 7016 (antraciet grijs) standaard. Ook in optie verkrijgbaar in de kleur S600 (zie p. 181).

TECHNISCH

- Elektrisch weerstandsgelast (onzichtbare lasnaden) en rolnaadgelast
- KTL-grondlaag, poedercoating
- Standaardwerkdruk: 10 bar
- Maximale bedrijfstemperatuur: 110°C

ELEKTRISCH (beschikbare uitvoeringen: zie hoofdstuk elektrische radiatoren)

- ✓ Zuiver elektrische radiator (zie p. 80)
- ✓ Gemengde radiator (zie p. 116)

TECHNISCHE TEKENINGEN

- Zie p. 185

AANSLUITING

- ✗ Eénpuntsaansluiting voor éénpijpssysteem
- ✗ Eénpuntsaansluiting voor tweepijpssysteem
- ✓ Tweepuntsaansluiting voor éénpijpssysteem (aansluiting via de middenaansluiting) (zie p. 362)
- ✓ Tweepuntsaansluiting voor tweepijpssysteem (standaard) (zie p. 362)
- ✗ Geïntegreerd ventiel
- Aansluitingen: 1/2" (binnendraad)

NIVA LAK VERTICAAL

Puur technische klasse, puur design, puur sfeer

De ultracompacte, gestyleerde Niva is nog steeds een stichtend voorbeeld voor heel wat ontwerpers en collega-producenten. Eén en al functionaliteit door de optimale luchtdoorstroming en de extra hoge warmteafgifte die meteen op gang komt. Eén en al design door de integere, zuivere vormgeving, het zwevend karakter –dankzij de achterliggende, onzichtbare ophanging- en de organisch geïntegreerde handdoekbeugel.

AANBEVOLEN AANSLUITING (LB)

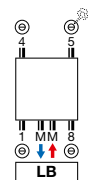

Andere aansluitmogelijkheden, zie p. 184



art. nr. 1182 103 0000 0099

prijs € 190

Koppelingen, zie p. 377

AANBEVOLEN VOOR BADKAMER EN KEUKEN IN OPTIE



handdoekbeugel (chrom) N1L1 art. nr. zie p. 182

prijs € 201

N2L1 art. nr. zie p. 182

prijs € 201

Andere accessoires, zie p. 182



HOE NIVA LAK VERTICAAL BESTELLEN

Leveringstermijn 15 - 30 werkdagen
(zonder transportduur)

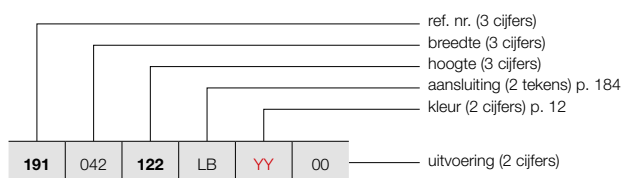

NIVA LAK VERTICAAL (N1L1, N2L1)

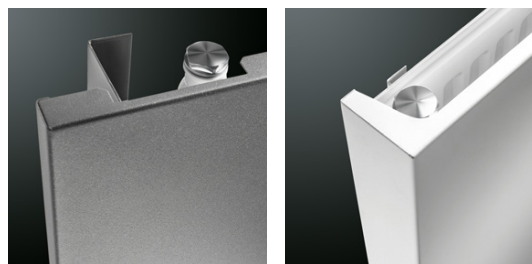

N1L1

N2L1

HOE VOORRAADRADIATOR NIVA LAK VERTICAAL BESTELLEN

Leveringstermijn 5 werkdagen
(zonder transportduur)

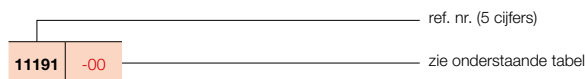

PRIJSGROEP: VPG2 - STAAL DESIGNRADIATOREN

BESTELCODE MAATWERK NIVA LAK VERTICAAL	TECHNISCHE GEGEVENS									STANDAARDKLEUR		ANDERE KLEUREN	
	buizen	breedte (L mm)	hoogte (H mm)	75/65/20 (Watt) (Φ50K)	55/45/20 (Watt) (Φ30K)	n-exp.	gewicht (kg)	inhoud (l)	el. weerst. (Watt)	prijs S600* (€)	verkorte ref. nr. S600 voorraad	prijs kleur (€)	verkorte ref. nr. M301 voorraad
REF. NR. NIVA LAK VERTICAAL N1L1 : 191													
191 042 122 LB YY 00	-	420	1220	645	337	1,27	18,10	2,55	-	619	11191-02	712	-
	-	420	1820	934	486	1,28	27,35	3,70	-	720	11191-03	828	11191-05
	-	420	2020	1023	532	1,28	30,20	4,00	-	761	11191-06	875	-
	-	420	2220	1070	559	1,27	33,20	4,50	-	826	-	950	-
191 052 122 LB YY 00	-	520	1220	815	424	1,28	21,97	3,32	-	696	11191-21	800	-
	-	520	1820	1128	587	1,28	33,67	4,61	-	811	11191-16	933	11191-01
	-	520	2020	1257	654	1,28	37,12	5,05	-	857	11191-22	986	-
	-	520	2220	1310	681	1,28	40,88	5,57	-	930	-	1070	-
191 062 122 LB YY 00	-	620	1220	985	510	1,29	25,83	3,85	-	725	11191-07	834	-
	-	620	1820	1322	687	1,28	39,98	5,52	-	842	11191-17	968	11191-04
	-	620	2020	1490	775	1,28	44,03	6,10	-	897	11191-20	1032	-
	-	620	2220	1550	806	1,28	48,57	6,63	-	971	-	1117	-
191 072 182 LB YY 00	-	720	1820	1515	784	1,29	46,30	6,43	-	878	11191-08	1010	-
	-	720	2020	1724	897	1,28	50,95	7,15	-	933	11191-09	1073	-
	-	720	2220	1790	926	1,29	56,25	7,70	-	1016	-	1168	-
REF. NR. NIVA LAK VERTICAAL N2L1 : 192													
192 042 122 LB YY 00	-	420	1220	988	506	1,31	26,50	4,90	-	927	-	1066	-
	-	420	1820	1330	681	1,31	42,23	7,28	-	1078	11192-02	1240	-
	-	420	2020	1438	736	1,31	46,75	8,00	-	1118	11192-04	1286	-
	-	420	2220	1543	823	1,23	51,40	8,90	-	1192	-	1371	-
192 052 122 LB YY 00	-	520	1220	1213	621	1,31	33,00	6,48	-	1045	11192-05	1202	-
	-	520	1820	1633	836	1,31	51,68	9,07	-	1211	11192-31	1393	-
	-	520	2020	1764	903	1,31	57,23	10,00	-	1257	11192-32	1446	-
	-	520	2220	1893	995	1,26	62,73	11,00	-	1342	-	1543	-
192 062 122 LB YY 00	-	620	1220	1437	732	1,32	39,50	7,02	-	1084	11192-37	1247	-
	-	620	1820	1935	991	1,31	61,14	10,86	-	1257	11192-33	1446	-
	-	620	2020	2091	1071	1,31	67,72	12,00	-	1315	11192-34	1512	-
	-	620	2220	2243	1160	1,29	74,07	13,10	-	1401	11192-39	1611	-
192 072 182 LB YY 00	-	720	1820	2237	1146	1,31	70,60	12,65	-	1315	11192-07	1512	-
	-	720	2020	2417	1238	1,31	78,20	14,00	-	1372	11192-35	1578	-
	-	720	2220	2594	1322	1,32	85,40	15,20	-	1463	11192-36	1682	-

Conform EN442-1: 2014: radiatoren en convectoren

* RAL 9016: geen meerprijs 15%

Voor meer details over onze artikel-data, zie artikel-database: <https://www.2ba.nl>

Voor de warmteafgiftes van andere regimes, kijkt u op p. 370 (correctiefactoren)
NEDERLAND. Prijzen in euro (excl. BTW)



TYPES

- Enkel (N1L1-ES) en dubbel (N2L1-ES)

KLEUREN

- Inox / RVS type 316L, mat geborsteld met korrel 360

SPECIAAL

- De Niva Inox Verticaal is beschikbaar met een inox voorplaat (dwz. stalen plaatradiator + inox-voorplaat).
- De Niva Inox Verticaal is te reinigen met een inox cleaner.

BEVESTIGINGEN

- Muurbevestigingen in de kleur RAL 7016 (antraciet grijs) standaard. Ook in optie verkrijgbaar in de kleur S600 (zie p. 181).

TECHNISCH

- Elektrisch weerstandsgelast (onzichtbare lasnaden) en rolnaadgelast
- Standaardwerkdruk: 10 bar
- Maximale bedrijfstemperatuur: 110°C

ELEKTRISCH

- ✗ Zuiver elektrische radiator
- ✗ Gemengde radiator

TECHNISCHE TEKENINGEN

- Zie p. 185

AANSLUITING

- ✗ Eénpuntsaansluiting voor éénpijpsysteem
- ✗ Eénpuntsaansluiting voor tweepijpsysteem
- ✓ Tweepuntsaansluiting voor éénpijpsysteem (aansluiting via de middenaansluiting) (zie p. 362)
- ✓ Tweepuntsaansluiting voor tweepijpsysteem (standaard) (zie p. 362)
- ✗ Geïntegreerd ventiel
- Aansluitingen: ½" (binnendraad)

NIVA INOX VERTICAAL

Pure klasse in al haar pracht

De Niva Inox Verticaal combineert een stalen plaatradiator met een inox voorplaat, die de integere, zuivere vormgeving en het zwevende karakter van de Niva letterlijk 'extra glans' geeft. De Niva Inox Verticaal designradiator is ook leverbaar met organisch geïntegreerde inox handdoekbeugel (in optie).

AANBEVOLEN AANSLUITING (LB)

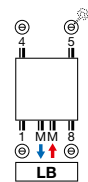

Andere aansluitmogelijkheden, zie p. 184

AANBEVOLEN VOOR BADKAMER EN KEUKEN IN OPTIE



handdoekbeugel (chrom) N1L1 art. nr. zie p. 182
prijs €201

N2L1 art. nr. zie p. 182
prijs €201

Andere accessoires, zie p. 182



HOE NIVA INOX VERTICAAL BESTELLEN

Leveringstermijn 15 - 30 werkdagen
(zonder transportduur)

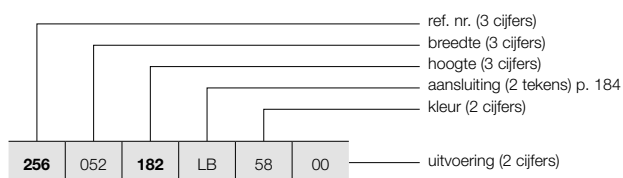

NIVA INOX VERTICAAL (N1L1-ES, N2L1-ES)

175

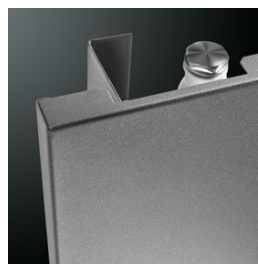

N1L1-ES

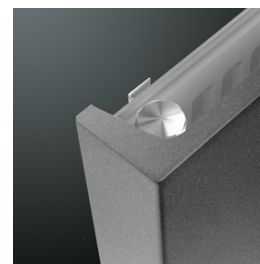

N2L1-ES

PRIJSGROEP: VPG2 - STAAL DESIGNRADIATOREN

BESTELCODE MAATWERK NIVA INOX VERTICAAL	TECHNISCHE GEGEVENS									STANDAARDKLEUR					
	buizen	breedte (L mm)	hoogte (H mm)	75/65/20 (Watt) (Φ50K)	55/45/20 (Watt) (Φ30K)	n-exp.	gewicht (kg)	inhoud (l)	el. weerst. (Watt)	prijs inox (€)					
REF. NR. NIVA INOX VERTICAAL N1L1-ES : 256															
256	052	182	LB	58	00	-	520	1820	1128	587	1,28	33,67	4,61	-	1457
		202				-	520	2020	1257	654	1,28	37,12	5,05	-	1545
256	062	182	LB	58	00	-	620	1820	1322	687	1,28	39,98	5,52	-	1514
		202				-	620	2020	1490	775	1,28	44,03	6,10	-	1612
REF. NR. NIVA INOX VERTICAAL N2L1-ES : 257															
257	052	182	LB	58	00	-	520	1820	1633	836	1,31	51,68	9,07	-	2182
		202				-	520	2020	1764	903	1,31	57,23	10,00	-	2266
257	062	182	LB	58	00	-	620	1820	1935	991	1,31	61,14	10,86	-	2267
		202				-	620	2020	2091	1071	1,31	67,72	12,00	-	2365

Conform EN442-1: 2014: radiatoren en convectoren

Voor meer details over onze artikel-data, zie artikel-database: <https://www.2ba.nl>
Voor de warmteafgiftes van andere regimes, kijkt u op p. 370 (correctiefactoren)
NEDERLAND. Prijzen in euro (excl. BTW)



GEÏNTEGREERD VENTIEL NIVA LAK HORIZONTAAL

- Radiator in wit: thermostaatkop in wit standaard, in de prijs inbegrepen
- Radiator in kleur: thermostaatkop in chroom standaard, in de prijs inbegrepen



TYPES

- NH1L1, NH2L1, NH2L2

KLEUREN

- Standaardkleur S600 (witte fijn structuurlak) (RAL 9016: geen meerprijs 15%)
- Uitgebreide kleurenkaart zie p. 12

SPECIAAL

- De Niva Lak Horizontaal is verkrijgbaar met 1 (NH1L1, NH2L1) of 2 rijen (NH2L2) lamellen ter verhoging van de warmteafgifte.
- NH1L1 ook verkrijgbaar als toiletradiator (520 x 450 mm)

BEVESTIGINGEN

- Muurbevestigingen in de kleur RAL 7016 (antraciet grijs) standaard. Ook in optie verkrijgbaar in de kleur S600 (zie p. 181).

TECHNISCH

- Elektrisch weerstandsgelast (onzichtbare lasnaden) en rolnaadgelast
- KTL-grondlaag, poedercoating
- Standaardwerkdruk: 10 bar
- Maximale bedrijfstemperatuur: 110°C

ELEKTRISCH

- ✗ Zuiver elektrische radiator
- ✗ Gemengde radiator

TECHNISCHE TEKENINGEN

- Zie p. 186

AANSLUITING

- ✗ Eénpuntsaansluiting voor éénpijpssysteem
- ✗ Eénpuntsaansluiting voor tweepijpssysteem
- ✓ Tweepuntsaansluiting voor éénpijpssysteem (aansluiting via het geïntegreerd ventiel) (zie p. 363)
- ✓ Tweepuntsaansluiting voor tweepijpssysteem (standaard) (zie p. 362)
- ✓ Geïntegreerd ventiel (**geen meerprijs**) (zie p. 363)
- Aansluitingen: 4x½" zijdelings (binnendraad), 2x¾" Euroconus (50mm rechtsonder)

NIVA LAK HORIZONTAAL

Pure klasse in al haar eenvoudig

Ook in de horizontale versie is en blijft de Niva een toonbeeld van efficiënte toegepaste vormgeving. Een geslaagde combinatie van functionaliteit en design, met de keuze uit 1 of 2 lamellen voor een aangepaste warmteafgifte, ook beschikbaar in toiletversie. Met optionele handdoekbeugel in chroomuitvoering.

AANBEVOLEN AANSLUITING (VR) GEÏNTEGREERD VENTIEL

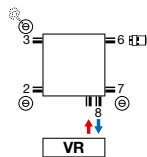

Andere aansluitmogelijkheden, zie p. 184



niet mogelijk voor stadsverwarming

art. nr. 1182 300 0000 0099

prijs € 173

Koppelingen, zie p. 377

AANBEVOLEN VOOR BADKAMER EN KEUKEN IN OPTIE



handdoekbeugel (chrom) art. nr. zie p. 182

prijs € 201



HOE NIVA LAK HORIZONTAAL BESTELLEN

Leveringstermijn 15 - 30 werkdagen
(zonder transportduur)

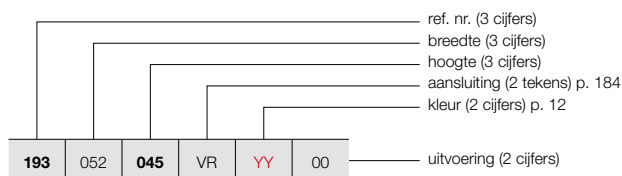

HOE VOORRAADRADIATOR NIVA LAK HORIZONTAAL BESTELLEN

Leveringstermijn 5 werkdagen
(zonder transportduur)

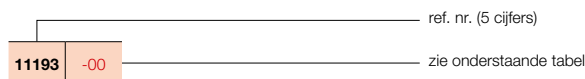

NIVA LAK HORIZONTAAL (NH1L1, NH2L1, NH2L2)



NH1L1 / NH2L1

PRIJSGROEP: VPG2 - STAAL DESIGNRADIATOREN

BESTELCODE MAATWERK NIVA LAK HORIZONTAAL	TECHNISCHE GEGEVENS							STANDAARDKLEUR		ANDERE KLEUREN							
	buizen	breedte (L mm)	hoogte (H mm)	75/65/20 (Watt) (φ50K)	55/45/20 (Watt) (φ30K)	n-exp.	gewicht (kg)	inhoud (l)	el. weerst. (Watt)		prijs S600* (€)	verkorte ref. nr. S600 voorraad	prijs kleur (€)				
REF. NR. NIVA LAK HORIZONTAAL NH1L1 : 193																	
193	052	045	VR	YY	00	-	520	450	301	158	1,26	7,50	1,19	-	523	11193-01	601
193	062	055	VR	YY	00	-	620	550	425	223	1,26	11,11	1,66	-	580	-	667
		065				-	620	650	490	256	1,27	13,28	1,92	-	686	-	789
193	082	055	VR	YY	00	-	820	550	562	295	1,26	14,69	2,20	-	675	-	776
		065				-	820	650	649	339	1,27	17,56	2,53	-	779	-	896
193	102	055	VR	YY	00	-	1020	550	699	367	1,26	18,28	2,73	-	767	-	882
		065				-	1020	650	807	422	1,27	21,85	3,15	-	874	-	1005
		095				-	1020	950	1124	585	1,28	31,85	4,40	-	1042	-	1198
193	122	055	VR	YY	00	-	1220	550	836	439	1,26	21,86	3,27	-	858	-	987
		065				-	1220	650	965	504	1,27	26,13	3,77	-	967	-	1112
		095				-	1220	950	1344	699	1,28	38,10	5,26	-	1137	-	1308
REF. NR. NIVA LAK HORIZONTAAL NH2L1 : 194																	
194	062	055	VR	YY	00	-	620	550	611	318	1,28	17,25	3,27	-	806	-	927
		065				-	620	650	708	370	1,27	20,70	3,83	-	967	-	1112
194	082	055	VR	YY	00	-	820	550	809	421	1,28	22,81	4,32	-	905	-	1041
		065				-	820	650	936	489	1,27	27,37	5,07	-	1071	-	1232
194	102	055	VR	YY	00	-	1020	550	1006	523	1,28	28,38	5,38	-	1011	-	1163
		065				-	1020	650	1165	609	1,27	34,05	6,30	-	1172	11194-23	1348
		095				-	1020	950	1630	839	1,30	50,20	9,05	-	1395	-	1604
194	122	055	VR	YY	00	-	1220	550	1203	626	1,28	33,94	6,43	-	1116	-	1283
		065				-	1220	650	1393	728	1,27	40,72	7,54	-	1281	-	1473
		095				-	1220	950	1950	1004	1,30	60,05	10,82	-	1509	-	1735
194	142	055	VR	YY	00	-	1420	550	1400	728	1,28	39,50	7,48	-	1299	-	1494
		065				-	1420	650	1622	848	1,27	47,40	8,78	-	1491	-	1715
194	162	055	VR	YY	00	-	1620	550	1597	830	1,28	45,07	8,54	-	1482	-	1704
		065				-	1620	650	1850	967	1,27	54,08	10,01	-	1698	-	1953

Conform EN442-1: 2014: radiatoren en convectoren

* RAL 9016: geen meerprijs 15%

Voor meer details over onze artikel-data, zie artikel-database: <https://www.2ba.nl>

Voor de warmteafgiftes van andere regimes, kijkt u op p. 370 (correctiefactoren)
NEDERLAND. Prijzen in euro (excl. BTW)

NIVA LAK HORIZONTAAL (NH2L2)



NH2L2

HOE NIVA LAK HORIZONTAAL BESTELLEN

Leveringstermijn 15 - 30 werkdagen
(zonder transportduur)

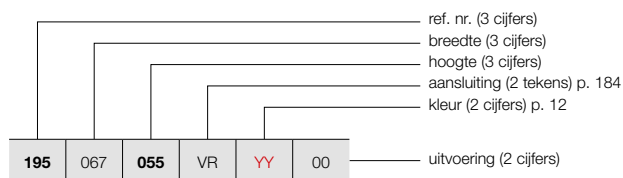

HOE VOORRAADRADIATOR NIVA LAK HORIZONTAAL BESTELLEN

Leveringstermijn 5 werkdagen
(zonder transportduur)

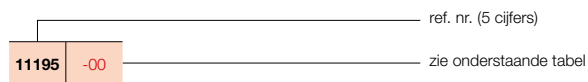

PRIJSGROEP: VPG2 - STAAL DESIGNRADIATOREN

BESTELCODE MAATWERK NIVA LAK HORIZONTAAL	TECHNISCHE GEGEVENS									STANDAARDKLEUR		ANDERE KLEUREN prijs kleur (€)					
	buizen	breedte (L mm)	hoogte (H mm)	75/65/20 (Watt Ø50K)	55/45/20 (Watt Ø30K)	n-exp.	gewicht (kg)	inhoud (l)	el. weerst. (Watt)	prijs S600* (€)	verkorte ref. nr. S600 voorraad						
REF. NR. NIVA LAK HORIZONTAAL NH2L2 : 195																	
195	067	055	VR	YY	00	-	678	550	804	416	1,29	20,50	3,40	-	990	-	1139
		065				-	678	650	941	487	1,29	24,28	3,93	-	1116	-	1283
195	087	055	VR	YY	00	-	878	550	1041	539	1,29	26,55	4,40	-	1129	-	1298
		065				-	878	650	1219	631	1,29	31,44	5,09	-	1255	-	1443
195	107	055	VR	YY	00	-	1078	550	1279	662	1,29	32,60	5,40	-	1271	-	1462
		065				-	1078	650	1496	774	1,29	38,60	6,25	-	1397	11195-16	1607
		095				-	1078	950	2027	1043	1,30	57,90	9,00	-	1626	-	1870
195	127	055	VR	YY	00	-	1278	550	1516	784	1,29	38,65	6,40	-	1407	-	1618
		065				-	1278	650	1774	918	1,29	45,77	7,41	-	1536	-	1766
		095				-	1278	950	2403	1237	1,30	68,64	10,67	-	1765	-	2030
195	147	055	VR	YY	00	-	1478	550	1753	907	1,29	44,69	7,40	-	1627	-	1871
		065				-	1478	650	2051	1061	1,29	52,93	8,57	-	1775	-	2041
195	167	055	VR	YY	00	-	1678	550	1990	1030	1,29	50,74	8,41	-	1849	-	2126
		065				-	1678	650	2329	1205	1,29	60,09	9,73	-	2014	-	2316

Conform EN442-1: 2014: radiatoren en convectoren

* RAL 9016: geen meerprijs 15%
Voor meer details over onze artikel-data, zie artikel-database: <https://www.2ba.nl>
Voor de warmteafgiftes van andere regimes, kijkt u op p. 370 (correctiefactoren)
NEDERLAND. Prijzen in euro (excl. BTW)

TYPES

- Enkel (NS1L1) en dubbel (NS2L1)

KLEUREN

- Standaardkleur S600 (witte fijn structuurlak) (RAL 9016: geen meerprijs 15%)
- Uitgebreide kleurenkaart zie p. 12

SPECIAAL

- De Niva Soft Verticaal is beschikbaar met een gelakte voorplaat (dwz. stalen plaatradiator + gelakte voorplaat).
- Vlakke voorplaat en afgeronde zijkanalen als hedendaagse troef
- Thermostaatkop op deurknophoogte in optie (niet bij NS1L1) (zie p. 363).

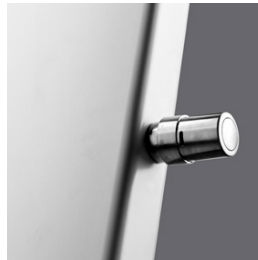

BEVESTIGINGEN

- Muurbevestigingen in de kleur RAL 7016 (antraciet grijs) standaard. Ook in optie verkrijgbaar in de kleur S600 (zie p. 181).

TECHNISCH

- Elektrisch weerstandsgelast (onzichtbare lasnaden) en rolnaadgelast
- KTL-grondlaag, poedercoating
- Standaardwerkdruk: 10 bar
- Maximale bedrijfstemperatuur: 110°C

ELEKTRISCH

- ✗ Zuiver elektrische radiator
- ✗ Gemengde radiator

TECHNISCHE TEKENINGEN

- Zie p. 187

AANSLUITING

- ✗ Eénpuntsaansluiting voor éénpijpsysteem
- ✗ Eénpuntsaansluiting voor tweepijpsysteem
- ✓ Tweepuntsaansluiting voor éénpijpsysteem (aansluiting via de middenaansluiting) (zie p. 362)
- ✓ Tweepuntsaansluiting voor tweepijpsysteem (standaard) (zie p. 362)
- ✓ Geïntegreerd ventiel (**meerprijs €172**) (niet bij NS1L1) (zie p. 363)
- Aansluitingen: 1/2" (binnendraad)

AANBEVOLEN AANSLUITING NS1L1/NS2L1 (LB)

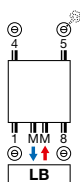

art. nr. 1182 103 0000 0099
prijs € 190
 Koppelingen, zie p. 377

AANBEVOLEN VOOR BADKAMER EN KEUKEN IN OPTIE

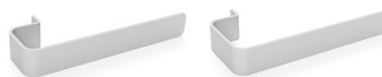

handdoekbeugel (aluminium)

NS1L1 art. nr. zie p. 182
prijs € 201

NS2L1 art. nr. zie p. 182
prijs € 201

Andere accessoires, zie p. 182

OPTIE: AANSLUITING NS2L1 (VR) GEÏNTEGREERD VENTIEL (MEERPRIJS)

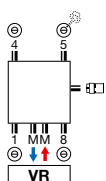

art. nr. 1182 301 0000 0099
prijs € 173
 Koppelingen, zie p. 377

Meerprijs: €172 (zie p. 363)

Andere aansluitmogelijkheden, zie p. 184



STAAL DESIGNRADIATOREN

NIVA SOFT VERTICAAL

Pure klasse in al haar creativiteit

De Niva in al zijn compacte, gestyleerde eenvoud, maar nu in een uitvoering met zacht afgeronde zijkanalen. Een designradiator die uitstekend tot zijn recht komt zowel in een minimalistisch interieur als in een eigentijdse retro-omgeving. Leverbaar met thermostaatkop op deurknophoogte.



NIVA SOFT VERTICAAL (NS1L1, NS2L1)

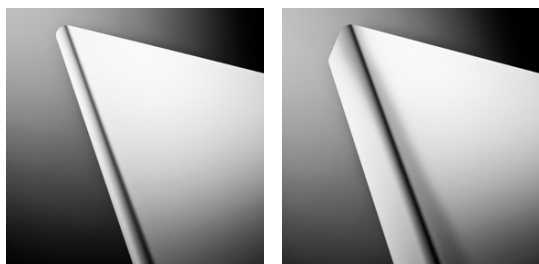

NS1L1

NS2L1

HOE NIVA SOFT BESTELLEN

Leveringstermijn 15 - 30 werkdagen
(zonder transportduur)

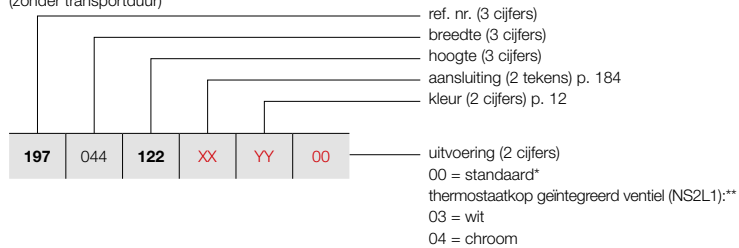

HOE VOORRAADRADIATOR NIVA SOFT BESTELLEN

Leveringstermijn 5 werkdagen
(zonder transportduur)

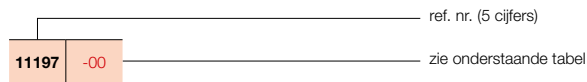

PRIJSGROEP: VPG2 - STAAL DESIGNRADIATOREN

BESTELCODE MAATWERK NIVA SOFT VERTICAAL	TECHNISCHE GEGEVENS									STANDAARDKLEUR		ANDERE KLEUREN prijs kleur (€)					
	buizen	breedte (L mm)	hoogte (H mm)	75/65/20 (Watt) (Φ50K)	55/45/20 (Watt) (Φ30K)	n-exp.	gewicht (kg)	inhoud (l)	el. weerst. (Watt)	prijs S600* (€)	verkorte ref. nr. S600 voorraad						
REF. NR. NIVA SOFT VERTICAAL NS1L1 : 197																	
197	044	122	XX	YY	00	-	440	1220	645	337	1,27	18,10	2,55	-	619	11197-06	712
		182				-	440	1820	934	486	1,28	27,35	3,70	-	720	11197-07	828
		202				-	440	2020	1023	532	1,28	30,20	4,00	-	761	11197-08	875
		222				-	440	2220	1070	559	1,27	33,20	4,50	-	826	-	950
197	054	122	XX	YY	00	-	540	1220	815	424	1,28	21,97	3,32	-	696	11197-04	800
		182				-	540	1820	1128	587	1,28	33,67	4,61	-	811	11197-01	933
		202				-	540	2020	1257	654	1,28	37,12	5,05	-	857	11197-05	986
		222				-	540	2220	1310	681	1,28	40,88	5,57	-	930	-	1070
197	064	122	XX	YY	00	-	640	1220	985	510	1,29	25,83	3,85	-	725	11197-09	834
		182				-	640	1820	1322	687	1,28	39,98	5,52	-	842	11197-02	968
		202				-	640	2020	1490	775	1,28	44,03	6,10	-	897	11197-03	1032
		222				-	640	2220	1550	806	1,28	48,57	6,63	-	971	-	1117
197	074	182	XX	YY	00	-	740	1820	1515	784	1,29	46,30	6,43	-	878	11197-10	1010
		202				-	740	2020	1724	897	1,28	50,95	7,15	-	933	11197-11	1073
		222				-	740	2220	1790	926	1,29	56,25	7,70	-	1016	-	1168
REF. NR. NIVA SOFT VERTICAAL NS2L1 : 198																	
198	044	122	XX	YY	00	-	440	1220	988	506	1,31	28,40	4,90	-	927	-	1066
		182				-	440	1820	1330	681	1,31	42,23	7,28	-	1078	11198-08	1240
		202				-	440	2020	1438	736	1,31	46,75	8,00	-	1118	11198-09	1286
		222				-	440	2220	1543	823	1,23	51,40	8,90	-	1192	-	1371
198	054	122	XX	YY	00	-	540	1220	1213	621	1,31	36,83	6,48	-	1045	11198-10	1202
		182				-	540	1820	1633	836	1,31	51,68	9,07	-	1211	11198-01	1393
		202				-	540	2020	1764	903	1,31	57,23	10,00	-	1257	11198-02	1446
		222				-	540	2220	1893	995	1,26	62,73	11,00	-	1342	-	1543
198	064	122	XX	YY	00	-	640	1220	1437	732	1,32	38,17	7,02	-	1084	-	1247
		182				-	640	1820	1935	991	1,31	61,14	10,86	-	1257	11198-03	1446
		202				-	640	2020	2091	1071	1,31	67,72	12,00	-	1315	11198-04	1512
		222				-	640	2220	2243	1160	1,29	74,07	13,10	-	1401	-	1611
198	074	182	XX	YY	00	-	740	1820	2237	1146	1,31	70,60	12,65	-	1315	11198-11	1512
		202				-	740	2020	2417	1238	1,31	78,20	14,00	-	1372	11198-05	1578
		222				-	740	2220	2594	1322	1,32	85,40	15,20	-	1463	-	1682





Conform EN442-1: 2014: radiatoren en convectoren

* RAL 9016: geen meerprijs 15%

Voor meer details over onze artikel-data, zie artikel-database: <https://www.2ba.nl>

Voor de warmteafgiftes van andere regimes, kijkt u op p. 370 (correctiefactoren)
NEDERLAND. Prijzen in euro (excl. BTW)

PRIJSGROEP: VPG10 - ACC.

BEVESTIGINGEN		HOOGTE RADIATOR	KLEUR	ART. NR.
		N1L1 / N1L1-ES / NS1L1*		
MUURBEVESTIGING		1220 mm	S600	1187 104 1100 0600
		1820 mm	S600	1187 104 1700 0600
		2020 mm	S600	1187 104 1900 0600
		2220 mm	S600	1187 104 2100 0600
		N2L1 / N2L1-ES / NS2L1		
MUURBEVESTIGING		1220 mm	S600	1187 105 1100 0600
		1820 mm	S600	1187 105 1700 0600
		2020 mm	S600	1187 105 1900 0600
		2220 mm	S600	1187 105 2100 0600
		NH1L1		
MUURBEVESTIGING		450 mm	S600	1187 102 0400 0600
		550 mm	S600	1187 102 0500 0600
		650 mm	S600	1187 102 0600 0600
		950 mm	S600	1187 102 0900 0600
		NH2L1 / NH2L2		
MUURBEVESTIGING		550 mm	S600	1187 103 0500 0600
		650 mm	S600	1187 103 0600 0600
		950 mm	S600	1187 103 0900 0600

Prijzen: zie prijslijst "spare parts"

* niet beschikbaar voor NS1L1 met geïntegreerd ventiel

PRIJSGROEP: VPG10B - HANDDOEKBEUGELS





ACCESSOIRES	BREEDTE HANDDOEKBEUGEL	KLEUR	ART. NR.	€
N1L1 / N2L1 / N1L1-ES / N2L1-ES / NS1L1 / NS2L1				
HANDDOEKBEUGEL MULTI+ RECHTS	600 mm	S600	1183 734 0000 0600	218
	600 mm	RAL 9005 ^S	1183 734 0000 9005	218
<ul style="list-style-type: none"> h = 70 mm; b = 600 mm (b tablet = 194 mm); e = 176 mm; c = 170 mm; Bevestiging aan de muur, rechts van de radiator. 				
N1L1 / N2L1 / N1L1-ES / N2L1-ES / NS1L1 / NS2L1				
HANDDOEKBEUGEL MULTI+ LINKS	600 mm	S600	1183 735 0000 0600	218
	600 mm	RAL 9005 ^S	1183 735 0000 9005	218
<ul style="list-style-type: none"> h = 70 mm; b = 600 mm (b tablet = 194 mm); e = 176 mm; c = 170 mm; Bevestiging aan de muur, links van de radiator. 				
N1L1 / N1L1-ES / NS1L1				
KORTE BEUGEL	240 mm	S600	1183 710 0000 0600	145
	240 mm	RAL 9005 ^S	1183 710 0000 9005	145
N2L1 / N2L1-ES / NS2L1				
KORTE BEUGEL	240 mm	S600	1183 720 0000 0600	145
	240 mm	RAL 9005 ^S	1183 720 0000 9005	145
<ul style="list-style-type: none"> N1L1 / N1L1-ES: d = 66,5 mm; a = 56,5 mm NS1L1: d = 68 mm; a = 58 mm N2L1 / N2L1-ES: d = 59,5 mm; a = 49,5 mm NS2L1: d = 58 mm; a = 48 mm 				
N1L1 / N1L1-ES / NS1L1				
LANGE BEUGEL	440 mm	S600	1183 711 0000 0600	145
	440 mm	RAL 9005 ^S	1183 711 0000 9005	145
N2L1 / N2L1-ES / NS2L1				
LANGE BEUGEL	440 mm	S600	1183 721 0000 0600	145
	440 mm	RAL 9005 ^S	1183 721 0000 9005	145
<ul style="list-style-type: none"> N1L1 / N1L1-ES: d = 66,5 mm; a = 56,5 mm NS1L1: d = 68 mm; a = 58 mm N2L1 / N2L1-ES: d = 59,5 mm; a = 49,5 mm NS2L1: d = 58 mm; a = 48 mm 				

^S structuur zwart

Montagevoorschriften accessoires: zie www.vasco.eu
 NEDERLAND. Prijzen in euro (excl. BTW)

e = afstand voorkant accessoire tot wand
 d = afstand voorkant accessoire tot voorkant radiator
 c = afstand wand tot achterkant beugel
 a = afstand accessoire tot radiator
uit voorraad leverbaar

PRIJSGROEP: VPG10B - HANDDOEKBEUGELS

ACCESSOIRES	BREEDTE HANDDOEKBEUGEL	KLEUR	ART. NR.	€
HANDDOEKBEUGEL 	N1L1 / N1L1-ES / NS1L1			
	372 mm	ALUMINIUM	1183 239 0000 0000	201
	372 mm	CHROOM	1183 239 0000 0099	201
	372 mm	RAL 9005 ^{mat}	1183 239 0000 9005	201
	526 mm	CHROOM	1183 271 0000 0099	201
	526 mm	S600	1183 271 0000 0600	201
	526 mm	RAL 9005 ^{mat}	1183 271 0000 9005	201
<ul style="list-style-type: none"> Handdoekbeugel in geanodiseerd aluminium h = 55 mm; b = 372, 526 mm; d = 56 mm; a = 50 mm; 				
HANDDOEKBEUGEL 	N2L1 / N2L1-ES / NS2L1			
	372 mm	ALUMINIUM	1183 240 0000 0000	201
	372 mm	CHROOM	1183 240 0000 0099	201
	372 mm	S600	1183 240 0000 0600	201
	372 mm	RAL 9005 ^{mat}	1183 240 0000 9005	201
	526 mm	CHROOM	1183 272 0000 0099	201
	526 mm	S600	1183 272 0000 0600	201
526 mm	RAL 9005 ^{mat}	1183 272 0000 9005	201	
<ul style="list-style-type: none"> Handdoekbeugel in geanodiseerd aluminium h = 55 mm; b = 372, 526 mm; d = 56 mm; a = 50 mm; 				
HANDDOEKBEUGEL 	BREEDTE RADIATOR	KLEUR	ART. NR.	€
	N1L1 / N1L1-ES			
	420 mm	CHROOM	1183 213 0000 0099	201
	520 mm	CHROOM	1183 214 0000 0099	201
	520 mm	INOX/RVS	1183 214 0000 9993	201
	620 mm	CHROOM	1183 215 0000 0099	201
	620 mm	INOX/RVS	1183 215 0000 9993	201
720 mm	CHROOM	1183 216 0000 0099	201	
<ul style="list-style-type: none"> h = 25 mm; b = 440, 540, 640, 740 mm; d = 73 mm; a = 57 mm 				
HANDDOEKBEUGEL 	N2L1 / N2L1-ES			
	420 mm	CHROOM	1183 218 0000 0099	201
	520 mm	CHROOM	1183 219 0000 0099	201
	620 mm	CHROOM	1183 220 0000 0099	201
	720 mm	CHROOM	1183 221 0000 0099	201
<ul style="list-style-type: none"> h = 25 mm; b = 440, 540, 640, 740 mm; d = 73 mm; a = 57 mm 				
HANDDOEKBEUGEL 	NH1L1 / NH2L1 / NH2L2			
		CHROOM	1183 217 0000 0099	201
<ul style="list-style-type: none"> h = 25 mm; b = 740 mm (zelf in te korten); d = 73 mm; a = 57 mm 				

^{mat} mat zwart

Montagevoorschriften accessoires: zie www.vasco.eu
NEDERLAND. Prijzen in euro (excl. BTW)

d = afstand voorkant accessoire tot voorkant radiator
a = afstand accessoire tot radiator
uit voorraad leverbaar

NIVA LAK VERTICAAL: N1L1 / N2L1

NIVA INOX VERTICAAL: N1L1-ES / N2L1-ES

NIVA SOFT VERTICAAL: NS1L1 / NS2L1 (zonder geïntegreerd ventiel)

NIVA MIXED HYBRIDE: N1L1-EL-MIX

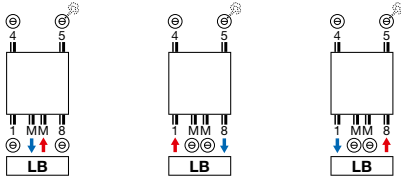

- **Opmerking: MM met aanvoer rechts.**

NIVA SOFT VERTICAAL: NS2L1

GEÏNTEGREERD VENTIEL

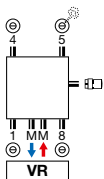

- **Meerprijs: €172 (zie p. 363)**
- **Opmerking: MM met aanvoer rechts (op deze aansluiting bevindt zich op de achterzijde een stijgbuis).**

NIVA LAK HORIZONTAAL: NH1L1 / NH2L1 / NH2L2

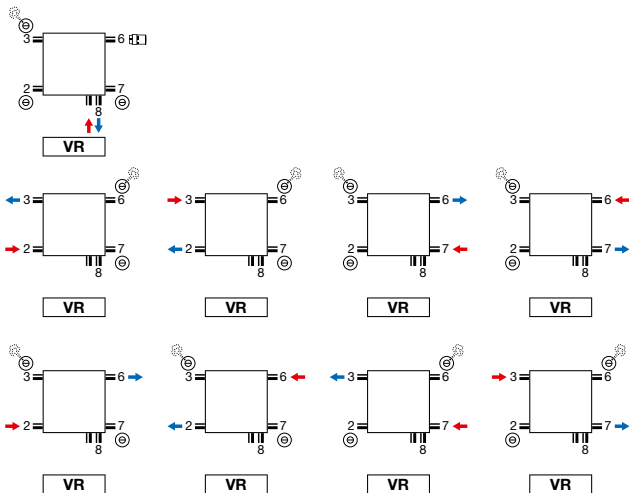

- **Geïntegreerd ventiel: geen meerprijs (zie p. 363)**
- **Thermostaatkop enkel te gebruiken bij aansluiting op het ventiel (aanvoer links, retour rechts). Andere aansluitingen, vb. SL, thermostaatkop uit de aansluiting 6 nemen. Hier is wel de mogelijkheid om aanvoer en retour te wisselen.**

Opmerking: het aansluiten van de radiator kan enkel volgens de getoonde aansluiticonen. Voor elke andere aansluitwijze nemen wij geen verantwoordelijkheid.

NIVA LAK VERTICAAL (N1L1, N2L1)

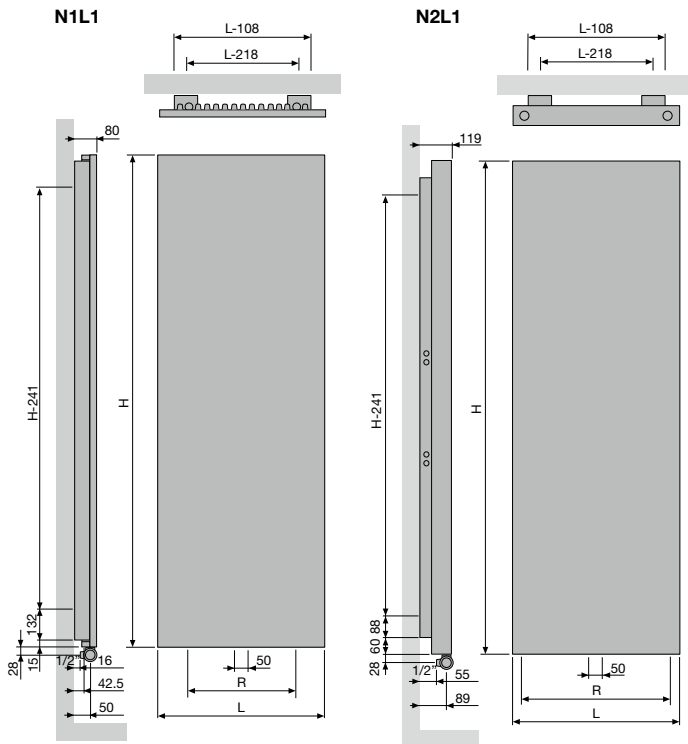

N1L1				
Breedte (L)	420	520	620	720
Hartafstand tussen de onderaansluitingen 18 (R)	200	300	400	500
Hartafstand tussen de ophangingen	L-218	H-241		

N2L1				
Breedte (L)	420	520	620	720
Hartafstand tussen de onderaansluitingen 18 (R)	338	438	538	638
Hartafstand tussen de ophangingen	L-218	H-241		

NIVA INOX VERTICAAL (N1L1-ES, N2L1-ES)

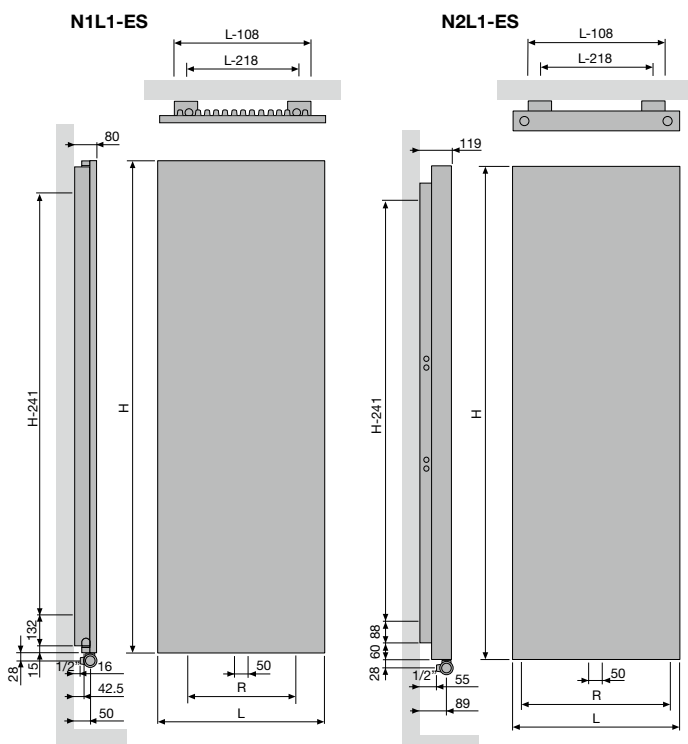

N1L1-ES				
Breedte (L)	520	620		
Hartafstand tussen de onderaansluitingen 18 (R)	300	400		
Hartafstand tussen de ophangingen	L-218	H-241		

N2L1-ES				
Breedte (L)	520	620		
Hartafstand tussen de onderaansluitingen 18 (R)	438	538		
Hartafstand tussen de ophangingen	L-218	H-241		

NIVA LAK HORIZONTAAL (NH1L1, NH2L1)

NH1L1 / NH2L1

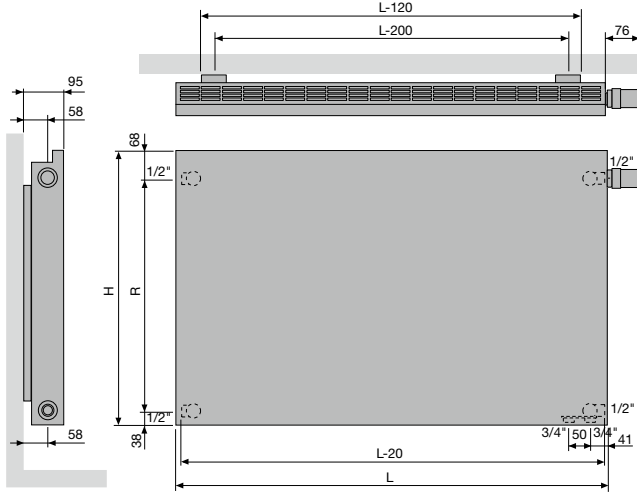

NH1L1				
Hoogte (H)	450	550	650	950
Hartafstand tussen de zijaansluitingen SL/SR (R)	343	443	543	843
Hartafstand tussen de ophangingen	L-200			

NH2L1				
Hoogte (H)	550	650	950	
Hartafstand tussen de zijaansluitingen SL/SR (R)	443	543	843	
Hartafstand tussen de ophangingen	L-200			

NIVA LAK HORIZONTAAL (NH2L2)

NH2L2

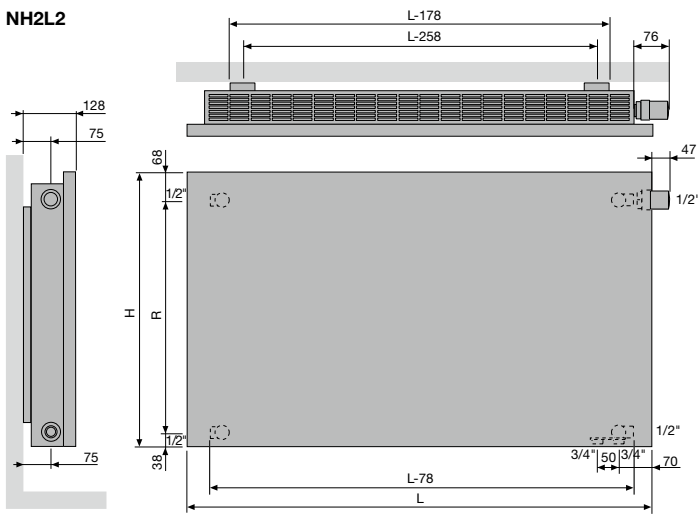

NH2L2				
Hoogte (H)	550	650	950	
Hartafstand tussen de zijaansluitingen SL/SR (R)	443	543	843	
Hartafstand tussen de ophangingen	L-258			

NIVA SOFT VERTICAAL (NS1L1)

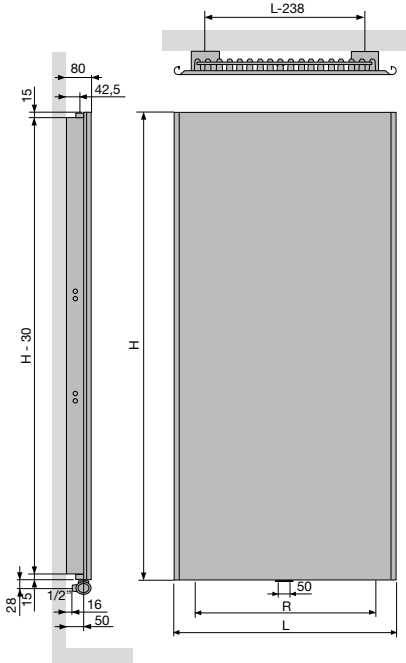

NS1L1				
Breedte (L)	440	540	640	740
Hartafstand tussen de onderaansluitingen 18 (R)	200	300	400	500
Hartafstand tussen de ophangingen	L-238	H-241		

NIVA SOFT VERTICAAL (NS2L1)

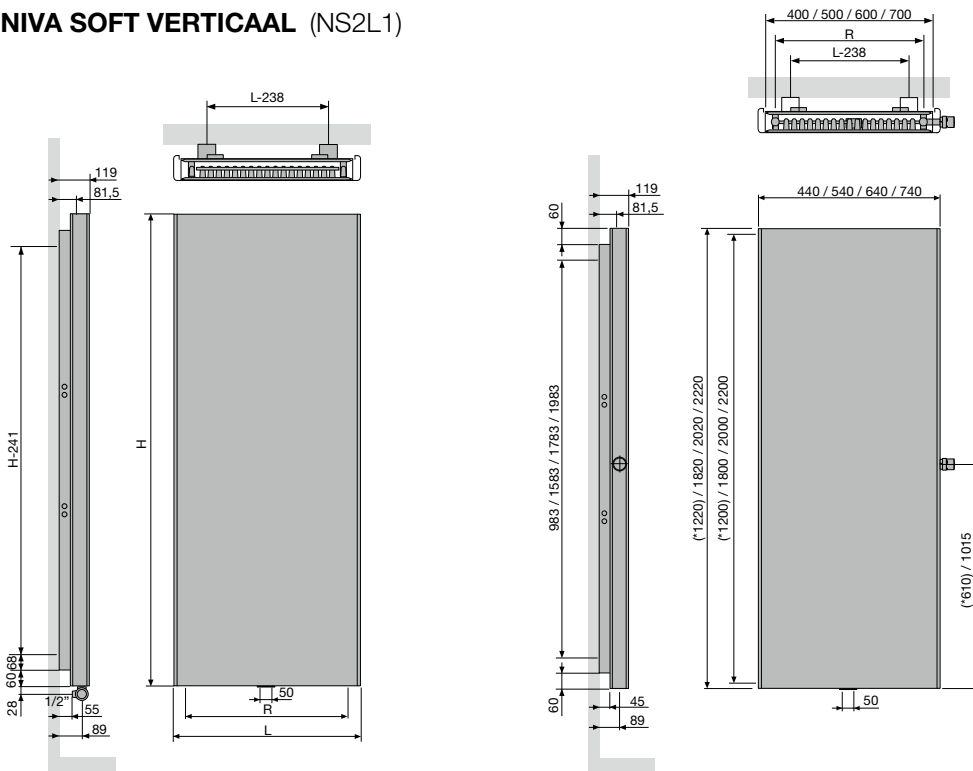

NS2L1				
Breedte (L)	440	540	640	740
Hartafstand tussen de onderaansluitingen 18 (R)	338	438	538	638
Hartafstand tussen de ophangingen	L-238	H-241		



TYPES

- Verticaal: Carré Plus (CPVN-PLUS)

BUIZEN

- Verticaal, vierkant 25 x 25 mm

COLLECTOREN

- Horizontaal, rond Ø 35 mm

KLEUREN

- Standaardkleur wit RAL 9016
- Uitgebreide kleurenkaart zie p. 12

BEVESTIGINGEN

- Muurbevestigingen standaard

TECHNISCH

- Weerstandsgelast (onzichtbare lasnaden)
- ATL-grondlaag, poedercoating
- Standaardwerkdruk: 10 bar
- Maximale bedrijfstemperatuur: 110°C

ELEKTRISCH

- ✗ Zuiver elektrische radiator in de fabriek vorgevuld
- ✗ Gemengde radiator

TECHNISCHE TEKENINGEN

- Zie p. 203

AANSLUITING

- ✗ Eénpuntsaansluiting voor éénpijpssysteem
- ✗ Eénpuntsaansluiting voor tweepijpssysteem
- ✓ Tweepuntsaansluiting voor éénpijpssysteem (aansluiting via de middenaansluiting) (zie p. 362)
- ✓ Tweepuntsaansluiting voor tweepijpssysteem (standaard) (zie p. 362)
- ✗ Geïntegreerd ventiel
- Aansluitingen: ½" (binnendraad)

CARRÉ PLUS VERTICAAL

Minimale tussenruimte, maximaal effect

Een icoon in de wereld van de designradiatoren. Speciaal voor de Carré ontwikkelde VASCO een heel nieuw type buis met scherpe hoeken voor een strakker design en met een optimaal warmterendement bij een minimale tussenruimte. De vlakke look creëert een gevoel van rust, versterkt door de weggewerkte, mooi in het geheel geïntegreerde collector. Een veel gelauwerde designradiator, waarvoor VASCO, zoals steeds, ook de passende accessoires ontwikkelde.

AANBEVOLEN AANSLUITING (LB)

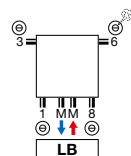

Andere aansluitmogelijkheden, zie p. 202



art. nr. 1182 103 0000 0099
prijs € 190
 Koppelingen, zie p. 377

AANBEVOLEN VOOR BADKAMER EN KEUKEN IN OPTIE



handdoekbeugel recht (chrom) art. nr. zie p. 201
prijs € 201

Andere accessoires, zie p. 201



HOE CARRÉ PLUS VERTICAAL BESTELLEN

Leveringstermijn 15 - 30 werkdagen
(zonder transportduur)

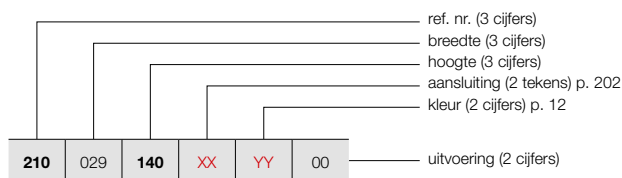

CARRÉ PLUS VERTICAAL (CPVN-PLUS)



CPVN-PLUS

HOE VOORRAADRADIATOR CARRÉ PLUS VERTICAAL BESTELLEN

Leveringstermijn 5 werkdagen
(zonder transportduur)

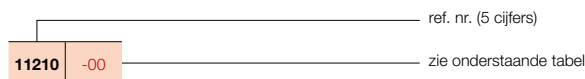

PRIJSGROEP: VPG2 - STAAL DESIGNRADIATOREN

BESTELCODE MAATWERK CARRÉ PLUS VERTICAAL	TECHNISCHE GEGEVENS							STANDAARDKLEUR		ANDERE KLEUREN		
	buizen	breedte (L mm)	hoogte (H mm)	75/65/20 (Watt) (Φ50K)	55/45/20 (Watt) (Φ30K)	n-exp.	gewicht (kg)	inhoud (l)	el. weerst. (Watt)		prijs RAL 9016 (€)	verkorte ref. nr. RAL 9016 voorraad
REF. NR. CARRÉ PLUS VERTICAAL CPVN-PLUS : 210												
210 029 140 XX YY 00	10	295	1400	871	443	1,31	19,70	8,40	-	572	-	658
	10	295	1600	986	505	1,31	21,60	9,40	-	623	-	716
	10	295	1800	1097	559	1,32	23,60	10,50	-	675	-	776
	10	295	2000	1206	614	1,32	26,20	12,00	-	726	-	835
	10	295	2200	1312	672	1,31	28,90	13,50	-	774	-	890
	10	295	2200	1312	672	1,31	28,90	13,50	-	774	-	890
210 035 140 XX YY 00	12	355	1400	1026	521	1,31	23,16	10,08	-	680	-	782
	12	355	1600	1161	595	1,31	25,44	11,28	-	750	-	863
	12	355	1800	1293	659	1,32	27,72	12,48	-	812	11210-16	934
	12	355	2000	1421	724	1,32	30,96	14,40	-	874	-	1005
	12	355	2200	1545	791	1,31	34,08	16,20	-	930	-	1070
210 041 140 XX YY 00	14	415	1400	1179	599	1,31	26,46	11,76	-	796	-	915
	14	415	1600	1334	683	1,31	29,12	13,16	-	875	-	1006
	14	415	1800	1485	757	1,32	31,64	14,56	-	943	-	1084
	14	415	2000	1632	836	1,31	35,42	16,66	-	1019	11210-05	1172
	14	415	2200	1775	909	1,31	39,20	18,90	-	1087	-	1250
210 047 140 XX YY 00	16	475	1400	1330	676	1,31	29,60	13,28	-	913	-	1050
	16	475	1600	1505	771	1,31	32,48	14,88	-	1000	-	1150
	16	475	1800	1675	853	1,32	35,52	16,48	-	1082	-	1244
	16	475	2000	1841	943	1,31	39,84	19,04	-	1163	-	1337
	16	475	2200	2002	1025	1,31	44,00	21,60	-	1243	-	1429
210 053 140 XX YY 00	18	535	1400	1478	751	1,31	32,58	14,94	-	1023	-	1176
	18	535	1600	1673	857	1,31	35,82	16,74	-	1122	-	1290
	18	535	1800	1862	954	1,31	39,06	18,54	-	1214	11210-07	1396
	18	535	2000	2046	1048	1,31	43,92	21,42	-	1309	11210-09	1505
	18	535	2200	2226	1140	1,31	48,78	24,30	-	1397	-	1607
210 059 140 XX YY 00	20	595	1400	1625	826	1,31	35,20	16,60	-	1138	-	1309
	20	595	1600	1839	942	1,31	39,00	18,60	-	1247	-	1434
	20	595	1800	2047	1048	1,31	42,60	20,40	-	1349	11210-11	1551
	20	595	2000	2250	1152	1,31	48,00	23,60	-	1453	11210-12	1671
	20	595	2200	2447	1260	1,30	53,40	27,00	-	1550	-	1783
210 065 140 XX YY 00	22	655	1400	1771	900	1,31	37,84	18,26	-	1252	-	1440
	22	655	1600	2004	1026	1,31	41,80	20,24	-	1373	-	1579
	22	655	1800	2231	1143	1,31	45,76	22,44	-	1489	-	1712
	22	655	2000	2451	1255	1,31	51,70	25,96	-	1598	-	1838
	22	655	2200	2666	1372	1,30	57,64	29,48	-	1706	-	1962
210 071 140 XX YY 00	24	715	1400	1915	973	1,31	40,32	19,68	-	1366	-	1571
	24	715	1600	2167	1110	1,31	44,64	22,08	-	1496	-	1720
	24	715	1800	2412	1235	1,31	48,96	24,24	-	1623	-	1866
	24	715	2000	2651	1365	1,30	55,44	28,32	-	1744	-	2006
	24	715	2200	2883	1484	1,30	61,92	32,16	-	1862	-	2141

Conform EN442-1: 2014: radiatoren en convectoren

Voor meer details over onze artikel-data, zie artikel-database: <https://www.2ba.nl>

Voor de warmteafgiftes van andere regimes, kijkt u op p. 370 (correctiefactoren)
NEDERLAND. Prijzen in euro (excl. BTW)

CARRÉ PLUS VERTICAAL (CPVN-PLUS)



CPVN-PLUS

HOE CARRÉ PLUS VERTICAAL BESTELLEN

Leveringstermijn 15 - 30 werkdagen
(zonder transportduur)

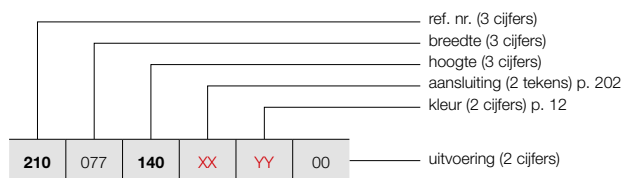

PRIJSGROEP: VPG2 - STAAL DESIGNRADIATOREN

BESTELCODE MAATWERK CARRÉ PLUS VERTICAAL	TECHNISCHE GEGEVENS									STANDAARDKLEUR	ANDERE KLEUREN
	buizen	breedte (L mm)	hoogte (H mm)	75/65/20 (Watt) (Φ50K)	55/45/20 (Watt) (Φ30K)	n-exp.	gewicht (kg)	inhoud (l)	el. weerst. (Watt)	prijs RAL 9016 (€)	prijs kleur (€)
REF. NR. CARRÉ PLUS VERTICAAL CPVN-PLUS : 210											
210	077	140	XX	YY	00						
		160								1481	1703
		180								1623	1866
		200								1759	2023
		220								1892	2176
										2017	2320
210	089	140	XX	YY	00						
		160								1706	1962
		180								1870	2151
		200								2028	2332
		220								2179	2506
										2326	2675

Conform EN442-1: 2014: radiatoren en convectoren

Voor meer details over onze artikel-data, zie artikel-database: <https://www.2ba.nl>

Voor de warmteafgifte van andere regimes, kijkt u op p. 370 (correctiefactoren)
NEDERLAND. Prijzen in euro (excl. BTW)

TYPES

- Twee rijen buizen (CPVN2-ZB)

BUIZEN

- Verticaal, vierkant 25 x 25 mm

COLLECTOREN

- Horizontaal, rond Ø 35 mm

KLEUREN

- Standaardkleur wit RAL 9016
- Uitgebreide kleurenkaart zie p. 12

BEVESTIGINGEN

- Muurbevestigingen in de kleur RAL 9016 standaard. Ook in optie verkrijgbaar in de kleur RAL 7016 (zie p. 201).

TECHNISCH

- Weerstandsgelast (onzichtbare lasnaden)
- ATL-grondlaag, poedercoating
- Standaardwerkdruk: 10 bar
- Maximale bedrijfstemperatuur: 110°C

ELEKTRISCH

- ✗ Zuiver elektrische radiator in de fabriek vorgevuld
- ✗ Gemengde radiator

TECHNISCHE TEKENINGEN

- Zie p. 203

AANSLUITING

- ✗ Eénpuntsaansluiting voor éénpijpsysteem
- ✗ Eénpuntsaansluiting voor tweepijpsysteem
- ✓ Tweepuntsaansluiting voor éénpijpsysteem (aansluiting via de middenaansluiting) (zie p. 362)
- ✓ Tweepuntsaansluiting voor tweepijpsysteem (standaard) (zie p. 362)
- ✗ Geïntegreerd ventiel
- Aansluitingen: ½" (binnendraad)

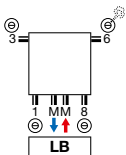
**AANBEVOLEN AANSLUITING (LB)**

Andere aansluitmogelijkheden, zie p. 202



art. nr. 1182 103 0000 0099

prijs € 190

Koppelingen, zie p. 377

**AANBEVOLEN VOOR BADKAMER EN KEUKEN
IN OPTIE**

handdoekbeugel recht (chrom) art. nr. zie p. 201

prijs € 201

Andere accessoires, zie p. 201

CARRÉ VERTICAAL**Topdesign met dubbele
warmtecapaciteit**

De strakke, vlakke look van de Carré Plus, voorzien van een dubbele buizenrij voor een maximale warmteafgifte. De Carré Verticaal designradiator blijft in alles zijn tijdloze, functionele zelf, maar garandeert door die extra capaciteit ook in grotere ruimten een optimaal rendement.



CARRÉ VERTICAAL (CPVN2-ZB)



CPVN2-ZB

HOE CARRÉ VERTICAAL BESTELLEN

Leveringstermijn 15 - 30 werkdagen
(zonder transportduur)

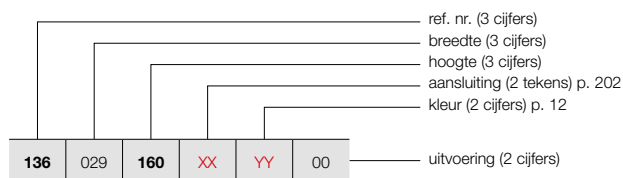

PRIJSGROEP: VPG2 - STAAL DESIGNRADIATOREN

BESTELCODE MAATWERK CARRÉ VERTICAAL	TECHNISCHE GEGEVENS									STANDAARDKLEUR	ANDERE KLEUREN
	buizen	breedte (L mm)	hoogte (H mm)	75/65/20 (Watt) (Ø50K)	55/45/20 (Watt) (Ø30K)	n-exp.	gewicht (kg)	inhoud (l)	el. weerst. (Watt)	prijs RAL 9016 (€)	prijs kleur (€)
REF. NR. CARRÉ VERTICAAL CPVN2-ZB : 136											
136	029	160	XX	YY	00						
		180								1000	1150
		200								1081	1243
		220								1165	1340
		240								1243	1429
		260								1318	1516
		280								1393	1602
		300								1463	1682
										1536	1766
136	035	160	XX	YY	00						
		180								1198	1378
		200								1298	1493
		220								1395	1604
		240								1490	1714
		260								1582	1819
		280								1670	1921
		300								1759	2023
										1847	2124
136	041	160	XX	YY	00						
		180								1400	1610
		200								1512	1739
		220								1629	1873
		240								1740	2001
		260								1847	2124
		280								1949	2241
		300								2051	2359
										2151	2474
136	047	160	XX	YY	00						
		180								1596	1835
		200								1729	1988
		220								1860	2139
		240								1984	2282
		260								2106	2422
		280								2229	2563
		300								2342	2693
										2454	2822
136	053	160	XX	YY	00						
		180								1794	2063
		200								1947	2239
		220								2091	2405
		240								2234	2569
		260								2370	2726
		280								2503	2878
		300								2634	3029
										2764	3179

Conform EN442-1: 2014: radiatoren en convectoren

Voor meer details over onze artikel-data, zie artikel-database: <https://www.2ba.nl>

Voor de warmteafgifte van andere regimes, kijkt u op p. 370 (correctiefactoren)
NEDERLAND. Prijzen in euro (excl. BTW)

HOE CARRÉ VERTICAAL BESTELLEN

Leveringstermijn 15 - 30 werkdagen
(zonder transportduur)

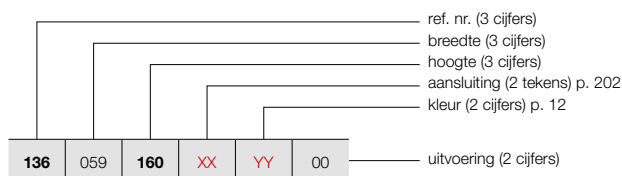

CARRÉ VERTICAAL (CPVN2-ZB)

193



CPVN2-ZB

PRIJSGROEP: VPG2 - STAAL DESIGNRADIATOREN

BESTELCODE MAATWERK CARRÉ VERTICAAL	TECHNISCHE GEGEVENS							STANDAARDKLEUR		ANDERE KLEUREN						
	buizen	breedte (L mm)	hoogte (H mm)	75/65/20 (Watt) (Φ50K)	55/45/20 (Watt) (Φ30K)	n-exp.	gewicht (kg)	inhoud (l)	el. weerst. (Watt)	prijs RAL 9016 (€)	prijs kleur (€)					
REF. NR. CARRÉ VERTICAAL CPVN2-ZB : 136																
136	059	160	XX	YY	00	20	595	1600	2125	1066	1,35	60,40	31,60	-	1994	2293
		180				20	595	1800	2348	1178	1,35	67,60	35,80	-	2163	2487
		200				20	595	2000	2557	1283	1,35	74,60	40,20	-	2325	2674
		220				20	595	2200	2754	1382	1,35	81,20	42,60	-	2484	2857
		240				20	595	2400	2938	1474	1,35	87,60	45,20	-	2632	3027
		260				20	595	2600	3110	1561	1,35	94,20	47,80	-	2786	3204
		280				20	595	2800	3269	1640	1,35	100,60	50,20	-	2931	3371
		300				20	595	3000	3417	1715	1,35	107,20	52,80	-	3071	3532
136	065	160	XX	YY	00	22	655	1600	2337	1173	1,35	66,44	34,76	-	2193	2522
		180				22	655	1800	2582	1296	1,35	74,36	39,38	-	2379	2736
		200				22	655	2000	2812	1411	1,35	82,06	44,22	-	2556	2939
		220				22	655	2200	3029	1520	1,35	89,32	46,86	-	2734	3144
		240				22	655	2400	3232	1622	1,35	96,36	49,72	-	2899	3334
		260				22	655	2600	3421	1717	1,35	103,62	52,58	-	3060	3519
		280				22	655	2800	3596	1804	1,35	110,66	55,22	-	3222	3705
		300				22	655	3000	3759	1886	1,35	117,92	58,08	-	3378	3885
136	071	160	XX	YY	00	24	715	1600	2550	1280	1,35	72,48	37,92	-	2394	2753
		180				24	715	1800	2817	1413	1,35	81,12	42,96	-	2593	2982
		200				24	715	2000	3069	1540	1,35	89,52	48,24	-	2791	3210
		220				24	715	2200	3305	1658	1,35	97,44	51,12	-	2977	3424
		240				24	715	2400	3526	1769	1,35	105,12	54,24	-	3160	3634
		260				24	715	2600	3732	1873	1,35	113,04	57,36	-	3343	3844
		280				24	715	2800	3923	1968	1,35	120,72	60,24	-	3515	4042
		300				24	715	3000	4101	2058	1,35	128,64	63,36	-	3685	4238
136	077	160	XX	YY	00	26	775	1600	2762	1386	1,35	78,52	41,08	-	2593	2982
		180				26	775	1800	3052	1531	1,35	87,88	46,54	-	2810	3232
		200				26	775	2000	3324	1668	1,35	96,98	52,26	-	3023	3476
		220				26	775	2200	3580	1796	1,35	105,56	55,38	-	3226	3710
		240				26	775	2400	3820	1917	1,35	113,88	58,76	-	3429	3943
		260				26	775	2600	4043	2029	1,35	122,46	62,14	-	3620	4163
		280				26	775	2800	4250	2133	1,35	130,78	65,26	-	3808	4379
		300				26	775	3000	4442	2229	1,35	139,36	68,64	-	3991	4590
136	089	160	XX	YY	00	30	895	1600	3187	1599	1,35	90,60	47,40	-	2993	3442
		180				30	895	1800	3521	1767	1,35	101,40	53,70	-	3243	3729
		200				30	895	2000	3836	1925	1,35	111,90	60,30	-	3489	4012
		220				30	895	2200	4131	2073	1,35	121,80	63,90	-	3722	4280
		240				30	895	2400	4407	2211	1,35	131,40	67,80	-	3954	4547
		260				30	895	2600	4665	2341	1,35	141,30	71,70	-	4176	4802

Conform EN442-1: 2014: radiatoren en convectoren

Voor meer details over onze artikel-data, zie artikel-database: <https://www.2ba.nl>
Voor de warmteafgiftes van andere regimes, kijkt u op p. 370 (correctiefactoren)
NETERLAND. Prijzen in euro (excl. BTW)

CARRÉ HORIZONTAAL (CPHN1-RO, CPHN2-RO)



TYPES

- Eén (CPHN1-RO) of twee rijen buizen (CPHN2-RO)

BUIZEN

- Horizontaal, vierkant 25 x 25 mm

COLLECTOREN

- Verticaal, rond Ø 35 mm

KLEUREN

- Standaardkleur wit RAL 9016
- Uitgebreide kleurenkaart zie p. 12

SPECIAAL

- CPHN1-RO ook verkrijgbaar als toiletradiator (600 x 415 mm)

BEVESTIGINGEN

- Muurbevestigingen in de kleur RAL 9016 standaard. Ook in optie verkrijgbaar in de kleur RAL 7016 (zie p. 201).

TECHNISCH

- Weerstandsgelast (onzichtbare lasnaden)
- ATL-grondlaag, poedercoating
- Standaardwerkdruk: 10 bar
- Maximale bedrijfstemperatuur: 110°C

ELEKTRISCH

- ✗ Zuiver elektrische radiator in de fabriek voorgevuld
- ✗ Gemengde radiator

TECHNISCHE TEKENINGEN

- Zie p. 204

AANSLUITING

- ✗ Eénpuntsaansluiting voor éénpijpsysteem
- ✗ Eénpuntsaansluiting voor tweepijpsysteem
- ✗ Tweepuntsaansluiting voor éénpijpsysteem
- ✓ Tweepuntsaansluiting voor tweepijpsysteem (standaard) (zie p. 362)
- ✗ Geïntegreerd ventiel
- Aansluitingen: ½" (binnendraad)

CARRÉ HORIZONTAAL

Topdesign voor elke warmtebehoefte

De horizontale versie van de Carré, met keuze uit één of twee buizenrijen voor een warmteafgifte op maat in elke ruimte. Een designradiator die ook in de horizontale uitvoering uitblinkt door zijn strak design en zijn vlakke look, nog versterkt door de in het geheel geïntegreerde collector.

AANBEVOLEN AANSLUITING (18)

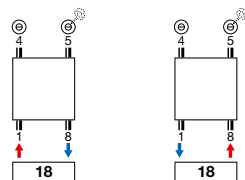

Andere aansluitmogelijkheden, zie p. 202



art. nr. 1182 101 0000 0099

prijs € 234

Koppelingen, zie p. 377

AANBEVOLEN VOOR BADKAMER EN KEUKEN IN OPTIE



handdoekbeugel recht (chrom) art. nr. zie p. 201

prijs € 201

Andere accessoires, zie p. 201



HOE CARRÉ HORIZONTAAL BESTELLEN

Leveringstermijn 15 - 30 werkdagen
(zonder transportduur)

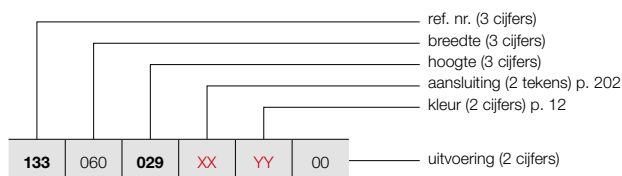

CARRÉ HORIZONTAAL (CPHN1-RO)

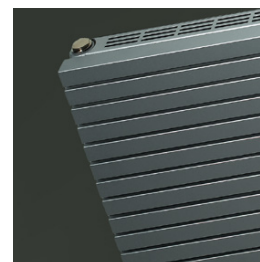

CPHN1-RO

PRIJSGROEP: VPG2 - STAAL DESIGNRADIATOREN

BESTELCODE MAATWERK CARRÉ HORIZONTAAL	TECHNISCHE GEGEVENS							STANDAARDKLEUR		ANDERE KLEUREN	
	buizen	breedte (L mm)	hoogte (H mm)	75/65/20 (Watt) (φ50K)	55/45/20 (Watt) (φ30K)	n-exp.	gewicht (kg)	inhoud (l)	el. weerst. (Watt)	prijs RAL 9016 (€)	prijs kleur (€)
REF. NR. CARRÉ HORIZONTAAL CPHN1-RO : 133											
133 060 029 XX YY 00	035	600	295	221	117	1,25	6,19	2,85	-	271	312
	041	600	355	259	137	1,25	7,41	3,60	-	327	376
	047	600	415	296	156	1,25	8,63	4,35	-	381	438
	053	600	475	333	176	1,25	9,86	5,10	-	435	500
	059	600	535	369	195	1,25	11,08	5,85	-	489	562
	065	600	595	404	213	1,25	12,30	6,60	-	547	629
	077	600	655	439	231	1,26	13,42	6,94	-	602	692
	089	600	775	507	266	1,26	15,67	7,63	-	710	817
		600	895	574	302	1,26	17,91	8,31	-	817	940
		600	895	574	302	1,26	17,91	8,31	-	817	940
133 080 029 XX YY 00	035	800	295	295	156	1,25	8,25	3,80	-	330	380
	041	800	355	346	183	1,25	9,88	4,80	-	399	459
	047	800	415	395	209	1,25	11,51	5,80	-	468	538
	053	800	475	444	234	1,25	13,14	6,80	-	529	608
	059	800	535	492	260	1,25	14,77	7,80	-	598	688
	065	800	595	538	284	1,25	16,40	8,80	-	666	766
	077	800	655	585	307	1,26	17,90	9,26	-	730	840
	089	800	775	676	355	1,26	20,89	10,17	-	862	991
		800	895	766	402	1,26	23,88	11,08	-	995	1144
		800	895	766	402	1,26	23,88	11,08	-	995	1144
133 100 029 XX YY 00	035	1000	295	369	195	1,25	10,31	4,75	-	389	447
	041	1000	355	432	228	1,25	12,35	6,00	-	468	538
	047	1000	415	494	261	1,25	14,39	7,25	-	541	622
	053	1000	475	555	293	1,25	16,43	8,50	-	620	713
	059	1000	535	615	325	1,25	18,46	9,75	-	696	800
	065	1000	595	673	355	1,25	20,50	11,00	-	773	889
	077	1000	655	731	384	1,26	22,37	11,57	-	850	978
	089	1000	775	845	444	1,26	26,11	12,71	-	1006	1157
		1000	895	957	503	1,26	29,85	13,85	-	1161	1335
		1000	895	957	503	1,26	29,85	13,85	-	1161	1335
133 120 029 XX YY 00	035	1200	295	443	234	1,25	12,37	5,70	-	438	504
	041	1200	355	518	274	1,25	14,82	7,20	-	524	603
	047	1200	415	593	313	1,25	17,27	8,70	-	612	704
	053	1200	475	666	352	1,25	19,72	10,20	-	703	808
	059	1200	535	738	390	1,25	22,15	11,70	-	790	909
	065	1200	595	808	427	1,25	24,60	13,20	-	877	1009
	077	1200	655	877	461	1,26	26,84	13,88	-	967	1112
	089	1200	775	1014	533	1,26	31,33	15,25	-	1141	1312
		1200	895	1148	603	1,26	35,82	16,62	-	1318	1516
		1200	895	1148	603	1,26	35,82	16,62	-	1318	1516
133 140 029 XX YY 00	035	1400	295	517	273	1,25	14,43	6,65	-	487	560
	041	1400	355	605	319	1,25	17,29	8,40	-	582	669
	047	1400	415	692	365	1,25	20,15	10,15	-	680	782
	053	1400	475	777	410	1,25	23,00	11,90	-	779	896
	059	1400	535	861	455	1,25	25,84	13,65	-	878	1010
	065	1400	595	942	497	1,25	28,70	15,40	-	977	1124
	077	1400	655	1023	537	1,26	31,32	16,20	-	1074	1235
	089	1400	775	1183	622	1,26	36,55	17,79	-	1271	1462
		1400	895	1340	704	1,26	41,79	19,39	-	1462	1681
		1400	895	1340	704	1,26	41,79	19,39	-	1462	1681

Conform EN442-1: 2014: radiatoren en convectoren

Voor meer details over onze artikel-data, zie artikel-database: <https://www.2ba.nl>

Voor de warmteafgiftes van andere regimes, kijkt u op p. 370 (correctiefactoren)
NETERLAND. Prijzen in euro (excl. BTW)

CARRÉ HORIZONTAAL (CPHN1-RO)



CPHN1-RO

HOE CARRÉ HORIZONTAAL BESTELLEN

Leveringstermijn 15 - 30 werkdagen
(zonder transportduur)

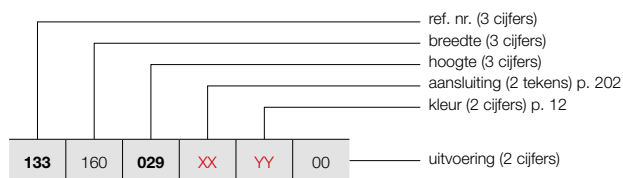

PRIJSGROEP: VPG2 - STAAL DESIGNRADIATOREN

BESTELCODE MAATWERK CARRÉ HORIZONTAAL							TECHNISCHE GEGEVENS					STANDAARDKLEUR	ANDERE KLEUREN			
buizen	breedte (L mm)	hoogte (H mm)	75/65/20 (Watt) (Φ50K)	55/45/20 (Watt) (Φ30K)	n-exp.	gewicht (kg)	inhoud (l)	el. weerst. (Watt)	prijs RAL 9016 (€)	prijs kleur (€)						
REF. NR. CARRÉ HORIZONTAAL CPHN1-RO : 133																
133	160	029	XX	YY	00	10	1600	295	590	312	1,25	16,50	7,60	-	532	612
		035				12	1600	355	691	365	1,25	19,76	9,60	-	642	738
		041				14	1600	415	790	417	1,25	23,02	11,60	-	750	863
		047				16	1600	475	888	469	1,25	26,29	13,60	-	854	982
		053				18	1600	535	984	520	1,25	29,54	15,60	-	963	1107
		059				20	1600	595	1077	569	1,25	32,80	17,60	-	1068	1228
		065				22	1600	655	1170	615	1,26	35,79	18,51	-	1174	1350
		077				26	1600	775	1352	710	1,26	41,78	20,34	-	1389	1597
		089				30	1600	895	1531	804	1,26	47,76	22,16	-	1602	1842
133	180	029	XX	YY	00	10	1800	295	664	351	1,25	18,56	8,55	-	579	666
		035				12	1800	355	778	411	1,25	22,23	10,80	-	695	799
		041				14	1800	415	889	469	1,25	25,90	13,05	-	812	934
		047				16	1800	475	999	528	1,25	29,57	15,30	-	927	1066
		053				18	1800	535	1107	585	1,25	33,23	17,55	-	1045	1202
		059				20	1800	595	1211	639	1,25	36,90	19,80	-	1158	1332
		065				22	1800	655	1316	691	1,26	40,27	20,83	-	1276	1467
		077				26	1800	775	1521	799	1,26	47,00	22,88	-	1506	1732
		089				30	1800	895	1723	905	1,26	53,73	24,93	-	1740	2001
133	200	029	XX	YY	00	10	2000	295	738	390	1,25	20,62	9,50	-	623	716
		035				12	2000	355	864	456	1,25	24,70	12,00	-	750	863
		041				14	2000	415	988	522	1,25	28,78	14,50	-	874	1005
		047				16	2000	475	1110	586	1,25	32,86	17,00	-	995	1144
		053				18	2000	535	1230	650	1,25	36,92	19,50	-	1120	1288
		059				20	2000	595	1346	711	1,25	41,00	22,00	-	1247	1434
		065				22	2000	655	1462	768	1,26	44,74	23,14	-	1372	1578
		077				26	2000	775	1690	888	1,26	52,22	25,42	-	1619	1862
		089				30	2000	895	1914	1006	1,26	59,70	27,70	-	1866	2146
133	220	029	XX	YY	00	10	2200	295	812	429	1,25	22,68	10,45	-	666	766
		035				12	2200	355	950	502	1,25	27,17	13,20	-	798	918
		041				14	2200	415	1087	574	1,25	31,66	15,95	-	930	1070
		047				16	2200	475	1221	645	1,25	36,15	18,70	-	1065	1225
		053				18	2200	535	1353	714	1,25	40,61	21,45	-	1198	1378
		059				20	2200	595	1481	782	1,25	45,10	24,20	-	1332	1532
		065				22	2200	655	1608	845	1,26	49,21	25,45	-	1462	1681
		077				26	2200	775	1859	977	1,26	57,44	27,96	-	1728	1987
		089				30	2200	895	2105	1106	1,26	65,67	30,47	-	1994	2293
133	240	029	XX	YY	00	10	2400	295	886	468	1,25	24,74	11,40	-	706	812
		035				12	2400	355	1037	548	1,25	29,64	14,40	-	845	972
		041				14	2400	415	1186	626	1,25	34,54	17,40	-	988	1136
		047				16	2400	475	1332	703	1,25	39,43	20,40	-	1129	1298
		053				18	2400	535	1476	779	1,25	44,30	23,40	-	1272	1463
		059				20	2400	595	1615	853	1,25	49,20	26,40	-	1409	1620
		065				22	2400	655	1754	922	1,26	53,69	27,77	-	1550	1783
		077				26	2400	775	2028	1065	1,26	62,66	30,50	-	1833	2108
		089				30	2400	895	2297	1207	1,26	71,64	33,24	-	2118	2436

Conform EN442-1: 2014: radiatoren en convectoren

Voor meer details over onze artikel-data, zie artikel-database: <https://www.2ba.nl>

Voor de warmteafgiftes van andere regimes, kijkt u op p. 370 (correctiefactoren)
NEDERLAND. Prijzen in euro (excl. BTW)

HOE CARRÉ HORIZONTAAL BESTELLEN

Leveringstermijn 15 - 30 werkdagen
(zonder transportduur)

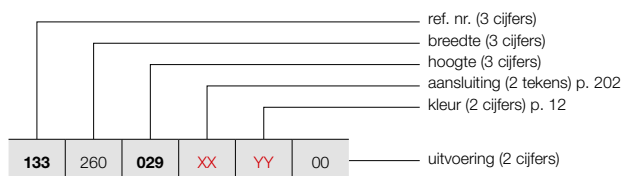

CARRÉ HORIZONTAAL (CPHN1-RO)

197



CPHN1-RO

PRIJSGROEP: VPG2 - STAAL DESIGNRADIATOREN

BESTELCODE MAATWERK CARRÉ HORIZONTAAL	TECHNISCHE GEGEVENS								STANDAARDKLEUR		ANDERE KLEUREN	
	buizen	breedte (L mm)	hoogte (H mm)	75/65/20 (Watt) (Φ50K)	55/45/20 (Watt) (Φ30K)	n-exp.	gewicht (kg)	inhoud (l)	el. weerst. (Watt)	prijs RAL 9016 (€)	prijs kleur (€)	
REF. NR. CARRÉ HORIZONTAAL CPHN1-RO : 133												
133	260	029	XX	YY	00							
		035								745	857	
		041								897	1032	
		047								1045	1202	
		053								1192	1371	
		059								1342	1543	
		065								1492	1716	
		077								1641	1887	
		089								1941	2232	
										2236	2571	
133	280	029	XX	YY	00							
		035								785	903	
		041								938	1079	
		047								1098	1263	
		053								1254	1442	
		059								1410	1622	
		065								1569	1804	
		077								1727	1986	
		089								2040	2346	
										2354	2707	
133	300	029	XX	YY	00							
		035								823	946	
		041								988	1136	
		047								1154	1327	
		053								1316	1513	
		059								1481	1703	
		065								1645	1892	
		077								1811	2083	
		089								2137	2458	
										2468	2838	

Conform EN442-1: 2014: radiatoren en convectoren

Voor meer details over onze artikel-data, zie artikel-database: <https://www.2ba.nl>

Voor de warmteafgiftes van andere regimes, kijkt u op p. 370 (correctiefactoren)
NEDERLAND. Prijzen in euro (excl. BTW)

CARRÉ HORIZONTAAL (CPHN2-RO)



CPHN2-RO

HOE CARRÉ HORIZONTAAL BESTELLEN

Leveringstermijn 15 - 30 werkdagen
(zonder transportduur)

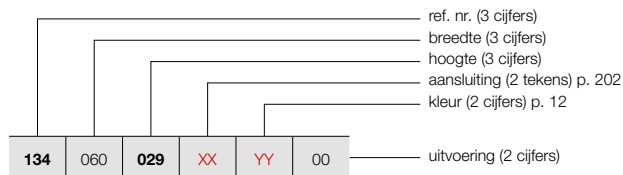

PRIJSGROEP: VPG2 - STAAL DESIGNRADIATOREN

BESTELCODE MAATWERK CARRÉ HORIZONTAAL	TECHNISCHE GEGEVENS									STANDAARDKLEUR	ANDERE KLEUREN
	buizen	breedte (L mm)	hoogte (H mm)	75/65/20 (Watt) (Φ50K)	55/45/20 (Watt) (Φ30K)	n-exp.	gewicht (kg)	inhoud (l)	el. weerst. (Watt)	prijs RAL 9016 (€)	prijs kleur (€)
REF. NR. CARRÉ HORIZONTAAL CPHN2-RO : 134											
134	060	029	XX	YY	00						
		035								529	608
		041								636	731
		047								744	856
		053								850	978
		059								958	1102
		065								1066	1226
		077								1168	1343
		089								1381	1588
										1596	1835
134	080	029	XX	YY	00						
		035								650	748
		041								774	890
		047								905	1041
		053								1037	1193
		059								1166	1341
		065								1296	1490
		077								1424	1638
		089								1685	1938
										1944	2236
134	100	029	XX	YY	00						
		035								756	869
		041								905	1041
		047								1059	1218
		053								1208	1389
		059								1361	1565
		065								1509	1735
		077								1659	1908
		089								1963	2257
										2262	2601
134	120	029	XX	YY	00						
		035								854	982
		041								1023	1176
		047								1200	1380
		053								1368	1573
		059								1541	1772
		065								1711	1968
		077								1882	2164
		089								2222	2555
										2571	2957
134	140	029	XX	YY	00						
		035								950	1093
		041								1141	1312
		047								1332	1532
		053								1519	1747
		059								1714	1971
		065								1904	2190
		077								2091	2405
		089								2471	2842
										2854	3282

Conform EN442-1: 2014: radiatoren en convectoren

Voor meer details over onze artikel-data, zie artikel-database: <https://www.2ba.nl>

Voor de warmteafgiftes van andere regimes, kijkt u op p. 370 (correctiefactoren)
NEDERLAND. Prijzen in euro (excl. BTW)

HOE CARRÉ HORIZONTAAL BESTELLEN

Leveringstermijn 15 - 30 werkdagen
(zonder transportduur)

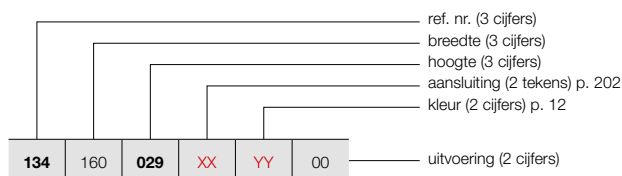

CARRÉ HORIZONTAAL (CPHN2-RO)



CPHN2-RO

PRIJSGROEP: VPG2 - STAAL DESIGNRADIATOREN

BESTELCODE MAATWERK CARRÉ HORIZONTAAL	TECHNISCHE GEGEVENS							STANDAARDKLEUR		ANDERE KLEUREN	
	buizen	breedte (L mm)	hoogte (H mm)	75/65/20 (Watt) (φ50K)	55/45/20 (Watt) (φ30K)	n-exp.	gewicht (kg)	inhoud (l)	el. weerst. (Watt)	prijs RAL 9016 (€)	prijs kleur (€)
REF. NR. CARRÉ HORIZONTAAL CPHN2-RO : 134											
134 160 029 XX YY 00	10	1600	295	1006	534	1,24	31,84	16,16	-	1042	1198
	12	1600	355	1224	646	1,25	38,02	19,39	-	1252	1440
	14	1600	415	1438	752	1,27	44,19	22,62	-	1457	1676
	16	1600	475	1646	856	1,28	50,37	25,86	-	1669	1919
	18	1600	535	1848	956	1,29	56,54	29,09	-	1875	2156
	20	1600	595	2042	1051	1,30	62,72	32,32	-	2084	2397
	22	1600	655	2229	1147	1,30	68,93	35,71	-	2295	2639
	26	1600	775	2579	1328	1,30	81,34	42,50	-	2710	3117
	30	1600	895	2898	1492	1,30	93,76	49,28	-	3122	3590
	134 180 029 XX YY 00	10	1800	295	1132	601	1,24	35,82	18,18	-	1131
12		1800	355	1377	727	1,25	42,77	21,82	-	1356	1559
14		1800	415	1618	846	1,27	49,72	25,45	-	1583	1820
16		1800	475	1852	963	1,28	56,66	29,09	-	1810	2082
18		1800	535	2079	1076	1,29	63,61	32,72	-	2033	2338
20		1800	595	2297	1182	1,30	70,56	36,36	-	2261	2600
22		1800	655	2507	1290	1,30	77,54	40,18	-	2486	2859
26		1800	775	2902	1494	1,30	91,51	47,81	-	2936	3376
30		1800	895	3260	1678	1,30	105,48	55,44	-	3388	3896
134 200 029 XX YY 00		10	2000	295	1258	668	1,24	39,80	20,20	-	1212
	12	2000	355	1530	808	1,25	47,52	24,24	-	1457	1676
	14	2000	415	1798	940	1,27	55,24	28,28	-	1698	1953
	16	2000	475	2058	1070	1,28	62,96	32,32	-	1944	2236
	18	2000	535	2310	1195	1,29	70,68	36,36	-	2187	2515
	20	2000	595	2552	1314	1,30	78,40	40,40	-	2431	2796
	22	2000	655	2786	1434	1,30	86,16	44,64	-	2674	3075
	26	2000	775	3224	1660	1,30	101,68	53,12	-	3157	3631
	30	2000	895	3622	1864	1,30	117,20	61,60	-	3640	4186
	134 220 029 XX YY 00	10	2200	295	1384	735	1,24	43,78	22,22	-	1296
12		2200	355	1683	889	1,25	52,27	26,66	-	1557	1791
14		2200	415	1978	1034	1,27	60,76	31,11	-	1815	2087
16		2200	475	2264	1177	1,28	69,26	35,55	-	2072	2383
18		2200	535	2541	1315	1,29	77,75	40,00	-	2333	2683
20		2200	595	2807	1445	1,30	86,24	44,44	-	2593	2982
22		2200	655	3065	1578	1,30	94,78	49,10	-	2854	3282
26		2200	775	3546	1825	1,30	111,85	58,43	-	3371	3877
30		2200	895	3984	2051	1,30	128,92	67,76	-	3887	4470
134 240 029 XX YY 00		10	2400	295	1510	801	1,24	47,76	24,24	-	1377
	12	2400	355	1836	970	1,25	57,02	29,09	-	1653	1901
	14	2400	415	2158	1128	1,27	66,29	33,94	-	1925	2214
	16	2400	475	2470	1284	1,28	75,55	38,78	-	2202	2532
	18	2400	535	2772	1434	1,29	84,82	43,63	-	2476	2847
	20	2400	595	3062	1576	1,30	94,08	48,48	-	2749	3161
	22	2400	655	3343	1721	1,30	103,39	53,57	-	3027	3481
	26	2400	775	3869	1992	1,30	122,02	63,74	-	3578	4115

Conform EN442-1: 2014: radiatoren en convectoren

Voor meer details over onze artikel-data, zie artikel-database: <https://www.2ba.nl>

Voor de warmteafgiftes van andere regimes, kijkt u op p. 370 (correctiefactoren)
NEDERLAND. Prijzen in euro (excl. BTW)

CARRÉ HORIZONTAAL (CPHN2-RO)



CPHN2-RO

HOE CARRÉ HORIZONTAAL BESTELLEN

Leveringstermijn 15 - 30 werkdagen
(zonder transportduur)

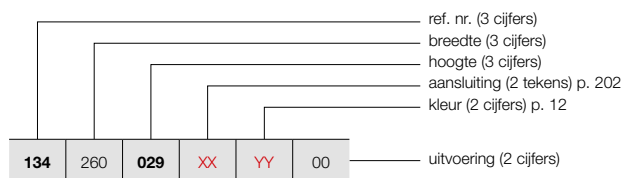

PRIJSGROEP: VPG2 - STAAL DESIGNRADIATOREN

BESTELCODE MAATWERK CARRÉ HORIZONTAAL	TECHNISCHE GEGEVENS									STANDAARDKLEUR	ANDERE KLEUREN
	buizen	breedte (L mm)	hoogte (H mm)	75/65/20 (Watt) (Φ50K)	55/45/20 (Watt) (Φ30K)	n-exp.	gewicht (kg)	inhoud (l)	el. weerst. (Watt)	prijs RAL 9016 (€)	prijs kleur (€)
REF. NR. CARRÉ HORIZONTAAL CPHN2-RO : 134											
134	260	029	XX	YY	00						
		035								1455	1673
		041								1744	2006
		047								2033	2338
		053								2326	2675
		059								2619	3012
		065								2910	3347
		077								3200	3680
										3780	4347
134	280	029	XX	YY	00						
		035								1533	1763
		041								1833	2108
		047								2141	2462
		053								2446	2813
		059								2754	3167
		065								3059	3518
										3368	3873
134	300	029	XX	YY	00						
		035								1607	1848
		041								1925	2214
		047								2247	2584
		053								2569	2954
		059								2884	3317
		065								3205	3686
										3528	4057

Conform EN442-1: 2014: radiatoren en convectoren

Voor meer details over onze artikel-data, zie artikel-database: <https://www.2ba.nl>

Voor de warmteafgifte van andere regimes, kijkt u op p. 370 (correctiefactoren)
NEDERLAND. Prijzen in euro (excl. BTW)





PRIJSGROEP: VPG10 - ACC.

BEVESTIGINGEN	HOOGTE / BREEDTE RADIATOR	KLEUR	ART. NR.	€
CPVN2-ZB / CPHN1-RO / CPHN2-RO				
WANDOPSTELLING	≤ 2400 mm (4 bevestigingen)	RAL 7016	1187 007 0000 7016	43
	≥ 2600 mm (6 bevestigingen)	RAL 7016	1187 008 0000 7016	63

NEDERLAND. Prijzen in euro (excl. BTW)

CARRÉ ACCESSOIRES
IN OPTIE

PRIJSGROEP: VPG10B - HANDDOEKBEUGELS

ACCESSOIRES	BREEDTE RADIATOR	KLEUR	ART. NR.	€
CPVN-PLUS / CPVN2-ZB / CPHN1-RO / CPHN2-RO				
KNOP VIERKANT 		CHROOM	1183 500 0000 0099	73
	<ul style="list-style-type: none"> h = 24 mm; b = 24 mm; d = 65 mm 			
CPVN-PLUS / CPVN2-ZB / CPHN1-RO / CPHN2-RO				
HANDDOEKBEUGEL RECHT 		CHROOM	1183 207 0000 0099	201
	<ul style="list-style-type: none"> h = 24 mm; b = 720 mm (zelf in te korten); d = 66 mm; a = 48 mm 			
CPVN-PLUS / CPVN2-ZB				
HANDDOEKBEUGEL MULTI+ RECHTS 	600 mm	S600	1183 734 0000 0600	218
	600 mm	RAL 9005 ^S	1183 734 0000 9005	218
<ul style="list-style-type: none"> h = 70 mm; b = 600 mm (b tablet = 194 mm); e = 176 mm; c = 170 mm; Bevestiging aan de muur, rechts van de radiator. 				
CPVN-PLUS / CPVN2-ZB				
HANDDOEKBEUGEL MULTI+ LINKS 	600 mm	S600	1183 735 0000 0600	218
	600 mm	RAL 9005 ^S	1183 735 0000 9005	218
<ul style="list-style-type: none"> h = 70 mm; b = 600 mm (b tablet = 194 mm); e = 176 mm; c = 170 mm; Bevestiging aan de muur, links van de radiator. 				

^S structuur zwart

Montagevoorschriften accessoires: zie www.vasco.eu

NEDERLAND. Prijzen in euro (excl. BTW)

e = afstand voorkant accessoire tot wand

d = afstand voorkant accessoire tot voorkant radiator

c = afstand wand tot achterkant beugel

a = afstand accessoire tot radiator

uit voorraad leverbaar

CARRÉ PLUS VERTICAAL: CPVN-PLUS (VOORRAAD)
CARRÉ VERTICAAL: CPVN2-ZB

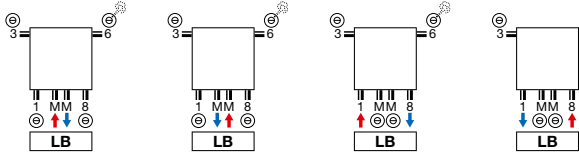

CARRÉ PLUS VERTICAAL: CPVN-PLUS (NIET-VOORRAAD)
CARRÉ VERTICAAL: CPVN2-ZB

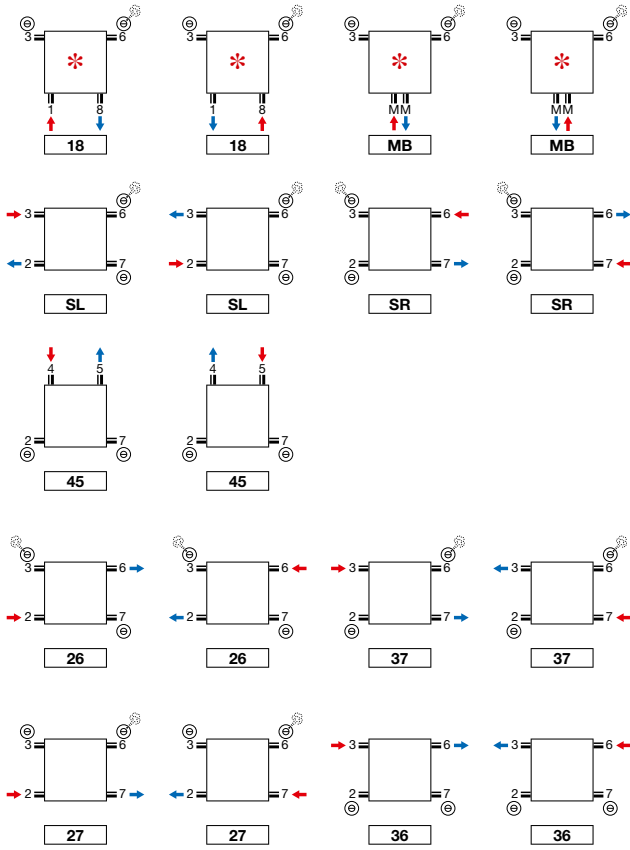

* **Opmerking CPVN-PLUS/CPVN2-ZB 10 buizen: 2/3/6/7 altijd open.**

CARRÉ HORIZONTAAL: CPHN1-RO / CPHN2-RO

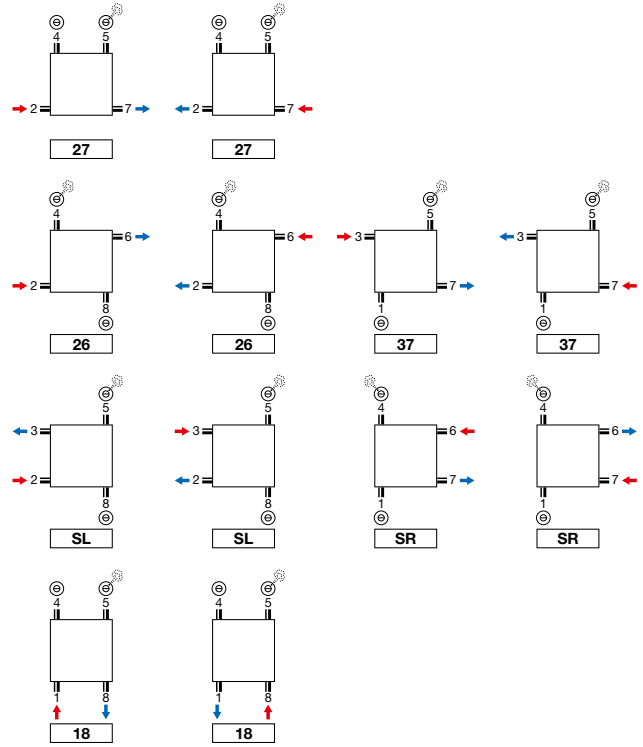

Opmerking: het aansluiten van de radiator kan enkel volgens de getoonde aansluiticonen. Voor elke andere aansluitwijze nemen wij geen verantwoordelijkheid.

CARRÉ PLUS VERTICAAL (CPVN-PLUS)

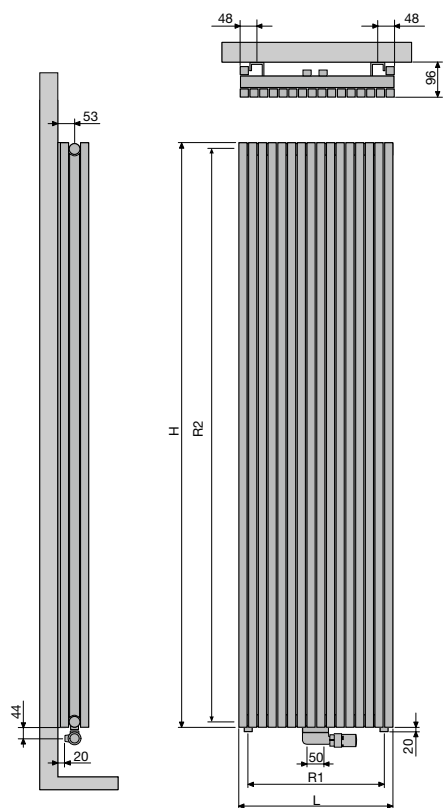

		CPVN-PLUS									
	Aantal buizen	10	12	14	16	18	20	22	26	30	
	Breedte (L)	295	355	415	475	535	595	655	775	895	
	Hartafstand tussen de onderaansluitingen 18 (R1)	240	300	360	420	480	540	600	720	840	
	Hoogte (H)	1400	1600	1800	2000	2200					
	Hartafstand tussen de zijansluitingen SL/SR (R2)	1365	1565	1765	1965	2165					
	Hartafstand tussen de ophangingen	L-200	H-290								

CARRÉ VERTICAAL (CPVN2-ZB)

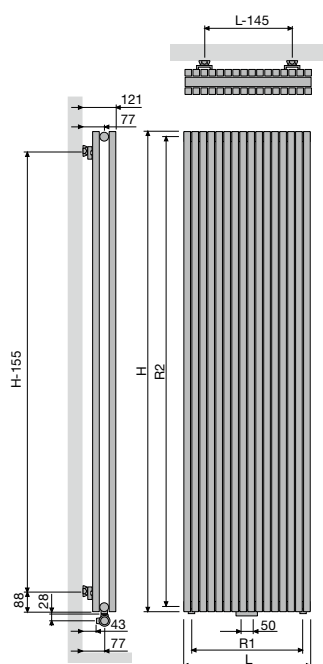

		CPVN2-ZB									
	Aantal buizen	10	12	14	16	18	20	22	26	30	
	Breedte (L)	295	355	415	475	535	595	655	775	895	
	Hartafstand tussen de onderaansluitingen 18 (R1)	240	300	360	420	480	540	600	720	840	
	Hoogte (H)	1400	1600	1800	2000	2200	2400	2600	2800	3000	
	Hartafstand tussen de zijansluitingen SL/SR (R2)	1365	1565	1765	1965	2165	2365	2565	2765	2965	
	Hartafstand tussen de ophangingen	L-145	H-155								

BUIZEN

- VV: Verticaal, rechthoekig 45 x 20 mm

KLEUREN

- Standaardkleur wit RAL 9016
- Uitgebreide kleurenkaart zie p. 12

SPECIAAL

- De Arche is bekroond met Design Plus Award 2005, Reddot Design Award 2006, Silver Award Designpreis Deutschland 2006 en genomineerd voor de Henry van de Velde prijs 2005.

BEVESTIGINGEN

- Muurbevestigingen standaard (telescopisch)

TECHNISCH

- ATL-grondlaag, poedercoating
- Standaardwerkdruk: 4 bar
- Maximale bedrijfstemperatuur: 110°C

ELEKTRISCH

- ✗ Zuiver elektrische radiator in de fabriek vorgevuld
- ✗ Gemengde radiator

TECHNISCHE TEKENINGEN

- Zie p. 210

AANSLUITING

- ✗ Eénpuntsaansluiting voor éénpijpsysteem
- ✗ Eénpuntsaansluiting voor tweepijpsysteem
- ✓ Tweepuntsaansluiting voor éénpijpsysteem (aansluiting via de middenaansluiting) (zie p. 362)
- ✓ Tweepuntsaansluiting voor tweepijpsysteem (standaard) (zie p. 362)
- ✗ Geïntegreerd ventiel
- Aansluitingen: ½" (binnendraad)

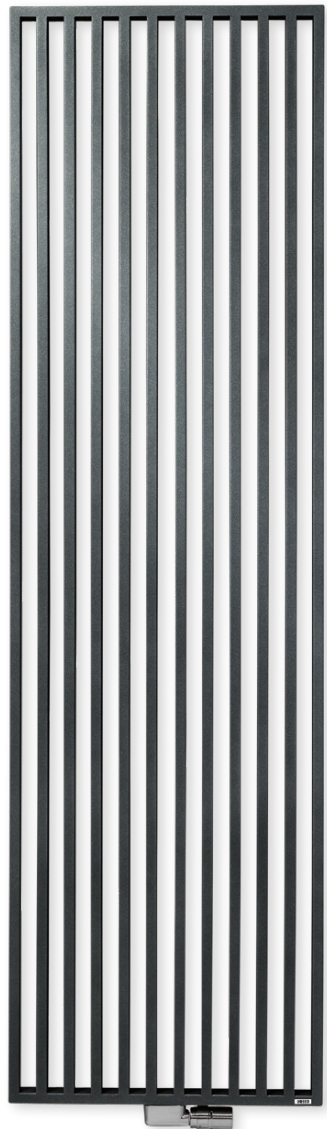

STAAL DESIGNRADIATOREN

AANBEVOLEN AANSLUITING (LB)

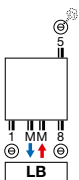

Andere aansluitmogelijkheden, zie p. 209



art. nr. 1182 103 0000 0099
prijs € 190
 Koppelingen, zie p. 377

**AANBEVOLEN VOOR BADKAMER EN KEUKEN
 IN OPTIE**



handdoekbeugel (chrom) art. nr. zie p. 209
prijs € 201

Andere accessoires, zie p. 209

ARCHE VERTICAAL

Techniek en esthetiek naadloos verenigd

Een designradiatorconcept, enig in zijn soort. De buizen zijn niet op, maar in elkaar gemonteerd en vormen samen één naadloze, vlakke structuur. Ook de accessoires zijn mooi in het geheel geïntegreerd. Die perfecte verstandhouding tussen techniek en esthetiek leveren een uniek product op dat inmiddels zowat alle belangrijke designprijzen heeft weggekaapt en ook beschikbaar is in een badkameruitvoering met middenaansluiting.



TYPES

- VVR (beugel rechts), VL (beugel links)

BUIZEN

- Verticaal, rechthoekig 45 x 20 mm

KLEUREN

- Standaardkleur wit RAL 9016
- Uitgebreide kleurenkaart zie p. 12

SPECIAAL

- Vaste handdoekbeugel in de kleur van de radiator
- Opgelet: deze beugel wordt niet warm!

BEVESTIGINGEN

- Muurbevestigingen standaard (telescopisch)

TECHNISCH

- ATL-grondlaag, poedercoating
- Standaardwerkdruk: 4 bar
- Maximale bedrijfstemperatuur: 110°C

ELEKTRISCH

- ✗ Zuiver elektrische radiator in de fabriek vorgevuld
- ✗ Gemengde radiator

TECHNISCHE TEKENINGEN

- Zie p. 210

AANSLUITING

- ✗ Eénpuntsaansluiting voor éénpijpsysteem
- ✗ Eénpuntsaansluiting voor tweepijpsysteem
- ✓ Tweepuntsaansluiting voor éénpijpsysteem (aansluiting via de middenaansluiting) (zie p. 362)
- ✓ Tweepuntsaansluiting voor tweepijpsysteem (standaard) (zie p. 362)
- ✗ Geïntegreerd ventiel
- Aansluitingen: 1/2" (binnendraad)

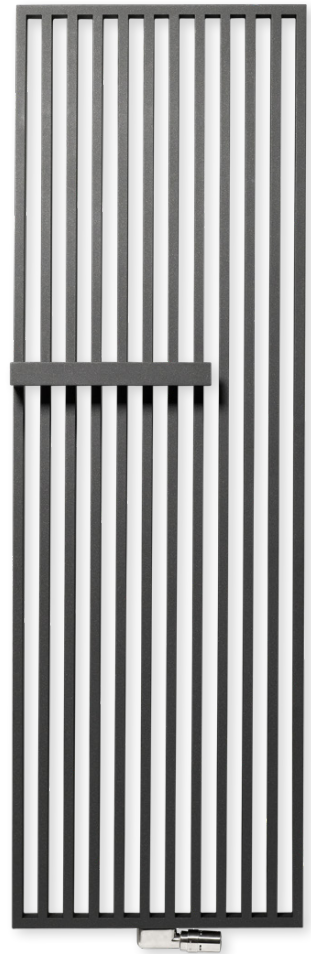

STAAL DESIGNRADIATOREN

AANBEVOLEN AANSLUITING (LB)

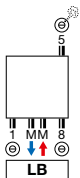

Andere aansluitmogelijkheden, zie p. 209



art. nr. 1182 103 0000 0099

prijs € 190

Koppelingen, zie p. 377

ARCHE PLUS VERTICAAL

Functioneel mooi over de hele lijn

Een designradiator waarbij de unieke, vlakke vormgeving van de Arche wordt aangevuld met een naadloos op de structuur gelaste handdoekbeugel. Samen vormen ze een mooi afgewerkt geheel dat de perfecte verstandhouding tussen de Arche vormgeving en functionaliteit extra benadrukt.



ARCHE PLUS VERTICAAL (VWL, VVR)

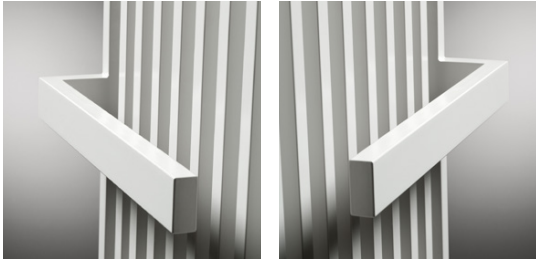

VWL

VVR

HOE ARCHE PLUS VERTICAAL BESTELLEN

Leveringstermijn 15 - 30 werkdagen
(zonder transportduur)

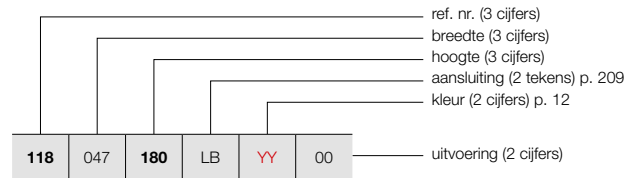

HOE VOORRAADRADIATOR ARCHE PLUS VERTICAAL BESTELLEN

Leveringstermijn 5 werkdagen
(zonder transportduur)

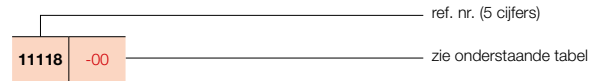



PRIJSGROEP: VPG2 - STAAL DESIGNRADIATOREN

BESTELCODE MAATWERK ARCHE PLUS VERTICAAL	TECHNISCHE GEGEVENS										STANDAARDKLEUR		ANDERE KLEUREN prijs kleur (€)
	buizen	breedte (L mm)	hoogte (H mm)	75/65/20 (Watt (Φ50K))	55/45/20 (Watt (Φ30K))	n-exp.	gewicht (kg)	inhoud (l)	el. weerst. (Watt)	prijs RAL 9016 (€)	verkorte ref. nr. RAL 9016 voorraad		
REF. NR. ARCHE PLUS VERTICAAL VWL : 118													
118 047 180 200 220 LB YY 00	10	470	1800	1050	560	1,23	23,49	13,94	-	847	11118-01	974	
	10	470	2000	1164	618	1,24	25,95	15,42	-	905	-	1041	
	10	470	2200	1279	679	1,24	28,40	16,91	-	959	-	1103	
118 057 180 200 220 LB YY 00	12	570	1800	1273	679	1,23	28,44	16,90	-	1025	-	1179	
	12	570	2000	1412	749	1,24	31,42	18,70	-	1098	-	1263	
	12	570	2200	1552	824	1,24	34,40	20,50	-	1158	-	1332	
118 067 180 200 220 LB YY 00	14	670	1800	1496	798	1,23	33,39	19,87	-	1207	-	1388	
	14	670	2000	1660	881	1,24	36,89	21,98	-	1292	-	1486	
	14	670	2200	1824	968	1,24	40,39	24,10	-	1363	-	1567	
REF. NR. ARCHE PLUS VERTICAAL VVR : 119													
119 047 180 200 220 LB YY 00	10	470	1800	1050	560	1,23	23,49	13,94	-	847	11119-01	974	
	10	470	2000	1164	618	1,24	25,95	15,42	-	905	-	1041	
	10	470	2200	1279	679	1,24	28,40	16,91	-	959	-	1103	
119 057 180 200 220 LB YY 00	12	570	1800	1273	679	1,23	28,44	16,90	-	1025	-	1179	
	12	570	2000	1412	749	1,24	31,42	18,70	-	1098	-	1263	
	12	570	2200	1552	824	1,24	34,40	20,50	-	1158	-	1332	
119 067 180 200 220 LB YY 00	14	670	1800	1496	798	1,23	33,39	19,87	-	1207	-	1388	
	14	670	2000	1660	881	1,24	36,89	21,98	-	1292	-	1486	
	14	670	2200	1824	968	1,24	40,39	24,10	-	1363	-	1567	

Conform EN442-1: 2014: radiatoren en convectoren

Voor meer details over onze artikel-data, zie artikel-database: <https://www.2ba.nl>
Voor de warmteafgiftes van andere regimes, kijkt u op p. 370 (correctiefactoren)
NEDERLAND. Prijzen in euro (excl. BTW)

PRIJSGROEP: VPG10B - HANDDOEKBEUGELS

ACCESSOIRES		KLEUR	ART. NR.	€
KNOP		VV / VWL / VWR		
		CHROOM	11834100000099	94
• h = 70 mm; b = 70 mm; d = 59 mm; a = 51 mm;				
HANDDOEKBEUGEL		W		
		CHROOM	11832280000099	201
• h = 22 mm; b = 720 mm (zelf in te korten) d = 75 mm; a = 56 mm				

Montagevoorschriften accessoires: zie www.vasco.eu
NEDERLAND. Prijzen in euro (excl. BTW)

d = afstand voorkant accessoire tot voorkant radiator
a = afstand accessoire tot radiator
uit voorraad leverbaar

ARCHE AANSLUITINGEN

ARCHE VERTICAAL: W
ARCHE PLUS VERTICAAL: WL / VR

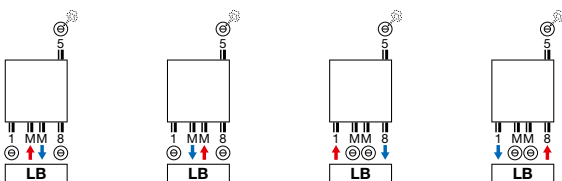

Opmerking: het aansluiten van de radiator kan enkel volgens de getoonde aansluiticonen. Voor elke andere aansluitwijze nemen wij geen verantwoordelijkheid.

ARCHE VERTICAAL (VV)

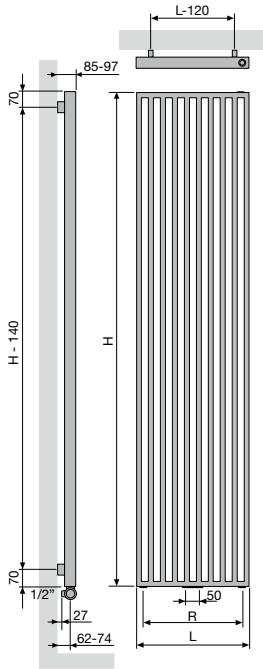

	VV		
Aantal buizen	10	12	14
Breedte (L)	470	570	670
Hartafstand tussen de onderaansluitingen 18 (R)	370	470	570
Hartafstand tussen de ophangingen	L-120	H-140	

ARCHE PLUS VERTICAAL (WL, VWR)

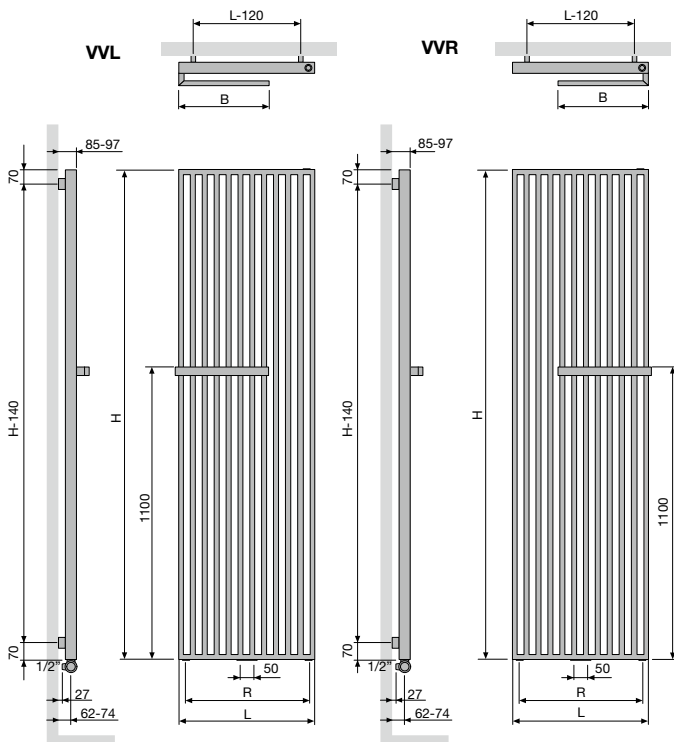

	WL / VWR		
Aantal buizen	10	12	14
Breedte (L)	470	570	670
Hartafstand tussen de onderaansluitingen 18 (R)	370	470	570
Breedte handdoekbeugel (B)	335	385	435
Hartafstand tussen de ophangingen	L-120	H-140	

TYPES

- Eén (ZV-1) of twee rijen buizen (ZV-2)

BUIZEN

- Verticaal, rechthoekig 45 x 20 mm

COLLECTOREN

- Horizontaal, achterliggend, rond Ø 35 mm

KLEUREN

- Standaardkleur wit RAL 9016
- Uitgebreide kleurenkaart zie p. 12

BEVESTIGINGEN

- Muurbevestigingen standaard

TECHNISCH

- Elektrisch lasergelast (onzichtbare lasnaden)
- ATL-grondlaag, poedercoating
- Standaardwerkdruk: 4 bar
- Maximale bedrijfstemperatuur: 110°C

ELEKTRISCH

- ✗ Zuiver elektrische radiator in de fabriek voorgevuld
- ✗ Gemengde radiator

TECHNISCHE TEKENINGEN

- Zie p. 223

AANSLUITING

- ✗ Eénpuntsaansluiting voor éénpijpsysteem
- ✗ Eénpuntsaansluiting voor tweepijpsysteem
- ✓ Tweepuntsaansluiting voor éénpijpsysteem (aansluiting via de middenaansluiting) (zie p. 362)
- ✓ Tweepuntsaansluiting voor tweepijpsysteem (standaard) (zie p. 362)
- ✗ Geïntegreerd ventiel
- Aansluitingen: 1/2" (binnendraad)

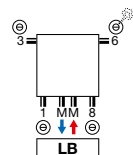
**AANBEVOLEN AANSLUITING (LB)****Andere aansluitmogelijkheden, zie p. 222**

art. nr. 1182 103 0000 0099

prijs € 190

Koppelingen, zie p. 377

**AANBEVOLEN VOOR BADKAMER EN KEUKEN
IN OPTIE**

handdoekbeugel recht (chrom) art. nr. zie p. 221

prijs € 201**Andere accessoires, zie p. 221****ZANA VERTICAAL****Traditie en trends in perfecte harmonie**

De Zana combineert een onklopbaar vermogen met een tijdloze lijnvoering. Een klassieker die blijft bekoren door zijn kracht, zijn klasse en zijn comfort. Het retrogevoel is nooit ver weg. Maar ook de moderniteit is volop aanwezig in dit unieke gamma designradiatoren voor elke woonomgeving, elke ruimte, elke toepassing.



ZANA VERTICAAL (ZV-1)



ZV-1

HOE ZANA VERTICAAL BESTELLEN

Leveringstermijn 15 - 30 werkdagen
(zonder transportduur)

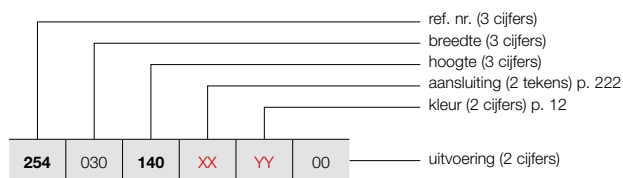

HOE VOORRAADRADIATOR ZANA VERTICAAL BESTELLEN

Leveringstermijn 5 werkdagen
(zonder transportduur)

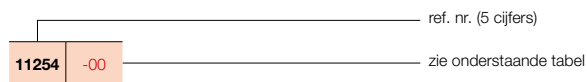

PRIJSGROEP: VPG2 - STAAL DESIGNRADIATOREN

BESTELCODE MAATWERK ZANA VERTICAAL	TECHNISCHE GEGEVENS									STANDAARDKLEUR		ANDERE KLEUREN prijs kleur (€)
	buizen	breedte (L mm)	hoogte (H mm)	75/65/20 (Watt) (Φ50K)	55/45/20 (Watt) (Φ30K)	n-exp.	gewicht (kg)	inhoud (l)	el. weerst. (Watt)	prijs RAL 9016 (€)	verkorte ref. nr. RAL 9016 voorraad	
REF. NR. ZANA VERTICAAL ZV-1 : 254												
254 030 140 XX YY 00	8	304	1400	680	359	1,27	18,16	8,24	-	578	-	665
	8	304	1600	769	406	1,27	20,72	9,44	-	628	-	722
	8	304	1800	859	454	1,28	23,20	10,64	-	677	-	779
	8	304	2000	950	502	1,28	25,68	11,68	-	729	-	838
	8	304	2200	1042	550	1,28	28,08	12,72	-	779	-	896
	8	304	2400	1136	600	1,29	30,56	13,76	-	831	-	956
	8	304	2600	1231	650	1,29	33,04	14,80	-	879	-	1011
	8	304	2800	1327	701	1,29	35,44	15,84	-	930	-	1070
	8	304	3000	1426	753	1,29	37,92	16,88	-	983	-	1130
	254 038 140 XX YY 00	10	384	1400	850	449	1,27	22,70	10,30	-	692	-
10		384	1600	962	508	1,27	25,90	11,80	-	758	-	872
10		384	1800	1074	567	1,28	29,00	13,30	-	819	11254-03	942
10		384	2000	1188	627	1,28	32,10	14,60	-	883	-	1015
10		384	2200	1303	688	1,28	35,10	15,90	-	943	-	1084
10		384	2400	1420	750	1,29	38,20	17,20	-	1009	-	1160
10		384	2600	1539	813	1,29	41,30	18,50	-	1074	-	1235
10		384	2800	1659	876	1,29	44,30	19,80	-	1137	-	1308
10		384	3000	1782	941	1,29	47,40	21,10	-	1200	-	1380
254 046 140 XX YY 00		12	464	1400	1020	539	1,27	27,24	12,36	-	811	-
	12	464	1600	1154	609	1,27	31,08	14,16	-	886	-	1019
	12	464	1800	1289	681	1,28	34,80	15,96	-	961	11254-12	1105
	12	464	2000	1425	752	1,28	38,52	17,52	-	1038	11254-01	1194
	12	464	2200	1563	825	1,28	42,12	19,08	-	1114	-	1281
	12	464	2400	1704	900	1,29	45,84	20,64	-	1188	-	1366
	12	464	2600	1846	975	1,29	49,56	22,20	-	1260	-	1449
	12	464	2800	1991	1051	1,29	53,16	23,76	-	1339	-	1540
	12	464	3000	2139	1130	1,29	56,88	25,32	-	1417	-	1630
	254 054 140 XX YY 00	14	544	1400	1190	628	1,27	31,78	14,42	-	924	-
14		544	1600	1346	711	1,27	36,26	16,52	-	1013	-	1165
14		544	1800	1504	794	1,28	40,60	18,62	-	1100	11254-07	1265
14		544	2000	1663	878	1,28	44,94	20,44	-	1189	11254-08	1367
14		544	2200	1824	963	1,28	49,14	22,26	-	1281	-	1473
14		544	2400	1988	1050	1,29	53,48	24,08	-	1367	-	1572
14		544	2600	2154	1137	1,29	57,82	25,90	-	1456	-	1674
14		544	2800	2323	1227	1,29	62,02	27,72	-	1545	-	1777
14		544	3000	2495	1318	1,29	66,36	29,54	-	1632	-	1877
254 062 140 XX YY 00		16	624	1400	1360	718	1,27	36,32	16,48	-	1042	-
	16	624	1600	1539	813	1,27	41,44	18,88	-	1143	-	1314
	16	624	1800	1719	908	1,28	46,40	21,28	-	1246	11254-09	1433
	16	624	2000	1900	1003	1,28	51,36	23,36	-	1344	11254-02	1546
	16	624	2200	2085	1101	1,28	56,16	25,44	-	1447	-	1664
	16	624	2400	2272	1200	1,29	61,12	27,52	-	1546	-	1778
	16	624	2600	2462	1300	1,29	66,08	29,60	-	1649	-	1896
	16	624	2800	2655	1402	1,29	70,88	31,68	-	1748	-	2010
	16	624	3000	2852	1506	1,29	75,84	33,76	-	1850	-	2128

Conform EN442-1: 2014: radiatoren en convectoren

Voor meer details over onze artikel-data, zie artikel-database: <https://www.2ba.nl>

Voor de warmteafgiftes van andere regimes, kijkt u op p. 370 (correctiefactoren)
NEDERLAND. Prijzen in euro (excl. BTW)

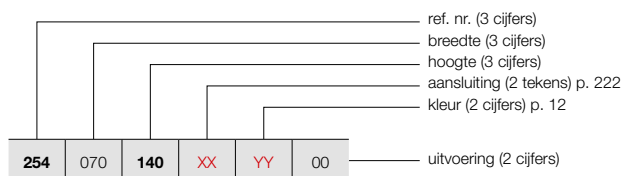

ZV-1

PRIJSGROEP: VPG2 - STAAL DESIGNRADIATOREN

BESTELCODE MAATWERK ZANA VERTICAAL	TECHNISCHE GEGEVENS							STANDAARDKLEUR		ANDERE KLEUREN						
	buizen	breedte (L mm)	hoogte (H mm)	75/65/20 (Watt) (φ50K)	55/45/20 (Watt) (φ30K)	n-exp.	gewicht (kg)	inhoud (l)	el. weerst. (Watt)	prijs RAL 9016 (€)	prijs kleur (€)					
REF. NR. ZANA VERTICAAL ZV-1 : 254																
254	070	140	XX	YY	00	18	704	1400	1531	808	1,27	40,86	18,54	-	1157	1331
		160				18	704	1600	1731	914	1,27	46,62	21,24	-	1273	1464
		180				18	704	1800	1933	1021	1,28	52,20	23,94	-	1387	1595
		200				18	704	2000	2138	1129	1,28	57,78	26,28	-	1497	1722
		220				18	704	2200	2345	1238	1,28	63,18	28,62	-	1612	1854
		240				18	704	2400	2555	1349	1,29	68,76	30,96	-	1727	1986
		260				18	704	2600	2769	1462	1,29	74,34	33,30	-	1838	2114
		280				18	704	2800	2987	1577	1,29	79,74	35,64	-	1953	2246
		300				18	704	3000	3208	1694	1,29	85,32	37,98	-	2068	2378
254	078	140	XX	YY	00	20	784	1400	1701	898	1,27	45,40	20,60	-	1275	1466
		160				20	784	1600	1923	1015	1,27	51,80	23,60	-	1402	1612
		180				20	784	1800	2148	1134	1,28	58,00	26,60	-	1527	1756
		200				20	784	2000	2375	1254	1,28	64,20	29,20	-	1654	1902
		220				20	784	2200	2606	1376	1,28	70,20	31,80	-	1778	2045
		240				20	784	2400	2839	1499	1,29	76,40	34,40	-	1905	2191
		260				20	784	2600	3077	1625	1,29	82,60	37,00	-	2030	2335
		280				20	784	2800	3319	1753	1,29	88,60	39,60	-	2158	2482
		300				20	784	3000	3564	1882	1,29	94,80	42,20	-	2284	2627
254	086	140	XX	YY	00	22	864	1400	1871	988	1,27	49,94	22,66	-	1390	1599
		160				22	864	1600	2116	1117	1,27	56,98	25,96	-	1528	1757
		180				22	864	1800	2363	1248	1,28	63,80	29,26	-	1669	1919
		200				22	864	2000	2613	1380	1,28	70,62	32,12	-	1810	2082
		220				22	864	2200	2866	1513	1,28	77,22	34,98	-	1947	2239
		240				22	864	2400	3123	1649	1,29	84,04	37,84	-	2086	2399
		260				22	864	2600	3385	1788	1,29	90,86	40,70	-	2222	2555
		280				22	864	2800	3650	1927	1,29	97,46	43,56	-	2363	2717
		300				22	864	3000	3921	2071	1,29	104,28	46,42	-	2501	2876
254	094	140	XX	YY	00	24	944	1400	2041	1078	1,27	54,48	24,72	-	1506	1732
		160				24	944	1600	2308	1219	1,27	62,16	28,32	-	1657	1906
		180				24	944	1800	2578	1361	1,28	69,60	31,92	-	1811	2083
		200				24	944	2000	2850	1505	1,28	77,04	35,04	-	1960	2254
		220				24	944	2200	3127	1651	1,28	84,24	38,16	-	2111	2428
		240				24	944	2400	3407	1799	1,29	91,68	41,28	-	2265	2605
		260				24	944	2600	3692	1950	1,29	99,12	44,40	-	2414	2776
		280				24	944	2800	3982	2103	1,29	106,32	47,52	-	2570	2956
		300				24	944	3000	4277	2259	1,29	113,76	50,64	-	2717	3125
254	102	140	XX	YY	00	26	1024	1400	2211	1168	1,27	59,02	26,78	-	1624	1868
		160				26	1024	1600	2500	1320	1,27	67,34	30,68	-	1785	2053
		180				26	1024	1800	2793	1475	1,28	75,40	34,58	-	1950	2243
		200				26	1024	2000	3088	1631	1,28	83,46	37,96	-	2116	2433
		220				26	1024	2200	3388	1789	1,28	91,26	41,34	-	2279	2621
		240				26	1024	2400	3691	1949	1,29	99,32	44,72	-	2443	2809
		260				26	1024	2600	4000	2112	1,29	107,38	48,10	-	2607	2998
		280				26	1024	2800	4314	2278	1,29	115,18	51,48	-	2773	3189
		300				26	1024	3000	4634	2447	1,29	123,24	54,86	-	2934	3374

ZANA VERTICAAL (ZV-2)



ZV-2

HOE ZANA VERTICAAL BESTELLEN

Leveringstermijn 15 - 30 werkdagen
(zonder transportduur)

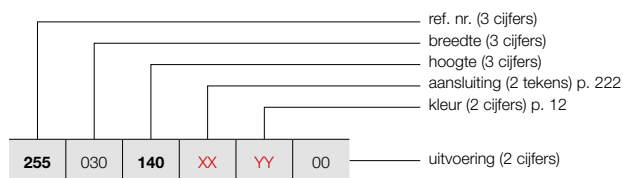

HOE VOORRAADRADIATOR ZANA VERTICAAL BESTELLEN

Leveringstermijn 5 werkdagen
(zonder transportduur)

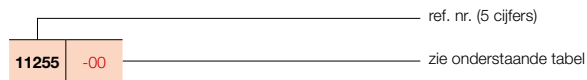

PRIJSGROEP: VPG2 - STAAL DESIGNRADIATOREN

BESTELCODE MAATWERK ZANA VERTICAAL	TECHNISCHE GEGEVENS									STANDAARDKLEUR		ANDERE KLEUREN
	buizen	breedte (L mm)	hoogte (H mm)	75/65/20 (Watt) (Φ50K)	55/45/20 (Watt) (Φ30K)	n-exp.	gewicht (kg)	inhoud (l)	el. weerst. (Watt)	prijs RAL 9016 (€)	verkorte ref. nr. RAL 9016 voorraad	
REF. NR. ZANA VERTICAAL ZV-2 : 255												
255	030	140	XX	YY	00							
		160										
		180										
		200										
		220										
		240										
		260										
		280										
		300										
255	038	140	XX	YY	00							
		160										
		180										
		200										
		220										
		240										
		260										
		280										
		300										
255	046	140	XX	YY	00							
		160										
		180										
		200										
		220										
		240										
		260										
		280										
		300										
255	054	140	XX	YY	00							
		160										
		180										
		200										
		220										
		240										
		260										
		280										
		300										
255	062	140	XX	YY	00							
		160										
		180										
		200										
		220										
		240										
		260										
		280										
		300										

Conform EN442-1: 2014: radiatoren en convectoren

Voor meer details over onze artikel-data, zie artikel-database: <https://www.2ba.nl>

Voor de warmteafgiftes van andere regimes, kijkt u op p. 370 (correctiefactoren)
NEDERLAND. Prijzen in euro (excl. BTW)

HOE ZANA VERTICAAL BESTELLEN
Leveringstermijn 15 - 30 werkdagen
(zonder transportduur)

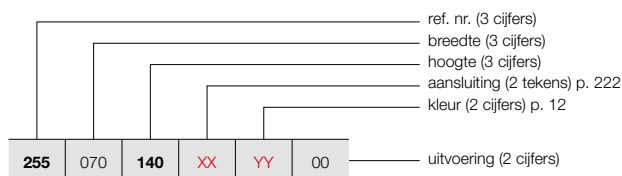

ZANA VERTICAAL (ZV-2)



ZV-2

HOE VOORRAADRADIATOR ZANA VERTICAAL BESTELLEN

Leveringstermijn 5 werkdagen
(zonder transportduur)

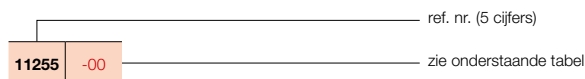

PRIJSGROEP: VPG2 - STAAL DESIGNRADIATOREN

BESTELCODE MAATWERK ZANA VERTICAAL	TECHNISCHE GEGEVENS							STANDAARDKLEUR		ANDERE KLEUREN		
	buizen	breedte (L mm)	hoogte (H mm)	75/65/20 (Watt) (φ50K)	55/45/20 (Watt) (φ30K)	n-exp.	gewicht (kg)	inhoud (l)	el. weerst. (Watt)		prijs RAL 9016 (€)	verkorte ref. nr. RAL 9016 voorraad
REF. NR. ZANA VERTICAAL ZV-2 : 255												
255 070 140 XX YY 00	18	704	1400	2486	1313	1,30	79,20	36,36	-	1966	-	2261
	18	704	1600	2795	1476	1,30	90,36	41,40	-	2162	-	2486
	18	704	1800	3102	1638	1,30	101,52	46,44	-	2356	-	2709
	18	704	2000	3409	1800	1,30	112,50	52,38	-	2545	11255-01	2927
	18	704	2200	3716	1962	1,30	123,30	58,32	-	2741	-	3152
	18	704	2400	4023	2124	1,30	134,28	64,26	-	2935	-	3375
	18	704	2600	4330	2287	1,30	145,08	70,02	-	3125	-	3594
	18	704	2800	4639	2450	1,30	156,06	75,96	-	3320	-	3818
255 078 140 XX YY 00	20	784	1400	2762	1459	1,30	88,00	40,40	-	2165	-	2490
	20	784	1600	3105	1640	1,30	100,40	46,00	-	2382	-	2739
	20	784	1800	3447	1820	1,30	112,80	51,60	-	2595	-	2984
	20	784	2000	3788	2000	1,30	125,00	58,20	-	2809	-	3230
	20	784	2200	4129	2180	1,30	137,00	64,80	-	3023	-	3476
	20	784	2400	4470	2360	1,30	149,20	71,40	-	3240	-	3726
	20	784	2600	4812	2541	1,30	161,20	77,80	-	3452	-	3970
255 086 140 XX YY 00	22	864	1400	3038	1604	1,30	96,80	44,44	-	2365	-	2720
	22	864	1600	3416	1804	1,30	110,44	50,60	-	2598	-	2988
	22	864	1800	3792	2002	1,30	124,08	56,76	-	2836	-	3261
	22	864	2000	4167	2200	1,30	137,50	64,02	-	3071	-	3532
	22	864	2200	4541	2398	1,30	150,70	71,28	-	3306	-	3802
255 094 140 XX YY 00	24	944	1400	3314	1750	1,30	105,60	48,48	-	2564	-	2949
	24	944	1600	3726	1968	1,30	120,48	55,20	-	2822	-	3245
	24	944	1800	4136	2184	1,30	135,36	61,92	-	3073	-	3534
	24	944	2000	4545	2400	1,30	150,00	69,84	-	3331	-	3831
255 102 140 XX YY 00	26	1024	1400	3590	1896	1,30	114,40	52,52	-	2758	-	3172
	26	1024	1600	4037	2132	1,30	130,52	59,80	-	3035	-	3490
	26	1024	1800	4481	2366	1,30	146,64	67,08	-	3314	-	3811

Conform EN442-1: 2014: radiatoren en convectoren

Voor meer details over onze artikel-data, zie artikel-database: <https://www.2ba.nl>

Voor de warmteafgiftes van andere regimes, kijkt u op p. 370 (correctiefactoren)
NEDERLAND. Prijzen in euro (excl. BTW)

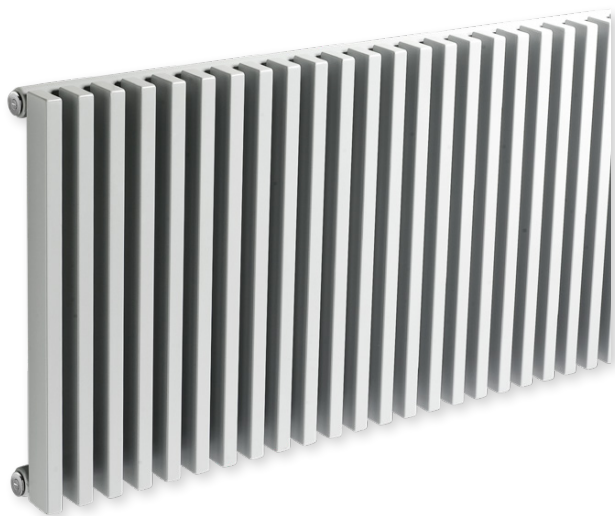

TYPES

- Eén (ZH-1) of twee rijen buizen (ZH-2)

BUIZEN

- Verticaal, rechthoekig 45 x 20 mm
- Opgelet: horizontale vormgeving, maar steeds met verticale buizen!

COLLECTOREN

- Horizontaal, achterliggend, rond Ø 35 mm

KLEUREN

- Standaardkleur wit RAL 9016
- Uitgebreide kleurenkaart zie p. 12

SPECIAAL

- ZH-1 ook verkrijgbaar als toiletradiator (384 x 500 mm)

BEVESTIGINGEN

- Muurbevestigingen standaard

TECHNISCH

- Elektrisch lasergelast (onzichtbare lasnaden)
- ATL-grondlaag, poedercoating
- Standaardwerkdruk: 4 bar
- Maximale bedrijfstemperatuur: 110°C

ELEKTRISCH

- ✗ Zuiver elektrische radiator in de fabriek voorgevuld
- ✗ Gemengde radiator

TECHNISCHE TEKENINGEN

- Zie p. 223

AANSLUITING

- ✗ Eénpuntsaansluiting voor éénpijpssysteem
- ✗ Eénpuntsaansluiting voor tweepijpssysteem
- ✗ Tweepuntsaansluiting voor éénpijpssysteem
- ✓ Tweepuntsaansluiting voor tweepijpssysteem (standaard) (zie p. 362)
- ✗ Geïntegreerd ventiel
- Aansluitingen: ½" (binnendraad)

ZANA HORIZONTAAL

Mooi tot in lengte van dagen

Ook in de horizontale uitvoering is de Zana designradiator een toonbeeld van klasse, kracht en comfort. De verticale buizen en de horizontale collectoren vormen samen een mooi gestructureerd geometrisch geheel en dragen bij tot de specifieke Zana retro-look. De Zana Horizontaal is verkrijgbaar met 1 of 2 rijen buizen en in een aparte toiletversie.

AANBEVOLEN AANSLUITING (18)

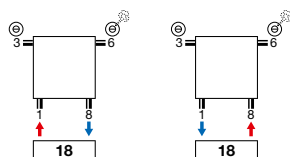

Andere aansluitmogelijkheden, zie p. 222



art. nr. 1182 101 0000 0099
prijs € 234
 Koppelingen, zie p. 377

AANBEVOLEN VOOR BADKAMER EN KEUKEN IN OPTIE



handdoekbeugel recht (chrom) art. nr. zie p. 221
prijs € 201

Andere accessoires, zie p. 221



HOE ZANA HORIZONTAAL BESTELLEN

Leveringstermijn 15 - 30 werkdagen
(zonder transportduur)

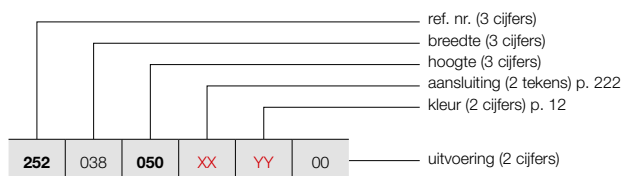

ZANA HORIZONTAAL (ZH-1)

217



ZH-1

PRIJSGROEP: VPG2 - STAAL DESIGNRADIATOREN

BESTELCODE MAATWERK ZANA HORIZONTAAL	TECHNISCHE GEGEVENS							STANDAARDKLEUR		ANDERE KLEUREN						
	buizen	breedte (L mm)	hoogte (H mm)	75/65/20 (Watt) (Φ50K)	55/45/20 (Watt) (Φ30K)	n-exp.	gewicht (kg)	inhoud (l)	el. weerst. (Watt)	prijs RAL 9016 (€)	prijs kleur (€)					
REF. NR. ZANA HORIZONTAAL ZH-1 : 252																
252	038	050	XX	YY	00	10	384	500	347	183	1,25	9,00	4,10	-	411	473
252	070	050	XX	YY	00	18	704	500	624	330	1,25	16,20	7,38	-	649	746
		060				18	704	600	728	384	1,25	18,90	8,46	-	705	811
		070				18	704	700	831	439	1,25	21,60	9,72	-	760	874
252	078	050	XX	YY	00	20	784	500	694	366	1,25	18,00	8,20	-	706	812
		060				20	784	600	809	427	1,25	21,00	9,40	-	768	883
		070				20	784	700	923	487	1,25	24,00	10,80	-	832	957
252	086	050	XX	YY	00	22	864	500	763	403	1,25	19,80	9,02	-	763	877
		060				22	864	600	890	470	1,25	23,10	10,34	-	834	959
		070				22	864	700	1015	536	1,25	26,40	11,88	-	902	1037
252	094	050	XX	YY	00	24	944	500	832	439	1,25	21,60	9,84	-	825	949
		060				24	944	600	971	513	1,25	25,20	11,28	-	900	1035
		070				24	944	700	1107	585	1,25	28,80	12,96	-	977	1124
252	102	050	XX	YY	00	26	1024	500	902	476	1,25	23,40	10,66	-	883	1015
		060				26	1024	600	1052	556	1,25	27,30	12,22	-	967	1112
		070				26	1024	700	1200	634	1,25	31,20	14,04	-	1048	1205
252	110	050	XX	YY	00	28	1104	500	971	513	1,25	25,20	11,48	-	941	1082
		060				28	1104	600	1133	598	1,25	29,40	13,16	-	1031	1186
		070				28	1104	700	1292	682	1,25	33,60	15,12	-	1118	1286
252	118	050	XX	YY	00	30	1184	500	1040	549	1,25	27,00	12,30	-	1002	1152
		060				30	1184	600	1214	641	1,25	31,50	14,10	-	1096	1260
		070				30	1184	700	1384	731	1,25	36,00	16,20	-	1189	1367
252	126	050	XX	YY	00	32	1264	500	1110	586	1,25	28,80	13,12	-	1062	1221
		060				32	1264	600	1295	684	1,25	33,60	15,04	-	1163	1337
		070				32	1264	700	1476	779	1,25	38,40	17,28	-	1259	1448
252	142	050	XX	YY	00	36	1424	500	1248	659	1,25	32,40	14,76	-	1180	1357
		060				36	1424	600	1457	769	1,25	37,80	16,92	-	1293	1487
		070				36	1424	700	1661	877	1,25	43,20	19,44	-	1407	1618
252	158	050	XX	YY	00	40	1584	500	1387	732	1,25	36,00	16,40	-	1298	1493
		060				40	1584	600	1618	854	1,25	42,00	18,80	-	1424	1638
		070				40	1584	700	1846	975	1,25	48,00	21,60	-	1549	1781
252	174	050	XX	YY	00	44	1744	500	1526	806	1,25	39,60	18,04	-	1417	1630
		060				44	1744	600	1780	940	1,25	46,20	20,68	-	1557	1791
		070				44	1744	700	2030	1072	1,25	52,80	23,76	-	1694	1948
252	190	050	XX	YY	00	48	1904	500	1665	879	1,25	43,20	19,68	-	1536	1766
		060				48	1904	600	1942	1026	1,25	50,40	22,56	-	1687	1940
		070				48	1904	700	2215	1170	1,25	57,60	25,92	-	1837	2113

Conform EN442-1: 2014: radiatoren en convectoren

Voor meer details over onze artikel-data, zie artikel-database: <https://www.2ba.nl>

Voor de warmteafgiftes van andere regimes, kijkt u op p. 370 (correctiefactoren)
NEDERLAND. Prijzen in euro (excl. BTW)

ZANA HORIZONTAAL (ZH-1)



ZH-1

HOE ZANA HORIZONTAAL BESTELLEN

Leveringstermijn 15 - 30 werkdagen
(zonder transportduur)

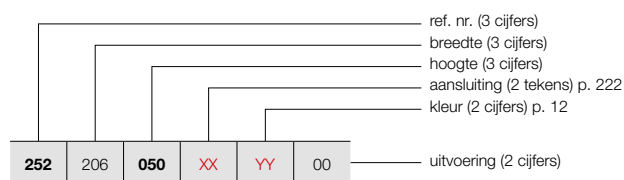

PRIJSGROEP: VPG2 - STAAL DESIGNRADIATOREN

BESTELCODE MAATWERK ZANA HORIZONTAAL	TECHNISCHE GEGEVENS									STANDAARDKLEUR	ANDERE KLEUREN	
	buizen	breedte (L mm)	hoogte (H mm)	75/65/20 (Watt) (Φ50K)	55/45/20 (Watt) (Φ30K)	n-exp.	gewicht (kg)	inhoud (l)	el. weerst. (Watt)	prijs RAL 9016 (€)	prijs kleur (€)	
REF. NR. ZANA HORIZONTAAL ZH-1 : 252												
252 206 050 XX YY 00	060	52	2064	500	1803	952	1,25	46,80	21,32	-	1654	1902
	070	52	2064	600	2104	1111	1,25	54,60	24,44	-	1817	2090
		52	2064	700	2399	1267	1,25	62,40	28,08	-	1982	2279
252 222 050 XX YY 00	060	56	2224	500	1942	1026	1,25	50,40	22,96	-	1773	2039
	070	56	2224	600	2266	1197	1,25	58,80	26,32	-	1949	2241
		56	2224	700	2584	1365	1,25	67,20	30,24	-	2126	2445
252 238 050 XX YY 00	060	60	2384	500	2081	1099	1,25	54,00	24,60	-	1892	2176
	070	60	2384	600	2428	1282	1,25	63,00	28,20	-	2079	2391
		60	2384	700	2768	1462	1,25	72,00	32,40	-	2268	2608
252 254 050 XX YY 00	060	64	2544	500	2220	1172	1,25	57,60	26,24	-	2010	2312
	070	64	2544	600	2589	1367	1,25	67,20	30,08	-	2211	2543
		64	2544	700	2953	1559	1,25	76,80	34,56	-	2412	2774
252 270 050 XX YY 00	060	68	2704	500	2358	1245	1,25	61,20	27,88	-	2127	2446
	070	68	2704	600	2751	1453	1,25	71,40	31,96	-	2341	2692
		68	2704	700	3138	1657	1,25	81,60	36,72	-	2555	2938
252 286 050 XX YY 00	060	72	2864	500	2497	1319	1,25	64,80	29,52	-	2246	2583
	070	72	2864	600	2913	1538	1,25	75,60	33,84	-	2471	2842
		72	2864	700	3322	1754	1,25	86,40	38,88	-	2699	3104

Conform EN442-1: 2014: radiatoren en convectoren

Voor meer details over onze artikel-data, zie artikel-database: <https://www.2ba.nl>

Voor de warmteafgiftes van andere regimes, kijkt u op p. 370 (correctiefactoren)
NEDERLAND. Prijzen in euro (excl. BTW)

HOE ZANA HORIZONTAAL BESTELLEN

Leveringstermijn 15 - 30 werkdagen
(zonder transportduur)

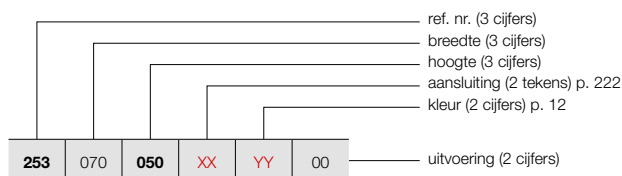

ZANA HORIZONTAAL (ZH-2)



ZH-2

PRIJSGROEP: VPG2 - STAAL DESIGNRADIATOREN

BESTELCODE MAATWERK ZANA HORIZONTAAL	TECHNISCHE GEGEVENS							STANDAARDKLEUR	ANDERE KLEUREN		
	buizen	breedte (L mm)	hoogte (H mm)	75/65/20 (Watt) (Φ50K)	55/45/20 (Watt) (Φ30K)	n-exp.	gewicht (kg)			inhoud (l)	el. weerst. (Watt)
REF. NR. ZANA HORIZONTAAL ZH-2 : 253											
253 070 050 XX YY 00	18	704	500	1035	547	1,28	30,42	13,50	-	1099	1264
	18	704	600	1205	636	1,28	35,64	16,02	-	1198	1378
	18	704	700	1372	725	1,28	41,04	18,54	-	1293	1487
253 078 050 XX YY 00	20	784	500	1150	607	1,28	33,80	15,00	-	1200	1380
	20	784	600	1339	707	1,28	39,60	17,80	-	1309	1505
	20	784	700	1525	805	1,28	45,60	20,60	-	1416	1628
253 086 050 XX YY 00	22	864	500	1265	668	1,28	37,18	16,50	-	1299	1494
	22	864	600	1473	778	1,28	43,56	19,58	-	1419	1632
	22	864	700	1677	886	1,28	50,16	22,66	-	1539	1770
253 094 050 XX YY 00	24	944	500	1380	729	1,28	40,56	18,00	-	1403	1613
	24	944	600	1607	849	1,28	47,52	21,36	-	1533	1763
	24	944	700	1830	966	1,28	54,72	24,72	-	1658	1907
253 102 050 XX YY 00	26	1024	500	1494	789	1,28	43,94	19,50	-	1501	1726
	26	1024	600	1741	919	1,28	51,48	23,14	-	1643	1889
	26	1024	700	1982	1047	1,28	59,28	26,78	-	1781	2048
253 110 050 XX YY 00	28	1104	500	1609	850	1,28	47,32	21,00	-	1602	1842
	28	1104	600	1875	990	1,28	55,44	24,92	-	1755	2018
	28	1104	700	2135	1127	1,28	63,84	28,84	-	1903	2188
253 118 050 XX YY 00	30	1184	500	1724	910	1,28	50,70	22,50	-	1701	1956
	30	1184	600	2009	1061	1,28	59,40	26,70	-	1864	2144
	30	1184	700	2287	1208	1,28	68,40	30,90	-	2025	2329
253 126 050 XX YY 00	32	1264	500	1839	971	1,28	54,08	24,00	-	1805	2076
	32	1264	600	2143	1132	1,28	63,36	28,48	-	1977	2274
	32	1264	700	2440	1288	1,28	72,96	32,96	-	2146	2468
253 142 050 XX YY 00	36	1424	500	2069	1093	1,28	60,84	27,00	-	2004	2305
	36	1424	600	2411	1273	1,28	71,28	32,04	-	2199	2529
	36	1424	700	2745	1450	1,28	82,08	37,08	-	2393	2752
253 158 050 XX YY 00	40	1584	500	2299	1214	1,28	67,60	30,00	-	2209	2540
	40	1584	600	2678	1414	1,28	79,20	35,60	-	2423	2786
	40	1584	700	3050	1611	1,28	91,20	41,20	-	2633	3028
253 174 050 XX YY 00	44	1744	500	2529	1335	1,28	74,36	33,00	-	2409	2770
	44	1744	600	2946	1556	1,28	87,12	39,16	-	2643	3039
	44	1744	700	3355	1772	1,28	100,32	45,32	-	2881	3313
253 190 050 XX YY 00	48	1904	500	2759	1457	1,28	81,12	36,00	-	2611	3003
	48	1904	600	3214	1697	1,28	95,04	42,72	-	2866	3296
	48	1904	700	3660	1933	1,28	109,44	49,44	-	3122	3590

Conform EN442-1: 2014: radiatoren en convectoren

Voor meer details over onze artikel-data, zie artikel-database: <https://www.2ba.nl>

Voor de warmteafgiftes van andere regimes, kijkt u op p. 370 (correctiefactoren)
NEDERLAND. Prijzen in euro (excl. BTW)

ZANA HORIZONTAAL (ZH-2)



ZH-2

HOE ZANA HORIZONTAAL BESTELLEN

Leveringstermijn 15 - 30 werkdagen
(zonder transportduur)

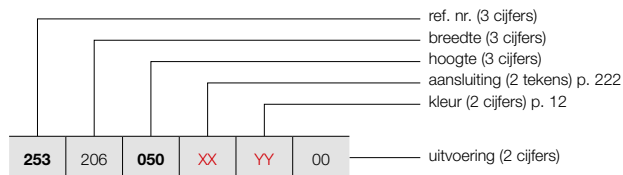

PRIJSGROEP: VPG2 - STAAL DESIGNRADIATOREN

BESTELCODE MAATWERK ZANA HORIZONTAAL	TECHNISCHE GEGEVENS									STANDAARDKLEUR	ANDERE KLEUREN					
	buizen	breedte (L mm)	hoogte (H mm)	75/65/20 (Watt) (Φ50K)	55/45/20 (Watt) (Φ30K)	n-exp.	gewicht (kg)	inhoud (l)	el. weerst. (Watt)	prijs RAL 9016 (€)	prijs kleur (€)					
REF. NR. ZANA HORIZONTAAL ZH-2 : 253																
253	206	050	XX	YY	00	52	2064	500	2989	1578	1,28	87,88	39,00	-	2809	3230
		060				52	2064	600	3482	1839	1,28	102,96	46,28	-	3092	3556
		070				52	2064	700	3964	2093	1,28	118,56	53,56	-	3369	3874
253	222	050	XX	YY	00	56	2224	500	3219	1700	1,28	94,64	42,00	-	3015	3467
		060				56	2224	600	3750	1980	1,28	110,88	49,84	-	3312	3809
		070				56	2224	700	4269	2254	1,28	127,68	57,68	-	3614	4156
253	238	050	XX	YY	00	60	2384	500	3449	1821	1,28	101,40	45,00	-	3213	3695
		060				60	2384	600	4018	2122	1,28	118,80	53,40	-	3536	4066
		070				60	2384	700	4574	2415	1,28	136,80	61,80	-	3861	4440
253	254	050	XX	YY	00	64	2544	500	3679	1943	1,28	108,16	48,00	-	3415	3927
		060				64	2544	600	4285	2263	1,28	126,72	56,96	-	3760	4324
		070				64	2544	700	4879	2576	1,28	145,92	65,92	-	4101	4716
253	270	050	XX	YY	00	68	2704	500	3909	2064	1,28	114,92	51,00	-	3617	4160
		060				68	2704	600	4553	2404	1,28	134,64	60,52	-	3980	4577
		070				68	2704	700	5184	2737	1,28	155,04	70,04	-	4347	4999
253	286	050	XX	YY	00	72	2864	500	4139	2186	1,28	121,68	54,00	-	3818	4391
		060				72	2864	600	4821	2546	1,28	142,56	64,08	-	4203	4833

Conform EN442-1: 2014: radiatoren en convectoren

Voor meer details over onze artikel-data, zie artikel-database: <https://www.2ba.nl>

Voor de warmteafgifte van andere regimes, kijkt u op p. 370 (correctiefactoren)
NEDERLAND. Prijzen in euro (excl. BTW)

PRIJSGROEP: VPG10B - HANDDOEKBEUGELS

ACCESSOIRES	BREEDTE RADIATOR	KLEUR	ART. NR.	€
ZV-1 / ZV-2 / ZH-1 / ZH-2				
HANDDOEKBEUGEL RECHT		CHROOM	1183 228 0000 0099	201
<ul style="list-style-type: none"> h = 22 mm; b = 720 mm (zelf in te korten); d = 75 mm; a = 56 mm 				
ZV-1 / ZV-2 / ZH-1 / ZH-2				
KNOP		CHROOM	1183 410 0000 0099	94
<ul style="list-style-type: none"> h = 70 mm; b = 70 mm; d = 59 mm; a = 51 mm; 				
ZV-1				
HANDDOEKBEUGEL MULTI+ RECHTS	600 mm	S600	1183 734 0000 0600	218
	600 mm	RAL 9005 ^S	1183 734 0000 9005	218
<ul style="list-style-type: none"> h = 70 mm; b = 600 mm (b tablet = 194 mm); e = 176 mm; c = 170 mm; Bevestiging aan de muur, rechts van de radiator. 				
ZV-1				
HANDDOEKBEUGEL MULTI+ LINKS	600 mm	S600	1183 735 0000 0600	218
	600 mm	RAL 9005 ^S	1183 735 0000 9005	218
<ul style="list-style-type: none"> h = 70 mm; b = 600 mm (b tablet = 194 mm); e = 176 mm; c = 170 mm; Bevestiging aan de muur, links van de radiator. 				

^S structuur zwart

Montagevoorschriften accessoires: zie www.vasco.eu
NEDERLAND. Prijzen in euro (excl. BTW)

e = afstand voorkant accessoire tot wand
d = afstand voorkant accessoire tot voorkant radiator
c = afstand wand tot achterkant beugel
a = afstand accessoire tot radiator
uit voorraad leverbaar

ZANA VERTICAAL: ZV-1 / ZV-2 (VOORRAAD)

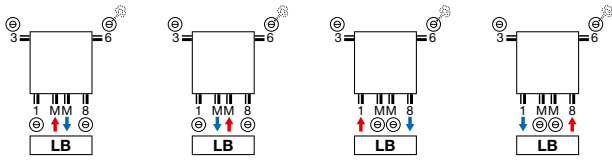

ZANA HORIZONTAAL: ZH-1 / ZH-2

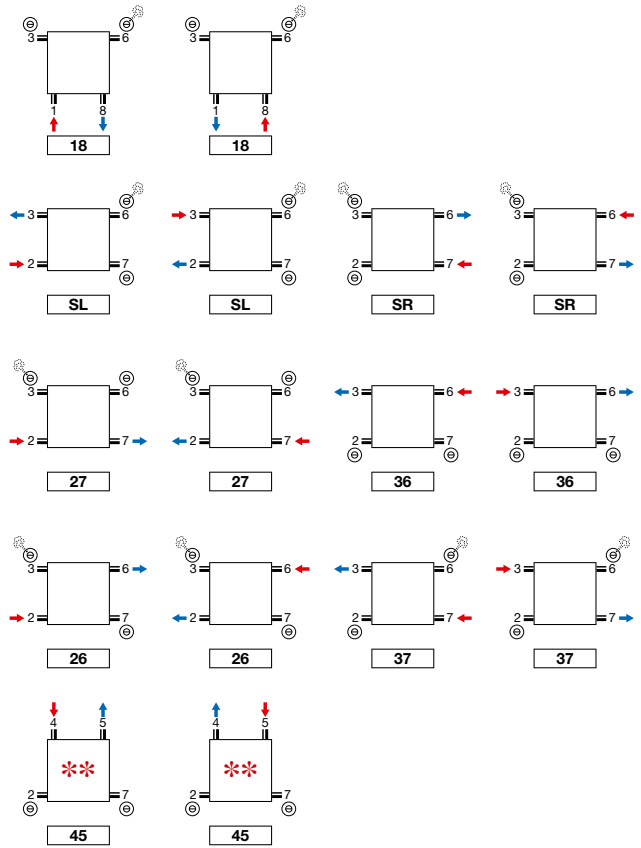

**** Niet voor ZH-1 toiletradiator.**

ZANA VERTICAAL: ZV-1 / ZV-2 (NIET-VOORRAAD)

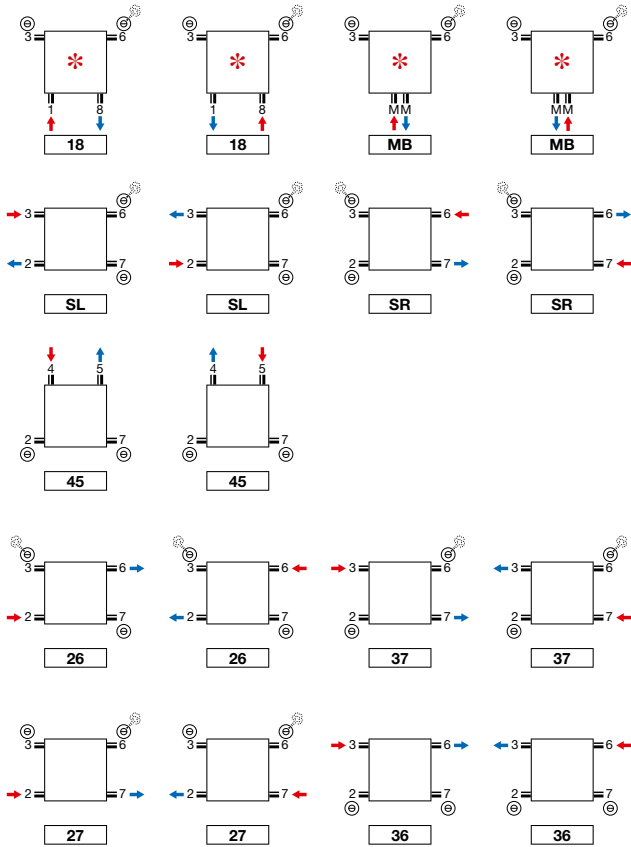

*** Opmerking ZV-1/ZV-2 8 buizen: 2/3/6/7 altijd open.**

Opmerking: het aansluiten van de radiator kan enkel volgens de getoonde aansluiticonen. Voor elke andere aansluitwijze nemen wij geen verantwoordelijkheid.

ZANA VERTICAAL (ZV-1, ZV-2)

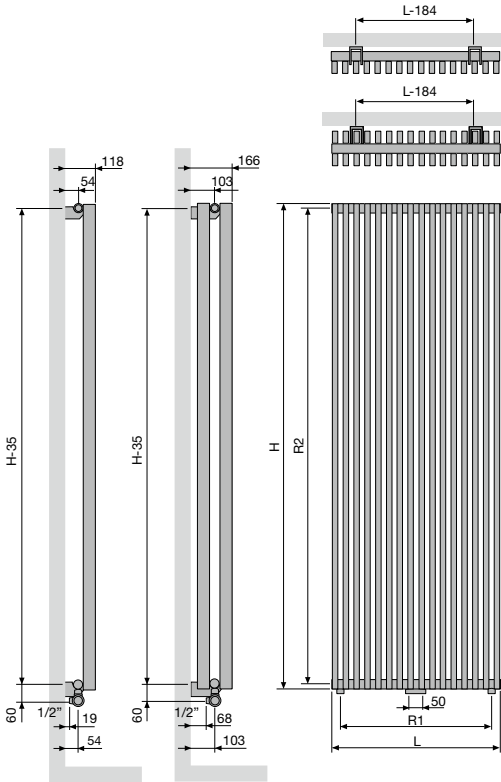

	ZV-1 / ZV-2										
Aantal buizen	8	10	12	14	16	18	20	22	24	26	
Breedte (L)	304	384	464	544	624	704	784	864	944	1024	
Hartafstand tussen de onderaansluitingen 18 (R1)	240	320	400	480	560	640	720	800	880	960	
Hoogte (H)	1400	1600	1800	2000	2200	2400	2600	2800	3000		
Hartafstand tussen de zijansluitingen SL/SR (R2)	1365	1565	1765	1965	2165	2365	2565	2765	2965		
Hartafstand tussen de ophangingen	L-184	H-35									

ZANA HORIZONTAAL (ZH-1, ZH-2)

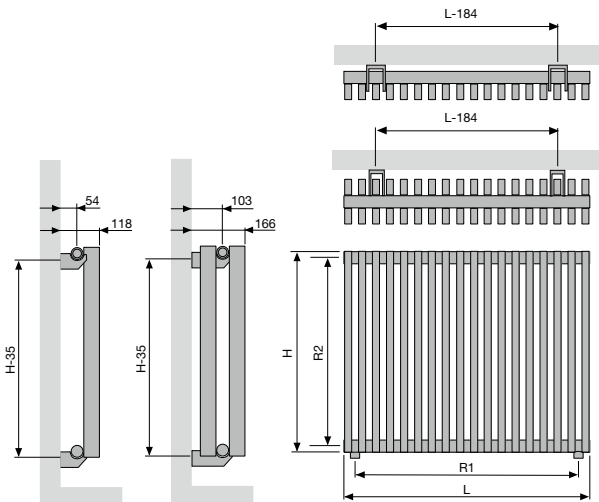

	ZH-1 / ZH-2																		
Breedte (L)	384	704	784	864	944	1024	1104	1184	1264	1424	1584	1744	1904	2064	2224	2384	2544	2704	2864
Hartafstand tussen de onderaansluitingen 18 (R1)	320	640	720	800	880	960	1040	1120	1200	1360	1520	1680	1840	2000	2160	2320	2480	2640	2800
Hoogte (H)	500	600	700																
Hartafstand tussen de zijansluitingen SL/SR (R2)	465	565	665																
Hartafstand tussen de ophangingen	L-184	H-35																	

VIOLA-A VERTICAAL (V1-ZB-A, V1L1-ZB-A, V2-ZB-A)

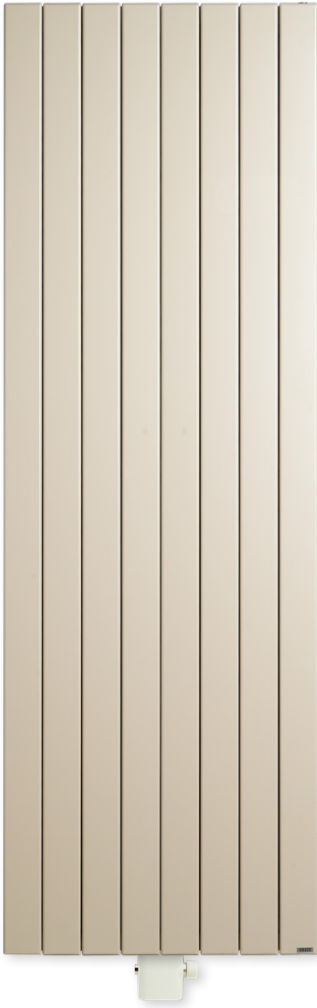

TYPES

- V1-ZB-A enkele rij buizen, V2-ZB-A dubbele rij buizen, V1L1-ZB-A met lamellen

BUIZEN

- Verticaal, rechthoekig 77 x 10 mm

COLLECTOREN

- V1-ZB-A: 35 x 43 mm
- V1L1-ZB-A: 35 x 43 mm
- V2-ZB-A: 35 x 41 mm

KLEUREN

- Standaardkleur wit RAL 9016
- Uitgebreide kleurenkaart zie p. 12

SPECIAAL

- Wordt standaard geleverd met 2 zijbekledingen.
- mm aansluiting alleen mogelijk bij even aantal buizen.
- Bij type V1L1-ZB-A is 1 rij stalen lamellen ter verhoging van de warmteafgifte op de platovale buizen gepuntlast.

BEVESTIGINGEN

- Muurbevestigingen standaard (inbegrepen in de verpakking van de radiator)
- Bovenste beugel in kleur van de radiator, onderaan:
 - Afstandshouder radiator wit = afstandshouder wit.
 - Afstandshouder radiator in kleur = afstandshouder RAL 7024.
- **V2-ZB-A:** Radiator met telescopische steunvoeten + variabele muurbevestiging: gelieve bij bestelling code **07** aan te geven bij "Afwerking" (zie p. 253).

TECHNISCH

- Weerstandsgelast (onzichtbare lasnaden)
- ATL-grondlaag, poedercoating
- Standaardwerkdruk: 4 bar. Meerprijs hogere werkdruk (10 bar): +10%
- De leveringstermijn van radiator met een hogere werkdruk is 1 week extra.
- Maximale bedrijfstemperatuur: 110°C

ELEKTRISCH

- ✗ Zuiver elektrische radiator in de fabriek voorgevuld
- ✗ Gemengde radiator

VIOLA-A VERTICAAL

In de soberheid toont zich de klasse

Een buizenradiator die naadloos combineert met elke woonstijl, door zijn sobere klasse en zijn vanzelfsprekend design. De strak gelijkende voorkant en de ingewerkte zijpanelen staan borg voor een uniforme look en een optimale warmteafgifte. Viola-A, zo simpel, krachtig en aantrekkelijk kan verwarmingscomfort zijn.

TECHNISCHE TEKENINGEN

- Zie p. 256

AANSLUITING

- ✗ Eénpuntsaansluiting voor éénpijpsysteem
 - ✗ Eénpuntsaansluiting voor tweepijpsysteem
 - ✓ Tweepuntsaansluiting voor éénpijpsysteem (aansluiting via de middenaansluiting) (zie p. 362)
 - ✓ Tweepuntsaansluiting voor tweepijpsysteem (standaard) (zie p. 362)
 - ✗ Geïntegreerd ventiel
- Aansluitingen: ½" (binnendraad)

AANBEVOLEN AANSLUITING (LM)

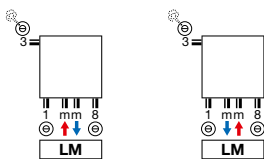

mm aansluiting alleen mogelijk bij even aantal buizen.
Andere aansluitmogelijkheden, zie p. 255

NEW



Ventielset haaks kleur

art. nr. 1182 105 0000 9016
prijs €201
 Andere kleuren, zie p. 366
 Koppelingen, zie p. 380



Thermostaatkop

Traffic White
 art. nr. 1182 030 0000 9016
prijs €40

AANBEVOLEN VOOR BADKAMER EN KEUKEN IN OPTIE



handdoekbeugel (RAL 9005)
 art. nr. zie p. 254

prijs €157
Andere accessoires, zie p. 254



HOE VIOLA-A VERTICAAL BESTELLEN

Leveringstermijn 15 - 30 werkdagen
(zonder transportduur)

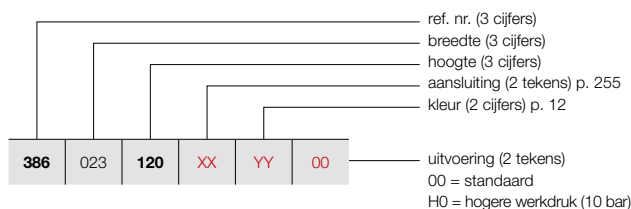

HOE VOORRAADRADIATOR VIOLA-A VERTICAAL BESTELLEN

Leveringstermijn 5 werkdagen
(zonder transportduur)

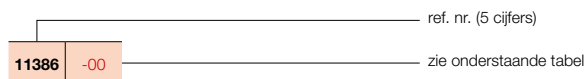

VIOLA-A VERTICAAL (V1-ZB-A)

225



V1-ZB-A

PRIJSGROEP: VPG2 - STAAL DESIGNRADIATOREN

BESTELCODE MAATWERK VIOLA-A VERTICAAL	TECHNISCHE GEGEVENS								STANDAARDKLEUR		ANDERE KLEUREN						
	buizen	breedte (L mm)	hoogte (H mm)	75/65/20 (Watt) (φ50K)	55/45/20 (Watt) (φ30K)	n-exp.	gewicht (kg)	inhoud (l)	el. weerst. (Watt)	prijs RAL 9016 (€)		verkorte ref. nr. RAL 9016 voorraad	prijs kleur (€)				
REF. NR. VIOLA-A VERTICAAL V1-ZB-A : 386																	
386	023	120	XX	YY	00	3	237	1200	371	189	1,32	7,80	2,40	-	404	-	465
		140				3	237	1400	427	218	1,32	9,00	2,73	-	442	-	508
		160				3	237	1600	483	246	1,32	9,90	3,03	-	478	-	550
		180				3	237	1800	535	273	1,32	11,10	3,33	-	516	-	593
		200				3	237	2000	589	301	1,30	12,30	3,60	-	552	-	635
		220				3	237	2200	640	327	1,28	13,50	3,90	-	582	-	669
		240				3	237	2400	689	352	1,27	14,40	4,20	-	622	-	715
386	031	120	XX	YY	00	4	317	1200	480	245	1,31	10,40	3,20	-	478	-	550
		140				4	317	1400	551	281	1,31	12,00	3,64	-	521	-	599
		160				4	317	1600	624	318	1,31	13,20	4,04	-	568	-	653
		180				4	317	1800	695	355	1,32	14,80	4,44	-	611	-	703
		200				4	317	2000	764	390	1,30	16,40	4,80	-	659	-	758
		220				4	317	2200	831	424	1,29	18,00	5,20	-	703	-	808
		240				4	317	2400	894	456	1,27	19,20	5,60	-	750	-	863
386	039	120	XX	YY	00	5	397	1200	585	298	1,31	13,00	4,00	-	552	-	635
		140				5	397	1400	673	343	1,31	15,00	4,55	-	605	-	696
		160				5	397	1600	762	389	1,31	16,50	5,05	-	659	-	758
		180				5	397	1800	850	434	1,31	18,50	5,55	-	712	-	819
		200				5	397	2000	936	478	1,30	20,50	6,00	-	766	-	881
		220				5	397	2200	1017	519	1,29	22,50	6,50	-	819	-	942
		240				5	397	2400	1094	558	1,28	24,00	7,00	-	875	-	1006
386	047	120	XX	YY	00	6	477	1200	689	352	1,31	15,60	4,80	-	622	-	715
		140				6	477	1400	792	404	1,31	18,00	5,46	-	681	-	783
		160				6	477	1600	897	458	1,31	19,80	6,06	-	750	-	863
		180				6	477	1800	1003	512	1,31	22,20	6,66	-	812	-	934
		200				6	477	2000	1104	563	1,30	24,60	7,20	-	875	11386-01	1006
		220				6	477	2200	1200	612	1,29	27,00	7,80	-	936	-	1076
		240				6	477	2400	1291	659	1,28	28,80	8,40	-	1001	-	1151
386	055	120	XX	YY	00	7	557	1200	790	403	1,30	18,20	5,60	-	692	-	796
		140				7	557	1400	909	464	1,31	21,00	6,37	-	763	-	877
		160				7	557	1600	1029	525	1,31	23,10	7,07	-	840	-	966
		180				7	557	1800	1154	589	1,31	25,90	7,77	-	913	-	1050
		200				7	557	2000	1269	647	1,30	28,70	8,40	-	983	-	1130
		220				7	557	2200	1380	704	1,29	31,50	9,10	-	1053	-	1211
		240				7	557	2400	1485	758	1,28	33,60	9,80	-	1128	-	1297
386	063	120	XX	YY	00	8	637	1200	891	455	1,30	20,80	6,40	-	763	-	877
		140				8	637	1400	1024	522	1,30	24,00	7,28	-	845	-	972
		160				8	637	1600	1159	591	1,31	26,40	8,08	-	927	-	1066
		180				8	637	1800	1302	664	1,31	29,60	8,88	-	1007	-	1158
		200				8	637	2000	1433	731	1,30	32,80	9,60	-	1091	-	1255
		220				8	637	2200	1557	794	1,29	36,00	10,40	-	1169	-	1344
		240				8	637	2400	1676	855	1,29	38,40	11,20	-	1253	-	1441

Conform EN442-1: 2014: radiatoren en convectoren

Voor meer details over onze artikel-data, zie artikel-database: <https://www.2ba.nl>

Voor de warmteafgiftes van andere regimes, kijkt u op p. 370 (correctiefactoren)
NEDERLAND. Prijzen in euro (excl. BTW)

VIOLA-A VERTICAAL (V1-ZB-A)



V1-ZB-A

HOE VIOLA-A VERTICAAL BESTELLEN

Leveringstermijn 15 - 30 werkdagen
(zonder transportduur)

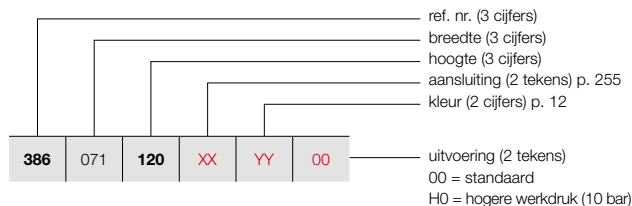

PRIJSGROEP: VPG2 - STAAL DESIGNRADIATOREN

BESTELCODE MAATWERK VIOLA-A VERTICAAL							TECHNISCHE GEGEVENS					STANDAARDKLEUR	ANDERE KLEUREN			
386	071	120	XX	YY	00	buizen	breedte (L mm)	hoogte (H mm)	75/65/20 (Watt) (Φ50K)	55/45/20 (Watt) (Φ30K)	n-exp.	gewicht (kg)	inhoud (l)	el. weerst. (Watt)	prijs RAL 9016 (€)	prijs kleur (€)
REF. NR. VIOLA-A VERTICAAL V1-ZB-A : 386																
386	071	120	XX	YY	00	9	717	1200	989	505	1,29	23,40	7,20	-	840	966
		140				9	717	1400	1137	580	1,30	27,00	8,19	-	927	1066
		160				9	717	1600	1288	657	1,31	29,70	9,09	-	1019	1172
		180				9	717	1800	1449	739	1,31	33,30	9,99	-	1105	1271
		200				9	717	2000	1594	813	1,30	36,90	10,80	-	1200	1380
		220				9	717	2200	1733	884	1,30	40,50	11,70	-	1290	1484
		240				9	717	2400	1864	951	1,29	43,20	12,60	-	1379	1586
386	079	120	XX	YY	00	10	797	1200	1087	555	1,29	26,00	8,00	-	912	1049
		140				10	797	1400	1249	637	1,30	30,00	9,10	-	1007	1158
		160				10	797	1600	1414	721	1,30	33,00	10,10	-	1105	1271
		180				10	797	1800	1594	813	1,31	37,00	11,10	-	1207	1388
		200				10	797	2000	1754	895	1,31	41,00	12,00	-	1305	1501
		220				10	797	2200	1906	972	1,30	45,00	13,00	-	1406	1617
		240				10	797	2400	2051	1046	1,29	48,00	14,00	-	1505	1731
386	087	120	XX	YY	00	11	877	1200	1183	604	1,28	28,60	8,80	-	982	1129
		140				11	877	1400	1360	694	1,29	33,00	10,01	-	1091	1255
		160				11	877	1600	1540	786	1,30	36,30	11,11	-	1199	1379
		180				11	877	1800	1738	887	1,31	40,70	12,21	-	1305	1501
		200				11	877	2000	1912	976	1,31	45,10	13,20	-	1417	1630
		220				11	877	2200	2078	1060	1,30	49,50	14,30	-	1522	1750
		240				11	877	2400	2236	1141	1,29	52,80	15,40	-	1631	1876
386	095	120	XX	YY	00	12	957	1200	1279	653	1,28	31,20	9,60	-	1053	1211
		140				12	957	1400	1470	750	1,29	36,00	10,92	-	1168	1343
		160				12	957	1600	1664	849	1,30	39,60	12,12	-	1288	1481
		180				12	957	1800	1881	960	1,31	44,40	13,32	-	1404	1615
		200				12	957	2000	2069	1056	1,31	49,20	14,40	-	1522	1750
		220				12	957	2200	2249	1147	1,30	54,00	15,60	-	1640	1886
		240				12	957	2400	2420	1235	1,30	57,60	16,80	-	1759	2023
386	103	120	XX	YY	00	13	1037	1200	1374	701	1,27	33,80	10,40	-	1199	1379
		140				13	1037	1400	1579	806	1,29	39,00	11,83	-	1333	1533
		160				13	1037	1600	1788	912	1,30	42,90	13,13	-	1464	1684
		180				13	1037	1800	2023	1032	1,31	48,10	14,43	-	1603	1843
		200				13	1037	2000	2225	1135	1,31	53,30	15,60	-	1740	2001
		220				13	1037	2200	2418	1234	1,30	58,50	16,90	-	1875	2156
		240				13	1037	2400	2602	1328	1,30	62,40	18,20	-	2011	2313

Conform EN442-1: 2014: radiatoren en convectoren

Voor meer details over onze artikel-data, zie artikel-database: <https://www.2ba.nl>

Voor de warmteafgifte van andere regimes, kijkt u op p. 370 (correctiefactoren)
NEDERLAND. Prijzen in euro (excl. BTW)

HOE VIOLA-A VERTICAAL BESTELLEN

Leveringstermijn 15 - 30 werkdagen
(zonder transportduur)

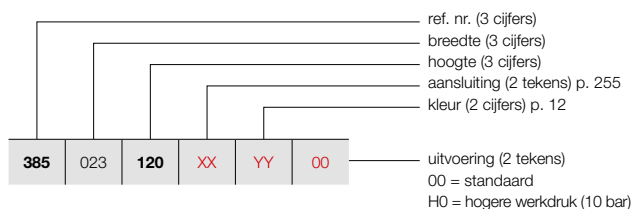

VIOLA-A VERTICAAL (V1L1-ZB-A)



V1L1-ZB-A

PRIJSGROEP: VPG2 - STAAL DESIGNRADIATOREN

BESTELCODE MAATWERK VIOLA-A VERTICAAL	TECHNISCHE GEGEVENS							STANDAARDKLEUR		ANDERE KLEUREN						
	buizen	breedte (L mm)	hoogte (H mm)	75/65/20 (Watt) (Φ50K)	55/45/20 (Watt) (Φ30K)	n-exp.	gewicht (kg)	inhoud (l)	el. weerst. (Watt)	prijs RAL 9016 (€)	prijs kleur (€)					
REF. NR. VIOLA-A VERTICAAL V1L1-ZB-A : 385																
385	023	120	XX	YY	00	3	237	1200	464	237	1,28	10,50	2,40	-	507	583
		140				3	237	1400	531	271	1,28	12,60	2,73	-	556	639
		160				3	237	1600	597	305	1,29	14,40	3,03	-	595	684
		180				3	237	1800	661	337	1,29	15,90	3,33	-	642	738
		200				3	237	2000	723	369	1,30	18,30	3,60	-	683	785
		220				3	237	2200	784	400	1,32	19,80	3,90	-	734	844
		240				3	237	2400	843	430	1,33	21,60	4,20	-	774	890
385	031	120	XX	YY	00	4	317	1200	605	309	1,28	14,00	3,20	-	595	684
		140				4	317	1400	693	354	1,29	16,80	3,64	-	653	751
		160				4	317	1600	778	397	1,29	19,20	4,04	-	710	817
		180				4	317	1800	861	439	1,29	21,20	4,44	-	766	881
		200				4	317	2000	943	481	1,31	24,40	4,80	-	822	945
		220				4	317	2200	1022	521	1,32	26,40	5,20	-	878	1010
		240				4	317	2400	1099	561	1,33	28,80	5,60	-	933	1073
385	039	120	XX	YY	00	5	397	1200	743	379	1,29	17,50	4,00	-	683	785
		140				5	397	1400	851	434	1,29	21,00	4,55	-	756	869
		160				5	397	1600	956	488	1,29	24,00	5,05	-	822	945
		180				5	397	1800	1058	540	1,30	26,50	5,55	-	891	1025
		200				5	397	2000	1158	591	1,31	30,50	6,00	-	960	1104
		220				5	397	2200	1255	640	1,32	33,00	6,50	-	1024	1178
		240				5	397	2400	1350	689	1,33	36,00	7,00	-	1092	1256
385	047	120	XX	YY	00	6	477	1200	879	448	1,29	21,00	4,80	-	774	890
		140				6	477	1400	1007	514	1,29	25,20	5,46	-	854	982
		160				6	477	1600	1131	577	1,30	28,80	6,06	-	933	1073
		180				6	477	1800	1252	639	1,30	31,80	6,66	-	1013	1165
		200				6	477	2000	1370	699	1,31	36,60	7,20	-	1092	1256
		220				6	477	2200	1485	758	1,32	39,60	7,80	-	1170	1346
		240				6	477	2400	1598	815	1,33	43,20	8,40	-	1252	1440
385	055	120	XX	YY	00	7	557	1200	1013	517	1,29	24,50	5,60	-	867	997
		140				7	557	1400	1160	592	1,30	29,40	6,37	-	959	1103
		160				7	557	1600	1303	665	1,30	33,60	7,07	-	1047	1204
		180				7	557	1800	1443	736	1,31	37,10	7,77	-	1139	1310
		200				7	557	2000	1579	806	1,31	42,70	8,40	-	1229	1413
		220				7	557	2200	1712	873	1,32	46,20	9,10	-	1318	1516
		240				7	557	2400	1841	939	1,33	50,40	9,80	-	1407	1618
385	063	120	XX	YY	00	8	637	1200	1146	585	1,29	28,00	6,40	-	959	1103
		140				8	637	1400	1312	669	1,30	33,60	7,28	-	1056	1214
		160				8	637	1600	1474	752	1,31	38,40	8,08	-	1158	1332
		180				8	637	1800	1632	833	1,31	42,40	8,88	-	1258	1447
		200				8	637	2000	1786	911	1,32	48,80	9,60	-	1365	1570
		220				8	637	2200	1936	988	1,32	52,80	10,40	-	1462	1681
		240				8	637	2400	2083	1063	1,33	57,60	11,20	-	1566	1801

Conform EN442-1: 2014: radiatoren en convectoren

Voor meer details over onze artikel-data, zie artikel-database: <https://www.2ba.nl>

Voor de warmteafgiftes van andere regimes, kijkt u op p. 370 (correctiefactoren)
 NEDERLAND. Prijzen in euro (excl. BTW)

STAAL DESIGNRADIATOREN

VIOLA-A VERTICAAL (V1L1-ZB-A)



V1L1-ZB-A

HOE VIOLA-A VERTICAAL BESTELLEN

Leveringstermijn 15 - 30 werkdagen
(zonder transportduur)

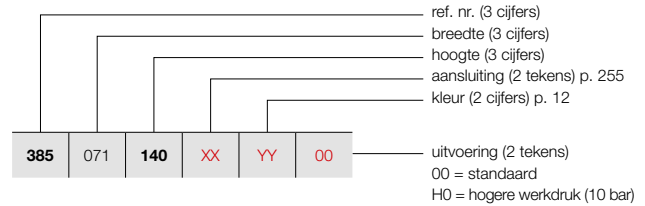

PRIJSGROEP: VPG2 - STAAL DESIGNRADIATOREN

BESTELCODE MAATWERK VIOLA-A VERTICAAL	TECHNISCHE GEGEVENS									STANDAARDKLEUR	ANDERE KLEUREN
	buizen	breedte (L mm)	hoogte (H mm)	75/65/20 (Watt) (Φ50K)	55/45/20 (Watt) (Φ30K)	n-exp.	gewicht (kg)	inhoud (l)	el. weerst. (Watt)	prijs RAL 9016 (€)	prijs kleur (€)
REF. NR. VIOLA-A VERTICAAL V1L1-ZB-A : 385											
385	071	140	XX	YY	00						
		160								1158	1332
		180								1273	1464
		200								1383	1590
		220								1497	1722
		240								1611	1853
										1723	1981
385	079	120	XX	YY	00						
		140								1137	1308
		160								1258	1447
		180								1383	1590
		200								1509	1735
		220								1632	1877
		240								1759	2023
										1882	2164
385	087	120	XX	YY	00						
		140								1228	1412
		160								1365	1570
		180								1496	1720
		200								1632	1877
		220								1771	2037
		240								1904	2190
										2040	2346
385	095	120	XX	YY	00						
		140								1318	1516
		160								1461	1680
		180								1609	1850
		200								1756	2019
		220								1904	2190
		240								2051	2359
										2196	2525
385	103	120	XX	YY	00						
		140								1496	1720
		160								1668	1918
		180								1833	2108
		200								2007	2308
		220								2174	2500
		240								2343	2694
										2515	2892

Conform EN442-1: 2014: radiatoren en convectoren

Voor meer details over onze artikel-data, zie artikel-database: <https://www.2ba.nl>
Voor de warmteafgiftes van andere regimes, kijkt u op p. 370 (correctiefactoren)
NEDERLAND. Prijzen in euro (excl. BTW)

HOE VIOLA-A VERTICAAL BESTELLEN

Leveringstermijn 15 - 30 werkdagen
(zonder transportduur)

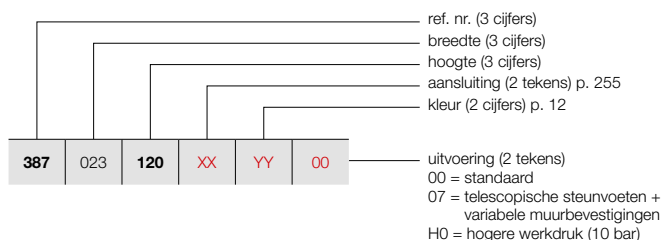

HOE VOORRAADRADIATOR VIOLA-A VERTICAAL BESTELLEN

Leveringstermijn 5 werkdagen
(zonder transportduur)

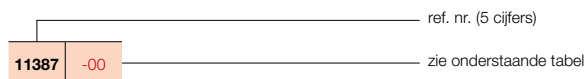

VIOLA-A VERTICAAL (V2-ZB-A)

229



V2-ZB-A

PRIJSGROEP: VPG2 - STAAL DESIGNRADIATOREN

BESTELCODE MAATWERK VIOLA-A VERTICAAL	TECHNISCHE GEGEVENS							STANDAARDKLEUR		ANDERE KLEUREN		
	buizen	breedte (L mm)	hoogte (H mm)	75/65/20 (Watt) (Φ50K)	55/45/20 (Watt) (Φ30K)	n-exp.	gewicht (kg)	inhoud (l)	el. weerst. (Watt)		prijs RAL 9016 (€)	verkorte ref. nr. RAL 9016 voorraad
REF. NR. VIOLA-A VERTICAAL V2-ZB-A : 387												
387 023 120 XX YY 00	3	237	1200	509	260	1,33	14,40	4,59	-	688	-	791
	3	237	1400	587	299	1,34	16,80	5,04	-	753	-	866
	3	237	1600	664	339	1,35	18,90	5,52	-	812	-	934
	3	237	1800	743	379	1,35	21,30	5,97	-	875	-	1006
	3	237	2000	821	419	1,35	23,40	6,39	-	932	-	1072
	3	237	2200	900	459	1,34	25,80	6,81	-	994	-	1143
	3	237	2400	979	499	1,34	28,20	7,23	-	1054	-	1212
387 031 120 XX YY 00	4	317	1200	655	334	1,33	19,20	6,12	-	812	-	934
	4	317	1400	755	385	1,34	22,40	6,72	-	887	-	1020
	4	317	1600	854	436	1,35	25,20	7,36	-	967	-	1112
	4	317	1800	952	486	1,35	28,40	7,96	-	1042	-	1198
	4	317	2000	1050	536	1,35	31,20	8,52	-	1116	-	1283
	4	317	2200	1147	585	1,35	34,40	9,08	-	1194	-	1373
	4	317	2400	1244	635	1,34	37,60	9,64	-	1272	-	1463
387 039 120 XX YY 00	5	397	1200	802	409	1,33	24,00	7,65	-	932	-	1072
	5	397	1400	923	471	1,34	28,00	8,40	-	1024	-	1178
	5	397	1600	1043	532	1,35	31,50	9,20	-	1116	-	1283
	5	397	1800	1162	593	1,36	35,50	9,95	-	1208	-	1389
	5	397	2000	1279	653	1,35	39,00	10,65	-	1302	-	1497
	5	397	2200	1394	711	1,35	43,00	11,35	-	1395	-	1604
	5	397	2400	1509	770	1,34	47,00	12,05	-	1489	-	1712
387 047 120 XX YY 00	6	477	1200	948	484	1,34	28,80	9,18	-	1054	-	1212
	6	477	1400	1092	557	1,34	33,60	10,08	-	1163	-	1337
	6	477	1600	1232	629	1,35	37,80	11,04	-	1272	-	1463
	6	477	1800	1371	699	1,36	42,60	11,94	-	1379	-	1586
	6	477	2000	1507	769	1,35	46,80	12,78	-	1489	-	1712
	6	477	2200	1642	838	1,35	51,60	13,62	-	1594	-	1833
	6	477	2400	1775	906	1,34	56,40	14,46	-	1698	-	1953
387 055 120 XX YY 00	7	557	1200	1094	558	1,34	33,60	10,71	-	1180	-	1357
	7	557	1400	1260	643	1,34	39,20	11,76	-	1299	-	1494
	7	557	1600	1422	726	1,35	44,10	12,88	-	1424	-	1638
	7	557	1800	1580	806	1,36	49,70	13,93	-	1546	-	1778
	7	557	2000	1736	886	1,36	54,60	14,91	-	1671	-	1922
	7	557	2200	1889	964	1,35	60,20	15,89	-	1789	-	2057
	7	557	2400	2040	1041	1,35	65,80	16,87	-	1914	-	2201
387 063 120 XX YY 00	8	637	1200	1240	633	1,34	38,40	12,24	-	1299	-	1494
	8	637	1400	1428	729	1,35	44,80	13,44	-	1437	-	1653
	8	637	1600	1611	822	1,35	50,40	14,72	-	1575	-	1811
	8	637	1800	1790	913	1,36	56,80	15,92	-	1715	-	1972
	8	637	2000	1965	1003	1,36	62,40	17,04	-	1855	11387-01	2133
	8	637	2200	2136	1090	1,35	68,80	18,16	-	1993	-	2292
	8	637	2400	2305	1176	1,35	75,20	19,28	-	2129	-	2448

Conform EN442-1: 2014: radiatoren en convectoren

Voor meer details over onze artikel-data, zie artikel-database: <https://www.2ba.nl>

Voor de warmteafgiftes van andere regimes, kijkt u op p. 370 (correctiefactoren)
NEDERLAND. Prijzen in euro (excl. BTW)

VIOLA-A VERTICAAL (V2-ZB-A)



V2-ZB-A

HOE VIOLA-A VERTICAAL BESTELLEN

Leveringstermijn 15 - 30 werkdagen
(zonder transportduur)

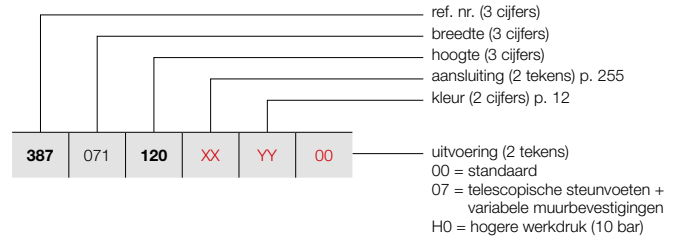

PRIJSGROEP: VPG2 - STAAL DESIGNRADIATOREN

BESTELCODE MAATWERK VIOLA-A VERTICAAL							TECHNISCHE GEGEVENS					STANDAARDKLEUR	ANDERE KLEUREN				
387	071	120	XX	YY	00	buizen	breedte (L mm)	hoogte (H mm)	75/65/20 (Watt) (Φ50K)	55/45/20 (Watt) (Φ30K)	n-exp.	gewicht (kg)	inhoud (l)	el. weerst. (Watt)	prijs RAL 9016 (€)	prijs kleur (€)	
REF. NR. VIOLA-A VERTICAAL V2-ZB-A : 387																	
387	071	120	XX	YY	00	9	717	1200	1387	708	1,34	43,20	13,77	-	1424	1638	
		140				9	717	1400	1596	814	1,35	50,40	15,12	-	1575	1811	
		160				9	717	1600	1801	919	1,36	56,70	16,56	-	1729	1988	
		180				9	717	1800	1999	1020	1,36	63,90	17,91	-	1882	2164	
		200				9	717	2000	2194	1119	1,36	70,20	19,17	-	2037	2343	
		220				9	717	2200	2384	1216	1,35	77,40	20,43	-	2191	2520	
		240				9	717	2400	2570	1311	1,35	84,60	21,69	-	2343	2694	
387	079	120	XX	YY	00	10	797	1200	1533	782	1,34	48,00	15,30	-	1545	1777	
		140				10	797	1400	1765	901	1,35	56,00	16,80	-	1715	1972	
		160				10	797	1600	1990	1015	1,36	63,00	18,40	-	1882	2164	
		180				10	797	1800	2209	1127	1,37	71,00	19,90	-	2053	2361	
		200				10	797	2000	2422	1236	1,36	78,00	21,30	-	2220	2553	
		220				10	797	2200	2631	1342	1,36	86,00	22,70	-	2389	2747	
		240				10	797	2400	2836	1447	1,35	94,00	24,10	-	2556	2939	
387	087	120	XX	YY	00	11	877	1200	1679	857	1,34	52,80	16,83	-	1669	1919	
		140				11	877	1400	1933	986	1,35	61,60	18,48	-	1855	2133	
		160				11	877	1600	2179	1112	1,36	69,30	20,24	-	2033	2338	
		180				11	877	1800	2418	1234	1,37	78,10	21,89	-	2220	2553	
		200				11	877	2000	2651	1353	1,36	85,80	23,43	-	2409	2770	
		220				11	877	2200	2878	1468	1,36	94,60	24,97	-	2588	2976	
		240				11	877	2400	3101	1582	1,35	103,40	26,51	-	2776	3192	
387	095	120	XX	YY	00	12	957	1200	1825	931	1,35	57,60	18,36	-	1789	2057	
		140				12	957	1400	2101	1072	1,35	67,20	20,16	-	1986	2284	
		160				12	957	1600	2369	1209	1,36	75,60	22,08	-	2189	2517	
		180				12	957	1800	2628	1341	1,37	85,20	23,88	-	2387	2745	
		200				12	957	2000	2880	1469	1,36	93,60	25,56	-	2588	2976	
		220				12	957	2200	3126	1595	1,36	103,20	27,24	-	2788	3206	
		240				12	957	2400	3366	1717	1,36	112,80	28,92	-	2989	3437	
387	103	120	XX	YY	00	13	1037	1200	1972	1006	1,35	62,40	19,89	-	2033	2338	
		140				13	1037	1400	2270	1158	1,36	72,80	21,84	-	2265	2605	
		160				13	1037	1600	2558	1305	1,36	81,90	23,92	-	2495	2869	
		180				13	1037	1800	2837	1447	1,37	92,30	25,87	-	2726	3135	
		200				13	1037	2000	3109	1586	1,37	101,40	27,69	-	2955	3398	
		220				13	1037	2200	3373	1721	1,36	111,80	29,51	-	3187	3665	
		240				13	1037	2400	3631	1853	1,36	122,20	31,33	-	3417	3930	

Conform EN442-1: 2014: radiatoren en convectoren

Voor meer details over onze artikel-data, zie artikel-database: <https://www.2ba.nl>
Voor de warmteafgifte van andere regimes, kijkt u op p. 370 (correctiefactoren)
NEDERLAND. Prijzen in euro (excl. BTW)

TYPES

- H1-RO-A enkele rij buizen, H2-RO-A dubbele rij buizen, H1L1-RO-A, H2L1-RO-A, H2L2-RO-A (1 of 2 rijen stalen lamellen)

BUIZEN

- Horizontaal, rechthoekig 77 x 10 mm

COLLECTOREN

- H1-RO-A en H1L1-RO-A: 35 x 43 mm
- H2-RO-A en H2L1-RO-A: 35 x 41 mm
- H2L2-RO-A: 35 x 81 mm

KLEUREN

- Standaardkleur wit RAL 9016
- Uitgebreide kleurenkaart zie p. 12

SPECIAAL

- Bij types H1L1-RO-A / H2L1-RO-A en H2L2-RO-A zijn 1 of 2 rijen stalen lamellen ter verhoging van de warmteafgifte op de platovale buizen gepuntlast.
- Standaard met rooster.
- H1L1-RO-A ook verkrijgbaar als toiletradiator (500 x 400 mm)

BEVESTIGINGEN

- Muurbevestigingen standaard (inbegrepen in de verpakking van de radiator)
- Bovenste beugel in kleur van de radiator, onderaan:
 - Afstandshouder radiator wit = afstandshouder wit.
 - Afstandshouder radiator in kleur = afstandshouder RAL 7024.
- **H2-RO-A/H2L1-RO-A:** Radiator met telescopische steunvoeten + variabele muurbevestiging: gelieve bij bestelling code **07** aan te geven bij "Afwerking" (zie p. 252).
- **H2-RO-A/H2L1-RO-A:** Ook verkrijgbaar als vrijstaande radiator (zie p. 253)

TECHNISCH

- Weerstandsgelast (onzichtbare lasnaden)
- ATL-grondlaag, poedercoating
- Standaardwerkdruk: 4 bar. Meerprijs hogere werkdruk (10 bar): +10%.
- De leveringstermijn van radiator met een hogere werkdruk is 1 week extra.
- Maximale bedrijfstemperatuur: 110°C

ELEKTRISCH

- ✗ Zuiver elektrische radiator in de fabriek voorgevuld
- ✗ Gemengde radiator

TECHNISCHE TEKENINGEN

- Zie p. 257

AANSLUITING

- ✗ Eénpuntsaansluiting voor éénpijpsysteem
- ✗ Eénpuntsaansluiting voor tweepijpsysteem
- ✓ Tweepuntsaansluiting voor éénpijpsysteem (aansluiting via het geïntegreerd ventiel) (zie p. 363)
- ✓ Tweepuntsaansluiting voor tweepijpsysteem (standaard) (zie p. 362)
- ✓ Geïntegreerd ventiel (**meerprijs €120**) (radiator speciaal te bestellen) (zie p. 363)
- Aansluitingen: 1/2" (binnendraad)



STAAL DESIGNRADIATOREN

VIOLA-A HORIZONTAAL

In het verlengde van een grote traditie

Ook de Viola-A Horizontaal combineert, net als de Viola-A Verticaal een sobere, uniforme look met een optimale warmteafgifte. De radiator is beschikbaar in enkele en dubbele uitvoering. Het design is sober en overal toepasbaar. Kan ook in een vrijstaande opstelling worden geïnstalleerd.

**AANBEVOLEN AANSLUITING
GEÏNTEGREERD VENTIEL (MEERPRIJS)**

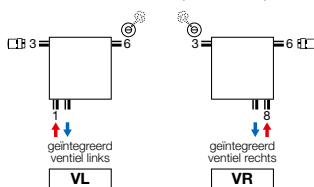

Meerprijs: €120 (zie p. 363)
Andere aansluitmogelijkheden, zie p. 255
Thermostaatkop apart te bestellen



art. nr. 1182 301 0000 0099
prijs €173
 Koppelingen, zie p. 377



art. nr. 11911630102
prijs €54
Thermostaatkop apart te bestellen

**AANBEVOLEN VOOR BADKAMER EN KEUKEN
IN OPTIE**



handdoekbeugel (RAL 9005)
 art. nr. zie p. 254
prijs €157
Andere accessoires, zie p. 254



H2-RO-A / H2L1-RO-A

VIOLA-A HORIZONTAAL (H1-RO-A)



H1-RO-A
(thermostaatkop apart te bestellen)

HOE VIOLA-A HORIZONTAAL BESTELLEN

Leveringstermijn 15 - 30 werkdagen
(zonder transportduur)

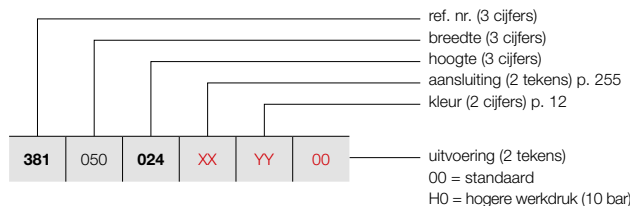

PRIJSGROEP: VPG2 - STAAL DESIGNRADIATOREN

BESTELCODE MAATWERK VIOLA-A HORIZONTAAL	TECHNISCHE GEGEVENS									STANDAARDKLEUR	ANDERE KLEUREN
	buizen	breedte (L mm)	hoogte (H mm)	75/65/20 (Watt) (Ø50K)	55/45/20 (Watt) (Ø30K)	n-exp.	gewicht (kg)	inhoud (l)	el. weerst. (Watt)	prijs RAL 9016 (€)	prijs kleur (€)
REF. NR. VIOLA-A HORIZONTAAL H1-RO-A : 381											
381	050	024	XX	YY	00						
		032								305	351
		040								465	397
		048								505	563
		056								544	608
		064								468	538
		072								506	582
		080								547	629
		088								586	674
										627	721
381	060	024	XX	YY	00						
		032								327	376
		040								372	428
		048								416	478
		056								463	532
		064								627	703
		072								678	762
		080								598	688
		088								645	742
										688	791
381	070	024	XX	YY	00						
		032								353	406
		040								401	461
		048								448	515
		056								500	695
		064								553	636
		072								602	692
		080								650	748
		088								697	802
										752	865
381	080	024	XX	YY	00						
		032								379	436
		040								431	496
		048								485	558
		056								537	618
		064								590	679
		072								649	746
		080								821	926
		088								757	871
										811	1053
381	090	024	XX	YY	00						
		032								401	461
		040								461	530
		048								519	597
		056								578	665
		064								634	729
		072								692	796
		080								754	867
		088								812	934
										872	1003

Conform EN442-1: 2014: radiatoren en convectoren

Voor meer details over onze artikel-data, zie artikel-database: <https://www.2ba.nl>

Voor de warmteafgiftes van andere regimes, kijkt u op p. 370 (correctiefactoren)
NEDERLAND. Prijzen in euro (excl. BTW)

HOE VIOLA-A HORIZONTAAL BESTELLEN

Leveringstermijn 15 - 30 werkdagen
(zonder transportduur)

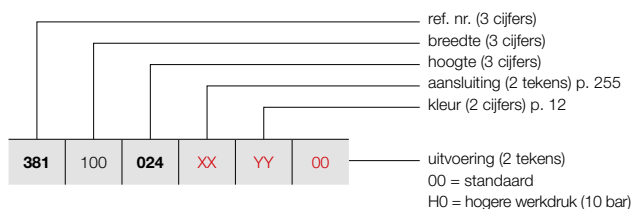

VIOLA-A HORIZONTAAL (H1-RO-A)

233



H1-RO-A
(thermostaatkop apart te bestellen)

PRIJSGROEP: VPG2 - STAAL DESIGNRADIATOREN

BESTELCODE MAATWERK VIOLA-A HORIZONTAAL	TECHNISCHE GEGEVENS							STANDAARDKLEUR	ANDERE KLEUREN			
	buizen	breedte (L mm)	hoogte (H mm)	75/65/20 (Watt) (φ50K)	55/45/20 (Watt) (φ30K)	n-exp.	gewicht (kg)			inhoud (l)	el. weerst. (Watt)	prijs RAL 9016 (€)
REF. NR. VIOLA-A HORIZONTAAL H1-RO-A : 381												
381 100 024 XX YY 00	3	1000	240	281	143	1,25	6,30	2,00	-	426	490	
	4	1000	320	358	183	1,25	6,50	2,80	-	487	560	
	5	1000	400	445	227	1,26	11,00	3,40	-	556	639	
	6	1000	480	532	271	1,26	13,20	4,10	-	614	706	
	7	1000	560	619	316	1,26	15,40	4,80	-	677	779	
	8	1000	640	705	360	1,26	17,60	5,50	-	740	851	
	9	1000	720	791	404	1,26	19,80	6,20	-	808	929	
	10	1000	800	876	447	1,26	22,00	7,00	-	870	1001	
	11	1000	880	961	490	1,27	24,20	7,70	-	930	1070	
	381 110 024 XX YY 00	3	1100	240	309	158	1,25	6,93	2,20	-	447	514
		4	1100	320	394	201	1,25	7,15	3,08	-	518	596
5		1100	400	490	250	1,26	12,10	3,74	-	582	669	
6		1100	480	585	299	1,26	14,52	4,51	-	653	751	
7		1100	560	681	347	1,26	16,94	5,28	-	843	831	
8		1100	640	776	396	1,26	19,36	6,05	-	790	909	
9		1100	720	870	444	1,26	21,78	6,82	-	856	984	
10		1100	800	964	492	1,26	24,20	7,70	-	923	1061	
11		1100	880	1057	539	1,27	26,62	8,47	-	991	1140	
381 120 024 XX YY 00		3	1200	240	337	172	1,25	7,56	2,40	-	474	545
		4	1200	320	430	219	1,25	7,80	3,36	-	547	629
	5	1200	400	534	272	1,26	13,20	4,08	-	620	713	
	6	1200	480	638	326	1,26	15,84	4,92	-	811	795	
	7	1200	560	743	379	1,26	18,48	5,76	-	761	875	
	8	1200	640	846	432	1,26	21,12	6,60	-	834	959	
	9	1200	720	949	484	1,26	23,76	7,44	-	912	1049	
	10	1200	800	1051	536	1,26	26,40	8,40	-	982	1129	
	11	1200	880	1153	588	1,27	29,04	9,24	-	1053	1211	
	381 140 024 XX YY 00	3	1400	240	393	201	1,25	8,82	2,80	-	521	599
		4	1400	320	501	256	1,25	9,10	3,92	-	607	698
5		1400	400	623	318	1,26	15,40	4,76	-	686	789	
6		1400	480	745	380	1,26	18,48	5,74	-	767	882	
7		1400	560	867	442	1,26	21,56	6,72	-	849	976	
8		1400	640	987	504	1,26	24,64	7,70	-	930	1070	
9		1400	720	1107	565	1,26	27,72	8,68	-	1012	1164	
10		1400	800	1226	626	1,26	30,80	9,80	-	1094	1258	
11		1400	880	1345	686	1,27	33,88	10,78	-	1172	1348	
381 160 024 XX YY 00		3	1600	240	450	229	1,25	10,08	3,20	-	574	660
		4	1600	320	573	292	1,25	10,40	4,48	-	664	764
	5	1600	400	712	363	1,26	17,60	5,44	-	754	867	
	6	1600	480	851	434	1,26	21,12	6,56	-	844	971	
	7	1600	560	990	505	1,26	24,64	7,68	-	933	1073	
	8	1600	640	1128	576	1,26	28,16	8,80	-	1023	1176	
	9	1600	720	1266	646	1,26	31,68	9,92	-	1115	1282	
	10	1600	800	1402	715	1,26	35,20	11,20	-	1205	1386	
	11	1600	880	1538	784	1,27	38,72	12,32	-	1294	1488	

Conform EN442-1: 2014: radiatoren en convectoren

Voor meer details over onze artikel-data, zie artikel-database: <https://www.2ba.nl>

Voor de warmteafgiftes van andere regimes, kijkt u op p. 370 (correctiefactoren)
NEDERLAND. Prijzen in euro (excl. BTW)

VIOLA-A HORIZONTAAL (H1-RO-A)



H1-RO-A
(thermostaatkop apart te bestellen)

HOE VIOLA-A HORIZONTAAL BESTELLEN

Leveringstermijn 15 - 30 werkdagen
(zonder transportduur)

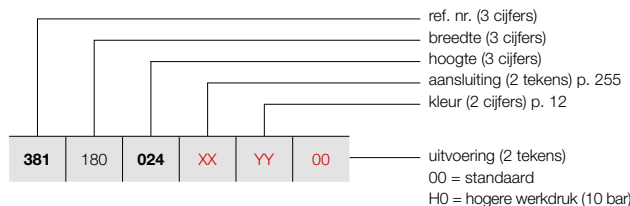

PRIJSGROEP: VPG2 - STAAL DESIGNRADIATOREN

BESTELCODE MAATWERK VIOLA-A HORIZONTAAL							TECHNISCHE GEGEVENS					STANDAARDKLEUR	ANDERE KLEUREN			
buizen	breedte (L mm)	hoogte (H mm)	75/65/20 (Watt) (Φ50K)	55/45/20 (Watt) (Φ30K)	n-exp.	gewicht (kg)	inhoud (l)	el. weerst. (Watt)	prijs RAL 9016 (€)	prijs kleur (€)						
REF. NR. VIOLA-A HORIZONTAAL H1-RO-A : 381																
381	180	024	XX	YY	00	3	1800	240	506	258	1,25	11,34	3,60	-	622	715
		032				4	1800	320	644	329	1,25	11,70	5,04	-	723	831
		040				5	1800	400	801	409	1,26	19,80	6,12	-	819	942
		048				6	1800	480	958	489	1,26	23,76	7,38	-	921	1059
		056				7	1800	560	1114	568	1,26	27,72	8,64	-	1020	1173
		064				8	1800	640	1269	647	1,26	31,68	9,90	-	1118	1286
		072				9	1800	720	1424	726	1,26	35,64	11,16	-	1217	1400
		080				10	1800	800	1577	804	1,26	39,60	12,60	-	1320	1518
		088				11	1800	880	1730	883	1,27	43,56	13,86	-	1419	1632
381	200	024	XX	YY	00	3	2000	240	562	287	1,25	12,60	4,00	-	670	771
		032				4	2000	320	716	365	1,25	13,00	5,60	-	779	896
		040				5	2000	400	890	454	1,26	22,00	6,80	-	887	1020
		048				6	2000	480	1064	543	1,26	26,40	8,20	-	995	1144
		056				7	2000	560	1238	632	1,26	30,80	9,60	-	1224	1270
		064				8	2000	640	1410	719	1,26	35,20	11,00	-	1211	1393
		072				9	2000	720	1582	807	1,26	39,60	12,40	-	1323	1521
		080				10	2000	800	1752	894	1,26	44,00	14,00	-	1431	1646
		088				11	2000	880	1922	981	1,27	48,40	15,40	-	1541	1772
381	220	024	XX	YY	00	3	2200	240	618	315	1,25	13,86	4,40	-	720	828
		032				4	2200	320	788	402	1,25	14,30	6,16	-	840	966
		040				5	2200	400	979	499	1,26	24,20	7,48	-	958	1102
		048				6	2200	480	1170	597	1,26	29,04	9,02	-	1074	1235
		056				7	2200	560	1362	695	1,26	33,88	10,56	-	1189	1367
		064				8	2200	640	1551	791	1,26	38,72	12,10	-	1309	1505
		072				9	2200	720	1740	888	1,26	43,56	13,64	-	1425	1639
		080				10	2200	800	1927	983	1,26	48,40	15,40	-	1543	1774
		088				11	2200	880	2114	1079	1,27	53,24	16,94	-	1659	1908
381	240	024	XX	YY	00	3	2400	240	674	344	1,25	15,12	4,80	-	767	882
		032				4	2400	320	859	438	1,25	15,60	6,72	-	897	1032
		040				5	2400	400	1068	545	1,26	26,40	8,16	-	1022	1175
		048				6	2400	480	1277	651	1,26	31,68	9,84	-	1148	1320
		056				7	2400	560	1486	758	1,26	36,96	11,52	-	1276	1467
		064				8	2400	640	1692	863	1,26	42,24	13,20	-	1403	1613
		072				9	2400	720	1898	969	1,26	47,52	14,88	-	1533	1763
		080				10	2400	800	2102	1073	1,26	52,80	16,80	-	1656	1904
		088				11	2400	880	2306	1177	1,27	58,08	18,48	-	1782	2049
381	260	024	XX	YY	00	3	2600	240	731	373	1,25	16,38	5,20	-	815	937
		032				4	2600	320	931	475	1,25	16,90	7,28	-	956	1099
		040				5	2600	400	1157	590	1,26	28,60	8,84	-	1090	1254
		048				6	2600	480	1383	706	1,26	34,32	10,66	-	1227	1411
		056				7	2600	560	1609	821	1,26	40,04	12,48	-	1363	1567
		064				8	2600	640	1833	935	1,26	45,76	14,30	-	1496	1720
		072				9	2600	720	2057	1049	1,26	51,48	16,12	-	1632	1877
		080				10	2600	800	2278	1162	1,26	57,20	18,20	-	1769	2034
		088				11	2600	880	2499	1275	1,27	62,92	20,02	-	1905	2191

Conform EN442-1: 2014: radiatoren en convectoren

Voor meer details over onze artikel-data, zie artikel-database: <https://www.2ba.nl>

Voor de warmteafgiftes van andere regimes, kijkt u op p. 370 (correctiefactoren)
NETERLAND. Prijzen in euro (excl. BTW)

HOE VIOLA-A HORIZONTAAL BESTELLEN

Leveringstermijn 15 - 30 werkdagen
(zonder transportduur)

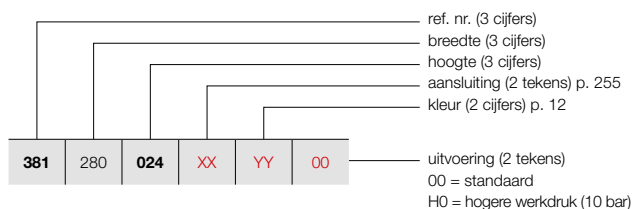

VIOLA-A HORIZONTAAL (H1-RO-A)

235



H1-RO-A
(thermostaatkop apart te bestellen)

PRIJSGROEP: VPG2 - STAAL DESIGNRADIATOREN

BESTELCODE MAATWERK VIOLA-A HORIZONTAAL	TECHNISCHE GEGEVENS							STANDAARDKLEUR		ANDERE KLEUREN	
	buizen	breedte (L mm)	hoogte (H mm)	75/65/20 (Watt) (Φ50K)	55/45/20 (Watt) (Φ30K)	n-exp.	gewicht (kg)	inhoud (l)	el. weerst. (Watt)	prijs RAL 9016 (€)	prijs kleur (€)
REF. NR. VIOLA-A HORIZONTAAL H1-RO-A : 381											
381	280	024	XX	YY	00						
		032								864	994
		040								1011	1163
		048								1156	1329
		056								1301	1496
		064								1447	1664
		072								1593	1832
		080								1738	1999
		088								1881	2163
										2027	2331
381	300	024	XX	YY	00						
		032								916	1053
		040								1071	1232
		048								1226	1410
		056								1378	1585
		064								1534	1764
		072								1686	1939
		080								1838	2114
		088								1994	2293
										2149	2471

Conform EN442-1: 2014: radiatoren en convectoren

Voor meer details over onze artikel-data, zie artikel-database: <https://www.2ba.nl>
Voor de warmteafgiftes van andere regimes, kijkt u op p. 370 (correctiefactoren)
NETERLAND. Prijzen in euro (excl. BTW)

VIOLA-A HORIZONTAAL (H1L1-RO-A)



H1L1-RO-A
(thermostaatkop apart te bestellen)

HOE VIOLA-A HORIZONTAAL BESTELLEN

Leveringstermijn 15 - 30 werkdagen
(zonder transportduur)

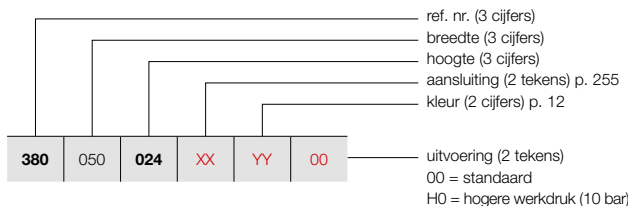

PRIJSGROEP: VPG2 - STAAL DESIGNRADIATOREN

BESTELCODE MAATWERK VIOLA-A HORIZONTAAL	TECHNISCHE GEGEVENS									STANDAARDKLEUR	ANDERE KLEUREN
	buizen	breedte (L mm)	hoogte (H mm)	75/65/20 (Watt) (Φ50K)	55/45/20 (Watt) (Φ30K)	n-exp.	gewicht (kg)	inhoud (l)	el. weerst. (Watt)	prijs RAL 9016 (€)	prijs kleur (€)
REF. NR. VIOLA-A HORIZONTAAL H1L1-RO-A : 380											
380	050	024	XX	YY	00						
		032								349	401
		040								401	461
		048								574	642
		056								507	583
		064								562	646
		072								611	703
		080								668	768
		088								720	948
										769	884
380	060	024	XX	YY	00						
		032								381	438
		040								442	508
		048								621	696
		056								562	646
		064								622	715
		072								680	782
		080								740	851
		088								804	925
										860	989
380	070	024	XX	YY	00						
		032								415	477
		040								484	557
		048								552	635
		056								614	706
		064								801	783
		072								872	985
		080								815	937
		088								883	1015
										949	1091
380	080	024	XX	YY	00						
		032								447	514
		040								521	599
		048								595	684
		056								671	772
		064								744	856
		072								937	1060
		080								893	1027
		088								967	1112
										1161	1317
380	090	024	XX	YY	00						
		032								484	557
		040								564	649
		048								646	743
		056								725	834
		064								809	930
		072								887	1020
		080								968	1113
		088								1048	1205
										1131	1301

Conform EN442-1: 2014: radiatoren en convectoren

Voor meer details over onze artikel-data, zie artikel-database: <https://www.2ba.nl>

Voor de warmteafgiftes van andere regimes, kijkt u op p. 370 (correctiefactoren)
NEDERLAND. Prijzen in euro (excl. BTW)

HOE VIOLA-A HORIZONTAAL BESTELLEN

Leveringstermijn 15 - 30 werkdagen
(zonder transportduur)

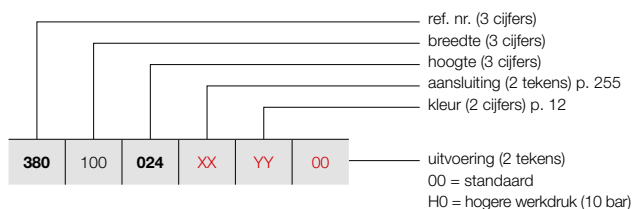

VIOLA-A HORIZONTAAL (H1L1-RO-A)

237



H1L1-RO-A
(thermostaatkop apart te bestellen)

PRIJSGROEP: VPG2 - STAAL DESIGNRADIATOREN

BESTELCODE MAATWERK VIOLA-A HORIZONTAAL	TECHNISCHE GEGEVENS							STANDAARDKLEUR		ANDERE KLEUREN		
	buizen	breedte (L mm)	hoogte (H mm)	75/65/20 (Watt) (φ50K)	55/45/20 (Watt) (φ30K)	n-exp.	gewicht (kg)	inhoud (l)	el. weerst. (Watt)	prijs RAL 9016 (€)	prijs kleur (€)	
REF. NR. VIOLA-A HORIZONTAAL H1L1-RO-A : 380												
380 100 024 XX YY 00	3	1000	240	522	266	1,24	10,90	2,00	-	518	596	
	4	1000	320	668	341	1,26	14,60	2,80	-	607	698	
	5	1000	400	798	407	1,27	18,20	3,40	-	691	795	
	6	1000	480	928	473	1,28	21,90	4,10	-	780	897	
	7	1000	560	1059	540	1,30	25,50	4,80	-	870	1001	
	8	1000	640	1162	593	1,30	29,20	5,50	-	958	1102	
	9	1000	720	1235	630	1,30	31,40	6,20	-	1045	1202	
	10	1000	800	1368	698	1,31	36,50	7,00	-	1131	1301	
	11	1000	880	1438	734	1,31	38,70	7,70	-	1217	1400	
	380 110 024 XX YY 00	3	1100	240	574	293	1,24	11,99	2,20	-	553	636
		4	1100	320	735	375	1,26	16,06	3,08	-	646	743
5		1100	400	878	448	1,27	20,02	3,74	-	739	850	
6		1100	480	1021	521	1,28	24,09	4,51	-	833	958	
7		1100	560	1165	594	1,30	28,05	5,28	-	929	1068	
8		1100	640	1278	652	1,30	32,12	6,05	-	1023	1176	
9		1100	720	1359	693	1,30	34,54	6,82	-	1116	1283	
10		1100	800	1505	768	1,31	40,15	7,70	-	1211	1393	
11		1100	880	1582	807	1,31	42,57	8,47	-	1309	1505	
380 120 024 XX YY 00		3	1200	240	626	320	1,24	13,08	2,40	-	582	669
		4	1200	320	802	409	1,26	17,52	3,36	-	686	789
	5	1200	400	958	489	1,27	21,84	4,08	-	788	906	
	6	1200	480	1114	568	1,28	26,28	4,92	-	891	1145	
	7	1200	560	1271	648	1,30	30,60	5,76	-	991	1140	
	8	1200	640	1394	711	1,30	35,04	6,60	-	1092	1256	
	9	1200	720	1482	756	1,30	37,68	7,44	-	1194	1373	
	10	1200	800	1642	838	1,31	43,80	8,40	-	1294	1488	
	11	1200	880	1726	880	1,31	46,44	9,24	-	1397	1607	
	380 140 024 XX YY 00	3	1400	240	731	373	1,24	15,26	2,80	-	652	750
		4	1400	320	935	477	1,26	20,44	3,92	-	767	882
5		1400	400	1117	570	1,27	25,48	4,76	-	883	1015	
6		1400	480	1299	663	1,28	30,66	5,74	-	1000	1150	
7		1400	560	1483	756	1,30	35,70	6,72	-	1114	1401	
8		1400	640	1627	830	1,30	40,88	7,70	-	1229	1413	
9		1400	720	1729	882	1,30	43,96	8,68	-	1343	1544	
10		1400	800	1915	977	1,31	51,10	9,80	-	1459	1678	
11		1400	880	2013	1027	1,31	54,18	10,78	-	1572	1808	
380 160 024 XX YY 00		3	1600	240	835	426	1,24	17,44	3,20	-	723	831
		4	1600	320	1069	545	1,26	23,36	4,48	-	849	976
	5	1600	400	1277	651	1,27	29,12	5,44	-	979	1126	
	6	1600	480	1485	758	1,28	35,04	6,56	-	1105	1271	
	7	1600	560	1694	864	1,30	40,80	7,68	-	1237	1423	
	8	1600	640	1859	949	1,30	46,72	8,80	-	1367	1572	
	9	1600	720	1976	1008	1,30	50,24	9,92	-	1494	1718	
	10	1600	800	2189	1117	1,31	58,40	11,20	-	1625	1869	
	11	1600	880	2301	1174	1,31	61,92	12,32	-	1755	2018	

Conform EN442-1: 2014: radiatoren en convectoren

Voor meer details over onze artikel-data, zie artikel-database: <https://www.2ba.nl>

Voor de warmteafgiftes van andere regimes, kijkt u op p. 370 (correctiefactoren)
NEDERLAND. Prijzen in euro (excl. BTW)

VIOLA-A HORIZONTAAL (H1L1-RO-A)



H1L1-RO-A
(thermostaatkop apart te bestellen)

HOE VIOLA-A HORIZONTAAL BESTELLEN

Leveringstermijn 15 - 30 werkdagen
(zonder transportduur)

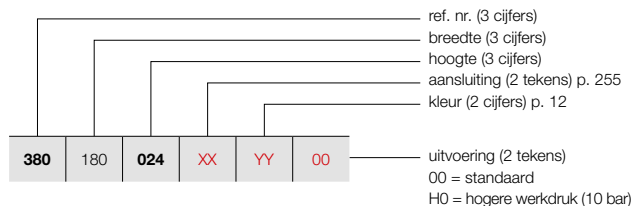

PRIJSGROEP: VPG2 - STAAL DESIGNRADIATOREN

BESTELCODE MAATWERK VIOLA-A HORIZONTAAL	TECHNISCHE GEGEVENS									STANDAARDKLEUR	ANDERE KLEUREN
	buizen	breedte (L mm)	hoogte (H mm)	75/65/20 (Watt) (Ø50K)	55/45/20 (Watt) (Ø30K)	n-exp.	gewicht (kg)	inhoud (l)	el. weerst. (Watt)	prijs RAL 9016 (€)	prijs kleur (€)
REF. NR. VIOLA-A HORIZONTAAL H1L1-RO-A : 380											
380	180	024	XX	YY	00						
		032								790	909
		040								930	1070
		048								1075	1236
		056								1217	1400
		064								1362	1566
		072								1504	1730
		080								1648	1895
		088								1787	2055
										1930	2220
380	200	024	XX	YY	00						
		032								856	984
		040								1013	1165
		048								1168	1343
		056								1329	1528
		064								1484	1707
		072								1640	1886
		080								1799	2069
		088								1953	2246
										2111	2428
380	220	024	XX	YY	00						
		032								923	1061
		040								1095	1259
		048								1260	1449
		056								1436	1651
		064								1608	1849
		072								1777	2044
		080								1949	2241
		088								2118	2436
										2291	2635
380	240	024	XX	YY	00						
		032								991	1140
		040								1174	1350
		048								1363	1567
		056								1545	1777
		064								1729	1988
		072								1911	2198
		080								2098	2413
		088								2282	2624
										2468	2838
380	260	024	XX	YY	00						
		032								1061	1220
		040								1256	1444
		048								1456	1674
		056								1655	1903
		064								1855	2133
		072								2051	2359
		080								2251	2589
		088								2446	2813
										2647	3044

Conform EN442-1: 2014: radiatoren en convectoren

Voor meer details over onze artikel-data, zie artikel-database: <https://www.2ba.nl>

Voor de warmteafgiftes van andere regimes, kijkt u op p. 370 (correctiefactoren)
NEDERLAND. Prijzen in euro (excl. BTW)

HOE VIOLA-A HORIZONTAAL BESTELLEN

Leveringstermijn 15 - 30 werkdagen
(zonder transportduur)

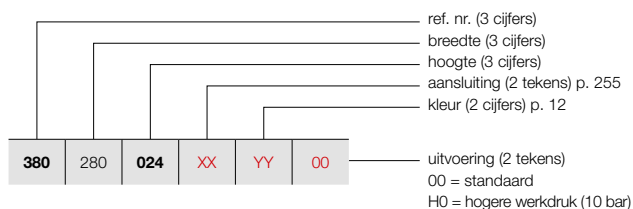

VIOLA-A HORIZONTAAL (H1L1-RO-A)

239



H1L1-RO-A
(thermostaatkop apart te bestellen)

PRIJSGROEP: VPG2 - STAAL DESIGNRADIATOREN

BESTELCODE MAATWERK VIOLA-A HORIZONTAAL	TECHNISCHE GEGEVENS								STANDAARDKLEUR		ANDERE KLEUREN					
	buizen	breedte (L mm)	hoogte (H mm)	75/65/20 (Watt) (Φ50K)	55/45/20 (Watt) (Φ30K)	n-exp.	gewicht (kg)	inhoud (l)	el. weerst. (Watt)	prijs RAL 9016 (€)	prijs kleur (€)					
REF. NR. VIOLA-A HORIZONTAAL H1L1-RO-A : 380																
380	280	024	XX	YY	00	3	2800	240	1462	746	1,24	30,52	5,60	-	1129	1298
		032				4	2800	320	1870	954	1,26	40,88	7,84	-	1338	1539
		040				5	2800	400	2234	1140	1,27	50,96	9,52	-	1550	1783
		048				6	2800	480	2598	1326	1,28	61,32	11,48	-	1764	2029
		056				7	2800	560	2965	1513	1,30	71,40	13,44	-	1977	2274
		064				8	2800	640	3254	1660	1,30	81,76	15,40	-	2189	2517
		072				9	2800	720	3458	1764	1,30	87,92	17,36	-	2398	2758
		080				10	2800	800	3830	1954	1,31	102,20	19,60	-	2615	3007
		088				11	2800	880	4026	2054	1,31	108,36	21,56	-	2825	3249
380	300	024	XX	YY	00	3	3000	240	1566	799	1,24	32,70	6,00	-	1198	1378
		032				4	3000	320	2004	1022	1,26	43,80	8,40	-	1422	1635
		040				5	3000	400	2394	1221	1,27	54,60	10,20	-	1649	1896
		048				6	3000	480	2784	1420	1,28	65,70	12,30	-	1871	2152
		056				7	3000	560	3177	1621	1,30	76,50	14,40	-	2098	2413
		064				8	3000	640	3486	1779	1,30	87,60	16,50	-	2325	2674
		072				9	3000	720	3705	1890	1,30	94,20	18,60	-	2548	2930
		080				10	3000	800	4104	2094	1,31	109,50	21,00	-	2778	3195
		088				11	3000	880	4314	2201	1,31	116,10	23,10	-	3002	3452

Conform EN442-1: 2014: radiatoren en convectoren

Voor meer details over onze artikel-data, zie artikel-database: <https://www.2ba.nl>
Voor de warmteafgiftes van andere regimes, kijkt u op p. 370 (correctiefactoren)
NETERLAND. Prijzen in euro (excl. BTW)

VIOLA-A HORIZONTAAL (H2-RO-A)



H2-RO-A
(thermostaatkop apart te bestellen)

HOE VIOLA-A HORIZONTAAL BESTELLEN

Leveringstermijn 15 - 30 werkdagen
(zonder transportduur)

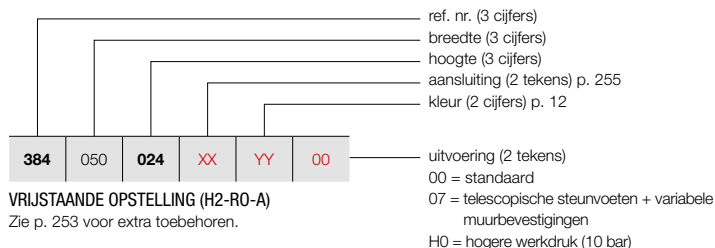

VRIJSTAANDE OPSTELLING (H2-RO-A)

Zie p. 253 voor extra toebehoren.

PRIJSGROEP: VPG2 - STAAL DESIGNRADIATOREN

BESTELCODE MAATWERK VIOLA-A HORIZONTAAL	TECHNISCHE GEGEVENS									STANDAARDKLEUR	ANDERE KLEUREN					
	buizen	breedte (L mm)	hoogte (H mm)	75/65/20 (Watt) (Φ50K)	55/45/20 (Watt) (Φ30K)	n-exp.	gewicht (kg)	inhoud (l)	el. weerst. (Watt)	prijs RAL 9016 (€)	prijs kleur (€)					
REF. NR. VIOLA-A HORIZONTAAL H2-RO-A : 384																
384	050	024	XX	YY	00	3	500	240	218	111	1,23	6,10	1,70	-	575	661
		032				4	500	320	273	139	1,22	8,15	2,25	-	656	754
		040				5	500	400	329	168	1,23	10,15	2,85	-	737	848
		048				6	500	480	389	198	1,25	12,20	3,45	-	817	940
		056				7	500	560	454	231	1,26	14,25	4,05	-	900	1035
		064				8	500	640	523	267	1,27	16,25	4,65	-	979	1126
		072				9	500	720	600	306	1,28	18,30	5,25	-	1061	1220
		080				10	500	800	663	338	1,28	20,35	5,70	-	1143	1314
		088				11	500	880	726	370	1,29	22,35	6,20	-	1226	1410
384	060	024	XX	YY	00	3	600	240	262	133	1,23	7,32	2,04	-	619	712
		032				4	600	320	327	167	1,22	9,78	2,70	-	709	815
		040				5	600	400	395	201	1,23	12,18	3,42	-	798	918
		048				6	600	480	467	238	1,25	14,64	4,14	-	887	1020
		056				7	600	560	544	278	1,26	17,10	4,86	-	978	1245
		064				8	600	640	628	320	1,27	19,50	5,58	-	1068	1228
		072				9	600	720	719	367	1,28	21,96	6,30	-	1157	1331
		080				10	600	800	795	406	1,28	24,42	6,84	-	1248	1435
		088				11	600	880	871	444	1,29	26,82	7,44	-	1337	1538
384	070	024	XX	YY	00	3	700	240	305	156	1,23	8,54	2,38	-	663	762
		032				4	700	320	382	195	1,22	11,41	3,15	-	759	873
		040				5	700	400	461	235	1,23	14,21	3,99	-	857	986
		048				6	700	480	545	278	1,25	17,08	4,83	-	960	1104
		056				7	700	560	635	324	1,26	19,95	5,67	-	1056	1214
		064				8	700	640	732	374	1,27	22,75	6,51	-	1156	1329
		072				9	700	720	839	428	1,28	25,62	7,35	-	1255	1443
		080				10	700	800	928	473	1,28	28,49	7,98	-	1352	1555
		088				11	700	880	1016	518	1,29	31,29	8,68	-	1453	1671
384	080	024	XX	YY	00	3	800	240	349	178	1,23	9,76	2,72	-	703	808
		032				4	800	320	436	222	1,22	13,04	3,60	-	812	934
		040				5	800	400	526	269	1,23	16,24	4,56	-	920	1058
		048				6	800	480	622	318	1,25	19,52	5,52	-	1025	1179
		056				7	800	560	726	370	1,26	22,80	6,48	-	1138	1309
		064				8	800	640	837	427	1,27	26,00	7,44	-	1246	1433
		072				9	800	720	959	489	1,28	29,28	8,40	-	1349	1551
		080				10	800	800	1060	541	1,28	32,56	9,12	-	1459	1678
		088				11	800	880	1161	592	1,29	35,76	9,92	-	1569	1804
384	090	024	XX	YY	00	3	900	240	392	200	1,23	10,98	3,06	-	745	857
		032				4	900	320	491	250	1,22	14,67	4,05	-	862	991
		040				5	900	400	592	302	1,23	18,27	5,13	-	1102	1129
		048				6	900	480	700	357	1,25	21,96	6,21	-	1096	1260
		056				7	900	560	816	416	1,26	25,65	7,29	-	1212	1394
		064				8	900	640	941	480	1,27	29,25	8,37	-	1333	1533
		072				9	900	720	1079	551	1,28	32,94	9,45	-	1450	1668
		080				10	900	800	1193	608	1,28	36,63	10,26	-	1568	1803
		088				11	900	880	1306	666	1,29	40,23	11,16	-	1686	1939

Conform EN442-1: 2014: radiatoren en convectoren

Voor meer details over onze artikel-data, zie artikel-database: <https://www.2ba.nl>

Voor de warmteafgiftes van andere regimes, kijkt u op p. 370 (correctiefactoren)
NETERLAND. Prijzen in euro (excl. BTW)

HOE VIOLA-A HORIZONTAAL BESTELLEN

Leveringstermijn 15 - 30 werkdagen
(zonder transportduur)

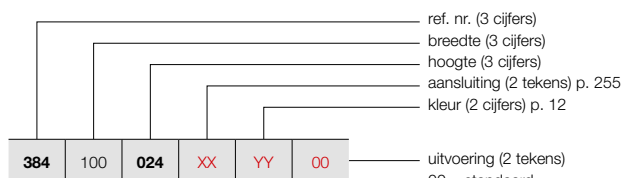

VRIJSTAANDE OPSTELLING (H2-RO-A)

Zie p. 253 voor extra toebehoren.

- ref. nr. (3 cijfers)
- breedte (3 cijfers)
- hoogte (3 cijfers)
- aansluiting (2 tekens) p. 255
- kleur (2 cijfers) p. 12
- uitvoering (2 tekens)
- 00 = standaard
- 07 = telescopische steunvoeten + variabele muurbevestigingen
- H0 = hogere werkdruk (10 bar)

VIOLA-A HORIZONTAAL (H2-RO-A)



H2-RO-A
(thermostaatkop apart te bestellen)

PRIJSGROEP: VPG2 - STAAL DESIGNRADIATOREN

BESTELCODE MAATWERK VIOLA-A HORIZONTAAL	TECHNISCHE GEGEVENS							STANDAARDKLEUR	ANDERE KLEUREN			
	buizen	breedte (L mm)	hoogte (H mm)	75/65/20 (Watt) (Φ50K)	55/45/20 (Watt) (Φ30K)	n-exp.	gewicht (kg)			inhoud (l)	el. weerst. (Watt)	prijs RAL 9016 (€)
REF. NR. VIOLA-A HORIZONTAAL H2-RO-A : 384												
384 100 024 XX YY 00	3	1000	240	436	222	1,23	12,20	3,40	-	790	909	
	4	1000	320	545	278	1,22	16,30	4,50	-	916	1053	
	5	1000	400	658	336	1,23	20,30	5,70	-	1042	1198	
	6	1000	480	778	397	1,25	24,40	6,90	-	1167	1342	
	7	1000	560	907	463	1,26	28,50	8,10	-	1413	1607	
	8	1000	640	1046	534	1,27	32,50	9,30	-	1541	1754	
	9	1000	720	1199	612	1,28	36,60	10,50	-	1546	1778	
	10	1000	800	1325	676	1,28	40,70	11,40	-	1672	1923	
	11	1000	880	1451	740	1,29	44,70	12,40	-	1802	2072	
	384 110 024 XX YY 00	3	1100	240	480	245	1,23	13,42	3,74	-	831	956
		4	1100	320	600	306	1,22	17,93	4,95	-	968	1113
5		1100	400	724	369	1,23	22,33	6,27	-	1100	1265	
6		1100	480	856	437	1,25	26,84	7,59	-	1237	1423	
7		1100	560	998	509	1,26	31,35	8,91	-	1374	1580	
8		1100	640	1151	587	1,27	35,75	10,23	-	1507	1733	
9		1100	720	1319	673	1,28	40,26	11,55	-	1645	1892	
10		1100	800	1458	744	1,28	44,77	12,54	-	1780	2047	
11		1100	880	1596	814	1,29	49,17	13,64	-	1914	2201	
384 120 024 XX YY 00		3	1200	240	523	267	1,23	14,64	4,08	-	875	1006
		4	1200	320	654	334	1,22	19,56	5,40	-	1019	1172
	5	1200	400	790	403	1,23	24,36	6,84	-	1163	1337	
	6	1200	480	934	476	1,25	29,28	8,28	-	1429	1505	
	7	1200	560	1088	555	1,26	34,20	9,72	-	1572	1670	
	8	1200	640	1255	640	1,27	39,00	11,16	-	1597	1837	
	9	1200	720	1439	734	1,28	43,92	12,60	-	1741	2002	
	10	1200	800	1590	811	1,28	48,84	13,68	-	1885	2168	
	11	1200	880	1741	888	1,29	53,64	14,88	-	2030	2335	
	384 140 024 XX YY 00	3	1400	240	610	311	1,23	17,08	4,76	-	960	1104
		4	1400	320	763	389	1,22	22,82	6,30	-	1120	1288
5		1400	400	921	470	1,23	28,42	7,98	-	1283	1475	
6		1400	480	1089	556	1,25	34,16	9,66	-	1449	1666	
7		1400	560	1270	648	1,26	39,90	11,34	-	1611	1853	
8		1400	640	1464	747	1,27	45,50	13,02	-	1894	2160	
9		1400	720	1679	856	1,28	51,24	14,70	-	1937	2228	
10		1400	800	1855	946	1,28	56,98	15,96	-	2098	2413	
11		1400	880	2031	1036	1,29	62,58	17,36	-	2261	2600	
384 160 024 XX YY 00		3	1600	240	698	356	1,23	19,52	5,44	-	1046	1203
		4	1600	320	872	445	1,22	26,08	7,20	-	1227	1411
	5	1600	400	1053	537	1,23	32,48	9,12	-	1406	1617	
	6	1600	480	1245	635	1,25	39,04	11,04	-	1586	1824	
	7	1600	560	1451	740	1,26	45,60	12,96	-	1769	2034	
	8	1600	640	1674	854	1,27	52,00	14,88	-	1950	2243	
	9	1600	720	1918	979	1,28	58,56	16,80	-	2129	2448	
	10	1600	800	2120	1082	1,28	65,12	18,24	-	2309	2655	
	11	1600	880	2322	1184	1,29	71,52	19,84	-	2489	2862	

Conform EN442-1: 2014: radiatoren en convectoren

Voor meer details over onze artikel-data, zie artikel-database: <https://www.2ba.nl>

Voor de warmteafgiftes van andere regimes, kijkt u op p. 370 (correctiefactoren)
NEDERLAND. Prijzen in euro (excl. BTW)

VIOLA-A HORIZONTAAL (H2-RO-A)



H2-RO-A
(thermostaatkop apart te bestellen)

HOE VIOLA-A HORIZONTAAL BESTELLEN

Leveringstermijn 15 - 30 werkdagen
(zonder transportduur)

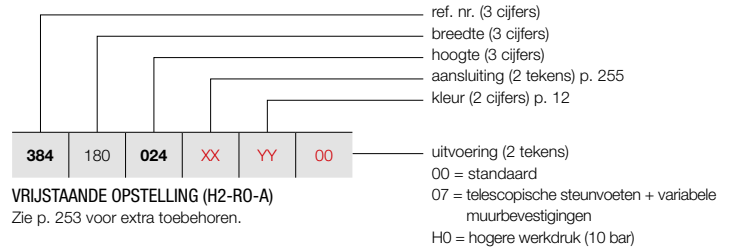

VRIJSTAANDE OPSTELLING (H2-RO-A)

Zie p. 253 voor extra toebehoren.

PRIJSGROEP: VPG2 - STAAL DESIGNRADIATOREN

BESTELCODE MAATWERK VIOLA-A HORIZONTAAL	TECHNISCHE GEGEVENS									STANDAARDKLEUR	ANDERE KLEUREN
	buizen	breedte (L mm)	hoogte (H mm)	75/65/20 (Watt) (Φ50K)	55/45/20 (Watt) (Φ30K)	n-exp.	gewicht (kg)	inhoud (l)	el. weerst. (Watt)	prijs RAL 9016 (€)	prijs kleur (€)
REF. NR. VIOLA-A HORIZONTAAL H2-RO-A : 384											
384	180	024	XX	YY	00						
		032								1131	1301
		040								1330	1530
		048								1527	1756
		056								1727	1986
		064								1924	2213
		072								2126	2445
		080								2325	2674
		088								2527	2906
										2721	3129
384	200	024	XX	YY	00						
		032								1212	1394
		040								1432	1647
		048								1651	1899
		056								1865	2145
		064								2086	2399
		072								2300	2645
		080								2519	2897
		088								2737	3148
										2953	3396
384	220	024	XX	YY	00						
		032								1299	1494
		040								1539	1770
		048								1773	2039
		056								2008	2309
		064								2244	2581
		072								2480	2852
		080								2712	3119
		088								2950	3393
										3185	3663
384	240	024	XX	YY	00						
		032								1387	1595
		040								1639	1885
		048								1896	2180
		056								2146	2468
		064								2398	2758
		072								2654	3052
		080								2909	3345
		088								3160	3634
										3415	3927
384	260	024	XX	YY	00						
		032								1470	1691
		040								1742	2003
		048								2013	2315
		056								2289	2632
		064								2556	2939
		072								2829	3253
		080								3104	3570
		088								3374	3880
										3644	4191

Conform EN442-1: 2014: radiatoren en convectoren

Voor meer details over onze artikel-data, zie artikel-database: <https://www.2ba.nl>

Voor de warmteafgiftes van andere regimes, kijkt u op p. 370 (correctiefactoren)
NEDERLAND. Prijzen in euro (excl. BTW)

VIOLA-A HORIZONTAAL (H2L1-RO-A)



H2L1-RO-A
(thermostaatkop apart te bestellen)

HOE VIOLA-A HORIZONTAAL BESTELLEN

Leveringstermijn 15 - 30 werkdagen
(zonder transportduur)

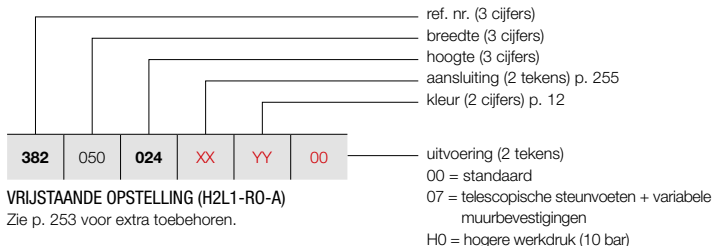

VRIJSTAANDE OPSTELLING (H2L1-RO-A)
 Zie p. 253 voor extra toebehoren.

PRIJSGROEP: VPG2 - STAAL DESIGNRADIATOREN

BESTELCODE MAATWERK VIOLA-A HORIZONTAAL							TECHNISCHE GEGEVENS					STANDAARDKLEUR	ANDERE KLEUREN			
buizen	breedte (L mm)	hoogte (H mm)	75/65/20 (Watt) (Φ50K)	55/45/20 (Watt) (Φ30K)	n-exp.	gewicht (kg)	inhoud (l)	el. weerst. (Watt)	prijs RAL 9016 (€)	prijs kleur (€)						
REF. NR. VIOLA-A HORIZONTAAL H2L1-RO-A : 382																
382	050	024	XX	YY	00	3	500	240	322	164	1,28	7,75	1,70	-	636	731
		032				4	500	320	399	204	1,30	10,35	2,25	-	739	850
		040				5	500	400	474	242	1,32	12,90	2,85	-	843	969
		048				6	500	480	550	280	1,34	15,50	3,45	-	942	1083
		056				7	500	560	625	319	1,36	18,10	4,05	-	1167	1324
		064				8	500	640	677	345	1,36	20,65	4,65	-	1152	1325
		072				9	500	720	728	371	1,36	23,25	5,25	-	1253	1441
		080				10	500	800	780	398	1,37	25,80	5,70	-	1352	1555
		088				11	500	880	822	419	1,36	27,85	6,20	-	1456	1674
382	060	024	XX	YY	00	3	600	240	386	197	1,28	9,30	2,04	-	688	791
		032				4	600	320	479	244	1,30	12,42	2,70	-	804	925
		040				5	600	400	569	290	1,32	15,48	3,42	-	915	1052
		048				6	600	480	659	336	1,34	18,60	4,14	-	1025	1179
		056				7	600	560	749	382	1,36	21,72	4,86	-	1141	1312
		064				8	600	640	812	414	1,36	24,78	5,58	-	1254	1442
		072				9	600	720	874	446	1,36	27,90	6,30	-	1367	1572
		080				10	600	800	936	478	1,37	30,96	6,84	-	1482	1704
		088				11	600	880	986	503	1,36	33,42	7,44	-	1594	1833
382	070	024	XX	YY	00	3	700	240	450	230	1,28	10,85	2,38	-	737	848
		032				4	700	320	559	285	1,30	14,49	3,15	-	860	989
		040				5	700	400	664	339	1,32	18,06	3,99	-	986	1134
		048				6	700	480	769	393	1,34	21,70	4,83	-	1107	1273
		056				7	700	560	874	446	1,36	25,34	5,67	-	1234	1419
		064				8	700	640	947	483	1,36	28,91	6,51	-	1361	1565
		072				9	700	720	1019	520	1,36	32,55	7,35	-	1484	1707
		080				10	700	800	1092	557	1,37	36,12	7,98	-	1607	1848
		088				11	700	880	1151	587	1,36	38,99	8,68	-	1849	2108
382	080	024	XX	YY	00	3	800	240	514	262	1,28	12,40	2,72	-	788	906
		032				4	800	320	638	326	1,30	16,56	3,60	-	922	1060
		040				5	800	400	758	387	1,32	20,64	4,56	-	1056	1214
		048				6	800	480	879	449	1,34	24,80	5,52	-	1192	1371
		056				7	800	560	999	510	1,36	28,96	6,48	-	1449	1648
		064				8	800	640	1082	552	1,36	33,04	7,44	-	1581	1680
		072				9	800	720	1165	594	1,36	37,20	8,40	-	1597	1837
		080				10	800	800	1248	637	1,37	41,28	9,12	-	1731	1991
		088				11	800	880	1315	671	1,36	44,56	9,92	-	1865	2145
382	090	024	XX	YY	00	3	900	240	579	295	1,28	13,95	3,06	-	840	966
		032				4	900	320	718	366	1,30	18,63	4,05	-	983	1130
		040				5	900	400	853	435	1,32	23,22	5,13	-	1129	1298
		048				6	900	480	989	505	1,34	27,90	6,21	-	1276	1467
		056				7	900	560	1124	574	1,36	32,58	7,29	-	1421	1634
		064				8	900	640	1218	621	1,36	37,17	8,37	-	1566	1801
		072				9	900	720	1310	669	1,36	41,85	9,45	-	1714	1971
		080				10	900	800	1404	716	1,37	46,44	10,26	-	1859	2138
		088				11	900	880	1480	755	1,36	50,13	11,16	-	2124	2425

Conform EN442-1: 2014: radiatoren en convectoren

Voor meer details over onze artikel-data, zie artikel-database: <https://www.2ba.nl>

Voor de warmteafgifte van andere regimes, kijkt u op p. 370 (correctiefactoren)
 NEDERLAND. Prijzen in euro (excl. BTW)

VIOLA-A HORIZONTAAL (H2L1-RO-A)



H2L1-RO-A
(thermostaatkop apart te bestellen)

HOE VIOLA-A HORIZONTAAL BESTELLEN

Leveringstermijn 15 - 30 werkdagen
(zonder transportduur)

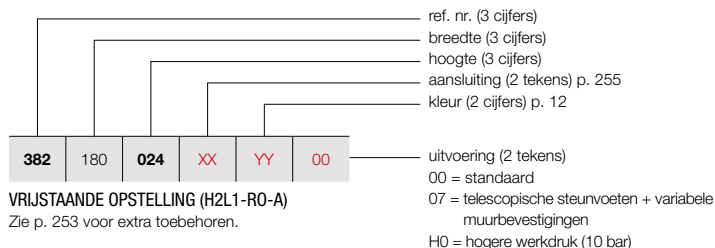

VRIJSTAANDE OPSTELLING (H2L1-RO-A)
 Zie p. 253 voor extra toebehoren.

PRIJSGROEP: VPG2 - STAAL DESIGNRADIATOREN

BESTELCODE MAATWERK VIOLA-A HORIZONTAAL	TECHNISCHE GEGEVENS									STANDAARDKLEUR	ANDERE KLEUREN
	buizen	breedte (L mm)	hoogte (H mm)	75/65/20 (Watt) (Φ50K)	55/45/20 (Watt) (Φ30K)	n-exp.	gewicht (kg)	inhoud (l)	el. weerst. (Watt)	prijs RAL 9016 (€)	prijs kleur (€)
REF. NR. VIOLA-A HORIZONTAAL H2L1-RO-A : 382											
382	180	024	XX	YY	00						
		032								1284	1477
		040								1533	1763
		048								1773	2039
		056								2014	2316
		064								2260	2599
		072								2502	2877
		080								2747	3159
		088								2990	3439
										3236	3721
382	200	024	XX	YY	00						
		032								1383	1590
		040								1653	1901
		048								1914	2201
		056								2179	2506
		064								2445	2812
		072								2711	3118
		080								2977	3424
		088								3242	3728
										3508	4034
382	220	024	XX	YY	00						
		032								1485	1708
		040								1773	2039
		048								2061	2370
		056								2348	2700
		064								2632	3027
		072								2918	3356
		080								3205	3686
		088								3494	4018
										3782	4349
382	240	024	XX	YY	00						
		032								1583	1820
		040								2016	2180
		048								2202	2532
		056								2512	2889
		064								2942	3365
		072								3245	3714
		080								3436	3951
		088								3745	4307
										4051	4659
382	260	024	XX	YY	00						
		032								1685	1938
		040								2013	2315
		048								2343	2694
		056								2675	3076
		064								3005	3456
		072								3340	3841
		080								3669	4219
		088								3996	4595
										4330	4980

Conform EN442-1: 2014: radiatoren en convectoren

Voor meer details over onze artikel-data, zie artikel-database: <https://www.2ba.nl>

Voor de warmteafgifte van andere regimes, kijkt u op p. 370 (correctiefactoren)
 NEDERLAND. Prijzen in euro (excl. BTW)

HOE VIOLA-A HORIZONTAAL BESTELLEN

Leveringstermijn 15 - 30 werkdagen
(zonder transportduur)

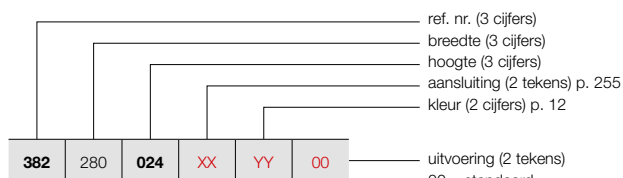

VRIJSTAANDE OPSTELLING (H2L1-RO-A)

Zie p. 253 voor extra toebehoren.

00 = standaard
07 = telescopische steunvoeten + variabele muurbevestigingen
H0 = hogere werkdruk (10 bar)

VIOLA-A HORIZONTAAL (H2L1-RO-A)

247



H2L1-RO-A
(thermostaatkop apart te bestellen)

PRIJSGROEP: VPG2 - STAAL DESIGNRADIATOREN

BESTELCODE MAATWERK VIOLA-A HORIZONTAAL	TECHNISCHE GEGEVENS							STANDAARDKLEUR		ANDERE KLEUREN	
	buizen	breedte (L mm)	hoogte (H mm)	75/65/20 (Watt) (Φ50K)	55/45/20 (Watt) (Φ30K)	n-exp.	gewicht (kg)	inhoud (l)	el. weerst. (Watt)	prijs RAL 9016 (€)	prijs kleur (€)
REF. NR. VIOLA-A HORIZONTAAL H2L1-RO-A : 382											
382	280	024	XX	YY	00						
		032								1781	2048
		040								2134	2454
		048								2487	2860
		056								2838	3264
		064								3195	3674
		072								3547	4079
		080								3896	4480
		088								4250	4888
										4602	5292
382	300	024	XX	YY	00						
		032								1882	2164
		040								2255	2593
		048								2630	3025
		056								3003	3453
		064								3380	3887
		072								3756	4319
		080								4126	4745
		088								4501	5176
										4874	5605

Conform EN442-1: 2014: radiatoren en convectoren

Voor meer details over onze artikel-data, zie artikel-database: <https://www.2ba.nl>
Voor de warmteafgiftes van andere regimes, kijkt u op p. 370 (correctiefactoren)
NEDERLAND. Prijzen in euro (excl. BTW)

VIOLA-A HORIZONTAAL (H2L2-RO-A)



H2L2-RO-A
(thermostaatkop apart te bestellen)

HOE VIOLA-A HORIZONTAAL BESTELLEN

Leveringstermijn 15 - 30 werkdagen
(zonder transportduur)

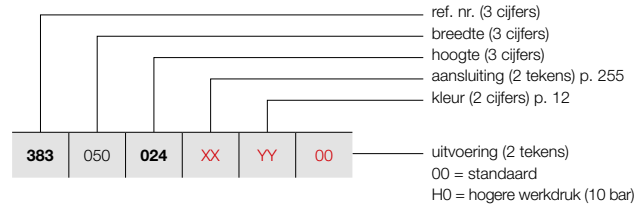

PRIJSGROEP: VPG2 - STAAL DESIGNRADIATOREN

BESTELCODE MAATWERK VIOLA-A HORIZONTAAL	TECHNISCHE GEGEVENS									STANDAARDKLEUR	ANDERE KLEUREN
	buizen	breedte (L mm)	hoogte (H mm)	75/65/20 (Watt) (Φ50K)	55/45/20 (Watt) (Φ30K)	n-exp.	gewicht (kg)	inhoud (l)	el. weerst. (Watt)	prijs RAL 9016 (€)	prijs kleur (€)
REF. NR. VIOLA-A HORIZONTAAL H2L2-RO-A : 383											
383	050	024	XX	YY	00						
		032								690	794
		040								809	930
		048								922	1060
		056								1038	1194
		064								1154	1327
		072								1271	1462
		080								1383	1590
		088								1497	1842
										1613	1855
383	060	024	XX	YY	00						
		032								753	866
		040								879	1011
		048								1007	1158
		056								1139	1310
		064								1262	1451
		072								1397	1607
		080								1524	1753
		088								1655	1903
										1781	2048
383	070	024	XX	YY	00						
		032								812	934
		040								956	1099
		048								1095	1259
		056								1239	1425
		064								1380	1587
		072								1642	1870
		080								1668	1918
		088								1810	2082
										1950	2243
383	080	024	XX	YY	00						
		032								874	1005
		040								1025	1179
		048								1185	1363
		056								1338	1539
		064								1614	1838
		072								1653	2021
		080								1808	2079
		088								1964	2259
										2120	2438
383	090	024	XX	YY	00						
		032								930	1070
		040								1099	1264
		048								1272	1463
		056								1438	1654
		064								1609	1850
		072								1778	2045
		080								1949	2241
		088								2118	2436
										2289	2632

Conform EN442-1: 2014: radiatoren en convectoren

Voor meer details over onze artikel-data, zie artikel-database: <https://www.2ba.nl>

Voor de warmteafgiftes van andere regimes, kijkt u op p. 370 (correctiefactoren)
 NEDERLAND. Prijzen in euro (excl. BTW)

HOE VIOLA-A HORIZONTAAL BESTELLEN

Leveringstermijn 15 - 30 werkdagen
(zonder transportduur)

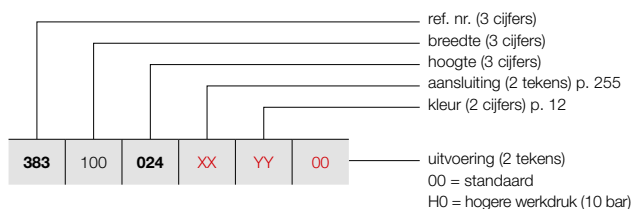

VIOLA-A HORIZONTAAL (H2L2-RO-A)



H2L2-RO-A
(thermostaatkop apart te bestellen)

PRIJSGROEP: VPG2 - STAAL DESIGNRADIATOREN

BESTELCODE MAATWERK VIOLA-A HORIZONTAAL	TECHNISCHE GEGEVENS							STANDAARDKLEUR		ANDERE KLEUREN		
	buizen	breedte (L mm)	hoogte (H mm)	75/65/20 (Watt) (φ50K)	55/45/20 (Watt) (φ30K)	n-exp.	gewicht (kg)	inhoud (l)	el. weerst. (Watt)	prijs RAL 9016 (€)	prijs kleur (€)	
REF. NR. VIOLA-A HORIZONTAAL H2L2-RO-A : 383												
383 100 024 XX YY 00	3	1000	240	865	441	1,25	19,40	4,00	-	991	1140	
	4	1000	320	1075	548	1,30	25,80	5,50	-	1172	1348	
	5	1000	400	1326	677	1,31	32,20	6,90	-	1361	1565	
	6	1000	480	1576	804	1,33	38,80	8,30	-	1541	1772	
	7	1000	560	1826	932	1,34	45,20	9,70	-	1723	2101	
	8	1000	640	1986	1013	1,34	51,70	11,00	-	1906	2192	
	9	1000	720	2145	1094	1,34	58,20	12,40	-	2209	2522	
	10	1000	800	2305	1176	1,36	64,60	13,80	-	2270	2611	
	11	1000	880	2408	1229	1,36	68,90	15,20	-	2454	2822	
	383 110 024 XX YY 00	3	1100	240	952	485	1,25	21,34	4,40	-	1052	1210
		4	1100	320	1183	603	1,30	28,38	6,05	-	1249	1436
5		1100	400	1459	744	1,31	35,42	7,59	-	1446	1663	
6		1100	480	1734	884	1,33	42,68	9,13	-	1641	1887	
7		1100	560	2009	1025	1,34	49,72	10,67	-	1837	2113	
8		1100	640	2185	1115	1,34	56,87	12,10	-	2033	2338	
9		1100	720	2360	1204	1,34	64,02	13,64	-	2232	2567	
10		1100	800	2536	1294	1,36	71,06	15,18	-	2426	2790	
11		1100	880	2649	1351	1,36	75,79	16,72	-	2622	3015	
383 120 024 XX YY 00		3	1200	240	1038	530	1,25	23,28	4,80	-	1113	1280
		4	1200	320	1290	658	1,30	30,96	6,60	-	1323	1521
	5	1200	400	1591	812	1,31	38,64	8,28	-	1535	1765	
	6	1200	480	1891	965	1,33	46,56	9,96	-	1742	2003	
	7	1200	560	2191	1118	1,34	54,24	11,64	-	1952	2245	
	8	1200	640	2383	1216	1,34	62,04	13,20	-	2163	2487	
	9	1200	720	2574	1313	1,34	69,84	14,88	-	2371	2727	
	10	1200	800	2766	1411	1,36	77,52	16,56	-	2581	2968	
	11	1200	880	2890	1474	1,36	82,68	18,24	-	2791	3210	
	383 140 024 XX YY 00	3	1400	240	1211	618	1,25	27,16	5,60	-	1234	1419
		4	1400	320	1505	768	1,30	36,12	7,70	-	1470	1691
5		1400	400	1856	947	1,31	45,08	9,66	-	1706	1962	
6		1400	480	2206	1126	1,33	54,32	11,62	-	1945	2237	
7		1400	560	2556	1304	1,34	63,28	13,58	-	2299	2506	
8		1400	640	2780	1419	1,34	72,38	15,40	-	2416	2778	
9		1400	720	3003	1532	1,34	81,48	17,36	-	2654	3052	
10		1400	800	3227	1646	1,36	90,44	19,32	-	2889	3322	
11		1400	880	3371	1720	1,36	96,46	21,28	-	3125	3594	
383 160 024 XX YY 00		3	1600	240	1384	706	1,25	31,04	6,40	-	1349	1551
		4	1600	320	1720	878	1,30	41,28	8,80	-	1616	1858
	5	1600	400	2122	1082	1,31	51,52	11,04	-	1881	2163	
	6	1600	480	2522	1287	1,33	62,08	13,28	-	2145	2467	
	7	1600	560	2922	1491	1,34	72,32	15,52	-	2410	2772	
	8	1600	640	3178	1621	1,34	82,72	17,60	-	2674	3075	
	9	1600	720	3432	1751	1,34	93,12	19,84	-	2935	3375	
	10	1600	800	3688	1882	1,36	103,36	22,08	-	3201	3681	
	11	1600	880	3853	1966	1,36	110,24	24,32	-	3464	3984	

Conform EN442-1: 2014: radiatoren en convectoren

Voor meer details over onze artikel-data, zie artikel-database: <https://www.2ba.nl>

Voor de warmteafgiftes van andere regimes, kijkt u op p. 370 (correctiefactoren)
 NEDERLAND. Prijzen in euro (excl. BTW)

STAAL DESIGNRADIATOREN

VIOLA-A HORIZONTAAL (H2L2-RO-A)



H2L2-RO-A
(thermostaatkop apart te bestellen)

HOE VIOLA-A HORIZONTAAL BESTELLEN

Leveringstermijn 15 - 30 werkdagen
(zonder transportduur)

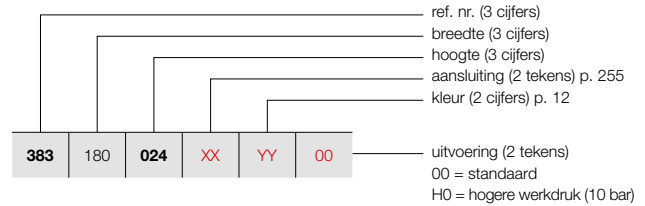

PRIJSGROEP: VPG2 - STAAL DESIGNRADIATOREN

BESTELCODE MAATWERK VIOLA-A HORIZONTAAL	TECHNISCHE GEGEVENS									STANDAARDKLEUR	ANDERE KLEUREN
	buizen	breedte (L mm)	hoogte (H mm)	75/65/20 (Watt) (Φ50K)	55/45/20 (Watt) (Φ30K)	n-exp.	gewicht (kg)	inhoud (l)	el. weerst. (Watt)	prijs RAL 9016 (€)	prijs kleur (€)
REF. NR. VIOLA-A HORIZONTAAL H2L2-RO-A : 383											
383	180	024	XX	YY	00						
		032								1478	1700
		040								1765	2030
		048								2056	2364
		056								2348	2700
		064								2634	3029
		072								2931	3371
		080								3220	3703
		088								3510	4037
										3800	4370
383	200	024	XX	YY	00						
		032								1596	1835
		040								1910	2197
		048								2232	2567
		056								2547	2929
		064								2985	3415
		072								3184	3662
		080								3505	4151
		088								3819	4392
										4135	4755
383	220	024	XX	YY	00						
		032								1715	1972
		040								2062	2371
		048								2408	2769
		056								2748	3160
		064								3095	3559
		072								3442	3958
		080								3784	4352
		088								4129	4748
										4475	5146
383	240	024	XX	YY	00						
		032								1834	2109
		040								2209	2540
		048								2579	2966
		056								2951	3394
		064								3324	3823
		072								3694	4248
		080								4067	4677
		088								4438	5104
										4807	5528
383	260	024	XX	YY	00						
		032								1956	2249
		040								2355	2708
		048								2754	3167
		056								3153	3626
		064								3552	4085
		072								3947	4539
		080								4349	5001
		088								4748	5460
										5149	5921

Conform EN442-1: 2014: radiatoren en convectoren

Voor meer details over onze artikel-data, zie artikel-database: <https://www.2ba.nl>

Voor de warmteafgiftes van andere regimes, kijkt u op p. 370 (correctiefactoren)
NEDERLAND. Prijzen in euro (excl. BTW)

HOE VIOLA-A HORIZONTAAL BESTELLEN

Leveringstermijn 15 - 30 werkdagen
(zonder transportduur)

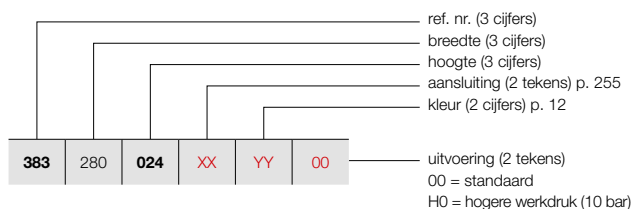

VIOLA-A HORIZONTAAL (H2L2-RO-A)



H2L2-RO-A
(thermostaatkop apart te bestellen)

PRIJSGROEP: VPG2 - STAAL DESIGNRADIATOREN

BESTELCODE MAATWERK VIOLA-A HORIZONTAAL	TECHNISCHE GEGEVENS							STANDAARDKLEUR		ANDERE KLEUREN	
	buizen	breedte (L mm)	hoogte (H mm)	75/65/20 (Watt) (Φ50K)	55/45/20 (Watt) (Φ30K)	n-exp.	gewicht (kg)	inhoud (l)	el. weerst. (Watt)	prijs RAL 9016 (€)	prijs kleur (€)
REF. NR. VIOLA-A HORIZONTAAL H2L2-RO-A : 383											
383	280	024	XX	YY	00						
		032								2074	2385
		040								2501	2876
		048								2930	3370
		056								3355	3858
		064								3782	4349
		072								4205	4836
		080								4630	5325
										5057	5816
383	300	024	XX	YY	00						
		032								2196	2525
		040								2650	3048
		048								3104	3570
		056								3555	4088
		064								4011	4613
		072								4458	5127
										4916	5653



Conform EN442-1: 2014: radiatoren en convectoren

Voor meer details over onze artikel-data, zie artikel-database: <https://www.2ba.nl>
Voor de warmteafgiftes van andere regimes, kijkt u op p. 370 (correctiefactoren)
NEDERLAND. Prijzen in euro (excl. BTW)

VIOLA-A WANDBEVESTIGING





IN OPTIE

PRIJSGROEP: VPG10 - ACC.

WANDOPSTELLING	BREEDTE RADIATOR	KLEUR	ART. NR.	€
TELESCOPISCHE STEUNVOETEN + VARIABLE MUURBEVESTIGINGEN 	V2-ZB-A			
	(2 voeten)	RAL 9016	*	97
		KLEUR	*	112
	H2-RO-A, H2L1-RO-A			
	≤ 2000 mm (2 voeten)	RAL 9016	*	97
		KLEUR	*	112
≥ 2200 mm (3 voeten)	RAL 9016	*	149	
	KLEUR	*	171	
* Opgelet: Voeten moeten gelijktijdig met de radiator besteld worden. Gelieve bij bestelling code 07 aan te geven bij "Afwerking".				
AFDEKROZET STANDVOET CHAPE 	V2-ZB-A			
		RAL 9016	11810390000	31
• 56 x 56 mm. Aantal rozetten = aantal standvoeten				
AFDEKROZET STANDVOET AFGEWERKTE VLOER 	H2-RO-A, H2L1-RO-A			
		RAL 9016	11810400000	40
• 104 x 84 mm. Aantal rozetten = aantal standvoeten				

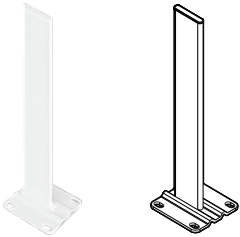
NEDERLAND. Prijzen in euro (excl. BTW)

PRIJSGROEP: VPG10 - ACC.



VRIJSTAANDE OPSTELLING	HOOGTE VOET	KLEUR	ART. NR.	€
STANDVOET VRIJSTAANDE OPSTELLING 	H2-RO-A, H2L1-RO-A			
	H = 450 mm	RAL 9016	11810350450	65
		KLEUR	11810350450C	75
	H = 550 mm	RAL 9016	11810350550	65
		KLEUR	11810350550C	75
	H = 600 mm	RAL 9016	11810350600	65
		KLEUR	11810350600C	75
	H = 650 mm	RAL 9016	11810350650	65
		KLEUR	11810350650C	75
	H = 750 mm	RAL 9016	11810350750	65
		KLEUR	11810350750C	75
	H = 850 mm	RAL 9016	11810350850	81
		KLEUR	11810350850C	92
	H = 900 mm	RAL 9016	11810350900	81
	KLEUR	11810350900C	92	
H = 1050 mm	RAL 9016	11810351050	81	
	KLEUR	11810351050C	92	
H = 1200 mm	RAL 9016	11810351200	81	
	KLEUR	11810351200C	92	
<ul style="list-style-type: none"> Afgewerkte vloer: hoogte voet = hoogte radiator + 150 mm Chape: hoogte voet = hoogte radiator + 300 mm Zelf in te korten indien nodig 				
BEVESTIGING STANDVOET VRIJSTAANDE OPSTELLING 	H2-RO-A, H2L1-RO-A			
		RAL 9016	11810360000	52
	KLEUR	11810360000C	60	
AFDEKROZET STANDVOET CHAPE 	H2-RO-A, H2L1-RO-A			
		RAL 9016	11810370000	14
	KLEUR	11810370000C	16	
<ul style="list-style-type: none"> 100 x 40 mm. Aantal rozetten = aantal standvoeten 				
AFDEKROZET STANDVOET AFGEWERKTE VLOER 	H2-RO-A, H2L1-RO-A			
		RAL 9016	11810380000	17
	KLEUR	11810380000C	19	
<ul style="list-style-type: none"> 115 x 110 mm. Aantal rozetten = aantal standvoeten 				

hoogte radiator (mm)	Lengte radiator (mm)	aantal standvoeten	aantal bevestigingen standvoet
240 - 880	500-2000	2x	2x
	2200-3000	3x	3x

NEDERLAND. Prijzen in euro (excl. BTW)

VIOLA-A ACCESSOIRES
 IN OPTIE

PRIJSGROEP: VPG10 - ACC.

ACCESSOIRES		KLEUR	ART. NR.	€
THERMOSTAATKOP		H1-RO-A, H1L1-RO-A, H2-RO-A, H2L1-RO-A, H2L2-RO-A		
		WIT	11911630102	54
THERMOSTAATKOP		H1-RO-A, H1L1-RO-A, H2-RO-A, H2L1-RO-A, H2L2-RO-A		
		CHROOM	11911631102	69

PRIJSGROEP: VPG10B - HANDDOEKBEUGELS

ACCESSOIRES	BREEDTE HANDDOEKBEUGEL	KLEUR	ART. NR.	€	
KNOP		V1-ZB-A, V1L1-ZB-A, V2-ZB-A			
		CHROOM	118341100000099	94	
HANDDOEKBEUGEL		V1-ZB-A, V1L1-ZB-A, V2-ZB-A			
		H1-RO-A, H1L1-RO-A, H2-RO-A, H2L1-RO-A, H2L2-RO-A			
		500 mm	CHROOM	11832700000099	157
		500 mm	RAL 9016	118327000009016	157
	500 mm	RAL 9005 ^{mat}	118327000009005	157	

- h = 70 mm; b = 70 mm; d = 51 mm; a = 43 mm;

- h = 55 mm; b = 500 mm; d = 53 mm; a = 38 mm;

 mat zwart

Montagevoorschriften accessoires: zie www.vasco.eu
 NEDERLAND. Prijzen in euro (excl. BTW)

d = afstand voorkant accessoire tot voorkant radiator
 a = afstand accessoire tot radiator
uit voorraad leverbaar

VIOLA-A VERTICAAL: V1-ZB-A / V1L1-ZB-A / V2-ZB-A (VOORRAAD)

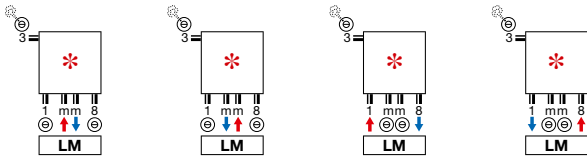

- * Aanvoer en retour kunnen verwisseld worden
- Bovenvermelde aansluiting voor voorraad radiator met even aantal buizen. Ook beschikbaar voor niet-voorraad radiatoren met even aantal buizen.

VIOLA-A VERTICAAL: V1-ZB-A / V1L1-ZB-A / V2-ZB-A (NIET-VOORRAAD)

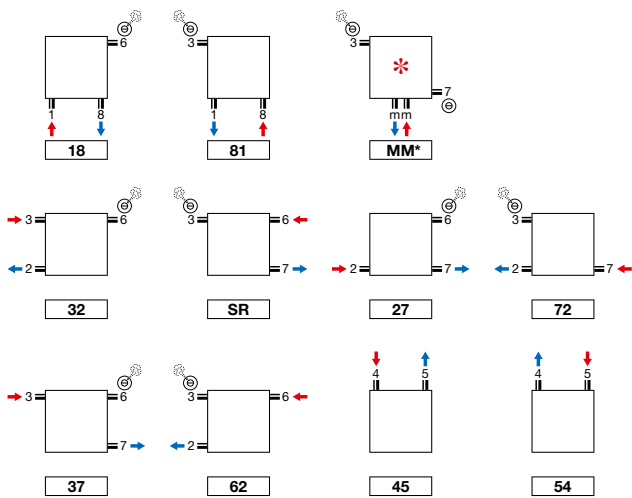

- * Aanvoer en retour kunnen verwisseld worden
- mm aansluiting alleen mogelijk bij even aantal buizen.

VIOLA-A HORIZONTAAL: H1-RO-A / H1L1-RO-A / H2-RO-A / H2L1-RO-A / H2L2-RO-A (NIET-VOORRAAD)

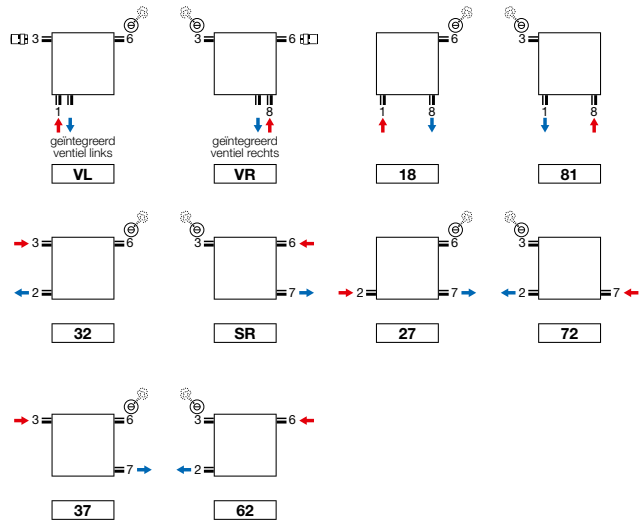

- Aansluiting VL en VR: thermostaatkop apart te bestellen
- Geïntegreerd ventiel (meerprijs) (zie p. 363)

Opmerking: het aansluiten van de radiator kan enkel volgens de getoonde aansluiticonen. Voor elke andere aansluitwijze nemen wij geen verantwoordelijkheid.

VIOLA-A HORIZONTAAL (H1-RO-A, H1L1-RO-A, H2-RO-A, H2L1-RO-A, H2L2-RO-A)

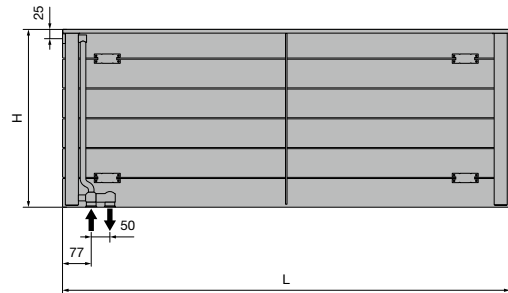
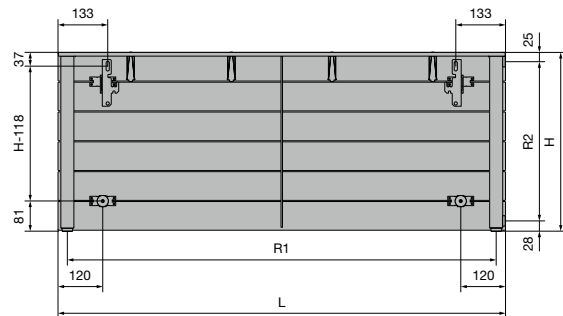
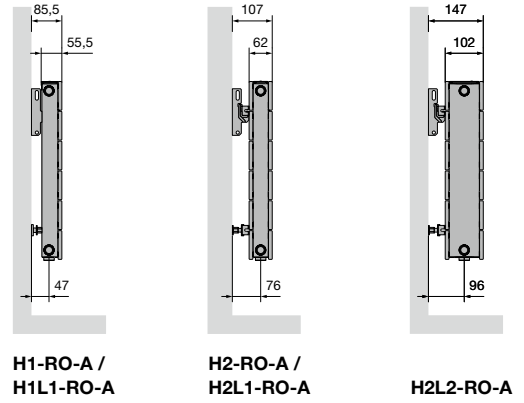
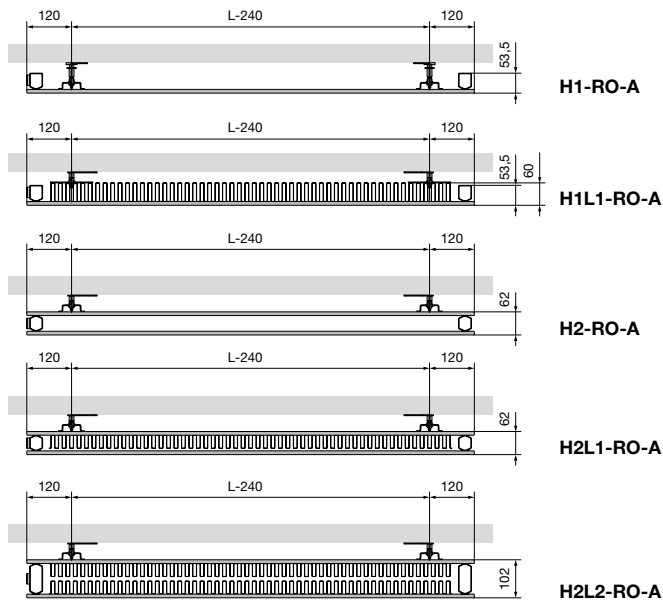

	H1-RO-A / H1L1-RO-A / H2-RO-A / H2L1-RO-A / H2L2-RO-A																
Breedte (L)	500	600	700	800	900	1000	1100	1200	1400	1600	1800	2000	2200	2400	2600	2800	3000
Hartafstand tussen de onderaansluitingen 18 (R1)	450	550	650	750	850	950	1050	1150	1350	1550	1750	1950	2150	2350	2550	2750	2950
Hoogte (H)	240	320	400	480	560	640	720	800	880								
Hartafstand tussen de zijansluitingen 32/SR (R2)	187	267	347	427	507	587	667	747	827								
Hartafstand tussen de ophangingen	L-240	H-118															

TULIPA-A VERTICAAL (TV1-A, TV2-A)



TULIPA-A VERTICAAL

Warmte in alle openheid

Een designradiator van de eerste generatie. Geschikt voor alle ruimten en toepassingen. Gekenmerkt door de klassieke open structuur en de loodrechte aansluiting van de buizen op de collector. De waarborg voor een smetteloos verwarmingscomfort waar dan ook in huis.

TYPES

- Eén (TV1-A) of twee rijen buizen (TV2-A)

BUIZEN

- Verticaal, platvaal 60 x 10 mm

COLLECTOREN

- Horizontaal, achterliggend, rond Ø 32 mm

KLEUREN

- Standaardkleur wit RAL 9016
- Uitgebreide kleurenkaart zie p. 12

SPECIAAL

- Tulipa-A 6 en 8 buizen: aansluiting 1mm8, 18, 81 niet mogelijk

BEVESTIGINGEN

- Muurbevestigingen standaard (inbegrepen in de verpakking van de radiator)
- **TV1-A / TV2-A:** ook verkrijgbaar als vrijstaande opstelling, zie p. 272. Extra muurbevestigingssteun nodig voor hoogte radiator > 600 mm

TECHNISCH

- Weerstandsgelast (onzichtbare lasnaden)
- ATL-grondlaag, poedercoating
- Standaardwerkdruk: 6 bar. Meerprijs hogere werkdruk (10 bar): +10%.
- De leveringstermijn van radiator met een hogere werkdruk is 1 week extra.
- Maximale bedrijfstemperatuur: 110°C

ELEKTRISCH

- ✗ Zuiver elektrische radiator in de fabriek voorgevuld
- ✗ Gemengde radiator

TECHNISCHE TEKENINGEN

- Zie p. 275

AANSLUITING

- ✗ Eénpuntsaansluiting voor éénpijpssysteem
- ✗ Eénpuntsaansluiting voor tweepijpssysteem
- ✓ Tweepuntsaansluiting voor éénpijpssysteem (aansluiting via de middenaansluiting) (zie p. 362)
- ✓ Tweepuntsaansluiting voor tweepijpssysteem (standaard) (zie p. 362)
- ✗ Geïntegreerd ventiel
- Aansluitingen: ½" (binnendraad)

AANBEVOLEN AANSLUITING (LM)

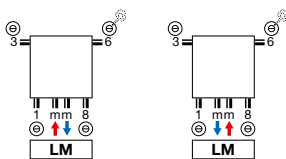

Andere aansluitmogelijkheden, zie p. 274

NEW



Ventielset haaks kleur

art. nr. 1182 105 0000 9016

prijs €201

Andere kleuren, zie p. 366

Koppelingen, zie p. 380



Thermostaatkop

Traffic White

art. nr. 1182 030 0000 9016

prijs €40

AANBEVOLEN VOOR BADKAMER EN KEUKEN IN OPTIE



handdoekbeugel (RAL 9005)

art. nr. zie p. 273

prijs €157

Andere accessoires, zie p. 273



TV1-A / TV2-A

HOE TULIPA-A VERTICAAL BESTELLEN

Leveringstermijn 15 - 30 werkdagen
(zonder transportduur)

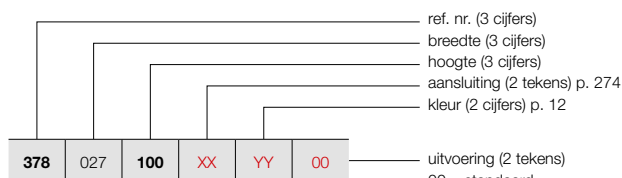

VRIJSTAANDE OPSTELLING (TV1-A)

Zie p. 272 voor extra toebehoren.

HOE VOORRAADRADIATOR TULIPA-A VERTICAAL BESTELLEN

Leveringstermijn 5 werkdagen
(zonder transportduur)

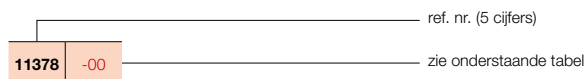

TULIPA-A VERTICAAL (TV1-A)



TV1-A

PRIJSGROEP: VPG2 - STAAL DESIGNRADIATOREN

BESTELCODE MAATWERK TULIPA-A VERTICAAL	TECHNISCHE GEGEVENS								STANDAARDKLEUR		ANDERE KLEUREN						
	buizen	breedte (L mm)	hoogte (H mm)	75/65/20 (Watt) (Φ50K)	55/45/20 (Watt) (Φ30K)	n-exp.	gewicht (kg)	inhoud (l)	el. weerst. (Watt)	prijs RAL 9016 (€)		verkorte ref. nr. RAL 9016 voorraad	prijs kleur (€)				
REF. NR. TULIPA-A VERTICAAL TV1-A : 378																	
378	027	100	XX	YY	00	6	270	1000	384	204	1,24	9,60	2,64	-	305	-	351
		120				6	270	1200	456	240	1,24	11,40	3,12	-	334	-	384
		150				6	270	1500	564	294	1,25	14,40	3,84	-	378	-	435
		160				6	270	1600	600	312	1,26	15,00	4,08	-	396	-	455
		180				6	270	1800	660	342	1,26	16,80	4,56	-	419	-	482
		200				6	270	2000	738	384	1,27	18,60	4,98	-	454	-	522
		220				6	270	2200	810	420	1,27	20,40	5,46	-	484	-	557
		250				6	270	2500	912	474	1,28	23,40	6,18	-	528	-	607
		300				6	270	3000	1092	558	1,29	27,60	7,32	-	604	-	695
378	036	100	XX	YY	00	8	360	1000	512	272	1,24	12,80	3,52	-	375	-	431
		120				8	360	1200	608	320	1,24	15,20	4,16	-	415	-	477
		150				8	360	1500	752	392	1,25	19,20	5,12	-	477	-	549
		160				8	360	1600	800	416	1,26	20,00	5,44	-	496	-	570
		180				8	360	1800	880	456	1,26	22,40	6,08	-	532	-	612
		200				8	360	2000	984	512	1,27	24,80	6,64	-	575	-	661
		220				8	360	2200	1080	560	1,27	27,20	7,28	-	611	-	703
		250				8	360	2500	1216	632	1,28	31,20	8,24	-	672	-	773
		300				8	360	3000	1456	744	1,29	36,80	9,76	-	769	-	884
378	045	100	XX	YY	00	10	450	1000	640	340	1,24	16,00	4,40	-	445	-	512
		120				10	450	1200	760	400	1,24	19,00	5,20	-	497	-	572
		150				10	450	1500	940	490	1,25	24,00	6,40	-	567	-	652
		160				10	450	1600	1000	520	1,26	25,00	6,80	-	591	-	680
		180				10	450	1800	1100	570	1,26	28,00	7,60	-	646	-	743
		200				10	450	2000	1230	640	1,27	31,00	8,30	-	692	-	796
		220				10	450	2200	1350	700	1,27	34,00	9,10	-	744	-	856
		250				10	450	2500	1520	790	1,28	39,00	10,30	-	820	-	943
		300				10	450	3000	1820	930	1,29	46,00	12,20	-	941	-	1082
378	054	100	XX	YY	00	12	540	1000	768	408	1,24	19,20	5,28	-	518	-	596
		120				12	540	1200	912	480	1,24	22,80	6,24	-	578	-	665
		150				12	540	1500	1128	588	1,25	28,80	7,68	-	667	-	767
		160				12	540	1600	1200	624	1,26	30,00	8,16	-	696	-	800
		180				12	540	1800	1320	684	1,26	33,60	9,12	-	757	11378-01	871
		200				12	540	2000	1476	768	1,27	37,20	9,96	-	814	11378-02	936
		220				12	540	2200	1620	840	1,27	40,80	10,92	-	876	-	1007
		250				12	540	2500	1824	948	1,28	46,80	12,36	-	963	-	1107
		300				12	540	3000	2184	1116	1,29	55,20	14,64	-	1114	-	1281

Conform EN442-1: 2014: radiatoren en convectoren

Voor meer details over onze artikel-data, zie artikel-database: <https://www.2ba.nl>
Voor de warmteafgiftes van andere regimes, kijkt u op p. 370 (correctiefactoren)
NEDERLAND. Prijzen in euro (excl. BTW)

TULIPA-A VERTICAAL (TV1-A)



TV1-A

HOE TULIPA-A VERTICAAL BESTELLEN

Leveringstermijn 15 - 30 werkdagen
(zonder transportduur)

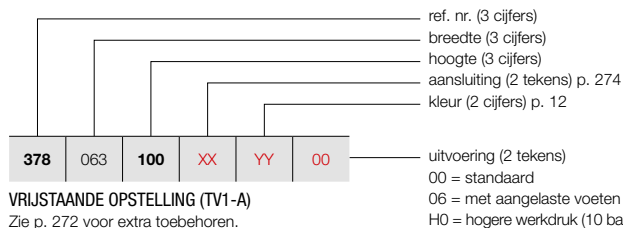

VRIJSTAANDE OPSTELLING (TV1-A)

Zie p. 272 voor extra toebehoren.

PRIJSGROEP: VPG2 - STAAL DESIGNRADIATOREN

BESTELCODE MAATWERK TULIPA-A VERTICAAL							TECHNISCHE GEGEVENS					STANDAARDKLEUR	ANDERE KLEUREN			
buizen	breedte (L mm)	hoogte (H mm)	75/65/20 (Watt) (Φ50K)	55/45/20 (Watt) (Φ30K)	n-exp.	gewicht (kg)	inhoud (l)	el. weerst. (Watt)	prijs RAL 9016 (€)	prijs kleur (€)						
REF. NR. TULIPA-A VERTICAAL TV1-A : 378																
378	063	100	XX	YY	00	14	630	1000	896	476	1,24	22,40	6,16	-	588	676
		120				14	630	1200	1064	560	1,24	26,60	7,28	-	661	760
		150				14	630	1500	1316	686	1,25	33,60	8,96	-	764	879
		160				14	630	1600	1400	728	1,26	35,00	9,52	-	798	918
		180				14	630	1800	1540	798	1,26	39,20	10,64	-	867	997
		200				14	630	2000	1722	896	1,27	43,40	11,62	-	935	1075
		220				14	630	2200	1890	980	1,27	47,60	12,74	-	1006	1157
		250				14	630	2500	2128	1106	1,28	54,60	14,42	-	1113	1280
		300				14	630	3000	2548	1302	1,29	64,40	17,08	-	1283	1475
378	072	100	XX	YY	00	16	720	1000	1024	544	1,24	25,60	7,04	-	663	762
		120				16	720	1200	1216	640	1,24	30,40	8,32	-	739	850
		150				16	720	1500	1504	784	1,25	38,40	10,24	-	859	988
		160				16	720	1600	1600	832	1,26	40,00	10,88	-	900	1035
		180				16	720	1800	1760	912	1,26	44,80	12,16	-	978	1125
		200				16	720	2000	1968	1024	1,27	49,60	13,28	-	1056	1214
		220				16	720	2200	2160	1120	1,27	54,40	14,56	-	1138	1309
		250				16	720	2500	2432	1264	1,28	62,40	16,48	-	1254	1442
		300				16	720	3000	2912	1488	1,29	73,60	19,52	-	1455	1673
378	081	100	XX	YY	00	18	810	1000	1152	612	1,24	28,80	7,92	-	734	844
		120				18	810	1200	1368	720	1,24	34,20	9,36	-	822	945
		150				18	810	1500	1692	882	1,25	43,20	11,52	-	957	1101
		160				18	810	1600	1800	936	1,26	45,00	12,24	-	1001	1151
		180				18	810	1800	1980	1026	1,26	50,40	13,68	-	1091	1255
		200				18	810	2000	2214	1152	1,27	55,80	14,94	-	1178	1355
		220				18	810	2200	2430	1260	1,27	61,20	16,38	-	1271	1462
		250				18	810	2500	2736	1422	1,28	70,20	18,54	-	1404	1615
		300				18	810	3000	3276	1674	1,29	82,80	21,96	-	1626	1870
378	090	100	XX	YY	00	20	900	1000	1280	680	1,24	32,00	8,80	-	806	927
		120				20	900	1200	1520	800	1,24	38,00	10,40	-	902	1037
		150				20	900	1500	1880	980	1,25	48,00	12,80	-	1051	1209
		160				20	900	1600	2000	1040	1,26	50,00	13,60	-	1099	1264
		180				20	900	1800	2200	1140	1,26	56,00	15,20	-	1201	1381
		200				20	900	2000	2460	1280	1,27	62,00	16,60	-	1299	1494
		220				20	900	2200	2700	1400	1,27	68,00	18,20	-	1401	1611
		250				20	900	2500	3040	1580	1,28	78,00	20,60	-	1548	1780
		300				20	900	3000	3640	1860	1,29	92,00	24,40	-	1794	2063

Conform EN442-1: 2014: radiatoren en convectoren

Voor meer details over onze artikel-data, zie artikel-database: <https://www.2ba.nl>

Voor de warmteafgifte van andere regimes, kijkt u op p. 370 (correctiefactoren)
NEDERLAND. Prijzen in euro (excl. BTW)

HOE TULIPA-A VERTICAAL BESTELLEN

Leveringstermijn 15 - 30 werkdagen
(zonder transportduur)

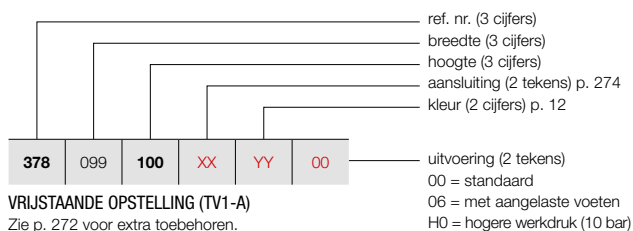

VRIJSTAANDE OPSTELLING (TV1-A)

Zie p. 272 voor extra toebehoren.

TULIPA-A VERTICAAL (TV1-A)



TV1-A

PRIJSGROEP: VPG2 - STAAL DESIGNRADIATOREN

BESTELCODE MAATWERK TULIPA-A VERTICAAL	TECHNISCHE GEGEVENS							STANDAARDKLEUR		ANDERE KLEUREN	
	buizen	breedte (L mm)	hoogte (H mm)	75/65/20 (Watt) (φ50K)	55/45/20 (Watt) (φ30K)	n-exp.	gewicht (kg)	inhoud (l)	el. weerst. (Watt)	prijs RAL 9016 (€)	prijs kleur (€)
REF. NR. TULIPA-A VERTICAAL TV1-A : 378											
378	099	100	XX	YY	00						
		120								876	1007
		150								985	1133
		160								1147	1319
		180								1202	1382
		200								1314	1511
		220								1421	1634
		250								1533	1763
										1695	1949
378	108	100	XX	YY	00						
		120								943	1084
		150								1066	1226
		160								1245	1432
		180								1302	1497
		200								1422	1635
		220								1542	1773
										1659	1908
378	117	100	XX	YY	00						
		120								1019	1172
		150								1147	1319
		160								1341	1542
		180								1404	1615
		200								1536	1766
										1661	1910
378	126	100	XX	YY	00						
		120								1090	1254
		150								1229	1413
		160								1436	1651
		180								1505	1731
										1648	1895

Conform EN442-1: 2014: radiatoren en convectoren

Voor meer details over onze artikel-data, zie artikel-database: <https://www.2ba.nl>

Voor de warmteafgifte van andere regimes, kijkt u op p. 370 (correctiefactoren)
NEDERLAND. Prijzen in euro (excl. BTW)

TULIPA-A VERTICAAL (TV2-A)



TV2-A

HOE TULIPA-A VERTICAAL BESTELLEN

Leveringstermijn 15 - 30 werkdagen
(zonder transportduur)

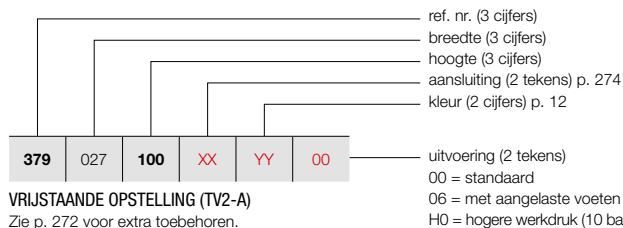

VRIJSTAANDE OPSTELLING (TV2-A)

Zie p. 272 voor extra toebehoren.

HOE VOORRAADRADIATOR VIOLA-A VERTICAAL BESTELLEN

Leveringstermijn 5 werkdagen
(zonder transportduur)

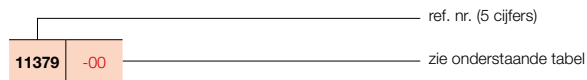

PRIJSGROEP: VPG2 - STAAL DESIGNRADIATOREN

BESTELCODE MAATWERK TULIPA-A VERTICAAL	TECHNISCHE GEGEVENS									STANDAARDKLEUR		ANDERE KLEUREN
	buizen	breedte (L mm)	hoogte (H mm)	75/65/20 (Watt) (Φ50K)	55/45/20 (Watt) (Φ30K)	n-exp.	gewicht (kg)	inhoud (l)	el. weerst. (Watt)	prijs RAL 9016 (€)	verkorte ref. nr. RAL 9016 voorraad	
REF. NR. TULIPA-A VERTICAAL TV2-A : 379												
379	027	100	XX	YY	00							
		120								528	-	607
		150								582	-	669
		160								661	-	760
		180								686	-	789
		200								738	-	849
		220								795	-	914
		250								844	-	971
		300								922	-	1060
										1053	-	1211
379	036	100	XX	YY	00							
		120								659	-	758
		150								726	-	835
		160								832	-	957
		180								867	-	997
		200								935	-	1075
		220								1004	-	1155
		250								1074	-	1235
		300								1178	-	1355
										1347	-	1549
379	045	100	XX	YY	00							
		120								783	-	900
		150								870	-	1001
		160								999	-	1149
		180								1042	-	1198
		200								1131	-	1301
		220								1212	-	1394
		250								1302	-	1497
		300								1435	-	1650
										1653	-	1901
379	054	100	XX	YY	00							
		120								903	-	1038
		150								1012	-	1164
		160								1168	-	1343
		180								1223	-	1406
		200								1325	-	1524
		220								1425	11379-01	1639
		250								1535	-	1765
		300								1687	-	1940
										1950	-	2243

Conform EN442-1: 2014: radiatoren en convectoren

Voor meer details over onze artikel-data, zie artikel-database: <https://www.2ba.nl>

Voor de warmteafgiftes van andere regimes, kijkt u op p. 370 (correctiefactoren)
NEDERLAND. Prijzen in euro (excl. BTW)

HOE TULIPA-A VERTICAAL BESTELLEN

Leveringstermijn 15 - 30 werkdagen
(zonder transportduur)

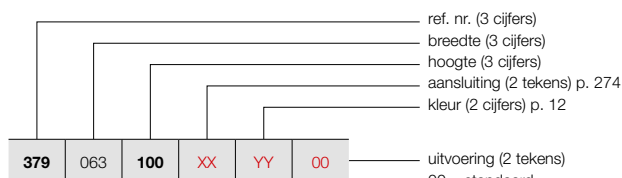

VRIJSTAANDE OPSTELLING (TV2-A)

Zie p. 272 voor extra toebehoren.

HOE VOORRAADRADIATOR VIOLA-A VERTICAAL BESTELLEN

Leveringstermijn 5 werkdagen
(zonder transportduur)

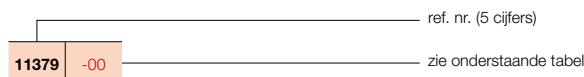

TULIPA-A VERTICAAL (TV2-A)



TV2-A

PRIJSGROEP: VPG2 - STAAL DESIGNRADIATOREN

BESTELCODE MAATWERK TULIPA-A VERTICAAL	TECHNISCHE GEGEVENS							STANDAARDKLEUR		ANDERE KLEUREN							
	buizen	breedte (L mm)	hoogte (H mm)	75/65/20 (Watt) (Φ50K)	55/45/20 (Watt) (Φ30K)	n-exp.	gewicht (kg)	inhoud (l)	el. weerst. (Watt)		prijs RAL 9016 (€)	verkorte ref. nr. RAL 9016 voorraad	prijs kleur (€)				
REF. NR. TULIPA-A VERTICAAL TV2-A : 379																	
379	063	100	XX	YY	00	14	630	1000	1484	770	1,26	43,40	11,62	-	1032	-	1187
		120				14	630	1200	1750	910	1,26	51,80	13,86	-	1155	-	1328
		150				14	630	1500	2156	1120	1,27	64,40	17,08	-	1338	-	1539
		160				14	630	1600	2296	1176	1,28	68,60	18,20	-	1397	-	1607
		180				14	630	1800	2646	1358	1,28	77,00	20,30	-	1515	-	1742
		200				14	630	2000	2828	1456	1,29	85,40	22,54	-	1639	11379-02	1885
		220				14	630	2200	3094	1596	1,29	93,80	24,64	-	1764	-	2029
		250				14	630	2500	3500	1792	1,30	106,40	28,00	-	1946	-	2238
		300				14	630	3000	4172	2114	1,31	127,40	33,46	-	2247	-	2584
379	072	100	XX	YY	00	16	720	1000	1696	880	1,26	49,60	13,28	-	1157	-	1331
		120				16	720	1200	2000	1040	1,26	59,20	15,84	-	1294	-	1488
		150				16	720	1500	2464	1280	1,27	73,60	19,52	-	1504	-	1730
		160				16	720	1600	2624	1344	1,28	78,40	20,80	-	1572	-	1808
		180				16	720	1800	3024	1552	1,28	88,00	23,20	-	1713	-	1970
		200				16	720	2000	3232	1664	1,29	97,60	25,76	-	1850	-	2128
		220				16	720	2200	3536	1824	1,29	107,20	28,16	-	1990	-	2289
		250				16	720	2500	4000	2048	1,30	121,60	32,00	-	2198	-	2528
		300				16	720	3000	4768	2416	1,31	145,60	38,24	-	2545	-	2927
379	081	100	XX	YY	00	18	810	1000	1908	990	1,26	55,80	14,94	-	1281	-	1473
		120				18	810	1200	2250	1170	1,26	66,60	17,82	-	1437	-	1653
		150				18	810	1500	2772	1440	1,27	82,80	21,96	-	1672	-	1923
		160				18	810	1600	2952	1512	1,28	88,20	23,40	-	1749	-	2011
		180				18	810	1800	3402	1746	1,28	99,00	26,10	-	1907	-	2193
		200				18	810	2000	3636	1872	1,29	109,80	28,98	-	2065	-	2375
		220				18	810	2200	3978	2052	1,29	120,60	31,68	-	2217	-	2550
		250				18	810	2500	4500	2304	1,30	136,80	36,00	-	2456	-	2824
		300				18	810	3000	5364	2718	1,31	163,80	43,02	-	2846	-	3273
379	090	100	XX	YY	00	20	900	1000	2120	1100	1,26	62,00	16,60	-	1404	-	1615
		120				20	900	1200	2500	1300	1,26	74,00	19,80	-	1582	-	1819
		150				20	900	1500	3080	1600	1,27	92,00	24,40	-	1837	-	2113
		160				20	900	1600	3280	1680	1,28	98,00	26,00	-	1924	-	2213
		180				20	900	1800	3780	1940	1,28	110,00	29,00	-	2103	-	2418
		200				20	900	2000	4040	2080	1,29	122,00	32,20	-	2273	-	2614
		220				20	900	2200	4420	2280	1,29	134,00	35,20	-	2447	-	2814
		250				20	900	2500	5000	2560	1,30	152,00	40,00	-	2708	-	3114
		300				20	900	3000	5960	3020	1,31	182,00	47,80	-	3144	-	3616

Conform EN442-1: 2014: radiatoren en convectoren

Voor meer details over onze artikel-data, zie artikel-database: <https://www.2ba.nl>
Voor de warmteafgiftes van andere regimes, kijkt u op p. 370 (correctiefactoren)
NEDERLAND. Prijzen in euro (excl. BTW)

TULIPA-A VERTICAAL (TV2-A)



TV2-A

HOE TULIPA-A VERTICAAL BESTELLEN

Leveringstermijn 15 - 30 werkdagen
(zonder transportduur)

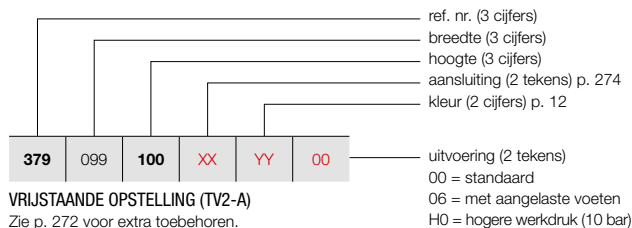

VRIJSTAANDE OPSTELLING (TV2-A)

Zie p. 272 voor extra toebehoren.

PRIJSGROEP: VPG2 - STAAL DESIGNRADIATOREN

BESTELCODE MAATWERK TULIPA-A VERTICAAL							TECHNISCHE GEGEVENS					STANDAARDKLEUR	ANDERE KLEUREN				
379	099	100	XX	YY	00	buizen	breedte (L mm)	hoogte (H mm)	75/65/20 (Watt) (Φ50K)	55/45/20 (Watt) (Φ30K)	n-exp.	gewicht (kg)	inhoud (l)	el. weerst. (Watt)	prijs RAL 9016 (€)	prijs kleur (€)	
REF. NR. TULIPA-A VERTICAAL TV2-A : 379																	
379	099	100	XX	YY	00	22	990	1000	2332	1210	1,26	68,20	18,26	-	1535	1765	
		120				22	990	1200	2750	1430	1,26	81,40	21,78	-	1723	1981	
		150				22	990	1500	3388	1760	1,27	101,20	26,84	-	2008	2309	
		160				22	990	1600	3608	1848	1,28	107,80	28,60	-	2104	2420	
		180				22	990	1800	4158	2134	1,28	121,00	31,90	-	2297	2642	
		200				22	990	2000	4444	2288	1,29	134,20	35,42	-	2486	2859	
		220				22	990	2200	4862	2508	1,29	147,40	38,72	-	2677	3079	
		250				22	990	2500	5500	2816	1,30	167,20	44,00	-	2967	3412	
379	108	100	XX	YY	00	24	1080	1000	2544	1320	1,26	74,40	19,92	-	1656	1904	
		120				24	1080	1200	3000	1560	1,26	88,80	23,76	-	1864	2144	
		150				24	1080	1500	3696	1920	1,27	110,40	29,28	-	2177	2504	
		160				24	1080	1600	3936	2016	1,28	117,60	31,20	-	2281	2623	
		180				24	1080	1800	4536	2328	1,28	132,00	34,80	-	2488	2861	
		200				24	1080	2000	4848	2496	1,29	146,40	38,64	-	2698	3103	
		220				24	1080	2200	5304	2736	1,29	160,80	42,24	-	2907	3343	
379	117	100	XX	YY	00	26	1170	1000	2756	1430	1,26	80,60	21,58	-	1780	2047	
		120				26	1170	1200	3250	1690	1,26	96,20	25,74	-	2008	2309	
		150				26	1170	1500	4004	2080	1,27	119,60	31,72	-	2346	2698	
		160				26	1170	1600	4264	2184	1,28	127,40	33,80	-	2459	2828	
		180				26	1170	1800	4914	2522	1,28	143,00	37,70	-	2687	3090	
		200				26	1170	2000	5252	2704	1,29	158,60	41,86	-	2910	3347	
379	126	100	XX	YY	00	28	1260	1000	2968	1540	1,26	86,80	23,24	-	1905	2191	
		120				28	1260	1200	3500	1820	1,26	103,60	27,72	-	2151	2474	
		150				28	1260	1500	4312	2240	1,27	128,80	34,16	-	2512	2889	
		160				28	1260	1600	4592	2352	1,28	137,20	36,40	-	2633	3028	
		180				28	1260	1800	5292	2716	1,28	154,00	40,60	-	2880	3312	

Conform EN442-1: 2014: radiatoren en convectoren

Voor meer details over onze artikel-data, zie artikel-database: <https://www.2ba.nl>

Voor de warmteafgifte van andere regimes, kijkt u op p. 370 (correctiefactoren)
NEDERLAND. Prijzen in euro (excl. BTW)

TYPES

- Eén (TH1-A) of twee rijen buizen (TH2-A)

BUIZEN

- Verticaal, platovaal 60 x 10 mm

COLLECTOREN

- Horizontaal, achterliggend, rond Ø 32 mm

KLEUREN

- Standaardkleur wit RAL 9016
- Uitgebreide kleurenkaart zie p. 12

SPECIAAL

- TH1-A ook verkrijgbaar als toiletradiator (540 x 500 mm)

BEVESTIGINGEN

- Muurbevestigingen standaard (inbegrepen in de verpakking van de radiator)
- **TH1-A / TH2-A:** ook verkrijgbaar als vrijstaande opstelling, zie p. 272. Extra muurbevestigingssteun nodig voor hoogte radiator > 600 mm.

TECHNISCH

- Weerstandsgelast (onzichtbare lasnaden)
- ATL-grondlaag, poedercoating
- Standaardwerkdruk: 6 bar. Meerprijs hogere werkdruk (10 bar): +10%.
- De leveringstermijn van radiator met een hogere werkdruk is 1 week extra.
- Maximale bedrijfstemperatuur: 110°C

ELEKTRISCH

- ✗ Zuiver elektrische radiator in de fabriek voorgevuld
- ✗ Gemengde radiator

TECHNISCHE TEKENINGEN

- Zie p. 275

AANSLUITING

- ✗ Eénpuntsaansluiting voor éénpijpsysteem
- ✗ Eénpuntsaansluiting voor tweepijpsysteem
- ✓ Tweepuntsaansluiting voor éénpijpsysteem (aansluiting via de middenaansluiting) (zie p. 362)
- ✓ Tweepuntsaansluiting voor tweepijpsysteem (standaard) (zie p. 362)
- ✗ Geïntegreerd ventiel
- Aansluitingen: ½" (binnendraad)

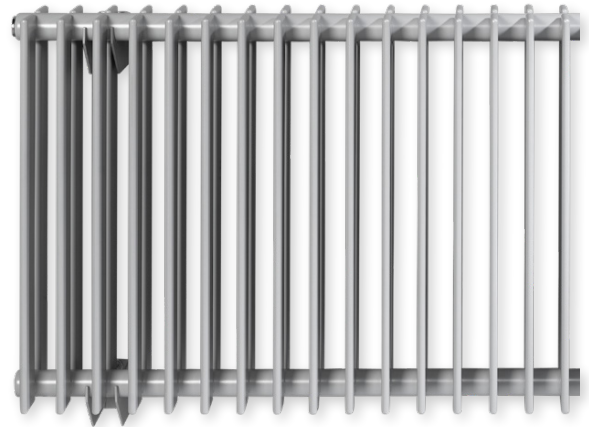
**TULIPA-A HORIZONTAAL****Eeuwige charme, tijdloze klasse**

De horizontale versie van de Tulipa-A. Het schoolvoorbeeld van een designradiator in zijn meest authentieke vorm. Gekenmerkt door de klassieke open structuur en de loodrechte aansluiting van de buizen op de collector. Een designradiator die blijft charmeren. Trendoverstijgend en overal toepasbaar.

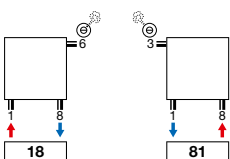
AANBEVOLEN AANSLUITING (18)

art. nr. 1182 101 0000 0099
prijs €234
 Koppelingen, zie p. 377

Andere aansluitmogelijkheden, zie p. 274

AANBEVOLEN VOOR BADKAMER EN KEUKEN IN OPTIE

handdoekbeugel (RAL 9005)
 art. nr. zie p. 273
prijs €157
 Andere accessoires, zie p. 273



TH1-A / TH2-A

TULIPA-A HORIZONTAAL (TH1-A)



TH1-A

HOE TULIPA-A HORIZONTAAL BESTELLEN

Leveringstermijn 15 - 30 werkdagen
(zonder transportduur)

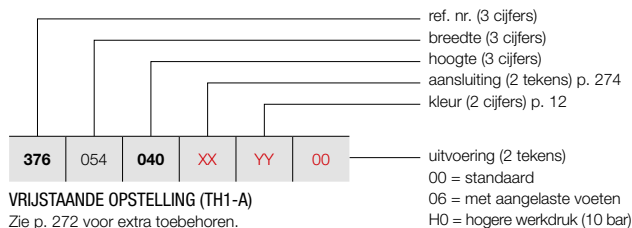

VRIJSTAANDE OPSTELLING (TH1-A)

Zie p. 272 voor extra toebehoren.

PRIJSGROEP: VPG2 - STAAL DESIGNRADIATOREN

BESTELCODE MAATWERK TULIPA-A HORIZONTAAL	TECHNISCHE GEGEVENS									STANDAARDKLEUR	ANDERE KLEUREN					
	buizen	breedte (L mm)	hoogte (H mm)	75/65/20 (Watt) (Φ50K)	55/45/20 (Watt) (Φ30K)	n-exp.	gewicht (kg)	inhoud (l)	el. weerst. (Watt)	prijs RAL 9016 (€)	prijs kleur (€)					
REF. NR. TULIPA-A HORIZONTAAL TH1-A : 376																
376	054	040	XX	YY	00	12	540	400	348	180	1,22	9,60	2,52	-	340	391
		050				12	540	500	420	216	1,23	10,80	3,00	-	367	422
		060				12	540	600	492	264	1,23	12,00	3,48	-	399	459
		070				12	540	700	564	300	1,23	14,40	3,96	-	429	493
		080				12	540	800	636	336	1,23	15,60	4,44	-	460	529
		090				12	540	900	696	372	1,24	18,00	4,92	-	487	560
376	063	040	XX	YY	00	14	630	400	406	210	1,22	11,20	2,94	-	381	438
		050				14	630	500	490	252	1,23	12,60	3,50	-	415	477
		060				14	630	600	574	308	1,23	15,40	4,06	-	447	514
		070				14	630	700	658	350	1,23	16,80	4,62	-	485	558
		080				14	630	800	742	392	1,23	18,20	5,18	-	519	597
		090				14	630	900	812	434	1,24	21,00	5,74	-	558	642
376	072	040	XX	YY	00	16	720	400	464	240	1,22	12,80	3,36	-	419	482
		050				16	720	500	560	288	1,23	14,40	4,00	-	463	532
		060				16	720	600	656	352	1,23	17,60	4,64	-	501	576
		070				16	720	700	752	400	1,23	19,20	5,28	-	539	620
		080				16	720	800	848	448	1,23	20,80	5,92	-	580	667
		090				16	720	900	928	496	1,24	24,00	6,56	-	622	715
376	081	040	XX	YY	00	18	810	400	522	270	1,22	14,40	3,78	-	467	537
		050				18	810	500	630	324	1,23	16,20	4,50	-	508	584
		060				18	810	600	738	396	1,23	19,80	5,22	-	558	642
		070				18	810	700	846	450	1,23	21,60	5,94	-	598	688
		080				18	810	800	954	504	1,23	23,40	6,66	-	642	738
		090				18	810	900	1044	558	1,24	27,00	7,38	-	686	789
376	090	040	XX	YY	00	20	900	400	580	300	1,22	16,00	4,20	-	506	582
		050				20	900	500	700	360	1,23	18,00	5,00	-	559	643
		060				20	900	600	820	440	1,23	22,00	5,80	-	607	698
		070				20	900	700	940	500	1,23	24,00	6,60	-	653	751
		080				20	900	800	1060	560	1,23	26,00	7,40	-	705	811
		090				20	900	900	1160	620	1,24	30,00	8,20	-	756	869
376	099	040	XX	YY	00	22	990	400	638	330	1,22	17,60	4,62	-	547	629
		050				22	990	500	770	396	1,23	19,80	5,50	-	604	695
		060				22	990	600	902	484	1,23	24,20	6,38	-	656	754
		070				22	990	700	1034	550	1,23	26,40	7,26	-	712	819
		080				22	990	800	1166	616	1,23	28,60	8,14	-	763	877
		090				22	990	900	1276	682	1,24	33,00	9,02	-	819	942
376	108	040	XX	YY	00	24	1080	400	696	360	1,22	19,20	5,04	-	587	675
		050				24	1080	500	840	432	1,23	21,60	6,00	-	650	748
		060				24	1080	600	984	528	1,23	26,40	6,96	-	709	815
		070				24	1080	700	1128	600	1,23	28,80	7,92	-	767	882
		080				24	1080	800	1272	672	1,23	31,20	8,88	-	826	950
		090				24	1080	900	1392	744	1,24	36,00	9,84	-	886	1019

Conform EN442-1: 2014: radiatoren en convectoren

Voor meer details over onze artikel-data, zie artikel-database: <https://www.2ba.nl>

Voor de warmteafgifte van andere regimes, kijkt u op p. 370 (correctiefactoren)
NEDERLAND. Prijzen in euro (excl. BTW)

HOE TULIPA-A HORIZONTAAL BESTELLEN

Leveringstermijn 15 - 30 werkdagen
(zonder transportduur)

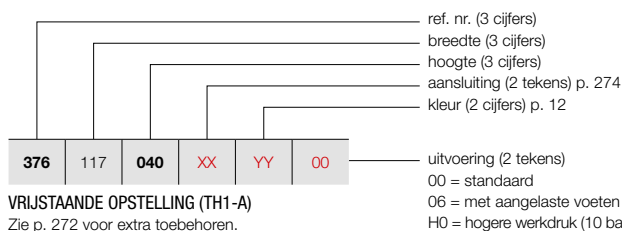

VRIJSTAANDE OPSTELLING (TH1-A)

Zie p. 272 voor extra toebehoren.

TULIPA-A HORIZONTAAL (TH1-A)



TH1-A

PRIJSGROEP: VPG2 - STAAL DESIGNRADIATOREN

BESTELCODE MAATWERK TULIPA-A HORIZONTAAL	TECHNISCHE GEGEVENS							STANDAARDKLEUR		ANDERE KLEUREN	
	buizen	breedte (L mm)	hoogte (H mm)	75/65/20 (Watt) (φ50K)	55/45/20 (Watt) (φ30K)	n-exp.	gewicht (kg)	inhoud (l)	el. weerst. (Watt)	prijs RAL 9016 (€)	prijs kleur (€)
REF. NR. TULIPA-A HORIZONTAAL TH1-A : 376											
376 117 040 XX YY 00	26	1170	400	754	390	1,22	20,80	5,46	-	631	726
	26	1170	500	910	468	1,23	23,40	6,50	-	695	799
	26	1170	600	1066	572	1,23	28,60	7,54	-	759	873
	26	1170	700	1222	650	1,23	28,80	8,58	-	823	946
	26	1170	800	1378	728	1,23	31,20	9,62	-	891	1025
	26	1170	900	1508	806	1,24	36,00	10,66	-	956	1099
	26	1170	900	1508	806	1,24	36,00	10,66	-	956	1099
376 126 040 XX YY 00	28	1260	400	812	420	1,22	22,40	5,88	-	671	772
	28	1260	500	980	504	1,23	25,20	7,00	-	740	851
	28	1260	600	1148	616	1,23	30,80	8,12	-	812	934
	28	1260	700	1316	700	1,23	33,60	9,24	-	879	1011
	28	1260	800	1484	784	1,23	36,40	10,36	-	949	1091
	28	1260	900	1624	868	1,24	42,00	11,48	-	1020	1173
376 144 040 XX YY 00	32	1440	400	928	480	1,22	25,60	6,72	-	756	869
	32	1440	500	1120	576	1,23	28,80	8,00	-	833	958
	32	1440	600	1312	704	1,23	35,20	9,28	-	915	1052
	32	1440	700	1504	800	1,23	38,40	10,56	-	992	1141
	32	1440	800	1696	896	1,23	41,60	11,84	-	1074	1235
	32	1440	900	1856	992	1,24	48,00	13,12	-	1154	1327
	32	1440	900	1856	992	1,24	48,00	13,12	-	1154	1327
376 162 040 XX YY 00	36	1620	400	1044	540	1,22	28,80	7,56	-	841	967
	36	1620	500	1260	648	1,23	32,40	9,00	-	927	1066
	36	1620	600	1476	792	1,23	39,60	10,44	-	1019	1172
	36	1620	700	1692	900	1,23	43,20	11,88	-	1104	1270
	36	1620	800	1908	1008	1,23	46,80	13,32	-	1198	1378
	36	1620	900	2088	1116	1,24	54,00	14,76	-	1284	1477
376 180 040 XX YY 00	40	1800	400	1160	600	1,22	32,00	8,40	-	922	1060
	40	1800	500	1400	720	1,23	36,00	10,00	-	1021	1174
	40	1800	600	1640	880	1,23	44,00	11,60	-	1118	1286
	40	1800	700	1880	1000	1,23	48,00	13,20	-	1223	1406
	40	1800	800	2120	1120	1,23	52,00	14,80	-	1320	1518
	40	1800	900	2320	1240	1,24	60,00	16,40	-	1419	1632
	40	1800	900	2320	1240	1,24	60,00	16,40	-	1419	1632
376 198 040 XX YY 00	44	1980	400	1276	660	1,22	35,20	9,24	-	1004	1155
	44	1980	500	1540	792	1,23	39,60	11,00	-	1114	1281
	44	1980	600	1804	968	1,23	48,40	12,76	-	1226	1410
	44	1980	700	2068	1100	1,23	52,80	14,52	-	1333	1533
	44	1980	800	2332	1232	1,23	57,20	16,28	-	1444	1661
	44	1980	900	2552	1364	1,24	66,00	18,04	-	1549	1781
376 216 040 XX YY 00	48	2160	400	1392	720	1,22	38,40	10,08	-	1090	1254
	48	2160	500	1680	864	1,23	43,20	12,00	-	1207	1388
	48	2160	600	1968	1056	1,23	52,80	13,92	-	1329	1528
	48	2160	700	2256	1200	1,23	57,60	15,84	-	1446	1663
	48	2160	800	2544	1344	1,23	62,40	17,76	-	1565	1800
	48	2160	900	2784	1488	1,24	72,00	19,68	-	1685	1938

Conform EN442-1: 2014: radiatoren en convectoren

Voor meer details over onze artikel-data, zie artikel-database: <https://www.2ba.nl>

Voor de warmteafgiftes van andere regimes, kijkt u op p. 370 (correctiefactoren)
NEDERLAND. Prijzen in euro (excl. BTW)

TULIPA-A HORIZONTAAL (TH1-A)



TH1-A

HOE TULIPA-A HORIZONTAAL BESTELLEN

Leveringstermijn 15 - 30 werkdagen
(zonder transportduur)

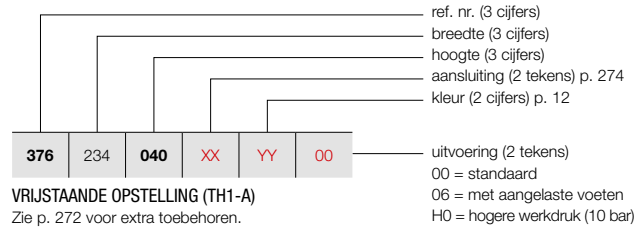

VRIJSTAANDE OPSTELLING (TH1-A)

Zie p. 272 voor extra toebehoren.

PRIJSGROEP: VPG2 - STAAL DESIGNRADIATOREN

BESTELCODE MAATWERK TULIPA-A HORIZONTAAL	TECHNISCHE GEGEVENS									STANDAARDKLEUR	ANDERE KLEUREN
	buizen	breedte (L mm)	hoogte (H mm)	75/65/20 (Watt) (Φ50K)	55/45/20 (Watt) (Φ30K)	n-exp.	gewicht (kg)	inhoud (l)	el. weerst. (Watt)	prijs RAL 9016 (€)	prijs kleur (€)
REF. NR. TULIPA-A HORIZONTAAL TH1-A : 376											
376	234	040	XX	YY	00						
		050									
		060									
		070									
		080									
		090									
376	252	040	XX	YY	00						
		050									
		060									
		070									
		080									
		090									
376	270	040	XX	YY	00						
		050									
		060									
		070									
		080									
376	288	040	XX	YY	00						
		050									
		060									
		070									
376	306	040	XX	YY	00						
		050									
		060									
		070									

Conform EN442-1: 2014: radiatoren en convectoren

Voor meer details over onze artikel-data, zie artikel-database: <https://www.2ba.nl>

Voor de warmteafgifte van andere regimes, kijkt u op p. 370 (correctiefactoren)
NEDERLAND. Prijzen in euro (excl. BTW)

HOE TULIPA-A HORIZONTAAL BESTELLEN

Leveringstermijn 15 - 30 werkdagen
(zonder transportduur)

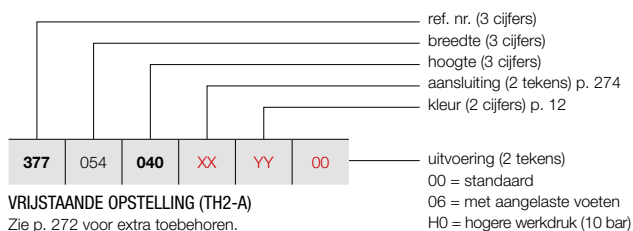

VRIJSTAANDE OPSTELLING (TH2-A)

Zie p. 272 voor extra toebehoren.

TULIPA-A HORIZONTAAL (TH2-A)

269



TH2-A

PRIJSGROEP: VPG2 - STAAL DESIGNRADIATOREN

BESTELCODE MAATWERK TULIPA-A HORIZONTAAL	TECHNISCHE GEGEVENS							STANDAARDKLEUR		ANDERE KLEUREN	
	buizen	breedte (L mm)	hoogte (H mm)	75/65/20 (Watt) (Φ50K)	55/45/20 (Watt) (Φ30K)	n-exp.	gewicht (kg)	inhoud (l)	el. weerst. (Watt)	prijs RAL 9016 (€)	prijs kleur (€)
REF. NR. TULIPA-A HORIZONTAAL TH2-A : 377											
377	054	040	XX	YY	00						
		050								590	679
		060								646	743
		070								696	800
		080								753	866
		090								806	927
										854	982
377	063	040	XX	YY	00						
		050								668	768
		060								726	835
		070								788	906
		080								847	974
		090								912	1049
										970	1116
377	072	040	XX	YY	00						
		050								738	849
		060								810	932
		070								878	1010
		080								946	1088
		090								1019	1172
										1087	1250
377	081	040	XX	YY	00						
		050								812	934
		060								892	1026
		070								970	1116
		080								1048	1205
		090								1122	1290
										1202	1382
377	090	040	XX	YY	00						
		050								883	1015
		060								974	1120
		070								1061	1220
		080								1145	1317
		090								1233	1418
										1322	1520
377	099	040	XX	YY	00						
		050								959	1103
		060								1053	1211
		070								1147	1319
		080								1246	1433
		090								1338	1539
										1436	1651
377	108	040	XX	YY	00						
		050								1030	1185
		060								1137	1308
		070								1239	1425
		080								1343	1544
		090								1449	1666
										1549	1781

Conform EN442-1: 2014: radiatoren en convectoren

Voor meer details over onze artikel-data, zie artikel-database: <https://www.2ba.nl>

Voor de warmteafgiftes van andere regimes, kijkt u op p. 370 (correctiefactoren)
NEDERLAND. Prijzen in euro (excl. BTW)

TULIPA-A HORIZONTAAL (TH2-A)

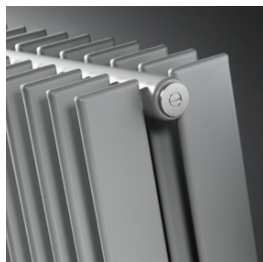

TH2-A

HOE TULIPA-A HORIZONTAAL BESTELLEN

Leveringstermijn 15 - 30 werkdagen
(zonder transportduur)

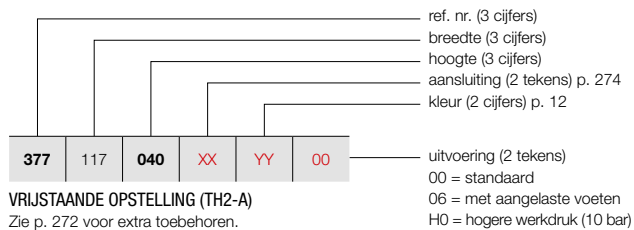

VRIJSTAANDE OPSTELLING (TH2-A)

Zie p. 272 voor extra toebehoren.

PRIJSGROEP: VPG2 - STAAL DESIGNRADIATOREN

BESTELCODE MAATWERK TULIPA-A HORIZONTAAL							TECHNISCHE GEGEVENS					STANDAARDKLEUR	ANDERE KLEUREN				
377	117	040	XX	YY	00	buizen	breedte (L mm)	hoogte (H mm)	75/65/20 (Watt) (Ø50K)	55/45/20 (Watt) (Ø30K)	n-exp.	gewicht (kg)	inhoud (l)	el. weerst. (Watt)	prijs RAL 9016 (€)	prijs kleur (€)	
REF. NR. TULIPA-A HORIZONTAAL TH2-A : 377																	
377	117	040	XX	YY	00	26	1170	400	1274	676	1,24	36,40	9,36	-	1100	1265	
		050				26	1170	500	1404	806	1,25	44,20	11,44	-	1217	1400	
		060				26	1170	600	1768	936	1,25	52,00	13,52	-	1330	1530	
		070				26	1170	700	2028	1066	1,25	57,20	15,60	-	1444	1661	
		080				26	1170	800	2262	1196	1,25	65,00	17,68	-	1559	1793	
		090				26	1170	900	2522	1300	1,26	72,80	19,50	-	1669	1919	
377	126	040	XX	YY	00	28	1260	400	1372	728	1,24	39,20	10,08	-	1172	1348	
		050				28	1260	500	1512	868	1,25	47,60	12,32	-	1299	1494	
		060				28	1260	600	1904	1008	1,25	56,00	14,56	-	1421	1634	
		070				28	1260	700	2184	1148	1,25	61,60	16,80	-	1542	1773	
		080				28	1260	800	2436	1288	1,25	70,00	19,04	-	1661	1910	
		090				28	1260	900	2716	1400	1,26	78,40	21,00	-	1782	2049	
377	144	040	XX	YY	00	32	1440	400	1568	832	1,24	44,80	11,52	-	1322	1520	
		050				32	1440	500	1728	992	1,25	54,40	14,08	-	1459	1678	
		060				32	1440	600	2176	1152	1,25	64,00	16,64	-	1598	1838	
		070				32	1440	700	2496	1312	1,25	70,40	19,20	-	1740	2001	
		080				32	1440	800	2784	1472	1,25	80,00	21,76	-	1877	2159	
		090				32	1440	900	3104	1600	1,26	89,60	24,00	-	2017	2320	
377	162	040	XX	YY	00	36	1620	400	1764	936	1,24	50,40	12,96	-	1467	1687	
		050				36	1620	500	1944	1116	1,25	61,20	15,84	-	1624	1868	
		060				36	1620	600	2448	1296	1,25	72,00	18,72	-	1780	2047	
		070				36	1620	700	2808	1476	1,25	79,20	21,60	-	1936	2226	
		080				36	1620	800	3132	1656	1,25	90,00	24,48	-	2090	2404	
		090				36	1620	900	3492	1800	1,26	100,80	27,00	-	2251	2589	
377	180	040	XX	YY	00	40	1800	400	1960	1040	1,24	56,00	14,40	-	1613	1855	
		050				40	1800	500	2160	1240	1,25	68,00	17,60	-	1786	2054	
		060				40	1800	600	2720	1440	1,25	80,00	20,80	-	1959	2253	
		070				40	1800	700	3120	1640	1,25	88,00	24,00	-	2134	2454	
		080				40	1800	800	3480	1840	1,25	100,00	27,20	-	2306	2652	
		090				40	1800	900	3880	2000	1,26	112,00	30,00	-	2484	2857	
377	198	040	XX	YY	00	44	1980	400	2156	1144	1,24	61,60	15,84	-	1761	2025	
		050				44	1980	500	2376	1364	1,25	74,80	19,36	-	1950	2243	
		060				44	1980	600	2992	1584	1,25	88,00	22,88	-	2138	2459	
		070				44	1980	700	3432	1804	1,25	96,80	26,40	-	2333	2683	
		080				44	1980	800	3828	2024	1,25	110,00	29,92	-	2526	2905	
		090				44	1980	900	4268	2200	1,26	123,20	33,00	-	2712	3119	
377	216	040	XX	YY	00	48	2160	400	2352	1248	1,24	67,20	17,28	-	1905	2191	
		050				48	2160	500	2592	1488	1,25	81,60	21,12	-	2116	2433	
		060				48	2160	600	3264	1728	1,25	96,00	24,96	-	2323	2671	
		070				48	2160	700	3744	1968	1,25	105,60	28,80	-	2530	2910	
		080				48	2160	800	4176	2208	1,25	120,00	32,64	-	2737	3148	
		090				48	2160	900	4656	2400	1,26	134,40	36,00	-	2947	3389	

Conform EN442-1: 2014: radiatoren en convectoren

Voor meer details over onze artikel-data, zie artikel-database: <https://www.2ba.nl>

Voor de warmteafgiftes van andere regimes, kijkt u op p. 370 (correctiefactoren)
NEDERLAND. Prijzen in euro (excl. BTW)

HOE TULIPA-A HORIZONTAAL BESTELLEN

Leveringstermijn 15 - 30 werkdagen
(zonder transportduur)

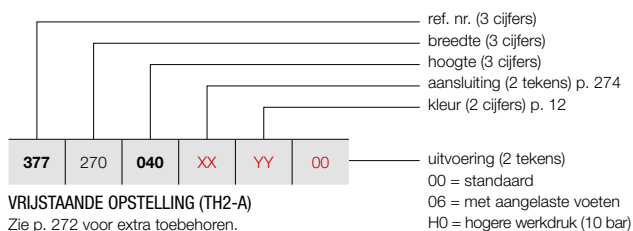

VRIJSTAANDE OPSTELLING (TH2-A)

Zie p. 272 voor extra toebehoren.

TULIPA-A HORIZONTAAL (TH2-A)

271



TH2-A

PRIJSGROEP: VPG2 - STAAL DESIGNRADIATOREN

BESTELCODE MAATWERK TULIPA-A HORIZONTAAL	TECHNISCHE GEGEVENS								STANDAARDKLEUR		ANDERE KLEUREN					
	buizen	breedte (L mm)	hoogte (H mm)	75/65/20 (Watt) (φ50K)	55/45/20 (Watt) (φ30K)	n-exp.	gewicht (kg)	inhoud (l)	el. weerst. (Watt)	prijs RAL 9016 (€)	prijs kleur (€)					
REF. NR. TULIPA-A HORIZONTAAL TH2-A : 377																
377	234	040	XX	YY	00	52	2340	400	2548	1352	1,24	72,80	18,72	-	2051	2359
		050				52	2340	500	2808	1612	1,25	88,40	22,88	-	2277	2619
		060				52	2340	600	3536	1872	1,25	104,00	27,04	-	2501	2876
		070				52	2340	700	4056	2132	1,25	114,40	31,20	-	2727	3136
		080				52	2340	800	4524	2392	1,25	130,00	35,36	-	2951	3394
		090				52	2340	900	5044	2600	1,26	145,60	39,00	-	3181	3658
377	252	040	XX	YY	00	56	2520	400	2744	1456	1,24	78,40	20,16	-	2193	2522
		050				56	2520	500	3024	1736	1,25	95,20	24,64	-	2439	2805
		060				56	2520	600	3808	2016	1,25	112,00	29,12	-	2685	3088
		070				56	2520	700	4368	2296	1,25	123,20	33,60	-	2928	3367
		080				56	2520	800	4872	2576	1,25	140,00	38,08	-	3166	3641
		090				56	2520	900	5432	2800	1,26	156,80	42,00	-	3413	3925
377	270	040	XX	YY	00	60	2700	400	2940	1560	1,24	84,00	21,60	-	2341	2692
		050				60	2700	500	3240	1860	1,25	102,00	26,40	-	2600	2990
		060				60	2700	600	4080	2160	1,25	120,00	31,20	-	2862	3291
		070				60	2700	700	4680	2460	1,25	132,00	36,00	-	3118	3586
		080				60	2700	800	5220	2760	1,25	150,00	40,80	-	3383	3890
377	288	040	XX	YY	00	64	2880	400	3136	1664	1,24	89,60	23,04	-	2486	2859
		050				64	2880	500	3456	1984	1,25	108,80	28,16	-	2766	3181
		060				64	2880	600	4352	2304	1,25	128,00	33,28	-	3044	3501
		070				64	2880	700	4992	2624	1,25	140,80	38,40	-	3321	3819
377	306	040	XX	YY	00	68	3060	400	3332	1768	1,24	95,20	24,48	-	2631	3026
		050				68	3060	500	3672	2108	1,25	115,60	29,92	-	2930	3370
		060				68	3060	600	4624	2448	1,25	136,00	35,36	-	3222	3705
		070				68	3060	700	5304	2788	1,25	149,60	40,80	-	3520	4048

Conform EN442-1: 2014: radiatoren en convectoren

Voor meer details over onze artikel-data, zie artikel-database: <https://www.2ba.nl>

Voor de warmteafgiftes van andere regimes, kijkt u op p. 370 (correctiefactoren)
NEDERLAND. Prijzen in euro (excl. BTW)

TULIPA-A VRIJSTAANDE OPSTELLING IN OPTIE

PRIJSGROEP: VPG10 - ACC.

VRIJSTAANDE OPSTELLING		KLEUR	ART. NR.	€	
VASTE VOET		TV1-A / TH1-A			
		150 mm	RAL 9016	*	101
		(geen zijbevestiging)	KLEUR	*	116
		TV2-A / TH2-A			
		150 mm	RAL 9016	*	182
		(geen zijbevestiging)	KLEUR	*	209

- Extra muurbevestigingssteun nodig voor hoogte radiator > 600 mm (meegeleverd).
- Gelieve bij bestelling code **06** aan te geven bij "Afwerking" (vaste voet in de prijs inbegrepen).
- Geen rozetten beschikbaar.

	TV1-A / TV2-A	TH1-A / TH2-A		
lengte radiator (mm)		540 - 1440	1620 - 2340	> 2340
aantal voeten	2x	2x	3x	4x

NEDERLAND. Prijzen in euro (excl. BTW)

PRIJSGROEP: VPG10B - HANDDOEKBEUGELS

ACCESSOIRES	BREEDTE HANDDOEKBEUGEL	KLEUR	ART. NR.	€
HANDDOEKBEUGEL	TV1-A / TV2-A / TH1-A / TH2-A			
	500 mm	CHROOM	1183 269 0000 0099	157
	500 mm	RAL 9016	1183 269 0000 9016	157
	500 mm	RAL 9005 ^M	1183 269 0000 9005	157



- h = 55 mm; b = 500 mm; d = 58 mm; a = 43 mm;

^M mat zwart

Montagevoorschriften accessoires: zie www.vasco.eu
NEDERLAND. Prijzen in euro (excl. BTW)

d = afstand voorkant accessoire tot voorkant radiator
a = afstand accessoire tot radiator
uit voorraad leverbaar

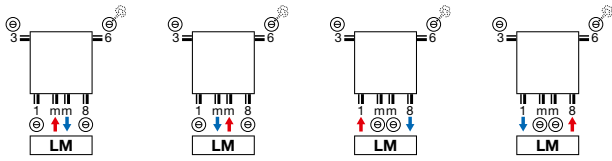
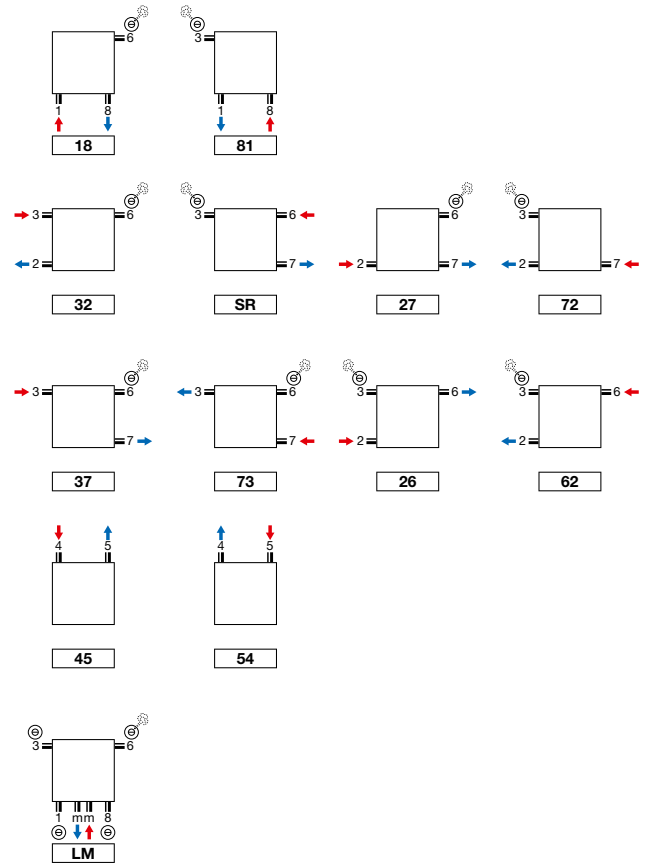
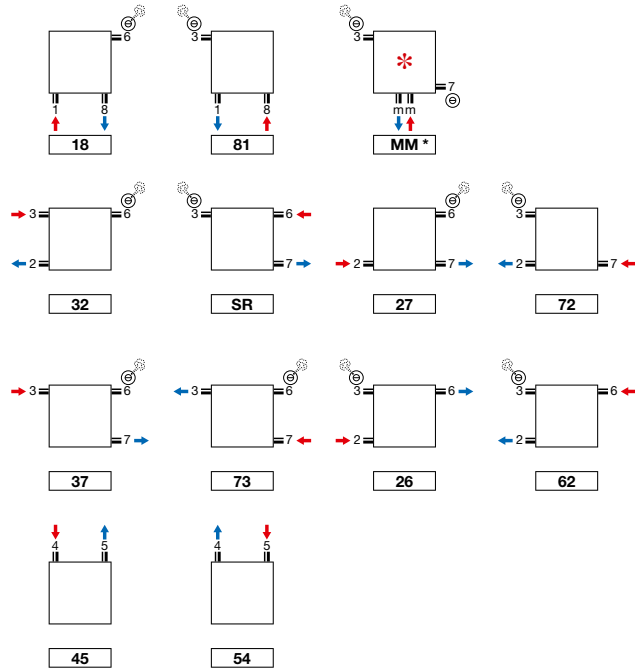
TULIPA-A VERTICAAL: TV1-A / TV2-A (VOORRAAD)**TULIPA-A HORIZONTAAL: TH1-A / TH2-A (NIET-VOORRAAD)****TULIPA-A VERTICAAL: TV1-A / TV2-A (NIET-VOORRAAD)**

- * Aansluiting MM: aanvoer moet aan de rechterkant!
 • Tulipa-A 6 en 8 buizen: aansluiting 1mm8, 18, 81 niet mogelijk

Opmerking: het aansluiten van de radiator kan enkel volgens de getoonde aansluiticonen. Voor elke andere aansluitwijze nemen wij geen verantwoordelijkheid.

TULIPA-A VERTICAAL (TV1-A, TV2-A)

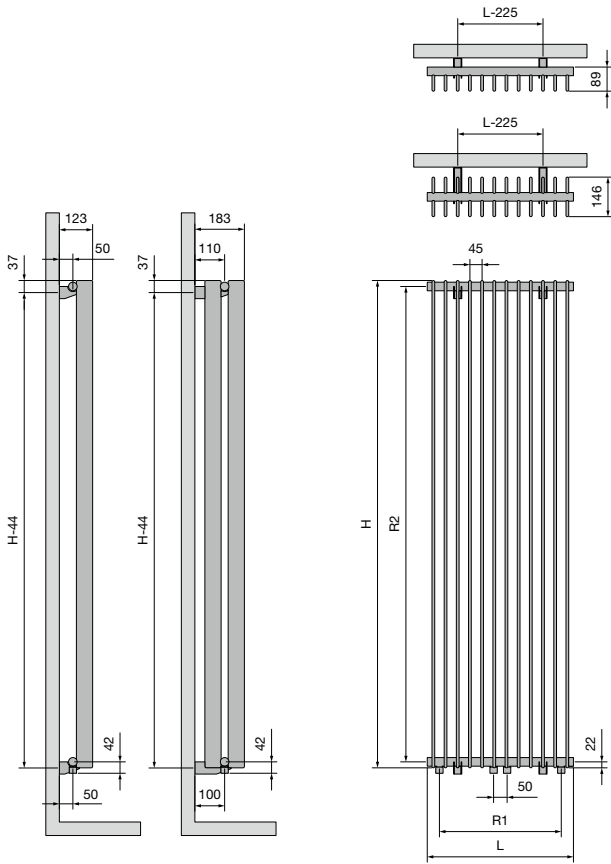

TV1-A / TV2-A

Breedte (L)	270	360	450	540	630	720	810	900	990	1080	1170	1260
Hartafstand tussen de onderaansluitingen 18 (R1)	180	270	360	450	540	630	720	810	900	990	1080	1170
Hoogte (H)	1000	1200	1500	1600	1800	2000	2200	2500	3000			
Hartafstand tussen de zijaansluitingen 32/SR (R2)	956	1156	1456	1556	1756	1956	2156	2456	2956			
Hartafstand tussen de ophangingen	H-44											

TULIPA-A HORIZONTAAL (TH1-A, TH2-A)

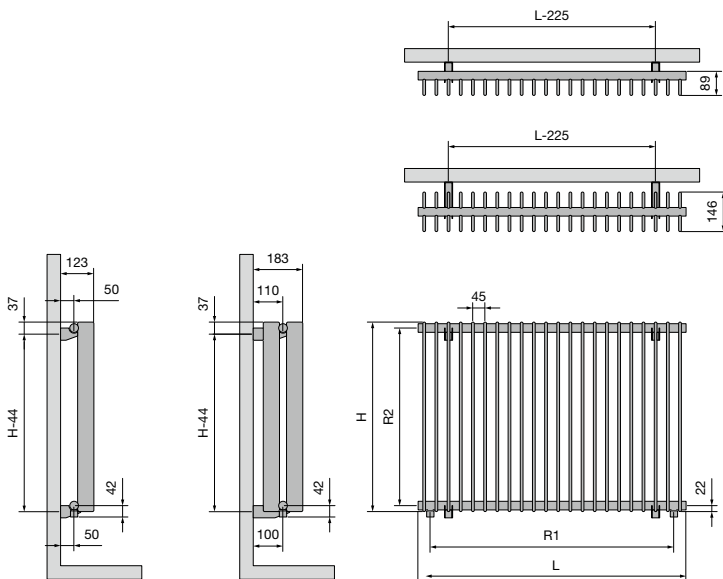

TH1-A / TH2-A

Breedte (L)	540	630	720	810	900	990	1080	1170	1260	1440	1620	1800	1980	2160	2340	2520	2700	2880	3060
Hartafstand tussen de onderaansluitingen 18 (R1)	450	540	630	720	810	900	990	1080	1170	1350	1530	1710	1890	2070	2250	2430	2610	2790	2970
Hoogte (H)	400	500	600	700	800	900													
Hartafstand tussen de zijaansluitingen 32/SR (R2)	356	456	556	656	756	856													
Hartafstand tussen de ophangingen	H-44																		