



Kolomradiatoren

Een klassieker met kracht.

De VASCO kolomradiator combineert een hoog vermogen met een snelle en efficiënte warmteafgifte.

Hij levert uitstekende prestaties, ook in combinatie met lage watertemperatuursystemen zoals warmtepompen — een retro ontwerp in de meest duurzame zin van het woord.

Tot in het kleinste detail afgestemd op zuinig energieverbruik, met slimme aansluitingen, doordachte bevestigingssystemen en innovatieve technologische oplossingen.

Een tijdloze klassieker die kracht, comfort en efficiëntie moeiteloos verenigt.

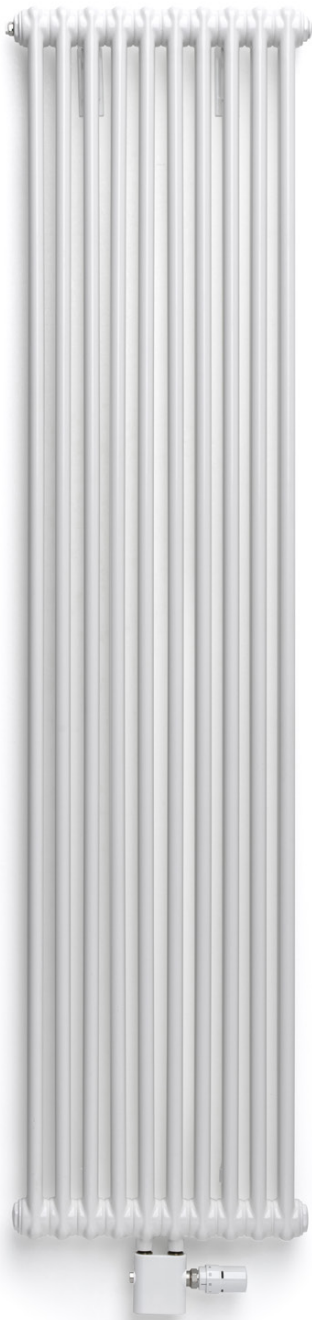

RITMO VERTICAAL

Hoge warmteafgifte

Met hun hoge warmteafgifte brengen VASCO's Ritmo-kolomradiatoren zelfs de grootste ruimtes in een mum van tijd op de gewenste temperatuur, zonder dat je dat merkt aan je energiefactuur. Door hun groot verwarmingsoppervlak zijn ze uitermate geschikt voor lage temperatuurverwarming. Zo geniet je van aangename temperaturen en een comfortabel binnenklimaat.

TYPES

- 2 / 3 / 4 kolommen
- Bouwdiepte: 65 / 105 / 145 mm
- Bouwhoogte: 1500, 1800, 2000, 2200 mm
- Bouwlengte: 270, 360, 450, 540, 630, 720 mm

BUIZEN

- Verticaal, 25 mm

KLEUREN

- Standaardkleur wit RAL 9016
- Uitgebreide kleurenkaart zie p. 12

BEVESTIGINGEN

- Wandmontage
- Muurbevestigingen standaard
- Bij witte radiatoren wordt standaard een witte klemconsole 30 mm en een witte afstandshouder geleverd
- Bij gekleurde radiatoren wordt standaard een klemconsole 30 mm in de kleur van de radiator en een afstandshouder in RAL 7024 geleverd

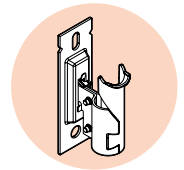

TECHNISCH

- Bestaande uit kopstukken (bandstaal persdelen) en ronde buizen.
- ATL-grondlaag, poedercoating
- Standaardwerkdruk: 10 bar
- Maximale bedrijfstemperatuur: 110°C

TECHNISCHE TEKENINGEN

- Zie p. 340

AANSLUITING

- ✗ Eénpuntsaansluiting voor éénpijpssysteem
- ✗ Eénpuntsaansluiting voor tweepijpssysteem
- ✓ Tweepuntsaansluiting voor éénpijpssysteem (aansluiting via de middenaansluiting) (zie p. 362)
- ✓ Tweepuntsaansluiting voor tweepijpssysteem (standaard) (zie p. 362)
- ✗ Geïntegreerd ventiel
- Aansluitingen: 1/2" (binnendraad)

AANBEVOLEN AANSLUITING (MM)

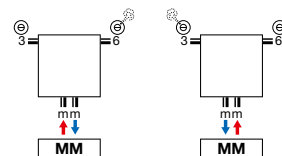

Andere aansluitmogelijkheden, zie p. 339

AANBEVOLEN VOOR BADKAMER EN KEUKEN IN OPTIE



handdoekbeugel (chrom) art. nr. zie p. 338
prijs € 150

NEW



Ventielset haaks kleur
art. nr. 1182 105 0000 9016
prijs €201
Andere kleuren, zie p. 366
Koppelingen, zie p. 380



Thermostaatkop
Traffic White
art. nr.
1182 030 0000 9016
prijs €40



HOE RITMO VERTICAAL BESTELLEN

Leveringstermijn 15 - 30 werkdagen
(zonder transportduur)

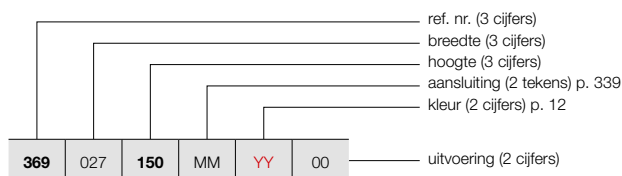

RITMO VERTICAAL (2-KOLOM)

325



RITMO VB-2K/65
(2-KOLOM)

PRIJSGROEP: VPG5 - KOLOMRADIATOREN

BESTELCODE MAATWERK RITMO VERTICAAL	TECHNISCHE GEGEVENS								STANDAARDKLEUR		ANDERE KLEUREN					
	buizen	breedte (L mm)	hoogte (H mm)	75/65/20 (Watt) (φ50K)	55/45/20 (Watt) (φ30K)	n-exp.	gewicht (kg)	inhoud (l)	el. weerst. (Watt)	prijs RAL 9016 (€)	prijs kleur (€)					
REF. NR. RITMO VERTICAAL VB-2K/65 : 369																
369	027	150	MM	YY	00	6	270	1500	654	333	1,32	11,58	7,92	-	427	491
		180				6	270	1800	780	397	1,32	13,74	9,36	-	482	554
		200				6	270	2000	864	440	1,32	15,18	10,32	-	540	621
		220				6	270	2200	948	483	1,32	16,68	11,28	-	718	826
369	036	150	MM	YY	00	8	360	1500	872	444	1,32	15,44	10,56	-	505	581
		180				8	360	1800	1040	530	1,32	18,32	12,48	-	570	656
		200				8	360	2000	1152	587	1,32	20,24	13,76	-	635	730
		220				8	360	2200	1264	644	1,32	22,24	15,04	-	806	927
369	045	150	MM	YY	00	10	450	1500	1090	555	1,32	19,30	13,20	-	581	668
		180				10	450	1800	1300	662	1,32	22,90	15,60	-	664	764
		200				10	450	2000	1440	734	1,32	25,30	17,20	-	713	820
		220				10	450	2200	1580	805	1,32	27,80	18,80	-	896	1030
369	054	150	MM	YY	00	12	540	1500	1308	666	1,32	23,16	15,84	-	679	781
		180				12	540	1800	1560	795	1,32	27,48	18,72	-	767	882
		200				12	540	2000	1728	880	1,32	30,36	20,64	-	844	971
		220				12	540	2200	1896	966	1,32	33,36	22,56	-	981	1128
369	063	150	MM	YY	00	14	630	1500	1526	778	1,32	27,02	18,48	-	779	896
		180				14	630	1800	1820	927	1,32	32,06	21,84	-	872	1003
		200				14	630	2000	2016	1027	1,32	35,42	24,08	-	976	1122
		220				14	630	2200	2212	1127	1,32	38,92	26,32	-	1070	1231
369	072	150	MM	YY	00	16	720	1500	1744	889	1,32	30,88	21,12	-	877	1009
		180				16	720	1800	2080	1060	1,32	36,64	24,96	-	981	1128
		200				16	720	2000	2304	1174	1,32	40,48	27,52	-	1086	1249
		220				16	720	2200	2528	1288	1,32	44,48	30,08	-	1156	1329

Conform EN442-1: 2014: radiatoren en convectoren

Voor meer details over onze artikel-data, zie artikel-database: <https://www.2ba.nl>

Voor de warmteafgifte van andere regimes, kijkt u op p. 370 (correctiefactoren)
NEDERLAND. Prijzen in euro (excl. BTW)

RITMO VERTICAAL (3-KOLOM)

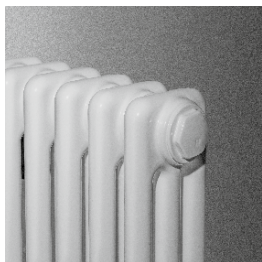

RITMO VB-3K/105
(3-KOLOM)

HOE RITMO VERTICAAL BESTELLEN

Leveringstermijn 15 - 30 werkdagen
(zonder transportduur)

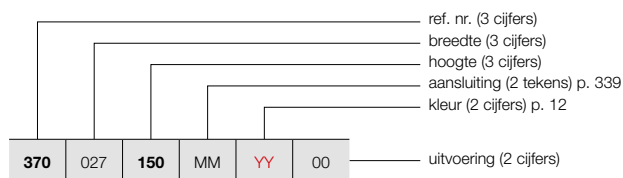

PRIJSGROEP: VPG5 - KOLOMRADIATOREN

BESTELCODE MAATWERK RITMO VERTICAAL	TECHNISCHE GEGEVENS									STANDAARDKLEUR	ANDERE KLEUREN
	buizen	breedte (L mm)	hoogte (H mm)	75/65/20 (Watt) (Φ50K)	55/45/20 (Watt) (Φ30K)	n-exp.	gewicht (kg)	inhoud (l)	el. weerst. (Watt)	prijs RAL 9016 (€)	prijs kleur (€)
REF. NR. RITMO VERTICAAL VB-3K/105 : 370											
370	027	150	MM	YY	00						
		180								559	643
		200								646	743
		220								659	758
										786	904
370	036	150	MM	YY	00						
		180								657	756
		200								766	881
		220								803	923
										927	1066
370	045	150	MM	YY	00						
		180								751	864
		200								877	1009
		220								926	1065
										1077	1239
370	054	150	MM	YY	00						
		180								877	1009
		200								1042	1198
		220								1090	1254
										1260	1449
370	063	150	MM	YY	00						
		180								1008	1159
		200								1170	1346
		220								1235	1420
										1410	1622
370	072	150	MM	YY	00						
		180								1123	1291
		200								1328	1527
		220								1362	1566
										1574	1810

Conform EN442-1: 2014: radiatoren en convectoren

Voor meer details over onze artikel-data, zie artikel-database: <https://www.2ba.nl>

Voor de warmteafgiftes van andere regimes, kijkt u op p. 370 (correctiefactoren)
NEDERLAND. Prijzen in euro (excl. BTW)

HOE RITMO VERTICAAL BESTELLEN

Leveringstermijn 15 - 30 werkdagen
(zonder transportduur)

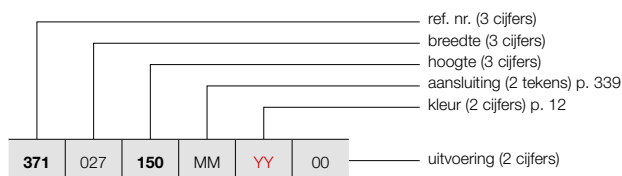

RITMO VERTICAAL (4-KOLOM)

327



RITMO VB-4K/145
(4-KOLOM)

PRIJSGROEP: VPG5 - KOLOMRADIATOREN

BESTELCODE MAATWERK RITMO VERTICAAL	TECHNISCHE GEGEVENS								STANDAARDKLEUR		ANDERE KLEUREN	
	buizen	breedte (L mm)	hoogte (H mm)	75/65/20 (Watt) (Φ50K)	55/45/20 (Watt) (Φ30K)	n-exp.	gewicht (kg)	inhoud (l)	el. weerst. (Watt)	prijs RAL 9016 (€)	prijs kleur (€)	
REF. NR. RITMO VERTICAAL VB-4K/145 : 371												
371 027 150 MM YY 00	6	270	1500	1116	560	1,35	23,10	15,60	-	681	783	
	6	270	1800	1314	663	1,34	27,48	18,48	-	818	941	
	6	270	2000	1446	729	1,34	30,36	20,40	-	868	998	
	6	270	2200	1572	793	1,34	33,30	22,32	-	1050	1208	
371 036 150 MM YY 00	8	360	1500	1488	747	1,35	30,80	20,80	-	804	925	
	8	360	1800	1752	884	1,34	36,64	24,64	-	974	1120	
	8	360	2000	1928	972	1,34	40,48	27,20	-	1044	1201	
	8	360	2200	2096	1057	1,34	44,40	29,76	-	1212	1394	
371 045 150 MM YY 00	10	450	1500	1860	933	1,35	38,50	26,00	-	932	1072	
	10	450	1800	2190	1105	1,34	45,80	30,80	-	1093	1257	
	10	450	2000	2410	1215	1,34	50,60	34,00	-	1216	1398	
	10	450	2200	2620	1321	1,34	55,50	37,20	-	1370	1576	
371 054 150 MM YY 00	12	540	1500	2232	1120	1,35	46,20	31,20	-	1084	1247	
	12	540	1800	2628	1325	1,34	54,96	36,96	-	1243	1429	
	12	540	2000	2892	1459	1,34	60,72	40,80	-	1496	1720	
	12	540	2200	3144	1586	1,34	66,60	44,64	-	1589	1827	
371 063 150 MM YY 00	14	630	1500	2604	1307	1,35	53,90	36,40	-	1248	1435	
	14	630	1800	3066	1546	1,34	64,12	43,12	-	1464	1684	
	14	630	2000	3374	1702	1,34	70,84	47,60	-	1688	1941	
	14	630	2200	3668	1850	1,34	77,70	52,08	-	1863	2142	
371 072 150 MM YY 00	16	720	1500	2976	1493	1,35	61,60	41,60	-	1384	1592	
	16	720	1800	3504	1767	1,34	73,28	49,28	-	1723	1981	
	16	720	2000	3856	1945	1,34	80,96	54,40	-	1925	2214	
	16	720	2200	4192	2114	1,34	88,80	59,52	-	2095	2409	

Conform EN442-1: 2014: radiatoren en convectoren

Voor meer details over onze artikel-data, zie artikel-database: <https://www.2ba.nl>

Voor de warmteafgiftes van andere regimes, kijkt u op p. 370 (correctiefactoren)
 NEDERLAND. Prijzen in euro (excl. BTW)

RITMO HORIZONTAAL (HB-2K/65, HB-3K/105, HB-4K/145)

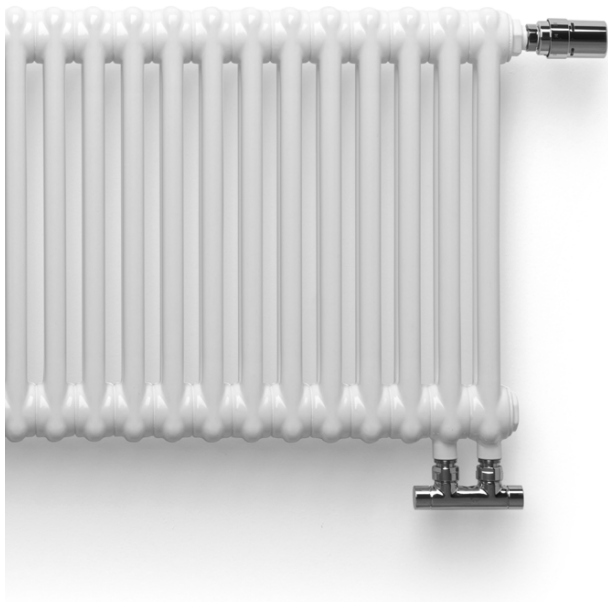

TYPES

- 2 / 3 / 4 kolommen
- Bouwdiepte: 65 / 105 / 145 mm
- Bouwhoogte: 300, 400, 500, 600, 900 mm
- Bouwlengte: 450, 540, 630, 720, 810, 900, 990, 1080, 1170, 1260, 1350, 1440, 1530, 1620, 1710, 1800 mm

BUIZEN

- Verticaal, 25 mm

KLEUREN

- Standaardkleur wit RAL 9016
- Uitgebreide kleurenkaart zie p. 12

BEVESTIGINGEN

- Vloer- of wandmontage
- Muurbevestigingen standaard
- Bij witte radiatoren wordt standaard een witte klemconsole 30 mm en een witte afstandshouder geleverd
- Bij gekleurde radiatoren wordt standaard een klemconsole 30 mm in de kleur van de radiator en een afstandshouder in RAL 7024 geleverd

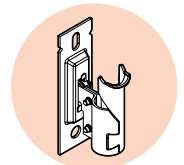

TECHNISCH

- Bestaande uit kopstukken (bandstaal persdelen) en ronde buizen.
- ATL-grondlaag, poedercoating
- Standaardwerkdruk: 10 bar
- Maximale bedrijfstemperatuur: 110°C

TECHNISCHE TEKENINGEN

- Zie p. 340

AANSLUITING

- ✗ Eénpuntsaansluiting voor éénpijpssysteem
- ✗ Eénpuntsaansluiting voor tweepijpssysteem
- ✓ Tweepuntsaansluiting voor éénpijpssysteem (aansluiting via het geïntegreerd ventiel) (zie p. 363)
- ✓ Tweepuntsaansluiting voor tweepijpssysteem (standaard) (zie p. 362)
- ✓ Geïntegreerd ventiel (aansluiting VR) (**meerprijs: €85**) (thermostaatkop apart te bestellen, zie p. 338)
- Aansluitingen: 1/2" (binnendraad)

RITMO HORIZONTAAL

Van klassiek tot modern

Het authentieke karakter van de Ritmo-kolomradiator is voor heel wat design-liefhebbers een schot in de roos. Omdat ze in hoge hoogtematen beschikbaar zijn, komen deze designradiatoren optimaal tot hun recht in grote, hoge en open interieurs, van klassieke herenhuisen tot moderne industriële lofts. Deze radiatoren worden ook vaak toegepast in openbare ruimtes, aangezien ze met hun relatief brede openingen makkelijk te reinigen en dus erg onderhoudsvriendelijk zijn. Met hun karakteristieke retro-uitstraling zijn deze kolomradiatoren in vele uitvoeringen beschikbaar: in horizontale of verticale variant en in 2, 3 of 4 kolommen.

AANBEVOLEN AANSLUITING GEÏNTEGREERD VENTIEL

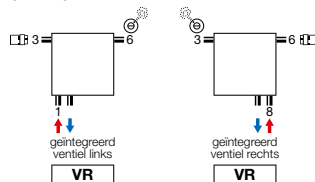

Andere aansluitmogelijkheden, zie p. 339

AANBEVOLEN VOOR BADKAMER EN KEUKEN IN OPTIE



handdoekbeugel (chrom) art. nr. zie p. 338
prijs € 150



art. nr. 118230100000099
prijs € 173



wit art. nr. 11911630102
prijs € 54



chrom art. nr. 11911631102
prijs € 69



HOE RITMO HORIZONTAAL BESTELLEN

Leveringstermijn 15 - 30 werkdagen
(zonder transportduur)

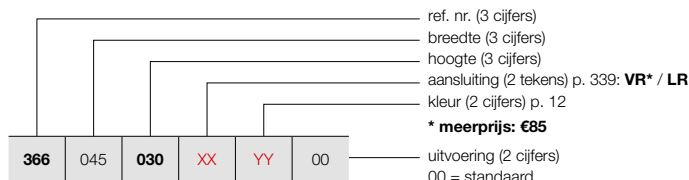

RITMO HORIZONTAAL (2-KOLOM)

329

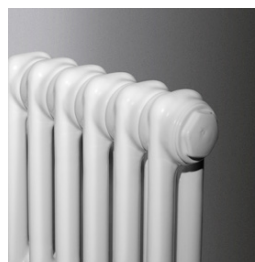

RITMO HB-2K/65
(2-KOLOM) 4-AANSLUITINGEN

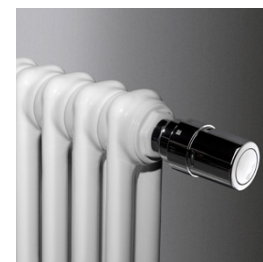

RITMO HB-2K/65
(2-KOLOM) GEÏNTEGREERD VENTIEL
(thermostaatkop apart te bestellen)

PRIJSGROEP: VPG5 - KOLOMRADIATOREN

BESTELCODE MAATWERK RITMO HORIZONTAAL	TECHNISCHE GEGEVENS							STANDAARDKLEUR		ANDERE KLEUREN	
	buizen	breedte (L mm)	hoogte (H mm)	75/65/20 (Watt) (φ50K)	55/45/20 (Watt) (φ30K)	n-exp.	gewicht (kg)	inhoud (l)	el. weerst. (Watt)	prijs RAL 9016 (€)	prijs kleur (€)
REF. NR. RITMO HORIZONTAAL HB-2K/65 : 366											
366 045 030 XX YY 00	10	450	300	240	126	1,26	4,70	3,70	-	296	425
	10	450	400	310	159	1,31	5,90	4,50	-	307	438
	10	450	500	390	200	1,31	7,10	5,30	-	318	451
	10	450	600	460	123	1,31	8,30	6,10	-	329	378
	10	450	900	670	343	1,31	12,00	8,40	-	365	420
	10	450	900	670	343	1,31	12,00	8,40	-	365	420
366 054 030 XX YY 00	12	540	300	288	151	1,26	5,64	4,44	-	351	489
	12	540	400	372	191	1,31	7,08	5,40	-	362	416
	12	540	500	468	240	1,31	8,52	6,36	-	373	514
	12	540	600	552	147	1,31	9,96	7,32	-	384	527
	12	540	900	804	412	1,31	14,40	10,08	-	420	568
	12	540	900	804	412	1,31	14,40	10,08	-	420	568
366 063 030 XX YY 00	14	630	300	336	177	1,26	6,58	5,18	-	417	480
	14	630	400	434	222	1,31	8,26	6,30	-	427	491
	14	630	500	546	280	1,31	9,94	7,42	-	439	590
	14	630	600	644	172	1,31	11,62	8,54	-	449	601
	14	630	900	938	480	1,31	16,80	11,76	-	486	644
	14	630	900	938	480	1,31	16,80	11,76	-	486	644
366 072 030 XX YY 00	16	720	300	384	202	1,26	7,52	5,92	-	483	555
	16	720	400	496	254	1,31	9,44	7,20	-	493	567
	16	720	500	624	320	1,31	11,36	8,48	-	505	581
	16	720	600	736	197	1,31	13,28	9,76	-	515	592
	16	720	900	1072	549	1,31	19,20	13,44	-	552	635
	16	720	900	1072	549	1,31	19,20	13,44	-	552	635
366 081 030 XX YY 00	18	810	300	432	227	1,26	8,46	6,66	-	549	631
	18	810	400	558	286	1,31	10,62	8,10	-	559	728
	18	810	500	702	360	1,31	12,78	9,54	-	570	656
	18	810	600	828	221	1,31	14,94	10,98	-	581	668
	18	810	900	1206	618	1,31	21,60	15,12	-	618	796
	18	810	900	1206	618	1,31	21,60	15,12	-	618	796
366 090 030 XX YY 00	20	900	300	480	252	1,26	9,40	7,40	-	591	680
	20	900	400	620	318	1,31	11,80	9,00	-	603	778
	20	900	500	780	399	1,31	14,20	10,60	-	613	790
	20	900	600	920	246	1,31	16,60	12,20	-	625	719
	20	900	900	1340	686	1,31	24,00	16,80	-	661	760
	20	900	900	1340	686	1,31	24,00	16,80	-	661	760
366 099 030 XX YY 00	22	990	300	528	277	1,26	10,34	8,14	-	625	719
	22	990	400	682	349	1,31	12,98	9,90	-	635	815
	22	990	500	858	439	1,31	15,62	11,66	-	647	829
	22	990	600	1012	270	1,31	18,26	13,42	-	657	841
	22	990	900	1474	755	1,31	26,40	18,48	-	694	798
	22	990	900	1474	755	1,31	26,40	18,48	-	694	798
366 108 030 XX YY 00	24	1080	300	576	303	1,26	11,28	8,88	-	657	756
	24	1080	400	744	381	1,31	14,16	10,80	-	669	769
	24	1080	500	936	479	1,31	17,04	12,72	-	679	781
	24	1080	600	1104	295	1,31	19,92	14,64	-	691	795
	24	1080	900	1608	824	1,31	28,80	20,16	-	726	920
	24	1080	900	1608	824	1,31	28,80	20,16	-	726	920

Conform EN442-1: 2014: radiatoren en convectoren

Voor meer details over onze artikel-data, zie artikel-database: <https://www.2ba.nl>

Voor de warmteafgiftes van andere regimes, kijkt u op p. 370 (correctiefactoren)
NEDERLAND. Prijzen in euro (excl. BTW)

RITMO HORIZONTAAL (2-KOLOM)

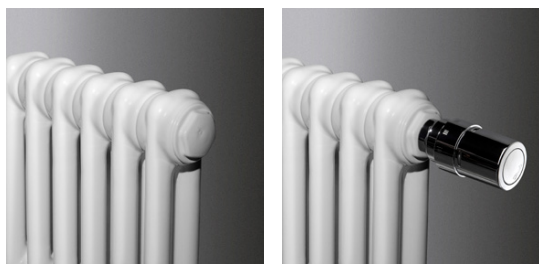

RITMO HB-2K/65
(2-KOLOM) 4-AANSLUITINGEN

RITMO HB-2K/65
(2-KOLOM) GEÏNTEGREERD VENTIEL
(thermostaatkop apart te bestellen)

HOE RITMO HORIZONTAAL BESTELLEN

Leveringstermijn 15 - 30 werkdagen
(zonder transportduur)

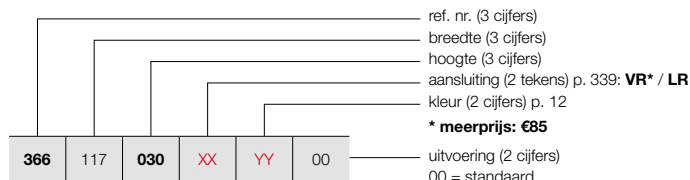

PRIJSGROEP: VPG5 - KOLOMRADIATOREN

BESTELCODE MAATWERK RITMO HORIZONTAAL	TECHNISCHE GEGEVENS									STANDAARDKLEUR	ANDERE KLEUREN
	buizen	breedte (L mm)	hoogte (H mm)	75/65/20 (Watt) (Φ50K)	55/45/20 (Watt) (Φ30K)	n-exp.	gewicht (kg)	inhoud (l)	el. weerst. (Watt)	prijs RAL 9016 (€)	prijs kleur (€)
REF. NR. RITMO HORIZONTAAL HB-2K/65 : 366											
366	117	030	XX	YY	00						
		040								718	826
		050								729	838
		060								740	936
		090								751	864
										787	990
366	126	030	XX	YY	00						
		040								779	896
		050								789	992
		060								800	920
		090								811	933
										847	1055
366	135	030	XX	YY	00						
		040								844	1055
		050								855	983
		060								866	1081
		090								877	1094
										913	1135
366	144	030	XX	YY	00						
		040								910	1047
		050								921	1059
		060								932	1072
		090								943	1084
										979	1126
366	153	030	XX	YY	00						
		040								976	1122
		050								986	1134
		060								998	1233
		090								1008	1159
										1045	1287
366	162	030	XX	YY	00						
		040								1042	1198
		050								1052	1210
		060								1064	1224
		090								1074	1320
										1111	1278
366	171	030	XX	YY	00						
		040								1107	1273
		050								1118	1286
		060								1129	1298
		090								1140	1396
										1177	1354
366	180	030	XX	YY	00						
		040								1172	1348
		050								1184	1362
		060								1194	1458
		090								1206	1387
										1243	1429

Conform EN442-1: 2014: radiatoren en convectoren

Voor meer details over onze artikel-data, zie artikel-database: <https://www.2ba.nl>

Voor de warmteafgiftes van andere regimes, kijkt u op p. 370 (correctiefactoren)
NEDERLAND. Prijzen in euro (excl. BTW)

HOE RITMO HORIZONTAAL BESTELLEN

Leveringstermijn 15 - 30 werkdagen
(zonder transportduur)

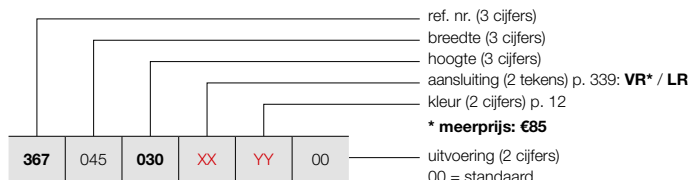

RITMO HORIZONTAAL (3-KOLOM)

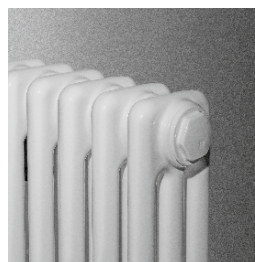

RITMO HB-3K/105
(3-KOLOM) 4-AANSLUITINGEN



RITMO HB-3K/105
(3-KOLOM) GEÏNTEGREERD VENTIEL
(thermostaatkop apart te bestellen)

PRIJSGROEP: VPG5 - KOLOMRADIATOREN

BESTELCODE MAATWERK RITMO HORIZONTAAL	TECHNISCHE GEGEVENS							STANDAARDKLEUR		ANDERE KLEUREN	
	buizen	breedte (L mm)	hoogte (H mm)	75/65/20 (Watt) (φ50K)	55/45/20 (Watt) (φ30K)	n-exp.	gewicht (kg)	inhoud (l)	el. weerst. (Watt)	prijs RAL 9016 (€)	prijs kleur (€)
REF. NR. RITMO HORIZONTAAL HB-3K/105 : 367											
367 045 030 XX YY 00	10	450	300	330	167	1,33	7,00	5,30	-	346	398
	10	450	400	430	215	1,36	8,80	6,50	-	357	411
	10	450	500	530	265	1,36	10,60	7,70	-	368	508
	10	450	600	630	315	1,36	12,50	8,90	-	379	436
	10	450	900	920	459	1,36	17,90	12,50	-	433	498
367 054 030 XX YY 00	12	540	300	396	201	1,33	8,40	6,36	-	403	463
	12	540	400	516	258	1,36	10,56	7,80	-	415	477
	12	540	500	636	258	1,36	12,72	9,24	-	425	489
	12	540	600	756	377	1,36	15,00	10,68	-	437	588
	12	540	900	1104	551	1,36	21,48	15,00	-	488	646
367 063 030 XX YY 00	14	630	300	462	234	1,33	9,80	7,42	-	461	615
	14	630	400	602	301	1,36	12,32	9,10	-	471	542
	14	630	500	742	301	1,36	14,84	10,78	-	483	555
	14	630	600	882	440	1,36	17,50	12,46	-	493	567
	14	630	900	1288	643	1,36	25,06	17,50	-	549	631
367 072 030 XX YY 00	16	720	300	528	268	1,33	11,20	8,48	-	524	688
	16	720	400	688	343	1,36	14,08	10,40	-	535	700
	16	720	500	848	343	1,36	16,96	12,32	-	545	712
	16	720	600	1008	503	1,36	20,00	14,24	-	557	726
	16	720	900	1472	735	1,36	28,64	20,00	-	623	801
367 081 030 XX YY 00	18	810	300	594	301	1,33	12,60	9,54	-	586	759
	18	810	400	774	386	1,36	15,84	11,70	-	598	773
	18	810	500	954	386	1,36	19,08	13,86	-	608	784
	18	810	600	1134	566	1,36	22,50	16,02	-	620	713
	18	810	900	1656	827	1,36	32,22	22,50	-	689	792
367 090 030 XX YY 00	20	900	300	660	335	1,33	14,00	10,60	-	647	829
	20	900	400	860	429	1,36	17,60	13,00	-	657	841
	20	900	500	1060	429	1,36	21,20	15,40	-	669	769
	20	900	600	1260	629	1,36	25,00	17,80	-	679	781
	20	900	900	1840	919	1,36	35,80	25,00	-	757	956
367 099 030 XX YY 00	22	990	300	726	368	1,33	15,40	11,66	-	686	789
	22	990	400	946	472	1,36	19,36	14,30	-	696	885
	22	990	500	1166	472	1,36	23,32	16,94	-	707	813
	22	990	600	1386	692	1,36	27,50	19,58	-	718	911
	22	990	900	2024	1010	1,36	39,38	27,50	-	789	907
367 108 030 XX YY 00	24	1080	300	792	401	1,33	16,80	12,72	-	723	916
	24	1080	400	1032	515	1,36	21,12	15,60	-	735	845
	24	1080	500	1272	515	1,36	25,44	18,48	-	745	857
	24	1080	600	1512	755	1,36	30,00	21,36	-	757	871
	24	1080	900	2208	1102	1,36	42,96	30,00	-	847	974

Conform EN442-1: 2014: radiatoren en convectoren

Voor meer details over onze artikel-data, zie artikel-database: <https://www.2ba.nl>

Voor de warmteafgiftes van andere regimes, kijkt u op p. 370 (correctiefactoren)
NEDERLAND. Prijzen in euro (excl. BTW)

RITMO HORIZONTAAL (3-KOLOM)

HOE RITMO HORIZONTAAL BESTELLEN

Leveringstermijn 15 - 30 werkdagen
(zonder transportduur)

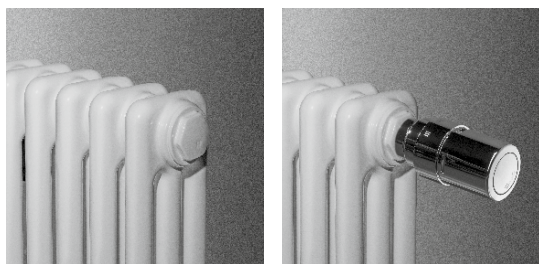

RITMO HB-3K/105
(3-KOLOM) 4-AANSLUITINGEN

RITMO HB-3K/105
(3-KOLOM) GEÏNTEGREERD VENTIEL
(thermostaatkop apart te bestellen)

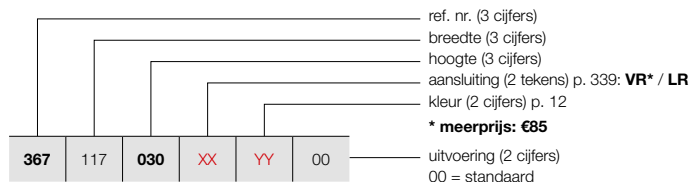

PRIJSGROEP: VPG5 - KOLOMRADIATOREN

BESTELCODE MAATWERK RITMO HORIZONTAAL	TECHNISCHE GEGEVENS									STANDAARDKLEUR	ANDERE KLEUREN
	buizen	breedte (L mm)	hoogte (H mm)	75/65/20 (Watt) (Ø50K)	55/45/20 (Watt) (Ø30K)	n-exp.	gewicht (kg)	inhoud (l)	el. weerst. (Watt)	prijs RAL 9016 (€)	prijs kleur (€)
REF. NR. RITMO HORIZONTAAL HB-3K/105 : 367											
367	117	030	XX	YY	00						
		040								787	905
		050								798	918
		060								809	1015
		090								820	943
										959	1188
367	126	030	XX	YY	00						
		040								844	971
		050								855	1068
		060								866	1081
		090								877	1094
										1030	1185
367	135	030	XX	YY	00						
		040								903	1123
		050								914	1136
		060								925	1149
		090								936	1161
										1096	1260
367	144	030	XX	YY	00						
		040								961	1105
		050								972	1118
		060								983	1130
		090								994	1143
										1162	1421
367	153	030	XX	YY	00						
		040								1020	1173
		050								1030	1185
		060								1042	1283
		090								1052	1210
										1238	1509
367	162	030	XX	YY	00						
		040								1075	1236
		050								1087	1335
		060								1097	1347
		090								1109	1275
										1316	1513
367	171	030	XX	YY	00						
		040								1140	1311
		050								1151	1324
		060								1162	1336
		090								1172	1433
										1381	1588
367	180	030	XX	YY	00						
		040								1211	1393
		050								1223	1406
		060								1233	1418
		090								1245	1432
										1463	1767

Conform EN442-1: 2014: radiatoren en convectoren

Voor meer details over onze artikel-data, zie artikel-database: <https://www.2ba.nl>

Voor de warmteafgifte van andere regimes, kijkt u op p. 370 (correctiefactoren)
NEDERLAND. Prijzen in euro (excl. BTW)

HOE RITMO HORIZONTAAL BESTELLEN

Leveringstermijn 15 - 30 werkdagen
(zonder transportduur)

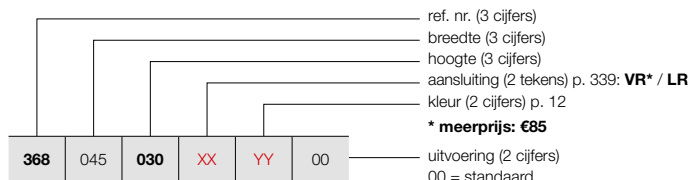

RITMO HORIZONTAAL (4-KOLOM)

333



RITMO HB-4K/145
(4-KOLOM) 4-AANSLUITINGEN



RITMO HB-4K/145
(4-KOLOM) GEÏNTEGREERD VENTIEL
(thermostaatkop apart te bestellen)

PRIJSGROEP: VPG5 - KOLOMRADIATOREN

BESTELCODE MAATWERK RITMO HORIZONTAAL	TECHNISCHE GEGEVENS							STANDAARDKLEUR		ANDERE KLEUREN	
	buizen	breedte (L mm)	hoogte (H mm)	75/65/20 (Watt) (φ50K)	55/45/20 (Watt) (φ30K)	n-exp.	gewicht (kg)	inhoud (l)	el. weerst. (Watt)	prijs RAL 9016 (€)	prijs kleur (€)
REF. NR. RITMO HORIZONTAAL HB-4K/145 : 368											
368 045 030 XX YY 00	040	450	300	430	218	1,33	9,30	6,90	-	409	470
	050	450	400	560	281	1,35	11,80	8,50	-	420	568
	060	450	500	690	346	1,35	14,20	10,10	-	431	496
	090	450	600	810	406	1,35	16,60	11,70	-	442	593
		450	900	1170	587	1,35	23,90	16,50	-	510	587
368 054 030 XX YY 00	040	540	300	516	262	1,33	11,16	8,28	-	466	536
	050	540	400	672	337	1,35	14,16	10,20	-	477	549
	060	540	500	828	415	1,35	17,04	12,12	-	488	646
	090	540	600	972	488	1,35	19,92	14,04	-	498	573
		540	900	1404	704	1,35	28,68	19,80	-	591	680
368 063 030 XX YY 00	040	630	300	602	305	1,33	13,02	9,66	-	527	606
	050	630	400	784	393	1,35	16,52	11,90	-	537	618
	060	630	500	966	485	1,35	19,88	14,14	-	549	631
	090	630	600	1134	569	1,35	23,24	16,38	-	559	728
		630	900	1638	822	1,35	33,46	23,10	-	707	813
368 072 030 XX YY 00	040	720	300	688	349	1,33	14,88	11,04	-	581	668
	050	720	400	896	450	1,35	18,88	13,60	-	591	680
	060	720	500	1104	554	1,35	22,72	16,16	-	603	693
	090	720	600	1296	650	1,35	26,56	18,72	-	613	705
		720	900	1872	939	1,35	38,24	26,40	-	806	1012
368 081 030 XX YY 00	040	810	300	774	392	1,33	16,74	12,42	-	657	756
	050	810	400	1008	506	1,35	21,24	15,30	-	669	769
	060	810	500	1242	623	1,35	25,56	18,18	-	679	866
	090	810	600	1458	732	1,35	29,88	21,06	-	691	795
		810	900	2106	1057	1,35	43,02	29,70	-	904	1040
368 090 030 XX YY 00	040	900	300	860	436	1,33	18,60	13,80	-	757	871
	050	900	400	1120	562	1,35	23,60	17,00	-	767	967
	060	900	500	1380	692	1,35	28,40	20,20	-	779	896
	090	900	600	1620	813	1,35	33,20	23,40	-	789	907
		900	900	2340	1174	1,35	47,80	33,00	-	1003	1153
368 099 030 XX YY 00	040	990	300	946	480	1,33	20,46	15,18	-	789	907
	050	990	400	1232	618	1,35	25,96	18,70	-	800	920
	060	990	500	1518	762	1,35	31,24	22,22	-	811	933
	090	990	600	1782	894	1,35	36,52	25,74	-	822	1030
		990	900	2574	1292	1,35	52,58	36,30	-	1058	1302
368 108 030 XX YY 00	040	1080	300	1032	523	1,33	22,32	16,56	-	822	1030
	050	1080	400	1344	674	1,35	28,32	20,40	-	833	1043
	060	1080	500	1656	831	1,35	34,08	24,24	-	844	971
	090	1080	600	1944	975	1,35	39,84	28,08	-	855	983
		1080	900	2808	1409	1,35	57,36	39,60	-	1107	1273

Conform EN442-1: 2014: radiatoren en convectoren

Voor meer details over onze artikel-data, zie artikel-database: <https://www.2ba.nl>

Voor de warmteafgiftes van andere regimes, kijkt u op p. 370 (correctiefactoren)
NEDERLAND. Prijzen in euro (excl. BTW)

RITMO HORIZONTAAL (4-KOLOM)

HOE RITMO HORIZONTAAL BESTELLEN

Leveringstermijn 15 - 30 werkdagen
(zonder transportduur)

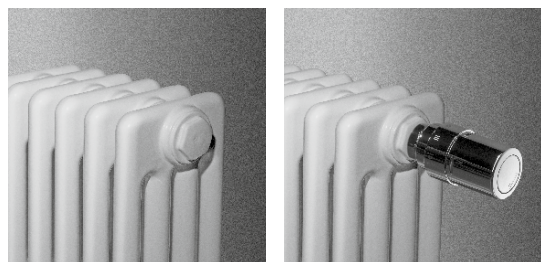

RITMO HB-4K/145
(4-KOLOM) 4-AANSLUITINGEN

RITMO HB-4K/145
(4-KOLOM) GEÏNTEGREERD VENTIEL
(thermostaatkop apart te bestellen)

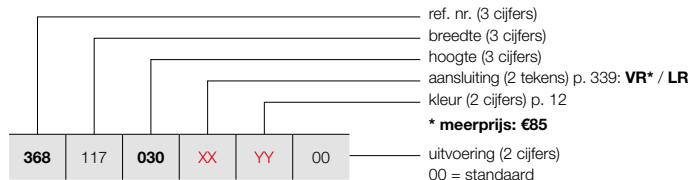

PRIJSGROEP: VPG5 - KOLOMRADIATOREN



BESTELCODE MAATWERK RITMO HORIZONTAAL	TECHNISCHE GEGEVENS									STANDAARDKLEUR	ANDERE KLEUREN					
	buizen	breedte (L mm)	hoogte (H mm)	75/65/20 (Watt) (Ø50K)	55/45/20 (Watt) (Ø30K)	n-exp.	gewicht (kg)	inhoud (l)	el. weerst. (Watt)	prijs RAL 9016 (€)	prijs kleur (€)					
REF. NR. RITMO HORIZONTAAL HB-4K/145 : 368																
368	117	030	XX	YY	00	26	1170	300	1118	567	1,33	24,18	17,94	-	965	1110
		040				26	1170	400	1456	731	1,35	30,68	22,10	-	976	1207
		050				26	1170	500	1794	900	1,35	36,92	26,26	-	986	1134
		060				26	1170	600	2106	1057	1,35	43,16	30,42	-	998	1148
		090				26	1170	900	3042	1526	1,35	62,14	42,90	-	1282	1474
368	126	030	XX	YY	00	28	1260	300	1204	610	1,33	26,04	19,32	-	1036	1191
		040				28	1260	400	1568	787	1,35	33,04	23,80	-	1047	1204
		050				28	1260	500	1932	969	1,35	39,76	28,28	-	1058	1302
		060				28	1260	600	2268	1138	1,35	46,48	32,76	-	1069	1229
		090				28	1260	900	3276	1644	1,35	66,92	46,20	-	1354	1642
368	135	030	XX	YY	00	30	1350	300	1290	654	1,33	27,90	20,70	-	1096	1260
		040				30	1350	400	1680	843	1,35	35,40	25,50	-	1107	1273
		050				30	1350	500	2070	1039	1,35	42,60	30,30	-	1118	1286
		060				30	1350	600	2430	1219	1,35	49,80	35,10	-	1129	1298
		090				30	1350	900	3510	1761	1,35	71,70	49,50	-	1414	1626
368	144	030	XX	YY	00	32	1440	300	1376	698	1,33	29,76	22,08	-	1172	1433
		040				32	1440	400	1792	899	1,35	37,76	27,20	-	1184	1447
		050				32	1440	500	2208	1108	1,35	45,44	32,32	-	1194	1458
		060				32	1440	600	2592	1301	1,35	53,12	37,44	-	1206	1387
		090				32	1440	900	3744	1879	1,35	76,48	52,80	-	1491	1800
368	153	030	XX	YY	00	34	1530	300	1462	741	1,33	31,62	23,46	-	1245	1517
		040				34	1530	400	1904	955	1,35	40,12	28,90	-	1255	1443
		050				34	1530	500	2346	1177	1,35	48,28	34,34	-	1267	1457
		060				34	1530	600	2754	1382	1,35	56,44	39,78	-	1277	1469
		090				34	1530	900	3978	1996	1,35	81,26	56,10	-	1568	1803
368	162	030	XX	YY	00	36	1620	300	1548	785	1,33	33,48	24,84	-	1324	1523
		040				36	1620	400	2016	1012	1,35	42,48	30,60	-	1336	1536
		050				36	1620	500	2484	1246	1,35	51,12	36,36	-	1346	1548
		060				36	1620	600	2916	1463	1,35	59,76	42,12	-	1357	1646
		090				36	1620	900	4212	2113	1,35	86,04	59,40	-	1650	1898
368	171	030	XX	YY	00	38	1710	300	1634	828	1,33	35,34	26,22	-	1387	1595
		040				38	1710	400	2128	1068	1,35	44,84	32,30	-	1397	1692
		050				38	1710	500	2622	1316	1,35	53,96	38,38	-	1409	1620
		060				38	1710	600	3078	1544	1,35	63,08	44,46	-	1419	1717
		090				38	1710	900	4446	2231	1,35	90,82	62,70	-	1704	1960
368	180	030	XX	YY	00	40	1800	300	1720	872	1,33	37,20	27,60	-	1435	1650
		040				40	1800	400	2240	1124	1,35	47,20	34,00	-	1446	1663
		050				40	1800	500	2760	1385	1,35	56,80	40,40	-	1457	1676
		060				40	1800	600	3240	1626	1,35	66,40	46,80	-	1468	1688
		090				40	1800	900	4680	2348	1,35	95,60	66,00	-	1764	2029

Conform EN442-1: 2014: radiatoren en convectoren

Voor meer details over onze artikel-data, zie artikel-database: <https://www.2ba.nl>

Voor de warmteafgiftes van andere regimes, kijkt u op p. 370 (correctiefactoren)
NEDERLAND. Prijzen in euro (excl. BTW)

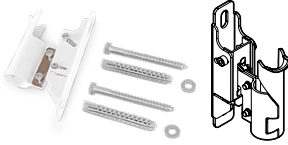
PRIJSGROEP: VPG10 - ACC.

BEVESTIGINGEN		KLEUR	ART. NR.	€
KLEMCONSOLE VARIABEL				
KLEMCONSOLE VARIABEL 	RITMO VERTICAAL / RITMO HORIZONTAAL			
	35 - 45 mm	RAL 9016	11872120000	35
		KLEUR	11872120000C	40
	45 - 60 mm	RAL 9016	11872130000	40
		KLEUR	11872130000C	47
<ul style="list-style-type: none"> • Wandafstand: 35 - 45 mm of 45 - 60 mm 				
AFSTANDHOUDER				
	RITMO VERTICAAL / RITMO HORIZONTAAL			
		RAL 9016	1187 209 0000 9016	13
	RAL 7024	1187 209 0000 7024	14	

hoogte (H mm)	2-kolom / 3-kolom / 4-kolom		
	300 - 900	1500 - 2200	
aantal buizen (n)	10 - 28	30 - 40	6 - 16
klemconsole variabel 35 - 45 mm	2x	3x	2x
klemconsole variabel 45 - 60 mm	2x	3x	2x
afstandhouder	2x	3x	2x

HOE BESTELLEN



1. Kies de gewenste klemconsole in bovenstaande tabel.
2. Afstandhouders dienen apart mee besteld te worden.

NEDERLAND. Prijzen in euro (excl. BTW)

RITMO VRIJSTAANDE OPSTELLING

IN OPTIE

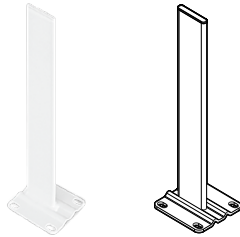
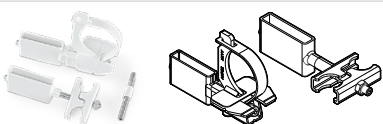

PRIJSGROEP: VPG10 - ACC.

VRIJSTAANDE OPSTELLING	HOOGTE VOET	KLEUR	ART. NR.	€
STANDVOET VRIJSTAANDE OPSTELLING 	RITMO HORIZONTAAL			
	H = 450 mm	RAL 9016	11810350450	65
		KLEUR	11810350450C	75
	H = 550 mm	RAL 9016	11810350550	65
		KLEUR	11810350550C	75
	H = 600 mm	RAL 9016	11810350600	65
		KLEUR	11810350600C	75
	H = 650 mm	RAL 9016	11810350650	65
		KLEUR	11810350650C	75
	H = 750 mm	RAL 9016	11810350750	65
		KLEUR	11810350750C	75
	H = 850 mm	RAL 9016	11810350850	81
		KLEUR	11810350850C	92
H = 900 mm	RAL 9016	11810350900	81	
	KLEUR	11810350900C	92	
H = 1050 mm	RAL 9016	11810351050	81	
	KLEUR	11810351050C	92	
H = 1200 mm	RAL 9016	11810351200	81	
	KLEUR	11810351200C	92	
<ul style="list-style-type: none"> Afgewerkte vloer: hoogte voet = hoogte radiator + 150 mm Chape: hoogte voet = hoogte radiator + 300 mm Zelf in te korten indien nodig 				
BEVESTIGING STANDVOET VRIJSTAANDE OPSTELLING 	RITMO HORIZONTAAL			
		RAL 9016	11810290000	85
		KLEUR	11810290000C	97
AFDEKROZET STANDVOET CHAPE 	RITMO HORIZONTAAL			
		RAL 9016	11810370000	14
		KLEUR	11810370000C	16
<ul style="list-style-type: none"> 100 x 40 mm. Aantal rozetten = aantal standvoeten 				
AFDEKROZET STANDVOET AFGEWERKTE VLOER 	RITMO HORIZONTAAL			
		RAL 9016	11810380000	17
		KLEUR	11810380000C	19
<ul style="list-style-type: none"> 115 x 110 mm. Aantal rozetten = aantal standvoeten 				

hoogte (H mm)	2-kolom / 3-kolom / 4-kolom	
	300 – 900	
aantal buizen (n)	10 – 26	28 – 40
standvoet	2x	3x

NEDERLAND. Prijzen in euro (excl. BTW)

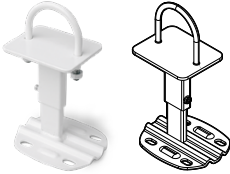
PRIJSGROEP: VPG10 - ACC.



		KLEUR	ART. NR.	€
TELESCOPISCHE ONDERSTEUNVOET  <ul style="list-style-type: none"> • Hoogte: min. 200 mm, max. 230 mm • Telescopische ondersteunvoet steeds in combinatie met de wand- en klemconsoles 	RITMO VERTICAAL / RITMO HORIZONTAAL			
		RAL 9016	11810300000	75
		KLEUR	11810300000C	86
AFDEKROZET ONDERSTEUNVOET CHAPE  <ul style="list-style-type: none"> • 70 x 40 mm. Aantal rozetten = aantal standvoeten 	RITMO VERTICAAL / RITMO HORIZONTAAL			
		RAL 9016	1181 032 0000 9016	13
AFDEKROZET ONDERSTEUNVOET AFGEWERKTE VLOER  <ul style="list-style-type: none"> • 130 x 110 mm. Aantal rozetten = aantal standvoeten 	RITMO VERTICAAL / RITMO HORIZONTAAL			
		RAL 9016	1181 031 0000 9016	17

hoogte (H mm)	2-kolom / 3-kolom					4-kolom				
	300 – 600	900 – 2000	2200	300 – 600	900 – 2000	2200	300 – 600	900 – 2000	2200	
aantal buizen (n)	10 – 24	26 – 40	6 – 24	26 – 40	6 – 16	10 – 24	26 – 40	6 – 24	26 – 40	6 – 16
telescopische ondersteunvoet	2x	3x	2x	3x	2x	2x	3x	2x	3x	3x

NEDERLAND. Prijzen in euro (excl. BTW)

RITMO ACCESSOIRES
 IN OPTIE

PRIJSGROEP: VPG10 - ACC.

ACCESSOIRES		KLEUR	ART. NR.	€
		RITMO HORIZONTAAL		
THERMOSTAATKOP		WIT	11911630102	54
		RITMO HORIZONTAAL		
THERMOSTAATKOP		CHROOM	11911631102	69

PRIJSGROEP: VPG10B - HANDDOEKBEUGELS

ACCESSOIRES		KLEUR	ART. NR.	€
		RITMO VERTICAAL / RITMO HORIZONTAAL		
HANDDOEKBEUGEL		CHROOM	11832650000099	150

- b = 1000 mm (zelf in te korten)

Montagevoorschriften accessoires: zie www.vasco.eu
 NEDERLAND. Prijzen in euro (excl. BTW)

uit voorraad leverbaar

RITMO: VERTICAAL

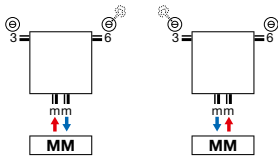

- Ontluchter in aansluiting 3 of 6.

RITMO: HORIZONTAAL

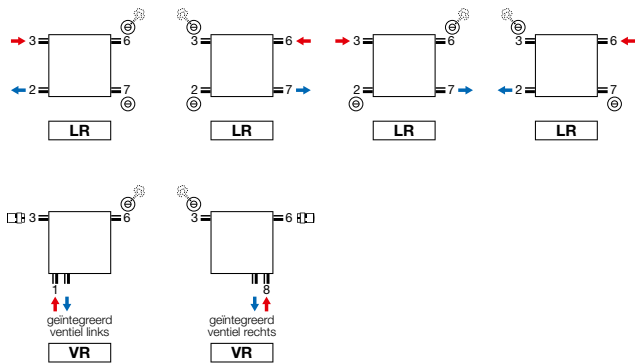

- Ontluchter in aansluiting 3 of 6.
- Geïntegreerd ventiel (aansluiting VR) (meerprijs: €85) (thermostaatkop apart te bestellen, zie p. 338). Plaatsing thermostaatkop links, door spiegelen van radiator. Opgelet: de aanvoer is aan de buitenkant van de radiator!

Opmerking: het aansluiten van de radiator kan enkel volgens de getoonde aansluiticonen. Voor elke andere aansluitwijze nemen wij geen verantwoordelijkheid.

RITMO VERTICAAL

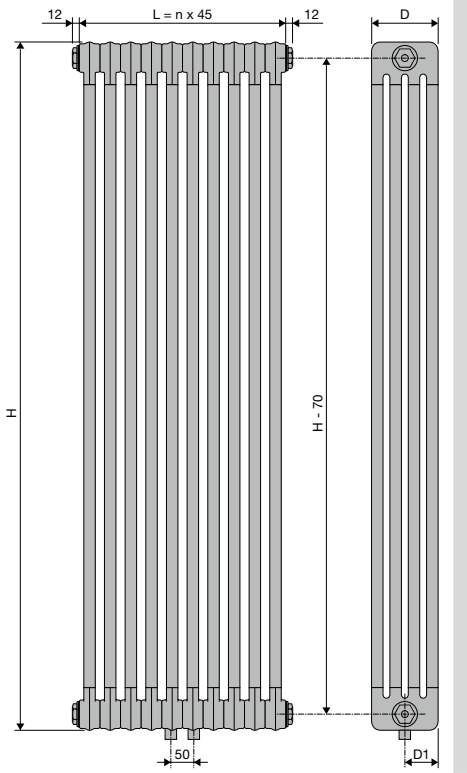

	VB-2K/65 / VB-3K/105 / VB-4K/145					
	H	1500	1800	2000	2200	
Diepte (D)	65	105	145			
D1	32,5	52,5	72,5			
Aantal leden (n)	6	8	10	12	14	16

RITMO HORIZONTAAL

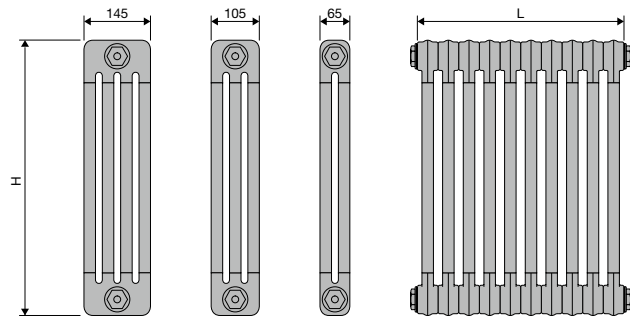
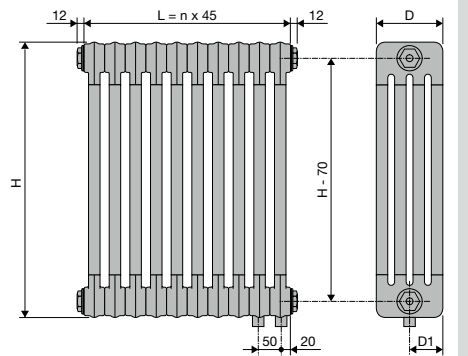
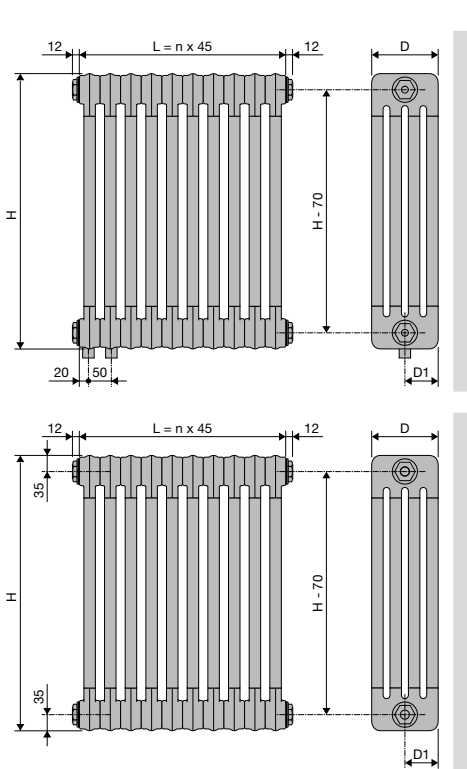

	HB-2K/65 / HB-3K/105 / HB-4K/145															
	H	300	400	500	600	900										
Diepte (D)	65	105	145													
D1	32,5	52,5	72,5													
Aantal leden (n)	10	12	14	16	18	20	22	24	26	28	30	32	34	36	38	40



KOLOMRADIATOREN

VINTAGE (VINTAGE 50)



TYPES

- Vintage 50: afstand tussen de leden 50 mm
- 4 dieptes (D110, D160, D220, D250)

KLEUREN

- Standaardkleur S600 (witte fijn structuurlak) (RAL 9016: geen meerprijs 15%)
- Verkrijgbaar in transparante coating (kleurcode 57)
- **Opgelet: een radiator in transparante coating niet in vochtige ruimtes plaatsen!**
- Uitgebreide kleurenkaart zie p. 12

SPECIAAL

- Vloer- of wandmontage

BEVESTIGINGEN

- Standaard wandbevestigingen of ledenvoeten, 1/2" blindstop, 1/2" ontluchter
- Bevestigingen in de kleur van de radiator (aantal afhankelijk van de lengte van de radiator)
- De voeten en bevestigingen van radiatoren in transparante coating zijn gelakt in de kleur N507.

TECHNISCH

- ATL-grondlaag, epoxy-polyester poedercoating
- Standaardwerkdruk: 5 bar
- Maximale bedrijfstemperatuur: 110°C

TECHNISCHE TEKENINGEN

- Zie p. 358

AANSLUITING

- 4x 1/2" (SL, SR, 26, 37)
- Ontluchter in aansluiting 3 of 6
- Aansluitingen: 1/2" (binnendraad)
- Aansluiting 27, 72: **meerprijs €88**

VINTAGE

Vroeger is weer helemaal van nu

Terug naar de 'oerradiator'. Erg populair omwille van de tot de verbeelding sprekende, authentieke look. Standaard aangeboden in een witte uitvoering, maar ook verkrijgbaar met een transparante coating voor een nog meer uitgesproken vintage look. De Vintage staat borg voor een zeer hoge warmteafgifte. Ideaal voor de verwarming van grote, hoge ruimten, ook in combinatie met energiezuinige technologieën. Een designradiator die als geen andere tot zijn recht komt in een retro-interieur en zich graag voor een raam laat plaatsen.

AANBEVOLEN AANSLUITING (LR)

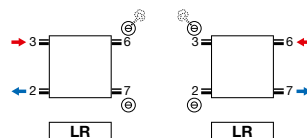

Andere aansluitmogelijkheden, zie p. 357



HOE VINTAGE 50 BESTELLEN

Leveringstermijn 15 - 30 werkdagen
(zonder transportduur)

VINTAGE (VINTAGE 50 / D110)

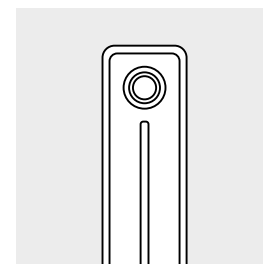
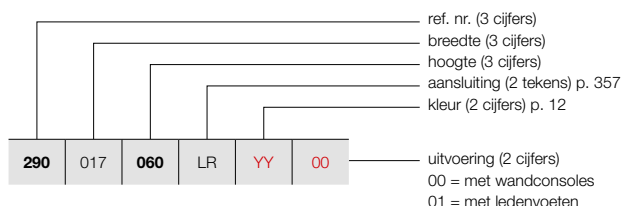

VINTAGE 50 / D110

PRIJSGROEP: VPG5 - KOLOMRADIATOREN

BESTELCODE MAATWERK VINTAGE 50	TECHNISCHE GEGEVENS							STANDAARDKLEUR		ANDERE KLEUREN						
	buizen	breedte (L mm)	hoogte (H mm)	75/65/20 (Watt) (Φ50K)	55/45/20 (Watt) (Φ30K)	n-exp.	gewicht (kg)	inhoud (l)	el. weerst. (Watt)	prijs S600* (€)	prijs kleur (€)					
REF. NR. VINTAGE 50 VINTAGE 50/D110 : 290																
290	017	060	LR	YY	00											
		100														
						3	178	600	165	87	1,25	4,17	2,49	-	410	472
						3	178	1000	252	131	1,28	6,57	3,39	-	434	499
290	022	060	LR	YY	00											
		100														
						4	228	600	220	116	1,25	5,56	3,32	-	427	491
						4	228	1000	336	175	1,28	8,76	4,52	-	463	532
290	027	060	LR	YY	00											
		100														
						5	278	600	275	145	1,25	6,95	4,15	-	447	514
						5	278	1000	420	218	1,28	10,95	5,65	-	493	567
290	032	060	LR	YY	00											
		100														
						6	328	600	330	174	1,25	8,34	4,98	-	471	542
						6	328	1000	504	262	1,28	13,14	6,78	-	520	598
290	037	060	LR	YY	00											
		100														
						7	378	600	385	203	1,25	9,73	5,81	-	488	561
						7	378	1000	588	306	1,28	15,33	7,91	-	552	635
290	042	060	LR	YY	00											
		100														
						8	428	600	440	232	1,25	11,12	6,64	-	518	596
						8	428	1000	672	349	1,28	17,52	9,04	-	582	669
290	047	060	LR	YY	00											
		100														
						9	478	600	495	261	1,25	12,51	7,47	-	535	615
						9	478	1000	756	393	1,28	19,71	10,17	-	611	703
290	052	060	LR	YY	00											
		100														
						10	528	600	550	290	1,25	13,90	8,30	-	560	644
						10	528	1000	840	437	1,28	21,90	11,30	-	641	737
290	057	060	LR	YY	00											
		100														
						11	578	600	605	319	1,25	15,29	9,13	-	581	668
						11	578	1000	924	481	1,28	24,09	12,43	-	675	776
290	062	060	LR	YY	00											
		100														
						12	628	600	660	349	1,25	16,68	9,96	-	605	696
						12	628	1000	1008	524	1,28	26,28	13,56	-	703	808
290	067	060	LR	YY	00											
		100														
						13	678	600	715	378	1,25	18,07	10,79	-	624	718
						13	678	1000	1092	568	1,28	28,47	14,69	-	734	844
290	072	060	LR	YY	00											
		100														
						14	728	600	770	407	1,25	19,46	11,62	-	645	742
						14	728	1000	1176	612	1,28	30,66	15,82	-	759	873
290	077	060	LR	YY	00											
		100														
						15	778	600	825	436	1,25	20,85	12,45	-	664	764
						15	778	1000	1260	655	1,28	32,85	16,95	-	788	906
290	082	060	LR	YY	00											
		100														
						16	828	600	880	465	1,25	22,24	13,28	-	681	783
						16	828	1000	1344	699	1,28	35,04	18,08	-	814	936
290	087	060	LR	YY	00											
		100														
						17	878	600	935	494	1,25	23,63	14,11	-	703	808
						17	878	1000	1428	743	1,28	37,23	19,21	-	843	969
290	092	060	LR	YY	00											
		100														
						18	928	600	990	523	1,25	25,02	14,94	-	724	833
						18	928	1000	1512	786	1,28	39,42	20,34	-	874	1005
290	097	060	LR	YY	00											
		100														
						19	978	600	1045	552	1,25	26,41	15,77	-	740	851
						19	978	1000	1596	830	1,28	41,61	21,47	-	900	1035

Conform EN442-1: 2014: radiatoren en convectoren

* RAL 9016: geen meerprijs 15%

Voor meer details over onze artikel-data, zie artikel-database: <https://www.2ba.nl>

Voor de warmteafgiftes van andere regimes, kijkt u op p. 370 (correctiefactoren)

NETERLAND. Prijzen in euro (excl. BTW)

VINTAGE (VINTAGE 50 / D110)

HOE VINTAGE 50 BESTELLEN

Leveringstermijn 15 - 30 werkdagen
(zonder transportduur)

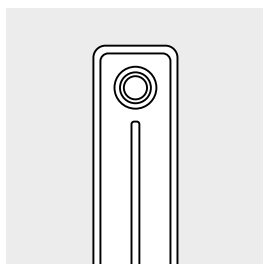

VINTAGE 50 / D110

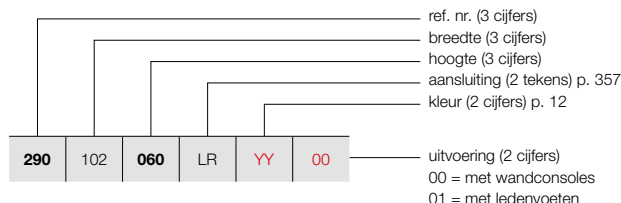

PRIJSGROEP: VPG5 - KOLOMRADIATOREN

BESTELCODE MAATWERK VINTAGE 50	TECHNISCHE GEGEVENS									STANDAARDKLEUR	ANDERE KLEUREN
	buizen	breedte (L mm)	hoogte (H mm)	75/65/20 (Watt) (Φ50K)	55/45/20 (Watt) (Φ30K)	n-exp.	gewicht (kg)	inhoud (l)	el. weerst. (Watt)	prijs S600* (€)	prijs kleur (€)
REF. NR. VINTAGE 50 VINTAGE 50/D110 : 290											
290 102 060 LR YY 00	20	1028	600	1100	581	1,25	27,80	16,60	-	761	875
	20	1028	1000	1680	874	1,28	43,80	22,60	-	927	1066
290 107 060 LR YY 00	21	1078	600	1155	610	1,25	29,19	17,43	-	798	918
	21	1078	1000	1764	917	1,28	45,99	23,73	-	971	1117
290 112 060 LR YY 00	22	1128	600	1210	639	1,25	30,58	18,26	-	815	937
	22	1128	1000	1848	961	1,28	48,18	24,86	-	1000	1150
290 117 060 LR YY 00	23	1178	600	1265	668	1,25	31,97	19,09	-	840	966
	23	1178	1000	1932	1005	1,28	50,37	25,99	-	1024	1178
290 122 060 LR YY 00	24	1228	600	1320	697	1,25	33,36	19,92	-	856	984
	24	1228	1000	2016	1048	1,28	52,56	27,12	-	1053	1211
290 127 060 LR YY 00	25	1278	600	1375	726	1,25	34,75	20,75	-	877	1009
	25	1278	1000	2100	1092	1,28	54,75	28,25	-	1082	1244
290 132 060 LR YY 00	26	1328	600	1430	755	1,25	36,14	21,58	-	915	1052
	26	1328	1000	2184	1136	1,28	56,94	29,38	-	1128	1297
290 137 060 LR YY 00	27	1378	600	1485	784	1,25	37,53	22,41	-	1021	1073
	27	1378	1000	2268	1179	1,28	59,13	30,51	-	1156	1329
290 142 060 LR YY 00	28	1428	600	1540	813	1,25	38,92	23,24	-	956	1099
	28	1428	1000	2352	1223	1,28	61,32	31,64	-	1185	1363
290 147 060 LR YY 00	29	1478	600	1595	842	1,25	40,31	24,07	-	975	1121
	29	1478	1000	2436	1267	1,28	63,51	32,77	-	1210	1392
290 152 060 LR YY 00	30	1528	600	1650	871	1,25	41,70	24,90	-	992	1141
	30	1528	1000	2520	1310	1,28	65,70	33,90	-	1239	1425
290 157 060 LR YY 00	31	1578	600	1705	900	1,25	43,09	25,73	-	1013	1165
	31	1578	1000	2604	1354	1,28	67,89	35,03	-	1275	1466
290 162 060 LR YY 00	32	1628	600	1760	929	1,25	44,48	26,56	-	1032	1187
	32	1628	1000	2688	1398	1,28	70,08	36,16	-	1301	1496
290 167 060 LR YY 00	33	1678	600	1815	958	1,25	45,87	27,39	-	1096	1260
	33	1678	1000	2772	1442	1,28	72,27	37,29	-	1374	1580
290 172 060 LR YY 00	34	1728	600	1870	987	1,25	47,26	28,22	-	1115	1282
	34	1728	1000	2856	1485	1,28	74,46	38,42	-	1402	1612
290 177 060 LR YY 00	35	1778	600	1925	1017	1,25	48,65	29,05	-	1138	1309
	35	1778	1000	2940	1529	1,28	76,65	39,55	-	1427	1641
290 182 060 LR YY 00	36	1828	600	1980	1046	1,25	50,04	29,88	-	1163	1337
	36	1828	1000	3024	1573	1,28	78,84	40,68	-	1456	1674
290 187 060 LR YY 00	37	1878	600	2035	1075	1,25	51,43	30,71	-	1183	1360
	37	1878	1000	3108	1616	1,28	81,03	41,81	-	1485	1708

Conform EN442-1: 2014: radiatoren en convectoren

* RAL 9016: geen meerprijs 15%

Voor meer details over onze artikel-data, zie artikel-database: <https://www.2ba.nl>

Voor de warmteafgiftes van andere regimes, kijkt u op p. 370 (correctiefactoren)
 NEDERLAND. Prijzen in euro (excl. BTW)

HOE VINTAGE 50 BESTELLEN

Leveringstermijn 15 - 30 werkdagen
(zonder transportduur)

VINTAGE (VINTAGE 50 / D110)

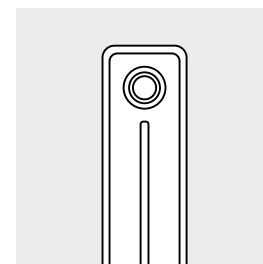
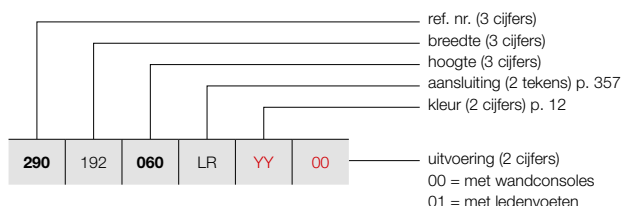

VINTAGE 50 / D110

PRIJSGROEP: VPG5 - KOLOMRADIATOREN

BESTELCODE MAATWERK VINTAGE 50	TECHNISCHE GEGEVENS							STANDAARDKLEUR	ANDERE KLEUREN		
	buizen	breedte (L mm)	hoogte (H mm)	75/65/20 (Watt) (Φ50K)	55/45/20 (Watt) (Φ30K)	n-exp.	gewicht (kg)			inhoud (l)	el. weerst. (Watt)
REF. NR. VINTAGE 50 VINTAGE 50/D110 : 290											
290 192 060 LR YY 00	38	1928	600	2090	1104	1,25	52,82	31,54	-	1202	1382
	38	1928	1000	3192	1660	1,28	83,22	42,94	-	1512	1739
290 197 060 LR YY 00	39	1978	600	2145	1133	1,25	54,21	32,37	-	1225	1409
	39	1978	1000	3276	1704	1,28	85,41	44,07	-	1542	1773
290 202 060 LR YY 00	40	2028	600	2200	1162	1,25	55,60	33,20	-	1244	1431
	40	2028	1000	3360	1747	1,28	87,60	45,20	-	1569	1804
290 207 060 LR YY 00	41	2078	600	2255	1191	1,25	56,99	34,03	-	1258	1447
	41	2078	1000	3444	1791	1,28	89,79	46,33	-	1597	1837
290 212 060 LR YY 00	42	2128	600	2310	1220	1,25	58,38	34,86	-	1282	1474
	42	2128	1000	3528	1835	1,28	91,98	47,46	-	1625	1869
290 217 060 LR YY 00	43	2178	600	2365	1249	1,25	59,77	35,69	-	1301	1496
	43	2178	1000	3612	1878	1,28	94,17	48,59	-	1655	1903
290 222 060 LR YY 00	44	2228	600	2420	1278	1,25	61,16	36,52	-	1323	1521
	44	2228	1000	3696	1922	1,28	96,36	49,72	-	1682	1934
290 227 060 LR YY 00	45	2278	600	2475	1307	1,25	62,55	37,35	-	1339	1540
	45	2278	1000	3780	1966	1,28	98,55	50,85	-	1711	1968
290 232 060 LR YY 00	46	2328	600	2530	1336	1,25	63,94	38,18	-	1363	1567
290 237 060 LR YY 00	47	2378	600	2585	1365	1,25	65,33	39,01	-	1380	1587
290 242 060 LR YY 00	48	2428	600	2640	1394	1,25	66,72	39,84	-	1402	1612
290 247 060 LR YY 00	49	2478	600	2695	1423	1,25	68,11	40,67	-	1421	1634
290 252 060 LR YY 00	50	2528	600	2750	1452	1,25	69,50	41,50	-	1444	1661
290 257 060 LR YY 00	51	2578	600	2805	1481	1,25	70,89	42,33	-	1480	1702
290 262 060 LR YY 00	52	2628	600	2860	1510	1,25	72,28	43,16	-	1497	1722
290 267 060 LR YY 00	53	2678	600	2915	1539	1,25	73,67	43,99	-	1515	1742
290 272 060 LR YY 00	54	2728	600	2970	1568	1,25	75,06	44,82	-	1540	1771
290 277 060 LR YY 00	55	2778	600	3025	1597	1,25	76,45	45,65	-	1559	1793
290 282 060 LR YY 00	56	2828	600	3080	1626	1,25	77,84	46,48	-	1579	1816
290 287 060 LR YY 00	57	2878	600	3135	1655	1,25	79,23	47,31	-	1597	1837
290 292 060 LR YY 00	58	2928	600	3190	1685	1,25	80,62	48,14	-	1616	1858
290 297 060 LR YY 00	59	2978	600	3245	1714	1,25	82,01	48,97	-	1636	1881
290 302 060 LR YY 00	60	3028	600	3300	1743	1,25	83,40	49,80	-	1657	1906

Conform EN442-1: 2014: radiatoren en convectoren

* RAL 9016: geen meerprijs 15%

Voor meer details over onze artikel-data, zie artikel-database: <https://www.2ba.nl>

Voor de warmteafgiftes van andere regimes, kijkt u op p. 370 (correctiefactoren)
 NEDERLAND. Prijzen in euro (excl. BTW)

HOE VINTAGE 50 BESTELLEN

Leveringstermijn 15 - 30 werkdagen
(zonder transportduur)

VINTAGE (VINTAGE 50 / D160)

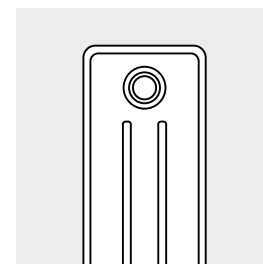
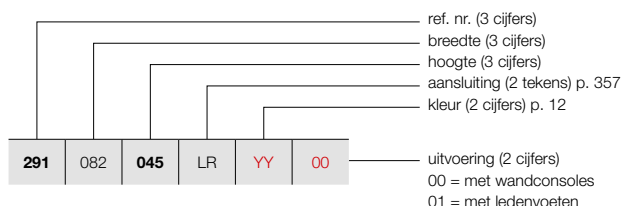

VINTAGE 50 / D160

PRIJSGROEP: VPG5 - KOLOMRADIATOREN

BESTELCODE MAATWERK VINTAGE 50							TECHNISCHE GEGEVENS					STANDAARDKLEUR	ANDERE KLEUREN			
buizen	breedte (L mm)	hoogte (H mm)	75/65/20 (Watt) (φ50K)	55/45/20 (Watt) (φ30K)	n-exp.	gewicht (kg)	inhoud (l)	el. weerst. (Watt)	prijs S600* (€)	prijs kleur (€)						
REF. NR. VINTAGE 50 VINTAGE 50/D160 : 291																
291	082	045	LR	YY	00	16	828	450	928	493	1,24	23,84	15,04	-	680	782
		060				16	828	600	1168	614	1,26	32,00	18,24	-	759	873
		100				16	828	1000	1776	919	1,29	51,36	26,08	-	937	1078
291	087	045	LR	YY	00	17	878	450	986	523	1,24	25,33	15,98	-	701	806
		060				17	878	600	1241	652	1,26	34,00	19,38	-	785	903
		100				17	878	1000	1887	976	1,29	54,57	27,71	-	975	1121
291	092	045	LR	YY	00	18	928	450	1044	554	1,24	26,82	16,92	-	720	828
		060				18	928	600	1314	690	1,26	36,00	20,52	-	810	932
		100				18	928	1000	1998	1034	1,29	57,78	29,34	-	1011	1163
291	097	045	LR	YY	00	19	978	450	1102	585	1,24	28,31	17,86	-	738	849
		060				19	978	600	1387	729	1,26	38,00	21,66	-	832	957
		100				19	978	1000	2109	1091	1,29	60,99	30,97	-	1046	1203
291	102	045	LR	YY	00	20	1028	450	1160	616	1,24	29,80	18,80	-	759	873
		060				20	1028	600	1460	767	1,26	40,00	22,80	-	856	984
		100				20	1028	1000	2220	1149	1,29	64,20	32,60	-	1082	1244
291	107	045	LR	YY	00	21	1078	450	1218	646	1,24	31,29	19,74	-	793	912
		060				21	1078	600	1533	805	1,26	42,00	23,94	-	897	1032
		100				21	1078	1000	2331	1206	1,29	67,41	34,23	-	1131	1301
291	112	045	LR	YY	00	22	1128	450	1276	677	1,24	32,78	20,68	-	813	935
		060				22	1128	600	1606	844	1,26	44,00	25,08	-	920	1058
		100				22	1128	1000	2442	1263	1,29	70,62	35,86	-	1166	1341
291	117	045	LR	YY	00	23	1178	450	1334	708	1,24	34,27	21,62	-	832	957
		060				23	1178	600	1679	882	1,26	46,00	26,22	-	941	1082
		100				23	1178	1000	2553	1321	1,29	73,83	37,49	-	1201	1381
291	122	045	LR	YY	00	24	1228	450	1392	739	1,24	35,76	22,56	-	850	978
		060				24	1228	600	1752	920	1,26	48,00	27,36	-	968	1113
		100				24	1228	1000	2664	1378	1,29	77,04	39,12	-	1237	1423
291	127	045	LR	YY	00	25	1278	450	1450	770	1,24	37,25	23,50	-	872	1003
		060				25	1278	600	1825	959	1,26	50,00	28,50	-	991	1140
		100				25	1278	1000	2775	1436	1,29	80,25	40,75	-	1273	1464
291	132	045	LR	YY	00	26	1328	450	1508	800	1,24	38,74	24,44	-	912	1049
		060				26	1328	600	1898	997	1,26	52,00	29,64	-	1037	1193
		100				26	1328	1000	2886	1493	1,29	83,46	42,38	-	1327	1526
291	137	045	LR	YY	00	27	1378	450	1566	831	1,24	40,23	25,38	-	929	1068
		060				27	1378	600	1971	1036	1,26	54,00	30,78	-	1059	1218
		100				27	1378	1000	2997	1551	1,29	86,67	44,01	-	1363	1567
291	142	045	LR	YY	00	28	1428	450	1624	862	1,24	41,72	26,32	-	946	1088
		060				28	1428	600	2044	1074	1,26	56,00	31,92	-	1083	1245
		100				28	1428	1000	3108	1608	1,29	89,88	45,64	-	1397	1607

Conform EN442-1: 2014: radiatoren en convectoren

* RAL 9016: geen meerprijs 15%

Voor meer details over onze artikel-data, zie artikel-database: <https://www.2ba.nl>

Voor de warmteafgiftes van andere regimes, kijkt u op p. 370 (correctiefactoren)
 NEDERLAND. Prijzen in euro (excl. BTW)

VINTAGE (VINTAGE 50 / D160)

HOE VINTAGE 50 BESTELLEN

Leveringstermijn 15 - 30 werkdagen
(zonder transportduur)

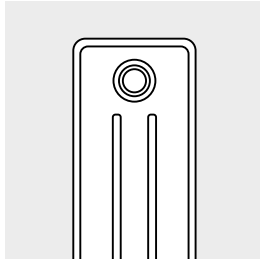

VINTAGE 50 / D160

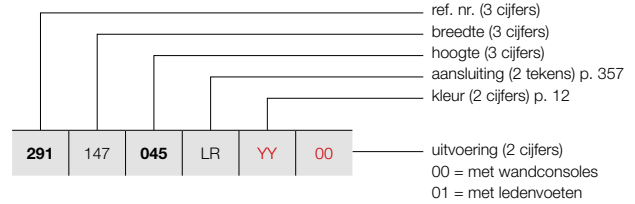

PRIJSGROEP: VPG5 - KOLOMRADIATOREN

BESTELCODE MAATWERK VINTAGE 50							TECHNISCHE GEGEVENS					STANDAARDKLEUR	ANDERE KLEUREN			
ref. nr.	breedte (L mm)	hoogte (H mm)	75/65/20 (Watt) (Φ50K)	55/45/20 (Watt) (Φ30K)	n-exp.	gewicht (kg)	inhoud (l)	el. weerst. (Watt)	prijs S600* (€)	prijs kleur (€)						
REF. NR. VINTAGE 50 VINTAGE 50/D160 : 291																
291	147	045	LR	YY	00	29	1478	450	1682	893	1,24	43,21	27,26	-	968	1113
		060				29	1478	600	2117	1112	1,26	58,00	33,06	-	1105	1271
		100				29	1478	1000	3219	1665	1,29	93,09	47,27	-	1432	1647
291	152	045	LR	YY	00	30	1528	450	1740	924	1,24	44,70	28,20	-	986	1134
		060				30	1528	600	2190	1151	1,26	60,00	34,20	-	1134	1304
		100				30	1528	1000	3330	1723	1,29	96,30	48,90	-	1464	1684
291	157	045	LR	YY	00	31	1578	450	1798	954	1,24	46,19	29,14	-	1006	1157
		060				31	1578	600	2263	1189	1,26	62,00	34,34	-	1156	1329
291	162	045	LR	YY	00	32	1628	450	1856	985	1,24	47,68	30,08	-	1024	1178
		060				32	1628	600	2336	1227	1,26	64,00	36,48	-	1180	1357
291	167	045	LR	YY	00	33	1678	450	1914	1016	1,24	49,17	31,02	-	1090	1254
		060				33	1678	600	2409	1266	1,26	66,00	37,62	-	1248	1435
291	172	045	LR	YY	00	34	1728	450	1972	1047	1,24	50,66	31,96	-	1105	1271
		060				34	1728	600	2482	1304	1,26	68,00	38,76	-	1275	1466
291	177	045	LR	YY	00	35	1778	450	2030	1077	1,24	52,15	32,90	-	1128	1297
		060				35	1778	600	2555	1342	1,26	70,00	39,90	-	1294	1488
291	182	045	LR	YY	00	36	1828	450	2088	1108	1,24	53,64	33,84	-	1155	1328
		060				36	1828	600	2628	1381	1,26	72,00	41,04	-	1329	1528
291	187	045	LR	YY	00	37	1878	450	2146	1139	1,24	55,13	34,78	-	1170	1346
		060				37	1878	600	2701	1419	1,26	74,00	42,18	-	1347	1549
291	192	045	LR	YY	00	38	1928	450	2204	1170	1,24	56,62	35,72	-	1192	1371
		060				38	1928	600	2774	1457	1,26	76,00	43,32	-	1377	1584
291	197	045	LR	YY	00	39	1978	450	2262	1201	1,24	58,11	36,66	-	1210	1392
		060				39	1978	600	2847	1496	1,26	78,00	44,46	-	1401	1611
291	202	045	LR	YY	00	40	2028	450	2320	1231	1,24	59,60	37,60	-	1230	1415
		060				40	2028	600	2920	1534	1,26	80,00	45,60	-	1424	1638
291	207	045	LR	YY	00	41	2078	450	2378	1262	1,24	61,09	38,54	-	1252	1440
		060				41	2078	600	2993	1572	1,26	82,00	46,74	-	1449	1666
291	212	045	LR	YY	00	42	2128	450	2436	1293	1,24	62,58	39,48	-	1272	1463
		060				42	2128	600	3066	1611	1,26	84,00	47,88	-	1477	1699
291	217	045	LR	YY	00	43	2178	450	2494	1324	1,24	64,07	40,42	-	1290	1484
		060				43	2178	600	3139	1649	1,26	86,00	49,02	-	1496	1720
291	222	045	LR	YY	00	44	2228	450	2552	1355	1,24	65,56	41,36	-	1309	1505
		060				44	2228	600	3212	1688	1,26	88,00	50,16	-	1519	1747

Conform EN442-1: 2014: radiatoren en convectoren

* RAL 9016: geen meerprijs 15%

Voor meer details over onze artikel-data, zie artikel-database: <https://www.2ba.nl>

Voor de warmteafgiftes van andere regimes, kijkt u op p. 370 (correctiefactoren)
NEDERLAND. Prijzen in euro (excl. BTW)

HOE VINTAGE 50 BESTELLEN

Leveringstermijn 15 - 30 werkdagen
(zonder transportduur)

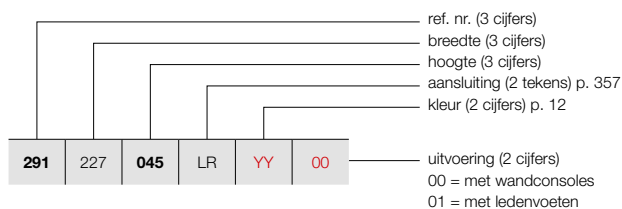

VINTAGE (VINTAGE 50 / D160)

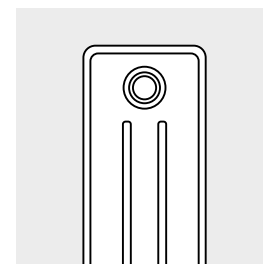

VINTAGE 50 / D160

PRIJSGROEP: VPG5 - KOLOMRADIATOREN

BESTELCODE MAATWERK VINTAGE 50	TECHNISCHE GEGEVENS							STANDAARDKLEUR		ANDERE KLEUREN						
	buizen	breedte (L mm)	hoogte (H mm)	75/65/20 (Watt) (Φ50K)	55/45/20 (Watt) (Φ30K)	n-exp.	gewicht (kg)	inhoud (l)	el. weerst. (Watt)	prijs S600* (€)	prijs kleur (€)					
REF. NR. VINTAGE 50 VINTAGE 50/D160 : 291																
291	227	045	LR	YY	00											
		060														
						45	2278	450	2610	1385	1,24	67,05	42,30	-	1330	1530
						45	2278	600	3285	1726	1,26	90,00	51,30	-	1545	1777
291	232	045	LR	YY	00											
		060														
						46	2328	450	2668	1416	1,24	68,54	43,24	-	1345	1547
						46	2328	600	3358	1764	1,26	92,00	52,44	-	1569	1804
291	237	045	LR	YY	00											
		060														
						47	2378	450	2726	1447	1,24	70,03	44,18	-	1367	1572
						47	2378	600	3431	1803	1,26	94,00	53,58	-	1594	1833
291	242	045	LR	YY	00											
		060														
						48	2428	450	2784	1478	1,24	71,52	45,12	-	1387	1595
						48	2428	600	3504	1841	1,26	96,00	54,72	-	1616	1858
291	247	045	LR	YY	00											
		060														
						49	2478	450	2842	1508	1,24	73,01	46,06	-	1406	1617
291	252	045	LR	YY	00											
		060														
						50	2528	450	2900	1539	1,24	74,50	47,00	-	1425	1639
291	257	045	LR	YY	00											
		060														
						51	2578	450	2958	1570	1,24	75,99	47,94	-	1462	1681
291	262	045	LR	YY	00											
		060														
						52	2628	450	3016	1601	1,24	77,48	48,88	-	1484	1707
291	267	045	LR	YY	00											
		060														
						53	2678	450	3074	1632	1,24	78,97	49,82	-	1501	1726
291	272	045	LR	YY	00											
		060														
						54	2728	450	3132	1662	1,24	80,46	50,76	-	1522	1750
291	277	045	LR	YY	00											
		060														
						55	2778	450	3190	1693	1,24	81,95	51,70	-	1542	1773
291	282	045	LR	YY	00											
		060														
						56	2828	450	3248	1724	1,24	83,44	52,64	-	1563	1797
291	287	045	LR	YY	00											
		060														
						57	2878	450	3306	1755	1,24	84,93	53,58	-	1581	1818
291	292	045	LR	YY	00											
		060														
						58	2928	450	3364	1786	1,24	86,42	54,52	-	1601	1841
291	297	045	LR	YY	00											
		060														
						59	2978	450	3422	1816	1,24	87,91	55,46	-	1619	1862
291	302	045	LR	YY	00											
		060														
						60	3028	450	3480	1847	1,24	89,40	56,40	-	1639	1885

Conform EN442-1: 2014: radiatoren en convectoren

* RAL 9016: geen meerprijs 15%

Voor meer details over onze artikel-data, zie artikel-database: <https://www.2ba.nl>

Voor de warmteafgiftes van andere regimes, kijkt u op p. 370 (correctiefactoren)
NEDERLAND. Prijzen in euro (excl. BTW)

VINTAGE (VINTAGE 50 / D220)

HOE VINTAGE 50 BESTELLEN

Leveringstermijn 15 - 30 werkdagen
(zonder transportduur)

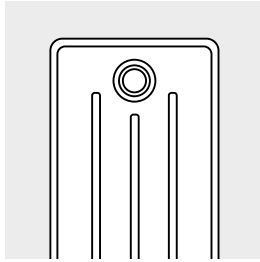

VINTAGE 50 / D220

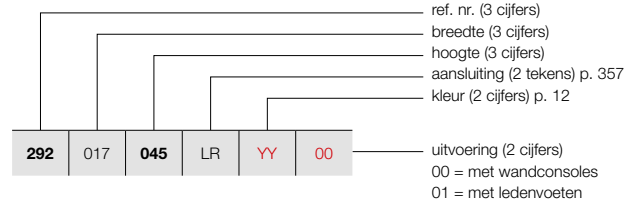

PRIJSGROEP: VPG5 - KOLOMRADIATOREN

BESTELCODE MAATWERK VINTAGE 50							TECHNISCHE GEGEVENS					STANDAARDKLEUR	ANDERE KLEUREN			
buizen	breedte (L mm)	hoogte (H mm)	75/65/20 (Watt) (Ø50K)	55/45/20 (Watt) (Ø30K)	n-exp.	gewicht (kg)	inhoud (l)	el. weerst. (Watt)	prijs S600* (€)	prijs kleur (€)						
REF. NR. VINTAGE 50 VINTAGE 50/D220 : 292																
292	017	045 060 100	LR	YY	00	3	178	450	225	119	1,25	6,00	3,69	-	426	490
						3	178	600	282	148	1,26	7,86	4,44	-	444	511
						3	178	1000	435	226	1,28	13,68	7,26	-	492	566
292	022	045 060 100	LR	YY	00	4	228	450	300	158	1,25	8,00	4,92	-	446	513
						4	228	600	376	198	1,26	10,48	5,92	-	475	546
						4	228	1000	580	302	1,28	18,24	9,68	-	536	616
292	027	045 060 100	LR	YY	00	5	278	450	375	198	1,25	10,00	6,15	-	474	545
						5	278	600	470	247	1,26	13,10	7,40	-	507	583
						5	278	1000	725	377	1,28	22,80	12,10	-	582	669
292	032	045 060 100	LR	YY	00	6	328	450	450	238	1,25	12,00	7,38	-	498	573
						6	328	600	564	296	1,26	15,72	8,88	-	535	615
						6	328	1000	870	452	1,28	27,36	14,52	-	631	726
292	037	045 060 100	LR	YY	00	7	378	450	525	277	1,25	14,00	8,61	-	608	598
						7	378	600	658	346	1,26	18,34	10,36	-	566	651
						7	378	1000	1015	528	1,28	31,92	16,94	-	675	776
292	042	045 060 100	LR	YY	00	8	428	450	600	317	1,25	16,00	9,84	-	556	639
						8	428	600	752	395	1,26	20,96	11,84	-	605	696
						8	428	1000	1160	603	1,28	36,48	19,36	-	726	835
292	047	045 060 100	LR	YY	00	9	478	450	675	356	1,25	18,00	11,07	-	575	661
						9	478	600	846	444	1,26	23,58	13,32	-	633	728
						9	478	1000	1305	679	1,28	41,04	21,78	-	770	886
292	052	045 060 100	LR	YY	00	10	528	450	750	396	1,25	20,00	12,30	-	598	688
						10	528	600	940	494	1,26	26,20	14,80	-	664	764
						10	528	1000	1450	754	1,28	45,60	24,20	-	817	940
292	057	045 060 100	LR	YY	00	11	578	450	825	436	1,25	22,00	13,53	-	631	726
						11	578	600	1034	543	1,26	28,82	16,28	-	697	802
						11	578	1000	1595	829	1,28	50,16	26,62	-	872	1003
292	062	045 060 100	LR	YY	00	12	628	450	900	475	1,25	24,00	14,76	-	652	750
						12	628	600	1128	593	1,26	31,44	17,76	-	730	840
						12	628	1000	1740	905	1,28	54,72	29,04	-	916	1053
292	067	045 060 100	LR	YY	00	13	678	450	975	515	1,25	26,00	15,99	-	676	777
						13	678	600	1222	642	1,26	34,06	19,24	-	759	873
						13	678	1000	1885	980	1,28	59,28	31,46	-	961	1105
292	072	045 060 100	LR	YY	00	14	728	450	1050	554	1,25	28,00	17,22	-	697	802
						14	728	600	1316	691	1,26	36,68	20,72	-	790	909
						14	728	1000	2030	1056	1,28	63,84	33,88	-	1004	1155
292	077	045 060 100	LR	YY	00	15	778	450	1125	594	1,25	30,00	18,45	-	724	833
						15	778	600	1410	741	1,26	39,30	22,20	-	817	940
						15	778	1000	2175	1131	1,28	68,40	36,30	-	1050	1208

Conform EN442-1: 2014: radiatoren en convectoren

* RAL 9016: geen meerprijs 15%

Voor meer details over onze artikel-data, zie artikel-database: <https://www.2ba.nl>

Voor de warmteafgifte van andere regimes, kijkt u op p. 370 (correctiefactoren)
NEDERLAND. Prijzen in euro (excl. BTW)

HOE VINTAGE 50 BESTELLEN

Leveringstermijn 15 - 30 werkdagen
(zonder transportduur)

VINTAGE (VINTAGE 50 / D220)

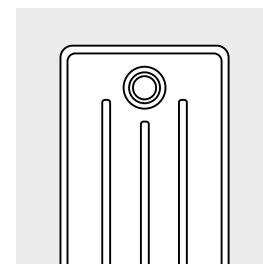
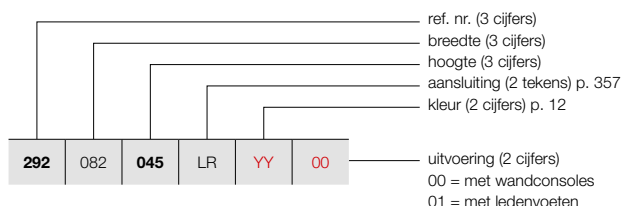

VINTAGE 50 / D220

PRIJSGROEP: VPG5 - KOLOMRADIATOREN

BESTELCODE MAATWERK VINTAGE 50	TECHNISCHE GEGEVENS							STANDAARDKLEUR	ANDERE KLEUREN							
	buizen	breedte (L mm)	hoogte (H mm)	75/65/20 (Watt) (φ50K)	55/45/20 (Watt) (φ30K)	n-exp.	gewicht (kg)			inhoud (l)	el. weerst. (Watt)	prijs S600* (€)	prijs kleur (€)			
REF. NR. VINTAGE 50 VINTAGE 50/D220 : 292																
292	082	045	LR	YY	00	16	828	450	1200	634	1,25	32,00	19,68	-	745	857
		060				16	828	600	1504	790	1,26	41,92	23,68	-	847	974
		100				16	828	1000	2320	1206	1,28	72,96	38,72	-	1096	1260
292	087	045	LR	YY	00	17	878	450	1275	673	1,25	34,00	20,91	-	768	883
		060				17	878	600	1598	840	1,26	44,54	25,16	-	878	1010
		100				17	878	1000	2465	1282	1,28	77,52	41,14	-	1143	1314
292	092	045	LR	YY	00	18	928	450	1350	713	1,25	36,00	22,14	-	793	912
		060				18	928	600	1692	889	1,26	47,16	26,64	-	912	1049
		100				18	928	1000	2610	1357	1,28	82,08	43,56	-	1187	1365
292	097	045	LR	YY	00	19	978	450	1425	752	1,25	38,00	23,37	-	815	937
		060				19	978	600	1786	938	1,26	49,78	28,12	-	936	1076
		100				19	978	1000	2755	1433	1,28	86,64	45,98	-	1233	1418
292	102	045	LR	YY	00	20	1028	450	1500	792	1,25	40,00	24,60	-	841	967
		060				20	1028	600	1880	988	1,26	52,40	29,60	-	968	1113
		100				20	1028	1000	2900	1508	1,28	91,20	48,40	-	1278	1470
292	107	045	LR	YY	00	21	1078	450	1575	832	1,25	42,00	25,83	-	877	1009
		060				21	1078	600	1974	1037	1,26	55,02	31,08	-	1011	1163
		100				21	1078	1000	3045	1584	1,28	95,76	50,82	-	1337	1538
292	112	045	LR	YY	00	22	1128	450	1650	871	1,25	44,00	27,06	-	901	1036
		060				22	1128	600	2068	1086	1,26	57,64	32,56	-	1042	1198
		100				22	1128	1000	3190	1659	1,28	100,32	53,24	-	1381	1588
292	117	045	LR	YY	00	23	1178	450	1725	911	1,25	46,00	28,29	-	923	1061
		060				23	1178	600	2162	1136	1,26	60,26	34,04	-	1072	1233
		100				23	1178	1000	3335	1734	1,28	104,88	55,66	-	1426	1640
292	122	045	LR	YY	00	24	1228	450	1800	951	1,25	48,00	29,52	-	946	1088
		060				24	1228	600	2256	1185	1,26	62,88	35,52	-	1099	1264
		100				24	1228	1000	3480	1810	1,28	109,44	58,08	-	1477	1699
292	127	045	LR	YY	00	25	1278	450	1875	990	1,25	50,00	30,75	-	971	1117
		060				25	1278	600	2350	1235	1,26	65,50	37,00	-	1131	1301
		100				25	1278	1000	3625	1885	1,28	114,00	60,50	-	1515	1742
292	132	045	LR	YY	00	26	1328	450	1950	1030	1,25	52,00	31,98	-	1012	1164
		060				26	1328	600	2444	1284	1,26	68,12	38,48	-	1178	1355
		100				26	1328	1000	3770	1961	1,28	118,56	62,92	-	1582	1819
292	137	045	LR	YY	00	27	1378	450	2025	1069	1,25	54,00	33,21	-	1038	1194
		060				27	1378	600	2538	1333	1,26	70,74	39,96	-	1207	1388
		100				27	1378	1000	3915	2036	1,28	123,12	65,34	-	1626	1870
292	142	045	LR	YY	00	28	1428	450	2100	1109	1,25	56,00	34,44	-	1059	1218
		060				28	1428	600	2632	1383	1,26	73,36	41,44	-	1237	1423
		100				28	1428	1000	4060	2111	1,28	127,68	67,76	-	1671	1922

Conform EN442-1: 2014: radiatoren en convectoren

* RAL 9016: geen meerprijs 15%

Voor meer details over onze artikel-data, zie artikel-database: <https://www.2ba.nl>

Voor de warmteafgiftes van andere regimes, kijkt u op p. 370 (correctiefactoren)
NEDERLAND. Prijzen in euro (excl. BTW)

VINTAGE (VINTAGE 50 / D220)

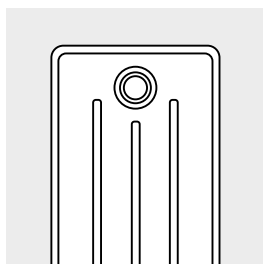

VINTAGE 50 / D220

HOE VINTAGE 50 BESTELLEN

Leveringstermijn 15 - 30 werkdagen
(zonder transportduur)

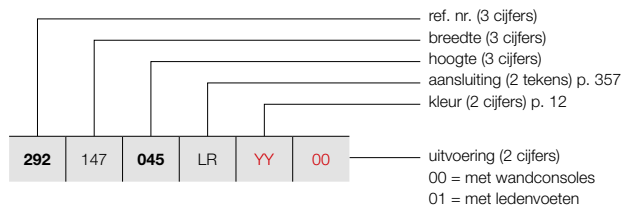

PRIJSGROEP: VPG5 - KOLOMRADIATOREN

BESTELCODE MAATWERK VINTAGE 50							TECHNISCHE GEGEVENS				STANDAARDKLEUR	ANDERE KLEUREN				
292	147	045	LR	YY	00	buizen	breedte (L mm)	hoogte (H mm)	75/65/20 (Watt) (Φ50K)	55/45/20 (Watt) (Φ30K)	n-exp.	gewicht (kg)	inhoud (l)	el. weerst. (Watt)	prijs S600* (€)	prijs kleur (€)
REF. NR. VINTAGE 50 VINTAGE 50/D220 : 292																
292	147	045	LR	YY	00	29	1478	450	2175	1149	1,25	58,00	35,67	-	1083	1245
		060				29	1478	600	2726	1432	1,26	75,98	42,92	-	1262	1451
		100				29	1478	1000	4205	2187	1,28	132,24	70,18	-	1717	1975
292	152	045	LR	YY	00	30	1528	450	2250	1188	1,25	60,00	36,90	-	1104	1270
		060				30	1528	600	2820	1482	1,26	78,60	44,40	-	1294	1488
		100				30	1528	1000	4350	2262	1,28	136,80	72,60	-	1762	2026
292	157	045	LR	YY	00	31	1578	450	2325	1228	1,25	62,00	38,13	-	1131	1301
		060				31	1578	600	2914	1531	1,26	81,22	45,88	-	1329	1528
292	162	045	LR	YY	00	32	1628	450	2400	1267	1,25	64,00	39,36	-	1155	1328
		060				32	1628	600	3008	1580	1,26	83,84	47,36	-	1357	1561
292	167	045	LR	YY	00	33	1678	450	2475	1307	1,25	66,00	40,59	-	1223	1406
		060				33	1678	600	3102	1630	1,26	86,46	48,84	-	1427	1641
292	172	045	LR	YY	00	34	1728	450	2550	1347	1,25	68,00	41,82	-	1246	1433
		060				34	1728	600	3196	1679	1,26	89,08	50,32	-	1457	1676
292	177	045	LR	YY	00	35	1778	450	2625	1386	1,25	70,00	43,05	-	1262	1451
		060				35	1778	600	3290	1728	1,26	91,70	51,80	-	1490	1714
292	182	045	LR	YY	00	36	1828	450	2700	1426	1,25	72,00	44,28	-	1294	1488
		060				36	1828	600	3384	1778	1,26	94,32	53,28	-	1524	1753
292	187	045	LR	YY	00	37	1878	450	2775	1465	1,25	74,00	45,51	-	1322	1520
		060				37	1878	600	3478	1827	1,26	96,36	54,76	-	1553	1786
292	192	045	LR	YY	00	38	1928	450	2850	1505	1,25	76,00	46,74	-	1342	1543
		060				38	1928	600	3572	1877	1,26	99,56	56,24	-	1583	1820
292	197	045	LR	YY	00	39	1978	450	2925	1545	1,25	78,00	47,97	-	1367	1572
		060				39	1978	600	3666	1926	1,26	102,18	57,72	-	1613	1855
292	202	045	LR	YY	00	40	2028	450	3000	1584	1,25	80,00	49,20	-	1389	1597
		060				40	2028	600	3760	1975	1,26	104,80	59,20	-	1645	1892
292	207	045	LR	YY	00	41	2078	450	3075	1624	1,25	82,00	50,43	-	1416	1628
		060				41	2078	600	3854	2025	1,26	107,42	60,68	-	1672	1923
292	212	045	LR	YY	00	42	2128	450	3150	1663	1,25	84,00	51,66	-	1437	1653
		060				42	2128	600	3948	2074	1,26	110,04	62,16	-	1702	1957
292	217	045	LR	YY	00	43	2178	450	3225	1703	1,25	86,00	52,89	-	1459	1678
		060				43	2178	600	4042	2124	1,26	112,66	63,64	-	1731	1991
292	222	045	LR	YY	00	44	2228	450	3300	1743	1,25	88,00	54,12	-	1485	1708
		060				44	2228	600	4136	2173	1,26	115,28	65,12	-	1764	2029

Conform EN442-1: 2014: radiatoren en convectoren

* RAL 9016: geen meerprijs 15%

Voor meer details over onze artikel-data, zie artikel-database: <https://www.2ba.nl>

Voor de warmteafgiftes van andere regimes, kijkt u op p. 370 (correctiefactoren)

NETERLAND. Prijzen in euro (excl. BTW)

HOE VINTAGE 50 BESTELLEN

Leveringstermijn 15 - 30 werkdagen
(zonder transportduur)

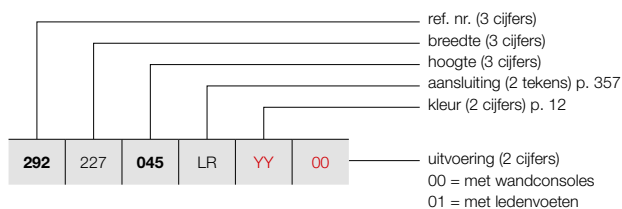

VINTAGE (VINTAGE 50 / D220)

353

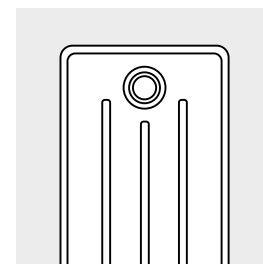

VINTAGE 50 / D220

PRIJSGROEP: VPG5 - KOLOMRADIATOREN

BESTELCODE MAATWERK VINTAGE 50	TECHNISCHE GEGEVENS							STANDAARDKLEUR		ANDERE KLEUREN						
	buizen	breedte (L mm)	hoogte (H mm)	75/65/20 (Watt) (Φ50K)	55/45/20 (Watt) (Φ30K)	n-exp.	gewicht (kg)	inhoud (l)	el. weerst. (Watt)	prijs S600* (€)	prijs kleur (€)					
REF. NR. VINTAGE 50 VINTAGE 50/D220 : 292																
292	227	045	LR	YY	00											
		060														
						45	2278	450	3375	1782	1,25	90,00	55,35	-	1506	1732
						45	2278	600	4230	2222	1,26	117,90	66,60	-	1791	2060
292	232	045	LR	YY	00											
		060														
						46	2328	450	3450	1822	1,25	93,84	56,58	-	1534	1764
						46	2328	600	4324	2272	1,26	120,52	68,08	-	1821	2094
292	237	045	LR	YY	00											
		060														
						47	2378	450	3525	1861	1,25	94,00	57,81	-	1553	1786
						47	2378	600	4418	2321	1,26	123,14	69,56	-	1853	2131
292	242	045	LR	YY	00											
		060														
						48	2428	450	3600	1901	1,25	96,00	59,04	-	1579	1816
						48	2428	600	4512	2370	1,26	125,76	71,04	-	1881	2163
292	247	045	LR	YY	00											
		060														
						49	2478	450	3675	1941	1,25	99,96	60,27	-	1601	1841
						49	2478	600	4606	2420	1,26	128,38	72,52	-	1909	2195
292	252	045	LR	YY	00											
		060														
						50	2528	450	3750	1980	1,25	102,00	61,50	-	1625	1869
						50	2528	600	4700	2469	1,26	131,00	74,00	-	1944	2236
292	257	045	LR	YY	00											
		060														
						51	2578	450	3825	2020	1,25	104,04	62,73	-	1668	1918
292	262	045	LR	YY	00											
		060														
						52	2628	450	3900	2059	1,25	106,08	63,96	-	1690	1944
292	267	045	LR	YY	00											
		060														
						53	2678	450	3975	2099	1,25	108,12	65,19	-	1714	1971
292	272	045	LR	YY	00											
		060														
						54	2728	450	4050	2139	1,25	110,16	66,42	-	1737	1998
292	277	045	LR	YY	00											
		060														
						55	2778	450	4125	2178	1,25	112,20	67,65	-	1761	2025
292	282	045	LR	YY	00											
		060														
						56	2828	450	4200	2218	1,25	114,24	68,88	-	1781	2048
292	287	045	LR	YY	00											
		060														
						57	2878	450	4275	2257	1,25	116,28	70,11	-	1808	2079
292	292	045	LR	YY	00											
		060														
						58	2928	450	4350	2297	1,25	118,32	71,34	-	1830	2105
292	297	045	LR	YY	00											
		060														
						59	2978	450	4425	2337	1,25	120,36	72,57	-	1855	2133
292	302	045	LR	YY	00											
		060														
						60	3028	450	4500	2376	1,25	122,40	73,80	-	1877	2159

Conform EN442-1: 2014: radiatoren en convectoren

* RAL 9016: geen meerprijs 15%

Voor meer details over onze artikel-data, zie artikel-database: <https://www.2ba.nl>

Voor de warmteafgiftes van andere regimes, kijkt u op p. 370 (correctiefactoren)
NETERLAND. Prijzen in euro (excl. BTW)

VINTAGE (VINTAGE 50 / D250)

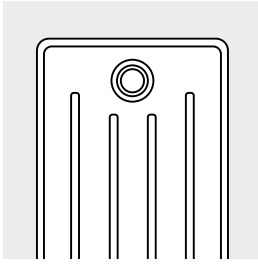

VINTAGE 50 / D250

HOE VINTAGE 50 BESTELLEN

Leveringstermijn 15 - 30 werkdagen
(zonder transportduur)

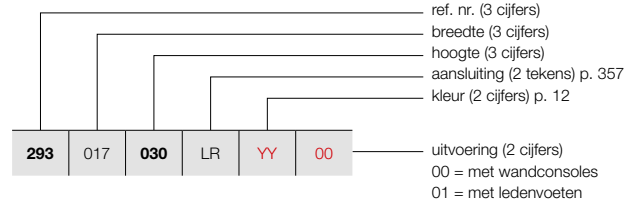

PRIJSGROEP: VPG5 - KOLOMRADIATOREN

BESTELCODE MAATWERK VINTAGE 50	TECHNISCHE GEGEVENS										STANDAARDKLEUR	ANDERE KLEUREN
	buizen	breedte (L mm)	hoogte (H mm)	75/65/20 (Watt) (Φ50K)	55/45/20 (Watt) (Φ30K)	n-exp.	gewicht (kg)	inhoud (l)	el. weerst. (Watt)	prijs S600* (€)	prijs kleur (€)	
REF. NR. VINTAGE 50 VINTAGE 50/D250 : 293												
293 017 030 LR YY 00	3	178	300	186	98	1,26	4,56	2,97	-	433	498	
293 022 030 LR YY 00	4	228	300	248	130	1,26	6,08	3,96	-	457	526	
293 027 030 LR YY 00	5	278	300	310	163	1,26	7,60	4,95	-	483	555	
293 032 030 LR YY 00	6	328	300	372	195	1,26	9,12	5,94	-	502	577	
293 037 030 LR YY 00	7	378	300	434	228	1,26	10,64	6,93	-	524	603	
293 042 030 LR YY 00	8	428	300	496	261	1,26	12,16	7,92	-	559	643	
293 047 030 LR YY 00	9	478	300	558	293	1,26	13,68	8,91	-	578	665	
293 052 030 LR YY 00	10	528	300	620	326	1,26	15,20	9,90	-	602	692	
293 057 030 LR YY 00	11	578	300	682	358	1,26	16,72	10,89	-	631	726	
293 062 030 LR YY 00	12	628	300	744	391	1,26	18,34	11,88	-	653	751	
293 067 030 LR YY 00	13	678	300	806	423	1,26	19,76	12,87	-	675	776	
293 072 030 LR YY 00	14	728	300	868	456	1,26	21,28	13,86	-	697	802	
293 077 030 LR YY 00	15	778	300	930	489	1,26	22,80	14,85	-	723	831	
293 082 030 LR YY 00	16	828	300	992	521	1,26	24,32	15,84	-	744	856	
293 087 030 LR YY 00	17	878	300	1054	554	1,26	25,84	16,83	-	766	881	
293 092 030 LR YY 00	18	928	300	1116	586	1,26	27,36	17,82	-	790	909	
293 097 030 LR YY 00	19	978	300	1178	619	1,26	28,88	18,81	-	812	934	
293 102 030 LR YY 00	20	1028	300	1240	651	1,26	30,40	19,80	-	833	958	
293 107 030 LR YY 00	21	1078	300	1302	684	1,26	31,92	20,79	-	872	1003	
293 112 030 LR YY 00	22	1128	300	1364	717	1,26	33,44	21,78	-	893	1027	
293 117 030 LR YY 00	23	1178	300	1426	749	1,26	34,96	22,77	-	919	1057	
293 122 030 LR YY 00	24	1228	300	1488	782	1,26	36,68	23,76	-	937	1078	
293 127 030 LR YY 00	25	1278	300	1550	814	1,26	38,00	24,75	-	963	1107	
293 132 030 LR YY 00	26	1328	300	1612	847	1,26	39,52	25,74	-	1006	1157	
293 137 030 LR YY 00	27	1378	300	1674	879	1,26	41,04	26,73	-	1030	1185	
293 142 030 LR YY 00	28	1428	300	1736	912	1,26	42,56	27,72	-	1052	1210	
293 147 030 LR YY 00	29	1478	300	1798	945	1,26	44,08	28,71	-	1075	1236	

Conform EN442-1: 2014: radiatoren en convectoren

* RAL 9016: geen meerprijs 15%

Voor meer details over onze artikel-data, zie artikel-database: <https://www.2ba.nl>

Voor de warmteafgiftes van andere regimes, kijkt u op p. 370 (correctiefactoren)
NETERLAND. Prijzen in euro (excl. BTW)

HOE VINTAGE 50 BESTELLEN

Leveringstermijn 15 - 30 werkdagen
(zonder transportduur)

VINTAGE (VINTAGE 50 / D250)

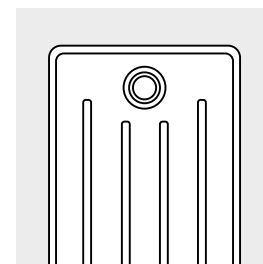
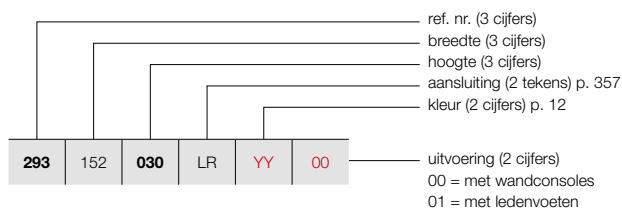

VINTAGE 50 / D250

PRIJSGROEP: VPG5 - KOLOMRADIATOREN

BESTELCODE MAATWERK VINTAGE 50	TECHNISCHE GEGEVENS										STANDAARDKLEUR	ANDERE KLEUREN
	buizen	breedte (L mm)	hoogte (H mm)	75/65/20 (Watt) (Φ50K)	55/45/20 (Watt) (Φ30K)	n-exp.	gewicht (kg)	inhoud (l)	el. weerst. (Watt)	prijs S600* (€)		
REF. NR. VINTAGE 50 VINTAGE 50/D250 : 293												
293 152 030 LR YY 00	30	1528	300	1860	977	1,26	45,60	29,70	-	1096	1260	
293 157 030 LR YY 00	31	1578	300	1922	1010	1,26	47,12	30,69	-	1120	1288	
293 162 030 LR YY 00	32	1628	300	1984	1042	1,26	48,64	31,68	-	1144	1316	
293 167 030 LR YY 00	33	1678	300	2046	1075	1,26	50,16	32,67	-	1208	1389	
293 172 030 LR YY 00	34	1728	300	2108	1107	1,26	51,68	33,66	-	1233	1418	
293 177 030 LR YY 00	35	1778	300	2170	1140	1,26	53,20	34,65	-	1254	1442	
293 182 030 LR YY 00	36	1828	300	2232	1173	1,26	55,02	35,64	-	1283	1475	
293 187 030 LR YY 00	37	1878	300	2294	1205	1,26	56,24	36,63	-	1305	1501	
293 192 030 LR YY 00	38	1928	300	2356	1238	1,26	57,76	37,62	-	1330	1530	
293 197 030 LR YY 00	39	1978	300	2418	1270	1,26	59,28	38,61	-	1347	1549	
293 202 030 LR YY 00	40	2028	300	2480	1303	1,26	60,80	39,60	-	1374	1580	
293 207 030 LR YY 00	41	2078	300	2542	1336	1,26	62,32	40,59	-	1397	1607	
293 212 030 LR YY 00	42	2128	300	2604	1368	1,26	63,84	41,58	-	1419	1632	
293 217 030 LR YY 00	43	2178	300	2666	1401	1,26	65,36	42,57	-	1444	1661	
293 222 030 LR YY 00	44	2228	300	2728	1433	1,26	66,88	43,56	-	1462	1681	
293 227 030 LR YY 00	45	2278	300	2790	1466	1,26	68,40	44,55	-	1489	1712	
293 232 030 LR YY 00	46	2328	300	2852	1498	1,26	69,92	45,54	-	1507	1733	
293 237 030 LR YY 00	47	2378	300	2914	1531	1,26	71,44	46,53	-	1534	1764	
293 242 030 LR YY 00	48	2428	300	2976	1564	1,26	73,36	47,52	-	1553	1786	
293 247 030 LR YY 00	49	2478	300	3038	1596	1,26	74,48	48,51	-	1575	1811	
293 252 030 LR YY 00	50	2528	300	3100	1629	1,26	76,00	49,50	-	1601	1841	
293 257 030 LR YY 00	51	2578	300	3162	1661	1,26	77,52	50,49	-	1648	1895	
293 262 030 LR YY 00	52	2628	300	3224	1694	1,26	79,04	51,48	-	1669	1919	
293 267 030 LR YY 00	53	2678	300	3286	1726	1,26	80,56	52,47	-	1691	1945	
293 272 030 LR YY 00	54	2728	300	3348	1759	1,26	82,08	53,46	-	1714	1971	
293 277 030 LR YY 00	55	2778	300	3410	1792	1,26	83,60	54,45	-	1737	1998	
293 282 030 LR YY 00	56	2828	300	3472	1824	1,26	85,12	55,44	-	1759	2023	

Conform EN442-1: 2014: radiatoren en convectoren

* RAL 9016: geen meerprijs 15%

Voor meer details over onze artikel-data, zie artikel-database: <https://www.2ba.nl>

Voor de warmteafgiftes van andere regimes, kijkt u op p. 370 (correctiefactoren)
 NEDERLAND. Prijzen in euro (excl. BTW)

VINTAGE (VINTAGE 50 / D250)

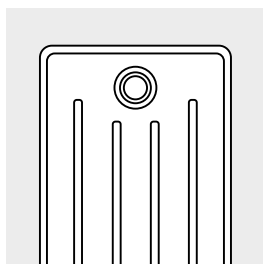

VINTAGE 50 / D250

HOE VINTAGE 50 BESTELLEN

Leveringstermijn 15 - 30 werkdagen
(zonder transportduur)

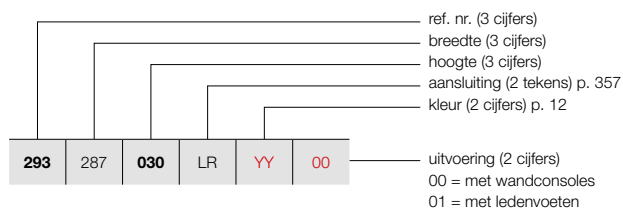

PRIJSGROEP: VPG5 - KOLOMRADIATOREN

BESTELCODE MAATWERK VINTAGE 50	TECHNISCHE GEGEVENS										STANDAARDKLEUR	ANDERE KLEUREN
	buizen	breedte (L mm)	hoogte (H mm)	75/65/20 (Watt) (Φ50K)	55/45/20 (Watt) (Φ30K)	n-exp.	gewicht (kg)	inhoud (l)	el. weerst. (Watt)	prijs S600* (€)	prijs kleur (€)	
REF. NR. VINTAGE 50 VINTAGE 50/D250 : 293												
293 287 030 LR YY 00	57	2878	300	3534	1857	1,26	86,64	56,43	-	1781	2048	
293 292 030 LR YY 00	58	2928	300	3596	1889	1,26	88,16	57,42	-	1805	2076	
293 297 030 LR YY 00	59	2978	300	3658	1922	1,26	89,68	58,41	-	1827	2101	
293 302 030 LR YY 00	60	3028	300	3720	1954	1,26	91,70	59,40	-	1850	2128	



Conform EN442-1: 2014: radiatoren en convectoren

* RAL 9016: geen meerprijs 15%

Voor meer details over onze artikel-data, zie artikel-database: <https://www.2ba.nl>

Voor de warmteafgiftes van andere regimes, kijkt u op p. 370 (correctiefactoren)
NEDERLAND. Prijzen in euro (excl. BTW)

PRIJSGROEP: VPG10 - ACC.

BEVESTIGINGEN		VINTAGE 50	KLEUR
WANDBEVESTIGING			in de kleur van de radiator*
LEDENVOETEN		VINTAGE 50 2 voeten voor 25 leden 3 voeten voor 50 leden 4 voeten voor 60 leden	in de kleur van de radiator*

* Voeten en bevestigingen voor radiatoren in transparante coating zijn gelakt in de kleur N507.

VINTAGE AANSLUITINGEN

VINTAGE: VINTAGE 50

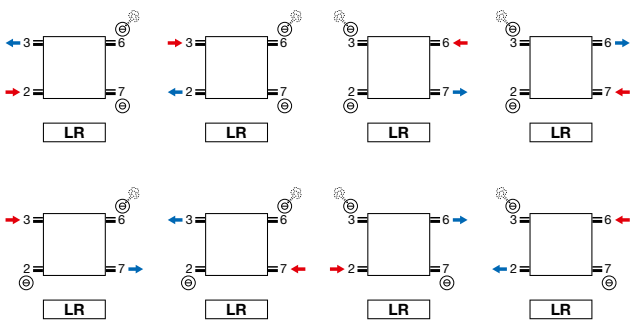

- Ontluchter in aansluiting 3 of 6.

VINTAGE: VINTAGE 50

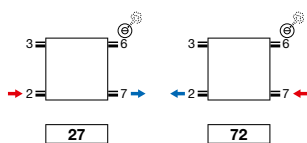

- Ontluchter in aansluiting 3 of 6.
- Aansluitingen op speciale aanvraag: meerprijs €88

Opmerking: het aansluiten van de radiator kan enkel volgens de getoonde aansluiticonen. Voor elke andere aansluitwijze nemen wij geen verantwoordelijkheid.

VINTAGE (VINTAGE 50)

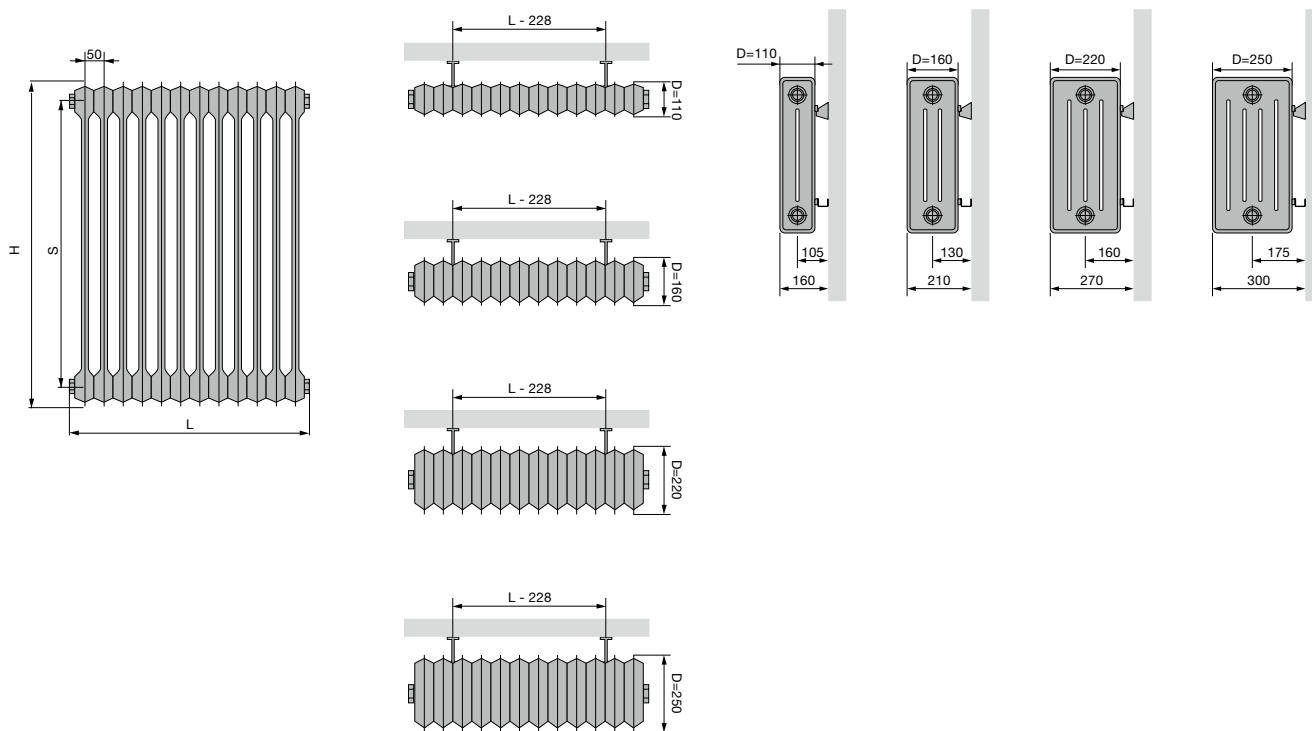

VINTAGE 50

Hoogte (H)	300	450	600	1000
Hartafstand tussen de zijaansluitingen (S)	200	350	500	900

VINTAGE (VINTAGE 50)

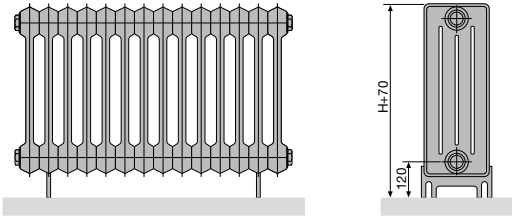

VINTAGE 50 (VLOERMONTAGE)

Aantal leden	2-25	26-50	51-60
Aantal voeten	2	3	4

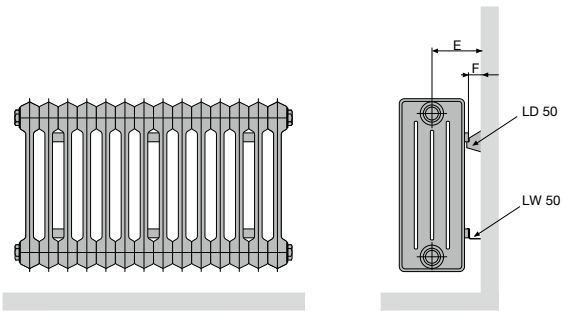

VINTAGE 50 (WANDMONTAGE) LD 50 + LW 50

Diepte (D)	110	160	220	250
Afstand tussen wand en aansluiting (E)	105	130	160	175
Afstand tussen wand en achterkant radiator (F)	50			

VINTAGE 50 (WANDMONTAGE)

Aantal leden	3-5	6-25	26-50	51-60
Aantal muurbevestigingen set LD 50 + LW 50	1	2	3	4

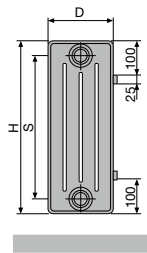

VINTAGE 50

Hoogte (H)	300	450	600	1000
Hartafstand tussen de zijansluitingen (S)	200	350	500	900

