



Kolomradiatoren

## Een klassieker met kracht.

De VASCO kolomradiator combineert een hoog vermogen met een snelle en efficiënte warmteafgifte.

Hij levert uitstekende prestaties, ook in combinatie met lage watertemperatuursystemen zoals warmtepompen — een retro ontwerp in de meest duurzame zin van het woord.

Tot in het kleinste detail afgestemd op zuinig energieverbruik, met slimme aansluitingen, doordachte bevestigingssystemen en innovatieve technologische oplossingen.

Een tijdloze klassieker die kracht, comfort en efficiëntie moeiteloos verenigt.

---

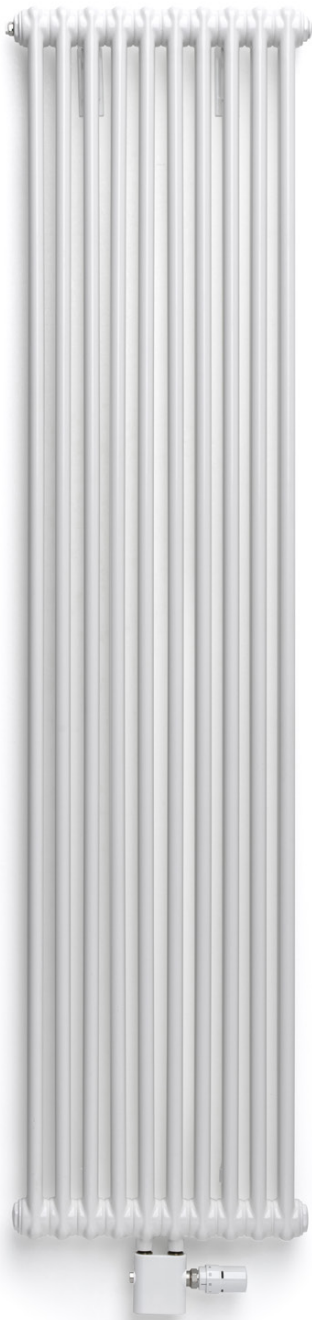

## RITMO VERTICAAL

### Hoge warmteafgifte

Met hun hoge warmteafgifte brengen VASCO's Ritmo-kolomradiatoren zelfs de grootste ruimtes in een mum van tijd op de gewenste temperatuur, zonder dat je dat merkt aan je energiefactuur. Door hun groot verwarmingsoppervlak zijn ze uitermate geschikt voor lage temperatuurverwarming. Zo geniet je van aangename temperaturen en een comfortabel binnenklimaat.

### TYPES

- 2 / 3 / 4 kolommen
- Bouwdiepte: 65 / 105 / 145 mm
- Bouwhoogte: 1500, 1800, 2000, 2200 mm
- Bouwlengte: 270, 360, 450, 540, 630, 720 mm

### BUIZEN

- Verticaal, 25 mm

### KLEUREN

- Standaardkleur wit RAL 9016
- Uitgebreide kleurenkaart zie p. 12

### BEVESTIGINGEN

- Wandmontage
- Muurbevestigingen standaard
- Bij witte radiatoren wordt standaard een witte klemconsole 30 mm en een witte afstandshouder geleverd
- Bij gekleurde radiatoren wordt standaard een klemconsole 30 mm in de kleur van de radiator en een afstandshouder in RAL 7024 geleverd

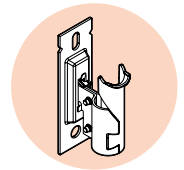

### TECHNISCH

- Bestaande uit kopstukken (bandstaal persdelen) en ronde buizen.
- ATL-grondlaag, poedercoating
- Standaardwerkdruk: 10 bar
- Maximale bedrijfstemperatuur: 110°C

### TECHNISCHE TEKENINGEN

- Zie p. 340

### AANSLUITING

- ✗ Eénpuntsaansluiting voor éénpijpsysteem
- ✗ Eénpuntsaansluiting voor tweepijpsysteem
- ✓ Tweepuntsaansluiting voor éénpijpsysteem (aansluiting via de middenaansluiting) (zie p. 362)
- ✓ Tweepuntsaansluiting voor tweepijpsysteem (standaard) (zie p. 362)
- ✗ Geïntegreerd ventiel
- Aansluitingen: ½" (binnendraad)

### AANBEVOLEN AANSLUITING (MM)

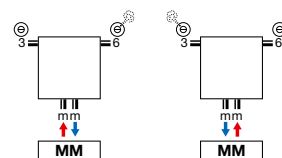

Andere aansluitmogelijkheden, zie p. 339

### AANBEVOLEN VOOR BADKAMER EN KEUKEN IN OPTIE



handdoekbeugel (chrom) art. nr. zie p. 338  
prijs € 150

**NEW**



**Ventielset haaks kleur**  
art. nr. 1182 105 0000 9016  
**prijs €201**  
Andere kleuren, zie p. 366  
Koppelingen, zie p. 380



**Thermostaatkop**  
Traffic White  
art. nr.  
1182 030 0000 9016  
**prijs €40**



## HOE RITMO VERTICAAL BESTELLEN

Leveringstermijn 15 - 30 werkdagen  
(zonder transportduur)

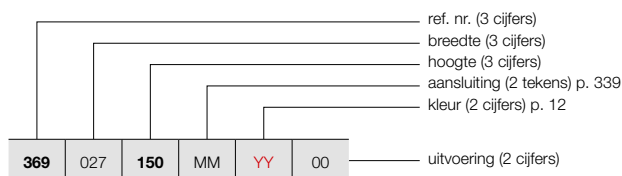

## RITMO VERTICAAL (2-KOLOM)

325



RITMO VB-2K/65  
(2-KOLOM)

### PRIJSGROEP: VPG5 - KOLOMRADIATOREN

BESTELCODE MAATWERK RITMO VERTICAAL	TECHNISCHE GEGEVENS								STANDAARDKLEUR		ANDERE KLEUREN					
	buizen	breedte (L mm)	hoogte (H mm)	75/65/20 (Watt) (φ50K)	55/45/20 (Watt) (φ30K)	n-exp.	gewicht (kg)	inhoud (l)	el. weerst. (Watt)	prijs RAL 9016 (€)	prijs kleur (€)					
<b>REF. NR. RITMO VERTICAAL VB-2K/65 : 369</b>																
<b>369</b>	027	150	MM	YY	00	6	270	1500	654	333	1,32	11,58	7,92	-	<b>427</b>	<b>491</b>
		180				6	270	1800	780	397	1,32	13,74	9,36	-	<b>482</b>	<b>554</b>
		200				6	270	2000	864	440	1,32	15,18	10,32	-	<b>540</b>	<b>621</b>
		220				6	270	2200	948	483	1,32	16,68	11,28	-	<b>718</b>	<b>826</b>
<b>369</b>	036	150	MM	YY	00	8	360	1500	872	444	1,32	15,44	10,56	-	<b>505</b>	<b>581</b>
		180				8	360	1800	1040	530	1,32	18,32	12,48	-	<b>570</b>	<b>656</b>
		200				8	360	2000	1152	587	1,32	20,24	13,76	-	<b>635</b>	<b>730</b>
		220				8	360	2200	1264	644	1,32	22,24	15,04	-	<b>806</b>	<b>927</b>
<b>369</b>	045	150	MM	YY	00	10	450	1500	1090	555	1,32	19,30	13,20	-	<b>581</b>	<b>668</b>
		180				10	450	1800	1300	662	1,32	22,90	15,60	-	<b>664</b>	<b>764</b>
		200				10	450	2000	1440	734	1,32	25,30	17,20	-	<b>713</b>	<b>820</b>
		220				10	450	2200	1580	805	1,32	27,80	18,80	-	<b>896</b>	<b>1030</b>
<b>369</b>	054	150	MM	YY	00	12	540	1500	1308	666	1,32	23,16	15,84	-	<b>679</b>	<b>781</b>
		180				12	540	1800	1560	795	1,32	27,48	18,72	-	<b>767</b>	<b>882</b>
		200				12	540	2000	1728	880	1,32	30,36	20,64	-	<b>844</b>	<b>971</b>
		220				12	540	2200	1896	966	1,32	33,36	22,56	-	<b>981</b>	<b>1128</b>
<b>369</b>	063	150	MM	YY	00	14	630	1500	1526	778	1,32	27,02	18,48	-	<b>779</b>	<b>896</b>
		180				14	630	1800	1820	927	1,32	32,06	21,84	-	<b>872</b>	<b>1003</b>
		200				14	630	2000	2016	1027	1,32	35,42	24,08	-	<b>976</b>	<b>1122</b>
		220				14	630	2200	2212	1127	1,32	38,92	26,32	-	<b>1070</b>	<b>1231</b>
<b>369</b>	072	150	MM	YY	00	16	720	1500	1744	889	1,32	30,88	21,12	-	<b>877</b>	<b>1009</b>
		180				16	720	1800	2080	1060	1,32	36,64	24,96	-	<b>981</b>	<b>1128</b>
		200				16	720	2000	2304	1174	1,32	40,48	27,52	-	<b>1086</b>	<b>1249</b>
		220				16	720	2200	2528	1288	1,32	44,48	30,08	-	<b>1156</b>	<b>1329</b>

Conform EN442-1: 2014: radiatoren en convectoren

Voor meer details over onze artikel-data, zie artikel-database: <https://www.2ba.nl>

**Voor de warmteafgifte van andere regimes, kijkt u op p. 370 (correctiefactoren)**  
**NEDERLAND. Prijzen in euro (excl. BTW)**

# RITMO VERTICAAL (3-KOLOM)

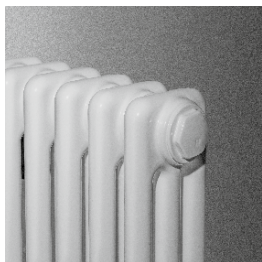

RITMO VB-3K/105  
(3-KOLOM)

## HOE RITMO VERTICAAL BESTELLEN

Leveringstermijn 15 - 30 werkdagen  
(zonder transportduur)

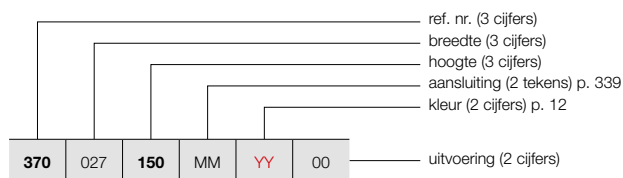

### PRIJSGROEP: VPG5 - KOLOMRADIATOREN

BESTELCODE MAATWERK RITMO VERTICAAL	TECHNISCHE GEGEVENS									STANDAARDKLEUR	ANDERE KLEUREN
	buizen	breedte (L mm)	hoogte (H mm)	75/65/20 (Watt) (Φ50K)	55/45/20 (Watt) (Φ30K)	n-exp.	gewicht (kg)	inhoud (l)	el. weerst. (Watt)	prijs RAL 9016 (€)	prijs kleur (€)
<b>REF. NR. RITMO VERTICAAL VB-3K/105 : 370</b>											
<b>370</b>	<b>027</b>	<b>150</b>	<b>MM</b>	<b>YY</b>	<b>00</b>						
		<b>180</b>								<b>559</b>	<b>643</b>
		<b>200</b>								<b>646</b>	<b>743</b>
		<b>220</b>								<b>659</b>	<b>758</b>
										<b>786</b>	<b>904</b>
<b>370</b>	<b>036</b>	<b>150</b>	<b>MM</b>	<b>YY</b>	<b>00</b>						
		<b>180</b>								<b>657</b>	<b>756</b>
		<b>200</b>								<b>766</b>	<b>881</b>
		<b>220</b>								<b>803</b>	<b>923</b>
										<b>927</b>	<b>1066</b>
<b>370</b>	<b>045</b>	<b>150</b>	<b>MM</b>	<b>YY</b>	<b>00</b>						
		<b>180</b>								<b>751</b>	<b>864</b>
		<b>200</b>								<b>877</b>	<b>1009</b>
		<b>220</b>								<b>926</b>	<b>1065</b>
										<b>1077</b>	<b>1239</b>
<b>370</b>	<b>054</b>	<b>150</b>	<b>MM</b>	<b>YY</b>	<b>00</b>						
		<b>180</b>								<b>877</b>	<b>1009</b>
		<b>200</b>								<b>1042</b>	<b>1198</b>
		<b>220</b>								<b>1090</b>	<b>1254</b>
										<b>1260</b>	<b>1449</b>
<b>370</b>	<b>063</b>	<b>150</b>	<b>MM</b>	<b>YY</b>	<b>00</b>						
		<b>180</b>								<b>1008</b>	<b>1159</b>
		<b>200</b>								<b>1170</b>	<b>1346</b>
		<b>220</b>								<b>1235</b>	<b>1420</b>
										<b>1410</b>	<b>1622</b>
<b>370</b>	<b>072</b>	<b>150</b>	<b>MM</b>	<b>YY</b>	<b>00</b>						
		<b>180</b>								<b>1123</b>	<b>1291</b>
		<b>200</b>								<b>1328</b>	<b>1527</b>
		<b>220</b>								<b>1362</b>	<b>1566</b>
										<b>1574</b>	<b>1810</b>

Conform EN442-1: 2014: radiatoren en convectoren

Voor meer details over onze artikel-data, zie artikel-database: <https://www.2ba.nl>

**Voor de warmteafgiftes van andere regimes, kijkt u op p. 370 (correctiefactoren)**  
**NEDERLAND. Prijzen in euro (excl. BTW)**

## HOE RITMO VERTICAAL BESTELLEN

Leveringstermijn 15 - 30 werkdagen  
(zonder transportduur)

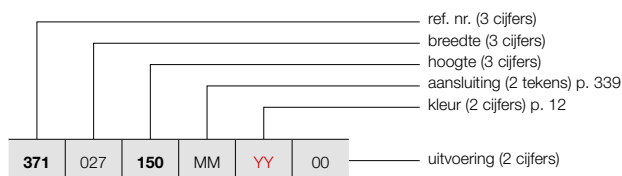

## RITMO VERTICAAL (4-KOLOM)

327



RITMO VB-4K/145  
(4-KOLOM)

### PRIJSGROEP: VPG5 - KOLOMRADIATOREN

BESTELCODE MAATWERK RITMO VERTICAAL	TECHNISCHE GEGEVENS								STANDAARDKLEUR	ANDERE KLEUREN	
	buizen	breedte (L mm)	hoogte (H mm)	75/65/20 (Watt) (Φ50K)	55/45/20 (Watt) (Φ30K)	n-exp.	gewicht (kg)	inhoud (l)			el. weerst. (Watt)
<b>REF. NR. RITMO VERTICAAL VB-4K/145 : 371</b>											
371 027 150 MM YY 00	6	270	1500	1116	560	1,35	23,10	15,60	-	681	783
	6	270	1800	1314	663	1,34	27,48	18,48	-	818	941
	6	270	2000	1446	729	1,34	30,36	20,40	-	868	998
	6	270	2200	1572	793	1,34	33,30	22,32	-	1050	1208
371 036 150 MM YY 00	8	360	1500	1488	747	1,35	30,80	20,80	-	804	925
	8	360	1800	1752	884	1,34	36,64	24,64	-	974	1120
	8	360	2000	1928	972	1,34	40,48	27,20	-	1044	1201
	8	360	2200	2096	1057	1,34	44,40	29,76	-	1212	1394
371 045 150 MM YY 00	10	450	1500	1860	933	1,35	38,50	26,00	-	932	1072
	10	450	1800	2190	1105	1,34	45,80	30,80	-	1093	1257
	10	450	2000	2410	1215	1,34	50,60	34,00	-	1216	1398
	10	450	2200	2620	1321	1,34	55,50	37,20	-	1370	1576
371 054 150 MM YY 00	12	540	1500	2232	1120	1,35	46,20	31,20	-	1084	1247
	12	540	1800	2628	1325	1,34	54,96	36,96	-	1243	1429
	12	540	2000	2892	1459	1,34	60,72	40,80	-	1496	1720
	12	540	2200	3144	1586	1,34	66,60	44,64	-	1589	1827
371 063 150 MM YY 00	14	630	1500	2604	1307	1,35	53,90	36,40	-	1248	1435
	14	630	1800	3066	1546	1,34	64,12	43,12	-	1464	1684
	14	630	2000	3374	1702	1,34	70,84	47,60	-	1688	1941
	14	630	2200	3668	1850	1,34	77,70	52,08	-	1863	2142
371 072 150 MM YY 00	16	720	1500	2976	1493	1,35	61,60	41,60	-	1384	1592
	16	720	1800	3504	1767	1,34	73,28	49,28	-	1723	1981
	16	720	2000	3856	1945	1,34	80,96	54,40	-	1925	2214
	16	720	2200	4192	2114	1,34	88,80	59,52	-	2095	2409

Conform EN442-1: 2014: radiatoren en convectoren

Voor meer details over onze artikel-data, zie artikel-database: <https://www.2ba.nl>

**Voor de warmteafgifte van andere regimes, kijkt u op p. 370 (correctiefactoren)**  
**NEDERLAND. Prijzen in euro (excl. BTW)**

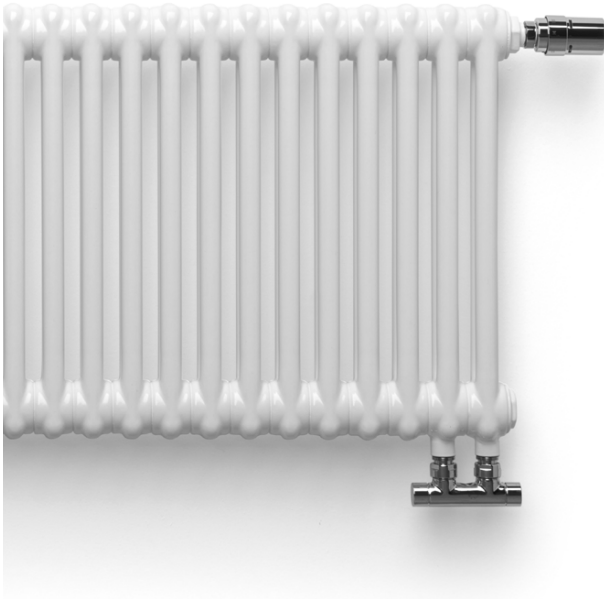

#### TYPES

- 2 / 3 / 4 kolommen
- Bouwdiepte: 65 / 105 / 145 mm
- Bouwhoogte: 300, 400, 500, 600, 900 mm
- Bouwlengte: 450, 540, 630, 720, 810, 900, 990, 1080, 1170, 1260, 1350, 1440, 1530, 1620, 1710, 1800 mm

#### BUIZEN

- Verticaal, 25 mm

#### KLEUREN

- Standaardkleur wit RAL 9016
- Uitgebreide kleurenkaart zie p. 12

#### BEVESTIGINGEN

- Vloer- of wandmontage
- Muurbevestigingen standaard
- Bij witte radiatoren wordt standaard een witte klemconsole 30 mm en een witte afstandshouder geleverd
- Bij gekleurde radiatoren wordt standaard een klemconsole 30 mm in de kleur van de radiator en een afstandshouder in RAL 7024 geleverd

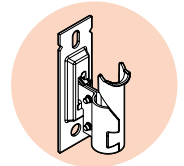

#### TECHNISCH

- Bestaande uit kopstukken (bandstaal persdelen) en ronde buizen.
- ATL-grondlaag, poedercoating
- Standaardwerkdruk: 10 bar
- Maximale bedrijfstemperatuur: 110°C

#### TECHNISCHE TEKENINGEN

- Zie p. 340

#### AANSLUITING

- ✗ Eénpuntsaansluiting voor éénpijpssysteem
- ✗ Eénpuntsaansluiting voor tweepijpssysteem
- ✓ Tweepuntsaansluiting voor éénpijpssysteem (aansluiting via het geïntegreerd ventiel) (zie p. 363)
- ✓ Tweepuntsaansluiting voor tweepijpssysteem (standaard) (zie p. 362)
- ✓ Geïntegreerd ventiel (aansluiting VR) (**meerprijs: €85**) (thermostaatkop apart te bestellen, zie p. 338)
- Aansluitingen: 1/2" (binnendraad)

## RITMO HORIZONTAAL

### Van klassiek tot modern

Het authentieke karakter van de Ritmo-kolomradiator is voor heel wat design-liefhebbers een schot in de roos. Omdat ze in hoge hoogtematen beschikbaar zijn, komen deze designradiatoren optimaal tot hun recht in grote, hoge en open interieurs, van klassieke herenhuisen tot moderne industriële lofts. Deze radiatoren worden ook vaak toegepast in openbare ruimtes, aangezien ze met hun relatief brede openingen makkelijk te reinigen en dus erg onderhoudsvriendelijk zijn. Met hun karakteristieke retro-uitstraling zijn deze kolomradiatoren in vele uitvoeringen beschikbaar: in horizontale of verticale variant en in 2, 3 of 4 kolommen.

#### AANBEVOLEN AANSLUITING GEÏNTEGREERD VENTIEL

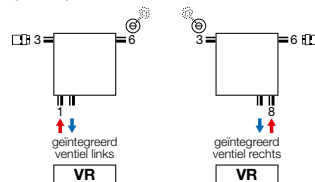

Andere aansluitmogelijkheden, zie p. 339



art. nr. 118230100000099  
prijs € 173

#### AANBEVOLEN VOOR BADKAMER EN KEUKEN IN OPTIE



handdoekbeugel (chrom) art. nr. zie p. 338  
prijs € 150



wit art. nr. 11911630102  
prijs € 54



chrom art. nr. 11911631102  
prijs € 69



HOE RITMO HORIZONTAAL BESTELLEN

Leveringstermijn 15 - 30 werkdagen  
(zonder transportduur)

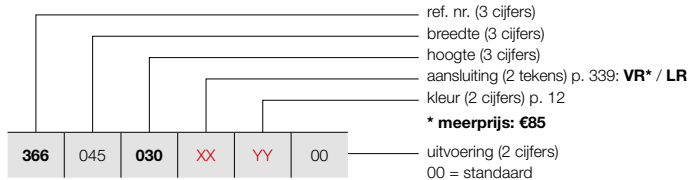

RITMO HORIZONTAAL (2-KOLOM)



RITMO HB-2K/65  
(2-KOLOM) 4-AANSLUITINGEN

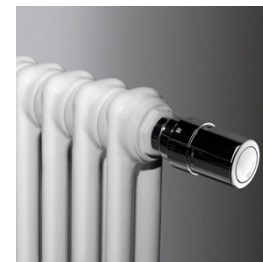

RITMO HB-2K/65  
(2-KOLOM) GEÏNTEGREERD VENTIEL  
(thermostaatkop apart te bestellen)

PRIJSGROEP: VPG5 - KOLOMRADIATOREN

BESTELCODE MAATWERK RITMO HORIZONTAAL	TECHNISCHE GEGEVENS							STANDAARDKLEUR		ANDERE KLEUREN	
	buizen	breedte (L mm)	hoogte (H mm)	75/65/20 (Watt) (φ50K)	55/45/20 (Watt) (φ30K)	n-exp.	gewicht (kg)	inhoud (l)	el. weerst. (Watt)	prijs RAL 9016 (€)	prijs kleur (€)
REF. NR. RITMO HORIZONTAAL HB-2K/65 : 366											
366 045 030 XX YY 00	10	450	300	240	126	1,26	4,70	3,70	-	296	340
	10	450	400	310	159	1,31	5,90	4,50	-	307	353
	10	450	500	390	200	1,31	7,10	5,30	-	318	366
	10	450	600	460	123	1,31	8,30	6,10	-	329	378
	10	450	900	670	343	1,31	12,00	8,40	-	365	420
	10	450	900	670	343	1,31	12,00	8,40	-	365	420
366 054 030 XX YY 00	12	540	300	288	151	1,26	5,64	4,44	-	351	404
	12	540	400	372	191	1,31	7,08	5,40	-	362	416
	12	540	500	468	240	1,31	8,52	6,36	-	373	429
	12	540	600	552	147	1,31	9,96	7,32	-	384	442
	12	540	900	804	412	1,31	14,40	10,08	-	420	483
366 063 030 XX YY 00	14	630	300	336	177	1,26	6,58	5,18	-	417	480
	14	630	400	434	222	1,31	8,26	6,30	-	427	491
	14	630	500	546	280	1,31	9,94	7,42	-	439	505
	14	630	600	644	172	1,31	11,62	8,54	-	449	516
	14	630	900	938	480	1,31	16,80	11,76	-	486	559
366 072 030 XX YY 00	16	720	300	384	202	1,26	7,52	5,92	-	483	555
	16	720	400	496	254	1,31	9,44	7,20	-	493	567
	16	720	500	624	320	1,31	11,36	8,48	-	505	581
	16	720	600	736	197	1,31	13,28	9,76	-	515	592
	16	720	900	1072	549	1,31	19,20	13,44	-	552	635
366 081 030 XX YY 00	18	810	300	432	227	1,26	8,46	6,66	-	549	631
	18	810	400	558	286	1,31	10,62	8,10	-	559	643
	18	810	500	702	360	1,31	12,78	9,54	-	570	656
	18	810	600	828	221	1,31	14,94	10,98	-	581	668
	18	810	900	1206	618	1,31	21,60	15,12	-	618	711
366 090 030 XX YY 00	20	900	300	480	252	1,26	9,40	7,40	-	591	680
	20	900	400	620	318	1,31	11,80	9,00	-	603	693
	20	900	500	780	399	1,31	14,20	10,60	-	613	705
	20	900	600	920	246	1,31	16,60	12,20	-	625	719
	20	900	900	1340	686	1,31	24,00	16,80	-	661	760
366 099 030 XX YY 00	22	990	300	528	277	1,26	10,34	8,14	-	625	719
	22	990	400	682	349	1,31	12,98	9,90	-	635	730
	22	990	500	858	439	1,31	15,62	11,66	-	647	744
	22	990	600	1012	270	1,31	18,26	13,42	-	657	756
	22	990	900	1474	755	1,31	26,40	18,48	-	694	798
366 108 030 XX YY 00	24	1080	300	576	303	1,26	11,28	8,88	-	657	756
	24	1080	400	744	381	1,31	14,16	10,80	-	669	769
	24	1080	500	936	479	1,31	17,04	12,72	-	679	781
	24	1080	600	1104	295	1,31	19,92	14,64	-	691	795
	24	1080	900	1608	824	1,31	28,80	20,16	-	726	835

Conform EN442-1: 2014: radiatoren en convectoren

Voor meer details over onze artikel-data, zie artikel-database: <https://www.2ba.nl>

Voor de warmteafgiftes van andere regimes, kijkt u op p. 370 (correctiefactoren)  
NEDERLAND. Prijzen in euro (excl. BTW)

# RITMO HORIZONTAAL (2-KOLOM)



RITMO HB-2K/65  
(2-KOLOM) 4-AANSLUITINGEN



RITMO HB-2K/65  
(2-KOLOM) GEÏNTEGREERD VENTIEL  
(thermostaatkop apart te bestellen)

## HOE RITMO HORIZONTAAL BESTELLEN

Leveringstermijn 15 - 30 werkdagen  
(zonder transportduur)

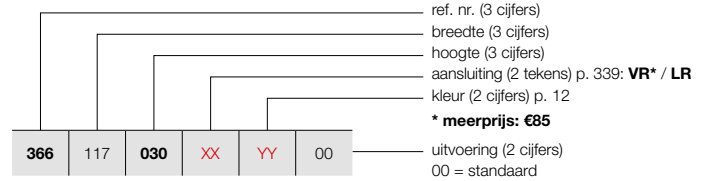

## PRIJSGROEP: VPG5 - KOLOMRADIATOREN

BESTELCODE MAATWERK RITMO HORIZONTAAL	TECHNISCHE GEGEVENS									STANDAARDKLEUR	ANDERE KLEUREN
	buizen	breedte (L mm)	hoogte (H mm)	75/65/20 (Watt) (Φ50K)	55/45/20 (Watt) (Φ30K)	n-exp.	gewicht (kg)	inhoud (l)	el. weerst. (Watt)	prijs RAL 9016 (€)	prijs kleur (€)
<b>REF. NR. RITMO HORIZONTAAL HB-2K/65 : 366</b>											
<b>366</b>	<b>117</b>	<b>030</b>	<b>XX</b>	<b>YY</b>	<b>00</b>						
		<b>040</b>								<b>718</b>	<b>826</b>
		<b>050</b>								<b>729</b>	<b>838</b>
		<b>060</b>								<b>740</b>	<b>851</b>
		<b>090</b>								<b>751</b>	<b>864</b>
										<b>787</b>	<b>905</b>
<b>366</b>	<b>126</b>	<b>030</b>	<b>XX</b>	<b>YY</b>	<b>00</b>						
		<b>040</b>								<b>779</b>	<b>896</b>
		<b>050</b>								<b>789</b>	<b>907</b>
		<b>060</b>								<b>800</b>	<b>920</b>
		<b>090</b>								<b>811</b>	<b>933</b>
										<b>847</b>	<b>974</b>
<b>366</b>	<b>135</b>	<b>030</b>	<b>XX</b>	<b>YY</b>	<b>00</b>						
		<b>040</b>								<b>844</b>	<b>971</b>
		<b>050</b>								<b>855</b>	<b>983</b>
		<b>060</b>								<b>866</b>	<b>996</b>
		<b>090</b>								<b>877</b>	<b>1009</b>
										<b>913</b>	<b>1050</b>
<b>366</b>	<b>144</b>	<b>030</b>	<b>XX</b>	<b>YY</b>	<b>00</b>						
		<b>040</b>								<b>910</b>	<b>1047</b>
		<b>050</b>								<b>921</b>	<b>1059</b>
		<b>060</b>								<b>932</b>	<b>1072</b>
		<b>090</b>								<b>943</b>	<b>1084</b>
										<b>979</b>	<b>1126</b>
<b>366</b>	<b>153</b>	<b>030</b>	<b>XX</b>	<b>YY</b>	<b>00</b>						
		<b>040</b>								<b>976</b>	<b>1122</b>
		<b>050</b>								<b>986</b>	<b>1134</b>
		<b>060</b>								<b>998</b>	<b>1148</b>
		<b>090</b>								<b>1008</b>	<b>1159</b>
										<b>1045</b>	<b>1202</b>
<b>366</b>	<b>162</b>	<b>030</b>	<b>XX</b>	<b>YY</b>	<b>00</b>						
		<b>040</b>								<b>1042</b>	<b>1198</b>
		<b>050</b>								<b>1052</b>	<b>1210</b>
		<b>060</b>								<b>1064</b>	<b>1224</b>
		<b>090</b>								<b>1074</b>	<b>1235</b>
										<b>1111</b>	<b>1278</b>
<b>366</b>	<b>171</b>	<b>030</b>	<b>XX</b>	<b>YY</b>	<b>00</b>						
		<b>040</b>								<b>1107</b>	<b>1273</b>
		<b>050</b>								<b>1118</b>	<b>1286</b>
		<b>060</b>								<b>1129</b>	<b>1298</b>
		<b>090</b>								<b>1140</b>	<b>1311</b>
										<b>1177</b>	<b>1354</b>
<b>366</b>	<b>180</b>	<b>030</b>	<b>XX</b>	<b>YY</b>	<b>00</b>						
		<b>040</b>								<b>1172</b>	<b>1348</b>
		<b>050</b>								<b>1184</b>	<b>1362</b>
		<b>060</b>								<b>1194</b>	<b>1373</b>
		<b>090</b>								<b>1206</b>	<b>1387</b>
										<b>1243</b>	<b>1429</b>

Conform EN442-1: 2014: radiatoren en convectoren

Voor meer details over onze artikel-data, zie artikel-database: <https://www.2ba.nl>

Voor de warmteafgiftes van andere regimes, kijkt u op p. 370 (correctiefactoren)  
NEDERLAND. Prijzen in euro (excl. BTW)

## HOE RITMO HORIZONTAAL BESTELLEN

Leveringstermijn 15 - 30 werkdagen  
(zonder transportduur)

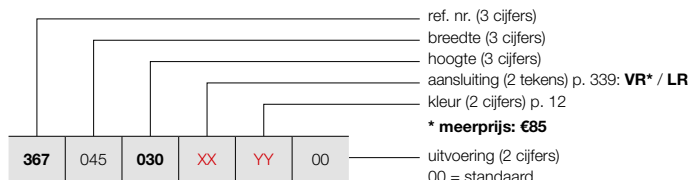

## RITMO HORIZONTAAL (3-KOLOM)

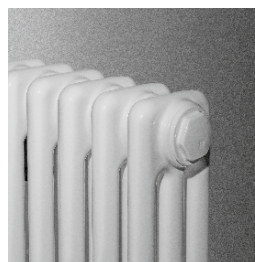

RITMO HB-3K/105  
(3-KOLOM) 4-AANSLUITINGEN



RITMO HB-3K/105  
(3-KOLOM) GEÏNTEGREERD VENTIEL  
(thermostaatkop apart te bestellen)

### PRIJSGROEP: VPG5 - KOLOMRADIATOREN

BESTELCODE MAATWERK RITMO HORIZONTAAL	TECHNISCHE GEGEVENS							STANDAARDKLEUR		ANDERE KLEUREN	
	buizen	breedte (L mm)	hoogte (H mm)	75/65/20 (Watt) (φ50K)	55/45/20 (Watt) (φ30K)	n-exp.	gewicht (kg)	inhoud (l)	el. weerst. (Watt)	prijs RAL 9016 (€)	prijs kleur (€)
<b>REF. NR. RITMO HORIZONTAAL HB-3K/105 : 367</b>											
367 045 030 XX YY 00	10	450	300	330	167	1,33	7,00	5,30	-	346	398
	10	450	400	430	215	1,36	8,80	6,50	-	357	411
	10	450	500	530	265	1,36	10,60	7,70	-	368	423
	10	450	600	630	315	1,36	12,50	8,90	-	379	436
	10	450	900	920	459	1,36	17,90	12,50	-	433	498
	10	450	900	920	459	1,36	17,90	12,50	-	433	498
367 054 030 XX YY 00	12	540	300	396	201	1,33	8,40	6,36	-	403	463
	12	540	400	516	258	1,36	10,56	7,80	-	415	477
	12	540	500	636	258	1,36	12,72	9,24	-	425	489
	12	540	600	756	377	1,36	15,00	10,68	-	437	503
	12	540	900	1104	551	1,36	21,48	15,00	-	488	561
	12	540	900	1104	551	1,36	21,48	15,00	-	488	561
367 063 030 XX YY 00	14	630	300	462	234	1,33	9,80	7,42	-	461	530
	14	630	400	602	301	1,36	12,32	9,10	-	471	542
	14	630	500	742	301	1,36	14,84	10,78	-	483	555
	14	630	600	882	440	1,36	17,50	12,46	-	493	567
	14	630	900	1288	643	1,36	25,06	17,50	-	549	631
	14	630	900	1288	643	1,36	25,06	17,50	-	549	631
367 072 030 XX YY 00	16	720	300	528	268	1,33	11,20	8,48	-	524	603
	16	720	400	688	343	1,36	14,08	10,40	-	535	615
	16	720	500	848	343	1,36	16,96	12,32	-	545	627
	16	720	600	1008	503	1,36	20,00	14,24	-	557	641
	16	720	900	1472	735	1,36	28,64	20,00	-	623	716
	16	720	900	1472	735	1,36	28,64	20,00	-	623	716
367 081 030 XX YY 00	18	810	300	594	301	1,33	12,60	9,54	-	586	674
	18	810	400	774	386	1,36	15,84	11,70	-	598	688
	18	810	500	954	386	1,36	19,08	13,86	-	608	699
	18	810	600	1134	566	1,36	22,50	16,02	-	620	713
	18	810	900	1656	827	1,36	32,22	22,50	-	689	792
	18	810	900	1656	827	1,36	32,22	22,50	-	689	792
367 090 030 XX YY 00	20	900	300	660	335	1,33	14,00	10,60	-	647	744
	20	900	400	860	429	1,36	17,60	13,00	-	657	756
	20	900	500	1060	429	1,36	21,20	15,40	-	669	769
	20	900	600	1260	629	1,36	25,00	17,80	-	679	781
	20	900	900	1840	919	1,36	35,80	25,00	-	757	871
	20	900	900	1840	919	1,36	35,80	25,00	-	757	871
367 099 030 XX YY 00	22	990	300	726	368	1,33	15,40	11,66	-	686	789
	22	990	400	946	472	1,36	19,36	14,30	-	696	800
	22	990	500	1166	472	1,36	23,32	16,94	-	707	813
	22	990	600	1386	692	1,36	27,50	19,58	-	718	826
	22	990	900	2024	1010	1,36	39,38	27,50	-	789	907
	22	990	900	2024	1010	1,36	39,38	27,50	-	789	907
367 108 030 XX YY 00	24	1080	300	792	401	1,33	16,80	12,72	-	723	831
	24	1080	400	1032	515	1,36	21,12	15,60	-	735	845
	24	1080	500	1272	515	1,36	25,44	18,48	-	745	857
	24	1080	600	1512	755	1,36	30,00	21,36	-	757	871
	24	1080	900	2208	1102	1,36	42,96	30,00	-	847	974
	24	1080	900	2208	1102	1,36	42,96	30,00	-	847	974

Conform EN442-1: 2014: radiatoren en convectoren

Voor meer details over onze artikel-data, zie artikel-database: <https://www.2ba.nl>

Voor de warmteafgiftes van andere regimes, kijkt u op p. 370 (correctiefactoren)  
NEDERLAND. Prijzen in euro (excl. BTW)

# RITMO HORIZONTAAL (3-KOLOM)

## HOE RITMO HORIZONTAAL BESTELLEN

Leveringstermijn 15 - 30 werkdagen  
(zonder transportduur)

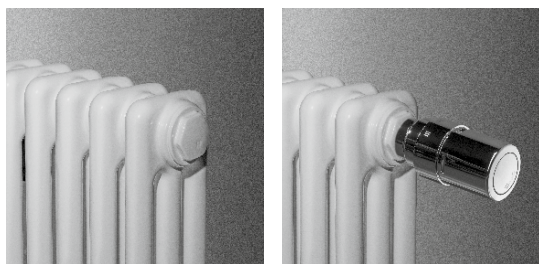

RITMO HB-3K/105  
(3-KOLOM) 4-AANSLUITINGEN

RITMO HB-3K/105  
(3-KOLOM) GEÏNTEGREERD VENTIEL  
(thermostaatkop apart te bestellen)

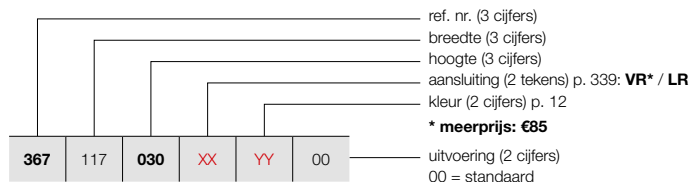

### PRIJSGROEP: VPG5 - KOLOMRADIATOREN

BESTELCODE MAATWERK RITMO HORIZONTAAL	TECHNISCHE GEGEVENS									STANDAARDKLEUR	ANDERE KLEUREN
	buizen	breedte (L mm)	hoogte (H mm)	75/65/20 (Watt) (Ø50K)	55/45/20 (Watt) (Ø30K)	n-exp.	gewicht (kg)	inhoud (l)	el. weerst. (Watt)	prijs RAL 9016 (€)	prijs kleur (€)
<b>REF. NR. RITMO HORIZONTAAL HB-3K/105 : 367</b>											
<b>367</b>	<b>117</b>	<b>030</b>	<b>XX</b>	<b>YY</b>	<b>00</b>						
		<b>040</b>								<b>787</b>	<b>905</b>
		<b>050</b>								<b>798</b>	<b>918</b>
		<b>060</b>								<b>809</b>	<b>930</b>
		<b>090</b>								<b>820</b>	<b>943</b>
										<b>959</b>	<b>1103</b>
<b>367</b>	<b>126</b>	<b>030</b>	<b>XX</b>	<b>YY</b>	<b>00</b>						
		<b>040</b>								<b>844</b>	<b>971</b>
		<b>050</b>								<b>855</b>	<b>983</b>
		<b>060</b>								<b>866</b>	<b>996</b>
		<b>090</b>								<b>877</b>	<b>1009</b>
										<b>1030</b>	<b>1185</b>
<b>367</b>	<b>135</b>	<b>030</b>	<b>XX</b>	<b>YY</b>	<b>00</b>						
		<b>040</b>								<b>903</b>	<b>1038</b>
		<b>050</b>								<b>914</b>	<b>1051</b>
		<b>060</b>								<b>925</b>	<b>1064</b>
		<b>090</b>								<b>936</b>	<b>1076</b>
										<b>1096</b>	<b>1260</b>
<b>367</b>	<b>144</b>	<b>030</b>	<b>XX</b>	<b>YY</b>	<b>00</b>						
		<b>040</b>								<b>961</b>	<b>1105</b>
		<b>050</b>								<b>972</b>	<b>1118</b>
		<b>060</b>								<b>983</b>	<b>1130</b>
		<b>090</b>								<b>994</b>	<b>1143</b>
										<b>1162</b>	<b>1336</b>
<b>367</b>	<b>153</b>	<b>030</b>	<b>XX</b>	<b>YY</b>	<b>00</b>						
		<b>040</b>								<b>1020</b>	<b>1173</b>
		<b>050</b>								<b>1030</b>	<b>1185</b>
		<b>060</b>								<b>1042</b>	<b>1198</b>
		<b>090</b>								<b>1052</b>	<b>1210</b>
										<b>1238</b>	<b>1424</b>
<b>367</b>	<b>162</b>	<b>030</b>	<b>XX</b>	<b>YY</b>	<b>00</b>						
		<b>040</b>								<b>1075</b>	<b>1236</b>
		<b>050</b>								<b>1087</b>	<b>1250</b>
		<b>060</b>								<b>1097</b>	<b>1262</b>
		<b>090</b>								<b>1109</b>	<b>1275</b>
										<b>1316</b>	<b>1513</b>
<b>367</b>	<b>171</b>	<b>030</b>	<b>XX</b>	<b>YY</b>	<b>00</b>						
		<b>040</b>								<b>1140</b>	<b>1311</b>
		<b>050</b>								<b>1151</b>	<b>1324</b>
		<b>060</b>								<b>1162</b>	<b>1336</b>
		<b>090</b>								<b>1172</b>	<b>1348</b>
										<b>1381</b>	<b>1588</b>
<b>367</b>	<b>180</b>	<b>030</b>	<b>XX</b>	<b>YY</b>	<b>00</b>						
		<b>040</b>								<b>1211</b>	<b>1393</b>
		<b>050</b>								<b>1223</b>	<b>1406</b>
		<b>060</b>								<b>1233</b>	<b>1418</b>
		<b>090</b>								<b>1245</b>	<b>1432</b>
										<b>1463</b>	<b>1682</b>

Conform EN442-1: 2014: radiatoren en convectoren

Voor meer details over onze artikel-data, zie artikel-database: <https://www.2ba.nl>

Voor de warmteafgiftes van andere regimes, kijkt u op p. 370 (correctiefactoren)  
NEDERLAND. Prijzen in euro (excl. BTW)

## HOE RITMO HORIZONTAAL BESTELLEN

Leveringstermijn 15 - 30 werkdagen  
(zonder transportduur)

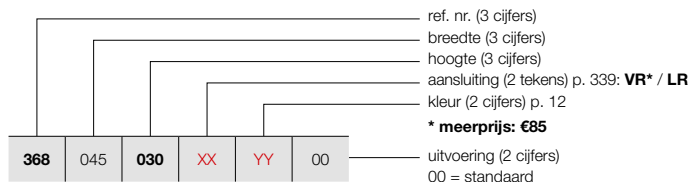

## RITMO HORIZONTAAL (4-KOLOM)

333

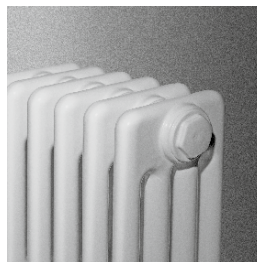

RITMO HB-4K/145  
(4-KOLOM) 4-AANSLUITINGEN



RITMO HB-4K/145  
(4-KOLOM) GEÏNTEGREERD VENTIEL  
(thermostaatkop apart te bestellen)

### PRIJSGROEP: VPG5 - KOLOMRADIATOREN

BESTELCODE MAATWERK RITMO HORIZONTAAL	TECHNISCHE GEGEVENS							STANDAARDKLEUR		ANDERE KLEUREN	
	buizen	breedte (L mm)	hoogte (H mm)	75/65/20 (Watt) (Φ50K)	55/45/20 (Watt) (Φ30K)	n-exp.	gewicht (kg)	inhoud (l)	el. weerst. (Watt)	prijs RAL 9016 (€)	prijs kleur (€)
REF. NR. RITMO HORIZONTAAL HB-4K/145 : 368											
368 045 030 XX YY 00	10	450	300	430	218	1,33	9,30	6,90	-	409	470
	10	450	400	560	281	1,35	11,80	8,50	-	420	483
	10	450	500	690	346	1,35	14,20	10,10	-	431	496
	10	450	600	810	406	1,35	16,60	11,70	-	442	508
	10	450	900	1170	587	1,35	23,90	16,50	-	510	587
	10	450	900	1170	587	1,35	23,90	16,50	-	510	587
368 054 030 XX YY 00	12	540	300	516	262	1,33	11,16	8,28	-	466	536
	12	540	400	672	337	1,35	14,16	10,20	-	477	549
	12	540	500	828	415	1,35	17,04	12,12	-	488	561
	12	540	600	972	488	1,35	19,92	14,04	-	498	573
	12	540	900	1404	704	1,35	28,68	19,80	-	591	680
	12	540	900	1404	704	1,35	28,68	19,80	-	591	680
368 063 030 XX YY 00	14	630	300	602	305	1,33	13,02	9,66	-	527	606
	14	630	400	784	393	1,35	16,52	11,90	-	537	618
	14	630	500	966	485	1,35	19,88	14,14	-	549	631
	14	630	600	1134	569	1,35	23,24	16,38	-	559	643
	14	630	900	1638	822	1,35	33,46	23,10	-	707	813
	14	630	900	1638	822	1,35	33,46	23,10	-	707	813
368 072 030 XX YY 00	16	720	300	688	349	1,33	14,88	11,04	-	581	668
	16	720	400	896	450	1,35	18,88	13,60	-	591	680
	16	720	500	1104	554	1,35	22,72	16,16	-	603	693
	16	720	600	1296	650	1,35	26,56	18,72	-	613	705
	16	720	900	1872	939	1,35	38,24	26,40	-	806	927
	16	720	900	1872	939	1,35	38,24	26,40	-	806	927
368 081 030 XX YY 00	18	810	300	774	392	1,33	16,74	12,42	-	657	756
	18	810	400	1008	506	1,35	21,24	15,30	-	669	769
	18	810	500	1242	623	1,35	25,56	18,18	-	679	781
	18	810	600	1458	732	1,35	29,88	21,06	-	691	795
	18	810	900	2106	1057	1,35	43,02	29,70	-	904	1040
	18	810	900	2106	1057	1,35	43,02	29,70	-	904	1040
368 090 030 XX YY 00	20	900	300	860	436	1,33	18,60	13,80	-	757	871
	20	900	400	1120	562	1,35	23,60	17,00	-	767	882
	20	900	500	1380	692	1,35	28,40	20,20	-	779	896
	20	900	600	1620	813	1,35	33,20	23,40	-	789	907
	20	900	900	2340	1174	1,35	47,80	33,00	-	1003	1153
	20	900	900	2340	1174	1,35	47,80	33,00	-	1003	1153
368 099 030 XX YY 00	22	990	300	946	480	1,33	20,46	15,18	-	789	907
	22	990	400	1232	618	1,35	25,96	18,70	-	800	920
	22	990	500	1518	762	1,35	31,24	22,22	-	811	933
	22	990	600	1782	894	1,35	36,52	25,74	-	822	945
	22	990	900	2574	1292	1,35	52,58	36,30	-	1058	1217
	22	990	900	2574	1292	1,35	52,58	36,30	-	1058	1217
368 108 030 XX YY 00	24	1080	300	1032	523	1,33	22,32	16,56	-	822	945
	24	1080	400	1344	674	1,35	28,32	20,40	-	833	958
	24	1080	500	1656	831	1,35	34,08	24,24	-	844	971
	24	1080	600	1944	975	1,35	39,84	28,08	-	855	983
	24	1080	900	2808	1409	1,35	57,36	39,60	-	1107	1273
	24	1080	900	2808	1409	1,35	57,36	39,60	-	1107	1273

Conform EN442-1: 2014: radiatoren en convectoren

Voor meer details over onze artikel-data, zie artikel-database: <https://www.2ba.nl>

Voor de warmteafgiftes van andere regimes, kijkt u op p. 370 (correctiefactoren)  
NEDERLAND. Prijzen in euro (excl. BTW)

# RITMO HORIZONTAAL (4-KOLOM)

## HOE RITMO HORIZONTAAL BESTELLEN

Leveringstermijn 15 - 30 werkdagen  
(zonder transportduur)

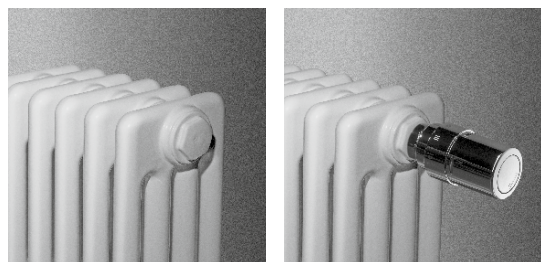

RITMO HB-4K/145  
(4-KOLOM) 4-AANSLUITINGEN

RITMO HB-4K/145  
(4-KOLOM) GEÏNTEGREERD VENTIEL  
(thermostaatkop apart te bestellen)

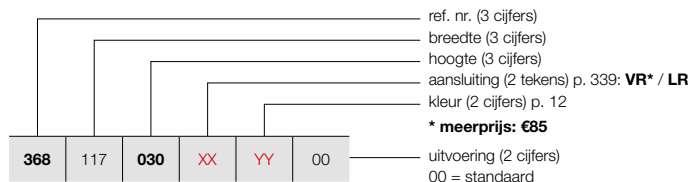

### PRIJSGROEP: VPG5 - KOLOMRADIATOREN



BESTELCODE MAATWERK RITMO HORIZONTAAL	TECHNISCHE GEGEVENS									STANDAARDKLEUR	ANDERE KLEUREN	
	buizen	breedte (L mm)	hoogte (H mm)	75/65/20 (Watt) (Ø50K)	55/45/20 (Watt) (Ø30K)	n-exp.	gewicht (kg)	inhoud (l)	el. weerst. (Watt)	prijs RAL 9016 (€)	prijs kleur (€)	
<b>REF. NR. RITMO HORIZONTAAL HB-4K/145 : 368</b>												
368 117 030 XX YY 00	040	26	1170	300	1118	567	1,33	24,18	17,94	-	965	1110
	050	26	1170	400	1456	731	1,35	30,68	22,10	-	976	1122
	060	26	1170	500	1794	900	1,35	36,92	26,26	-	986	1134
	090	26	1170	600	2106	1057	1,35	43,16	30,42	-	998	1148
	090	26	1170	900	3042	1526	1,35	62,14	42,90	-	1282	1474
368 126 030 XX YY 00	040	28	1260	300	1204	610	1,33	26,04	19,32	-	1036	1191
	050	28	1260	400	1568	787	1,35	33,04	23,80	-	1047	1204
	060	28	1260	500	1932	969	1,35	39,76	28,28	-	1058	1217
	090	28	1260	600	2268	1138	1,35	46,48	32,76	-	1069	1229
	090	28	1260	900	3276	1644	1,35	66,92	46,20	-	1354	1557
368 135 030 XX YY 00	040	30	1350	300	1290	654	1,33	27,90	20,70	-	1096	1260
	050	30	1350	400	1680	843	1,35	35,40	25,50	-	1107	1273
	060	30	1350	500	2070	1039	1,35	42,60	30,30	-	1118	1286
	090	30	1350	600	2430	1219	1,35	49,80	35,10	-	1129	1298
	090	30	1350	900	3510	1761	1,35	71,70	49,50	-	1414	1626
368 144 030 XX YY 00	040	32	1440	300	1376	698	1,33	29,76	22,08	-	1172	1348
	050	32	1440	400	1792	899	1,35	37,76	27,20	-	1184	1362
	060	32	1440	500	2208	1108	1,35	45,44	32,32	-	1194	1373
	090	32	1440	600	2592	1301	1,35	53,12	37,44	-	1206	1387
	090	32	1440	900	3744	1879	1,35	76,48	52,80	-	1491	1715
368 153 030 XX YY 00	040	34	1530	300	1462	741	1,33	31,62	23,46	-	1245	1432
	050	34	1530	400	1904	955	1,35	40,12	28,90	-	1255	1443
	060	34	1530	500	2346	1177	1,35	48,28	34,34	-	1267	1457
	090	34	1530	600	2754	1382	1,35	56,44	39,78	-	1277	1469
	090	34	1530	900	3978	1996	1,35	81,26	56,10	-	1568	1803
368 162 030 XX YY 00	040	36	1620	300	1548	785	1,33	33,48	24,84	-	1324	1523
	050	36	1620	400	2016	1012	1,35	42,48	30,60	-	1336	1536
	060	36	1620	500	2484	1246	1,35	51,12	36,36	-	1346	1548
	090	36	1620	600	2916	1463	1,35	59,76	42,12	-	1357	1561
	090	36	1620	900	4212	2113	1,35	86,04	59,40	-	1650	1898
368 171 030 XX YY 00	040	38	1710	300	1634	828	1,33	35,34	26,22	-	1387	1595
	050	38	1710	400	2128	1068	1,35	44,84	32,30	-	1397	1607
	060	38	1710	500	2622	1316	1,35	53,96	38,38	-	1409	1620
	090	38	1710	600	3078	1544	1,35	63,08	44,46	-	1419	1632
	090	38	1710	900	4446	2231	1,35	90,82	62,70	-	1704	1960
368 180 030 XX YY 00	040	40	1800	300	1720	872	1,33	37,20	27,60	-	1435	1650
	050	40	1800	400	2240	1124	1,35	47,20	34,00	-	1446	1663
	060	40	1800	500	2760	1385	1,35	56,80	40,40	-	1457	1676
	090	40	1800	600	3240	1626	1,35	66,40	46,80	-	1468	1688
	090	40	1800	900	4680	2348	1,35	95,60	66,00	-	1764	2029

Conform EN442-1: 2014: radiatoren en convectoren

Voor meer details over onze artikel-data, zie artikel-database: <https://www.2ba.nl>

Voor de warmteafgiftes van andere regimes, kijkt u op p. 370 (correctiefactoren)  
NEDERLAND. Prijzen in euro (excl. BTW)

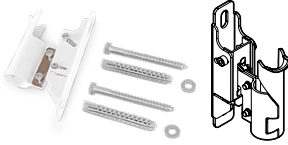
PRIJSGROEP: VPG10 - ACC.

BEVESTIGINGEN		KLEUR	ART. NR.	€
<b>KLEMCONSOLE VARIABEL</b>				
<b>KLEMCONSOLE VARIABEL</b> 	<b>RITMO VERTICAAL / RITMO HORIZONTAAL</b>			
	35 - 45 mm	RAL 9016	11872120000	<b>35</b>
		KLEUR	11872120000C	<b>40</b>
	45 - 60 mm	RAL 9016	11872130000	<b>40</b>
		KLEUR	11872130000C	<b>47</b>
<ul style="list-style-type: none"> <li>Wandafstand: 35 - 45 mm of 45 - 60 mm</li> </ul>				
<b>AFSTANDHOUDER</b>				
	<b>RITMO VERTICAAL / RITMO HORIZONTAAL</b>			
		RAL 9016	1187 209 0000 9016	<b>13</b>
	RAL 7024	1187 209 0000 7024	<b>14</b>	

hoogte (H mm)	2-kolom / 3-kolom / 4-kolom		
	300 - 900	1500 - 2200	
aantal buizen (n)	10 - 28	30 - 40	6 - 16
klemconsole variabel 35 - 45 mm	2x	3x	2x
klemconsole variabel 45 - 60 mm	2x	3x	2x
afstandhouder	2x	3x	2x

**HOE BESTELLEN**



- Kies de gewenste klemconsole in bovenstaande tabel.
- Afstandhouders dienen apart mee besteld te worden.

**NEDERLAND. Prijzen in euro (excl. BTW)**

# RITMO VRIJSTAANDE OPSTELLING

## IN OPTIE

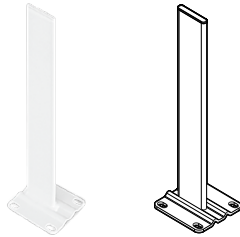
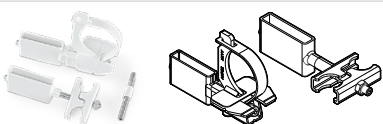

PRIJSGROEP: VPG10 - ACC.

VRIJSTAANDE OPSTELLING	HOOGTE VOET	KLEUR	ART. NR.	€
<b>STANDVOET VRIJSTAANDE OPSTELLING</b> 	<b>RITMO HORIZONTAAL</b>			
	H = 450 mm	RAL 9016	11810350450	<b>65</b>
		KLEUR	11810350450C	<b>75</b>
	H = 550 mm	RAL 9016	11810350550	<b>65</b>
		KLEUR	11810350550C	<b>75</b>
	H = 600 mm	RAL 9016	11810350600	<b>65</b>
		KLEUR	11810350600C	<b>75</b>
	H = 650 mm	RAL 9016	11810350650	<b>65</b>
		KLEUR	11810350650C	<b>75</b>
	H = 750 mm	RAL 9016	11810350750	<b>65</b>
		KLEUR	11810350750C	<b>75</b>
	H = 850 mm	RAL 9016	11810350850	<b>81</b>
		KLEUR	11810350850C	<b>92</b>
H = 900 mm	RAL 9016	11810350900	<b>81</b>	
	KLEUR	11810350900C	<b>92</b>	
H = 1050 mm	RAL 9016	11810351050	<b>81</b>	
	KLEUR	11810351050C	<b>92</b>	
H = 1200 mm	RAL 9016	11810351200	<b>81</b>	
	KLEUR	11810351200C	<b>92</b>	
<ul style="list-style-type: none"> <li>Afgewerkte vloer: hoogte voet = hoogte radiator + 150 mm</li> <li>Chape: hoogte voet = hoogte radiator + 300 mm</li> <li>Zelf in te korten indien nodig</li> </ul>				
<b>BEVESTIGING STANDVOET VRIJSTAANDE OPSTELLING</b> 	<b>RITMO HORIZONTAAL</b>			
		RAL 9016	11810290000	<b>85</b>
		KLEUR	11810290000C	<b>97</b>
<b>AFDEKROZET STANDVOET CHAPE</b> 	<b>RITMO HORIZONTAAL</b>			
		RAL 9016	11810370000	<b>14</b>
		KLEUR	11810370000C	<b>16</b>
<ul style="list-style-type: none"> <li>100 x 40 mm. Aantal rozetten = aantal standvoeten</li> </ul>				
<b>AFDEKROZET STANDVOET AFGEWERKTE VLOER</b> 	<b>RITMO HORIZONTAAL</b>			
		RAL 9016	11810380000	<b>17</b>
		KLEUR	11810380000C	<b>19</b>
<ul style="list-style-type: none"> <li>115 x 110 mm. Aantal rozetten = aantal standvoeten</li> </ul>				

hoogte (H mm)	2-kolom / 3-kolom / 4-kolom	
	300 – 900	
aantal buizen (n)	10 – 26	28 – 40
standvoet	2x	3x

NEDERLAND. Prijzen in euro (excl. BTW)

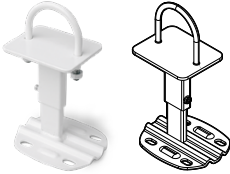
PRIJSGROEP: VPG10 - ACC.



		KLEUR	ART. NR.	€
<b>TELESCOPISCHE ONDERSTEUNVOET</b>  <ul style="list-style-type: none"> <li>• Hoogte: min. 200 mm, max. 230 mm</li> <li>• Telescopische ondersteunvoet steeds in combinatie met de wand- en klemconsoles</li> </ul>	<b>RITMO VERTICAAL / RITMO HORIZONTAAL</b>			
		RAL 9016	11810300000	<b>75</b>
		KLEUR	11810300000C	<b>86</b>
<b>AFDEKROZET ONDERSTEUNVOET CHAPE</b>  <ul style="list-style-type: none"> <li>• 70 x 40 mm. Aantal rozetten = aantal standvoeten</li> </ul>	<b>RITMO VERTICAAL / RITMO HORIZONTAAL</b>			
		RAL 9016	1181 032 0000 9016	<b>13</b>
<b>AFDEKROZET ONDERSTEUNVOET AFGEWERKTE VLOER</b>  <ul style="list-style-type: none"> <li>• 130 x 110 mm. Aantal rozetten = aantal standvoeten</li> </ul>	<b>RITMO VERTICAAL / RITMO HORIZONTAAL</b>			
		RAL 9016	1181 031 0000 9016	<b>17</b>

hoogte (H mm)	2-kolom / 3-kolom					4-kolom				
	300 – 600		900 – 2000		2200	300 – 600		900 – 2000		2200
aantal buizen (n)	10 – 24	26 – 40	6 – 24	26 – 40	6 – 16	10 – 24	26 – 40	6 – 24	26 – 40	6 – 16
telescopische ondersteunvoet	2x	3x	2x	3x	2x	2x	3x	2x	3x	3x

NEDERLAND. Prijzen in euro (excl. BTW)

**RITMO ACCESSOIRES**  
 IN OPTIE

PRIJSGROEP: VPG10 - ACC.

ACCESSOIRES		KLEUR	ART. NR.	€
		<b>RITMO HORIZONTAAL</b>		
THERMOSTAATKOP		WIT	11911630102	<b>54</b>
		<b>RITMO HORIZONTAAL</b>		
THERMOSTAATKOP		CHROOM	11911631102	<b>69</b>

PRIJSGROEP: VPG10B - HANDDOEKBEUGELS

ACCESSOIRES		KLEUR	ART. NR.	€
		<b>RITMO VERTICAAL / RITMO HORIZONTAAL</b>		
HANDDOEKBEUGEL		CHROOM	11832650000099	<b>150</b>

- b = 1000 mm (zelf in te korten)

Montagevoorschriften accessoires: zie [www.vasco.eu](http://www.vasco.eu)  
 NEDERLAND. Prijzen in euro (excl. BTW)

uit voorraad leverbaar

## RITMO: VERTICAAL

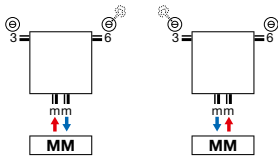

- Ontluchter in aansluiting 3 of 6.

## RITMO: HORIZONTAAL

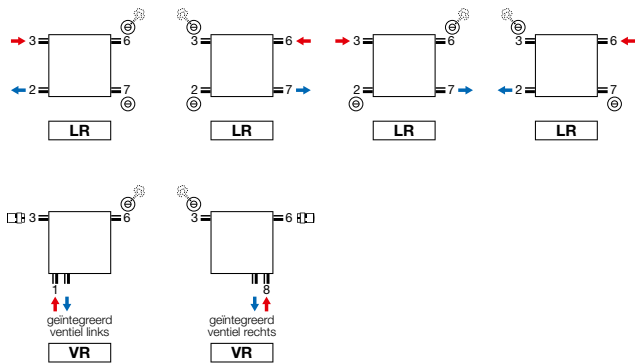

- Ontluchter in aansluiting 3 of 6.
- Geïntegreerd ventiel (aansluiting VR) (meerprijs: €85) (thermostaatkop apart te bestellen, zie p. 338). Plaatsing thermostaatkop links, door spiegelen van radiator.  
Opgelet: de aanvoer is aan de buitenkant van de radiator!

**Opmerking:** het aansluiten van de radiator kan enkel volgens de getoonde aansluiticonen. Voor elke andere aansluitwijze nemen wij geen verantwoordelijkheid.

**RITMO VERTICAAL**

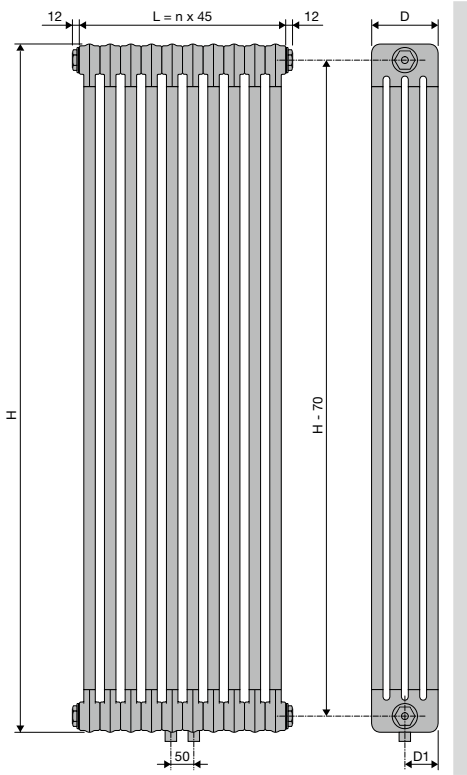

<b>VB-2K/65 / VB-3K/105 / VB-4K/145</b>						
H	1500	1800	2000	2200		
Diepte (D)	65	105	145			
D1	32,5	52,5	72,5			
Aantal leden (n)	6	8	10	12	14	16

**RITMO HORIZONTAAL**

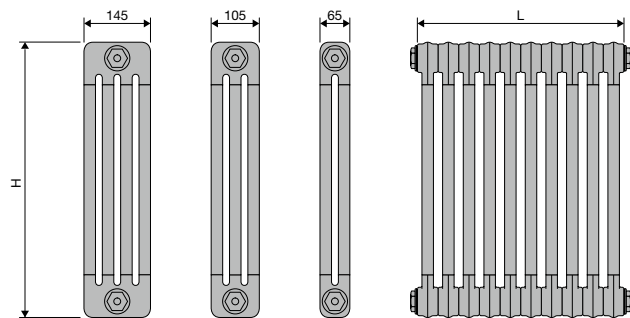
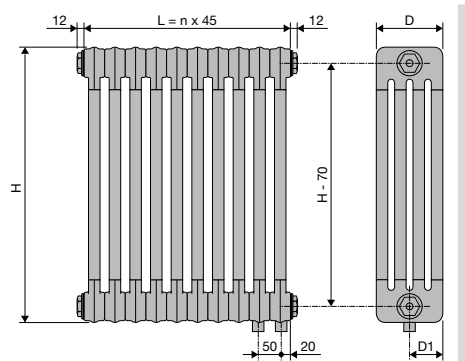
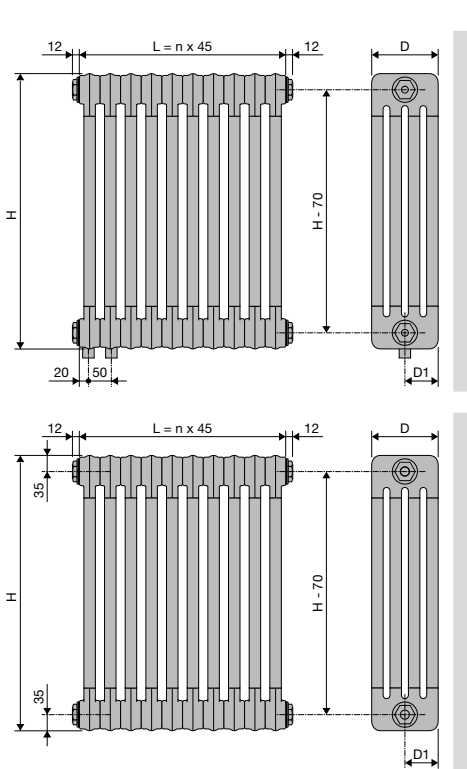

<b>HB-2K/65 / HB-3K/105 / HB-4K/145</b>																
H	300	400	500	600	900											
Diepte (D)	65	105	145													
D1	32,5	52,5	72,5													
Aantal leden (n)	10	12	14	16	18	20	22	24	26	28	30	32	34	36	38	40



KOLOMRADIATOREN

## VINTAGE (VINTAGE 50)



### TYPES

- Vintage 50: afstand tussen de leden 50 mm
- 4 dieptes (D110, D160, D220, D250)

### KLEUREN

- Standaardkleur S600 (witte fijn structuurlak) (RAL 9016: geen meerprijs 15%)
- Verkrijgbaar in transparante coating (kleurcode 57)
- **Opgelet: een radiator in transparante coating niet in vochtige ruimtes plaatsen!**
- Uitgebreide kleurenkaart zie p. 12

### SPECIAAL

- Vloer- of wandmontage

### BEVESTIGINGEN

- Standaard wandbevestigingen of ledenvoeten, 1/2" blindstop, 1/2" ontluchter
- Bevestigingen in de kleur van de radiator (aantal afhankelijk van de lengte van de radiator)
- De voeten en bevestigingen van radiatoren in transparante coating zijn gelakt in de kleur N507.

### TECHNISCH

- ATL-grondlaag, epoxy-polyester poedercoating
- Standaardwerkdruk: 5 bar
- Maximale bedrijfstemperatuur: 110°C

### TECHNISCHE TEKENINGEN

- Zie p. 358

### AANSLUITING

- 4x 1/2" (SL, SR, 26, 37)
- Ontluchter in aansluiting 3 of 6
- Aansluitingen: 1/2" (binnendraad)
- Aansluiting 27, 72: **meerprijs €88**

## VINTAGE

### Vroeger is weer helemaal van nu

Terug naar de 'oerradiator'. Erg populair omwille van de tot de verbeelding sprekende, authentieke look. Standaard aangeboden in een witte uitvoering, maar ook verkrijgbaar met een transparante coating voor een nog meer uitgesproken vintage look. De Vintage staat borg voor een zeer hoge warmteafgifte. Ideaal voor de verwarming van grote, hoge ruimten, ook in combinatie met energiezuinige technologieën. Een designradiator die als geen andere tot zijn recht komt in een retro-interieur en zich graag voor een raam laat plaatsen.

### AANBEVOLEN AANSLUITING (LR)

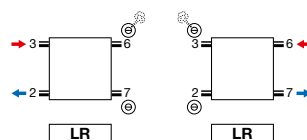

Andere aansluitmogelijkheden, zie p. 357



HOE VINTAGE 50 BESTELLEN

Leveringstermijn 15 - 30 werkdagen  
(zonder transportduur)

VINTAGE (VINTAGE 50 / D110)

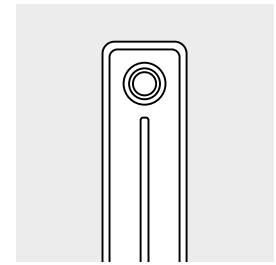
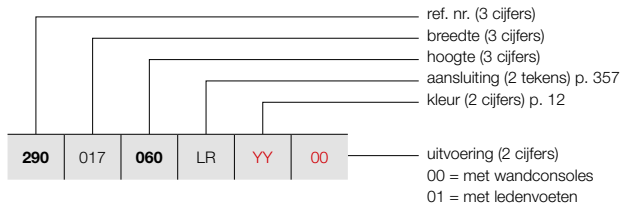

VINTAGE 50 / D110

PRIJSGROEP: VPG5 - KOLOMRADIATOREN

BESTELCODE MAATWERK VINTAGE 50	TECHNISCHE GEGEVENS								STANDAARDKLEUR	ANDERE KLEUREN	
	buizen	breedte (L mm)	hoogte (H mm)	75/65/20 (Watt) (Ø50K)	55/45/20 (Watt) (Ø30K)	n-exp.	gewicht (kg)	inhoud (l)			el. weerst. (Watt)
REF. NR. VINTAGE 50 VINTAGE 50/D110 : 290											
290 017 060 LR YY 00	3	178	600	165	87	1,25	4,17	2,49	-	410	472
	3	178	1000	252	131	1,28	6,57	3,39	-	434	499
290 022 060 LR YY 00	4	228	600	220	116	1,25	5,56	3,32	-	427	491
	4	228	1000	336	175	1,28	8,76	4,52	-	463	532
290 027 060 LR YY 00	5	278	600	275	145	1,25	6,95	4,15	-	447	514
	5	278	1000	420	218	1,28	10,95	5,65	-	493	567
290 032 060 LR YY 00	6	328	600	330	174	1,25	8,34	4,98	-	471	542
	6	328	1000	504	262	1,28	13,14	6,78	-	520	598
290 037 060 LR YY 00	7	378	600	385	203	1,25	9,73	5,81	-	488	561
	7	378	1000	588	306	1,28	15,33	7,91	-	552	635
290 042 060 LR YY 00	8	428	600	440	232	1,25	11,12	6,64	-	518	596
	8	428	1000	672	349	1,28	17,52	9,04	-	582	669
290 047 060 LR YY 00	9	478	600	495	261	1,25	12,51	7,47	-	535	615
	9	478	1000	756	393	1,28	19,71	10,17	-	611	703
290 052 060 LR YY 00	10	528	600	550	290	1,25	13,90	8,30	-	560	644
	10	528	1000	840	437	1,28	21,90	11,30	-	641	737
290 057 060 LR YY 00	11	578	600	605	319	1,25	15,29	9,13	-	581	668
	11	578	1000	924	481	1,28	24,09	12,43	-	675	776
290 062 060 LR YY 00	12	628	600	660	349	1,25	16,68	9,96	-	605	696
	12	628	1000	1008	524	1,28	26,28	13,56	-	703	808
290 067 060 LR YY 00	13	678	600	715	378	1,25	18,07	10,79	-	624	718
	13	678	1000	1092	568	1,28	28,47	14,69	-	734	844
290 072 060 LR YY 00	14	728	600	770	407	1,25	19,46	11,62	-	645	742
	14	728	1000	1176	612	1,28	30,66	15,82	-	759	873
290 077 060 LR YY 00	15	778	600	825	436	1,25	20,85	12,45	-	664	764
	15	778	1000	1260	655	1,28	32,85	16,95	-	788	906
290 082 060 LR YY 00	16	828	600	880	465	1,25	22,24	13,28	-	681	783
	16	828	1000	1344	699	1,28	35,04	18,08	-	814	936
290 087 060 LR YY 00	17	878	600	935	494	1,25	23,63	14,11	-	703	808
	17	878	1000	1428	743	1,28	37,23	19,21	-	843	969
290 092 060 LR YY 00	18	928	600	990	523	1,25	25,02	14,94	-	724	833
	18	928	1000	1512	786	1,28	39,42	20,34	-	874	1005
290 097 060 LR YY 00	19	978	600	1045	552	1,25	26,41	15,77	-	740	851
	19	978	1000	1596	830	1,28	41,61	21,47	-	900	1035

Conform EN442-1: 2014: radiatoren en convectoren

\* RAL 9016: geen meerprijs 15%

Voor meer details over onze artikel-data, zie artikel-database: <https://www.2ba.nl>

Voor de warmteafgiftes van andere regimes, kijkt u op p. 370 (correctiefactoren)

NETERLAND. Prijzen in euro (excl. BTW)

# VINTAGE (VINTAGE 50 / D110)

## HOE VINTAGE 50 BESTELLEN

Leveringstermijn 15 - 30 werkdagen  
(zonder transportduur)

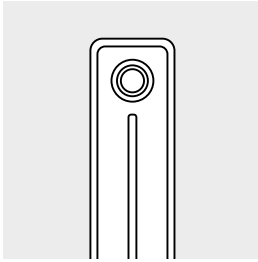

VINTAGE 50 / D110

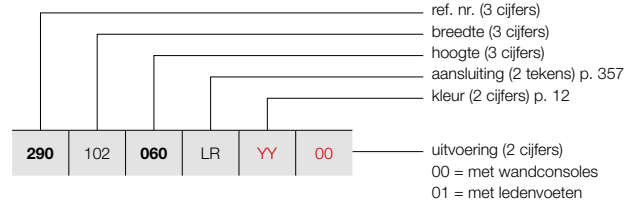

### PRIJSGROEP: VPG5 - KOLOMRADIATOREN

BESTELCODE MAATWERK VINTAGE 50	TECHNISCHE GEGEVENS									STANDAARDKLEUR	ANDERE KLEUREN
	buizen	breedte (L mm)	hoogte (H mm)	75/65/20 (Watt) (Ø50K)	55/45/20 (Watt) (Ø30K)	n-exp.	gewicht (kg)	inhoud (l)	el. weerst. (Watt)	prijs S600* (€)	prijs kleur (€)
<b>REF. NR. VINTAGE 50 VINTAGE 50/D110 : 290</b>											
290 102 060 LR YY 00	20	1028	600	1100	581	1,25	27,80	16,60	-	<b>761</b>	<b>875</b>
	20	1028	1000	1680	874	1,28	43,80	22,60	-	<b>927</b>	<b>1066</b>
290 107 060 LR YY 00	21	1078	600	1155	610	1,25	29,19	17,43	-	<b>798</b>	<b>918</b>
	21	1078	1000	1764	917	1,28	45,99	23,73	-	<b>971</b>	<b>1117</b>
290 112 060 LR YY 00	22	1128	600	1210	639	1,25	30,58	18,26	-	<b>815</b>	<b>937</b>
	22	1128	1000	1848	961	1,28	48,18	24,86	-	<b>1000</b>	<b>1150</b>
290 117 060 LR YY 00	23	1178	600	1265	668	1,25	31,97	19,09	-	<b>840</b>	<b>966</b>
	23	1178	1000	1932	1005	1,28	50,37	25,99	-	<b>1024</b>	<b>1178</b>
290 122 060 LR YY 00	24	1228	600	1320	697	1,25	33,36	19,92	-	<b>856</b>	<b>984</b>
	24	1228	1000	2016	1048	1,28	52,56	27,12	-	<b>1053</b>	<b>1211</b>
290 127 060 LR YY 00	25	1278	600	1375	726	1,25	34,75	20,75	-	<b>877</b>	<b>1009</b>
	25	1278	1000	2100	1092	1,28	54,75	28,25	-	<b>1082</b>	<b>1244</b>
290 132 060 LR YY 00	26	1328	600	1430	755	1,25	36,14	21,58	-	<b>915</b>	<b>1052</b>
	26	1328	1000	2184	1136	1,28	56,94	29,38	-	<b>1128</b>	<b>1297</b>
290 137 060 LR YY 00	27	1378	600	1485	784	1,25	37,53	22,41	-	<b>933</b>	<b>1073</b>
	27	1378	1000	2268	1179	1,28	59,13	30,51	-	<b>1156</b>	<b>1329</b>
290 142 060 LR YY 00	28	1428	600	1540	813	1,25	38,92	23,24	-	<b>956</b>	<b>1099</b>
	28	1428	1000	2352	1223	1,28	61,32	31,64	-	<b>1185</b>	<b>1363</b>
290 147 060 LR YY 00	29	1478	600	1595	842	1,25	40,31	24,07	-	<b>975</b>	<b>1121</b>
	29	1478	1000	2436	1267	1,28	63,51	32,77	-	<b>1210</b>	<b>1392</b>
290 152 060 LR YY 00	30	1528	600	1650	871	1,25	41,70	24,90	-	<b>992</b>	<b>1141</b>
	30	1528	1000	2520	1310	1,28	65,70	33,90	-	<b>1239</b>	<b>1425</b>
290 157 060 LR YY 00	31	1578	600	1705	900	1,25	43,09	25,73	-	<b>1013</b>	<b>1165</b>
	31	1578	1000	2604	1354	1,28	67,89	35,03	-	<b>1275</b>	<b>1466</b>
290 162 060 LR YY 00	32	1628	600	1760	929	1,25	44,48	26,56	-	<b>1032</b>	<b>1187</b>
	32	1628	1000	2688	1398	1,28	70,08	36,16	-	<b>1301</b>	<b>1496</b>
290 167 060 LR YY 00	33	1678	600	1815	958	1,25	45,87	27,39	-	<b>1096</b>	<b>1260</b>
	33	1678	1000	2772	1442	1,28	72,27	37,29	-	<b>1374</b>	<b>1580</b>
290 172 060 LR YY 00	34	1728	600	1870	987	1,25	47,26	28,22	-	<b>1115</b>	<b>1282</b>
	34	1728	1000	2856	1485	1,28	74,46	38,42	-	<b>1402</b>	<b>1612</b>
290 177 060 LR YY 00	35	1778	600	1925	1017	1,25	48,65	29,05	-	<b>1138</b>	<b>1309</b>
	35	1778	1000	2940	1529	1,28	76,65	39,55	-	<b>1427</b>	<b>1641</b>
290 182 060 LR YY 00	36	1828	600	1980	1046	1,25	50,04	29,88	-	<b>1163</b>	<b>1337</b>
	36	1828	1000	3024	1573	1,28	78,84	40,68	-	<b>1456</b>	<b>1674</b>
290 187 060 LR YY 00	37	1878	600	2035	1075	1,25	51,43	30,71	-	<b>1183</b>	<b>1360</b>
	37	1878	1000	3108	1616	1,28	81,03	41,81	-	<b>1485</b>	<b>1708</b>

Conform EN442-1: 2014: radiatoren en convectoren

\* RAL 9016: geen meerprijs 15%

Voor meer details over onze artikel-data, zie artikel-database: <https://www.2ba.nl>

**Voor de warmteafgiftes van andere regimes, kijkt u op p. 370 (correctiefactoren)**  
**NEDERLAND. Prijzen in euro (excl. BTW)**

HOE VINTAGE 50 BESTELLEN

Leveringstermijn 15 - 30 werkdagen  
(zonder transportduur)

VINTAGE (VINTAGE 50 / D110)

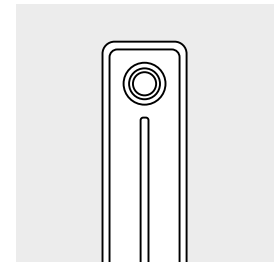
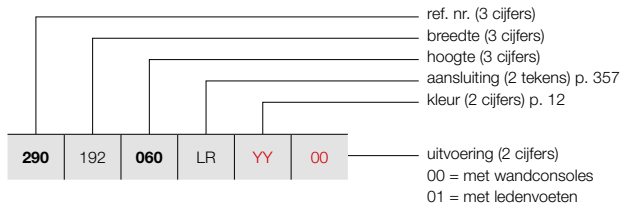

VINTAGE 50 / D110

PRIJSGROEP: VPG5 - KOLOMRADIATOREN

BESTELCODE MAATWERK VINTAGE 50	TECHNISCHE GEGEVENS							STANDAARDKLEUR		ANDERE KLEUREN						
	buizen	breedte (L mm)	hoogte (H mm)	75/65/20 (Watt) (φ50K)	55/45/20 (Watt) (φ30K)	n-exp.	gewicht (kg)	inhoud (l)	el. weerst. (Watt)	prijs S600* (€)	prijs kleur (€)					
REF. NR. VINTAGE 50 VINTAGE 50/D110 : 290																
<b>290</b>	192	<b>060</b>	LR	<b>YY</b>	<b>00</b>											
		<b>100</b>														
						38	1928	600	2090	1104	1,25	52,82	31,54	-	<b>1202</b>	<b>1382</b>
						38	1928	1000	3192	1660	1,28	83,22	42,94	-	<b>1512</b>	<b>1739</b>
<b>290</b>	197	<b>060</b>	LR	<b>YY</b>	<b>00</b>											
		<b>100</b>														
						39	1978	600	2145	1133	1,25	54,21	32,37	-	<b>1225</b>	<b>1409</b>
						39	1978	1000	3276	1704	1,28	85,41	44,07	-	<b>1542</b>	<b>1773</b>
<b>290</b>	202	<b>060</b>	LR	<b>YY</b>	<b>00</b>											
		<b>100</b>														
						40	2028	600	2200	1162	1,25	55,60	33,20	-	<b>1244</b>	<b>1431</b>
						40	2028	1000	3360	1747	1,28	87,60	45,20	-	<b>1569</b>	<b>1804</b>
<b>290</b>	207	<b>060</b>	LR	<b>YY</b>	<b>00</b>											
		<b>100</b>														
						41	2078	600	2255	1191	1,25	56,99	34,03	-	<b>1258</b>	<b>1447</b>
						41	2078	1000	3444	1791	1,28	89,79	46,33	-	<b>1597</b>	<b>1837</b>
<b>290</b>	212	<b>060</b>	LR	<b>YY</b>	<b>00</b>											
		<b>100</b>														
						42	2128	600	2310	1220	1,25	58,38	34,86	-	<b>1282</b>	<b>1474</b>
						42	2128	1000	3528	1835	1,28	91,98	47,46	-	<b>1625</b>	<b>1869</b>
<b>290</b>	217	<b>060</b>	LR	<b>YY</b>	<b>00</b>											
		<b>100</b>														
						43	2178	600	2365	1249	1,25	59,77	35,69	-	<b>1301</b>	<b>1496</b>
						43	2178	1000	3612	1878	1,28	94,17	48,59	-	<b>1655</b>	<b>1903</b>
<b>290</b>	222	<b>060</b>	LR	<b>YY</b>	<b>00</b>											
		<b>100</b>														
						44	2228	600	2420	1278	1,25	61,16	36,52	-	<b>1323</b>	<b>1521</b>
						44	2228	1000	3696	1922	1,28	96,36	49,72	-	<b>1682</b>	<b>1934</b>
<b>290</b>	227	<b>060</b>	LR	<b>YY</b>	<b>00</b>											
		<b>100</b>														
						45	2278	600	2475	1307	1,25	62,55	37,35	-	<b>1339</b>	<b>1540</b>
						45	2278	1000	3780	1966	1,28	98,55	50,85	-	<b>1711</b>	<b>1968</b>
<b>290</b>	232	<b>060</b>	LR	<b>YY</b>	<b>00</b>											
						46	2328	600	2530	1336	1,25	63,94	38,18	-	<b>1363</b>	<b>1567</b>
<b>290</b>	237	<b>060</b>	LR	<b>YY</b>	<b>00</b>											
						47	2378	600	2585	1365	1,25	65,33	39,01	-	<b>1380</b>	<b>1587</b>
<b>290</b>	242	<b>060</b>	LR	<b>YY</b>	<b>00</b>											
						48	2428	600	2640	1394	1,25	66,72	39,84	-	<b>1402</b>	<b>1612</b>
<b>290</b>	247	<b>060</b>	LR	<b>YY</b>	<b>00</b>											
						49	2478	600	2695	1423	1,25	68,11	40,67	-	<b>1421</b>	<b>1634</b>
<b>290</b>	252	<b>060</b>	LR	<b>YY</b>	<b>00</b>											
						50	2528	600	2750	1452	1,25	69,50	41,50	-	<b>1444</b>	<b>1661</b>
<b>290</b>	257	<b>060</b>	LR	<b>YY</b>	<b>00</b>											
						51	2578	600	2805	1481	1,25	70,89	42,33	-	<b>1480</b>	<b>1702</b>
<b>290</b>	262	<b>060</b>	LR	<b>YY</b>	<b>00</b>											
						52	2628	600	2860	1510	1,25	72,28	43,16	-	<b>1497</b>	<b>1722</b>
<b>290</b>	267	<b>060</b>	LR	<b>YY</b>	<b>00</b>											
						53	2678	600	2915	1539	1,25	73,67	43,99	-	<b>1515</b>	<b>1742</b>
<b>290</b>	272	<b>060</b>	LR	<b>YY</b>	<b>00</b>											
						54	2728	600	2970	1568	1,25	75,06	44,82	-	<b>1540</b>	<b>1771</b>
<b>290</b>	277	<b>060</b>	LR	<b>YY</b>	<b>00</b>											
						55	2778	600	3025	1597	1,25	76,45	45,65	-	<b>1559</b>	<b>1793</b>
<b>290</b>	282	<b>060</b>	LR	<b>YY</b>	<b>00</b>											
						56	2828	600	3080	1626	1,25	77,84	46,48	-	<b>1579</b>	<b>1816</b>
<b>290</b>	287	<b>060</b>	LR	<b>YY</b>	<b>00</b>											
						57	2878	600	3135	1655	1,25	79,23	47,31	-	<b>1597</b>	<b>1837</b>
<b>290</b>	292	<b>060</b>	LR	<b>YY</b>	<b>00</b>											
						58	2928	600	3190	1685	1,25	80,62	48,14	-	<b>1616</b>	<b>1858</b>
<b>290</b>	297	<b>060</b>	LR	<b>YY</b>	<b>00</b>											
						59	2978	600	3245	1714	1,25	82,01	48,97	-	<b>1636</b>	<b>1881</b>
<b>290</b>	302	<b>060</b>	LR	<b>YY</b>	<b>00</b>											
						60	3028	600	3300	1743	1,25	83,40	49,80	-	<b>1657</b>	<b>1906</b>

Conform EN442-1: 2014: radiatoren en convectoren

\* RAL 9016: geen meerprijs 15%

Voor meer details over onze artikel-data, zie artikel-database: <https://www.2ba.nl>

Voor de warmteafgiftes van andere regimes, kijkt u op p. 370 (correctiefactoren)  
NEDERLAND. Prijzen in euro (excl. BTW)

# VINTAGE (VINTAGE 50 / D160)

## HOE VINTAGE 50 BESTELLEN

Leveringstermijn 15 - 30 werkdagen  
(zonder transportduur)

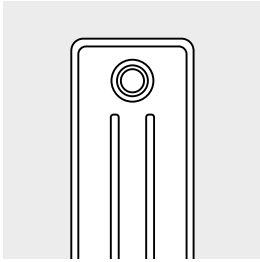

VINTAGE 50 / D160

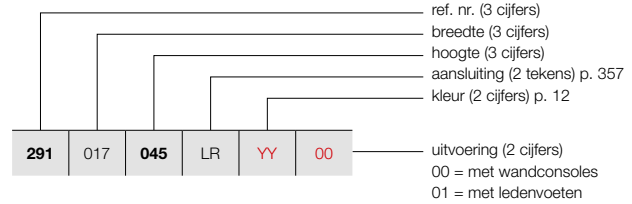

### PRIJSGROEP: VPG5 - KOLOMRADIATOREN

BESTELCODE MAATWERK VINTAGE 50							TECHNISCHE GEGEVENS						STANDAARDKLEUR	ANDERE KLEUREN		
buizen	breedte (L mm)	hoogte (H mm)	75/65/20 (Watt) (Ø50K)	55/45/20 (Watt) (Ø30K)	n-exp.	gewicht (kg)	inhoud (l)	el. weerst. (Watt)	prijs S600* (€)	prijs kleur (€)						
REF. NR. VINTAGE 50 VINTAGE 50/D160 : 291																
291	017	045 060 100	LR	YY	00	3	178	450	174	92	1,24	4,47	2,82	-	412	474
						3	178	600	219	115	1,26	6,00	3,42	-	427	491
						3	178	1000	333	172	1,29	9,63	4,89	-	467	537
291	022	045 060 100	LR	YY	00	4	228	450	232	123	1,24	5,96	3,76	-	433	498
						4	228	600	292	153	1,26	8,00	4,56	-	448	515
						4	228	1000	444	230	1,29	12,84	6,52	-	498	573
291	027	045 060 100	LR	YY	00	5	278	450	290	154	1,24	7,45	4,70	-	454	522
						5	278	600	365	192	1,26	10,00	5,70	-	478	550
						5	278	1000	555	287	1,29	16,05	8,15	-	535	615
291	032	045 060 100	LR	YY	00	6	328	450	348	185	1,24	8,94	5,64	-	473	544
						6	328	600	438	230	1,26	12,00	6,84	-	501	576
						6	328	1000	666	345	1,29	19,26	9,78	-	573	659
291	037	045 060 100	LR	YY	00	7	378	450	406	215	1,24	10,43	6,58	-	492	566
						7	378	600	511	268	1,26	14,00	7,98	-	524	603
						7	378	1000	777	402	1,29	22,47	11,41	-	608	699
291	042	045 060 100	LR	YY	00	8	428	450	464	246	1,24	11,92	7,52	-	519	597
						8	428	600	584	307	1,26	16,00	9,12	-	561	645
						8	428	1000	888	459	1,29	25,68	13,04	-	650	748
291	047	045 060 100	LR	YY	00	9	478	450	522	277	1,24	13,41	8,46	-	536	616
						9	478	600	657	345	1,26	18,00	10,26	-	581	668
						9	478	1000	999	517	1,29	28,89	14,67	-	683	785
291	052	045 060 100	LR	YY	00	10	528	450	580	308	1,24	14,90	9,40	-	560	644
						10	528	600	730	384	1,26	20,00	11,40	-	608	699
						10	528	1000	1110	574	1,29	32,10	16,30	-	720	828
291	057	045 060 100	LR	YY	00	11	578	450	638	339	1,24	16,39	10,34	-	582	669
						11	578	600	803	422	1,26	22,00	12,54	-	636	731
						11	578	1000	1221	632	1,29	35,31	17,93	-	761	875
291	062	045 060 100	LR	YY	00	12	628	450	696	369	1,24	17,88	11,28	-	605	696
						12	628	600	876	460	1,26	24,00	13,68	-	664	764
						12	628	1000	1332	689	1,29	38,52	19,56	-	798	918
291	067	045 060 100	LR	YY	00	13	678	450	754	400	1,24	19,37	12,22	-	623	716
						13	678	600	949	499	1,26	26,00	14,82	-	686	789
						13	678	1000	1443	747	1,29	41,73	21,19	-	832	957
291	072	045 060 100	LR	YY	00	14	728	450	812	431	1,24	20,86	13,16	-	642	738
						14	728	600	1022	537	1,26	28,00	15,96	-	712	819
						14	728	1000	1554	804	1,29	44,94	22,82	-	870	1001
291	077	045 060 100	LR	YY	00	15	778	450	870	462	1,24	22,35	14,10	-	664	764
						15	778	600	1095	575	1,26	30,00	17,10	-	736	846
						15	778	1000	1665	861	1,29	48,15	24,45	-	902	1037

Conform EN442-1: 2014: radiatoren en convectoren

\* RAL 9016: geen meerprijs 15%

Voor meer details over onze artikel-data, zie artikel-database: <https://www.2ba.nl>

Voor de warmteafgifte van andere regimes, kijkt u op p. 370 (correctiefactoren)  
 NEDERLAND. Prijzen in euro (excl. BTW)

HOE VINTAGE 50 BESTELLEN

Leveringstermijn 15 - 30 werkdagen  
(zonder transportduur)

VINTAGE (VINTAGE 50 / D160)

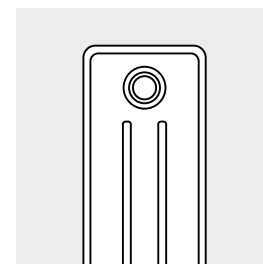
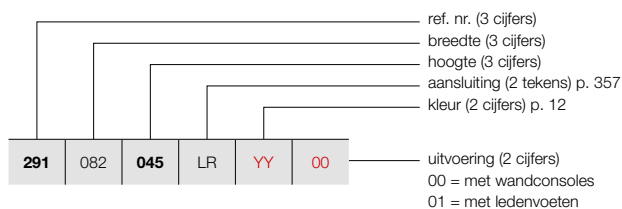

VINTAGE 50 / D160

PRIJSGROEP: VPG5 - KOLOMRADIATOREN

BESTELCODE MAATWERK VINTAGE 50	TECHNISCHE GEGEVENS								STANDAARDKLEUR	ANDERE KLEUREN						
	buizen	breedte (L mm)	hoogte (H mm)	75/65/20 (Watt) (Ø50K)	55/45/20 (Watt) (Ø30K)	n-exp.	gewicht (kg)	inhoud (l)			el. weerst. (Watt)	prijs S600* (€)	prijs kleur (€)			
REF. NR. VINTAGE 50 VINTAGE 50/D160 : 291																
291	082	045	LR	YY	00	16	828	450	928	493	1,24	23,84	15,04	-	680	782
		060				16	828	600	1168	614	1,26	32,00	18,24	-	759	873
		100				16	828	1000	1776	919	1,29	51,36	26,08	-	937	1078
291	087	045	LR	YY	00	17	878	450	986	523	1,24	25,33	15,98	-	701	806
		060				17	878	600	1241	652	1,26	34,00	19,38	-	785	903
		100				17	878	1000	1887	976	1,29	54,57	27,71	-	975	1121
291	092	045	LR	YY	00	18	928	450	1044	554	1,24	26,82	16,92	-	720	828
		060				18	928	600	1314	690	1,26	36,00	20,52	-	810	932
		100				18	928	1000	1998	1034	1,29	57,78	29,34	-	1011	1163
291	097	045	LR	YY	00	19	978	450	1102	585	1,24	28,31	17,86	-	738	849
		060				19	978	600	1387	729	1,26	38,00	21,66	-	832	957
		100				19	978	1000	2109	1091	1,29	60,99	30,97	-	1046	1203
291	102	045	LR	YY	00	20	1028	450	1160	616	1,24	29,80	18,80	-	759	873
		060				20	1028	600	1460	767	1,26	40,00	22,80	-	856	984
		100				20	1028	1000	2220	1149	1,29	64,20	32,60	-	1082	1244
291	107	045	LR	YY	00	21	1078	450	1218	646	1,24	31,29	19,74	-	793	912
		060				21	1078	600	1533	805	1,26	42,00	23,94	-	897	1032
		100				21	1078	1000	2331	1206	1,29	67,41	34,23	-	1131	1301
291	112	045	LR	YY	00	22	1128	450	1276	677	1,24	32,78	20,68	-	813	935
		060				22	1128	600	1606	844	1,26	44,00	25,08	-	920	1058
		100				22	1128	1000	2442	1263	1,29	70,62	35,86	-	1166	1341
291	117	045	LR	YY	00	23	1178	450	1334	708	1,24	34,27	21,62	-	832	957
		060				23	1178	600	1679	882	1,26	46,00	26,22	-	941	1082
		100				23	1178	1000	2553	1321	1,29	73,83	37,49	-	1201	1381
291	122	045	LR	YY	00	24	1228	450	1392	739	1,24	35,76	22,56	-	850	978
		060				24	1228	600	1752	920	1,26	48,00	27,36	-	968	1113
		100				24	1228	1000	2664	1378	1,29	77,04	39,12	-	1237	1423
291	127	045	LR	YY	00	25	1278	450	1450	770	1,24	37,25	23,50	-	872	1003
		060				25	1278	600	1825	959	1,26	50,00	28,50	-	991	1140
		100				25	1278	1000	2775	1436	1,29	80,25	40,75	-	1273	1464
291	132	045	LR	YY	00	26	1328	450	1508	800	1,24	38,74	24,44	-	912	1049
		060				26	1328	600	1898	997	1,26	52,00	29,64	-	1037	1193
		100				26	1328	1000	2886	1493	1,29	83,46	42,38	-	1327	1526
291	137	045	LR	YY	00	27	1378	450	1566	831	1,24	40,23	25,38	-	929	1068
		060				27	1378	600	1971	1036	1,26	54,00	30,78	-	1059	1218
		100				27	1378	1000	2997	1551	1,29	86,67	44,01	-	1363	1567
291	142	045	LR	YY	00	28	1428	450	1624	862	1,24	41,72	26,32	-	946	1088
		060				28	1428	600	2044	1074	1,26	56,00	31,92	-	1083	1245
		100				28	1428	1000	3108	1608	1,29	89,88	45,64	-	1397	1607

Conform EN442-1: 2014: radiatoren en convectoren

\* RAL 9016: geen meerprijs 15%

Voor meer details over onze artikel-data, zie artikel-database: <https://www.2ba.nl>

Voor de warmteafgiftes van andere regimes, kijkt u op p. 370 (correctiefactoren)  
NEDERLAND. Prijzen in euro (excl. BTW)

# VINTAGE (VINTAGE 50 / D160)

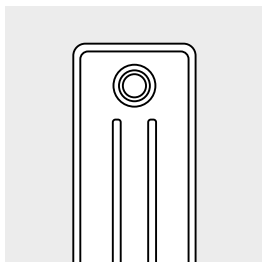

VINTAGE 50 / D160

## HOE VINTAGE 50 BESTELLEN

Leveringstermijn 15 - 30 werkdagen  
(zonder transportduur)

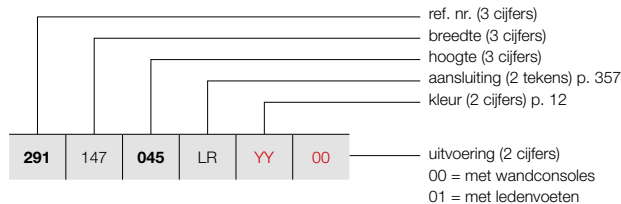

### PRIJSGROEP: VPG5 - KOLOMRADIATOREN

BESTELCODE MAATWERK VINTAGE 50							TECHNISCHE GEGEVENS						STANDAARDKLEUR	ANDERE KLEUREN		
ref. nr.	breedte	hoogte	aansluiting	kleur	uitvoering	buizen	breedte (L mm)	hoogte (H mm)	75/65/20 (Watt) (Φ50K)	55/45/20 (Watt) (Φ30K)	n-exp.	gewicht (kg)	inhoud (l)	el. weerst. (Watt)	prijs S600* (€)	prijs kleur (€)
<b>REF. NR. VINTAGE 50 VINTAGE 50/D160 : 291</b>																
<b>291</b>	<b>147</b>	<b>045</b>	<b>LR</b>	<b>YY</b>	<b>00</b>	29	1478	450	1682	893	1,24	43,21	27,26	-	<b>968</b>	<b>1113</b>
		<b>060</b>				29	1478	600	2117	1112	1,26	58,00	33,06	-	<b>1105</b>	<b>1271</b>
		<b>100</b>				29	1478	1000	3219	1665	1,29	93,09	47,27	-	<b>1432</b>	<b>1647</b>
<b>291</b>	<b>152</b>	<b>045</b>	<b>LR</b>	<b>YY</b>	<b>00</b>	30	1528	450	1740	924	1,24	44,70	28,20	-	<b>986</b>	<b>1134</b>
		<b>060</b>				30	1528	600	2190	1151	1,26	60,00	34,20	-	<b>1134</b>	<b>1304</b>
		<b>100</b>				30	1528	1000	3330	1723	1,29	96,30	48,90	-	<b>1464</b>	<b>1684</b>
<b>291</b>	<b>157</b>	<b>045</b>	<b>LR</b>	<b>YY</b>	<b>00</b>	31	1578	450	1798	954	1,24	46,19	29,14	-	<b>1006</b>	<b>1157</b>
		<b>060</b>				31	1578	600	2263	1189	1,26	62,00	34,34	-	<b>1156</b>	<b>1329</b>
<b>291</b>	<b>162</b>	<b>045</b>	<b>LR</b>	<b>YY</b>	<b>00</b>	32	1628	450	1856	985	1,24	47,68	30,08	-	<b>1024</b>	<b>1178</b>
		<b>060</b>				32	1628	600	2336	1227	1,26	64,00	36,48	-	<b>1180</b>	<b>1357</b>
<b>291</b>	<b>167</b>	<b>045</b>	<b>LR</b>	<b>YY</b>	<b>00</b>	33	1678	450	1914	1016	1,24	49,17	31,02	-	<b>1090</b>	<b>1254</b>
		<b>060</b>				33	1678	600	2409	1266	1,26	66,00	37,62	-	<b>1248</b>	<b>1435</b>
<b>291</b>	<b>172</b>	<b>045</b>	<b>LR</b>	<b>YY</b>	<b>00</b>	34	1728	450	1972	1047	1,24	50,66	31,96	-	<b>1105</b>	<b>1271</b>
		<b>060</b>				34	1728	600	2482	1304	1,26	68,00	38,76	-	<b>1275</b>	<b>1466</b>
<b>291</b>	<b>177</b>	<b>045</b>	<b>LR</b>	<b>YY</b>	<b>00</b>	35	1778	450	2030	1077	1,24	52,15	32,90	-	<b>1128</b>	<b>1297</b>
		<b>060</b>				35	1778	600	2555	1342	1,26	70,00	39,90	-	<b>1294</b>	<b>1488</b>
<b>291</b>	<b>182</b>	<b>045</b>	<b>LR</b>	<b>YY</b>	<b>00</b>	36	1828	450	2088	1108	1,24	53,64	33,84	-	<b>1155</b>	<b>1328</b>
		<b>060</b>				36	1828	600	2628	1381	1,26	72,00	41,04	-	<b>1329</b>	<b>1528</b>
<b>291</b>	<b>187</b>	<b>045</b>	<b>LR</b>	<b>YY</b>	<b>00</b>	37	1878	450	2146	1139	1,24	55,13	34,78	-	<b>1170</b>	<b>1346</b>
		<b>060</b>				37	1878	600	2701	1419	1,26	74,00	42,18	-	<b>1347</b>	<b>1549</b>
<b>291</b>	<b>192</b>	<b>045</b>	<b>LR</b>	<b>YY</b>	<b>00</b>	38	1928	450	2204	1170	1,24	56,62	35,72	-	<b>1192</b>	<b>1371</b>
		<b>060</b>				38	1928	600	2774	1457	1,26	76,00	43,32	-	<b>1377</b>	<b>1584</b>
<b>291</b>	<b>197</b>	<b>045</b>	<b>LR</b>	<b>YY</b>	<b>00</b>	39	1978	450	2262	1201	1,24	58,11	36,66	-	<b>1210</b>	<b>1392</b>
		<b>060</b>				39	1978	600	2847	1496	1,26	78,00	44,46	-	<b>1401</b>	<b>1611</b>
<b>291</b>	<b>202</b>	<b>045</b>	<b>LR</b>	<b>YY</b>	<b>00</b>	40	2028	450	2320	1231	1,24	59,60	37,60	-	<b>1230</b>	<b>1415</b>
		<b>060</b>				40	2028	600	2920	1534	1,26	80,00	45,60	-	<b>1424</b>	<b>1638</b>
<b>291</b>	<b>207</b>	<b>045</b>	<b>LR</b>	<b>YY</b>	<b>00</b>	41	2078	450	2378	1262	1,24	61,09	38,54	-	<b>1252</b>	<b>1440</b>
		<b>060</b>				41	2078	600	2993	1572	1,26	82,00	46,74	-	<b>1449</b>	<b>1666</b>
<b>291</b>	<b>212</b>	<b>045</b>	<b>LR</b>	<b>YY</b>	<b>00</b>	42	2128	450	2436	1293	1,24	62,58	39,48	-	<b>1272</b>	<b>1463</b>
		<b>060</b>				42	2128	600	3066	1611	1,26	84,00	47,88	-	<b>1477</b>	<b>1699</b>
<b>291</b>	<b>217</b>	<b>045</b>	<b>LR</b>	<b>YY</b>	<b>00</b>	43	2178	450	2494	1324	1,24	64,07	40,42	-	<b>1290</b>	<b>1484</b>
		<b>060</b>				43	2178	600	3139	1649	1,26	86,00	49,02	-	<b>1496</b>	<b>1720</b>
<b>291</b>	<b>222</b>	<b>045</b>	<b>LR</b>	<b>YY</b>	<b>00</b>	44	2228	450	2552	1355	1,24	65,56	41,36	-	<b>1309</b>	<b>1505</b>
		<b>060</b>				44	2228	600	3212	1688	1,26	88,00	50,16	-	<b>1519</b>	<b>1747</b>

Conform EN442-1: 2014: radiatoren en convectoren

\* RAL 9016: geen meerprijs 15%

Voor meer details over onze artikel-data, zie artikel-database: <https://www.2ba.nl>

Voor de warmteafgiftes van andere regimes, kijkt u op p. 370 (correctiefactoren)  
**NEDERLAND. Prijzen in euro (excl. BTW)**

## HOE VINTAGE 50 BESTELLEN

Leveringstermijn 15 - 30 werkdagen  
(zonder transportduur)

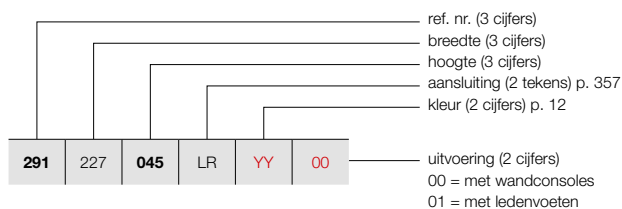

## VINTAGE (VINTAGE 50 / D160)

349

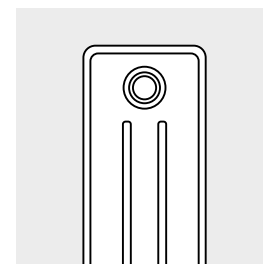

VINTAGE 50 / D160

### PRIJSGROEP: VPG5 - KOLOMRADIATOREN

BESTELCODE MAATWERK VINTAGE 50	TECHNISCHE GEGEVENS							STANDAARDKLEUR		ANDERE KLEUREN						
	buizen	breedte (L mm)	hoogte (H mm)	75/65/20 (Watt) (Φ50K)	55/45/20 (Watt) (Φ30K)	n-exp.	gewicht (kg)	inhoud (l)	el. weerst. (Watt)	prijs S600* (€)	prijs kleur (€)					
REF. NR. VINTAGE 50 VINTAGE 50/D160 : 291																
291	227	045	LR	YY	00											
		060														
						45	2278	450	2610	1385	1,24	67,05	42,30	-	1330	1530
						45	2278	600	3285	1726	1,26	90,00	51,30	-	1545	1777
291	232	045	LR	YY	00											
		060														
						46	2328	450	2668	1416	1,24	68,54	43,24	-	1345	1547
						46	2328	600	3358	1764	1,26	92,00	52,44	-	1569	1804
291	237	045	LR	YY	00											
		060														
						47	2378	450	2726	1447	1,24	70,03	44,18	-	1367	1572
						47	2378	600	3431	1803	1,26	94,00	53,58	-	1594	1833
291	242	045	LR	YY	00											
		060														
						48	2428	450	2784	1478	1,24	71,52	45,12	-	1387	1595
						48	2428	600	3504	1841	1,26	96,00	54,72	-	1616	1858
291	247	045	LR	YY	00											
						49	2478	450	2842	1508	1,24	73,01	46,06	-	1406	1617
291	252	045	LR	YY	00											
						50	2528	450	2900	1539	1,24	74,50	47,00	-	1425	1639
291	257	045	LR	YY	00											
						51	2578	450	2958	1570	1,24	75,99	47,94	-	1462	1681
291	262	045	LR	YY	00											
						52	2628	450	3016	1601	1,24	77,48	48,88	-	1484	1707
291	267	045	LR	YY	00											
						53	2678	450	3074	1632	1,24	78,97	49,82	-	1501	1726
291	272	045	LR	YY	00											
						54	2728	450	3132	1662	1,24	80,46	50,76	-	1522	1750
291	277	045	LR	YY	00											
						55	2778	450	3190	1693	1,24	81,95	51,70	-	1542	1773
291	282	045	LR	YY	00											
						56	2828	450	3248	1724	1,24	83,44	52,64	-	1563	1797
291	287	045	LR	YY	00											
						57	2878	450	3306	1755	1,24	84,93	53,58	-	1581	1818
291	292	045	LR	YY	00											
						58	2928	450	3364	1786	1,24	86,42	54,52	-	1601	1841
291	297	045	LR	YY	00											
						59	2978	450	3422	1816	1,24	87,91	55,46	-	1619	1862
291	302	045	LR	YY	00											
						60	3028	450	3480	1847	1,24	89,40	56,40	-	1639	1885

Conform EN442-1: 2014: radiatoren en convectoren

\* RAL 9016: geen meerprijs 15%

Voor meer details over onze artikel-data, zie artikel-database: <https://www.2ba.nl>

**Voor de warmteafgiftes van andere regimes, kijkt u op p. 370 (correctiefactoren)**  
**NEDERLAND. Prijzen in euro (excl. BTW)**

# VINTAGE (VINTAGE 50 / D220)

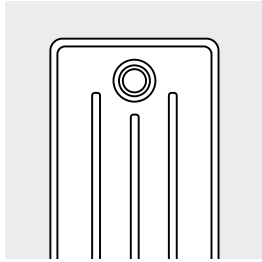

VINTAGE 50 / D220

## HOE VINTAGE 50 BESTELLEN

Leveringstermijn 15 - 30 werkdagen  
(zonder transportduur)

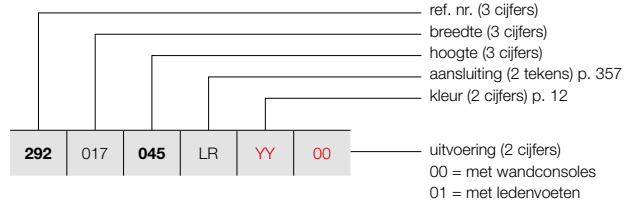

### PRIJSGROEP: VPG5 - KOLOMRADIATOREN

BESTELCODE MAATWERK VINTAGE 50							TECHNISCHE GEGEVENS				STANDAARDKLEUR	ANDERE KLEUREN				
buizen	breedte (L mm)	hoogte (H mm)	75/65/20 (Watt) (Ø50K)	55/45/20 (Watt) (Ø30K)	n-exp.	gewicht (kg)	inhoud (l)	el. weerst. (Watt)	prijs S600* (€)	prijs kleur (€)						
<b>REF. NR. VINTAGE 50 VINTAGE 50/D220 : 292</b>																
292	017	045	LR	YY	00	3	178	450	225	119	1,25	6,00	3,69	-	426	490
		060				3	178	600	282	148	1,26	7,86	4,44	-	444	511
		100				3	178	1000	435	226	1,28	13,68	7,26	-	492	566
292	022	045	LR	YY	00	4	228	450	300	158	1,25	8,00	4,92	-	446	513
		060				4	228	600	376	198	1,26	10,48	5,92	-	475	546
		100				4	228	1000	580	302	1,28	18,24	9,68	-	536	616
292	027	045	LR	YY	00	5	278	450	375	198	1,25	10,00	6,15	-	474	545
		060				5	278	600	470	247	1,26	13,10	7,40	-	507	583
		100				5	278	1000	725	377	1,28	22,80	12,10	-	582	669
292	032	045	LR	YY	00	6	328	450	450	238	1,25	12,00	7,38	-	498	573
		060				6	328	600	564	296	1,26	15,72	8,88	-	535	615
		100				6	328	1000	870	452	1,28	27,36	14,52	-	631	726
292	037	045	LR	YY	00	7	378	450	525	277	1,25	14,00	8,61	-	520	598
		060				7	378	600	658	346	1,26	18,34	10,36	-	566	651
		100				7	378	1000	1015	528	1,28	31,92	16,94	-	675	776
292	042	045	LR	YY	00	8	428	450	600	317	1,25	16,00	9,84	-	556	639
		060				8	428	600	752	395	1,26	20,96	11,84	-	605	696
		100				8	428	1000	1160	603	1,28	36,48	19,36	-	726	835
292	047	045	LR	YY	00	9	478	450	675	356	1,25	18,00	11,07	-	575	661
		060				9	478	600	846	444	1,26	23,58	13,32	-	633	728
		100				9	478	1000	1305	679	1,28	41,04	21,78	-	770	886
292	052	045	LR	YY	00	10	528	450	750	396	1,25	20,00	12,30	-	598	688
		060				10	528	600	940	494	1,26	26,20	14,80	-	664	764
		100				10	528	1000	1450	754	1,28	45,60	24,20	-	817	940
292	057	045	LR	YY	00	11	578	450	825	436	1,25	22,00	13,53	-	631	726
		060				11	578	600	1034	543	1,26	28,82	16,28	-	697	802
		100				11	578	1000	1595	829	1,28	50,16	26,62	-	872	1003
292	062	045	LR	YY	00	12	628	450	900	475	1,25	24,00	14,76	-	652	750
		060				12	628	600	1128	593	1,26	31,44	17,76	-	730	840
		100				12	628	1000	1740	905	1,28	54,72	29,04	-	916	1053
292	067	045	LR	YY	00	13	678	450	975	515	1,25	26,00	15,99	-	676	777
		060				13	678	600	1222	642	1,26	34,06	19,24	-	759	873
		100				13	678	1000	1885	980	1,28	59,28	31,46	-	961	1105
292	072	045	LR	YY	00	14	728	450	1050	554	1,25	28,00	17,22	-	697	802
		060				14	728	600	1316	691	1,26	36,68	20,72	-	790	909
		100				14	728	1000	2030	1056	1,28	63,84	33,88	-	1004	1155
292	077	045	LR	YY	00	15	778	450	1125	594	1,25	30,00	18,45	-	724	833
		060				15	778	600	1410	741	1,26	39,30	22,20	-	817	940
		100				15	778	1000	2175	1131	1,28	68,40	36,30	-	1050	1208

Conform EN442-1: 2014: radiatoren en convectoren

\* RAL 9016: geen meerprijs 15%

Voor meer details over onze artikel-data, zie artikel-database: <https://www.2ba.nl>

Voor de warmteafgifte van andere regimes, kijkt u op p. 370 (correctiefactoren)  
NEDERLAND. Prijzen in euro (excl. BTW)

HOE VINTAGE 50 BESTELLEN

Leveringstermijn 15 - 30 werkdagen  
(zonder transportduur)

VINTAGE (VINTAGE 50 / D220)

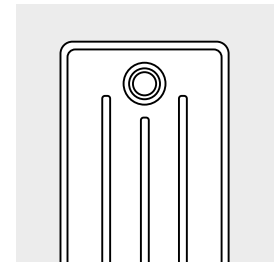
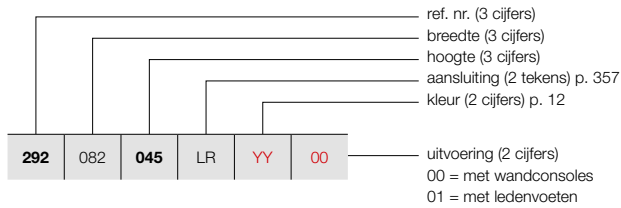

VINTAGE 50 / D220

PRIJSGROEP: VPG5 - KOLOMRADIATOREN

BESTELCODE MAATWERK VINTAGE 50	TECHNISCHE GEGEVENS							STANDAARDKLEUR	ANDERE KLEUREN		
	buizen	breedte (L mm)	hoogte (H mm)	75/65/20 (Watt) (φ50K)	55/45/20 (Watt) (φ30K)	n-exp.	gewicht (kg)			inhoud (l)	el. weerst. (Watt)
<b>REF. NR. VINTAGE 50 VINTAGE 50/D220 : 292</b>											
292 082 045 LR YY 00	16	828	450	1200	634	1,25	32,00	19,68	-	745	857
	16	828	600	1504	790	1,26	41,92	23,68	-	847	974
	16	828	1000	2320	1206	1,28	72,96	38,72	-	1096	1260
292 087 045 LR YY 00	17	878	450	1275	673	1,25	34,00	20,91	-	768	883
	17	878	600	1598	840	1,26	44,54	25,16	-	878	1010
	17	878	1000	2465	1282	1,28	77,52	41,14	-	1143	1314
292 092 045 LR YY 00	18	928	450	1350	713	1,25	36,00	22,14	-	793	912
	18	928	600	1692	889	1,26	47,16	26,64	-	912	1049
	18	928	1000	2610	1357	1,28	82,08	43,56	-	1187	1365
292 097 045 LR YY 00	19	978	450	1425	752	1,25	38,00	23,37	-	815	937
	19	978	600	1786	938	1,26	49,78	28,12	-	936	1076
	19	978	1000	2755	1433	1,28	86,64	45,98	-	1233	1418
292 102 045 LR YY 00	20	1028	450	1500	792	1,25	40,00	24,60	-	841	967
	20	1028	600	1880	988	1,26	52,40	29,60	-	968	1113
	20	1028	1000	2900	1508	1,28	91,20	48,40	-	1278	1470
292 107 045 LR YY 00	21	1078	450	1575	832	1,25	42,00	25,83	-	877	1009
	21	1078	600	1974	1037	1,26	55,02	31,08	-	1011	1163
	21	1078	1000	3045	1584	1,28	95,76	50,82	-	1337	1538
292 112 045 LR YY 00	22	1128	450	1650	871	1,25	44,00	27,06	-	901	1036
	22	1128	600	2068	1086	1,26	57,64	32,56	-	1042	1198
	22	1128	1000	3190	1659	1,28	100,32	53,24	-	1381	1588
292 117 045 LR YY 00	23	1178	450	1725	911	1,25	46,00	28,29	-	923	1061
	23	1178	600	2162	1136	1,26	60,26	34,04	-	1072	1233
	23	1178	1000	3335	1734	1,28	104,88	55,66	-	1426	1640
292 122 045 LR YY 00	24	1228	450	1800	951	1,25	48,00	29,52	-	946	1088
	24	1228	600	2256	1185	1,26	62,88	35,52	-	1099	1264
	24	1228	1000	3480	1810	1,28	109,44	58,08	-	1477	1699
292 127 045 LR YY 00	25	1278	450	1875	990	1,25	50,00	30,75	-	971	1117
	25	1278	600	2350	1235	1,26	65,50	37,00	-	1131	1301
	25	1278	1000	3625	1885	1,28	114,00	60,50	-	1515	1742
292 132 045 LR YY 00	26	1328	450	1950	1030	1,25	52,00	31,98	-	1012	1164
	26	1328	600	2444	1284	1,26	68,12	38,48	-	1178	1355
	26	1328	1000	3770	1961	1,28	118,56	62,92	-	1582	1819
292 137 045 LR YY 00	27	1378	450	2025	1069	1,25	54,00	33,21	-	1038	1194
	27	1378	600	2538	1333	1,26	70,74	39,96	-	1207	1388
	27	1378	1000	3915	2036	1,28	123,12	65,34	-	1626	1870
292 142 045 LR YY 00	28	1428	450	2100	1109	1,25	56,00	34,44	-	1059	1218
	28	1428	600	2632	1383	1,26	73,36	41,44	-	1237	1423
	28	1428	1000	4060	2111	1,28	127,68	67,76	-	1671	1922

Conform EN442-1: 2014: radiatoren en convectoren

\* RAL 9016: geen meerprijs 15%

Voor meer details over onze artikel-data, zie artikel-database: <https://www.2ba.nl>

Voor de warmteafgiftes van andere regimes, kijkt u op p. 370 (correctiefactoren)  
NEDERLAND. Prijzen in euro (excl. BTW)

# VINTAGE (VINTAGE 50 / D220)

**HOE VINTAGE 50 BESTELLEN**  
Leveringstermijn 15 - 30 werkdagen  
(zonder transportduur)

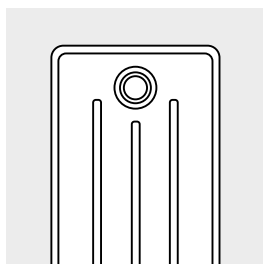

VINTAGE 50 / D220

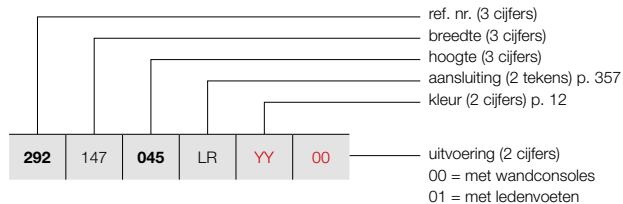

**PRIJSGROEP: VPG5 - KOLOMRADIATOREN**

BESTELCODE MAATWERK VINTAGE 50							TECHNISCHE GEGEVENS				STANDAARDKLEUR	ANDERE KLEUREN					
292	147	045	LR	YY	00	buizen	breedte (L mm)	hoogte (H mm)	75/65/20 (Watt) (Φ50K)	55/45/20 (Watt) (Φ30K)	n-exp.	gewicht (kg)	inhoud (l)	el. weerst. (Watt)	prijs S600* (€)	prijs kleur (€)	
<b>REF. NR. VINTAGE 50 VINTAGE 50/D220 : 292</b>																	
292	147	045	LR	YY	00	29	1478	450	2175	1149	1,25	58,00	35,67	-	1083	1245	
		060				29	1478	600	2726	1432	1,26	75,98	42,92	-	1262	1451	
		100				29	1478	1000	4205	2187	1,28	132,24	70,18	-	1717	1975	
292	152	045	LR	YY	00	30	1528	450	2250	1188	1,25	60,00	36,90	-	1104	1270	
		060				30	1528	600	2820	1482	1,26	78,60	44,40	-	1294	1488	
		100				30	1528	1000	4350	2262	1,28	136,80	72,60	-	1762	2026	
292	157	045	LR	YY	00	31	1578	450	2325	1228	1,25	62,00	38,13	-	1131	1301	
		060				31	1578	600	2914	1531	1,26	81,22	45,88	-	1329	1528	
292	162	045	LR	YY	00	32	1628	450	2400	1267	1,25	64,00	39,36	-	1155	1328	
		060				32	1628	600	3008	1580	1,26	83,84	47,36	-	1357	1561	
292	167	045	LR	YY	00	33	1678	450	2475	1307	1,25	66,00	40,59	-	1223	1406	
		060				33	1678	600	3102	1630	1,26	86,46	48,84	-	1427	1641	
292	172	045	LR	YY	00	34	1728	450	2550	1347	1,25	68,00	41,82	-	1246	1433	
		060				34	1728	600	3196	1679	1,26	89,08	50,32	-	1457	1676	
292	177	045	LR	YY	00	35	1778	450	2625	1386	1,25	70,00	43,05	-	1262	1451	
		060				35	1778	600	3290	1728	1,26	91,70	51,80	-	1490	1714	
292	182	045	LR	YY	00	36	1828	450	2700	1426	1,25	72,00	44,28	-	1294	1488	
		060				36	1828	600	3384	1778	1,26	94,32	53,28	-	1524	1753	
292	187	045	LR	YY	00	37	1878	450	2775	1465	1,25	74,00	45,51	-	1322	1520	
		060				37	1878	600	3478	1827	1,26	96,36	54,76	-	1553	1786	
292	192	045	LR	YY	00	38	1928	450	2850	1505	1,25	76,00	46,74	-	1342	1543	
		060				38	1928	600	3572	1877	1,26	99,56	56,24	-	1583	1820	
292	197	045	LR	YY	00	39	1978	450	2925	1545	1,25	78,00	47,97	-	1367	1572	
		060				39	1978	600	3666	1926	1,26	102,18	57,72	-	1613	1855	
292	202	045	LR	YY	00	40	2028	450	3000	1584	1,25	80,00	49,20	-	1389	1597	
		060				40	2028	600	3760	1975	1,26	104,80	59,20	-	1645	1892	
292	207	045	LR	YY	00	41	2078	450	3075	1624	1,25	82,00	50,43	-	1416	1628	
		060				41	2078	600	3854	2025	1,26	107,42	60,68	-	1672	1923	
292	212	045	LR	YY	00	42	2128	450	3150	1663	1,25	84,00	51,66	-	1437	1653	
		060				42	2128	600	3948	2074	1,26	110,04	62,16	-	1702	1957	
292	217	045	LR	YY	00	43	2178	450	3225	1703	1,25	86,00	52,89	-	1459	1678	
		060				43	2178	600	4042	2124	1,26	112,66	63,64	-	1731	1991	
292	222	045	LR	YY	00	44	2228	450	3300	1743	1,25	88,00	54,12	-	1485	1708	
		060				44	2228	600	4136	2173	1,26	115,28	65,12	-	1764	2029	

Conform EN442-1: 2014: radiatoren en convectoren

\* RAL 9016: geen meerprijs 15%

Voor meer details over onze artikel-data, zie artikel-database: <https://www.2ba.nl>  
**Voor de warmteafgiftes van andere regimes, kijkt u op p. 370 (correctiefactoren)**  
**NEDERLAND. Prijzen in euro (excl. BTW)**

## HOE VINTAGE 50 BESTELLEN

Leveringstermijn 15 - 30 werkdagen  
(zonder transportduur)

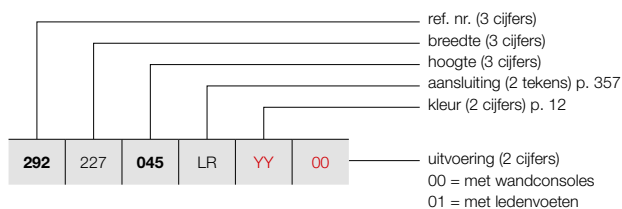

## VINTAGE (VINTAGE 50 / D220)

353

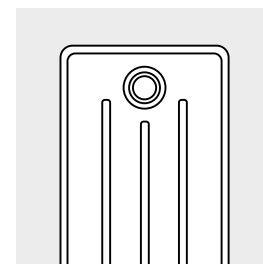

VINTAGE 50 / D220

### PRIJSGROEP: VPG5 - KOLOMRADIATOREN

BESTELCODE MAATWERK VINTAGE 50	TECHNISCHE GEGEVENS								STANDAARDKLEUR	ANDERE KLEUREN						
	buizen	breedte (L mm)	hoogte (H mm)	75/65/20 (Watt) (Φ50K)	55/45/20 (Watt) (Φ30K)	n-exp.	gewicht (kg)	inhoud (l)			el. weerst. (Watt)	prijs S600* (€)	prijs kleur (€)			
<b>REF. NR. VINTAGE 50 VINTAGE 50/D220 : 292</b>																
<b>292</b>	227	<b>045</b>	LR	<b>YY</b>	<b>00</b>	45	2278	450	3375	1782	1,25	90,00	55,35	-	<b>1506</b>	<b>1732</b>
		<b>060</b>				45	2278	600	4230	2222	1,26	117,90	66,60	-	<b>1791</b>	<b>2060</b>
<b>292</b>	232	<b>045</b>	LR	<b>YY</b>	<b>00</b>	46	2328	450	3450	1822	1,25	93,84	56,58	-	<b>1534</b>	<b>1764</b>
		<b>060</b>				46	2328	600	4324	2272	1,26	120,52	68,08	-	<b>1821</b>	<b>2094</b>
<b>292</b>	237	<b>045</b>	LR	<b>YY</b>	<b>00</b>	47	2378	450	3525	1861	1,25	94,00	57,81	-	<b>1553</b>	<b>1786</b>
		<b>060</b>				47	2378	600	4418	2321	1,26	123,14	69,56	-	<b>1853</b>	<b>2131</b>
<b>292</b>	242	<b>045</b>	LR	<b>YY</b>	<b>00</b>	48	2428	450	3600	1901	1,25	96,00	59,04	-	<b>1579</b>	<b>1816</b>
		<b>060</b>				48	2428	600	4512	2370	1,26	125,76	71,04	-	<b>1881</b>	<b>2163</b>
<b>292</b>	247	<b>045</b>	LR	<b>YY</b>	<b>00</b>	49	2478	450	3675	1941	1,25	99,96	60,27	-	<b>1601</b>	<b>1841</b>
		<b>060</b>				49	2478	600	4606	2420	1,26	128,38	72,52	-	<b>1909</b>	<b>2195</b>
<b>292</b>	252	<b>045</b>	LR	<b>YY</b>	<b>00</b>	50	2528	450	3750	1980	1,25	102,00	61,50	-	<b>1625</b>	<b>1869</b>
		<b>060</b>				50	2528	600	4700	2469	1,26	131,00	74,00	-	<b>1944</b>	<b>2236</b>
<b>292</b>	257	<b>045</b>	LR	<b>YY</b>	<b>00</b>	51	2578	450	3825	2020	1,25	104,04	62,73	-	<b>1668</b>	<b>1918</b>
<b>292</b>	262	<b>045</b>	LR	<b>YY</b>	<b>00</b>	52	2628	450	3900	2059	1,25	106,08	63,96	-	<b>1690</b>	<b>1944</b>
<b>292</b>	267	<b>045</b>	LR	<b>YY</b>	<b>00</b>	53	2678	450	3975	2099	1,25	108,12	65,19	-	<b>1714</b>	<b>1971</b>
<b>292</b>	272	<b>045</b>	LR	<b>YY</b>	<b>00</b>	54	2728	450	4050	2139	1,25	110,16	66,42	-	<b>1737</b>	<b>1998</b>
<b>292</b>	277	<b>045</b>	LR	<b>YY</b>	<b>00</b>	55	2778	450	4125	2178	1,25	112,20	67,65	-	<b>1761</b>	<b>2025</b>
<b>292</b>	282	<b>045</b>	LR	<b>YY</b>	<b>00</b>	56	2828	450	4200	2218	1,25	114,24	68,88	-	<b>1781</b>	<b>2048</b>
<b>292</b>	287	<b>045</b>	LR	<b>YY</b>	<b>00</b>	57	2878	450	4275	2257	1,25	116,28	70,11	-	<b>1808</b>	<b>2079</b>
<b>292</b>	292	<b>045</b>	LR	<b>YY</b>	<b>00</b>	58	2928	450	4350	2297	1,25	118,32	71,34	-	<b>1830</b>	<b>2105</b>
<b>292</b>	297	<b>045</b>	LR	<b>YY</b>	<b>00</b>	59	2978	450	4425	2337	1,25	120,36	72,57	-	<b>1855</b>	<b>2133</b>
<b>292</b>	302	<b>045</b>	LR	<b>YY</b>	<b>00</b>	60	3028	450	4500	2376	1,25	122,40	73,80	-	<b>1877</b>	<b>2159</b>

Conform EN442-1: 2014: radiatoren en convectoren

\* RAL 9016: geen meerprijs 15%

Voor meer details over onze artikel-data, zie artikel-database: <https://www.2ba.nl>

Voor de warmteafgiftes van andere regimes, kijkt u op p. 370 (correctiefactoren)  
NEDERLAND. Prijzen in euro (excl. BTW)

## VINTAGE (VINTAGE 50 / D250)

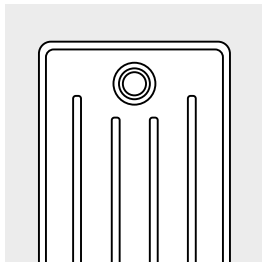

VINTAGE 50 / D250

### HOE VINTAGE 50 BESTELLEN

Leveringstermijn 15 - 30 werkdagen  
(zonder transportduur)

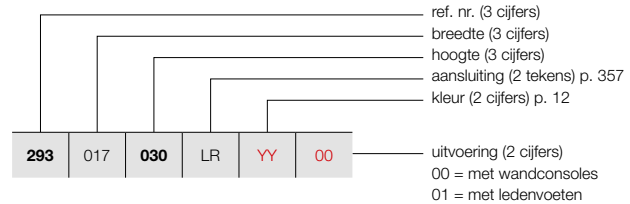

### PRIJSGROEP: VPG5 - KOLOMRADIATOREN

BESTELCODE MAATWERK VINTAGE 50	TECHNISCHE GEGEVENS										STANDAARDKLEUR	ANDERE KLEUREN
	buizen	breedte (L mm)	hoogte (H mm)	75/65/20 (Watt) (Ø50K)	55/45/20 (Watt) (Ø30K)	n-exp.	gewicht (kg)	inhoud (l)	el. weerst. (Watt)	prijs S600* (€)	prijs kleur (€)	
<b>REF. NR. VINTAGE 50 VINTAGE 50/D250 : 293</b>												
<b>293</b>   017   <b>030</b>   LR   <b>YY</b>   <b>00</b>	3	178	300	186	98	1,26	4,56	2,97	-	<b>433</b>	<b>498</b>	
<b>293</b>   022   <b>030</b>   LR   <b>YY</b>   <b>00</b>	4	228	300	248	130	1,26	6,08	3,96	-	<b>457</b>	<b>526</b>	
<b>293</b>   027   <b>030</b>   LR   <b>YY</b>   <b>00</b>	5	278	300	310	163	1,26	7,60	4,95	-	<b>483</b>	<b>555</b>	
<b>293</b>   032   <b>030</b>   LR   <b>YY</b>   <b>00</b>	6	328	300	372	195	1,26	9,12	5,94	-	<b>502</b>	<b>577</b>	
<b>293</b>   037   <b>030</b>   LR   <b>YY</b>   <b>00</b>	7	378	300	434	228	1,26	10,64	6,93	-	<b>524</b>	<b>603</b>	
<b>293</b>   042   <b>030</b>   LR   <b>YY</b>   <b>00</b>	8	428	300	496	261	1,26	12,16	7,92	-	<b>559</b>	<b>643</b>	
<b>293</b>   047   <b>030</b>   LR   <b>YY</b>   <b>00</b>	9	478	300	558	293	1,26	13,68	8,91	-	<b>578</b>	<b>665</b>	
<b>293</b>   052   <b>030</b>   LR   <b>YY</b>   <b>00</b>	10	528	300	620	326	1,26	15,20	9,90	-	<b>602</b>	<b>692</b>	
<b>293</b>   057   <b>030</b>   LR   <b>YY</b>   <b>00</b>	11	578	300	682	358	1,26	16,72	10,89	-	<b>631</b>	<b>726</b>	
<b>293</b>   062   <b>030</b>   LR   <b>YY</b>   <b>00</b>	12	628	300	744	391	1,26	18,34	11,88	-	<b>653</b>	<b>751</b>	
<b>293</b>   067   <b>030</b>   LR   <b>YY</b>   <b>00</b>	13	678	300	806	423	1,26	19,76	12,87	-	<b>675</b>	<b>776</b>	
<b>293</b>   072   <b>030</b>   LR   <b>YY</b>   <b>00</b>	14	728	300	868	456	1,26	21,28	13,86	-	<b>697</b>	<b>802</b>	
<b>293</b>   077   <b>030</b>   LR   <b>YY</b>   <b>00</b>	15	778	300	930	489	1,26	22,80	14,85	-	<b>723</b>	<b>831</b>	
<b>293</b>   082   <b>030</b>   LR   <b>YY</b>   <b>00</b>	16	828	300	992	521	1,26	24,32	15,84	-	<b>744</b>	<b>856</b>	
<b>293</b>   087   <b>030</b>   LR   <b>YY</b>   <b>00</b>	17	878	300	1054	554	1,26	25,84	16,83	-	<b>766</b>	<b>881</b>	
<b>293</b>   092   <b>030</b>   LR   <b>YY</b>   <b>00</b>	18	928	300	1116	586	1,26	27,36	17,82	-	<b>790</b>	<b>909</b>	
<b>293</b>   097   <b>030</b>   LR   <b>YY</b>   <b>00</b>	19	978	300	1178	619	1,26	28,88	18,81	-	<b>812</b>	<b>934</b>	
<b>293</b>   102   <b>030</b>   LR   <b>YY</b>   <b>00</b>	20	1028	300	1240	651	1,26	30,40	19,80	-	<b>833</b>	<b>958</b>	
<b>293</b>   107   <b>030</b>   LR   <b>YY</b>   <b>00</b>	21	1078	300	1302	684	1,26	31,92	20,79	-	<b>872</b>	<b>1003</b>	
<b>293</b>   112   <b>030</b>   LR   <b>YY</b>   <b>00</b>	22	1128	300	1364	717	1,26	33,44	21,78	-	<b>893</b>	<b>1027</b>	
<b>293</b>   117   <b>030</b>   LR   <b>YY</b>   <b>00</b>	23	1178	300	1426	749	1,26	34,96	22,77	-	<b>919</b>	<b>1057</b>	
<b>293</b>   122   <b>030</b>   LR   <b>YY</b>   <b>00</b>	24	1228	300	1488	782	1,26	36,68	23,76	-	<b>937</b>	<b>1078</b>	
<b>293</b>   127   <b>030</b>   LR   <b>YY</b>   <b>00</b>	25	1278	300	1550	814	1,26	38,00	24,75	-	<b>963</b>	<b>1107</b>	
<b>293</b>   132   <b>030</b>   LR   <b>YY</b>   <b>00</b>	26	1328	300	1612	847	1,26	39,52	25,74	-	<b>1006</b>	<b>1157</b>	
<b>293</b>   137   <b>030</b>   LR   <b>YY</b>   <b>00</b>	27	1378	300	1674	879	1,26	41,04	26,73	-	<b>1030</b>	<b>1185</b>	
<b>293</b>   142   <b>030</b>   LR   <b>YY</b>   <b>00</b>	28	1428	300	1736	912	1,26	42,56	27,72	-	<b>1052</b>	<b>1210</b>	
<b>293</b>   147   <b>030</b>   LR   <b>YY</b>   <b>00</b>	29	1478	300	1798	945	1,26	44,08	28,71	-	<b>1075</b>	<b>1236</b>	

Conform EN442-1: 2014: radiatoren en convectoren

\* RAL 9016: geen meerprijs 15%

Voor meer details over onze artikel-data, zie artikel-database: <https://www.2ba.nl>

**Voor de warmteafgifte van andere regimes, kijkt u op p. 370 (correctiefactoren)**  
**NETERLAND. Prijzen in euro (excl. BTW)**

HOE VINTAGE 50 BESTELLEN

Leveringstermijn 15 - 30 werkdagen  
(zonder transportduur)

VINTAGE (VINTAGE 50 / D250)

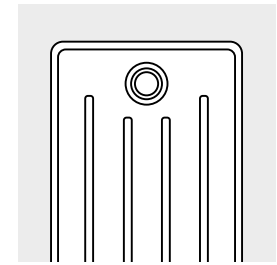
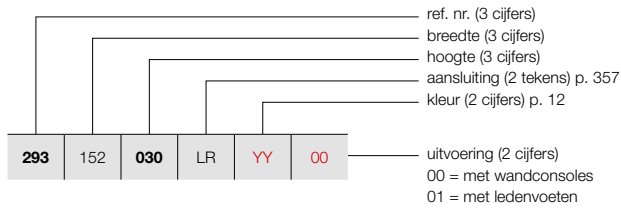

VINTAGE 50 / D250

PRIJSGROEP: VPG5 - KOLOMRADIATOREN

BESTELCODE MAATWERK VINTAGE 50	TECHNISCHE GEGEVENS										STANDAARDKLEUR prijs S600* (€)	ANDERE KLEUREN prijs kleur (€)				
	buizen	breedte (L mm)	hoogte (H mm)	75/65/20 (Watt) (Φ50K)	55/45/20 (Watt) (Φ30K)	n-exp.	gewicht (kg)	inhoud (l)	el. weerst. (Watt)							
REF. NR. VINTAGE 50 VINTAGE 50/D250 : 293																
293	152	030	LR	YY	00	30	1528	300	1860	977	1,26	45,60	29,70	-	1096	1260
293	157	030	LR	YY	00	31	1578	300	1922	1010	1,26	47,12	30,69	-	1120	1288
293	162	030	LR	YY	00	32	1628	300	1984	1042	1,26	48,64	31,68	-	1144	1316
293	167	030	LR	YY	00	33	1678	300	2046	1075	1,26	50,16	32,67	-	1208	1389
293	172	030	LR	YY	00	34	1728	300	2108	1107	1,26	51,68	33,66	-	1233	1418
293	177	030	LR	YY	00	35	1778	300	2170	1140	1,26	53,20	34,65	-	1254	1442
293	182	030	LR	YY	00	36	1828	300	2232	1173	1,26	55,02	35,64	-	1283	1475
293	187	030	LR	YY	00	37	1878	300	2294	1205	1,26	56,24	36,63	-	1305	1501
293	192	030	LR	YY	00	38	1928	300	2356	1238	1,26	57,76	37,62	-	1330	1530
293	197	030	LR	YY	00	39	1978	300	2418	1270	1,26	59,28	38,61	-	1347	1549
293	202	030	LR	YY	00	40	2028	300	2480	1303	1,26	60,80	39,60	-	1374	1580
293	207	030	LR	YY	00	41	2078	300	2542	1336	1,26	62,32	40,59	-	1397	1607
293	212	030	LR	YY	00	42	2128	300	2604	1368	1,26	63,84	41,58	-	1419	1632
293	217	030	LR	YY	00	43	2178	300	2666	1401	1,26	65,36	42,57	-	1444	1661
293	222	030	LR	YY	00	44	2228	300	2728	1433	1,26	66,88	43,56	-	1462	1681
293	227	030	LR	YY	00	45	2278	300	2790	1466	1,26	68,40	44,55	-	1489	1712
293	232	030	LR	YY	00	46	2328	300	2852	1498	1,26	69,92	45,54	-	1507	1733
293	237	030	LR	YY	00	47	2378	300	2914	1531	1,26	71,44	46,53	-	1534	1764
293	242	030	LR	YY	00	48	2428	300	2976	1564	1,26	73,36	47,52	-	1553	1786
293	247	030	LR	YY	00	49	2478	300	3038	1596	1,26	74,48	48,51	-	1575	1811
293	252	030	LR	YY	00	50	2528	300	3100	1629	1,26	76,00	49,50	-	1601	1841
293	257	030	LR	YY	00	51	2578	300	3162	1661	1,26	77,52	50,49	-	1648	1895
293	262	030	LR	YY	00	52	2628	300	3224	1694	1,26	79,04	51,48	-	1669	1919
293	267	030	LR	YY	00	53	2678	300	3286	1726	1,26	80,56	52,47	-	1691	1945
293	272	030	LR	YY	00	54	2728	300	3348	1759	1,26	82,08	53,46	-	1714	1971
293	277	030	LR	YY	00	55	2778	300	3410	1792	1,26	83,60	54,45	-	1737	1998
293	282	030	LR	YY	00	56	2828	300	3472	1824	1,26	85,12	55,44	-	1759	2023

Conform EN442-1: 2014: radiatoren en convectoren

\* RAL 9016: geen meerprijs 15%

Voor meer details over onze artikel-data, zie artikel-database: <https://www.2ba.nl>

Voor de warmteafgiftes van andere regimes, kijkt u op p. 370 (correctiefactoren)  
 NEDERLAND. Prijzen in euro (excl. BTW)

## VINTAGE (VINTAGE 50 / D250)

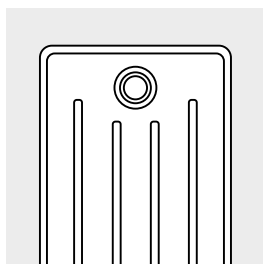

VINTAGE 50 / D250

### HOE VINTAGE 50 BESTELLEN

Leveringstermijn 15 - 30 werkdagen  
(zonder transportduur)

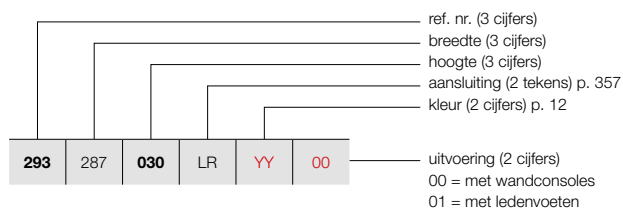

### PRIJSGROEP: VPG5 - KOLOMRADIATOREN

BESTELCODE MAATWERK VINTAGE 50	TECHNISCHE GEGEVENS										STANDAARDKLEUR	ANDERE KLEUREN
	buizen	breedte (L mm)	hoogte (H mm)	75/65/20 (Watt) (Φ50K)	55/45/20 (Watt) (Φ30K)	n-exp.	gewicht (kg)	inhoud (l)	el. weerst. (Watt)	prijs S600* (€)	prijs kleur (€)	
REF. NR. VINTAGE 50 VINTAGE 50/D250 : 293												
<b>293</b>   287   <b>030</b>   LR   <b>YY</b>   <b>00</b>	57	2878	300	3534	1857	1,26	86,64	56,43	-	<b>1781</b>	<b>2048</b>	
<b>293</b>   292   <b>030</b>   LR   <b>YY</b>   <b>00</b>	58	2928	300	3596	1889	1,26	88,16	57,42	-	<b>1805</b>	<b>2076</b>	
<b>293</b>   297   <b>030</b>   LR   <b>YY</b>   <b>00</b>	59	2978	300	3658	1922	1,26	89,68	58,41	-	<b>1827</b>	<b>2101</b>	
<b>293</b>   302   <b>030</b>   LR   <b>YY</b>   <b>00</b>	60	3028	300	3720	1954	1,26	91,70	59,40	-	<b>1850</b>	<b>2128</b>	



Conform EN442-1: 2014: radiatoren en convectoren

\* RAL 9016: geen meerprijs 15%

Voor meer details over onze artikel-data, zie artikel-database: <https://www.2ba.nl>

**Voor de warmteafgiftes van andere regimes, kijkt u op p. 370 (correctiefactoren)**  
**NEDERLAND. Prijzen in euro (excl. BTW)**

PRIJSGROEP: VPG10 - ACC.

BEVESTIGINGEN		VINTAGE 50	KLEUR
WANDBEVESTIGING			in de kleur van de radiator*
LEDENVOETEN		<p>VINTAGE 50</p> <p>2 voeten voor 25 leden</p> <p>3 voeten voor 50 leden</p> <p>4 voeten voor 60 leden</p>	in de kleur van de radiator*

\* Voeten en bevestigingen voor radiatoren in transparante coating zijn gelakt in de kleur N507.

VINTAGE AANSLUITINGEN

VINTAGE: VINTAGE 50

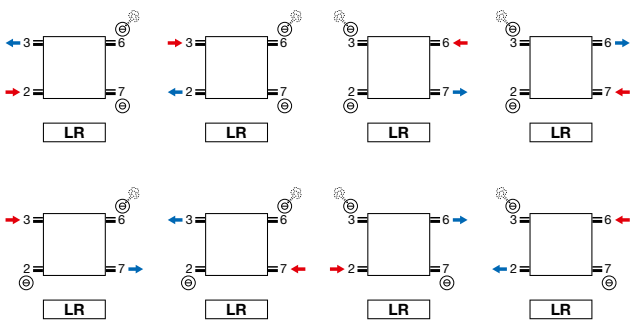

- Ontluchter in aansluiting 3 of 6.

VINTAGE: VINTAGE 50

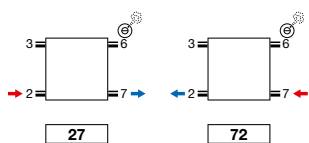

- Ontluchter in aansluiting 3 of 6.
- Aansluitingen op speciale aanvraag: meerprijs €88

**Opmerking:** het aansluiten van de radiator kan enkel volgens de getoonde aansluiticonen. Voor elke andere aansluitwijze nemen wij geen verantwoordelijkheid.

VINTAGE (VINTAGE 50)

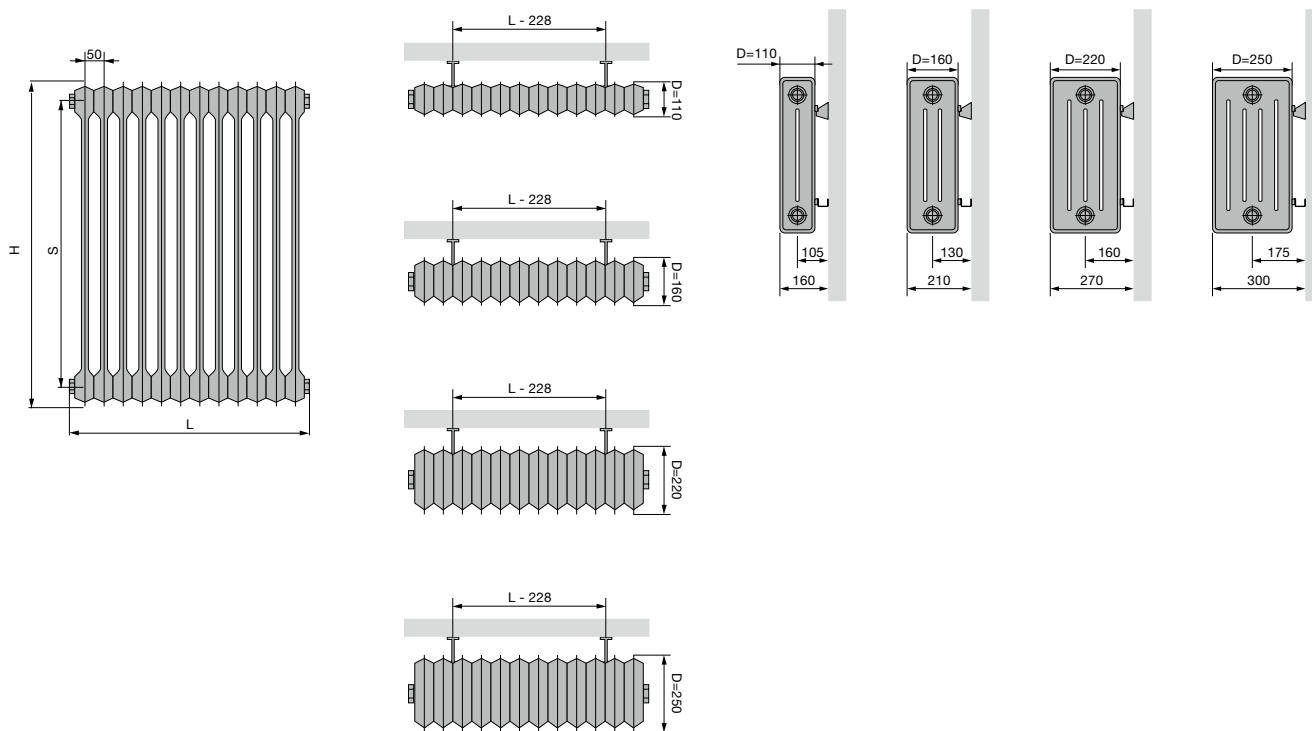

VINTAGE 50

Hoogte (H)	300	450	600	1000
Hartafstand tussen de zijaansluitingen (S)	200	350	500	900

VINTAGE (VINTAGE 50)

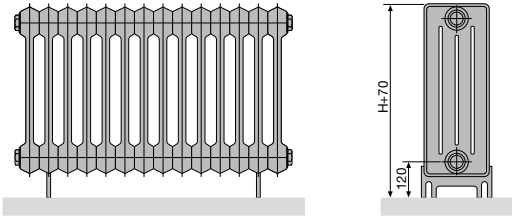

VINTAGE 50 (VLOERMONTAGE)

Aantal leden	2-25	26-50	51-60
Aantal voeten	2	3	4

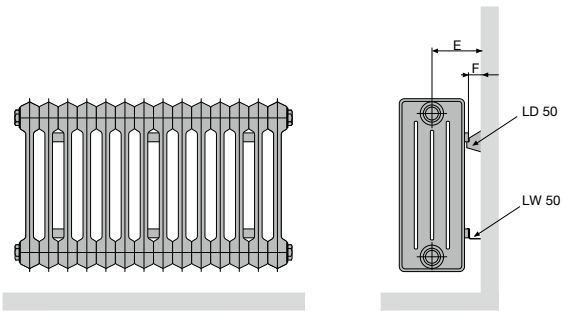

VINTAGE 50 (WANDMONTAGE) LD 50 + LW 50

Diepte (D)	110	160	220	250
Afstand tussen wand en aansluiting (E)	105	130	160	175
Afstand tussen wand en achterkant radiator (F)	50			

VINTAGE 50 (WANDMONTAGE)

Aantal leden	3-5	6-25	26-50	51-60
Aantal muurbevestigingen set LD 50 + LW 50	1	2	3	4

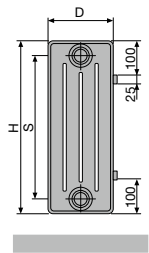

VINTAGE 50

Hoogte (H)	300	450	600	1000
Hartafstand tussen de zijansluitingen (S)	200	350	500	900

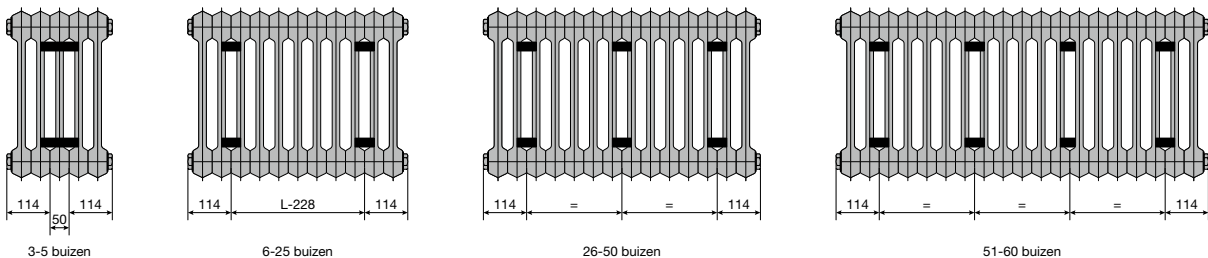

3-5 buizen

6-25 buizen

26-50 buizen

51-60 buizen