

Staal designradiatoren



VASCO staalradiatoren verenigen een optimaal eigentijds warmtecomfort met een doordachte, tijdloze vormgeving.

Elke collectie is een unieke demonstratie van warmte op haar efficiëntst én op haar mooist.

Op maat van elke woonruimte. Geschikt voor elke toepassing. Stuk voor stuk meesterwerkjes van technisch vernuft en creativiteit, bekroond met vele internationale designprijzen.

Ervaren technici, innovatieve ontwerpers en wetenschappelijke specialisten creëren samen oplossingen waarin de details het verschil maken.

Staalradiatoren die zich steeds weer onderscheiden door hun zuivere vormgeving en gebruiksgemak.

Staal designradiatoren

Niva	140
Niva Ventilo-Convactor	150
Carré	160
Arche	177
Zana	183
Viola-A	196
Tulipa-A	230

NIVA LAK VERTICAAL (N1L1, N2L1)



TYPES

- Enkel (N1L1) en dubbel (N2L1)

KLEUREN

- Standaardkleur S600 (witte fijn structuurlak) (RAL 9016: geen meerprijs 15%)
- Uitgebreide kleurenkaart zie p. 12

SPECIAAL

- De Niva Lak Verticaal is beschikbaar met een gelakte voorplaat (dwz. plaatradiator + gelakte voorplaat).

BEVESTIGINGEN

- Muurbevestigingen in de kleur RAL 7016 (antraciet grijs) standaard. Ook in optie verkrijgbaar in de kleur S600 (zie p. 152).

TECHNISCH

- Elektrisch weerstandsgelast (onzichtbare lasnaden) en rolnaadgelast
- KTL-grondlaag, poedercoating
- Standaardwerkdruk: 10 bar
- Maximale bedrijfstemperatuur: 110°C

ELEKTRISCH (beschikbare uitvoeringen: zie hoofdstuk elektrische radiatoren)

- ✓ Zuiver elektrische radiator (zie p. 62)
- ✓ Gemengde radiator (zie p. 92)

TECHNISCHE TEKENINGEN

- Zie p. 156

AANSLUITING

- ✗ Eénpuntsaansluiting voor éénpijpsysteem
- ✗ Eénpuntsaansluiting voor tweepijpsysteem
- ✓ Tweepuntsaansluiting voor éénpijpsysteem (aansluiting via de middenaansluiting) (zie p. 340)
- ✓ Tweepuntsaansluiting voor tweepijpsysteem (standaard) (zie p. 340)
- ✗ Geïntegreerd ventiel
- Aansluitingen: 1/2" (binnendraad)

NIVA LAK VERTICAAL

Puur technische klasse, puur design, puur sfeer

De ultracompacte, gestyleerde Niva is nog steeds een stichtend voorbeeld voor heel wat ontwerpers en collega-producenten. Eén en al functionaliteit door de optimale luchtdoorstroming en de extra hoge warmteafgifte die meteen op gang komt. Eén en al design door de integere, zuivere vormgeving, het zwevend karakter –dankzij de achterliggende, onzichtbare ophanging- en de organisch geïntegreerde handdoekbeugel.

AANBEVOLEN AANSLUITING (LB)

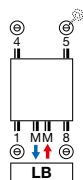

Andere aansluitmogelijkheden, zie p. 155



art. nr. 1182 103 0000 0099

prijs €175

Koppelingen, zie p. 353

AANBEVOLEN VOOR BADKAMER EN KEUKEN IN OPTIE



handdoekbeugel (chrom) N1L1 art. nr. zie p. 153

prijs €184

N2L1 art. nr. zie p. 153

prijs €184

Andere accessoires, zie p. 153



HOE NIVA LAK VERTICAAL BESTELLEN

Leveringstermijn 15 - 30 werkdagen
(zonder transportduur)

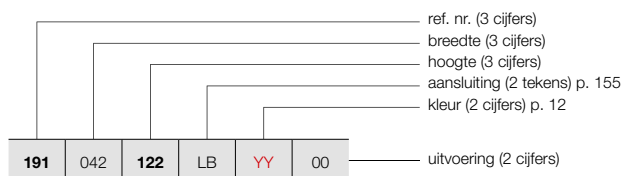

NIVA LAK VERTICAAL (N1L1, N2L1)



N1L1

N2L1

HOE VOORRAADRADIATOR NIVA LAK VERTICAAL BESTELLEN

Leveringstermijn 5 werkdagen
(zonder transportduur)

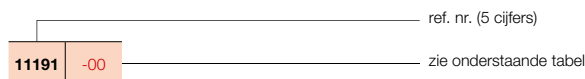

PRIJSGROEP: VPG2 - STAAL DESIGNRADIATOREN

BESTELCODE MAATWERK NIVA LAK VERTICAAL	TECHNISCHE GEGEVENS									STANDAARDKLEUR		ANDERE KLEUREN	
	buizen	breedte (L mm)	hoogte (H mm)	75/65/20 (Watt) (Φ50K)	55/45/20 (Watt) (Φ30K)	n-exp.	gewicht (kg)	inhoud (l)	el. weerst. (Watt)	prijs S600* (€)	verkorte ref. nr. S600 voorraad	prijs kleur (€)	verkorte ref. nr. M301 voorraad
REF. NR. NIVA LAK VERTICAAL N1L1 : 191													
191 042 122 LB YY 00	-	420	1220	645	337	1,27	18,10	2,55	-	504	11191-02	580	-
	-	420	1820	934	486	1,28	27,35	3,70	-	586	11191-03	674	11191-05
	-	420	2020	1023	532	1,28	30,20	4,00	-	618	11191-06	711	-
	-	420	2220	1070	559	1,27	33,20	4,50	-	667	-	767	-
191 052 122 LB YY 00	-	520	1220	815	424	1,28	21,97	3,32	-	568	11191-21	653	-
	-	520	1820	1128	587	1,28	33,67	4,61	-	659	11191-16	758	11191-01
	-	520	2020	1257	654	1,28	37,12	5,05	-	696	11191-22	800	-
	-	520	2220	1310	681	1,28	40,88	5,57	-	752	-	865	-
191 062 122 LB YY 00	-	620	1220	985	510	1,29	25,83	3,85	-	591	11191-07	680	-
	-	620	1820	1322	687	1,28	39,98	5,52	-	687	11191-17	790	11191-04
	-	620	2020	1490	775	1,28	44,03	6,10	-	728	11191-20	837	-
	-	620	2220	1550	806	1,28	48,57	6,63	-	788	-	906	-
191 072 182 LB YY 00	-	720	1820	1515	784	1,29	46,30	6,43	-	712	11191-08	819	-
	-	720	2020	1724	897	1,28	50,95	7,15	-	758	11191-09	872	-
	-	720	2220	1790	926	1,29	56,25	7,70	-	825	-	949	-
REF. NR. NIVA LAK VERTICAAL N2L1 : 192													
192 042 122 LB YY 00	-	420	1220	988	506	1,31	26,50	4,90	-	755	-	868	-
	-	420	1820	1330	681	1,31	42,23	7,28	-	877	11192-02	1009	-
	-	420	2020	1438	736	1,31	46,75	8,00	-	909	11192-04	1045	-
	-	420	2220	1543	823	1,23	51,40	8,90	-	962	-	1106	-
192 052 122 LB YY 00	-	520	1220	1213	621	1,31	33,00	6,48	-	847	11192-05	974	-
	-	520	1820	1633	836	1,31	51,68	9,07	-	987	11192-31	1135	-
	-	520	2020	1764	903	1,31	57,23	10,00	-	1023	11192-32	1176	-
	-	520	2220	1893	995	1,26	62,73	11,00	-	1083	-	1245	-
192 062 122 LB YY 00	-	620	1220	1437	732	1,32	39,50	7,02	-	883	11192-37	1015	-
	-	620	1820	1935	991	1,31	61,14	10,86	-	1028	11192-33	1182	-
	-	620	2020	2091	1071	1,31	67,72	12,00	-	1066	11192-34	1226	-
	-	620	2220	2243	1160	1,29	74,07	13,10	-	1133	11192-39	1303	-
192 072 182 LB YY 00	-	720	1820	2237	1146	1,31	70,60	12,65	-	1065	11192-07	1225	-
	-	720	2020	2417	1238	1,31	78,20	14,00	-	1115	11192-35	1282	-
	-	720	2220	2594	1322	1,32	85,40	15,20	-	1188	11192-36	1366	-

Conform EN442-1: 2014: radiatoren en convectoren

* RAL 9016: geen meerprijs 15%

Voor meer details over onze artikel-data, zie artikel-database: <https://www.installdata.be>

Voor de warmteafgiftes van andere regimes, kijkt u op p. 346 (correctiefactoren)

BELGIË. Prijzen in euro (excl. BTW)

NIVA INOX VERTICAAL (N1L1-ES, N2L1-ES)



TYPES

- Enkel (N1L1-ES) en dubbel (N2L1-ES)

KLEUREN

- Inox / RVS type 316L, mat geborsteld met korrel 360

SPECIAAL

- De Niva Inox Verticaal is beschikbaar met een inox voorplaat (dwz. stalen plaatradiator + inox-voorplaat).
- De Niva Inox Verticaal is te reinigen met een inox cleaner.

BEVESTIGINGEN

- Muurbevestigingen in de kleur RAL 7016 (antraciet grijs) standaard. Ook in optie verkrijgbaar in de kleur S600 (zie p. 152).

TECHNISCH

- Elektrisch weerstandsgelast (onzichtbare lasnaden) en rolnaadgelast
- Standaardwerkdruk: 10 bar
- Maximale bedrijfstemperatuur: 110°C

ELEKTRISCH

- ✗ Zuiver elektrische radiator
- ✗ Gemengde radiator

TECHNISCHE TEKENINGEN

- Zie p. 156

AANSLUITING

- ✗ Eénpuntsaansluiting voor éénpijpsysteem
- ✗ Eénpuntsaansluiting voor tweepijpsysteem
- ✓ Tweepuntsaansluiting voor éénpijpsysteem (aansluiting via de middenaansluiting) (zie p. 340)
- ✓ Tweepuntsaansluiting voor tweepijpsysteem (standaard) (zie p. 340)
- ✗ Geïntegreerd ventiel
- Aansluitingen: 1/2" (binnendraad)

NIVA INOX VERTICAAL

Pure klasse in al haar pracht

De Niva Inox Verticaal combineert een stalen plaatradiator met een inox voorplaat, die de integere, zuivere vormgeving en het zwevende karakter van de Niva letterlijk 'extra glans' geeft. De Niva Inox Verticaal designradiator is ook leverbaar met organisch geïntegreerde inox handdoekbeugel (in optie).

AANBEVOLEN AANSLUITING (LB)

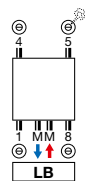

Andere aansluitmogelijkheden, zie p. 155

AANBEVOLEN VOOR BADKAMER EN KEUKEN IN OPTIE



handdoekbeugel (chrom) N1L1 art. nr. zie p. 153

prijs €184

N2L1 art. nr. zie p. 153

prijs €184

Andere accessoires, zie p. 153



HOE NIVA INOX VERTICAAL BESTELLEN

Leveringstermijn 15 - 30 werkdagen
(zonder transportduur)

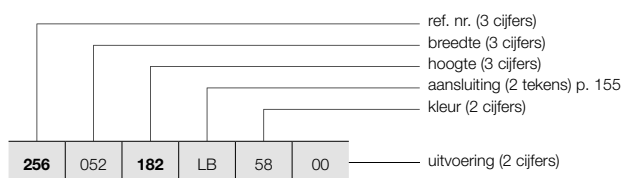

NIVA INOX VERTICAAL (N1L1-ES, N2L1-ES)

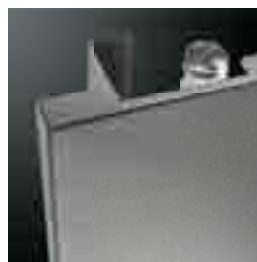

N1L1-ES



N2L1-ES

PRIJSGROEP: VPG2 - STAAL DESIGNRADIATOREN

BESTELCODE MAATWERK NIVA INOX VERTICAAL	TECHNISCHE GEGEVENS									STANDAARDKLEUR					
	buizen	breedte (L mm)	hoogte (H mm)	75/65/20 (Watt) (Φ50K)	55/45/20 (Watt) (Φ30K)	n-exp.	gewicht (kg)	inhoud (l)	el. weerst. (Watt)	prijs inox (€)					
REF. NR. NIVA INOX VERTICAAL N1L1-ES : 256															
256	052	182	LB	58	00	-	520	1820	1128	587	1,28	33,67	4,61	-	1217
		202				-	520	2020	1257	654	1,28	37,12	5,05	-	1291
256	062	182	LB	58	00	-	620	1820	1322	687	1,28	39,98	5,52	-	1270
		202				-	620	2020	1490	775	1,28	44,03	6,10	-	1347
REF. NR. NIVA INOX VERTICAAL N2L1-ES : 257															
257	052	182	LB	58	00	-	520	1820	1633	836	1,31	51,68	9,07	-	1825
		202				-	520	2020	1764	903	1,31	57,23	10,00	-	1890
257	062	182	LB	58	00	-	620	1820	1935	991	1,31	61,14	10,86	-	1901
		202				-	620	2020	2091	1071	1,31	67,72	12,00	-	1972

Conform EN442-1: 2014: radiatoren en convectoren

Voor meer details over onze artikel-data, zie artikel-database: <https://www.installdata.be>

Voor de warmteafgiftes van andere regimes, kijkt u op p. 346 (correctiefactoren)
BELGIË. Prijzen in euro (excl. BTW)

NIVA LAK HORIZONTAAL (NH1L1, NH2L1, NH2L2)

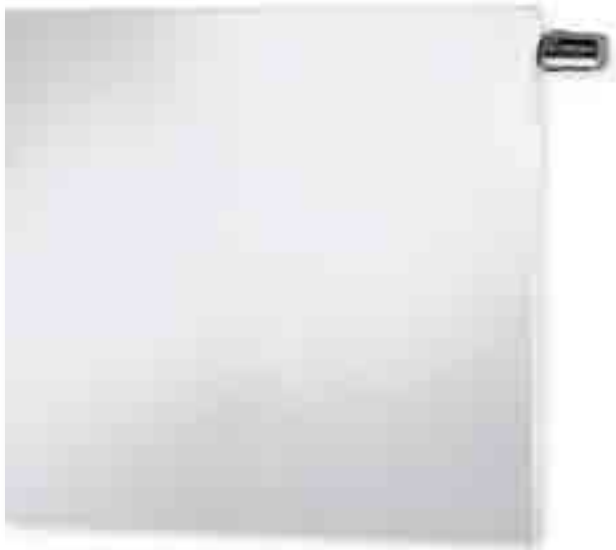

GEÏNTEGREERD VENTIEL

NIVA LAK HORIZONTAAL

- Radiator in wit: thermostaatkop in wit standaard, in de prijs inbegrepen
- Radiator in kleur: thermostaatkop in chroom standaard, in de prijs inbegrepen



TYPES

- NH1L1, NH2L1, NH2L2

KLEUREN

- Standaardkleur S600 (witte fijn structuurlak) (RAL 9016: geen meerprijs 15%)
- Uitgebreide kleurenkaart zie p. 12

SPECIAAL

- De Niva Lak Horizontaal is verkrijgbaar met 1 (NH1L1, NH2L1) of 2 rijen (NH2L2) lamellen ter verhoging van de warmteafgifte.
- NH1L1 ook verkrijgbaar als toiletradiator (520 x 450 mm)

BEVESTIGINGEN

- Muurbevestigingen in de kleur RAL 7016 (antraciet grijs) standaard. Ook in optie verkrijgbaar in de kleur S600 (zie p. 152).

TECHNISCH

- Elektrisch weerstandsgelast (onzichtbare lasnaden) en rolnaadgelast
- KTL-grondlaag, poedercoating
- Standaardwerkdruk: 10 bar
- Maximale bedrijfstemperatuur: 110°C

ELEKTRISCH

- ✗ Zuiver elektrische radiator
- ✗ Gemengde radiator

TECHNISCHE TEKENINGEN

- Zie p. 157

AANSLUITING

- ✗ Eénpuntsaansluiting voor éénpijpssysteem
- ✗ Eénpuntsaansluiting voor tweepijpssysteem
- ✓ Tweepuntsaansluiting voor éénpijpssysteem (aansluiting via het geïntegreerd ventiel) (zie p. 341)
- ✓ Tweepuntsaansluiting voor tweepijpssysteem (standaard) (zie p. 340)
- ✓ Geïntegreerd ventiel (**geen meerprijs**) (zie p. 341)
- Aansluitingen: 4x½" zijdelings (binnendraad), 2x¾" Euroconus (50mm rechtsonder)

NIVA LAK HORIZONTAAL

Pure klasse in al haar eenvoud

Ook in de horizontale versie is en blijft de Niva een toonbeeld van efficiënte toegepaste vormgeving. Een geslaagde combinatie van functionaliteit en design, met de keuze uit 1 of 2 lamellen voor een aangepaste warmteafgifte, ook beschikbaar in toiletversie. Met optionele handdoekbeugel in chroomuitvoering.

AANBEVOLEN AANSLUITING (VR) GEÏNTEGREERD VENTIEL

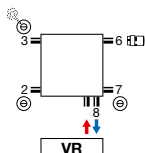

Andere aansluitmogelijkheden, zie p. 155



art. nr. 1182 300 0000 0099

prijs €145

Koppelingen, zie p. 353

AANBEVOLEN VOOR BADKAMER EN KEUKEN IN OPTIE



handdoekbeugel (chroom)

art. nr. zie p. 153

prijs €184



HOE NIVA LAK HORIZONTAAL BESTELLEN

Leveringstermijn 15 - 30 werkdagen
(zonder transportduur)

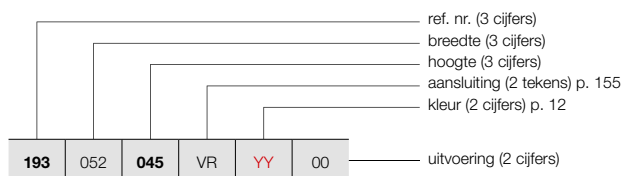

NIVA LAK HORIZONTAAL (NH1L1, NH2L1, NH2L2)



NH1L1 / NH2L1

HOE VOORRAADRADIATOR NIVA LAK HORIZONTAAL BESTELLEN

Leveringstermijn 5 werkdagen
(zonder transportduur)

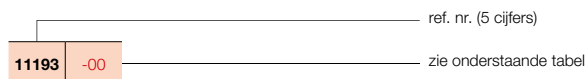

PRIJSGROEP: VPG2 - STAAL DESIGNRADIATOREN

BESTELCODE MAATWERK NIVA LAK HORIZONTAAL	TECHNISCHE GEGEVENS							STANDAARDKLEUR		ANDERE KLEUREN		
	buizen	breedte (L mm)	hoogte (H mm)	75/65/20 (Watt) (Φ50K)	55/45/20 (Watt) (Φ30K)	n-exp.	gewicht (kg)	inhoud (l)	el. weerst. (Watt)		prijs S600* (€)	verkorte ref. nr. S600 voorraad
REF. NR. NIVA LAK HORIZONTAAL NH1L1 : 193												
193 052 045 VR YY 00	-	520	450	301	158	1,26	7,50	1,19	-	460	11193-01	529
193 062 055 065 VR YY 00	-	620	550	425	223	1,26	11,11	1,66	-	515	-	592
	-	620	650	490	256	1,27	13,28	1,92	-	578	-	665
193 082 055 065 VR YY 00	-	820	550	562	295	1,26	14,69	2,20	-	599	-	689
	-	820	650	649	339	1,27	17,56	2,53	-	662	-	761
193 102 055 065 095 VR YY 00	-	1020	550	699	367	1,26	18,28	2,73	-	685	-	788
	-	1020	650	807	422	1,27	21,85	3,15	-	747	-	859
	-	1020	950	1124	585	1,28	31,85	4,40	-	921	-	1059
193 122 055 065 095 VR YY 00	-	1220	550	836	439	1,26	21,86	3,27	-	766	-	881
	-	1220	650	965	504	1,27	26,13	3,77	-	832	-	957
	-	1220	950	1344	699	1,28	38,10	5,26	-	1010	-	1162
REF. NR. NIVA LAK HORIZONTAAL NH2L1 : 194												
194 062 055 065 VR YY 00	-	620	550	611	318	1,28	17,25	3,27	-	671	-	772
	-	620	650	708	370	1,27	20,70	3,83	-	788	-	906
194 082 055 065 VR YY 00	-	820	550	809	421	1,28	22,81	4,32	-	766	-	881
	-	820	650	936	489	1,27	27,37	5,07	-	883	-	1015
194 102 055 065 095 VR YY 00	-	1020	550	1006	523	1,28	28,38	5,38	-	863	-	992
	-	1020	650	1165	609	1,27	34,05	6,30	-	977	11194-23	1124
	-	1020	950	1630	839	1,30	50,20	9,05	-	1175	-	1351
194 122 055 065 095 VR YY 00	-	1220	550	1203	626	1,28	33,94	6,43	-	956	-	1099
	-	1220	650	1393	728	1,27	40,72	7,54	-	1071	-	1232
	-	1220	950	1950	1004	1,30	60,05	10,82	-	1260	-	1449
194 142 055 065 VR YY 00	-	1420	550	1400	728	1,28	39,50	7,48	-	1115	-	1282
	-	1420	650	1622	848	1,27	47,40	8,78	-	1247	-	1434
194 162 055 065 VR YY 00	-	1620	550	1597	830	1,28	45,07	8,54	-	1270	-	1461
	-	1620	650	1850	967	1,27	54,08	10,01	-	1425	-	1639

Conform EN442-1: 2014: radiatoren en convectoren

* RAL 9016: geen meerprijs 15%

Voor meer details over onze artikel-data, zie artikel-database: <https://www.installdata.be>

Voor de warmteafgiftes van andere regimes, kijkt u op p. 346 (correctiefactoren)
BELGIË. Prijzen in euro (excl. BTW)

NIVA LAK HORIZONTAAL (NH2L2)



NH2L2

HOE NIVA LAK HORIZONTAAL BESTELLEN

Leveringstermijn 15 - 30 werkdagen
(zonder transportduur)

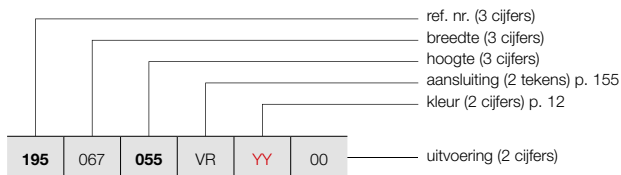

HOE VOORRAADRADIATOR NIVA LAK HORIZONTAAL BESTELLEN

Leveringstermijn 5 werkdagen
(zonder transportduur)

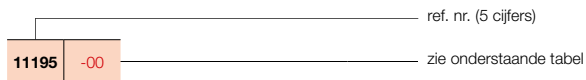

PRIJSGROEP: VPG2 - STAAL DESIGNRADIATOREN

BESTELCODE MAATWERK NIVA LAK HORIZONTAAL	TECHNISCHE GEGEVENS									STANDAARDKLEUR		ANDERE KLEUREN prijs kleur (€)
	buizen	breedte (L mm)	hoogte (H mm)	75/65/20 (Watt Ø50K)	55/45/20 (Watt Ø30K)	n-exp.	gewicht (kg)	inhoud (l)	el. weerst. (Watt)	prijs S600* (€)	verkorte ref. nr. S600 voorraad	
REF. NR. NIVA LAK HORIZONTAAL NH2L2 : 195												
195 067 055 VR YY 00	-	678	550	804	416	1,29	20,50	3,40	-	840	-	966
065	-	678	650	941	487	1,29	24,28	3,93	-	988	-	1136
195 087 055 VR YY 00	-	878	550	1041	539	1,29	26,55	4,40	-	968	-	1113
065	-	878	650	1219	631	1,29	31,44	5,09	-	1117	-	1285
195 107 055 VR YY 00	-	1078	550	1279	662	1,29	32,60	5,40	-	1092	-	1256
065	-	1078	650	1496	774	1,29	38,60	6,25	-	1241	11195-16	1427
095	-	1078	950	2027	1043	1,30	57,90	9,00	-	1470	-	1691
195 127 055 VR YY 00	-	1278	550	1516	784	1,29	38,65	6,40	-	1217	-	1400
065	-	1278	650	1774	918	1,29	45,77	7,41	-	1363	-	1567
095	-	1278	950	2403	1237	1,30	68,64	10,67	-	1595	-	1834
195 147 055 VR YY 00	-	1478	550	1753	907	1,29	44,69	7,40	-	1410	-	1622
065	-	1478	650	2051	1061	1,29	52,93	8,57	-	1579	-	1816
195 167 055 VR YY 00	-	1678	550	1990	1030	1,29	50,74	8,41	-	1602	-	1842
065	-	1678	650	2329	1205	1,29	60,09	9,73	-	1793	-	2062

Conform EN442-1: 2014: radiatoren en convectoren

* RAL 9016: geen meerprijs 15%
Voor meer details over onze artikel-data, zie artikel-database: <https://www.installdata.be>
Voor de warmteafgiftes van andere regimes, kijkt u op p. 346 (correctiefactoren)
BELGIË. Prijzen in euro (excl. BTW)

TYPES

- Enkel (NS1L1) en dubbel (NS2L1)

KLEUREN

- Standaardkleur S600 (witte fijn structuurlak) (RAL 9016: geen meerprijs 15%)
- Uitgebreide kleurenkaart zie p. 12

SPECIAAL

- De Niva Soft Verticaal is beschikbaar met een gelakte voorplaat (dwz. stalen plaatradiator + gelakte voorplaat).
- Vlakke voorplaat en afgeronde zijken als hedendaagse troef
- Thermostaatkop op deurknophoogte in optie (niet bij NS1L1) (zie p. 341).



BEVESTIGINGEN

- Muurbevestigingen in de kleur RAL 7016 (antraciet grijs) standaard. Ook in optie verkrijgbaar in de kleur S600 (zie p. 152).

TECHNISCH

- Elektrisch weerstandsgelast (onzichtbare lasnaden) en rolnaadgelast
- KTL-grondlaag, poedercoating
- Standaardwerkdruk: 10 bar
- Maximale bedrijfstemperatuur: 110°C

ELEKTRISCH

- ✗ Zuiver elektrische radiator
- ✗ Gemengde radiator

TECHNISCHE TEKENINGEN

- Zie p. 158

AANSLUITING

- ✗ Eénpuntsaansluiting voor éénpijpsysteem
- ✗ Eénpuntsaansluiting voor tweepijpsysteem
- ✓ Tweepuntsaansluiting voor éénpijpsysteem (aansluiting via de middenaansluiting) (zie p. 340)
- ✓ Tweepuntsaansluiting voor tweepijpsysteem (standaard) (zie p. 340)
- ✓ Geïntegreerd ventiel (**meerprijs €154**) (niet bij NS1L1) (zie p. 341)
- Aansluitingen: 1/2" (binnendraad)

AANBEVOLEN AANSLUITING NS1L1/NS2L1 (LB)

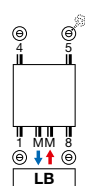

art. nr. 1182 103 0000 0099
prijs €175
Koppelingen, zie p. 353

AANBEVOLEN VOOR BADKAMER EN KEUKEN IN OPTIE



handdoekbeugel (aluminium)
NS1L1 art. nr. zie p. 153
prijs €184

OPTIE: AANSLUITING NS2L1 (VR) GEÏNTEGREERD VENTIEL

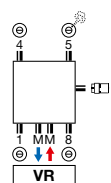

art. nr. 1182 301 0000 0099
prijs €145
Koppelingen, zie p. 353

Meerprijs: €154 (zie p. 341)

Andere aansluitmogelijkheden, zie p. 155



NIVA SOFT VERTICAAL

Pure klasse in al haar creativiteit

De Niva in al zijn compacte, gestyleerde eenvoud, maar nu in een uitvoering met zacht afgeronde zijken. Een designradiator die uitstekend tot zijn recht komt zowel in een minimalistisch interieur als in een eigentijdse retro-omgeving. Leverbaar met thermostaatkop op deurknophoogte.



NIVA SOFT VERTICAAL (NS1L1, NS2L1)

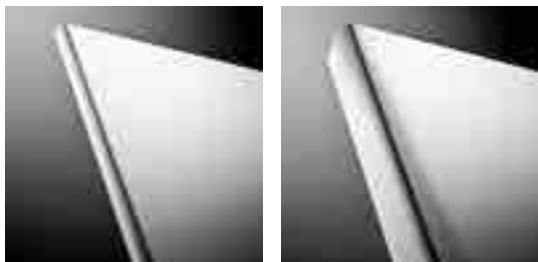

NS1L1

NS2L1

HOE NIVA SOFT BESTELLEN

Leveringstermijn 15 - 30 werkdagen
(zonder transportduur)

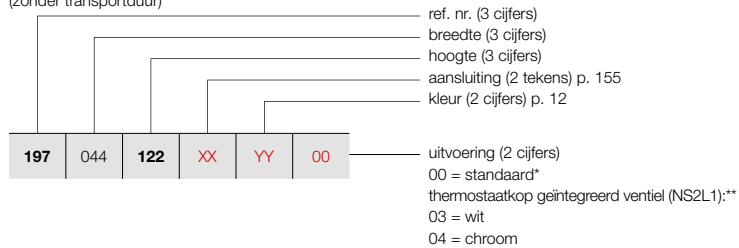

HOE VOORRAADRADIATOR NIVA SOFT BESTELLEN

Leveringstermijn 5 werkdagen
(zonder transportduur)

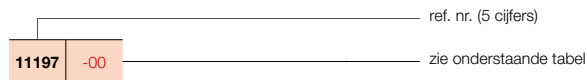

PRIJSGROEP: VPG2 - STAAL DESIGNRADIATOREN

BESTELCODE MAATWERK NIVA SOFT VERTICAAL	TECHNISCHE GEGEVENS									STANDAARDKLEUR		ANDERE KLEUREN prijs kleur (€)					
	buizen	breedte (L mm)	hoogte (H mm)	75/65/20 (Watt) (Φ50K)	55/45/20 (Watt) (Φ30K)	n-exp.	gewicht (kg)	inhoud (l)	el. weerst. (Watt)	prijs S600* (€)	verkorte ref. nr. S600 voorraad						
REF. NR. NIVA SOFT VERTICAAL NS1L1 : 197																	
197	044	122	XX	YY	00	-	440	1220	645	337	1,27	18,10	2,55	-	504	11197-06	580
		182				-	440	1820	934	486	1,28	27,35	3,70	-	586	11197-07	674
		202				-	440	2020	1023	532	1,28	30,20	4,00	-	618	11197-08	711
		222				-	440	2220	1070	559	1,27	33,20	4,50	-	667	-	767
197	054	122	XX	YY	00	-	540	1220	815	424	1,28	21,97	3,32	-	568	11197-04	653
		182				-	540	1820	1128	587	1,28	33,67	4,61	-	659	11197-01	758
		202				-	540	2020	1257	654	1,28	37,12	5,05	-	696	11197-05	800
		222				-	540	2220	1310	681	1,28	40,88	5,57	-	752	-	865
197	064	122	XX	YY	00	-	640	1220	985	510	1,29	25,83	3,85	-	591	11197-09	680
		182				-	640	1820	1322	687	1,28	39,98	5,52	-	687	11197-02	790
		202				-	640	2020	1490	775	1,28	44,03	6,10	-	728	11197-03	837
		222				-	640	2220	1550	806	1,28	48,57	6,63	-	788	-	906
197	074	182	XX	YY	00	-	740	1820	1515	784	1,29	46,30	6,43	-	712	11197-10	819
		202				-	740	2020	1724	897	1,28	50,95	7,15	-	758	11197-11	872
		222				-	740	2220	1790	926	1,29	56,25	7,70	-	825	-	949
REF. NR. NIVA SOFT VERTICAAL NS2L1 : 198																	
198	044	122	XX	YY	00	-	440	1220	988	506	1,31	28,40	4,90	-	755	-	868
		182				-	440	1820	1330	681	1,31	42,23	7,28	-	877	11198-08	1009
		202				-	440	2020	1438	736	1,31	46,75	8,00	-	909	11198-09	1045
		222				-	440	2220	1543	823	1,23	51,40	8,90	-	962	-	1106
198	054	122	XX	YY	00	-	540	1220	1213	621	1,31	36,83	6,48	-	847	11198-10	974
		182				-	540	1820	1633	836	1,31	51,68	9,07	-	987	11198-01	1135
		202				-	540	2020	1764	903	1,31	57,23	10,00	-	1023	11198-02	1176
		222				-	540	2220	1893	995	1,26	62,73	11,00	-	1083	-	1245
198	064	122	XX	YY	00	-	640	1220	1437	732	1,32	38,17	7,02	-	883	-	1015
		182				-	640	1820	1935	991	1,31	61,14	10,86	-	1028	11198-03	1182
		202				-	640	2020	2091	1071	1,31	67,72	12,00	-	1066	11198-04	1226
		222				-	640	2220	2243	1160	1,29	74,07	13,10	-	1133	-	1303
198	074	182	XX	YY	00	-	740	1820	2237	1146	1,31	70,60	12,65	-	1065	11198-11	1225
		202				-	740	2020	2417	1238	1,31	78,20	14,00	-	1115	11198-05	1282
		222				-	740	2220	2594	1322	1,32	85,40	15,20	-	1188	-	1366

Conform EN442-1: 2014: radiatoren en convectoren

* RAL 9016: geen meerprijs 15%

Voor meer details over onze artikel-data, zie artikel-database: <https://www.installdata.be>

Voor de warmteafgiftes van andere regimes, kijkt u op p. 346 (correctiefactoren)
BELGIË. Prijzen in euro (excl. BTW)

NIVA

VENTILO CONVECTOR

verwarmen &
koelen



verwarmen & koelen

De warmtepomp wint jaar na jaar terrein in nieuwe en bestaande woningen. Specialisten zijn het er dan ook over eens: dit is dé energiebron van de toekomst. De eindgebruiker profiteert twee keer. Want met een warmtepomp kan hij niet alleen energie-efficiënt verwarmen, maar ook koelen. Zeker in combinatie met de gloednieuwe Niva Ventilo-Convector van VASCO! Een ventilo-convector is een warmtewisselaar met lamellen waarbij een geïntegreerde ventilator warme of koele lucht de ruimte in brengt. Dit systeem, dat werkt op lage watertemperaturen van 30 tot 40°C, is zeer interessant in combinatie met een warmtepomp. De ventilo-convector kan in alle ruimtes van de woning toegepast worden, maar vormt vooral in de slaapkamer een absolute meerwaarde, omdat we daar behoefte hebben aan zowel verwarming als aan koeling. De ventilo-convector verwarmt of koelt de ruimte in korte tijd van 18 naar 22°C of van 28 naar 24°C. Bij toepassing van koeling worden er watertemperaturen gebruikt van 7 tot 12°C.

Dé oplossing tijdens koele winters en warme zomers!

- 2^{IN}1** de ideale 2-in-1 oplossing in sneltempo de gewenste temperatuur
- ideaal in combinatie met warmtepomp** koeling enkel mogelijk met warmtepomp met koelfunctie
- voor lage watertemperatuursystemen**
- fluïsterstille werking**
- met modulerende ventilator-regeling**
- met koper/aluminium warmtewisselaar**
- energie-efficiënte werking**
- touch display met intuïtieve bediening**
- overschilderbaar**

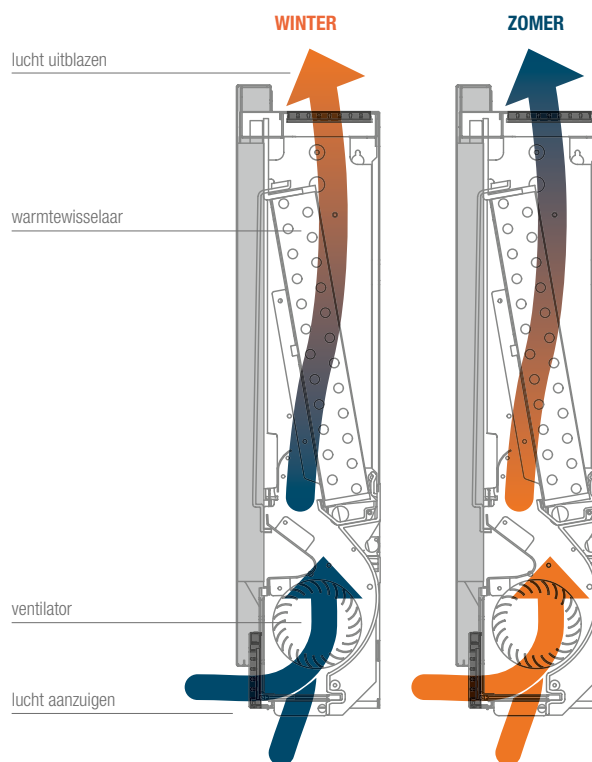

2-IN-1

De Niva ventilo-convector brengt iedere ruimte in uw woning op de gewenste comforttemperatuur. De convector verwarmt bij koud weer snel op en zorgt bij warme dagen voor de nodige verkoeling!



PRIJSGROEP: VPG8 - VENILO

TECHNISCHE GEGEVENS						STANDAARDKLEUR	
breedte (L mm)	hoogte (H mm)	45/40/20 (Watt)	35/30/20 (Watt)	gewicht (kg)	inhoud (l)	prijs S600 (€)	verkorte ref. nr. S600
TYPE: FC75							
750	610	1018	536	18,00	0,47	1237	11600-01
TYPE: FC95							
950	610	2205	1165	21,00	0,80	1355	11600-02
TYPE: FC115							
1150	610	3013	1639	24,00	1,13	1455	11600-03





Conform EN442-1: 2014: radiatoren en convectoren
 Voor meer details over onze artikel-data, zie artikel-database: <https://www.installdata.be>
Voor de warmteafgiftes van andere regimes, kijkt u op p. 346 (correctiefactoren)
BELGIË. Prijzen in euro (excl. BTW)

TECHNISCHE GEGEVENS

		FC75	FC95	FC115
Algemene gegevens				
Verwarmingsvermogen bij	W	1018	2205	3013
Waterdebiet	l/h	146	294	438
Drukverlies	kPA	9,10	9,20	19,00
Verwarmingsvermogen bij 35/30/20°C	W	536	1165	1639
Totaal koelvermogen bij 7/12/27°C 50% RV	W	955	2222	2914
Voelbaar koelvermogen	W	683	1483	2043
Waterdebiet	l/h	164	381	499
Drukverlies	kPA	13,20	8,90	18,30
Maximale werkdruk	bar	10	10	10
Hydraulische aansluiting		3/4" EK	3/4" EK	3/4" EK
Ventilator gegevens				
Maximaal luchtdebiet	m ³ /h	146	294	438
Medium luchtdebiet	m ³ /h	91	210	318
Minimum luchtdebiet	m ³ /h	49	124	194
Elektrische gegevens				
Voedingsspanning	V/ph/Hz	230/1/50	230/1/50	230/1/50
Maximaal opgenomen vermogen	W	11	19	20
Maximale opgenomen stroom	A	0,11	0,16	0,19
Opgenomen vermogen bij minimum snelheid	W	5	4	6
Geluidsgegevens				
Geluidsdruk bij maximaal luchtdebiet *	dB(A)	41	42	44
Geluidsdruk bij medium luchtdebiet *	dB(A)	33	34	34
Geluidsdruk bij minimum luchtdebiet *	dB(A)	24	25	26
Geluidsdruk bij maximale snelheid *	dB(A)	54	53	54

* Gemeten op 1 meter afstand volgens ISO 7779



BEVESTIGINGEN		HOOGTE RADIATOR	KLEUR	ART. NR.
N1L1 / N1L1-ES / NS1L1*				
MUURBEVESTIGING		1220 mm	S600	1187 104 1100 0600
		1820 mm	S600	1187 104 1700 0600
		2020 mm	S600	1187 104 1900 0600
		2220 mm	S600	1187 104 2100 0600
N2L1 / N2L1-ES / NS2L1				
MUURBEVESTIGING		1220 mm	S600	1187 105 1100 0600
		1820 mm	S600	1187 105 1700 0600
		2020 mm	S600	1187 105 1900 0600
		2220 mm	S600	1187 105 2100 0600
NH1L1				
MUURBEVESTIGING		450 mm	S600	1187 102 0400 0600
		550 mm	S600	1187 102 0500 0600
		650 mm	S600	1187 102 0600 0600
		950 mm	S600	1187 102 0900 0600
NH2L1 / NH2L2				
MUURBEVESTIGING		550 mm	S600	118710305000600
		650 mm	S600	118710306000600
		950 mm	S600	118710309000600

Prijzen: zie prijslijst "spare parts"

* niet beschikbaar voor NS1L1 met geïntegreerd ventiel





PRIJSGROEP: VPG10B - HANDDOEKBEUGELS

ACCESSOIRES	BREEDTE HANDDOEKBEUGEL	KLEUR	ART. NR.	€
HANDDOEKBEUGEL MULTI+ RECHTS	N1L1 / N2L1 / N1L1-ES / N2L1-ES / NS1L1 / NS2L1			
	600 mm	S600	1183 734 0000 0600	198
	600 mm	RAL 9005 ^S	1183 734 0000 9005	198
<ul style="list-style-type: none"> • h = 70 mm; b = 600 mm (b tablet = 194 mm); e = 176 mm; c = 170 mm; • Bevestiging aan de muur, rechts van de radiator. 				
HANDDOEKBEUGEL MULTI+ LINKS	N1L1 / N2L1 / N1L1-ES / N2L1-ES / NS1L1 / NS2L1			
	600 mm	S600	1183 735 0000 0600	198
	600 mm	RAL 9005 ^S	1183 735 0000 9005	198
<ul style="list-style-type: none"> • h = 70 mm; b = 600 mm (b tablet = 194 mm); e = 176 mm; c = 170 mm; • Bevestiging aan de muur, links van de radiator. 				
KORTE BEUGEL	N1L1 / N1L1-ES / NS1L1			
	240 mm	S600	1183 710 0000 0600	132
	240 mm	RAL 9005 ^S	1183 710 0000 9005	132
	N2L1 / N2L1-ES / NS2L1			
	240 mm	S600	1183 720 0000 0600	132
	240 mm	RAL 9005 ^S	1183 720 0000 9005	132
<ul style="list-style-type: none"> • N1L1 / N1L1-ES: d = 66,5 mm; a = 56,5 mm • NS1L1: d = 68 mm; a = 58 mm • N2L1 / N2L1-ES: d = 59,5 mm; a = 49,5 mm • NS2L1: d = 58 mm; a = 48 mm 				
LANGE BEUGEL	N1L1 / N1L1-ES / NS1L1			
	440 mm	S600	1183 711 0000 0600	132
	440 mm	RAL 9005 ^S	1183 711 0000 9005	132
	N2L1 / N2L1-ES / NS2L1			
	440 mm	S600	1183 721 0000 0600	132
	440 mm	RAL 9005 ^S	1183 721 0000 9005	132
<ul style="list-style-type: none"> • N1L1 / N1L1-ES: d = 66,5 mm; a = 56,5 mm • NS1L1: d = 68 mm; a = 58 mm • N2L1 / N2L1-ES: d = 59,5 mm; a = 49,5 mm • NS2L1: d = 58 mm; a = 48 mm 				

^S structuur zwart

Montagevoorschriften accessoires: zie www.vasco.eu
BELGIË. Prijzen in euro (excl. BTW)

e = afstand voorkant accessoire tot wand
d = afstand voorkant accessoire tot voorkant radiator
c = afstand wand tot achterkant beugel
a = afstand accessoire tot radiator
uit voorraad leverbaar

ACCESSOIRES	BREEDTE HANDDOEKBEUGEL	KLEUR	ART. NR.	€	
HANDDOEKBEUGEL 	N1L1 / N1L1-ES / NS1L1				
	372 mm	ALUMINIUM	1183 239 0000 0000	184	
	372 mm	UITLOPEND KOPER	1183 239 0000 0029	184	
	372 mm	CHROOM	1183 239 0000 0099	184	
	372 mm	S600	1183 239 0000 0600	184	
	372 mm	RAL 9005 ^M	1183 239 0000 9005	184	
	526 mm	CHROOM	1183 271 0000 0099	184	
	526 mm	S600	1183 271 0000 0600	184	
	526 mm	RAL 9005 ^M	1183 271 0000 9005	184	
<ul style="list-style-type: none"> Handdoekbeugel in geanodiseerd aluminium h = 55 mm; b = 372, 526 mm; d = 56 mm; a = 50 mm; 					
HANDDOEKBEUGEL 	N2L1 / N2L1-ES / NS2L1				
	372 mm	ALUMINIUM	1183 240 0000 0000	184	
	372 mm	UITLOPEND KOPER	1183 240 0000 0029	184	
	372 mm	CHROOM	1183 240 0000 0099	184	
	372 mm	S600	1183 240 0000 0600	184	
	372 mm	RAL 9005 ^M	1183 240 0000 9005	184	
	526 mm	CHROOM	1183 272 0000 0099	184	
	526 mm	S600	1183 272 0000 0600	184	
	526 mm	RAL 9005 ^M	1183 272 0000 9005	184	
<ul style="list-style-type: none"> Handdoekbeugel in geanodiseerd aluminium h = 55 mm; b = 372, 526 mm; d = 56 mm; a = 50 mm; 					
HANDDOEKBEUGEL 	BREEDTE RADIATOR	KLEUR	ART. NR.	€	
	N1L1 / N1L1-ES				
	420 mm	CHROOM	1183 213 0000 0099	184	
	520 mm	CHROOM	1183 214 0000 0099	184	
	520 mm	INOX/RVS	1183 214 0000 9993	184	
	620 mm	CHROOM	1183 215 0000 0099	184	
	620 mm	INOX/RVS	1183 215 0000 9993	184	
	720 mm	CHROOM	1183 216 0000 0099	184	
	<ul style="list-style-type: none"> h = 25 mm; b = 440, 540, 640, 740 mm; d = 73 mm; a = 57 mm 				
	HANDDOEKBEUGEL 	N2L1 / N2L1-ES			
		420 mm	CHROOM	1183 218 0000 0099	184
		520 mm	CHROOM	1183 219 0000 0099	184
		520 mm	UITLOPEND INOX/RVS	1183 219 0000 9993	184
		620 mm	CHROOM	1183 220 0000 0099	184
		620 mm	UITLOPEND INOX/RVS	1183 220 0000 9993	184
720 mm		CHROOM	1183 221 0000 0099	184	
<ul style="list-style-type: none"> h = 25 mm; b = 440, 540, 640, 740 mm; d = 73 mm; a = 57 mm 					
HANDDOEKBEUGEL 	NH1L1 / NH2L1 / NH2L2				
		CHROOM	1183 217 0000 0099	184	
<ul style="list-style-type: none"> h = 25 mm; b = 740 mm (zelf in te korten); d = 73 mm; a = 57 mm 					

^M mat zwart

Montagevoorschriften accessoires: zie www.vasco.eu
BELGIË. Prijzen in euro (excl. BTW)

d = afstand voorkant accessoire tot voorkant radiator
a = afstand accessoire tot radiator
uit voorraad leverbaar

NIVA LAK VERTICAAL: N1L1 / N2L1

NIVA INOX VERTICAAL: N1L1-ES / N2L1-ES

NIVA SOFT VERTICAAL: NS1L1 / NS2L1 (zonder geïntegreerd ventiel)

NIVA MIXED HYBRIDE: N1L1-EL-MIX

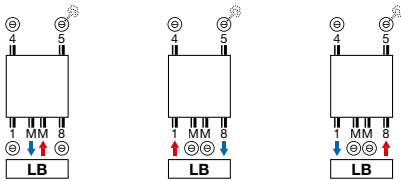

- **Opmerking:** MM met aanvoer rechts.

NIVA SOFT VERTICAAL: NS2L1

GEÏNTEGREERD VENTIEL

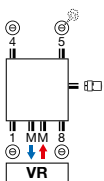

- **Meerprijs:** €154 (zie p. 341)
- **Opmerking:** MM met aanvoer rechts (op deze aansluiting bevindt zich op de achterzijde een stijgbuis).

NIVA LAK HORIZONTAAL: NH1L1 / NH2L1 / NH2L2

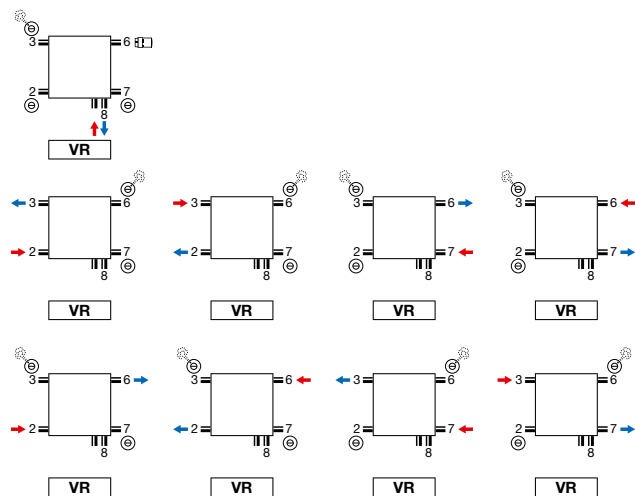

- **Geïntegreerd ventiel:** geen meerprijs (zie p. 341)
- **Thermostaatkop** enkel te gebruiken bij aansluiting op het ventiel (aanvoer links, retour rechts). Andere aansluitingen, vb. SL, thermostaatkop uit de aansluiting 6 nemen. Hier is wel de mogelijkheid om aanvoer en retour te wisselen.

Opmerking: het aansluiten van de radiator kan enkel volgens de getoonde aansluiticonen. Voor elke andere aansluitwijze nemen wij geen verantwoordelijkheid.

NIVA LAK VERTICAAL (N1L1, N2L1)

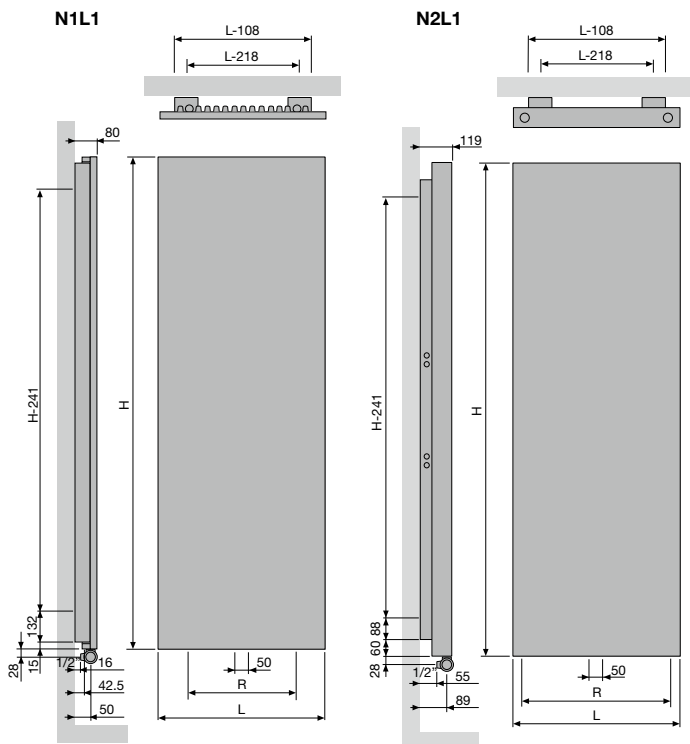

N1L1				
Breedte (L)	420	520	620	720
Hartafstand tussen de onderaansluitingen 18 (R)	200	300	400	500
Hartafstand tussen de ophangingen	L-218	H-241		

N2L1				
Breedte (L)	420	520	620	720
Hartafstand tussen de onderaansluitingen 18 (R)	338	438	538	638
Hartafstand tussen de ophangingen	L-218	H-241		

NIVA INOX VERTICAAL (N1L1-ES, N2L1-ES)

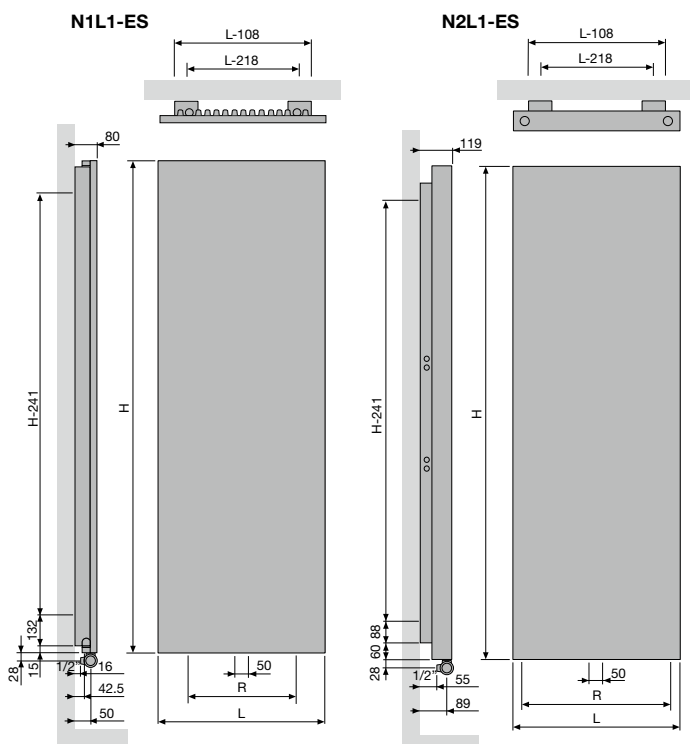

N1L1-ES				
Breedte (L)	520	620		
Hartafstand tussen de onderaansluitingen 18 (R)	300	400		
Hartafstand tussen de ophangingen	L-218	H-241		

N2L1-ES				
Breedte (L)	520	620		
Hartafstand tussen de onderaansluitingen 18 (R)	438	538		
Hartafstand tussen de ophangingen	L-218	H-241		

NIVA LAK HORIZONTAAL (NH1L1, NH2L1)

NH1L1 / NH2L1

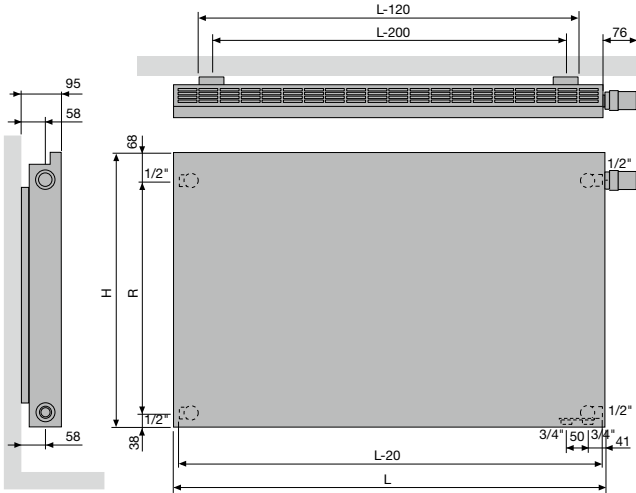

NH1L1				
hoogte (H)	450	550	650	950
Hartafstand tussen de zijaansluitingen SL/SR (R)	343	443	543	843
Hartafstand tussen de ophangingen	L-200			

NH2L1			
hoogte (H)	550	650	950
Hartafstand tussen de zijaansluitingen SL/SR (R)	443	543	843
Hartafstand tussen de ophangingen	L-200		

NIVA LAK HORIZONTAAL (NH2L2)

NH2L2

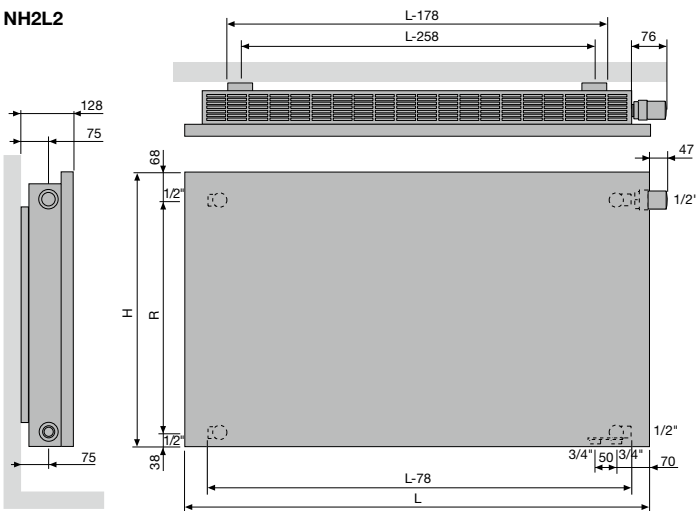

NH2L2			
hoogte (H)	550	650	950
Hartafstand tussen de zijaansluitingen SL/SR (R)	443	543	843
Hartafstand tussen de ophangingen	L-258		

NIVA SOFT VERTICAAL (NS1L1)

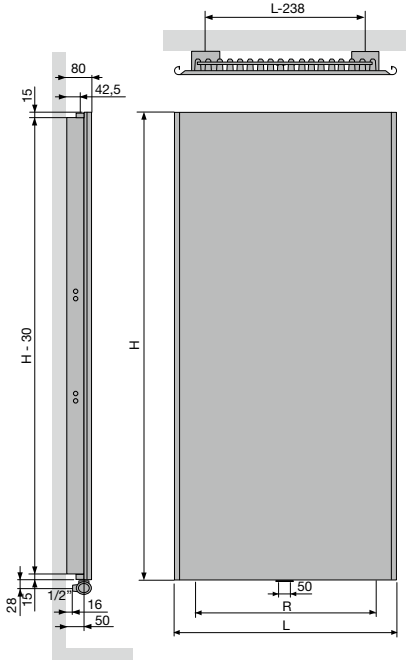

NS1L1				
Breedte (L)	440	540	640	740
Hartafstand tussen de onderaansluitingen 18 (R)	200	300	400	500
Hartafstand tussen de ophangingen	L-238	H-241		

NIVA SOFT VERTICAAL (NS2L1)

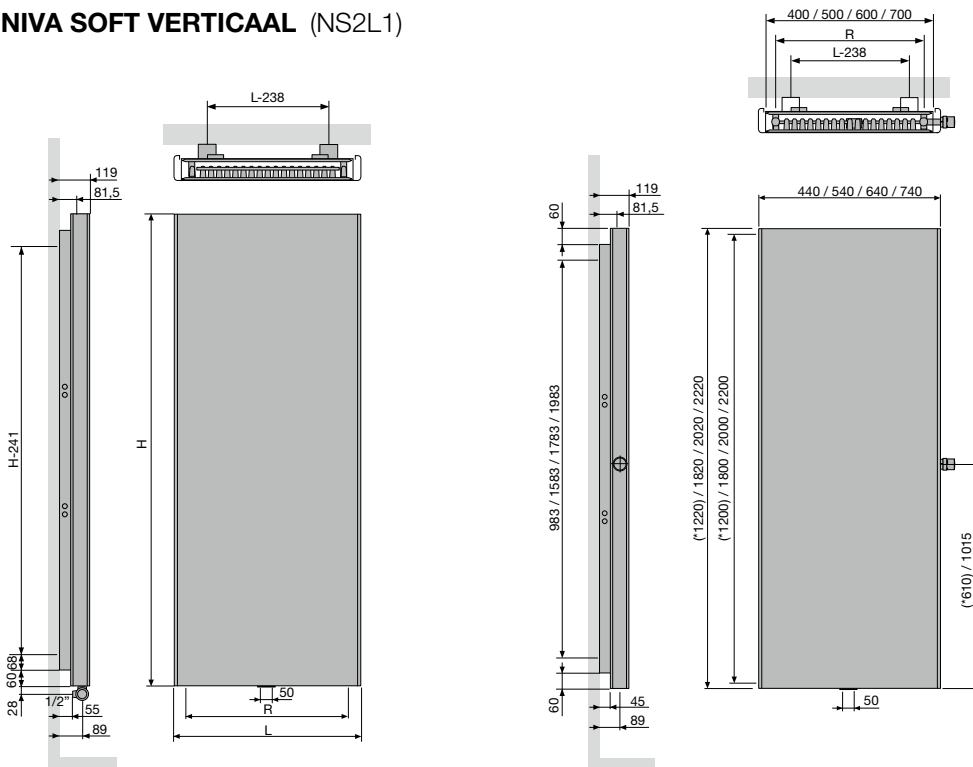

NS2L1				
Breedte (L)	440	540	640	740
Hartafstand tussen de onderaansluitingen 18 (R)	338	438	538	638
Hartafstand tussen de ophangingen	L-238	H-241		

NIVA VENTILO

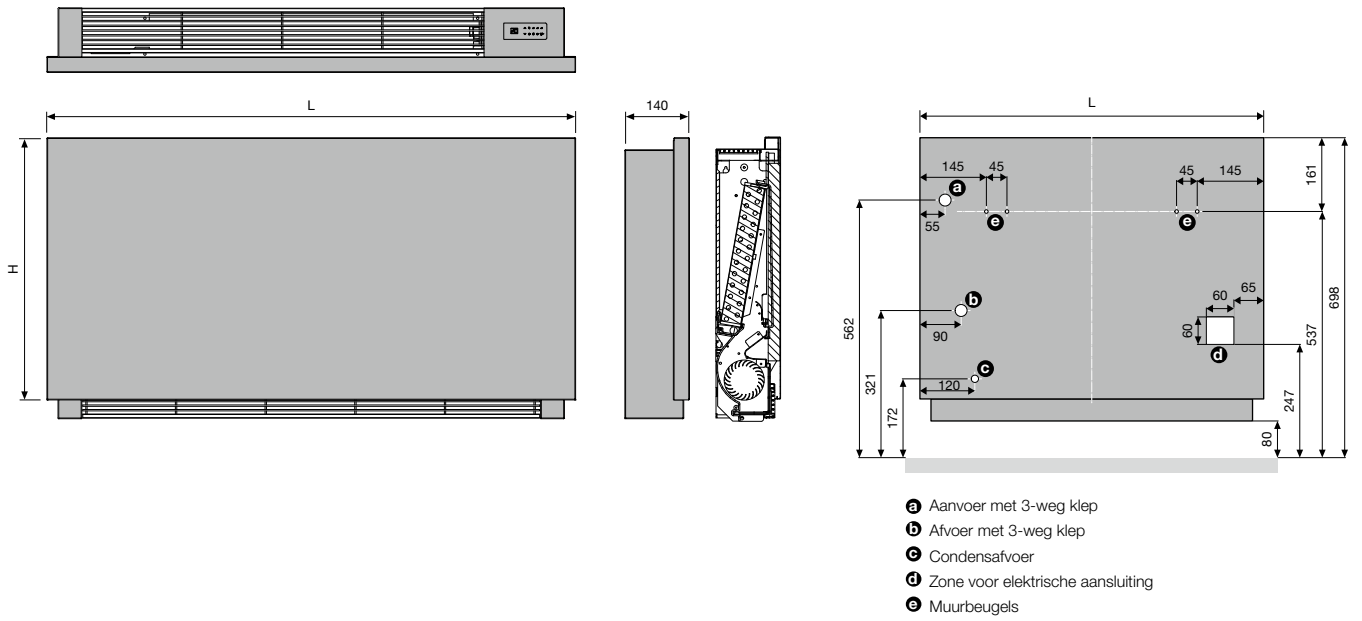

CARRÉ PLUS VERTICAAL (CPVN-PLUS)



TYPES

- Verticaal: Carré Plus (CPVN-PLUS)

BUIZEN

- Verticaal, vierkant 25 x 25 mm

COLLECTOREN

- Horizontaal, rond Ø 35 mm

KLEUREN

- Standaardkleur wit RAL 9016
- Uitgebreide kleurenkaart zie p. 12

BEVESTIGINGEN

- Muurbevestigingen standaard

TECHNISCH

- Weerstandsgelast (onzichtbare lasnaden)
- KTL-grondlaag, poedercoating
- Standaardwerkdruk: 10 bar
- Maximale bedrijfstemperatuur: 110°C

ELEKTRISCH

- ✗ Zuiver elektrische radiator in de fabriek vorgevuld
- ✗ Gemengde radiator

TECHNISCHE TEKENINGEN

- Zie p. 175

AANSLUITING

- ✗ Eénpuntsaansluiting voor éénpijpssysteem
- ✗ Eénpuntsaansluiting voor tweepijpssysteem
- ✓ Tweepuntsaansluiting voor éénpijpssysteem (aansluiting via de middenaansluiting) (zie p. 340)
- ✓ Tweepuntsaansluiting voor tweepijpssysteem (standaard) (zie p. 340)
- ✗ Geïntegreerd ventiel
- Aansluitingen: ½" (binnendraad)

CARRÉ PLUS VERTICAAL

Minimale tussenruimte, maximaal effect

Een icoon in de wereld van de designradiatoren. Speciaal voor de Carré ontwikkelde VASCO een heel nieuw type buis met scherpe hoeken voor een strakker design en met een optimaal warmerendement bij een minimale tussenruimte. De vlakke look creëert een gevoel van rust, versterkt door de weggewerkte, mooi in het geheel geïntegreerde collector. Een veel gelauwerde designradiator, waarvoor VASCO, zoals steeds, ook de passende accessoires ontwikkelde.

AANBEVOLEN AANSLUITING (LB)

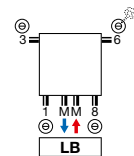

Andere aansluitmogelijkheden, zie p. 174



art. nr. 1182 103 0000 0099

prijs €175

Koppelingen, zie p. 353

AANBEVOLEN VOOR BADKAMER EN KEUKEN IN OPTIE



handdoekbeugel recht (chrom)

art. nr. zie p. 173

prijs €184

Andere accessoires, zie p. 173



HOE CARRÉ PLUS VERTICAAL BESTELLEN

Leveringstermijn 15 - 30 werkdagen
(zonder transportduur)

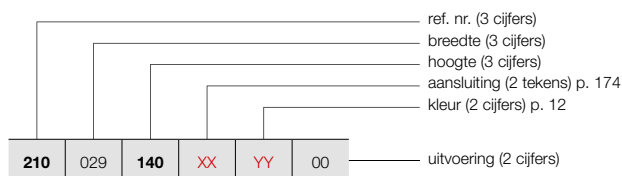

CARRÉ PLUS VERTICAAL (CPVN-PLUS)



CPVN-PLUS

HOE VOORRAADRADIATOR CARRÉ PLUS VERTICAAL BESTELLEN

Leveringstermijn 5 werkdagen
(zonder transportduur)

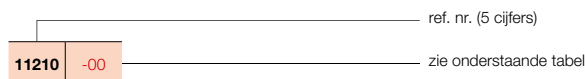

PRIJSGROEP: VPG2 - STAAL DESIGNRADIATOREN

BESTELCODE MAATWERK CARRÉ PLUS VERTICAAL	TECHNISCHE GEGEVENS							STANDAARDKLEUR		ANDERE KLEUREN		
	buizen	breedte (L mm)	hoogte (H mm)	75/65/20 (Watt) (Φ50K)	55/45/20 (Watt) (Φ30K)	n-exp.	gewicht (kg)	inhoud (l)	el. weerst. (Watt)		prijs RAL 9016 (€)	verkorte ref. nr. RAL 9016 voorraad
REF. NR. CARRÉ PLUS VERTICAAL CPVN-PLUS : 210												
210 029 140 XX YY 00	10	295	1400	871	443	1,31	19,70	8,40	-	474	-	545
	10	295	1600	986	505	1,31	21,60	9,40	-	521	-	599
	10	295	1800	1097	559	1,32	23,60	10,50	-	564	-	649
	10	295	2000	1206	614	1,32	26,20	12,00	-	607	-	698
	10	295	2200	1312	672	1,31	28,90	13,50	-	650	-	748
210 035 140 XX YY 00	12	355	1400	1026	521	1,31	23,16	10,08	-	571	-	657
	12	355	1600	1161	595	1,31	25,44	11,28	-	624	-	718
	12	355	1800	1293	659	1,32	27,72	12,48	-	679	11210-16	781
	12	355	2000	1421	724	1,32	30,96	14,40	-	729	-	838
	12	355	2200	1545	791	1,31	34,08	16,20	-	777	-	894
210 041 140 XX YY 00	14	415	1400	1179	599	1,31	26,46	11,76	-	665	-	765
	14	415	1600	1334	683	1,31	29,12	13,16	-	729	-	838
	14	415	1800	1485	757	1,32	31,64	14,56	-	791	-	910
	14	415	2000	1632	836	1,31	35,42	16,66	-	848	11210-05	975
	14	415	2200	1775	909	1,31	39,20	18,90	-	908	-	1044
210 047 140 XX YY 00	16	475	1400	1330	676	1,31	29,60	13,28	-	759	-	873
	16	475	1600	1505	771	1,31	32,48	14,88	-	834	-	959
	16	475	1800	1675	853	1,32	35,52	16,48	-	903	-	1038
	16	475	2000	1841	943	1,31	39,84	19,04	-	972	-	1118
	16	475	2200	2002	1025	1,31	44,00	21,60	-	1036	-	1191
210 053 140 XX YY 00	18	535	1400	1478	751	1,31	32,58	14,94	-	853	-	981
	18	535	1600	1673	857	1,31	35,82	16,74	-	936	-	1076
	18	535	1800	1862	954	1,31	39,06	18,54	-	1016	11210-07	1168
	18	535	2000	2046	1048	1,31	43,92	21,42	-	1092	11210-09	1256
	18	535	2200	2226	1140	1,31	48,78	24,30	-	1165	-	1340
210 059 140 XX YY 00	20	595	1400	1625	826	1,31	35,20	16,60	-	951	-	1094
	20	595	1600	1839	942	1,31	39,00	18,60	-	1043	-	1199
	20	595	1800	2047	1048	1,31	42,60	20,40	-	1129	11210-11	1298
	20	595	2000	2250	1152	1,31	48,00	23,60	-	1214	11210-12	1396
	20	595	2200	2447	1260	1,30	53,40	27,00	-	1296	-	1490
210 065 140 XX YY 00	22	655	1400	1771	900	1,31	37,84	18,26	-	1047	-	1204
	22	655	1600	2004	1026	1,31	41,80	20,24	-	1146	-	1318
	22	655	1800	2231	1143	1,31	45,76	22,44	-	1242	-	1428
	22	655	2000	2451	1255	1,31	51,70	25,96	-	1338	-	1539
	22	655	2200	2666	1372	1,30	57,64	29,48	-	1427	-	1641
210 071 140 XX YY 00	24	715	1400	1915	973	1,31	40,32	19,68	-	1139	-	1310
	24	715	1600	2167	1110	1,31	44,64	22,08	-	1251	-	1439
	24	715	1800	2412	1235	1,31	48,96	24,24	-	1354	-	1557
	24	715	2000	2651	1365	1,30	55,44	28,32	-	1456	-	1674
	24	715	2200	2883	1484	1,30	61,92	32,16	-	1554	-	1787

Conform EN442-1: 2014: radiatoren en convectoren

Voor meer details over onze artikel-data, zie artikel-database: <https://www.installdata.be>

Voor de warmteafgifte van andere regimes, kijkt u op p. 346 (correctiefactoren)
BELGIË. Prijzen in euro (excl. BTW)

CARRÉ PLUS VERTICAAL (CPVN-PLUS)



CPVN-PLUS

HOE CARRÉ PLUS VERTICAAL BESTELLEN

Leveringstermijn 15 - 30 werkdagen
(zonder transportduur)

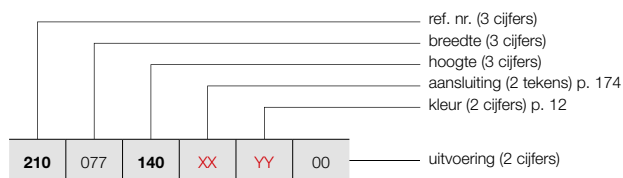

PRIJSGROEP: VPG2 - STAAL DESIGNRADIATOREN

BESTELCODE MAATWERK CARRÉ PLUS VERTICAAL	TECHNISCHE GEGEVENS									STANDAARDKLEUR	ANDERE KLEUREN
	buizen	breedte (L mm)	hoogte (H mm)	75/65/20 (Watt) (Φ50K)	55/45/20 (Watt) (Φ30K)	n-exp.	gewicht (kg)	inhoud (l)	el. weerst. (Watt)	prijs RAL 9016 (€)	prijs kleur (€)
REF. NR. CARRÉ PLUS VERTICAAL CPVN-PLUS : 210											
210	077	140	XX	YY	00						
		160								1236	1421
		180								1354	1557
		200								1468	1688
		220								1578	1815
										1685	1938
210	089	140	XX	YY	00						
		160								1427	1641
		180								1562	1796
		200								1692	1946
		220								1819	2092
										1946	2238

Conform EN442-1: 2014: radiatoren en convectoren

Voor meer details over onze artikel-data, zie artikel-database: <https://www.installdata.be>

Voor de warmteafgifte van andere regimes, kijkt u op p. 346 (correctiefactoren)
BELGIË. Prijzen in euro (excl. BTW)

TYPES

- Twee rijen buizen (CPVN2-ZB)

BUIZEN

- Verticaal, vierkant 25 x 25 mm

COLLECTOREN

- Horizontaal, rond Ø 35 mm

KLEUREN

- Standaardkleur wit RAL 9016
- Uitgebreide kleurenkaart zie p. 12

BEVESTIGINGEN

- Muurbevestigingen in de kleur RAL 9016 standaard. Ook in optie verkrijgbaar in de kleur RAL 7016 (zie p. 173).

TECHNISCH

- Weerstandsgelast (onzichtbare lasnaden)
- KTL-grondlaag, poedercoating
- Standaardwerkdruk: 10 bar
- Maximale bedrijfstemperatuur: 110°C

ELEKTRISCH

- ✗ Zuiver elektrische radiator in de fabriek vorgevuld
- ✗ Gemengde radiator

TECHNISCHE TEKENINGEN

- Zie p. 175

AANSLUITING

- ✗ Eénpuntsaansluiting voor éénpijpssysteem
- ✗ Eénpuntsaansluiting voor tweepijpssysteem
- ✓ Tweepuntsaansluiting voor éénpijpssysteem (aansluiting via de middenaansluiting) (zie p. 340)
- ✓ Tweepuntsaansluiting voor tweepijpssysteem (standaard) (zie p. 340)
- ✗ Geïntegreerd ventiel
- Aansluitingen: ½" (binnendraad)



AANBEVOLEN AANSLUITING (LB)

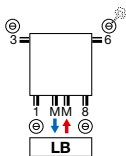

Andere aansluitmogelijkheden, zie p. 174



art. nr. 1182 103.0000 0099

prijs €175

Koppelingen, zie p. 353

**AANBEVOLEN VOOR BADKAMER EN KEUKEN
IN OPTIE**



handdoekbeugel recht (chrom) art. nr. zie p. 173

prijs €184

Andere accessoires, zie p. 173

CARRÉ VERTICAAL

Topdesign met dubbele warmtecapaciteit

De strakke, vlakke look van de Carré Plus, voorzien van een dubbele buizenrij voor een maximale warmteafgifte. De Carré Verticaal designradiator blijft in alles zijn tijdloze, functionele zelf, maar garandeert door die extra capaciteit ook in grotere ruimten een optimaal rendement.



CARRÉ VERTICAAL (CPVN2-ZB)

HOE CARRÉ VERTICAAL BESTELLEN
Leveringstermijn 15 - 30 werkdagen
(zonder transportduur)

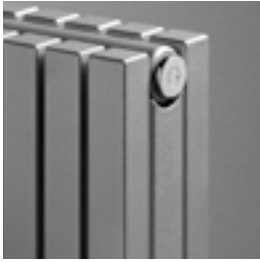

CPVN2-ZB

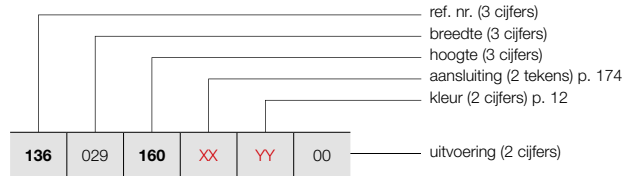

PRIJSGROEP: VPG2 - STAAL DESIGNRADIATOREN

BESTELCODE MAATWERK CARRÉ VERTICAAL	TECHNISCHE GEGEVENS									STANDAARDKLEUR	ANDERE KLEUREN
	buizen	breedte (L mm)	hoogte (H mm)	75/65/20 (Watt) (Φ50K)	55/45/20 (Watt) (Φ30K)	n-exp.	gewicht (kg)	inhoud (l)	el. weerst. (Watt)	prijs RAL 9016 (€)	prijs kleur (€)
REF. NR. CARRÉ VERTICAAL CPVN2-ZB : 136											
136 029 160 XX YY 00	10	295	1600	1062	533	1,35	30,20	15,80	-	834	959
	10	295	1800	1174	589	1,35	33,80	17,90	-	903	1038
	10	295	2000	1279	642	1,35	37,30	20,10	-	972	1118
	10	295	2200	1377	691	1,35	40,60	21,30	-	1036	1191
	10	295	2400	1469	737	1,35	43,80	22,60	-	1101	1266
	10	295	2600	1555	780	1,35	47,10	23,90	-	1163	1337
	10	295	2800	1635	820	1,35	50,30	25,10	-	1224	1408
	10	295	3000	1709	858	1,35	53,60	26,40	-	1281	1473
136 035 160 XX YY 00	12	355	1600	1275	640	1,35	36,24	18,96	-	998	1148
	12	355	1800	1409	707	1,35	40,56	21,48	-	1084	1247
	12	355	2000	1534	770	1,35	44,76	24,12	-	1165	1340
	12	355	2200	1652	829	1,35	48,72	25,56	-	1243	1429
	12	355	2400	1763	885	1,35	52,56	27,12	-	1319	1517
	12	355	2600	1866	936	1,35	56,52	28,68	-	1393	1602
	12	355	2800	1962	984	1,35	60,36	30,12	-	1467	1687
	12	355	3000	2050	1029	1,35	64,32	31,68	-	1539	1770
136 041 160 XX YY 00	14	415	1600	1487	746	1,35	42,28	22,12	-	1165	1340
	14	415	1800	1643	824	1,35	47,32	25,06	-	1266	1456
	14	415	2000	1790	898	1,35	52,22	28,14	-	1359	1563
	14	415	2200	1928	967	1,35	56,84	29,82	-	1453	1671
	14	415	2400	2057	1032	1,35	61,32	31,64	-	1539	1770
	14	415	2600	2177	1092	1,35	65,94	33,46	-	1626	1870
	14	415	2800	2289	1149	1,35	70,42	35,14	-	1713	1970
	14	415	3000	2392	1200	1,35	75,04	36,96	-	1793	2062
136 047 160 XX YY 00	16	475	1600	1700	853	1,35	48,32	25,28	-	1335	1535
	16	475	1800	1878	942	1,35	54,08	28,64	-	1445	1662
	16	475	2000	2046	1027	1,35	59,68	32,16	-	1554	1787
	16	475	2200	2203	1105	1,35	64,96	34,08	-	1657	1906
	16	475	2400	2351	1180	1,35	70,08	36,16	-	1759	2023
	16	475	2600	2488	1248	1,35	75,36	38,24	-	1862	2141
	16	475	2800	2616	1313	1,35	80,48	40,16	-	1958	2252
	16	475	3000	2734	1372	1,35	85,76	42,24	-	2052	2360
136 053 160 XX YY 00	18	535	1600	1912	959	1,35	54,36	28,44	-	1500	1725
	18	535	1800	2113	1060	1,35	60,84	32,22	-	1626	1870
	18	535	2000	2301	1155	1,35	67,14	36,18	-	1750	2013
	18	535	2200	2479	1244	1,35	73,08	38,34	-	1867	2147
	18	535	2400	2644	1327	1,35	78,84	40,68	-	1981	2278
	18	535	2600	2799	1404	1,35	84,78	43,02	-	2094	2408
	18	535	2800	2942	1476	1,35	90,54	45,18	-	2201	2531
	18	535	3000	3075	1543	1,35	96,48	47,52	-	2307	2653

Conform EN442-1: 2014: radiatoren en convectoren

Voor meer details over onze artikel-data, zie artikel-database: <https://www.installdata.be>
Voor de warmteafgiftes van andere regimes, kijkt u op p. 346 (correctiefactoren)
BELGIË. Prijzen in euro (excl. BTW)

HOE CARRÉ VERTICAAL BESTELLEN

Leveringstermijn 15 - 30 werkdagen
(zonder transportduur)

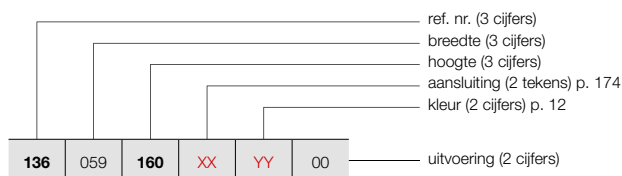

CARRÉ VERTICAAL (CPVN2-ZB)



CPVN2-ZB

PRIJSGROEP: VPG2 - STAAL DESIGNRADIATOREN

BESTELCODE MAATWERK CARRÉ VERTICAAL	TECHNISCHE GEGEVENS							STANDAARDKLEUR		ANDERE KLEUREN						
	buizen	breedte (L mm)	hoogte (H mm)	75/65/20 (Watt) (Φ50K)	55/45/20 (Watt) (Φ30K)	n-exp.	gewicht (kg)	inhoud (l)	el. weerst. (Watt)	prijs RAL 9016 (€)	prijs kleur (€)					
REF. NR. CARRÉ VERTICAAL CPVN2-ZB : 136																
136	059	160	XX	YY	00	20	595	1600	2125	1066	1,35	60,40	31,60	-	1668	1918
		180				20	595	1800	2348	1178	1,35	67,60	35,80	-	1807	2078
		200				20	595	2000	2557	1283	1,35	74,60	40,20	-	1942	2233
		220				20	595	2200	2754	1382	1,35	81,20	42,60	-	2073	2384
		240				20	595	2400	2938	1474	1,35	87,60	45,20	-	2200	2530
		260				20	595	2600	3110	1561	1,35	94,20	47,80	-	2325	2674
		280				20	595	2800	3269	1640	1,35	100,60	50,20	-	2444	2811
		300				20	595	3000	3417	1715	1,35	107,20	52,80	-	2564	2949
136	065	160	XX	YY	00	22	655	1600	2337	1173	1,35	66,44	34,76	-	1834	2109
		180				22	655	1800	2582	1296	1,35	74,36	39,38	-	1987	2285
		200				22	655	2000	2812	1411	1,35	82,06	44,22	-	2137	2458
		220				22	655	2200	3029	1520	1,35	89,32	46,86	-	2281	2623
		240				22	655	2400	3232	1622	1,35	96,36	49,72	-	2421	2784
		260				22	655	2600	3421	1717	1,35	103,62	52,58	-	2559	2943
		280				22	655	2800	3596	1804	1,35	110,66	55,22	-	2691	3095
		300				22	655	3000	3759	1886	1,35	117,92	58,08	-	2821	3244
136	071	160	XX	YY	00	24	715	1600	2550	1280	1,35	72,48	37,92	-	2001	2301
		180				24	715	1800	2817	1413	1,35	81,12	42,96	-	2166	2491
		200				24	715	2000	3069	1540	1,35	89,52	48,24	-	2331	2681
		220				24	715	2200	3305	1658	1,35	97,44	51,12	-	2484	2857
		240				24	715	2400	3526	1769	1,35	105,12	54,24	-	2644	3041
		260				24	715	2600	3732	1873	1,35	113,04	57,36	-	2792	3211
		280				24	715	2800	3923	1968	1,35	120,72	60,24	-	2934	3374
		300				24	715	3000	4101	2058	1,35	128,64	63,36	-	3080	3542
136	077	160	XX	YY	00	26	775	1600	2762	1386	1,35	78,52	41,08	-	2166	2491
		180				26	775	1800	3052	1531	1,35	87,88	46,54	-	2348	2700
		200				26	775	2000	3324	1668	1,35	96,98	52,26	-	2525	2904
		220				26	775	2200	3580	1796	1,35	105,56	55,38	-	2696	3100
		240				26	775	2400	3820	1917	1,35	113,88	58,76	-	2859	3288
		260				26	775	2600	4043	2029	1,35	122,46	62,14	-	3023	3476
		280				26	775	2800	4250	2133	1,35	130,78	65,26	-	3180	3657
		300				26	775	3000	4442	2229	1,35	139,36	68,64	-	3333	3833
136	089	160	XX	YY	00	30	895	1600	3187	1599	1,35	90,60	47,40	-	2498	2873
		180				30	895	1800	3521	1767	1,35	101,40	53,70	-	2710	3117
		200				30	895	2000	3836	1925	1,35	111,90	60,30	-	2911	3348
		220				30	895	2200	4131	2073	1,35	121,80	63,90	-	3113	3580
		240				30	895	2400	4407	2211	1,35	131,40	67,80	-	3298	3793
		260				30	895	2600	4665	2341	1,35	141,30	71,70	-	3489	4012

Conform EN442-1: 2014: radiatoren en convectoren

Voor meer details over onze artikel-data, zie artikel-database: <https://www.installdata.be>
Voor de warmteafgiftes van andere regimes, kijkt u op p. 346 (correctiefactoren)
BELGIË. Prijzen in euro (excl. BTW)

CARRÉ HORIZONTAAL (CPHN1-RO, CPHN2-RO)



TYPES

- Eén (CPHN1-RO) of twee rijen buizen (CPHN2-RO)

BUIZEN

- Horizontaal, vierkant 25 x 25 mm

COLLECTOREN

- Verticaal, rond Ø 35 mm

KLEUREN

- Standaardkleur wit RAL 9016
- Uitgebreide kleurenkaart zie p. 12

SPECIAAL

- CPHN1-RO ook verkrijgbaar als toileradiator (600 x 415 mm)

BEVESTIGINGEN

- Muurbevestigingen in de kleur RAL 9016 standaard. Ook in optie verkrijgbaar in de kleur RAL 7016 (zie p. 173).

TECHNISCH

- Weerstandsgelast (onzichtbare lasnaden)
- KTL-grondlaag, poedercoating
- Standaardwerkdruk: 10 bar
- Maximale bedrijfstemperatuur: 110°C

ELEKTRISCH

- ✗ Zuiver elektrische radiator in de fabriek voorgevuld
- ✗ Gemengde radiator

TECHNISCHE TEKENINGEN

- Zie p. 176

AANSLUITING

- ✗ Eénpuntsaansluiting voor éénpijpsysteem
- ✗ Eénpuntsaansluiting voor tweepijpsysteem
- ✗ Tweepuntsaansluiting voor éénpijpsysteem
- ✓ Tweepuntsaansluiting voor tweepijpsysteem (standaard) (zie p. 340)
- ✗ Geïntegreerd ventiel
- Aansluitingen: ½" (binnendraad)

CARRÉ HORIZONTAAL

Topdesign voor elke warmtebehoefte

De horizontale versie van de Carré, met keuze uit één of twee buizenrijen voor een warmteafgifte op maat in elke ruimte. Een designradiator die ook in de horizontale uitvoering uitblinkt door zijn strak design en zijn vlakke look, nog versterkt door de in het geheel geïntegreerde collector.

AANBEVOLEN AANSLUITING (18)

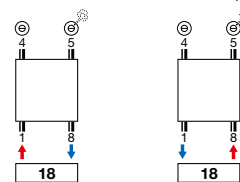

Andere aansluitmogelijkheden, zie p. 174



art. nr. 1182 101 0000 0099

prijs €215

Koppelingen, zie p. 353

AANBEVOLEN VOOR BADKAMER EN KEUKEN IN OPTIE



handdoekbeugel recht (chrom) art. nr. zie p. 173

prijs €184

Andere accessoires, zie p. 173



HOE CARRÉ HORIZONTAAL BESTELLEN

Leveringstermijn 15 - 30 werkdagen
(zonder transportduur)

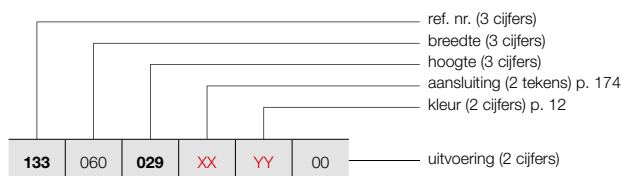

CARRÉ HORIZONTAAL (CPHN1-RO)



CPHN1-RO

PRIJSGROEP: VPG2 - STAAL DESIGNRADIATOREN

BESTELCODE MAATWERK CARRÉ HORIZONTAAL	TECHNISCHE GEGEVENS							STANDAARDKLEUR		ANDERE KLEUREN		
	buizen	breedte (L mm)	hoogte (H mm)	75/65/20 (Watt) (φ50K)	55/45/20 (Watt) (φ30K)	n-exp.	gewicht (kg)	inhoud (l)	el. weerst. (Watt)	prijs RAL 9016 (€)	prijs kleur (€)	
REF. NR. CARRÉ HORIZONTAAL CPHN1-RO : 133												
133 060 029 XX YY 00	035	10	600	295	221	117	1,25	6,19	2,85	-	228	262
	041	12	600	355	259	137	1,25	7,41	3,60	-	274	315
	047	14	600	415	296	156	1,25	8,63	4,35	-	319	367
	053	16	600	475	333	176	1,25	9,86	5,10	-	364	419
	059	18	600	535	369	195	1,25	11,08	5,85	-	408	469
	065	20	600	595	404	213	1,25	12,30	6,60	-	455	523
	077	22	600	655	439	231	1,26	13,42	6,94	-	503	578
	089	26	600	775	507	266	1,26	15,67	7,63	-	593	682
		30	600	895	574	302	1,26	17,91	8,31	-	685	788
	133 080 029 XX YY 00	035	10	800	295	295	156	1,25	8,25	3,80	-	279
041		12	800	355	346	183	1,25	9,88	4,80	-	330	380
047		14	800	415	395	209	1,25	11,51	5,80	-	389	447
053		16	800	475	444	234	1,25	13,14	6,80	-	442	508
059		18	800	535	492	260	1,25	14,77	7,80	-	499	574
065		20	800	595	538	284	1,25	16,40	8,80	-	555	638
077		22	800	655	585	307	1,26	17,90	9,26	-	610	702
089		26	800	775	676	355	1,26	20,89	10,17	-	723	831
		30	800	895	766	402	1,26	23,88	11,08	-	833	958
133 100 029 XX YY 00		035	10	1000	295	369	195	1,25	10,31	4,75	-	323
	041	12	1000	355	432	228	1,25	12,35	6,00	-	389	447
	047	14	1000	415	494	261	1,25	14,39	7,25	-	453	521
	053	16	1000	475	555	293	1,25	16,43	8,50	-	518	596
	059	18	1000	535	615	325	1,25	18,46	9,75	-	581	668
	065	20	1000	595	673	355	1,25	20,50	11,00	-	649	746
	077	22	1000	655	731	384	1,26	22,37	11,57	-	712	819
	089	26	1000	775	845	444	1,26	26,11	12,71	-	840	966
		30	1000	895	957	503	1,26	29,85	13,85	-	970	1116
	133 120 029 XX YY 00	035	10	1200	295	443	234	1,25	12,37	5,70	-	365
041		12	1200	355	518	274	1,25	14,82	7,20	-	440	506
047		14	1200	415	593	313	1,25	17,27	8,70	-	514	591
053		16	1200	475	666	352	1,25	19,72	10,20	-	588	676
059		18	1200	535	738	390	1,25	22,15	11,70	-	660	759
065		20	1200	595	808	427	1,25	24,60	13,20	-	733	843
077		22	1200	655	877	461	1,26	26,84	13,88	-	805	926
089		26	1200	775	1014	533	1,26	31,33	15,25	-	954	1097
		30	1200	895	1148	603	1,26	35,82	16,62	-	1096	1260
133 140 029 XX YY 00		035	10	1400	295	517	273	1,25	14,43	6,65	-	405
	041	12	1400	355	605	319	1,25	17,29	8,40	-	488	561
	047	14	1400	415	692	365	1,25	20,15	10,15	-	571	657
	053	16	1400	475	777	410	1,25	23,00	11,90	-	652	750
	059	18	1400	535	861	455	1,25	25,84	13,65	-	733	843
	065	20	1400	595	942	497	1,25	28,70	15,40	-	815	937
	077	22	1400	655	1023	537	1,26	31,32	16,20	-	896	1030
	089	26	1400	775	1183	622	1,26	36,55	17,79	-	1059	1218
		30	1400	895	1340	704	1,26	41,79	19,39	-	1219	1402

Conform EN442-1: 2014: radiatoren en convectoren

Voor meer details over onze artikel-data, zie artikel-database: <https://www.installdata.be>

Voor de warmteafgiftes van andere regimes, kijkt u op p. 346 (correctiefactoren)
BELGIË. Prijzen in euro (excl. BTW)

CARRÉ HORIZONTAAL (CPHN1-RO)

HOE CARRÉ HORIZONTAAL BESTELLEN

Leveringstermijn 15 - 30 werkdagen
(zonder transportduur)

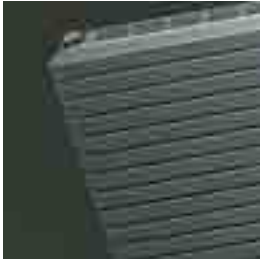

CPHN1-RO

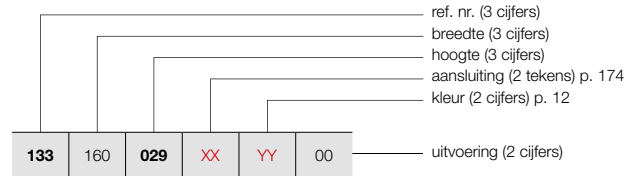

PRIJSGROEP: VPG2 - STAAL DESIGNRADIATOREN

BESTELCODE MAATWERK CARRÉ HORIZONTAAL							TECHNISCHE GEGEVENS				STANDAARDKLEUR	ANDERE KLEUREN				
buizen	breedte (L mm)	hoogte (H mm)	75/65/20 (Watt) (Φ50K)	55/45/20 (Watt) (Φ30K)	n-exp.	gewicht (kg)	inhoud (l)	el. weerst. (Watt)	prijs RAL 9016 (€)	prijs kleur (€)						
REF. NR. CARRÉ HORIZONTAAL CPHN1-RO : 133																
133	160	029	XX	YY	00	10	1600	295	590	312	1,25	16,50	7,60	-	446	513
		035				12	1600	355	691	365	1,25	19,76	9,60	-	535	615
		041				14	1600	415	790	417	1,25	23,02	11,60	-	624	718
		047				16	1600	475	888	469	1,25	26,29	13,60	-	716	823
		053				18	1600	535	984	520	1,25	29,54	15,60	-	802	922
		059				20	1600	595	1077	569	1,25	32,80	17,60	-	891	1025
		065				22	1600	655	1170	615	1,26	35,79	18,51	-	984	1132
		077				26	1600	775	1352	710	1,26	41,78	20,34	-	1162	1336
		089				30	1600	895	1531	804	1,26	47,76	22,16	-	1340	1541
133	180	029	XX	YY	00	10	1800	295	664	351	1,25	18,56	8,55	-	483	555
		035				12	1800	355	778	411	1,25	22,23	10,80	-	581	668
		041				14	1800	415	889	469	1,25	25,90	13,05	-	679	781
		047				16	1800	475	999	528	1,25	29,57	15,30	-	773	889
		053				18	1800	535	1107	585	1,25	33,23	17,55	-	872	1003
		059				20	1800	595	1211	639	1,25	36,90	19,80	-	969	1114
		065				22	1800	655	1316	691	1,26	40,27	20,83	-	1064	1224
		077				26	1800	775	1521	799	1,26	47,00	22,88	-	1259	1448
		089				30	1800	895	1723	905	1,26	53,73	24,93	-	1450	1668
133	200	029	XX	YY	00	10	2000	295	738	390	1,25	20,62	9,50	-	521	599
		035				12	2000	355	864	456	1,25	24,70	12,00	-	623	716
		041				14	2000	415	988	522	1,25	28,78	14,50	-	729	838
		047				16	2000	475	1110	586	1,25	32,86	17,00	-	833	958
		053				18	2000	535	1230	650	1,25	36,92	19,50	-	935	1075
		059				20	2000	595	1346	711	1,25	41,00	22,00	-	1041	1197
		065				22	2000	655	1462	768	1,26	44,74	23,14	-	1144	1316
		077				26	2000	775	1690	888	1,26	52,22	25,42	-	1352	1555
		089				30	2000	895	1914	1006	1,26	59,70	27,70	-	1561	1795
133	220	029	XX	YY	00	10	2200	295	812	429	1,25	22,68	10,45	-	555	638
		035				12	2200	355	950	502	1,25	27,17	13,20	-	666	766
		041				14	2200	415	1087	574	1,25	31,66	15,95	-	777	894
		047				16	2200	475	1221	645	1,25	36,15	18,70	-	888	1021
		053				18	2200	535	1353	714	1,25	40,61	21,45	-	998	1148
		059				20	2200	595	1481	782	1,25	45,10	24,20	-	1111	1278
		065				22	2200	655	1608	845	1,26	49,21	25,45	-	1219	1402
		077				26	2200	775	1859	977	1,26	57,44	27,96	-	1444	1661
		089				30	2200	895	2105	1106	1,26	65,67	30,47	-	1668	1918
133	240	029	XX	YY	00	10	2400	295	886	468	1,25	24,74	11,40	-	591	680
		035				12	2400	355	1037	548	1,25	29,64	14,40	-	706	812
		041				14	2400	415	1186	626	1,25	34,54	17,40	-	826	950
		047				16	2400	475	1332	703	1,25	39,43	20,40	-	945	1087
		053				18	2400	535	1476	779	1,25	44,30	23,40	-	1061	1220
		059				20	2400	595	1615	853	1,25	49,20	26,40	-	1179	1356
		065				22	2400	655	1754	922	1,26	53,69	27,77	-	1296	1490
		077				26	2400	775	2028	1065	1,26	62,66	30,50	-	1533	1763
		089				30	2400	895	2297	1207	1,26	71,64	33,24	-	1768	2033

Conform EN442-1: 2014: radiatoren en convectoren

Voor meer details over onze artikel-data, zie artikel-database: <https://www.installdata.be>

Voor de warmteafgiftes van andere regimes, kijkt u op p. 346 (correctiefactoren)
BELGIË. Prijzen in euro (excl. BTW)

HOE CARRÉ HORIZONTAAL BESTELLEN

Leveringstermijn 15 - 30 werkdagen
(zonder transportduur)

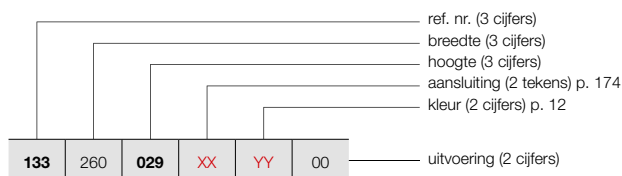

CARRÉ HORIZONTAAL (CPHN1-RO)



CPHN1-RO

PRIJSGROEP: VPG2 - STAAL DESIGNRADIATOREN

BESTELCODE MAATWERK CARRÉ HORIZONTAAL	TECHNISCHE GEGEVENS							STANDAARDKLEUR		ANDERE KLEUREN						
	buizen	breedte (L mm)	hoogte (H mm)	75/65/20 (Watt) (Φ50K)	55/45/20 (Watt) (Φ30K)	n-exp.	gewicht (kg)	inhoud (l)	el. weerst. (Watt)	prijs RAL 9016 (€)	prijs kleur (€)					
REF. NR. CARRÉ HORIZONTAAL CPHN1-RO : 133																
133	260	029	XX	YY	00	10	2600	295	959	506	1,25	26,81	12,35	-	622	715
						12	2600	355	1123	593	1,25	32,11	15,60	-	747	859
						14	2600	415	1284	678	1,25	37,41	18,85	-	872	1003
						16	2600	475	1443	762	1,25	42,72	22,10	-	995	1144
						18	2600	535	1599	844	1,25	48,00	25,35	-	1122	1290
						20	2600	595	1750	924	1,25	53,30	28,60	-	1246	1433
						22	2600	655	1901	999	1,26	58,16	30,08	-	1369	1574
						26	2600	775	2197	1154	1,26	67,89	33,05	-	1619	1862
						30	2600	895	2488	1307	1,26	77,61	36,01	-	1869	2149
						133	280	029	XX	YY	00	10	2800	295	1033	545
12	2800	355	1210	639	1,25							34,58	16,80	-	787	905
14	2800	415	1383	730	1,25							40,29	20,30	-	917	1055
16	2800	475	1554	821	1,25							46,00	23,80	-	1049	1206
18	2800	535	1722	909	1,25							51,69	27,30	-	1179	1356
20	2800	595	1884	995	1,25							57,40	30,80	-	1311	1508
22	2800	655	2047	1075	1,26							62,64	32,40	-	1443	1659
26	2800	775	2366	1243	1,26							73,11	35,59	-	1702	1957
30	2800	895	2680	1408	1,26							83,58	38,78	-	1966	2261
133	300	029	XX	YY	00							10	3000	295	1107	585
						12	3000	355	1296	684	1,25	37,05	18,00	-	825	949
						14	3000	415	1482	783	1,25	43,17	21,75	-	962	1106
						16	3000	475	1665	879	1,25	49,29	25,50	-	1096	1260
						18	3000	535	1845	974	1,25	55,38	29,25	-	1237	1423
						20	3000	595	2019	1066	1,25	61,50	33,00	-	1373	1579
						22	3000	655	2193	1152	1,26	67,11	34,71	-	1511	1738
						26	3000	775	2535	1332	1,26	78,33	38,13	-	1787	2055
						30	3000	895	2871	1508	1,26	89,55	41,55	-	2062	2371

Conform EN442-1: 2014: radiatoren en convectoren

Voor meer details over onze artikel-data, zie artikel-database: <https://www.installdata.be>

Voor de warmteafgifte van andere regimes, kijkt u op p. 346 (correctiefactoren)

BELGIË. Prijzen in euro (excl. BTW)

CARRÉ HORIZONTAAL (CPHN2-RO)

HOE CARRÉ HORIZONTAAL BESTELLEN

Leveringstermijn 15 - 30 werkdagen
(zonder transportduur)



CPHN2-RO

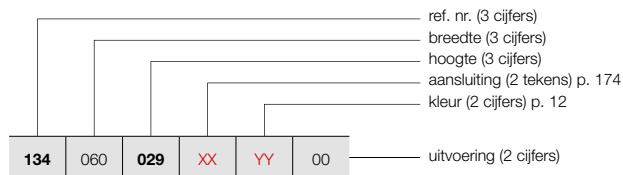

PRIJSGROEP: VPG2 - STAAL DESIGNRADIATOREN

BESTELCODE MAATWERK CARRÉ HORIZONTAAL							TECHNISCHE GEGEVENS				STANDAARDKLEUR	ANDERE KLEUREN					
134	060	029	XX	YY	00	buizen	breedte (L mm)	hoogte (H mm)	75/65/20 (Watt) (Φ50K)	55/45/20 (Watt) (Φ30K)	n-exp.	gewicht (kg)	inhoud (l)	el. weerst. (Watt)	prijs RAL 9016 (€)	prijs kleur (€)	
REF. NR. CARRÉ HORIZONTAAL CPHN2-RO : 134																	
134	060	029	XX	YY	00	10	600	295	377	200	1,24	11,94	6,06	-	445	512	
		035				12	600	355	459	242	1,25	14,26	7,27	-	531	611	
		041				14	600	415	539	282	1,27	16,57	8,48	-	622	715	
		047				16	600	475	617	321	1,28	18,89	9,70	-	710	817	
		053				18	600	535	693	359	1,29	21,20	10,91	-	800	920	
		059				20	600	595	766	394	1,30	23,52	12,12	-	888	1021	
		065				22	600	655	836	430	1,30	25,85	13,39	-	977	1124	
		077				26	600	775	967	498	1,30	30,50	15,94	-	1156	1329	
		089				30	600	895	1087	560	1,30	35,16	18,48	-	1335	1535	
134	080	029	XX	YY	00	10	800	295	503	267	1,24	15,92	8,08	-	541	622	
		035				12	800	355	612	323	1,25	19,01	9,70	-	650	748	
		041				14	800	415	719	376	1,27	22,10	11,31	-	757	871	
		047				16	800	475	823	428	1,28	25,18	12,93	-	865	995	
		053				18	800	535	924	478	1,29	28,27	14,54	-	974	1120	
		059				20	800	595	1021	526	1,30	31,36	16,16	-	1084	1247	
		065				22	800	655	1114	573	1,30	34,46	17,86	-	1190	1369	
		077				26	800	775	1290	664	1,30	40,67	21,25	-	1407	1618	
		089				30	800	895	1449	746	1,30	46,88	24,64	-	1621	1864	
134	100	029	XX	YY	00	10	1000	295	629	334	1,24	19,90	10,10	-	627	721	
		035				12	1000	355	765	404	1,25	23,76	12,12	-	757	871	
		041				14	1000	415	899	470	1,27	27,62	14,14	-	882	1014	
		047				16	1000	475	1029	535	1,28	31,48	16,16	-	1011	1163	
		053				18	1000	535	1155	598	1,29	35,34	18,18	-	1132	1302	
		059				20	1000	595	1276	657	1,30	39,20	20,20	-	1263	1452	
		065				22	1000	655	1393	717	1,30	43,08	22,32	-	1390	1599	
		077				26	1000	775	1612	830	1,30	50,84	26,56	-	1641	1887	
		089				30	1000	895	1811	932	1,30	58,60	30,80	-	1889	2172	
134	120	029	XX	YY	00	10	1200	295	755	401	1,24	23,88	12,12	-	714	821	
		035				12	1200	355	918	485	1,25	28,51	14,54	-	859	988	
		041				14	1200	415	1079	564	1,27	33,14	16,97	-	998	1148	
		047				16	1200	475	1235	642	1,28	37,78	19,39	-	1142	1313	
		053				18	1200	535	1386	717	1,29	42,41	21,82	-	1285	1478	
		059				20	1200	595	1531	788	1,30	47,04	24,24	-	1430	1645	
		065				22	1200	655	1672	861	1,30	51,70	26,78	-	1571	1807	
		077				26	1200	775	1934	996	1,30	61,01	31,87	-	1859	2138	
		089				30	1200	895	2173	1119	1,30	70,32	36,96	-	2143	2464	
134	140	029	XX	YY	00	10	1400	295	881	468	1,24	27,86	14,14	-	794	913	
		035				12	1400	355	1071	566	1,25	33,26	16,97	-	954	1097	
		041				14	1400	415	1259	658	1,27	38,67	19,80	-	1115	1282	
		047				16	1400	475	1441	749	1,28	44,07	22,62	-	1271	1462	
		053				18	1400	535	1617	837	1,29	49,48	25,45	-	1430	1645	
		059				20	1400	595	1786	919	1,30	54,88	28,28	-	1589	1827	
		065				22	1400	655	1950	1004	1,30	60,31	31,25	-	1746	2008	
		077				26	1400	775	2257	1162	1,30	71,18	37,18	-	2066	2376	
		089				30	1400	895	2535	1305	1,30	82,04	43,12	-	2381	2738	

Conform EN442-1: 2014: radiatoren en convectoren

Voor meer details over onze artikel-data, zie artikel-database: <https://www.installdata.be>

Voor de warmteafgiftes van andere regimes, kijkt u op p. 346 (correctiefactoren)
BELGIË. Prijzen in euro (excl. BTW)

HOE CARRÉ HORIZONTAAL BESTELLEN

Leveringstermijn 15 - 30 werkdagen
(zonder transportduur)

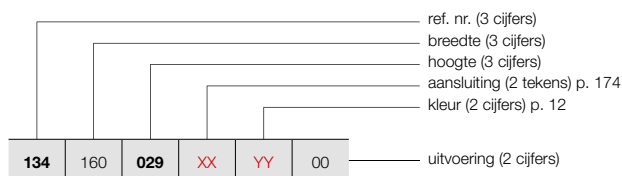

CARRÉ HORIZONTAAL (CPHN2-RO)



CPHN2-RO

PRIJSGROEP: VPG2 - STAAL DESIGNRADIATOREN

BESTELCODE MAATWERK CARRÉ HORIZONTAAL	TECHNISCHE GEGEVENS							STANDAARDKLEUR		ANDERE KLEUREN						
	buizen	breedte (L mm)	hoogte (H mm)	75/65/20 (Watt) (φ50K)	55/45/20 (Watt) (φ30K)	n-exp.	gewicht (kg)	inhoud (l)	el. weerst. (Watt)	prijs RAL 9016 (€)	prijs kleur (€)					
REF. NR. CARRÉ HORIZONTAAL CPHN2-RO : 134																
134	160	029	XX	YY	00	10	1600	295	1006	534	1,24	31,84	16,16	-	870	1001
		035				12	1600	355	1224	646	1,25	38,02	19,39	-	1045	1202
		041				14	1600	415	1438	752	1,27	44,19	22,62	-	1217	1400
		047				16	1600	475	1646	856	1,28	50,37	25,86	-	1393	1602
		053				18	1600	535	1848	956	1,29	56,54	29,09	-	1568	1803
		059				20	1600	595	2042	1051	1,30	62,72	32,32	-	1740	2001
		065				22	1600	655	2229	1147	1,30	68,93	35,71	-	1916	2203
		077				26	1600	775	2579	1328	1,30	81,34	42,50	-	2264	2604
		089				30	1600	895	2898	1492	1,30	93,76	49,28	-	2610	3002
		134				180	029	XX	YY	00	10	1800	295	1132	601	1,24
035	12		1800	355	1377		727				1,25	42,77	21,82	-	1132	1302
041	14		1800	415	1618		846				1,27	49,72	25,45	-	1319	1517
047	16		1800	475	1852		963				1,28	56,66	29,09	-	1510	1737
053	18		1800	535	2079		1076				1,29	63,61	32,72	-	1699	1954
059	20		1800	595	2297		1182				1,30	70,56	36,36	-	1887	2170
065	22		1800	655	2507		1290				1,30	77,54	40,18	-	2075	2386
077	26		1800	775	2902		1494				1,30	91,51	47,81	-	2451	2819
089	30		1800	895	3260		1678				1,30	105,48	55,44	-	2831	3256
134	200		029	XX	YY		00				10	2000	295	1258	668	1,24
		035	12			2000		355	1530	808	1,25	47,52	24,24	-	1215	1397
		041	14			2000		415	1798	940	1,27	55,24	28,28	-	1420	1633
		047	16			2000		475	2058	1070	1,28	62,96	32,32	-	1621	1864
		053	18			2000		535	2310	1195	1,29	70,68	36,36	-	1826	2100
		059	20			2000		595	2552	1314	1,30	78,40	40,40	-	2028	2332
		065	22			2000		655	2786	1434	1,30	86,16	44,64	-	2231	2566
		077	26			2000		775	3224	1660	1,30	101,68	53,12	-	2635	3030
		089	30			2000		895	3622	1864	1,30	117,20	61,60	-	3041	3497
		134	220			029		XX	YY	00	10	2200	295	1384	735	1,24
035	12			2200	355	1683	889				1,25	52,27	26,66	-	1298	1493
041	14			2200	415	1978	1034				1,27	60,76	31,11	-	1514	1741
047	16			2200	475	2264	1177				1,28	69,26	35,55	-	1732	1992
053	18			2200	535	2541	1315				1,29	77,75	40,00	-	1950	2243
059	20			2200	595	2807	1445				1,30	86,24	44,44	-	2166	2491
065	22			2200	655	3065	1578				1,30	94,78	49,10	-	2381	2738
077	26			2200	775	3546	1825				1,30	111,85	58,43	-	2811	3233
089	30			2200	895	3984	2051				1,30	128,92	67,76	-	3250	3738
134	240			029	XX	YY	00				10	2400	295	1510	801	1,24
		035	12	2400				355	1836	970	1,25	57,02	29,09	-	1380	1587
		041	14	2400				415	2158	1128	1,27	66,29	33,94	-	1609	1850
		047	16	2400				475	2470	1284	1,28	75,55	38,78	-	1837	2113
		053	18	2400				535	2772	1434	1,29	84,82	43,63	-	2068	2378
		059	20	2400				595	3062	1576	1,30	94,08	48,48	-	2298	2643
		065	22	2400				655	3343	1721	1,30	103,39	53,57	-	2526	2905
		077	26	2400				775	3869	1992	1,30	122,02	63,74	-	2989	3437

Conform EN442-1: 2014: radiatoren en convectoren

Voor meer details over onze artikel-data, zie artikel-database: <https://www.installdata.be>

Voor de warmteafgiftes van andere regimes, kijkt u op p. 346 (correctiefactoren)
BELGIË. Prijzen in euro (excl. BTW)

CARRÉ HORIZONTAAL (CPHN2-RO)

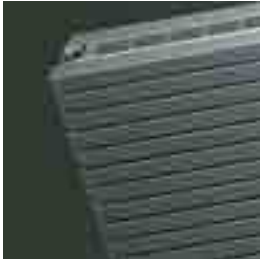

CPHN2-RO

HOE CARRÉ HORIZONTAAL BESTELLEN

Leveringstermijn 15 - 30 werkdagen
(zonder transportduur)

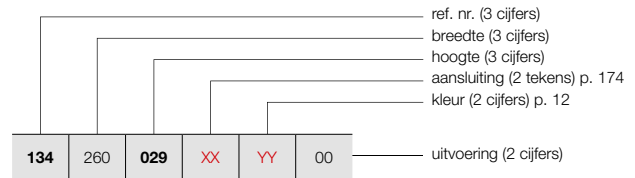

PRIJSGROEP: VPG2 - STAAL DESIGNRADIATOREN

BESTELCODE MAATWERK CARRÉ HORIZONTAAL	TECHNISCHE GEGEVENS									STANDAARDKLEUR	ANDERE KLEUREN
	buizen	breedte (L mm)	hoogte (H mm)	75/65/20 (Watt) (Φ50K)	55/45/20 (Watt) (Φ30K)	n-exp.	gewicht (kg)	inhoud (l)	el. weerst. (Watt)	prijs RAL 9016 (€)	prijs kleur (€)
REF. NR. CARRÉ HORIZONTAAL CPHN2-RO : 134											
134	260	029	XX	YY	00						
		035								1214	1396
		041								1455	1673
		047								1699	1954
		053								1941	2232
		059								2187	2515
		065								2431	2796
		077								2672	3073
										3160	3634
134	280	029	XX	YY	00						
		035								1278	1470
		041								1533	1763
		047								1788	2056
		053								2044	2351
		059								2298	2643
		065								2556	2939
										2810	3232
134	300	029	XX	YY	00						
		035								1341	1542
		041								1607	1848
		047								1875	2156
		053								2143	2464
		059								2411	2773
		065								2676	3077
										2951	3394

Conform EN442-1: 2014: radiatoren en convectoren

Voor meer details over onze artikel-data, zie artikel-database: <https://www.installdata.be>

Voor de warmteafgifte van andere regimes, kijkt u op p. 346 (correctiefactoren)
BELGIË. Prijzen in euro (excl. BTW)



PRIJSGROEP: VPG10 - ACC.

BEVESTIGINGEN	HOOGTE / BREEDTE RADIATOR	KLEUR	ART. NR.	€
CPVN2-ZB / CPHN1-RO / CPHN2-RO				
WANDOPSTELLING	≤ 2400 mm (4 bevestigingen)	RAL 7016	1187 007 0000 7016	39
	≥ 2600 mm (6 bevestigingen)	RAL 7016	1187 008 0000 7016	58

BELGIË. Prijzen in euro (excl. BTW)

CARRÉ ACCESSOIRES
IN OPTIE

PRIJSGROEP: VPG10B - HANDDOEKBEUGELS

ACCESSOIRES	BREEDTE RADIATOR	KLEUR	ART. NR.	€
CPVN-PLUS / CPVN2-ZB / CPHN1-RO / CPHN2-RO				
KNOP VIERKANT 		CHROOM	1183 500 0000 0099	66
	<ul style="list-style-type: none"> h = 24 mm; b = 24 mm; d = 65 mm 			
CPVN-PLUS / CPVN2-ZB / CPHN1-RO / CPHN2-RO				
HANDDOEKBEUGEL RECHT 		CHROOM	1183 207 0000 0099	184
	<ul style="list-style-type: none"> h = 24 mm; b = 720 mm (zelf in te korten); d = 66 mm; a = 48 mm 			
CPVN-PLUS / CPVN2-ZB				
HANDDOEKBEUGEL MULTI+ RECHTS 	600 mm	S600	1183 734 0000 0600	198
	600 mm	RAL 9005 ^S	1183 734 0000 9005	198
<ul style="list-style-type: none"> h = 70 mm; b = 600 mm (b tablet = 194 mm); e = 176 mm; c = 170 mm; Bevestiging aan de muur, rechts van de radiator. 				
CPVN-PLUS / CPVN2-ZB				
HANDDOEKBEUGEL MULTI+ LINKS 	600 mm	S600	1183 735 0000 0600	198
	600 mm	RAL 9005 ^S	1183 735 0000 9005	198
<ul style="list-style-type: none"> h = 70 mm; b = 600 mm (b tablet = 194 mm); e = 176 mm; c = 170 mm; Bevestiging aan de muur, links van de radiator. 				

^S structuur zwart

Montagevoorschriften accessoires: zie www.vasco.eu

BELGIË. Prijzen in euro (excl. BTW)

e = afstand voorkant accessoire tot wand
d = afstand voorkant accessoire tot voorkant radiator
c = afstand wand tot achterkant beugel
a = afstand accessoire tot radiator
uit voorraad leverbaar

CARRÉ AANSLUITINGEN

CARRÉ PLUS VERTICAAL: CPVN-PLUS (VOORRAAD) CARRÉ VERTICAAL: CPVN2-ZB

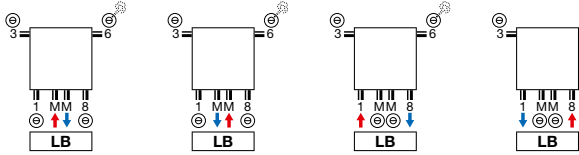

CARRÉ PLUS VERTICAAL: CPVN-PLUS (NIET-VOORRAAD) CARRÉ VERTICAAL: CPVN2-ZB

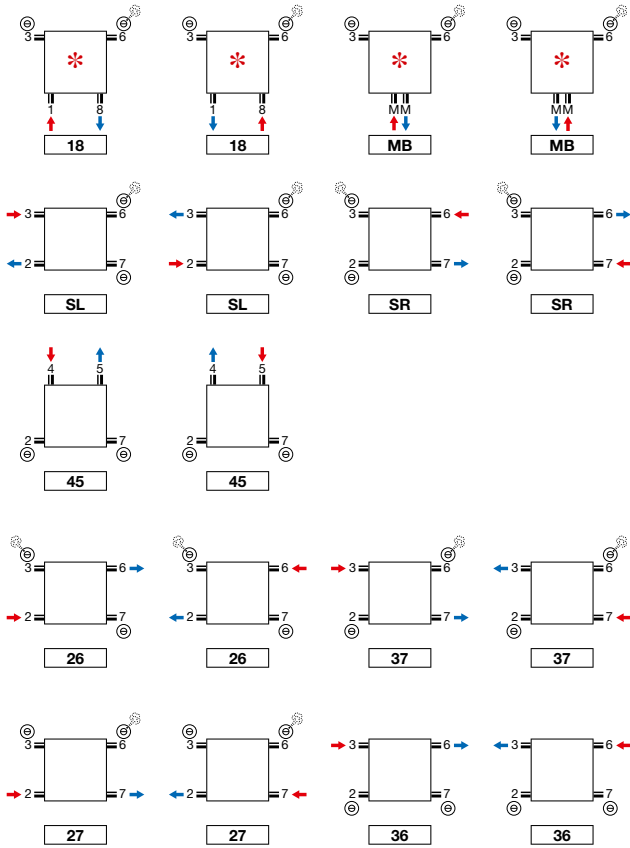

* **Opmerking CPVN-PLUS/CPVN2-ZB 10 buizen:** 2/3/6/7 altijd open.

CARRÉ HORIZONTAAL: CPHN1-RO / CPHN2-RO

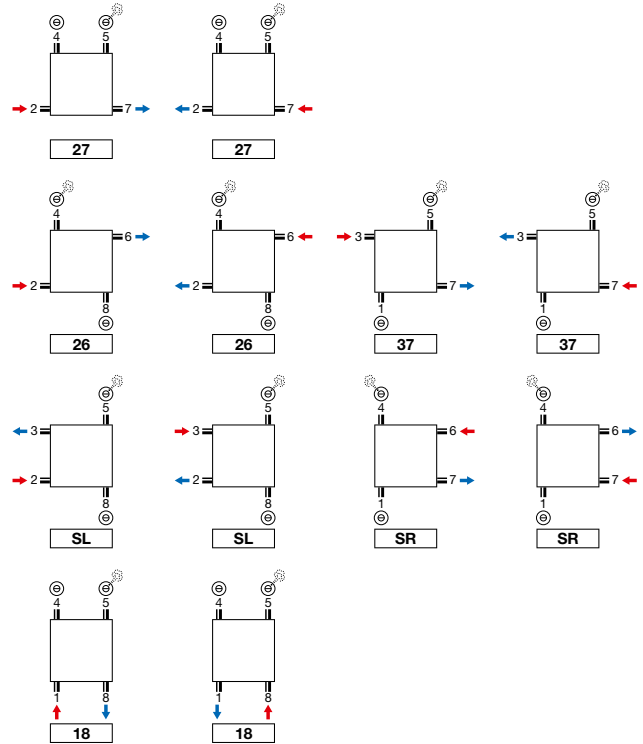

Opmerking: het aansluiten van de radiator kan enkel volgens de getoonde aansluiticonen. Voor elke andere aansluitwijze nemen wij geen verantwoordelijkheid.

CARRÉ PLUS VERTICAAL (CPVN-PLUS)

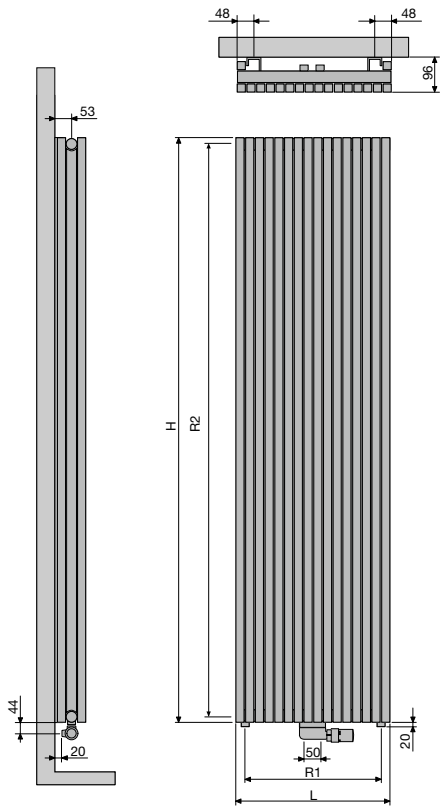

	CPVN-PLUS									
aantal buizen	10	12	14	16	18	20	22	26	30	
Breedte (L)	295	355	415	475	535	595	655	775	895	
Hartafstand tussen de onderaansluitingen 18 (R1)	240	300	360	420	480	540	600	720	840	
hoogte (H)	1400	1600	1800	2000	2200					
Hartafstand tussen de zijansluitingen SL/SR (R2)	1365	1565	1765	1965	2165					
Hartafstand tussen de ophangingen	L-200	H-290								

CARRÉ VERTICAAL (CPVN2-ZB)

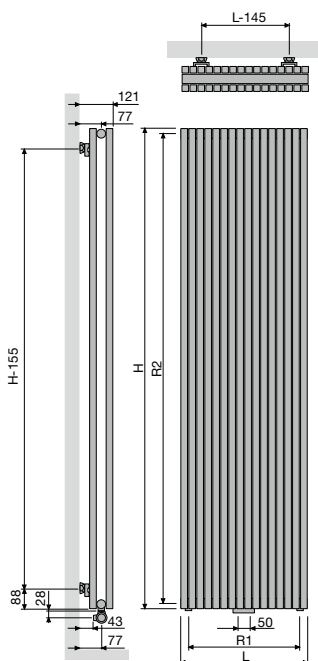

	CPVN2-ZB									
aantal buizen	10	12	14	16	18	20	22	26	30	
Breedte (L)	295	355	415	475	535	595	655	775	895	
Hartafstand tussen de onderaansluitingen 18 (R1)	240	300	360	420	480	540	600	720	840	
hoogte (H)	1400	1600	1800	2000	2200	2400	2600	2800	3000	
Hartafstand tussen de zijansluitingen SL/SR (R2)	1365	1565	1765	1965	2165	2365	2565	2765	2965	
Hartafstand tussen de ophangingen	L-145	H-155								

CARRÉ HORIZONTAAL (CPHN1-RO, CPHN2-RO)

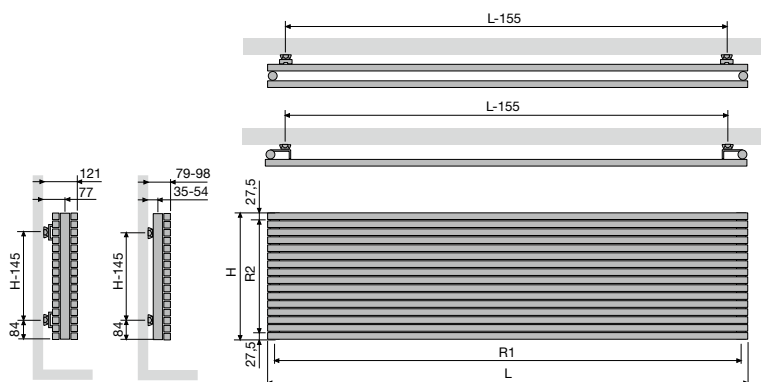

	CPHN1-RO / CPHN2-RO												
Breedte (L)	600	800	1000	1200	1400	1600	1800	2000	2200	2400	2600	2800	3000
Hartafstand tussen de onderaansluitingen 18 (R1)	565	765	965	1165	1365	1565	1765	1965	2165	2365	2565	2765	2965
hoogte (H)	295	355	415	475	535	595	655	775	895				
Hartafstand tussen de zijaansluitingen SL/SR (R2)	240	300	360	420	480	540	600	720	840				
Hartafstand tussen de ophangingen	L-155	H-145											

BUIZEN

- VV: Verticaal, rechthoekig 45 x 20 mm

KLEUREN

- Standaardkleur wit RAL 9016
- Uitgebreide kleurenkaart zie p. 12

SPECIAAL

- De Arche is bekroond met Design Plus Award 2005, Reddot Design Award 2006, Silver Award Designpreis Deutschland 2006 en genomineerd voor de Henry van de Velde prijs 2005.

BEVESTIGINGEN

- Muurbevestigingen standaard (telescopisch)

TECHNISCH

- KTL-grondlaag, poedercoating
- Standaardwerkdruk: 4 bar
- Maximale bedrijfstemperatuur: 110°C

ELEKTRISCH

- ✗ Zuiver elektrische radiator in de fabriek vorgevuld
- ✗ Gemengde radiator

TECHNISCHE TEKENINGEN

- Zie p. 182

AANSLUITING

- ✗ Eénpuntsaansluiting voor éénpijpsysteem
- ✗ Eénpuntsaansluiting voor tweepijpsysteem
- ✓ Tweepuntsaansluiting voor éénpijpsysteem (aansluiting via de middenaansluiting) (zie p. 340)
- ✓ Tweepuntsaansluiting voor tweepijpsysteem (standaard) (zie p. 340)
- ✗ Geïntegreerd ventiel
- Aansluitingen: ½" (binnendraad)

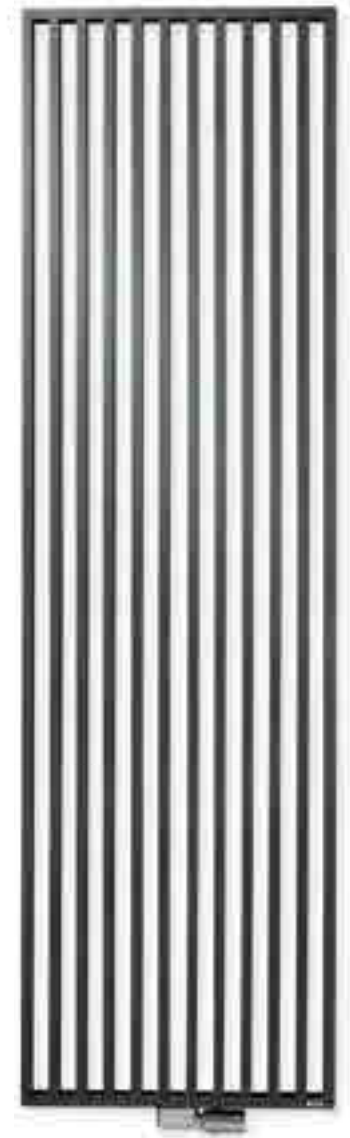

AANBEVOLEN AANSLUITING (LB)

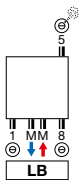

Andere aansluitmogelijkheden, zie p. 181



art. nr. 1182 103 0000 0099

prijs €175

Koppelingen, zie p. 353

**AANBEVOLEN VOOR BADKAMER EN KEUKEN
IN OPTIE**



handdoekbeugel (chrom) art. nr. zie p. 181

prijs €184

Andere accessoires, zie p. 181

ARCHE VERTICAAL

Techniek en esthetiek naadloos verenigd

Een designradiatorconcept, enig in zijn soort. De buizen zijn niet op, maar in elkaar gemonteerd en vormen samen één naadloze, vlakke structuur. Ook de accessoires zijn mooi in het geheel geïntegreerd. Die perfecte verstandhouding tussen techniek en esthetiek leveren een uniek product op dat inmiddels zowat alle belangrijke designprijzen heeft weggekaapt en ook beschikbaar is in een badkameruitvoering met middenaansluiting.



ARCHE VERTICAAL (W)



W

HOE ARCHE VERTICAAL BESTELLEN

Leveringstermijn 15 - 30 werkdagen
(zonder transportduur)

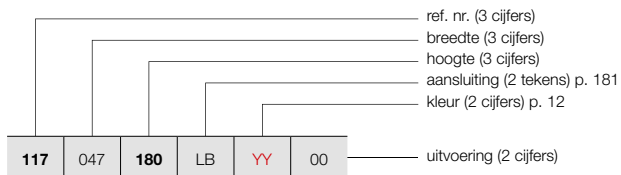

HOE VOORRAADRADIATOR ARCHE VERTICAAL BESTELLEN

Leveringstermijn 5 werkdagen
(zonder transportduur)

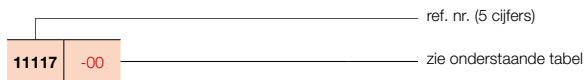

PRIJSGROEP: VPG2 - STAAL DESIGNRADIATOREN

BESTELCODE MAATWERK ARCHE VERTICAAL	TECHNISCHE GEGEVENS									STANDAARDKLEUR		ANDERE KLEUREN prijs kleur (€)
	buizen	breedte (L mm)	hoogte (H mm)	75/65/20 (Watt (Φ50K))	55/45/20 (Watt (Φ30K))	n-exp.	gewicht (kg)	inhoud (l)	el. weerst. (Watt)	prijs RAL 9016 (€)	verkorte ref. nr. RAL 9016 voorraad	
REF. NR. ARCHE VERTICAAL W : 117												
117	047	180	LB	YY	00							
		200										
		220										
117	057	180	LB	YY	00							
		200										
		220										
117	067	180	LB	YY	00							
		200										
		220										

Conform EN442-1: 2014: radiatoren en convectoren

Voor meer details over onze artikel-data, zie artikel-database: <https://www.installdata.be>

Voor de warmteafgifte van andere regimes, kijkt u op p. 346 (correctiefactoren)
BELGIË. Prijzen in euro (excl. BTW)

TYPES

- VVR (beugel rechts), VVL (beugel links)

BUIZEN

- Verticaal, rechthoekig 45 x 20 mm

KLEUREN

- Standaardkleur wit RAL 9016
- Uitgebreide kleurenkaart zie p. 12

SPECIAAL

- Vaste handdoekbeugel in de kleur van de radiator
- Opgelet: deze beugel wordt niet warm!

BEVESTIGINGEN

- Muurbevestigingen standaard (telescopisch)

TECHNISCH

- KTL-grondlaag, poedercoating
- Standaardwerkdruk: 4 bar
- Maximale bedrijfstemperatuur: 110°C

ELEKTRISCH

- ✗ Zuiver elektrische radiator in de fabriek voorgevuld
- ✗ Gemengde radiator

TECHNISCHE TEKENINGEN

- Zie p. 182

AANSLUITING

- ✗ Eénpuntsaansluiting voor éénpijpsysteem
- ✗ Eénpuntsaansluiting voor tweepijpsysteem
- ✓ Tweepuntsaansluiting voor éénpijpsysteem (aansluiting via de middenaansluiting) (zie p. 340)
- ✓ Tweepuntsaansluiting voor tweepijpsysteem (standaard) (zie p. 340)
- ✗ Geïntegreerd ventiel
- Aansluitingen: 1/2" (binnendraad)



AANBEVOLEN AANSLUITING (LB)

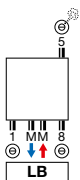

Andere aansluitmogelijkheden, zie p. 181



art. nr. 1182 103 0000 0099

prijs €175

Koppelingen, zie p. 353

ARCHE PLUS VERTICAAL

Functioneel mooi over de hele lijn

Een designradiator waarbij de unieke, vlakke vormgeving van de Arche wordt aangevuld met een naadloos op de structuur gelaste handdoekbeugel. Samen vormen ze een mooi afgewerkt geheel dat de perfecte verstandhouding tussen de Arche vormgeving en functionaliteit extra benadrukt.



ARCHE PLUS VERTICAAL (VWL, VVR)



VWL

VVR

HOE ARCHE PLUS VERTICAAL BESTELLEN

Leveringstermijn 15 - 30 werkdagen
(zonder transportduur)

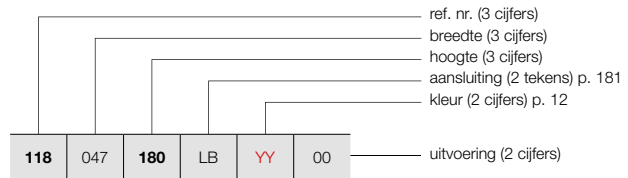

HOE VOORRAADRADIATOR ARCHE PLUS VERTICAAL BESTELLEN

Leveringstermijn 5 werkdagen
(zonder transportduur)

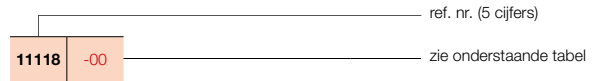



PRIJSGROEP: VPG2 - STAAL DESIGNRADIATOREN

BESTELCODE MAATWERK ARCHE PLUS VERTICAAL	TECHNISCHE GEGEVENS										STANDAARDKLEUR		ANDERE KLEUREN prijs kleur (€)
	buizen	breedte (L mm)	hoogte (H mm)	75/65/20 (Watt (Φ50K))	55/45/20 (Watt (Φ30K))	n-exp.	gewicht (kg)	inhoud (l)	el. weerst. (Watt)	prijs RAL 9016 (€)	verkorte ref. nr. RAL 9016 voorraad		
REF. NR. ARCHE PLUS VERTICAAL VWL : 118													
118 047 180 200 220 LB YY 00	10	470	1800	1050	560	1,23	23,49	13,94	-	710	11118-01	817	
	10	470	2000	1164	618	1,24	25,95	15,42	-	759	-	873	
	10	470	2200	1279	679	1,24	28,40	16,91	-	799	-	919	
118 057 180 200 220 LB YY 00	12	570	1800	1273	679	1,23	28,44	16,90	-	860	-	989	
	12	570	2000	1412	749	1,24	31,42	18,70	-	920	-	1058	
	12	570	2200	1552	824	1,24	34,40	20,50	-	970	-	1116	
118 067 180 200 220 LB YY 00	14	670	1800	1496	798	1,23	33,39	19,87	-	1012	-	1164	
	14	670	2000	1660	881	1,24	36,89	21,98	-	1083	-	1245	
	14	670	2200	1824	968	1,24	40,39	24,10	-	1138	-	1309	
REF. NR. ARCHE PLUS VERTICAAL VVR : 119													
119 047 180 200 220 LB YY 00	10	470	1800	1050	560	1,23	23,49	13,94	-	710	11119-01	817	
	10	470	2000	1164	618	1,24	25,95	15,42	-	759	-	873	
	10	470	2200	1279	679	1,24	28,40	16,91	-	799	-	919	
119 057 180 200 220 LB YY 00	12	570	1800	1273	679	1,23	28,44	16,90	-	860	-	989	
	12	570	2000	1412	749	1,24	31,42	18,70	-	920	-	1058	
	12	570	2200	1552	824	1,24	34,40	20,50	-	970	-	1116	
119 067 180 200 220 LB YY 00	14	670	1800	1496	798	1,23	33,39	19,87	-	1012	-	1164	
	14	670	2000	1660	881	1,24	36,89	21,98	-	1083	-	1245	
	14	670	2200	1824	968	1,24	40,39	24,10	-	1138	-	1309	

Conform EN442-1: 2014: radiatoren en convectoren

Voor meer details over onze artikel-data, zie artikel-database: <https://www.installdata.be>
Voor de warmteafgiftes van andere regimes, kijkt u op p. 346 (correctiefactoren)
BELGIË. Prijzen in euro (excl. BTW)

PRIJSGROEP: VPG10B - HANDDOEKBEUGELS

ACCESSOIRES		KLEUR	ART. NR.	€
KNOP		VV / VWL / VWR		
		CHROOM	11834100000099	87
HANDDOEKBEUGEL		W		
		CHROOM	11832280000099	184

- h = 70 mm; b = 70 mm; d = 59 mm; a = 51 mm;

- h = 22 mm; b = 720 mm (zelf in te korten) d = 75 mm; a = 56 mm

Montagevoorschriften accessoires: zie www.vasco.eu
BELGIË. Prijzen in euro (excl. BTW)

d = afstand voorkant accessoire tot voorkant radiator
a = afstand accessoire tot radiator
uit voorraad leverbaar

ARCHE AANSLUITINGEN

ARCHE VERTICAAL: W
ARCHE PLUS VERTICAAL: VWL / VWR

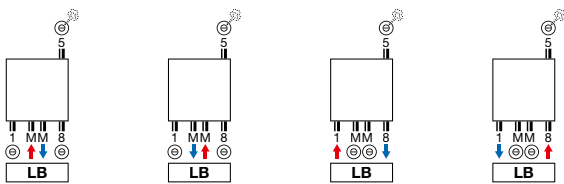

Opmerking: het aansluiten van de radiator kan enkel volgens de getoonde aansluiticonen. Voor elke andere aansluitwijze nemen wij geen verantwoordelijkheid.

ARCHE VERTICAAL (VV)

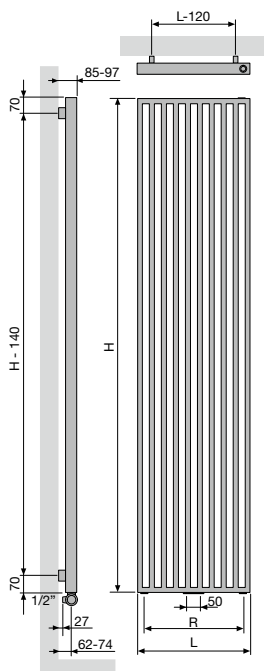

	VV		
aantal buizen	10	12	14
Breedte (L)	470	570	670
Hartafstand tussen de onderaansluitingen 18 (R)	370	470	570
Hartafstand tussen de ophangingen	L-120	H-140	

ARCHE PLUS VERTICAAL (VWL, VWR)

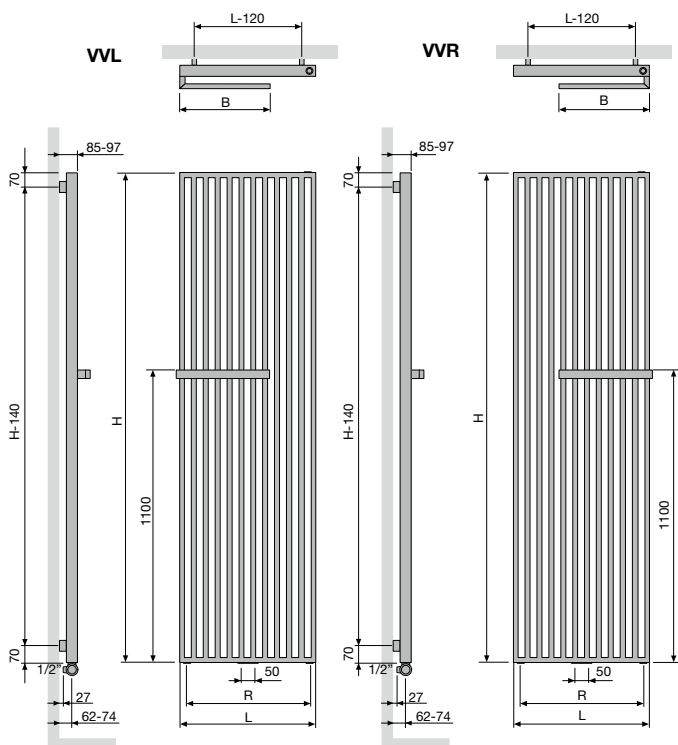

	VWL / VWR		
aantal buizen	10	12	14
Breedte (L)	470	570	670
Hartafstand tussen de onderaansluitingen 18 (R)	370	470	570
Breedte handdoekbeugel (B)	335	385	435
Hartafstand tussen de ophangingen	L-120	H-140	

TYPES

- Eén (ZV-1) of twee rijen buizen (ZV-2)

BUIZEN

- Verticaal, rechthoekig 45 x 20 mm

COLLECTOREN

- Horizontaal, achterliggend, rond Ø 35 mm

KLEUREN

- Standaardkleur wit RAL 9016
- Uitgebreide kleurenkaart zie p. 12

BEVESTIGINGEN

- Muurbevestigingen standaard

TECHNISCH

- Elektrisch lasergelast (onzichtbare lasnaden)
- KTL-grondlaag, poedercoating
- Standaardwerkdruk: 4 bar
- Maximale bedrijfstemperatuur: 110°C

ELEKTRISCH

- ✗ Zuiver elektrische radiator in de fabriek voorgevuld
- ✗ Gemengde radiator

TECHNISCHE TEKENINGEN

- Zie p. 195

AANSLUITING

- ✗ Eénpuntsaansluiting voor éénpijpsysteem
- ✗ Eénpuntsaansluiting voor tweepijpsysteem
- ✓ Tweepuntsaansluiting voor éénpijpsysteem (aansluiting via de middenaansluiting) (zie p. 340)
- ✓ Tweepuntsaansluiting voor tweepijpsysteem (standaard) (zie p. 340)
- ✗ Geïntegreerd ventiel
- Aansluitingen: 1/2" (binnendraad)



AANBEVOLEN AANSLUITING (LB)

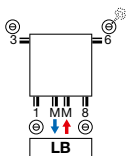

Andere aansluitmogelijkheden, zie p. 194



art. nr. 1182 103 0000 0099
prijs €175
 Koppelingen, zie p. 353

**AANBEVOLEN VOOR BADKAMER EN KEUKEN
 IN OPTIE**



handdoekbeugel recht (chrom) art. nr. zie p. 193
prijs €184

Andere accessoires, zie p. 193

ZANA VERTICAAL

Traditie en trends in perfecte harmonie

De Zana combineert een onklopbaar vermogen met een tijdloze lijnvoering. Een klassieker die blijft bekoren door zijn kracht, zijn klasse en zijn comfort. Het retrogevoel is nooit ver weg. Maar ook de moderniteit is volop aanwezig in dit unieke gamma designradiatoren voor elke woonomgeving, elke ruimte, elke toepassing.



ZANA VERTICAAL (ZV-1)



ZV-1

HOE ZANA VERTICAAL BESTELLEN
Leveringstermijn 15 - 30 werkdagen
(zonder transportduur)

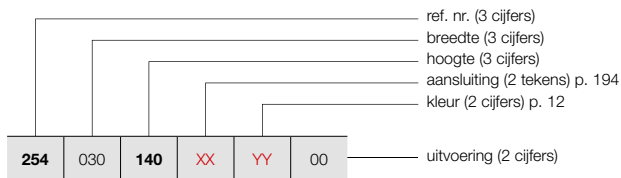

HOE VOORRAADRADIATOR ZANA VERTICAAL BESTELLEN
Leveringstermijn 5 werkdagen
(zonder transportduur)

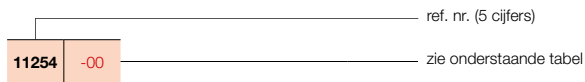

PRIJSGROEP: VPG2 - STAAL DESIGNRADIATOREN

BESTELCODE MAATWERK ZANA VERTICAAL	TECHNISCHE GEGEVENS									STANDAARDKLEUR		ANDERE KLEUREN prijs kleur (€)					
	buizen	breedte (L mm)	hoogte (H mm)	75/65/20 (Watt) (Φ50K)	55/45/20 (Watt) (Φ30K)	n-exp.	gewicht (kg)	inhoud (l)	el. weerst. (Watt)	prijs RAL 9016 (€)	verkorte ref. nr. RAL 9016 voorraad						
REF. NR. ZANA VERTICAAL ZV-1 : 254																	
254	030	140	XX	YY	00	8	304	1400	680	359	1,27	18,16	8,24	-	446	-	513
		160				8	304	1600	769	406	1,27	20,72	9,44	-	483	-	555
		180				8	304	1800	859	454	1,28	23,20	10,64	-	523	-	601
		200				8	304	2000	950	502	1,28	25,68	11,68	-	562	-	646
		220				8	304	2200	1042	550	1,28	28,08	12,72	-	602	-	692
		240				8	304	2400	1136	600	1,29	30,56	13,76	-	642	-	738
		260				8	304	2600	1231	650	1,29	33,04	14,80	-	683	-	785
		280				8	304	2800	1327	701	1,29	35,44	15,84	-	718	-	826
		300				8	304	3000	1426	753	1,29	37,92	16,88	-	757	-	871
254	038	140	XX	YY	00	10	384	1400	850	449	1,27	22,70	10,30	-	535	-	615
		160				10	384	1600	962	508	1,27	25,90	11,80	-	586	-	674
		180				10	384	1800	1074	567	1,28	29,00	13,30	-	634	11254-03	729
		200				10	384	2000	1188	627	1,28	32,10	14,60	-	684	-	787
		220				10	384	2200	1303	688	1,28	35,10	15,90	-	731	-	841
		240				10	384	2400	1420	750	1,29	38,20	17,20	-	778	-	895
		260				10	384	2600	1539	813	1,29	41,30	18,50	-	827	-	951
		280				10	384	2800	1659	876	1,29	44,30	19,80	-	877	-	1009
		300				10	384	3000	1782	941	1,29	47,40	21,10	-	922	-	1060
254	046	140	XX	YY	00	12	464	1400	1020	539	1,27	27,24	12,36	-	624	-	718
		160				12	464	1600	1154	609	1,27	31,08	14,16	-	685	-	788
		180				12	464	1800	1289	681	1,28	34,80	15,96	-	743	11254-12	854
		200				12	464	2000	1425	752	1,28	38,52	17,52	-	800	11254-01	920
		220				12	464	2200	1563	825	1,28	42,12	19,08	-	859	-	988
		240				12	464	2400	1704	900	1,29	45,84	20,64	-	917	-	1055
		260				12	464	2600	1846	975	1,29	49,56	22,20	-	975	-	1121
		280				12	464	2800	1991	1051	1,29	53,16	23,76	-	1034	-	1189
		300				12	464	3000	2139	1130	1,29	56,88	25,32	-	1092	-	1256
254	054	140	XX	YY	00	14	544	1400	1190	628	1,27	31,78	14,42	-	716	-	823
		160				14	544	1600	1346	711	1,27	36,26	16,52	-	784	-	902
		180				14	544	1800	1504	794	1,28	40,60	18,62	-	848	11254-07	975
		200				14	544	2000	1663	878	1,28	44,94	20,44	-	918	11254-08	1056
		220				14	544	2200	1824	963	1,28	49,14	22,26	-	987	-	1135
		240				14	544	2400	1988	1050	1,29	53,48	24,08	-	1054	-	1212
		260				14	544	2600	2154	1137	1,29	57,82	25,90	-	1123	-	1291
		280				14	544	2800	2323	1227	1,29	62,02	27,72	-	1193	-	1372
		300				14	544	3000	2495	1318	1,29	66,36	29,54	-	1260	-	1449
254	062	140	XX	YY	00	16	624	1400	1360	718	1,27	36,32	16,48	-	804	-	925
		160				16	624	1600	1539	813	1,27	41,44	18,88	-	882	-	1014
		180				16	624	1800	1719	908	1,28	46,40	21,28	-	960	11254-09	1104
		200				16	624	2000	1900	1003	1,28	51,36	23,36	-	1038	11254-02	1194
		220				16	624	2200	2085	1101	1,28	56,16	25,44	-	1118	-	1286
		240				16	624	2400	2272	1200	1,29	61,12	27,52	-	1194	-	1373
		260				16	624	2600	2462	1300	1,29	66,08	29,60	-	1273	-	1464
		280				16	624	2800	2655	1402	1,29	70,88	31,68	-	1350	-	1553
		300				16	624	3000	2852	1506	1,29	75,84	33,76	-	1428	-	1642

Conform EN442-1: 2014: radiatoren en convectoren

Voor meer details over onze artikel-data, zie artikel-database: <https://www.installdata.be>
Voor de warmteafgifte van andere regimes, kijkt u op p. 346 (correctiefactoren)
BELGIË. Prijzen in euro (excl. BTW)

HOE ZANA VERTICAAL BESTELLEN
Leveringstermijn 15 - 30 werkdagen
(zonder transportduur)

ZANA VERTICAAL (ZV-1)

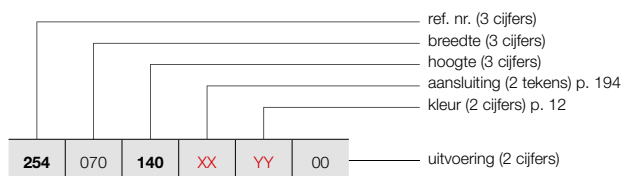

ZV-1

PRIJSGROEP: VPG2 - STAAL DESIGNRADIATOREN

BESTELCODE MAATWERK ZANA VERTICAAL						TECHNISCHE GEGEVENS							STANDAARDKLEUR	ANDERE KLEUREN		
						buizen	breedte (L mm)	hoogte (H mm)	75/65/20 (Watt) (φ50K)	55/45/20 (Watt) (φ30K)	n-exp.	gewicht (kg)	inhoud (l)	el. weerst. (Watt)	prijs RAL 9016 (€)	prijs kleur (€)
REF. NR. ZANA VERTICAAL ZV-1 : 254																
254	070	140	XX	YY	00	18	704	1400	1531	808	1,27	40,86	18,54	-	893	1027
		160				18	704	1600	1731	914	1,27	46,62	21,24	-	980	1127
		180				18	704	1800	1933	1021	1,28	52,20	23,94	-	1067	1227
		200				18	704	2000	2138	1129	1,28	57,78	26,28	-	1159	1333
		220				18	704	2200	2345	1238	1,28	63,18	28,62	-	1245	1432
		240				18	704	2400	2555	1349	1,29	68,76	30,96	-	1333	1533
		260				18	704	2600	2769	1462	1,29	74,34	33,30	-	1417	1630
		280				18	704	2800	2987	1577	1,29	79,74	35,64	-	1508	1734
		300				18	704	3000	3208	1694	1,29	85,32	37,98	-	1595	1834
		254				078	140	XX	YY	00	20	784	1400	1701	898	1,27
160	20		784	1600	1923		1015				1,27	51,80	23,60	-	1082	1244
180	20		784	1800	2148		1134				1,28	58,00	26,60	-	1178	1355
200	20		784	2000	2375		1254				1,28	64,20	29,20	-	1275	1466
220	20		784	2200	2606		1376				1,28	70,20	31,80	-	1372	1578
240	20		784	2400	2839		1499				1,29	76,40	34,40	-	1471	1692
260	20		784	2600	3077		1625				1,29	82,60	37,00	-	1569	1804
280	20		784	2800	3319		1753				1,29	88,60	39,60	-	1666	1916
300	20		784	3000	3564		1882				1,29	94,80	42,20	-	1761	2025
254	086		140	XX	YY		00				22	864	1400	1871	988	1,27
		160	22			864		1600	2116	1117	1,27	56,98	25,96	-	1179	1356
		180	22			864		1800	2363	1248	1,28	63,80	29,26	-	1285	1478
		200	22			864		2000	2613	1380	1,28	70,62	32,12	-	1393	1602
		220	22			864		2200	2866	1513	1,28	77,22	34,98	-	1500	1725
		240	22			864		2400	3123	1649	1,29	84,04	37,84	-	1608	1849
		260	22			864		2600	3385	1788	1,29	90,86	40,70	-	1716	1973
		280	22			864		2800	3650	1927	1,29	97,46	43,56	-	1824	2098
		300	22			864		3000	3921	2071	1,29	104,28	46,42	-	1929	2218
		254	094			140		XX	YY	00	24	944	1400	2041	1078	1,27
160	24			944	1600	2308	1219				1,27	62,16	28,32	-	1279	1471
180	24			944	1800	2578	1361				1,28	69,60	31,92	-	1395	1604
200	24			944	2000	2850	1505				1,28	77,04	35,04	-	1512	1739
220	24			944	2200	3127	1651				1,28	84,24	38,16	-	1630	1875
240	24			944	2400	3407	1799				1,29	91,68	41,28	-	1746	2008
260	24			944	2600	3692	1950				1,29	99,12	44,40	-	1866	2146
280	24			944	2800	3982	2103				1,29	106,32	47,52	-	1980	2277
300	24			944	3000	4277	2259				1,29	113,76	50,64	-	2098	2413
254	102			140	XX	YY	00				26	1024	1400	2211	1168	1,27
		160	26	1024				1600	2500	1320	1,27	67,34	30,68	-	1378	1585
		180	26	1024				1800	2793	1475	1,28	75,40	34,58	-	1504	1730
		200	26	1024				2000	3088	1631	1,28	83,46	37,96	-	1634	1879
		220	26	1024				2200	3388	1789	1,28	91,26	41,34	-	1757	2021
		240	26	1024				2400	3691	1949	1,29	99,32	44,72	-	1885	2168
		260	26	1024				2600	4000	2112	1,29	107,38	48,10	-	2011	2313
		280	26	1024				2800	4314	2278	1,29	115,18	51,48	-	2138	2459
		300	26	1024				3000	4634	2447	1,29	123,24	54,86	-	2264	2604

Conform EN442-1: 2014: radiatoren en convectoren

Voor meer details over onze artikel-data, zie artikel-database: <https://www.installdata.be>

Voor de warmteafgiftes van andere regimes, kijkt u op p. 346 (correctiefactoren)
BELGIË. Prijzen in euro (excl. BTW)

ZANA VERTICAAL (ZV-2)



ZV-2

HOE ZANA VERTICAAL BESTELLEN

Leveringstermijn 15 - 30 werkdagen
(zonder transportduur)

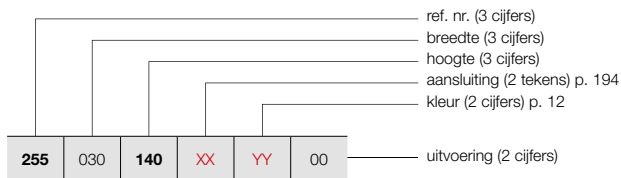

HOE VOORRAADRADIATOR ZANA VERTICAAL BESTELLEN

Leveringstermijn 5 werkdagen
(zonder transportduur)

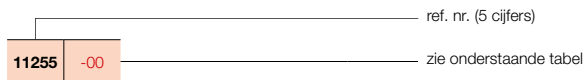

PRIJSGROEP: VPG2 - STAAL DESIGNRADIATOREN

BESTELCODE MAATWERK ZANA VERTICAAL	TECHNISCHE GEGEVENS									STANDAARDKLEUR		ANDERE KLEUREN
	buizen	breedte (L mm)	hoogte (H mm)	75/65/20 (Watt) (Φ50K)	55/45/20 (Watt) (Φ30K)	n-exp.	gewicht (kg)	inhoud (l)	el. weerst. (Watt)	prijs RAL 9016 (€)	verkorte ref. nr. RAL 9016 voorraad	
REF. NR. ZANA VERTICAAL ZV-2 : 255												
255 030 140 XX YY 00	8	304	1400	1105	584	1,30	35,20	16,16	-	758	-	872
	8	304	1600	1242	656	1,30	40,16	18,40	-	824	-	948
	8	304	1800	1379	728	1,30	45,12	20,64	-	890	-	1024
	8	304	2000	1515	800	1,30	50,00	23,28	-	958	-	1102
	8	304	2200	1651	872	1,30	54,80	25,92	-	1020	-	1173
	8	304	2400	1788	944	1,30	59,68	28,56	-	1088	-	1251
	8	304	2600	1925	1017	1,30	64,48	31,12	-	1159	-	1333
	8	304	2800	2062	1089	1,30	69,36	33,76	-	1218	-	1401
	8	304	3000	2200	1162	1,30	74,16	36,40	-	1285	-	1478
255 038 140 XX YY 00	10	384	1400	1381	729	1,30	44,00	20,20	-	912	-	1049
	10	384	1600	1553	820	1,30	50,20	23,00	-	994	-	1143
	10	384	1800	1724	910	1,30	56,40	25,80	-	1076	-	1237
	10	384	2000	1894	1000	1,30	62,50	29,10	-	1160	-	1334
	10	384	2200	2064	1090	1,30	68,50	32,40	-	1242	-	1428
	10	384	2400	2235	1180	1,30	74,60	35,70	-	1322	-	1520
	10	384	2600	2406	1271	1,30	80,60	38,90	-	1408	-	1619
	10	384	2800	2577	1361	1,30	86,70	42,20	-	1489	-	1712
	10	384	3000	2750	1452	1,30	92,70	45,50	-	1571	-	1807
255 046 140 XX YY 00	12	464	1400	1657	875	1,30	52,80	24,24	-	1062	-	1221
	12	464	1600	1863	984	1,30	60,24	27,60	-	1162	-	1336
	12	464	1800	2068	1092	1,30	67,68	30,96	-	1263	-	1452
	12	464	2000	2273	1200	1,30	75,00	34,92	-	1359	-	1563
	12	464	2200	2477	1308	1,30	82,20	38,88	-	1458	-	1677
	12	464	2400	2682	1416	1,30	89,52	42,84	-	1560	-	1794
	12	464	2600	2887	1525	1,30	96,72	46,68	-	1657	-	1906
	12	464	2800	3093	1633	1,30	104,04	50,64	-	1757	-	2021
	12	464	3000	3300	1743	1,30	111,24	54,60	-	1857	-	2136
255 054 140 XX YY 00	14	544	1400	1933	1021	1,30	61,60	28,28	-	1215	-	1397
	14	544	1600	2174	1148	1,30	70,28	32,20	-	1333	-	1533
	14	544	1800	2413	1274	1,30	78,96	36,12	-	1445	-	1662
	14	544	2000	2651	1400	1,30	87,50	40,74	-	1562	11255-02	1796
	14	544	2200	2890	1526	1,30	95,90	45,36	-	1677	-	1929
	14	544	2400	3129	1652	1,30	104,44	49,98	-	1793	-	2062
	14	544	2600	3368	1779	1,30	112,84	54,46	-	1909	-	2195
	14	544	2800	3608	1905	1,30	121,38	59,08	-	2027	-	2331
	14	544	3000	3849	2033	1,30	129,78	63,70	-	2142	-	2463
255 062 140 XX YY 00	16	624	1400	2209	1167	1,30	70,40	32,32	-	1365	-	1570
	16	624	1600	2484	1312	1,30	80,32	36,80	-	1499	-	1724
	16	624	1800	2758	1456	1,30	90,24	41,28	-	1630	-	1875
	16	624	2000	3030	1600	1,30	100,00	46,56	-	1766	-	2031
	16	624	2200	3303	1744	1,30	109,60	51,84	-	1898	-	2183
	16	624	2400	3576	1888	1,30	119,36	57,12	-	2028	-	2332
	16	624	2600	3849	2033	1,30	128,96	62,24	-	2163	-	2487
	16	624	2800	4124	2178	1,30	138,72	67,52	-	2294	-	2638
	16	624	3000	4399	2323	1,30	148,32	72,80	-	2428	-	2792

Conform EN442-1: 2014: radiatoren en convectoren

Voor meer details over onze artikel-data, zie artikel-database: <https://www.installdata.be>

Voor de warmteafgifte van andere regimes, kijkt u op p. 346 (correctiefactoren)
BELGIË. Prijzen in euro (excl. BTW)

HOE ZANA VERTICAAL BESTELLEN
Leveringstermijn 15 - 30 werkdagen
(zonder transportduur)

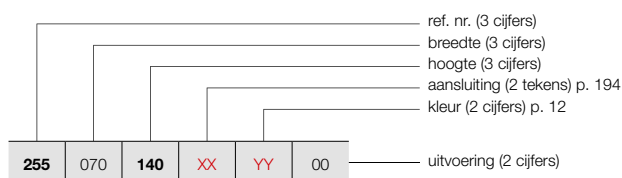

ZANA VERTICAAL (ZV-2)



ZV-2

HOE VOORRAADRADIATOR ZANA VERTICAAL BESTELLEN

Leveringstermijn 5 werkdagen
(zonder transportduur)

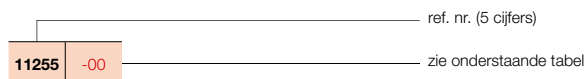

PRIJSGROEP: VPG2 - STAAL DESIGNRADIATOREN

BESTELCODE MAATWERK ZANA VERTICAAL	TECHNISCHE GEGEVENS							STANDAARDKLEUR		ANDERE KLEUREN		
	buizen	breedte (L mm)	hoogte (H mm)	75/65/20 (Watt) (φ50K)	55/45/20 (Watt) (φ30K)	n-exp.	gewicht (kg)	inhoud (l)	el. weerst. (Watt)		prijs RAL 9016 (€)	verkorte ref. nr. RAL 9016 voorraad
REF. NR. ZANA VERTICAAL ZV-2 : 255												
255 070 140 XX YY 00	18	704	1400	2486	1313	1,30	79,20	36,36	-	1521	-	1749
	18	704	1600	2795	1476	1,30	90,36	41,40	-	1668	-	1918
	18	704	1800	3102	1638	1,30	101,52	46,44	-	1817	-	2090
	18	704	2000	3409	1800	1,30	112,50	52,38	-	1966	11255-01	2261
	18	704	2200	3716	1962	1,30	123,30	58,32	-	2115	-	2432
	18	704	2400	4023	2124	1,30	134,28	64,26	-	2263	-	2602
	18	704	2600	4330	2287	1,30	145,08	70,02	-	2412	-	2774
	18	704	2800	4639	2450	1,30	156,06	75,96	-	2562	-	2946
255 078 140 XX YY 00	20	784	1400	2762	1459	1,30	88,00	40,40	-	1673	-	1924
	20	784	1600	3105	1640	1,30	100,40	46,00	-	1836	-	2111
	20	784	1800	3447	1820	1,30	112,80	51,60	-	2002	-	2302
	20	784	2000	3788	2000	1,30	125,00	58,20	-	2168	-	2493
	20	784	2200	4129	2180	1,30	137,00	64,80	-	2332	-	2682
	20	784	2400	4470	2360	1,30	149,20	71,40	-	2500	-	2875
	20	784	2600	4812	2541	1,30	161,20	77,80	-	2665	-	3065
255 086 140 XX YY 00	22	864	1400	3038	1604	1,30	96,80	44,44	-	1825	-	2099
	22	864	1600	3416	1804	1,30	110,44	50,60	-	2004	-	2305
	22	864	1800	3792	2002	1,30	124,08	56,76	-	2188	-	2516
	22	864	2000	4167	2200	1,30	137,50	64,02	-	2368	-	2723
	22	864	2200	4541	2398	1,30	150,70	71,28	-	2553	-	2936
255 094 140 XX YY 00	24	944	1400	3314	1750	1,30	105,60	48,48	-	1975	-	2271
	24	944	1600	3726	1968	1,30	120,48	55,20	-	2176	-	2502
	24	944	1800	4136	2184	1,30	135,36	61,92	-	2373	-	2729
	24	944	2000	4545	2400	1,30	150,00	69,84	-	2574	-	2960
255 102 140 XX YY 00	26	1024	1400	3590	1896	1,30	114,40	52,52	-	2131	-	2451
	26	1024	1600	4037	2132	1,30	130,52	59,80	-	2344	-	2696
	26	1024	1800	4481	2366	1,30	146,64	67,08	-	2559	-	2943

Conform EN442-1: 2014: radiatoren en convectoren

Voor meer details over onze artikel-data, zie artikel-database: <https://www.installdata.be>

Voor de warmteafgiftes van andere regimes, kijkt u op p. 346 (correctiefactoren)

BELGIË. Prijzen in euro (excl. BTW)

ZANA HORIZONTAAL (ZH-1, ZH-2)



TYPES

- Eén (ZH-1) of twee rijen buizen (ZH-2)

BUIZEN

- Verticaal, rechthoekig 45 x 20 mm
- Opgelet: horizontale vormgeving, maar steeds met verticale buizen!

COLLECTOREN

- Horizontaal, achterliggend, rond Ø 35 mm

KLEUREN

- Standaardkleur wit RAL 9016
- Uitgebreide kleurenkaart zie p. 12

SPECIAAL

- ZH-1 ook verkrijgbaar als toiletradiator (384 x 500 mm)

BEVESTIGINGEN

- Muurbevestigingen standaard

TECHNISCH

- Elektrisch lasergelast (onzichtbare lasnaden)
- KTL-grondlaag, poedercoating
- Standaardwerkdruk: 4 bar
- Maximale bedrijfstemperatuur: 110°C

ELEKTRISCH

- ✗ Zuiver elektrische radiator in de fabriek voorgevuld
- ✗ Gemengde radiator

TECHNISCHE TEKENINGEN

- Zie p. 195

AANSLUITING

- ✗ Eénpuntsaansluiting voor éénpijpsysteem
- ✗ Eénpuntsaansluiting voor tweepijpsysteem
- ✗ Tweepuntsaansluiting voor éénpijpsysteem
- ✓ Tweepuntsaansluiting voor tweepijpsysteem (standaard) (zie p. 340)
- ✗ Geïntegreerd ventiel
- Aansluitingen: ½" (binnendraad)

ZANA HORIZONTAAL

Mooi tot in lengte van dagen

Ook in de horizontale uitvoering is de Zana designradiator een toonbeeld van klasse, kracht en comfort. De verticale buizen en de horizontale collectoren vormen samen een mooi gestructureerd geometrisch geheel en dragen bij tot de specifieke Zana retro-look. De Zana Horizontaal is verkrijgbaar met 1 of 2 rijen buizen en in een aparte toiletversie.

AANBEVOLEN AANSLUITING (18)

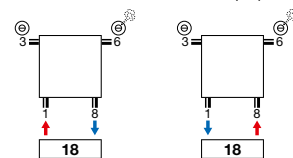

Andere aansluitmogelijkheden, zie p. 194



art. nr. 1182 101 0000 0099

prijs €215

Koppelingen, zie p. 353

AANBEVOLEN VOOR BADKAMER EN KEUKEN IN OPTIE



handdoekbeugel recht (chrom) art. nr. zie p. 193

prijs €184

Andere accessoires, zie p. 193

HOE ZANA HORIZONTAAL BESTELLEN

Leveringstermijn 15 - 30 werkdagen
(zonder transportduur)

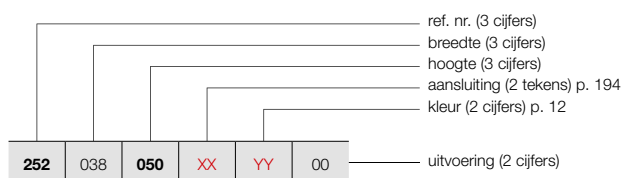

ZANA HORIZONTAAL (ZH-1)



ZH-1

PRIJSGROEP: VPG2 - STAAL DESIGNRADIATOREN

BESTELCODE MAATWERK ZANA HORIZONTAAL	TECHNISCHE GEGEVENS							STANDAARDKLEUR		ANDERE KLEUREN						
	buizen	breedte (L mm)	hoogte (H mm)	75/65/20 (Watt) (Φ50K)	55/45/20 (Watt) (Φ30K)	n-exp.	gewicht (kg)	inhoud (l)	el. weerst. (Watt)	prijs RAL 9016 (€)	prijs kleur (€)					
REF. NR. ZANA HORIZONTAAL ZH-1 : 252																
252	038	050	XX	YY	00	10	384	500	347	183	1,25	9,00	4,10	-	316	363
252	070	050	XX	YY	00	18	704	500	624	330	1,25	16,20	7,38	-	499	574
		060				18	704	600	728	384	1,25	18,90	8,46	-	544	626
		070				18	704	700	831	439	1,25	21,60	9,72	-	588	676
252	078	050	XX	YY	00	20	784	500	694	366	1,25	18,00	8,20	-	545	627
		060				20	784	600	809	427	1,25	21,00	9,40	-	594	683
		070				20	784	700	923	487	1,25	24,00	10,80	-	644	741
252	086	050	XX	YY	00	22	864	500	763	403	1,25	19,80	9,02	-	592	681
		060				22	864	600	890	470	1,25	23,10	10,34	-	645	742
		070				22	864	700	1015	536	1,25	26,40	11,88	-	694	798
252	094	050	XX	YY	00	24	944	500	832	439	1,25	21,60	9,84	-	636	731
		060				24	944	600	971	513	1,25	25,20	11,28	-	692	796
		070				24	944	700	1107	585	1,25	28,80	12,96	-	753	866
252	102	050	XX	YY	00	26	1024	500	902	476	1,25	23,40	10,66	-	684	787
		060				26	1024	600	1052	556	1,25	27,30	12,22	-	745	857
		070				26	1024	700	1200	634	1,25	31,20	14,04	-	809	930
252	110	050	XX	YY	00	28	1104	500	971	513	1,25	25,20	11,48	-	728	837
		060				28	1104	600	1133	598	1,25	29,40	13,16	-	795	914
		070				28	1104	700	1292	682	1,25	33,60	15,12	-	865	995
252	118	050	XX	YY	00	30	1184	500	1040	549	1,25	27,00	12,30	-	771	887
		060				30	1184	600	1214	641	1,25	31,50	14,10	-	843	969
		070				30	1184	700	1384	731	1,25	36,00	16,20	-	919	1057
252	126	050	XX	YY	00	32	1264	500	1110	586	1,25	28,80	13,12	-	818	941
		060				32	1264	600	1295	684	1,25	33,60	15,04	-	897	1032
		070				32	1264	700	1476	779	1,25	38,40	17,28	-	974	1120
252	142	050	XX	YY	00	36	1424	500	1248	659	1,25	32,40	14,76	-	912	1049
		060				36	1424	600	1457	769	1,25	37,80	16,92	-	996	1145
		070				36	1424	700	1661	877	1,25	43,20	19,44	-	1085	1248
252	158	050	XX	YY	00	40	1584	500	1387	732	1,25	36,00	16,40	-	999	1149
		060				40	1584	600	1618	854	1,25	42,00	18,80	-	1096	1260
		070				40	1584	700	1846	975	1,25	48,00	21,60	-	1197	1377
252	174	050	XX	YY	00	44	1744	500	1526	806	1,25	39,60	18,04	-	1092	1256
		060				44	1744	600	1780	940	1,25	46,20	20,68	-	1200	1380
		070				44	1744	700	2030	1072	1,25	52,80	23,76	-	1309	1505
252	190	050	XX	YY	00	48	1904	500	1665	879	1,25	43,20	19,68	-	1184	1362
		060				48	1904	600	1942	1026	1,25	50,40	22,56	-	1299	1494
		070				48	1904	700	2215	1170	1,25	57,60	25,92	-	1416	1628

Conform EN442-1: 2014: radiatoren en convectoren

Voor meer details over onze artikel-data, zie artikel-database: <https://www.installdata.be>

Voor de warmteafgiftes van andere regimes, kijkt u op p. 346 (correctiefactoren)
BELGIË. Prijzen in euro (excl. BTW)

ZANA HORIZONTAAL (ZH-1)



ZH-1

HOE ZANA HORIZONTAAL BESTELLEN

Leveringstermijn 15 - 30 werkdagen
(zonder transportduur)

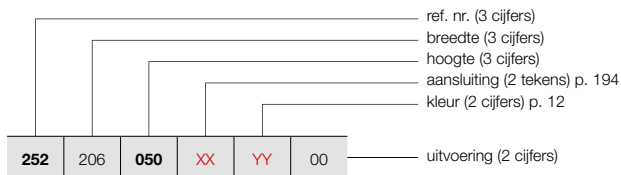

PRIJSGROEP: VPG2 - STAAL DESIGNRADIATOREN

BESTELCODE MAATWERK ZANA HORIZONTAAL	TECHNISCHE GEGEVENS									STANDAARDKLEUR	ANDERE KLEUREN	
	buizen	breedte (L mm)	hoogte (H mm)	75/65/20 (Watt) (Φ50K)	55/45/20 (Watt) (Φ30K)	n-exp.	gewicht (kg)	inhoud (l)	el. weerst. (Watt)	prijs RAL 9016 (€)	prijs kleur (€)	
REF. NR. ZANA HORIZONTAAL ZH-1 : 252												
252 206 050 XX YY 00	060	52	2064	500	1803	952	1,25	46,80	21,32	-	1275	1466
	070	52	2064	600	2104	1111	1,25	54,60	24,44	-	1401	1611
		52	2064	700	2399	1267	1,25	62,40	28,08	-	1528	1757
252 222 050 XX YY 00	060	56	2224	500	1942	1026	1,25	50,40	22,96	-	1365	1570
	070	56	2224	600	2266	1197	1,25	58,80	26,32	-	1502	1727
		56	2224	700	2584	1365	1,25	67,20	30,24	-	1641	1887
252 238 050 XX YY 00	060	60	2384	500	2081	1099	1,25	54,00	24,60	-	1457	1676
	070	60	2384	600	2428	1282	1,25	63,00	28,20	-	1605	1846
		60	2384	700	2768	1462	1,25	72,00	32,40	-	1751	2014
252 254 050 XX YY 00	060	64	2544	500	2220	1172	1,25	57,60	26,24	-	1548	1780
	070	64	2544	600	2589	1367	1,25	67,20	30,08	-	1706	1962
		64	2544	700	2953	1559	1,25	76,80	34,56	-	1862	2141
252 270 050 XX YY 00	060	68	2704	500	2358	1245	1,25	61,20	27,88	-	1642	1888
	070	68	2704	600	2751	1453	1,25	71,40	31,96	-	1807	2078
		68	2704	700	3138	1657	1,25	81,60	36,72	-	1971	2267
252 286 050 XX YY 00	060	72	2864	500	2497	1319	1,25	64,80	29,52	-	1732	1992
	070	72	2864	600	2913	1538	1,25	75,60	33,84	-	1908	2194
		72	2864	700	3322	1754	1,25	86,40	38,88	-	2083	2395

Conform EN442-1: 2014: radiatoren en convectoren

Voor meer details over onze artikel-data, zie artikel-database: <https://www.installdata.be>
Voor de warmteafgiftes van andere regimes, kijkt u op p. 346 (correctiefactoren)
BELGIË. Prijzen in euro (excl. BTW)

HOE ZANA HORIZONTAAL BESTELLEN

Leveringstermijn 15 - 30 werkdagen
(zonder transportduur)

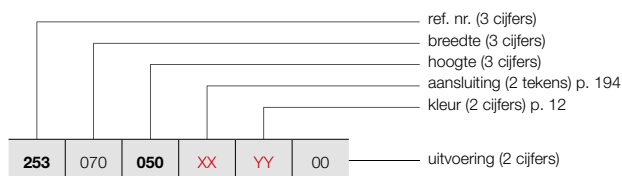

ZANA HORIZONTAAL (ZH-2)



ZH-2

PRIJSGROEP: VPG2 - STAAL DESIGNRADIATOREN

BESTELCODE MAATWERK ZANA HORIZONTAAL	TECHNISCHE GEGEVENS							STANDAARDKLEUR		ANDERE KLEUREN	
	buizen	breedte (L mm)	hoogte (H mm)	75/65/20 (Watt) (φ50K)	55/45/20 (Watt) (φ30K)	n-exp.	gewicht (kg)	inhoud (l)	el. weerst. (Watt)	prijs RAL 9016 (€)	prijs kleur (€)
REF. NR. ZANA HORIZONTAAL ZH-2 : 253											
253 070 050 XX YY 00	18	704	500	1035	547	1,28	30,42	13,50	-	847	974
	18	704	600	1205	636	1,28	35,64	16,02	-	922	1060
	18	704	700	1372	725	1,28	41,04	18,54	-	995	1144
253 078 050 XX YY 00	20	784	500	1150	607	1,28	33,80	15,00	-	923	1061
	20	784	600	1339	707	1,28	39,60	17,80	-	1011	1163
	20	784	700	1525	805	1,28	45,60	20,60	-	1090	1254
253 086 050 XX YY 00	22	864	500	1265	668	1,28	37,18	16,50	-	1000	1150
	22	864	600	1473	778	1,28	43,56	19,58	-	1093	1257
	22	864	700	1677	886	1,28	50,16	22,66	-	1184	1362
253 094 050 XX YY 00	24	944	500	1380	729	1,28	40,56	18,00	-	1082	1244
	24	944	600	1607	849	1,28	47,52	21,36	-	1179	1356
	24	944	700	1830	966	1,28	54,72	24,72	-	1279	1471
253 102 050 XX YY 00	26	1024	500	1494	789	1,28	43,94	19,50	-	1160	1334
	26	1024	600	1741	919	1,28	51,48	23,14	-	1268	1458
	26	1024	700	1982	1047	1,28	59,28	26,78	-	1374	1580
253 110 050 XX YY 00	28	1104	500	1609	850	1,28	47,32	21,00	-	1236	1421
	28	1104	600	1875	990	1,28	55,44	24,92	-	1352	1555
	28	1104	700	2135	1127	1,28	63,84	28,84	-	1468	1688
253 118 050 XX YY 00	30	1184	500	1724	910	1,28	50,70	22,50	-	1313	1510
	30	1184	600	2009	1061	1,28	59,40	26,70	-	1437	1653
	30	1184	700	2287	1208	1,28	68,40	30,90	-	1563	1797
253 126 050 XX YY 00	32	1264	500	1839	971	1,28	54,08	24,00	-	1391	1600
	32	1264	600	2143	1132	1,28	63,36	28,48	-	1526	1755
	32	1264	700	2440	1288	1,28	72,96	32,96	-	1655	1903
253 142 050 XX YY 00	36	1424	500	2069	1093	1,28	60,84	27,00	-	1547	1779
	36	1424	600	2411	1273	1,28	71,28	32,04	-	1693	1947
	36	1424	700	2745	1450	1,28	82,08	37,08	-	1845	2122
253 158 050 XX YY 00	40	1584	500	2299	1214	1,28	67,60	30,00	-	1702	1957
	40	1584	600	2678	1414	1,28	79,20	35,60	-	1869	2149
	40	1584	700	3050	1611	1,28	91,20	41,20	-	2036	2341
253 174 050 XX YY 00	44	1744	500	2529	1335	1,28	74,36	33,00	-	1857	2136
	44	1744	600	2946	1556	1,28	87,12	39,16	-	2041	2347
	44	1744	700	3355	1772	1,28	100,32	45,32	-	2220	2553
253 190 050 XX YY 00	48	1904	500	2759	1457	1,28	81,12	36,00	-	2012	2314
	48	1904	600	3214	1697	1,28	95,04	42,72	-	2212	2544
	48	1904	700	3660	1933	1,28	109,44	49,44	-	2409	2770

Conform EN442-1: 2014: radiatoren en convectoren

Voor meer details over onze artikel-data, zie artikel-database: <https://www.installdata.be>

Voor de warmteafgiftes van andere regimes, kijkt u op p. 346 (correctiefactoren)

BELGIË. Prijzen in euro (excl. BTW)

ZANA HORIZONTAAL (ZH-2)



ZH-2

HOE ZANA HORIZONTAAL BESTELLEN

Leveringstermijn 15 - 30 werkdagen
(zonder transportduur)

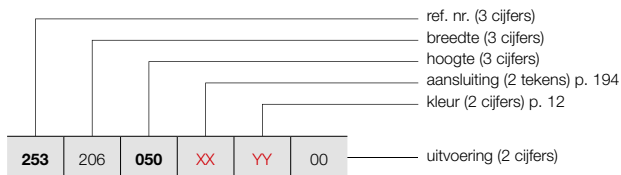

PRIJSGROEP: VPG2 - STAAL DESIGNRADIATOREN

BESTELCODE MAATWERK ZANA HORIZONTAAL	TECHNISCHE GEGEVENS									STANDAARDKLEUR	ANDERE KLEUREN					
	buizen	breedte (L mm)	hoogte (H mm)	75/65/20 (Watt) (Φ50K)	55/45/20 (Watt) (Φ30K)	n-exp.	gewicht (kg)	inhoud (l)	el. weerst. (Watt)	prijs RAL 9016 (€)	prijs kleur (€)					
REF. NR. ZANA HORIZONTAAL ZH-2 : 253																
253	206	050	XX	YY	00	52	2064	500	2989	1578	1,28	87,88	39,00	-	2168	2493
		060				52	2064	600	3482	1839	1,28	102,96	46,28	-	2382	2739
		070				52	2064	700	3964	2093	1,28	118,56	53,56	-	2598	2988
253	222	050	XX	YY	00	56	2224	500	3219	1700	1,28	94,64	42,00	-	2326	2675
		060				56	2224	600	3750	1980	1,28	110,88	49,84	-	2556	2939
		070				56	2224	700	4269	2254	1,28	127,68	57,68	-	2787	3205
253	238	050	XX	YY	00	60	2384	500	3449	1821	1,28	101,40	45,00	-	2480	2852
		060				60	2384	600	4018	2122	1,28	118,80	53,40	-	2727	3136
		070				60	2384	700	4574	2415	1,28	136,80	61,80	-	2974	3420
253	254	050	XX	YY	00	64	2544	500	3679	1943	1,28	108,16	48,00	-	2634	3029
		060				64	2544	600	4285	2263	1,28	126,72	56,96	-	2900	3335
		070				64	2544	700	4879	2576	1,28	145,92	65,92	-	3164	3639
253	270	050	XX	YY	00	68	2704	500	3909	2064	1,28	114,92	51,00	-	2792	3211
		060				68	2704	600	4553	2404	1,28	134,64	60,52	-	3069	3529
		070				68	2704	700	5184	2737	1,28	155,04	70,04	-	3352	3855
253	286	050	XX	YY	00	72	2864	500	4139	2186	1,28	121,68	54,00	-	2944	3386
		060				72	2864	600	4821	2546	1,28	142,56	64,08	-	3244	3731

Conform EN442-1: 2014: radiatoren en convectoren

Voor meer details over onze artikel-data, zie artikel-database: <https://www.installdata.be>

Voor de warmteafgifte van andere regimes, kijkt u op p. 346 (correctiefactoren)
BELGIË. Prijzen in euro (excl. BTW)

PRIJSGROEP: VPG10B - HANDDOEKBEUGELS

ACCESSOIRES	BREEDTE RADIATOR	KLEUR	ART. NR.	€
ZV-1 / ZV-2 / ZH-1 / ZH-2				
HANDDOEKBEUGEL RECHT		CHROOM	1183 228 0000 0099	184
<ul style="list-style-type: none"> h = 22 mm; b = 720 mm (zelf in te korten); d = 75 mm; a = 56 mm 				
ZV-1 / ZV-2 / ZH-1 / ZH-2				
KNOP		CHROOM	1183 410 0000 0099	87
<ul style="list-style-type: none"> h = 70 mm; b = 70 mm; d = 59 mm; a = 51 mm; 				
ZV-1				
HANDDOEKBEUGEL MULTI+ RECHTS	600 mm	S600	1183 734 0000 0600	198
	600 mm	RAL 9005 ^S	1183 734 0000 9005	198
<ul style="list-style-type: none"> h = 70 mm; b = 600 mm (b tablet = 194 mm); e = 176 mm; c = 170 mm; Bevestiging aan de muur, rechts van de radiator. 				
ZV-1				
HANDDOEKBEUGEL MULTI+ LINKS	600 mm	S600	1183 735 0000 0600	198
	600 mm	RAL 9005 ^S	1183 735 0000 9005	198
<ul style="list-style-type: none"> h = 70 mm; b = 600 mm (b tablet = 194 mm); e = 176 mm; c = 170 mm; Bevestiging aan de muur, links van de radiator. 				

^S structuur zwart

Montagevoorschriften accessoires: zie www.vasco.eu
BELGIË. Prijzen in euro (excl. BTW)

e = afstand voorkant accessoire tot wand
d = afstand voorkant accessoire tot voorkant radiator
c = afstand wand tot achterkant beugel
a = afstand accessoire tot radiator
uit voorraad leverbaar

ZANA VERTICAAL: ZV-1 / ZV-2 (VOORRAAD)

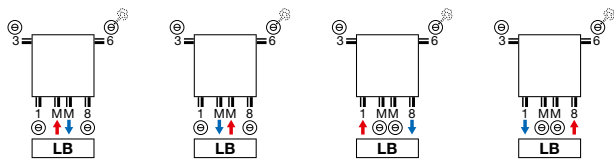

ZANA HORIZONTAAL: ZH-1 / ZH-2

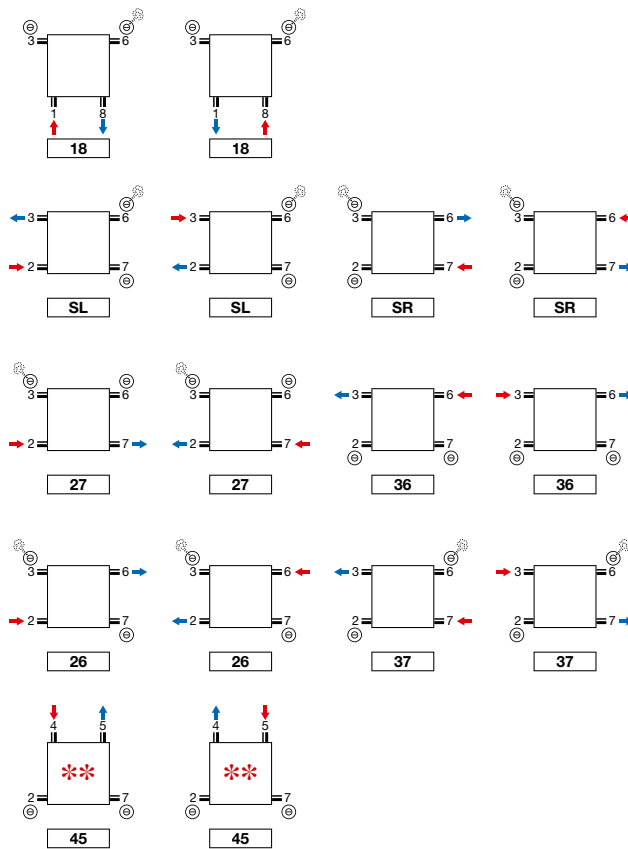

** Niet voor ZH-1 toiletradiator.

ZANA VERTICAAL: ZV-1 / ZV-2 (NIET-VOORRAAD)

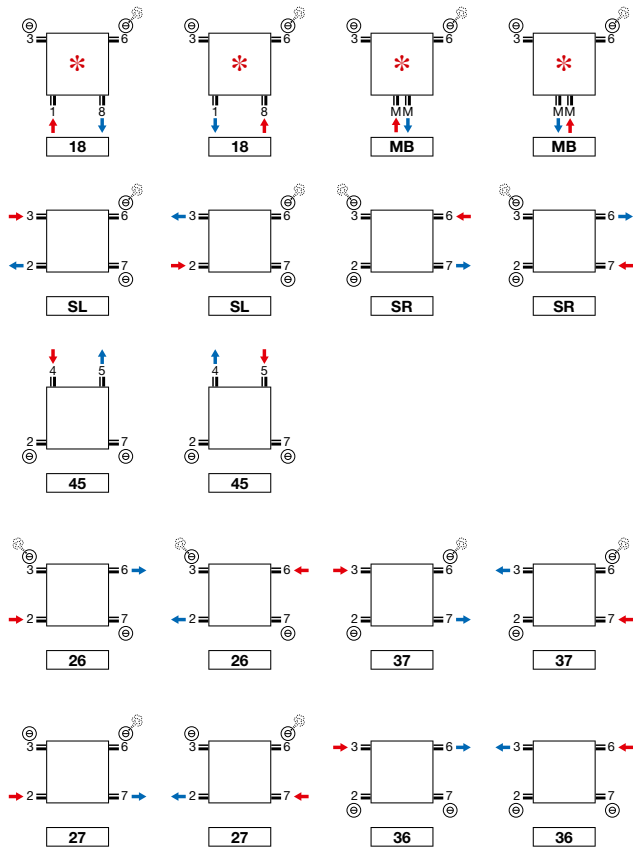

* **Opmerking ZV-1/ZV-2 8 buizen: 2/3/6/7 altijd open.**

Opmerking: het aansluiten van de radiator kan enkel volgens de getoonde aansluiticonen. Voor elke andere aansluitwijze nemen wij geen verantwoordelijkheid.

ZANA VERTICAAL (ZV-1, ZV-2)

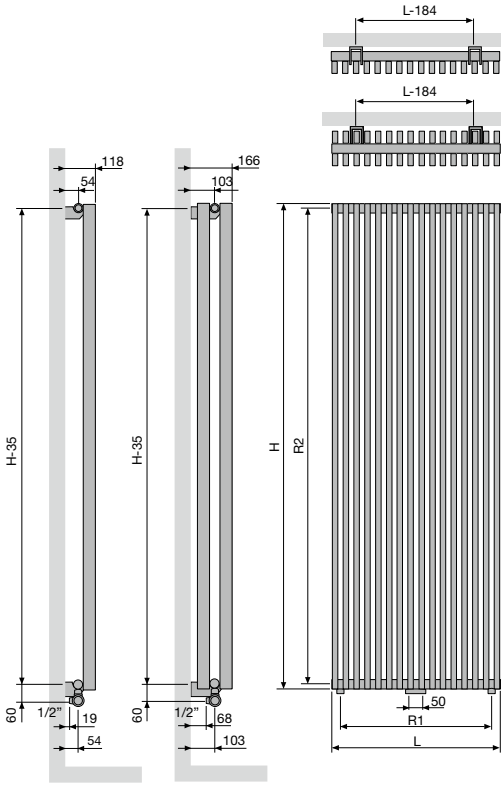

ZV-1 / ZV-2

aantal buizen	8	10	12	14	16	18	20	22	24	26
Breedte (L)	304	384	464	544	624	704	784	864	944	1024
Hartafstand tussen de onderaansluitingen 18 (R1)	240	320	400	480	560	640	720	800	880	960
hoogte (H)	1400	1600	1800	2000	2200	2400	2600	2800	3000	
Hartafstand tussen de zijaansluitingen SL/SR (R2)	1365	1565	1765	1965	2165	2365	2565	2765	2965	
Hartafstand tussen de ophangingen	L-184	H-35								

ZANA HORIZONTAAL (ZH-1, ZH-2)

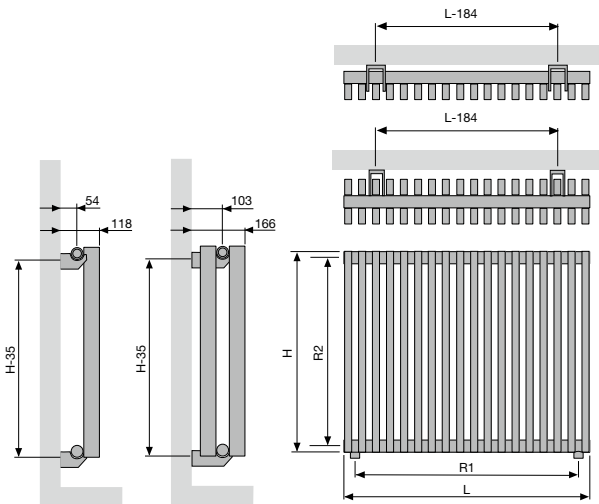

ZH-1 / ZH-2

Breedte (L)	384	704	784	864	944	1024	1104	1184	1264	1424	1584	1744	1904	2064	2224	2384	2544	2704	2864
Hartafstand tussen de onderaansluitingen 18 (R1)	320	640	720	800	880	960	1040	1120	1200	1360	1520	1680	1840	2000	2160	2320	2480	2640	2800
hoogte (H)	500	600	700																
Hartafstand tussen de zijaansluitingen SL/SR (R2)	465	565	665																
Hartafstand tussen de ophangingen	L-184	H-35																	

VIOLA-A VERTICAAL (V1-ZB-A, V1L1-ZB-A, V2-ZB-A)



TYPES

- V1-ZB-A enkele rij buizen, V2-ZB-A dubbele rij buizen, V1L1-ZB-A met lamellen

BUIZEN

- Verticaal, rechthoekig 77 x 10 mm

COLLECTOREN

- V1-ZB-A: 35 x 43 mm
- V1L1-ZB-A: 35 x 43 mm
- V2-ZB-A: 35 x 41 mm

KLEUREN

- Standaardkleur wit RAL 9016
- Uitgebreide kleurenkaart zie p. 12

SPECIAAL

- Wordt standaard geleverd met 2 zijbekledingen.
- mm aansluiting alleen mogelijk bij even aantal buizen.
- Bij type V1L1-ZB-A is 1 rij stalen lamellen ter verhoging van de warmteafgifte op de platovale buizen gepuntlast.

BEVESTIGINGEN

- Muurbevestigingen standaard (inbegrepen in de verpakking van de radiator)
- Bovenste beugel in kleur van de radiator, onderaan:
 - Afstandshouder radiator wit = afstandshouder wit.
 - Afstandshouder radiator in kleur = afstandshouder RAL 7024.
- **V2-ZB-A:** Radiator met telescopische steunvoeten + variabele muurbevestiging: gelieve bij bestelling code **07** aan te geven bij "Afwerking" (zie p. 225).

TECHNISCH

- Weerstandsgelast (onzichtbare lasnaden)
- ATL-grondlaag, poedercoating
- Standaardwerkdruk: 4 bar. Meerprijs hogere werkdruk (10 bar): +10%
- De leveringstermijn van radiator met een hogere werkdruk is 1 week extra.
- Maximale bedrijfstemperatuur: 110°C

ELEKTRISCH

- ✗ Zuiver elektrische radiator in de fabriek voorgevuld
- ✗ Gemengde radiator

TECHNISCHE TEKENINGEN

- Zie p. 228

AANSLUITING

- ✗ Eénpuntsaansluiting voor éénpijpsysteem
- ✗ Eénpuntsaansluiting voor tweepijpsysteem
- ✓ Tweepuntsaansluiting voor éénpijpsysteem (aansluiting via de middenaansluiting) (zie p. 340)
- ✓ Tweepuntsaansluiting voor tweepijpsysteem (standaard) (zie p. 340)
- ✗ Geïntegreerd ventiel
- Aansluitingen: ½" (binnendraad)

VIOLA-A VERTICAAL

In de soberheid toont zich de klasse

Een buizenradiator die naadloos combineert met elke woonstijl, door zijn sobere klasse en zijn vanzelfsprekend design. De strak gelijkende voorkant en de ingewerkte zijpanelen staan borg voor een uniforme look en een optimale warmteafgifte. Viola-A, zo simpel, krachtig en aantrekkelijk kan verwarmingscomfort zijn.

AANBEVOLEN AANSLUITING (LM)

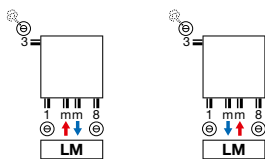

mm aansluiting alleen mogelijk bij even aantal buizen.
Andere aansluitmogelijkheden, zie p. 227



art. nr. 118200100009016
prijs €126
 Koppelingen, zie p. 353



art. nr. 11911630102
prijs €44

AANBEVOLEN VOOR BADKAMER EN KEUKEN IN OPTIE



handdoekbeugel (RAL 9005)
 art. nr. zie p. 226
prijs €145
Andere accessoires, zie p. 226



HOE VIOLA-A VERTICAAL BESTELLEN

Leveringstermijn 15 - 30 werkdagen
(zonder transportduur)

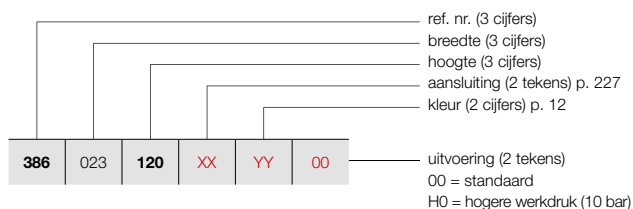

VIOLA-A VERTICAAL (V1-ZB-A)



V1-ZB-A

HOE VOORRAADRADIATOR VIOLA-A VERTICAAL BESTELLEN

Leveringstermijn 5 werkdagen
(zonder transportduur)

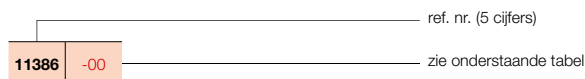

PRIJSGROEP: VPG2 - STAAL DESIGNRADIATOREN

BESTELCODE MAATWERK VIOLA-A VERTICAAL	TECHNISCHE GEGEVENS									STANDAARDKLEUR		ANDERE KLEUREN
	buizen	breedte (L mm)	hoogte (H mm)	75/65/20 (Watt) (Φ50K)	55/45/20 (Watt) (Φ30K)	n-exp.	gewicht (kg)	inhoud (l)	el. weerst. (Watt)	prijs RAL 9016 (€)	verkorte ref. nr. RAL 9016 voorraad	
REF. NR. VIOLA-A VERTICAAL V1-ZB-A : 386												
386 023 120 XX YY 00	3	237	1200	371	189	1,32	7,80	2,40	-	321	-	369
	3	237	1400	427	218	1,32	9,00	2,73	-	354	-	407
	3	237	1600	483	246	1,32	9,90	3,03	-	377	-	434
	3	237	1800	535	273	1,32	11,10	3,33	-	405	-	466
	3	237	2000	589	301	1,30	12,30	3,60	-	436	-	501
	3	237	2200	640	327	1,28	13,50	3,90	-	464	-	534
	3	237	2400	689	352	1,27	14,40	4,20	-	490	-	564
386 031 120 XX YY 00	4	317	1200	480	245	1,31	10,40	3,20	-	377	-	434
	4	317	1400	551	281	1,31	12,00	3,64	-	414	-	476
	4	317	1600	624	318	1,31	13,20	4,04	-	450	-	518
	4	317	1800	695	355	1,32	14,80	4,44	-	483	-	555
	4	317	2000	764	390	1,30	16,40	4,80	-	521	-	599
	4	317	2200	831	424	1,29	18,00	5,20	-	556	-	639
	4	317	2400	894	456	1,27	19,20	5,60	-	593	-	682
386 039 120 XX YY 00	5	397	1200	585	298	1,31	13,00	4,00	-	434	-	499
	5	397	1400	673	343	1,31	15,00	4,55	-	476	-	547
	5	397	1600	762	389	1,31	16,50	5,05	-	521	-	599
	5	397	1800	850	434	1,31	18,50	5,55	-	564	-	649
	5	397	2000	936	478	1,30	20,50	6,00	-	607	-	698
	5	397	2200	1017	519	1,29	22,50	6,50	-	650	-	748
	5	397	2400	1094	558	1,28	24,00	7,00	-	691	-	795
386 047 120 XX YY 00	6	477	1200	689	352	1,31	15,60	4,80	-	490	-	564
	6	477	1400	792	404	1,31	18,00	5,46	-	541	-	622
	6	477	1600	897	458	1,31	19,80	6,06	-	593	-	682
	6	477	1800	1003	512	1,31	22,20	6,66	-	644	-	741
	6	477	2000	1104	563	1,30	24,60	7,20	-	691	11386-01	795
	6	477	2200	1200	612	1,29	27,00	7,80	-	743	-	854
	6	477	2400	1291	659	1,28	28,80	8,40	-	793	-	912
386 055 120 XX YY 00	7	557	1200	790	403	1,30	18,20	5,60	-	551	-	634
	7	557	1400	909	464	1,31	21,00	6,37	-	607	-	698
	7	557	1600	1029	525	1,31	23,10	7,07	-	663	-	762
	7	557	1800	1154	589	1,31	25,90	7,77	-	723	-	831
	7	557	2000	1269	647	1,30	28,70	8,40	-	777	-	894
	7	557	2200	1380	704	1,29	31,50	9,10	-	835	-	960
	7	557	2400	1485	758	1,28	33,60	9,80	-	891	-	1025
386 063 120 XX YY 00	8	637	1200	891	455	1,30	20,80	6,40	-	606	-	697
	8	637	1400	1024	522	1,30	24,00	7,28	-	670	-	771
	8	637	1600	1159	591	1,31	26,40	8,08	-	735	-	845
	8	637	1800	1302	664	1,31	29,60	8,88	-	799	-	919
	8	637	2000	1433	731	1,30	32,80	9,60	-	865	-	995
	8	637	2200	1557	794	1,29	36,00	10,40	-	924	-	1063
	8	637	2400	1676	855	1,29	38,40	11,20	-	990	-	1139

Conform EN442-1: 2014: radiatoren en convectoren

Voor meer details over onze artikel-data, zie artikel-database: <https://www.installdata.be>
Voor de warmteafgiftes van andere regimes, kijkt u op p. 346 (correctiefactoren)
BELGIË. Prijzen in euro (excl. BTW)

VIOLA-A VERTICAAL (V1-ZB-A)



V1-ZB-A

HOE VIOLA-A VERTICAAL BESTELLEN

Leveringstermijn 15 - 30 werkdagen
(zonder transportduur)

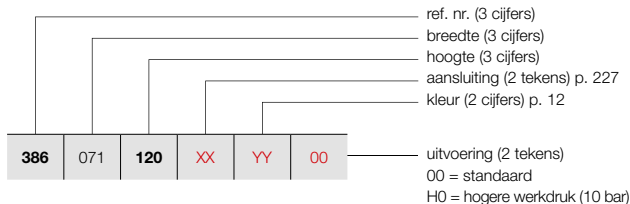

PRIJSGROEP: VPG2 - STAAL DESIGNRADIATOREN

BESTELCODE MAATWERK VIOLA-A VERTICAAL							TECHNISCHE GEGEVENS					STANDAARDKLEUR	ANDERE KLEUREN				
386	071	120	XX	YY	00	buizen	breedte (L mm)	hoogte (H mm)	75/65/20 (Watt) (Φ50K)	55/45/20 (Watt) (Φ30K)	n-exp.	gewicht (kg)	inhoud (l)	el. weerst. (Watt)	prijs RAL 9016 (€)	prijs kleur (€)	
REF. NR. VIOLA-A VERTICAAL V1-ZB-A : 386																	
386	071	120	XX	YY	00	9	717	1200	989	505	1,29	23,40	7,20	-	663	762	
		140				9	717	1400	1137	580	1,30	27,00	8,19	-	735	845	
		160				9	717	1600	1288	657	1,31	29,70	9,09	-	804	925	
		180				9	717	1800	1449	739	1,31	33,30	9,99	-	879	1011	
		200				9	717	2000	1594	813	1,30	36,90	10,80	-	950	1093	
		220				9	717	2200	1733	884	1,30	40,50	11,70	-	1020	1173	
		240				9	717	2400	1864	951	1,29	43,20	12,60	-	1090	1254	
386	079	120	XX	YY	00	10	797	1200	1087	555	1,29	26,00	8,00	-	719	827	
		140				10	797	1400	1249	637	1,30	30,00	9,10	-	799	919	
		160				10	797	1600	1414	721	1,30	33,00	10,10	-	879	1011	
		180				10	797	1800	1594	813	1,31	37,00	11,10	-	955	1098	
		200				10	797	2000	1754	895	1,31	41,00	12,00	-	1034	1189	
		220				10	797	2200	1906	972	1,30	45,00	13,00	-	1115	1282	
		240				10	797	2400	2051	1046	1,29	48,00	14,00	-	1193	1372	
386	087	120	XX	YY	00	11	877	1200	1183	604	1,28	28,60	8,80	-	777	894	
		140				11	877	1400	1360	694	1,29	33,00	10,01	-	863	992	
		160				11	877	1600	1540	786	1,30	36,30	11,11	-	948	1090	
		180				11	877	1800	1738	887	1,31	40,70	12,21	-	1034	1189	
		200				11	877	2000	1912	976	1,31	45,10	13,20	-	1120	1288	
		220				11	877	2200	2078	1060	1,30	49,50	14,30	-	1206	1387	
		240				11	877	2400	2236	1141	1,29	52,80	15,40	-	1292	1486	
386	095	120	XX	YY	00	12	957	1200	1279	653	1,28	31,20	9,60	-	834	959	
		140				12	957	1400	1470	750	1,29	36,00	10,92	-	923	1061	
		160				12	957	1600	1664	849	1,30	39,60	12,12	-	1018	1171	
		180				12	957	1800	1881	960	1,31	44,40	13,32	-	1111	1278	
		200				12	957	2000	2069	1056	1,31	49,20	14,40	-	1206	1387	
		220				12	957	2200	2249	1147	1,30	54,00	15,60	-	1297	1492	
		240				12	957	2400	2420	1235	1,30	57,60	16,80	-	1392	1601	
386	103	120	XX	YY	00	13	1037	1200	1374	701	1,27	33,80	10,40	-	948	1090	
		140				13	1037	1400	1579	806	1,29	39,00	11,83	-	1053	1211	
		160				13	1037	1600	1788	912	1,30	42,90	13,13	-	1162	1336	
		180				13	1037	1800	2023	1032	1,31	48,10	14,43	-	1270	1461	
		200				13	1037	2000	2225	1135	1,31	53,30	15,60	-	1374	1580	
		220				13	1037	2200	2418	1234	1,30	58,50	16,90	-	1484	1707	
		240				13	1037	2400	2602	1328	1,30	62,40	18,20	-	1591	1830	

Conform EN442-1: 2014: radiatoren en convectoren

Voor meer details over onze artikel-data, zie artikel-database: <https://www.installdata.be>

Voor de warmteafgifte van andere regimes, kijkt u op p. 346 (correctiefactoren)
BELGIË. Prijzen in euro (excl. BTW)

HOE VIOLA-A VERTICAAL BESTELLEN

Leveringstermijn 15 - 30 werkdagen
(zonder transportduur)

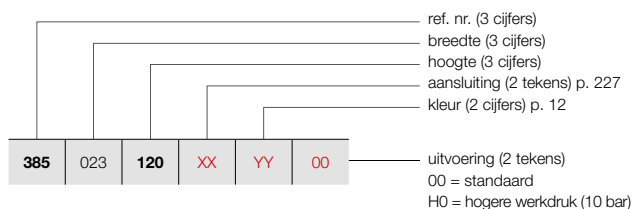

VIOLA-A VERTICAAL (V1L1-ZB-A)



V1L1-ZB-A

PRIJSGROEP: VPG2 - STAAL DESIGNRADIATOREN

BESTELCODE MAATWERK VIOLA-A VERTICAAL	TECHNISCHE GEGEVENS							STANDAARDKLEUR		ANDERE KLEUREN						
	buizen	breedte (L mm)	hoogte (H mm)	75/65/20 (Watt) (Φ50K)	55/45/20 (Watt) (Φ30K)	n-exp.	gewicht (kg)	inhoud (l)	el. weerst. (Watt)	prijs RAL 9016 (€)	prijs kleur (€)					
REF. NR. VIOLA-A VERTICAAL V1L1-ZB-A : 385																
385	023	120	XX	YY	00	3	237	1200	464	237	1,28	10,50	2,40	-	400	460
		140				3	237	1400	531	271	1,28	12,60	2,73	-	437	503
		160				3	237	1600	597	305	1,29	14,40	3,03	-	473	544
		180				3	237	1800	661	337	1,29	15,90	3,33	-	510	587
		200				3	237	2000	723	369	1,30	18,30	3,60	-	545	627
		220				3	237	2200	784	400	1,32	19,80	3,90	-	579	666
		240				3	237	2400	843	430	1,33	21,60	4,20	-	616	708
385	031	120	XX	YY	00	4	317	1200	605	309	1,28	14,00	3,20	-	473	544
		140				4	317	1400	693	354	1,29	16,80	3,64	-	518	596
		160				4	317	1600	778	397	1,29	19,20	4,04	-	562	646
		180				4	317	1800	861	439	1,29	21,20	4,44	-	607	698
		200				4	317	2000	943	481	1,31	24,40	4,80	-	651	749
		220				4	317	2200	1022	521	1,32	26,40	5,20	-	693	797
		240				4	317	2400	1099	561	1,33	28,80	5,60	-	740	851
385	039	120	XX	YY	00	5	397	1200	743	379	1,29	17,50	4,00	-	544	626
		140				5	397	1400	851	434	1,29	21,00	4,55	-	597	687
		160				5	397	1600	956	488	1,29	24,00	5,05	-	651	749
		180				5	397	1800	1058	540	1,30	26,50	5,55	-	704	810
		200				5	397	2000	1158	591	1,31	30,50	6,00	-	758	872
		220				5	397	2200	1255	640	1,32	33,00	6,50	-	813	935
		240				5	397	2400	1350	689	1,33	36,00	7,00	-	867	997
385	047	120	XX	YY	00	6	477	1200	879	448	1,29	21,00	4,80	-	616	708
		140				6	477	1400	1007	514	1,29	25,20	5,46	-	680	782
		160				6	477	1600	1131	577	1,30	28,80	6,06	-	740	851
		180				6	477	1800	1252	639	1,30	31,80	6,66	-	802	922
		200				6	477	2000	1370	699	1,31	36,60	7,20	-	867	997
		220				6	477	2200	1485	758	1,32	39,60	7,80	-	927	1066
		240				6	477	2400	1598	815	1,33	43,20	8,40	-	990	1139
385	055	120	XX	YY	00	7	557	1200	1013	517	1,29	24,50	5,60	-	687	790
		140				7	557	1400	1160	592	1,30	29,40	6,37	-	758	872
		160				7	557	1600	1303	665	1,30	33,60	7,07	-	831	956
		180				7	557	1800	1443	736	1,31	37,10	7,77	-	900	1035
		200				7	557	2000	1579	806	1,31	42,70	8,40	-	972	1118
		220				7	557	2200	1712	873	1,32	46,20	9,10	-	1045	1202
		240				7	557	2400	1841	939	1,33	50,40	9,80	-	1118	1286
385	063	120	XX	YY	00	8	637	1200	1146	585	1,29	28,00	6,40	-	757	871
		140				8	637	1400	1312	669	1,30	33,60	7,28	-	837	963
		160				8	637	1600	1474	752	1,31	38,40	8,08	-	919	1057
		180				8	637	1800	1632	833	1,31	42,40	8,88	-	997	1147
		200				8	637	2000	1786	911	1,32	48,80	9,60	-	1081	1243
		220				8	637	2200	1936	988	1,32	52,80	10,40	-	1160	1334
		240				8	637	2400	2083	1063	1,33	57,60	11,20	-	1241	1427

Conform EN442-1: 2014: radiatoren en convectoren

Voor meer details over onze artikel-data, zie artikel-database: <https://www.installdata.be>
Voor de warmteafgifte van andere regimes, kijkt u op p. 346 (correctiefactoren)
BELGIË. Prijzen in euro (excl. BTW)

VIOLA-A VERTICAAL (V1L1-ZB-A)



V1L1-ZB-A

HOE VIOLA-A VERTICAAL BESTELLEN

Leveringstermijn 15 - 30 werkdagen
(zonder transportduur)

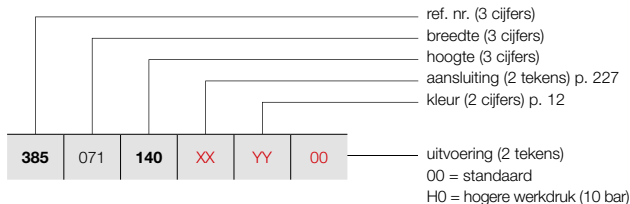

PRIJSGROEP: VPG2 - STAAL DESIGNRADIATOREN

BESTELCODE MAATWERK VIOLA-A VERTICAAL							TECHNISCHE GEGEVENS					STANDAARDKLEUR	ANDERE KLEUREN			
buizen	breedte (L mm)	hoogte (H mm)	75/65/20 (Watt) (Φ50K)	55/45/20 (Watt) (Φ30K)	n-exp.	gewicht (kg)	inhoud (l)	el. weerst. (Watt)	prijs RAL 9016 (€)	prijs kleur (€)						
REF. NR. VIOLA-A VERTICAAL V1L1-ZB-A : 385																
385	071	140	XX	YY	00	9	717	1400	1462	746	1,30	37,80	8,19	-	919	1057
		160				9	717	1600	1643	838	1,31	43,20	9,09	-	1008	1159
		180				9	717	1800	1819	928	1,32	47,70	9,99	-	1094	1258
		200				9	717	2000	1990	1015	1,32	54,90	10,80	-	1187	1365
		220				9	717	2200	2158	1101	1,32	59,40	11,70	-	1275	1466
		240				9	717	2400	2321	1184	1,33	64,80	12,60	-	1362	1566
385	079	120	XX	YY	00	10	797	1200	1407	718	1,30	35,00	8,00	-	899	1034
		140				10	797	1400	1611	822	1,31	42,00	9,10	-	997	1147
		160				10	797	1600	1810	923	1,31	48,00	10,10	-	1094	1258
		180				10	797	1800	2004	1022	1,32	53,00	11,10	-	1196	1375
		200				10	797	2000	2194	1119	1,32	61,00	12,00	-	1292	1486
		220				10	797	2200	2387	1218	1,32	66,00	13,00	-	1392	1601
		240				10	797	2400	2558	1305	1,33	72,00	14,00	-	1490	1714
385	087	120	XX	YY	00	11	877	1200	1536	784	1,30	38,50	8,80	-	972	1118
		140				11	877	1400	1759	897	1,31	46,20	10,01	-	1079	1241
		160				11	877	1600	1976	1008	1,32	52,80	11,11	-	1186	1364
		180				11	877	1800	2189	1117	1,32	58,30	12,21	-	1292	1486
		200				11	877	2000	2394	1221	1,33	67,10	13,20	-	1398	1608
		220				11	877	2200	2596	1324	1,33	72,60	14,30	-	1508	1734
		240				11	877	2400	2792	1424	1,33	79,20	15,40	-	1615	1857
385	095	120	XX	YY	00	12	957	1200	1665	849	1,31	42,00	9,60	-	1043	1199
		140				12	957	1400	1907	973	1,31	50,40	10,92	-	1159	1333
		160				12	957	1600	2142	1093	1,32	57,60	12,12	-	1274	1465
		180				12	957	1800	2371	1210	1,33	63,60	13,32	-	1391	1600
		200				12	957	2000	2595	1324	1,33	73,20	14,40	-	1508	1734
		220				12	957	2200	2813	1435	1,33	79,20	15,60	-	1621	1864
		240				12	957	2400	3026	1544	1,33	86,40	16,80	-	1739	2000
385	103	120	XX	YY	00	13	1037	1200	1792	914	1,31	45,50	10,40	-	1186	1364
		140				13	1037	1400	2052	1047	1,32	54,60	11,83	-	1317	1515
		160				13	1037	1600	2306	1177	1,33	62,40	13,13	-	1453	1671
		180				13	1037	1800	2552	1302	1,33	68,90	14,43	-	1585	1823
		200				13	1037	2000	2793	1425	1,33	79,30	15,60	-	1719	1977
		220				13	1037	2200	3028	1545	1,33	85,80	16,90	-	1853	2131
		240				13	1037	2400	3257	1662	1,33	93,60	18,20	-	1990	2289

Conform EN442-1: 2014: radiatoren en convectoren

Voor meer details over onze artikel-data, zie artikel-database: <https://www.installdata.be>
Voor de warmteafgifte van andere regimes, kijkt u op p. 346 (correctiefactoren)
BELGIË. Prijzen in euro (excl. BTW)

HOE VIOLA-A VERTICAAL BESTELLEN

Leveringstermijn 15 - 30 werkdagen
(zonder transportduur)

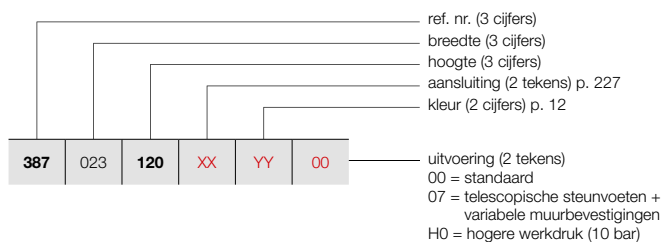

HOE VOORRAADRADIATOR VIOLA-A VERTICAAL BESTELLEN

Leveringstermijn 5 werkdagen
(zonder transportduur)

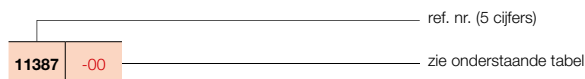

VIOLA-A VERTICAAL (V2-ZB-A)



V2-ZB-A

PRIJSGROEP: VPG2 - STAAL DESIGNRADIATOREN

BESTELCODE MAATWERK VIOLA-A VERTICAAL	TECHNISCHE GEGEVENS							STANDAARDKLEUR		ANDERE KLEUREN		
	buizen	breedte (L mm)	hoogte (H mm)	75/65/20 (Watt) (Φ50K)	55/45/20 (Watt) (Φ30K)	n-exp.	gewicht (kg)	inhoud (l)	el. weerst. (Watt)		prijs RAL 9016 (€)	verkorte ref. nr. RAL 9016 voorraad
REF. NR. VIOLA-A VERTICAAL V2-ZB-A : 387												
387	023	120	XX	YY	00							
		140										
		160										
		180										
		200										
		220										
		240										
387	031	120	XX	YY	00							
		140										
		160										
		180										
		200										
		220										
		240										
387	039	120	XX	YY	00							
		140										
		160										
		180										
		200										
		220										
		240										
387	047	120	XX	YY	00							
		140										
		160										
		180										
		200										
		220										
		240										
387	055	120	XX	YY	00							
		140										
		160										
		180										
		200										
		220										
		240										
387	063	120	XX	YY	00							
		140										
		160										
		180										
		200										
		220										
		240										

Conform EN442-1: 2014: radiatoren en convectoren

Voor meer details over onze artikel-data, zie artikel-database: <https://www.installdata.be>
Voor de warmteafgiftes van andere regimes, kijkt u op p. 346 (correctiefactoren)
BELGIË. Prijzen in euro (excl. BTW)

VIOLA-A VERTICAAL (V2-ZB-A)



V2-ZB-A

HOE VIOLA-A VERTICAAL BESTELLEN

Leveringstermijn 15 - 30 werkdagen
(zonder transportduur)

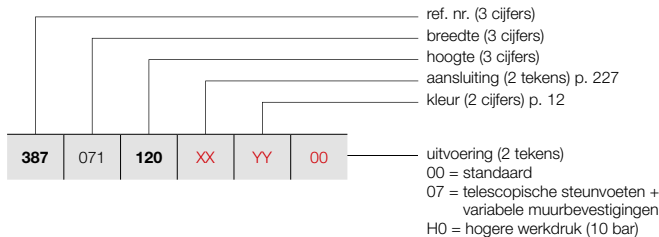

PRIJSGROEP: VPG2 - STAAL DESIGNRADIATOREN

BESTELCODE MAATWERK VIOLA-A VERTICAAL							TECHNISCHE GEGEVENS					STANDAARDKLEUR	ANDERE KLEUREN			
buizen	breedte (L mm)	hoogte (H mm)	75/65/20 (Watt) (Φ50K)	55/45/20 (Watt) (Φ30K)	n-exp.	gewicht (kg)	inhoud (l)	el. weerst. (Watt)	prijs RAL 9016 (€)	prijs kleur (€)						
REF. NR. VIOLA-A VERTICAAL V2-ZB-A : 387																
387	071	120	XX	YY	00	9	717	1200	1387	708	1,34	43,20	13,77	-	1128	1297
		140				9	717	1400	1596	814	1,35	50,40	15,12	-	1248	1435
		160				9	717	1600	1801	919	1,36	56,70	16,56	-	1368	1573
		180				9	717	1800	1999	1020	1,36	63,90	17,91	-	1491	1715
		200				9	717	2000	2194	1119	1,36	70,20	19,17	-	1614	1856
		220				9	717	2200	2384	1216	1,35	77,40	20,43	-	1736	1996
		240				9	717	2400	2570	1311	1,35	84,60	21,69	-	1854	2132
387	079	120	XX	YY	00	10	797	1200	1533	782	1,34	48,00	15,30	-	1219	1402
		140				10	797	1400	1765	901	1,35	56,00	16,80	-	1358	1562
		160				10	797	1600	1990	1015	1,36	63,00	18,40	-	1491	1715
		180				10	797	1800	2209	1127	1,37	71,00	19,90	-	1624	1868
		200				10	797	2000	2422	1236	1,36	78,00	21,30	-	1757	2021
		220				10	797	2200	2631	1342	1,36	86,00	22,70	-	1889	2172
		240				10	797	2400	2836	1447	1,35	94,00	24,10	-	2025	2329
387	087	120	XX	YY	00	11	877	1200	1679	857	1,34	52,80	16,83	-	1319	1517
		140				11	877	1400	1933	986	1,35	61,60	18,48	-	1464	1684
		160				11	877	1600	2179	1112	1,36	69,30	20,24	-	1609	1850
		180				11	877	1800	2418	1234	1,37	78,10	21,89	-	1757	2021
		200				11	877	2000	2651	1353	1,36	85,80	23,43	-	1904	2190
		220				11	877	2200	2878	1468	1,36	94,60	24,97	-	2049	2356
		240				11	877	2400	3101	1582	1,35	103,40	26,51	-	2196	2525
387	095	120	XX	YY	00	12	957	1200	1825	931	1,35	57,60	18,36	-	1415	1627
		140				12	957	1400	2101	1072	1,35	67,20	20,16	-	1572	1808
		160				12	957	1600	2369	1209	1,36	75,60	22,08	-	1732	1992
		180				12	957	1800	2628	1341	1,37	85,20	23,88	-	1888	2171
		200				12	957	2000	2880	1469	1,36	93,60	25,56	-	2049	2356
		220				12	957	2200	3126	1595	1,36	103,20	27,24	-	2204	2535
		240				12	957	2400	3366	1717	1,36	112,80	28,92	-	2365	2720
387	103	120	XX	YY	00	13	1037	1200	1972	1006	1,35	62,40	19,89	-	1609	1850
		140				13	1037	1400	2270	1158	1,36	72,80	21,84	-	1791	2060
		160				13	1037	1600	2558	1305	1,36	81,90	23,92	-	1973	2269
		180				13	1037	1800	2837	1447	1,37	92,30	25,87	-	2155	2478
		200				13	1037	2000	3109	1586	1,37	101,40	27,69	-	2339	2690
		220				13	1037	2200	3373	1721	1,36	111,80	29,51	-	2522	2900
		240				13	1037	2400	3631	1853	1,36	122,20	31,33	-	2706	3112

Conform EN442-1: 2014: radiatoren en convectoren

Voor meer details over onze artikel-data, zie artikel-database: <https://www.installdata.be>
Voor de warmteafgifte van andere regimes, kijkt u op p. 346 (correctiefactoren)
BELGIË. Prijzen in euro (excl. BTW)

VIOLA-A HORIZONTAAL (H1-RO-A, H1L1-RO-A, H2-RO-A, H2L1-RO-A, H2L2-RO-A)

TYPES

- H1-RO-A enkele rij buizen, H2-RO-A dubbele rij buizen, H1L1-RO-A, H2L1-RO-A, H2L2-RO-A (1 of 2 rijen stalen lamellen)

BUIZEN

- Horizontaal, rechthoekig 77 x 10 mm

COLLECTOREN

- H1-RO-A en H1L1-RO-A: 35 x 43 mm
- H2-RO-A en H2L1-RO-A: 35 x 41 mm
- H2L2-RO-A: 35 x 81 mm

KLEUREN

- Standaardkleur wit RAL 9016
- Uitgebreide kleurenkaart zie p. 12

SPECIAAL

- Bij types H1L1-RO-A / H2L1-RO-A en H2L2-RO-A zijn 1 of 2 rijen stalen lamellen ter verhoging van de warmteafgifte op de platovale buizen gepuntlast.
- Standaard met rooster.
- H1L1-RO-A ook verkrijgbaar als toiletradiator (500 x 400 mm)

BEVESTIGINGEN

- Muurbevestigingen standaard (inbegrepen in de verpakking van de radiator)
- Bovenste beugel in kleur van de radiator, onderaan:
 - Afstandshouder radiator wit = afstandshouder wit.
 - Afstandshouder radiator in kleur = afstandshouder RAL 7024.
- **H2-RO-A/H2L1-RO-A:** Radiator met telescopische steunvoeten + variabele muurbevestiging: gelieve bij bestelling code **07** aan te geven bij "Afwerking" (zie p. 224).
- **H2-RO-A/H2L1-RO-A:** Ook verkrijgbaar als vrijstaande radiator (zie p. 225)

TECHNISCH

- Weerstandsgelast (onzichtbare lasnaden)
- ATL-grondlaag, poedercoating
- Standaardwerkdruk: 4 bar. Meerprijs hogere werkdruk (10 bar): +10%.
- De leveringstermijn van radiator met een hogere werkdruk is 1 week extra.
- Maximale bedrijfstemperatuur: 110°C

ELEKTRISCH

- ✗ Zuiver elektrische radiator in de fabriek voorgevuld
- ✗ Gemengde radiator

TECHNISCHE TEKENINGEN

- Zie p. 229

AANSLUITING

- ✗ Eénpuntsaansluiting voor éénpijpsysteem
- ✗ Eénpuntsaansluiting voor tweepijpsysteem
- ✓ Tweepuntsaansluiting voor éénpijpsysteem (aansluiting via het geïntegreerd ventiel) (zie p. 341)
- ✓ Tweepuntsaansluiting voor tweepijpsysteem (standaard) (zie p. 340)
- ✓ Geïntegreerd ventiel (**meerprijs €110**) (radiator speciaal te bestellen) (zie p. 341)
- Aansluitingen: ½" (binnendraad)

AANBEVOLEN AANSLUITING

GEÏNTEGREERD VENTIEL (MEERPRIJS)

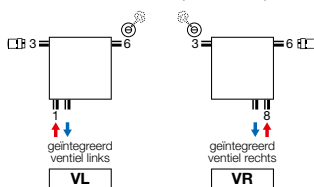

Meerprijs: €110 (zie p. 341)

Andere aansluitmogelijkheden, zie p. 227
Thermostaatkop apart te bestellen



art. nr. 1182 301 0000 0099

prijs €145

Koppelingen, zie p. 353



art. nr. 11911630102

prijs €44

Thermostaatkop apart te bestellen

AANBEVOLEN VOOR BADKAMER EN KEUKEN IN OPTIE

handdoekbeugel (RAL 9005)

art. nr. zie p. 226

prijs €145

Andere accessoires, zie p. 226



VIOLA-A HORIZONTAAL

In het verlengde van een grote traditie

Ook de Viola-A Horizontaal combineert, net als de Viola-A Verticaal een sobere, uniforme look met een optimale warmteafgifte. De radiator is beschikbaar in enkele en dubbele uitvoering. Het design is sober en overal toepasbaar. Kan ook in een vrijstaande opstelling worden geïnstalleerd.



H2-RO-A / H2L1-RO-A

VIOLA-A HORIZONTAAL (H1-RO-A)



H1-RO-A
(thermostaatkop apart te bestellen)

HOE VIOLA-A HORIZONTAAL BESTELLEN

Leveringstermijn 15 - 30 werkdagen
(zonder transportduur)

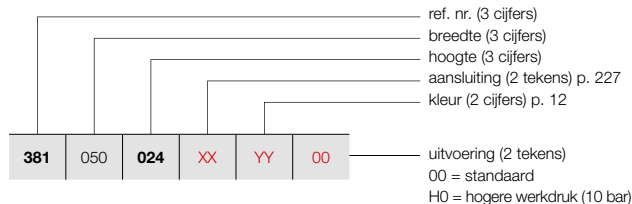

PRIJSGROEP: VPG2 - STAAL DESIGNRADIATOREN

BESTELCODE MAATWERK VIOLA-A HORIZONTAAL							TECHNISCHE GEGEVENS					STANDAARDKLEUR	ANDERE KLEUREN			
buizen	breedte (L mm)	hoogte (H mm)	75/65/20 (Watt) (Ø50K)	55/45/20 (Watt) (Ø30K)	n-exp.	gewicht (kg)	inhoud (l)	el. weerst. (Watt)	prijs RAL 9016 (€)	prijs kleur (€)						
REF. NR. VIOLA-A HORIZONTAAL H1-RO-A : 381																
381	050	024	XX	YY	00	3	500	240	141	72	1,25	3,15	1,00	-	242	278
		032				4	500	320	179	91	1,25	3,25	1,40	-	272	313
		040				5	500	400	223	114	1,26	5,50	1,70	-	306	352
		048				6	500	480	266	136	1,26	6,60	2,05	-	335	385
		056				7	500	560	310	158	1,26	7,70	2,40	-	367	422
		064				8	500	640	353	180	1,26	8,80	2,75	-	400	460
		072				9	500	720	396	202	1,26	9,90	3,10	-	433	498
		080				10	500	800	438	223	1,26	11,00	3,50	-	464	534
		088				11	500	880	481	245	1,27	12,10	3,85	-	498	573
381	060	024	XX	YY	00	3	600	240	169	86	1,25	3,78	1,20	-	259	298
		032				4	600	320	215	110	1,25	3,90	1,68	-	295	339
		040				5	600	400	267	136	1,26	6,60	2,04	-	329	378
		048				6	600	480	319	163	1,26	7,92	2,46	-	366	421
		056				7	600	560	371	189	1,26	9,24	2,88	-	403	463
		064				8	600	640	423	216	1,26	10,56	3,30	-	437	503
		072				9	600	720	475	242	1,26	11,88	3,72	-	473	544
		080				10	600	800	526	268	1,26	13,20	4,20	-	512	589
		088				11	600	880	577	294	1,27	14,52	4,62	-	545	627
381	070	024	XX	YY	00	3	700	240	197	100	1,25	4,41	1,40	-	281	323
		032				4	700	320	251	128	1,25	4,55	1,96	-	319	367
		040				5	700	400	312	159	1,26	7,70	2,38	-	360	414
		048				6	700	480	372	190	1,26	9,24	2,87	-	396	455
		056				7	700	560	433	221	1,26	10,78	3,36	-	436	501
		064				8	700	640	494	252	1,26	12,32	3,85	-	474	545
		072				9	700	720	554	283	1,26	13,86	4,34	-	515	592
		080				10	700	800	613	313	1,26	15,40	4,90	-	554	637
		088				11	700	880	673	343	1,27	16,94	5,39	-	594	683
381	080	024	XX	YY	00	3	800	240	225	115	1,25	5,04	1,60	-	298	343
		032				4	800	320	286	146	1,25	5,20	2,24	-	343	394
		040				5	800	400	356	182	1,26	8,80	2,72	-	384	442
		048				6	800	480	426	217	1,26	10,56	3,28	-	430	495
		056				7	800	560	495	253	1,26	12,32	3,84	-	471	542
		064				8	800	640	564	288	1,26	14,08	4,40	-	514	591
		072				9	800	720	633	323	1,26	15,84	4,96	-	556	639
		080				10	800	800	701	358	1,26	17,60	5,60	-	597	687
		088				11	800	880	769	392	1,27	19,36	6,16	-	642	738
381	090	024	XX	YY	00	3	900	240	253	129	1,25	5,67	1,80	-	319	367
		032				4	900	320	322	164	1,25	5,85	2,52	-	365	420
		040				5	900	400	401	204	1,26	9,90	3,06	-	409	470
		048				6	900	480	479	244	1,26	11,88	3,69	-	458	527
		056				7	900	560	557	284	1,26	13,86	4,32	-	508	584
		064				8	900	640	635	324	1,26	15,84	4,95	-	552	635
		072				9	900	720	712	363	1,26	17,82	5,58	-	596	685
		080				10	900	800	788	402	1,26	19,80	6,30	-	645	742
		088				11	900	880	865	441	1,27	21,78	6,93	-	689	792

Conform EN442-1: 2014: radiatoren en convectoren

Voor meer details over onze artikel-data, zie artikel-database: <https://www.installdata.be>

Voor de warmteafgifte van andere regimes, kijkt u op p. 346 (correctiefactoren)
BELGIË. Prijzen in euro (excl. BTW)

HOE VIOLA-A HORIZONTAAL BESTELLEN

Leveringstermijn 15 - 30 werkdagen
(zonder transportduur)

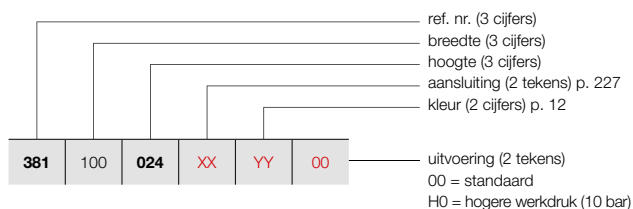

VIOLA-A HORIZONTAAL (H1-RO-A)



H1-RO-A
(thermostaatkop apart te bestellen)

PRIJSGROEP: VPG2 - STAAL DESIGNRADIATOREN

BESTELCODE MAATWERK VIOLA-A HORIZONTAAL	TECHNISCHE GEGEVENS							STANDAARDKLEUR	ANDERE KLEUREN							
	buizen	breedte (L mm)	hoogte (H mm)	75/65/20 (Watt) (Φ50K)	55/45/20 (Watt) (Φ30K)	n-exp.	gewicht (kg)			inhoud (l)	el. weerst. (Watt)	prijs RAL 9016 (€)	prijs kleur (€)			
REF. NR. VIOLA-A HORIZONTAAL H1-RO-A : 381																
381	100	024	XX	YY	00	3	1000	240	281	143	1,25	6,30	2,00	-	336	386
		032				4	1000	320	358	183	1,25	6,50	2,80	-	388	446
		040				5	1000	400	445	227	1,26	11,00	3,40	-	437	503
		048				6	1000	480	532	271	1,26	13,20	4,10	-	487	560
		056				7	1000	560	619	316	1,26	15,40	4,80	-	536	616
		064				8	1000	640	705	360	1,26	17,60	5,50	-	589	677
		072				9	1000	720	791	404	1,26	19,80	6,20	-	637	733
		080				10	1000	800	876	447	1,26	22,00	7,00	-	688	791
		088				11	1000	880	961	490	1,27	24,20	7,70	-	738	849
381	110	024	XX	YY	00	3	1100	240	309	158	1,25	6,93	2,20	-	360	414
		032				4	1100	320	394	201	1,25	7,15	3,08	-	409	470
		040				5	1100	400	490	250	1,26	12,10	3,74	-	464	534
		048				6	1100	480	585	299	1,26	14,52	4,51	-	519	597
		056				7	1100	560	681	347	1,26	16,94	5,28	-	572	658
		064				8	1100	640	776	396	1,26	19,36	6,05	-	624	718
		072				9	1100	720	870	444	1,26	21,78	6,82	-	683	785
		080				10	1100	800	964	492	1,26	24,20	7,70	-	733	843
		088				11	1100	880	1057	539	1,27	26,62	8,47	-	787	905
381	120	024	XX	YY	00	3	1200	240	337	172	1,25	7,56	2,40	-	376	432
		032				4	1200	320	430	219	1,25	7,80	3,36	-	434	499
		040				5	1200	400	534	272	1,26	13,20	4,08	-	490	564
		048				6	1200	480	638	326	1,26	15,84	4,92	-	551	634
		056				7	1200	560	743	379	1,26	18,48	5,76	-	607	698
		064				8	1200	640	846	432	1,26	21,12	6,60	-	663	762
		072				9	1200	720	949	484	1,26	23,76	7,44	-	723	831
		080				10	1200	800	1051	536	1,26	26,40	8,40	-	777	894
		088				11	1200	880	1153	588	1,27	29,04	9,24	-	835	960
381	140	024	XX	YY	00	3	1400	240	393	201	1,25	8,82	2,80	-	416	478
		032				4	1400	320	501	256	1,25	9,10	3,92	-	480	552
		040				5	1400	400	623	318	1,26	15,40	4,76	-	545	627
		048				6	1400	480	745	380	1,26	18,48	5,74	-	610	702
		056				7	1400	560	867	442	1,26	21,56	6,72	-	672	773
		064				8	1400	640	987	504	1,26	24,64	7,70	-	738	849
		072				9	1400	720	1107	565	1,26	27,72	8,68	-	801	921
		080				10	1400	800	1226	626	1,26	30,80	9,80	-	869	999
		088				11	1400	880	1345	686	1,27	33,88	10,78	-	932	1072
381	160	024	XX	YY	00	3	1600	240	450	229	1,25	10,08	3,20	-	455	523
		032				4	1600	320	573	292	1,25	10,40	4,48	-	526	605
		040				5	1600	400	712	363	1,26	17,60	5,44	-	597	687
		048				6	1600	480	851	434	1,26	21,12	6,56	-	670	771
		056				7	1600	560	990	505	1,26	24,64	7,68	-	743	854
		064				8	1600	640	1128	576	1,26	28,16	8,80	-	814	936
		072				9	1600	720	1266	646	1,26	31,68	9,92	-	885	1018
		080				10	1600	800	1402	715	1,26	35,20	11,20	-	956	1099
		088				11	1600	880	1538	784	1,27	38,72	12,32	-	1030	1185

Conform EN442-1: 2014: radiatoren en convectoren

Voor meer details over onze artikel-data, zie artikel-database: <https://www.installdata.be>

Voor de warmteafgiftes van andere regimes, kijkt u op p. 346 (correctiefactoren)
BELGIË. Prijzen in euro (excl. BTW)

VIOLA-A HORIZONTAAL (H1-RO-A)



H1-RO-A
(thermostaatkop apart te bestellen)

HOE VIOLA-A HORIZONTAAL BESTELLEN

Leveringstermijn 15 - 30 werkdagen
(zonder transportduur)

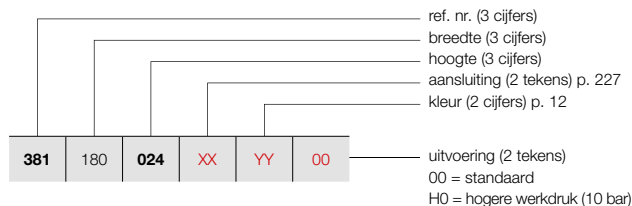

PRIJSGROEP: VPG2 - STAAL DESIGNRADIATOREN

BESTELCODE MAATWERK VIOLA-A HORIZONTAAL							TECHNISCHE GEGEVENS					STANDAARDKLEUR	ANDERE KLEUREN			
buizen	breedte (L mm)	hoogte (H mm)	75/65/20 (Watt) (Ø50K)	55/45/20 (Watt) (Ø30K)	n-exp.	gewicht (kg)	inhoud (l)	el. weerst. (Watt)	prijs RAL 9016 (€)	prijs kleur (€)						
REF. NR. VIOLA-A HORIZONTAAL H1-RO-A : 381																
381	180	024	XX	YY	00	3	1800	240	506	258	1,25	11,34	3,60	-	495	569
		032				4	1800	320	644	329	1,25	11,70	5,04	-	573	659
		040				5	1800	400	801	409	1,26	19,80	6,12	-	653	751
		048				6	1800	480	958	489	1,26	23,76	7,38	-	732	842
		056				7	1800	560	1114	568	1,26	27,72	8,64	-	810	932
		064				8	1800	640	1269	647	1,26	31,68	9,90	-	888	1021
		072				9	1800	720	1424	726	1,26	35,64	11,16	-	969	1114
		080				10	1800	800	1577	804	1,26	39,60	12,60	-	1047	1204
		088				11	1800	880	1730	883	1,27	43,56	13,86	-	1125	1294
381	200	024	XX	YY	00	3	2000	240	562	287	1,25	12,60	4,00	-	531	611
		032				4	2000	320	716	365	1,25	13,00	5,60	-	618	711
		040				5	2000	400	890	454	1,26	22,00	6,80	-	704	810
		048				6	2000	480	1064	543	1,26	26,40	8,20	-	791	910
		056				7	2000	560	1238	632	1,26	30,80	9,60	-	879	1011
		064				8	2000	640	1410	719	1,26	35,20	11,00	-	962	1106
		072				9	2000	720	1582	807	1,26	39,60	12,40	-	1049	1206
		080				10	2000	800	1752	894	1,26	44,00	14,00	-	1133	1303
		088				11	2000	880	1922	981	1,27	48,40	15,40	-	1218	1401
381	220	024	XX	YY	00	3	2200	240	618	315	1,25	13,86	4,40	-	572	658
		032				4	2200	320	788	402	1,25	14,30	6,16	-	666	766
		040				5	2200	400	979	499	1,26	24,20	7,48	-	759	873
		048				6	2200	480	1170	597	1,26	29,04	9,02	-	850	978
		056				7	2200	560	1362	695	1,26	33,88	10,56	-	947	1089
		064				8	2200	640	1551	791	1,26	38,72	12,10	-	1038	1194
		072				9	2200	720	1740	888	1,26	43,56	13,64	-	1131	1301
		080				10	2200	800	1927	983	1,26	48,40	15,40	-	1224	1408
		088				11	2200	880	2114	1079	1,27	53,24	16,94	-	1317	1515
381	240	024	XX	YY	00	3	2400	240	674	344	1,25	15,12	4,80	-	611	703
		032				4	2400	320	859	438	1,25	15,60	6,72	-	714	821
		040				5	2400	400	1068	545	1,26	26,40	8,16	-	814	936
		048				6	2400	480	1277	651	1,26	31,68	9,84	-	915	1052
		056				7	2400	560	1486	758	1,26	36,96	11,52	-	1013	1165
		064				8	2400	640	1692	863	1,26	42,24	13,20	-	1115	1282
		072				9	2400	720	1898	969	1,26	47,52	14,88	-	1213	1395
		080				10	2400	800	2102	1073	1,26	52,80	16,80	-	1314	1511
		088				11	2400	880	2306	1177	1,27	58,08	18,48	-	1414	1626
381	260	024	XX	YY	00	3	2600	240	731	373	1,25	16,38	5,20	-	651	749
		032				4	2600	320	931	475	1,25	16,90	7,28	-	758	872
		040				5	2600	400	1157	590	1,26	28,60	8,84	-	867	997
		048				6	2600	480	1383	706	1,26	34,32	10,66	-	974	1120
		056				7	2600	560	1609	821	1,26	40,04	12,48	-	1082	1244
		064				8	2600	640	1833	935	1,26	45,76	14,30	-	1188	1366
		072				9	2600	720	2057	1049	1,26	51,48	16,12	-	1296	1490
		080				10	2600	800	2278	1162	1,26	57,20	18,20	-	1406	1617
		088				11	2600	880	2499	1275	1,27	62,92	20,02	-	1511	1738

Conform EN442-1: 2014: radiatoren en convectoren

Voor meer details over onze artikel-data, zie artikel-database: <https://www.installdata.be>

Voor de warmteafgifte van andere regimes, kijkt u op p. 346 (correctiefactoren)
BELGIË. Prijzen in euro (excl. BTW)

HOE VIOLA-A HORIZONTAAL BESTELLEN

Leveringstermijn 15 - 30 werkdagen
(zonder transportduur)

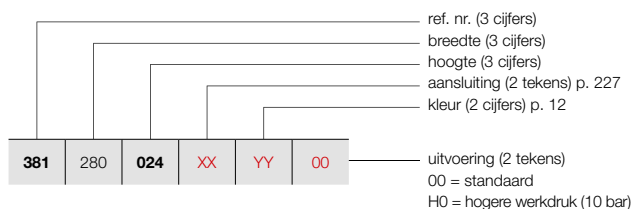

VIOLA-A HORIZONTAAL (H1-RO-A)



H1-RO-A
(thermostaatkop apart te bestellen)

PRIJSGROEP: VPG2 - STAAL DESIGNRADIATOREN

BESTELCODE MAATWERK VIOLA-A HORIZONTAAL	TECHNISCHE GEGEVENS							STANDAARDKLEUR		ANDERE KLEUREN	
	buizen	breedte (L mm)	hoogte (H mm)	75/65/20 (Watt) (Φ50K)	55/45/20 (Watt) (Φ30K)	n-exp.	gewicht (kg)	inhoud (l)	el. weerst. (Watt)	prijs RAL 9016 (€)	prijs kleur (€)
REF. NR. VIOLA-A HORIZONTAAL H1-RO-A : 381											
381	280	024	XX	YY	00						
		032								689	792
		040								804	925
		048								919	1057
		056								1035	1190
		064								1148	1320
		072								1264	1454
		080								1378	1585
		088								1493	1717
										1607	1848
381	300	024	XX	YY	00						
		032								729	838
		040								848	975
		048								973	1119
		056								1093	1257
		064								1215	1397
		072								1340	1541
		080								1458	1677
		088								1580	1817
										1704	1960

Conform EN442-1: 2014: radiatoren en convectoren

Voor meer details over onze artikel-data, zie artikel-database: <https://www.installdata.be>
Voor de warmteafgiftes van andere regimes, kijkt u op p. 346 (correctiefactoren)
BELGIË. Prijzen in euro (excl. BTW)

VIOLA-A HORIZONTAAL (H1L1-RO-A)



H1L1-RO-A
(thermostaatkop apart te bestellen)

HOE VIOLA-A HORIZONTAAL BESTELLEN

Leveringstermijn 15 - 30 werkdagen
(zonder transportduur)

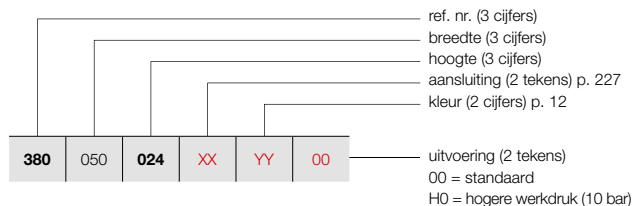

PRIJSGROEP: VPG2 - STAAL DESIGNRADIATOREN

BESTELCODE MAATWERK VIOLA-A HORIZONTAAL							TECHNISCHE GEGEVENS					STANDAARDKLEUR	ANDERE KLEUREN			
buizen	breedte (L mm)	hoogte (H mm)	75/65/20 (Watt) (Φ50K)	55/45/20 (Watt) (Φ30K)	n-exp.	gewicht (kg)	inhoud (l)	el. weerst. (Watt)	prijs RAL 9016 (€)	prijs kleur (€)						
REF. NR. VIOLA-A HORIZONTAAL H1L1-RO-A : 380																
380	050	024	XX	YY	00	3	500	240	261	133	1,24	5,45	1,00	-	278	320
		032				4	500	320	334	170	1,26	7,30	1,40	-	318	366
		040				5	500	400	399	204	1,27	9,10	1,70	-	361	415
		048				6	500	480	464	237	1,28	10,95	2,05	-	401	461
		056				7	500	560	530	270	1,30	12,75	2,40	-	445	512
		064				8	500	640	581	296	1,30	14,60	2,75	-	485	558
		072				9	500	720	618	315	1,30	15,70	3,10	-	527	606
		080				10	500	800	684	349	1,31	18,25	3,50	-	571	657
		088				11	500	880	719	367	1,31	19,35	3,85	-	611	703
380	060	024	XX	YY	00	3	600	240	313	160	1,24	6,54	1,20	-	302	347
		032				4	600	320	401	204	1,26	8,76	1,68	-	354	407
		040				5	600	400	479	244	1,27	10,92	2,04	-	399	459
		048				6	600	480	557	284	1,28	13,14	2,46	-	446	513
		056				7	600	560	635	324	1,30	15,30	2,88	-	490	564
		064				8	600	640	697	356	1,30	17,52	3,30	-	539	620
		072				9	600	720	741	378	1,30	18,84	3,72	-	589	677
		080				10	600	800	821	419	1,31	21,90	4,20	-	635	730
		088				11	600	880	863	440	1,31	23,22	4,62	-	685	788
380	070	024	XX	YY	00	3	700	240	365	186	1,24	7,63	1,40	-	328	377
		032				4	700	320	468	239	1,26	10,22	1,96	-	382	439
		040				5	700	400	559	285	1,27	12,74	2,38	-	436	501
		048				6	700	480	650	331	1,28	15,33	2,87	-	488	561
		056				7	700	560	741	378	1,30	17,85	3,36	-	541	622
		064				8	700	640	813	415	1,30	20,44	3,85	-	594	683
		072				9	700	720	865	441	1,30	21,98	4,34	-	649	746
		080				10	700	800	958	489	1,31	25,55	4,90	-	699	804
		088				11	700	880	1007	514	1,31	27,09	5,39	-	753	866
380	080	024	XX	YY	00	3	800	240	418	213	1,24	8,72	1,60	-	359	413
		032				4	800	320	534	273	1,26	11,68	2,24	-	416	478
		040				5	800	400	638	326	1,27	14,56	2,72	-	473	544
		048				6	800	480	742	379	1,28	17,52	3,28	-	530	610
		056				7	800	560	847	432	1,30	20,40	3,84	-	592	681
		064				8	800	640	930	474	1,30	23,36	4,40	-	650	748
		072				9	800	720	988	504	1,30	25,12	4,96	-	708	814
		080				10	800	800	1094	558	1,31	29,20	5,60	-	766	881
		088				11	800	880	1150	587	1,31	30,96	6,16	-	825	949
380	090	024	XX	YY	00	3	900	240	470	240	1,24	9,81	1,80	-	384	442
		032				4	900	320	601	307	1,26	13,14	2,52	-	449	516
		040				5	900	400	718	366	1,27	16,38	3,06	-	513	590
		048				6	900	480	835	426	1,28	19,71	3,69	-	575	661
		056				7	900	560	953	486	1,30	22,95	4,32	-	640	736
		064				8	900	640	1046	534	1,30	26,28	4,95	-	703	808
		072				9	900	720	1112	567	1,30	28,26	5,58	-	767	882
		080				10	900	800	1231	628	1,31	32,85	6,30	-	833	958
		088				11	900	880	1294	660	1,31	34,83	6,93	-	896	1030

Conform EN442-1: 2014: radiatoren en convectoren

Voor meer details over onze artikel-data, zie artikel-database: <https://www.installdata.be>

Voor de warmteafgifte van andere regimes, kijkt u op p. 346 (correctiefactoren)
BELGIË. Prijzen in euro (excl. BTW)

HOE VIOLA-A HORIZONTAAL BESTELLEN

Leveringstermijn 15 - 30 werkdagen
(zonder transportduur)

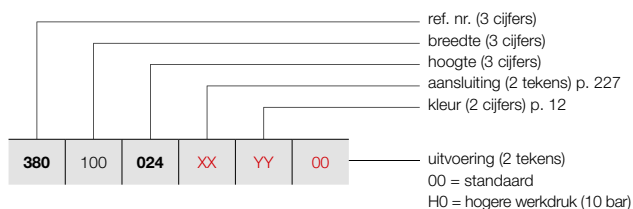

VIOLA-A HORIZONTAAL (H1L1-RO-A)



H1L1-RO-A
(thermostaatkop apart te bestellen)

PRIJSGROEP: VPG2 - STAAL DESIGNRADIATOREN

BESTELCODE MAATWERK VIOLA-A HORIZONTAAL	TECHNISCHE GEGEVENS							STANDAARDKLEUR	ANDERE KLEUREN			
	buizen	breedte (L mm)	hoogte (H mm)	75/65/20 (Watt) (φ50K)	55/45/20 (Watt) (φ30K)	n-exp.	gewicht (kg)			inhoud (l)	el. weerst. (Watt)	prijs RAL 9016 (€)
REF. NR. VIOLA-A HORIZONTAAL H1L1-RO-A : 380												
380 100 024 XX YY 00	3	1000	240	522	266	1,24	10,90	2,00	-	409	470	
	4	1000	320	668	341	1,26	14,60	2,80	-	478	550	
	5	1000	400	798	407	1,27	18,20	3,40	-	552	635	
	6	1000	480	928	473	1,28	21,90	4,10	-	618	711	
	7	1000	560	1059	540	1,30	25,50	4,80	-	688	791	
	8	1000	640	1162	593	1,30	29,20	5,50	-	758	872	
	9	1000	720	1235	630	1,30	31,40	6,20	-	827	951	
	10	1000	800	1368	698	1,31	36,50	7,00	-	896	1030	
	11	1000	880	1438	734	1,31	38,70	7,70	-	968	1113	
	380 110 024 XX YY 00	3	1100	240	574	293	1,24	11,99	2,20	-	437	503
		4	1100	320	735	375	1,26	16,06	3,08	-	514	591
5		1100	400	878	448	1,27	20,02	3,74	-	589	677	
6		1100	480	1021	521	1,28	24,09	4,51	-	663	762	
7		1100	560	1165	594	1,30	28,05	5,28	-	738	849	
8		1100	640	1278	652	1,30	32,12	6,05	-	814	936	
9		1100	720	1359	693	1,30	34,54	6,82	-	886	1019	
10		1100	800	1505	768	1,31	40,15	7,70	-	961	1105	
11		1100	880	1582	807	1,31	42,57	8,47	-	1036	1191	
380 120 024 XX YY 00		3	1200	240	626	320	1,24	13,08	2,40	-	465	535
		4	1200	320	802	409	1,26	17,52	3,36	-	545	627
	5	1200	400	958	489	1,27	21,84	4,08	-	624	718	
	6	1200	480	1114	568	1,28	26,28	4,92	-	706	812	
	7	1200	560	1271	648	1,30	30,60	5,76	-	787	905	
	8	1200	640	1394	711	1,30	35,04	6,60	-	867	997	
	9	1200	720	1482	756	1,30	37,68	7,44	-	948	1090	
	10	1200	800	1642	838	1,31	43,80	8,40	-	1029	1183	
	11	1200	880	1726	880	1,31	46,44	9,24	-	1108	1274	
	380 140 024 XX YY 00	3	1400	240	731	373	1,24	15,26	2,80	-	519	597
		4	1400	320	935	477	1,26	20,44	3,92	-	611	703
5		1400	400	1117	570	1,27	25,48	4,76	-	700	805	
6		1400	480	1299	663	1,28	30,66	5,74	-	793	912	
7		1400	560	1483	756	1,30	35,70	6,72	-	885	1018	
8		1400	640	1627	830	1,30	40,88	7,70	-	975	1121	
9		1400	720	1729	882	1,30	43,96	8,68	-	1065	1225	
10		1400	800	1915	977	1,31	51,10	9,80	-	1160	1334	
11		1400	880	2013	1027	1,31	54,18	10,78	-	1248	1435	
380 160 024 XX YY 00		3	1600	240	835	426	1,24	17,44	3,20	-	573	659
		4	1600	320	1069	545	1,26	23,36	4,48	-	675	776
	5	1600	400	1277	651	1,27	29,12	5,44	-	777	894	
	6	1600	480	1485	758	1,28	35,04	6,56	-	881	1013	
	7	1600	560	1694	864	1,30	40,80	7,68	-	984	1132	
	8	1600	640	1859	949	1,30	46,72	8,80	-	1084	1247	
	9	1600	720	1976	1008	1,30	50,24	9,92	-	1187	1365	
	10	1600	800	2189	1117	1,31	58,40	11,20	-	1286	1479	
	11	1600	880	2301	1174	1,31	61,92	12,32	-	1392	1601	

Conform EN442-1: 2014: radiatoren en convectoren

Voor meer details over onze artikel-data, zie artikel-database: <https://www.installdata.be>

Voor de warmteafgiftes van andere regimes, kijkt u op p. 346 (correctiefactoren)
BELGIË. Prijzen in euro (excl. BTW)

VIOLA-A HORIZONTAAL (H1L1-RO-A)



H1L1-RO-A
(thermostaatkop apart te bestellen)

HOE VIOLA-A HORIZONTAAL BESTELLEN

Leveringstermijn 15 - 30 werkdagen
(zonder transportduur)

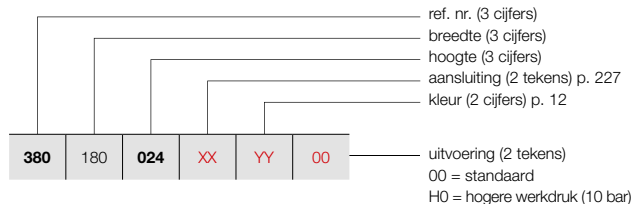

PRIJSGROEP: VPG2 - STAAL DESIGNRADIATOREN

BESTELCODE MAATWERK VIOLA-A HORIZONTAAL							TECHNISCHE GEGEVENS					STANDAARDKLEUR	ANDERE KLEUREN					
buizen	breedte (L mm)	hoogte (H mm)	75/65/20 (Watt) (Ø50K)	55/45/20 (Watt) (Ø30K)	n-exp.	gewicht (kg)	inhoud (l)	el. weerst. (Watt)	prijs RAL 9016 (€)	prijs kleur (€)								
REF. NR. VIOLA-A HORIZONTAAL H1L1-RO-A : 380																		
380	180	024	XX	YY	00	3	1800	240	940	479	1,24	19,62	3,60	-	625	719		
		032				4	1800	320	1202	613	1,26	26,28	5,04	-	740	851		
		040				5	1800	400	1436	733	1,27	32,76	6,12	-	851	979		
		048				6	1800	480	1670	852	1,28	39,42	7,38	-	968	1113		
		056				7	1800	560	1906	973	1,30	45,90	8,64	-	1082	1244		
		064				8	1800	640	2092	1067	1,30	52,56	9,90	-	1194	1373		
		072				9	1800	720	2223	1134	1,30	56,52	11,16	-	1308	1504		
		080				10	1800	800	2462	1256	1,31	65,70	12,60	-	1417	1630		
		088				11	1800	880	2588	1321	1,31	69,66	13,86	-	1531	1761		
		380	200	024	XX	YY	00	3	2000	240	1044	533	1,24	21,80	4,00	-	684	787
				032				4	2000	320	1336	682	1,26	29,20	5,60	-	804	925
040						5	2000	400	1596	814	1,27	36,40	6,80	-	931	1071		
048						6	2000	480	1856	947	1,28	43,80	8,20	-	1053	1211		
056						7	2000	560	2118	1081	1,30	51,00	9,60	-	1178	1355		
064						8	2000	640	2324	1186	1,30	58,40	11,00	-	1305	1501		
072						9	2000	720	2470	1260	1,30	62,80	12,40	-	1427	1641		
080						10	2000	800	2736	1396	1,31	73,00	14,00	-	1548	1780		
088						11	2000	880	2876	1467	1,31	77,40	15,40	-	1675	1926		
380	220			024	XX	YY	00	3	2200	240	1148	586	1,24	23,98	4,40	-	737	848
				032				4	2200	320	1470	750	1,26	32,12	6,16	-	872	1003
		040				5	2200	400	1756	896	1,27	40,04	7,48	-	1007	1158		
		048				6	2200	480	2042	1042	1,28	48,18	9,02	-	1139	1310		
		056				7	2200	560	2330	1189	1,30	56,10	10,56	-	1275	1466		
		064				8	2200	640	2556	1304	1,30	64,24	12,10	-	1410	1622		
		072				9	2200	720	2717	1386	1,30	69,08	13,64	-	1545	1777		
		080				10	2200	800	3010	1536	1,31	80,30	15,40	-	1679	1931		
		088				11	2200	880	3164	1614	1,31	85,14	16,94	-	1815	2087		
		380	240	024	XX	YY	00	3	2400	240	1253	639	1,24	26,16	4,80	-	789	907
				032				4	2400	320	1603	818	1,26	35,04	6,72	-	934	1074
040						5	2400	400	1915	977	1,27	43,68	8,16	-	1083	1245		
048						6	2400	480	2227	1136	1,28	52,56	9,84	-	1228	1412		
056						7	2400	560	2542	1297	1,30	61,20	11,52	-	1372	1578		
064						8	2400	640	2789	1423	1,30	70,08	13,20	-	1521	1749		
072						9	2400	720	2964	1512	1,30	75,36	14,88	-	1666	1916		
080						10	2400	800	3283	1675	1,31	87,60	16,80	-	1810	2082		
088						11	2400	880	3451	1761	1,31	92,88	18,48	-	1958	2252		
380	260			024	XX	YY	00	3	2600	240	1357	692	1,24	28,34	5,20	-	842	968
				032				4	2600	320	1737	886	1,26	37,96	7,28	-	998	1148
		040				5	2600	400	2075	1059	1,27	47,32	8,84	-	1159	1333		
		048				6	2600	480	2413	1231	1,28	56,94	10,66	-	1314	1511		
		056				7	2600	560	2753	1405	1,30	66,30	12,48	-	1471	1692		
		064				8	2600	640	3021	1541	1,30	75,92	14,30	-	1626	1870		
		072				9	2600	720	3211	1638	1,30	81,64	16,12	-	1786	2054		
		080				10	2600	800	3557	1815	1,31	94,90	18,20	-	1941	2232		
		088				11	2600	880	3739	1908	1,31	100,62	20,02	-	2098	2413		

Conform EN442-1: 2014: radiatoren en convectoren

Voor meer details over onze artikel-data, zie artikel-database: <https://www.installdata.be>

Voor de warmteafgifte van andere regimes, kijkt u op p. 346 (correctiefactoren)
BELGIË. Prijzen in euro (excl. BTW)

HOE VIOLA-A HORIZONTAAL BESTELLEN

Leveringstermijn 15 - 30 werkdagen
(zonder transportduur)

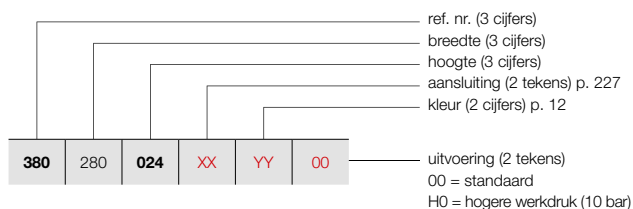

VIOLA-A HORIZONTAAL (H1L1-RO-A)



H1L1-RO-A
(thermostaatkop apart te bestellen)

PRIJSGROEP: VPG2 - STAAL DESIGNRADIATOREN

BESTELCODE MAATWERK VIOLA-A HORIZONTAAL	TECHNISCHE GEGEVENS									STANDAARDKLEUR	ANDERE KLEUREN					
	buizen	breedte (L mm)	hoogte (H mm)	75/65/20 (Watt) (Φ50K)	55/45/20 (Watt) (Φ30K)	n-exp.	gewicht (kg)	inhoud (l)	el. weerst. (Watt)	prijs RAL 9016 (€)	prijs kleur (€)					
REF. NR. VIOLA-A HORIZONTAAL H1L1-RO-A : 380																
380	280	024	XX	YY	00	3	2800	240	1462	746	1,24	30,52	5,60	-	897	1032
		032				4	2800	320	1870	954	1,26	40,88	7,84	-	1065	1225
		040				5	2800	400	2234	1140	1,27	50,96	9,52	-	1233	1418
		048				6	2800	480	2598	1326	1,28	61,32	11,48	-	1400	1610
		056				7	2800	560	2965	1513	1,30	71,40	13,44	-	1570	1806
		064				8	2800	640	3254	1660	1,30	81,76	15,40	-	1737	1998
		072				9	2800	720	3458	1764	1,30	87,92	17,36	-	1906	2192
		080				10	2800	800	3830	1954	1,31	102,20	19,60	-	2073	2384
		088				11	2800	880	4026	2054	1,31	108,36	21,56	-	2240	2576
380	300	024	XX	YY	00	3	3000	240	1566	799	1,24	32,70	6,00	-	953	1096
		032				4	3000	320	2004	1022	1,26	43,80	8,40	-	1130	1300
		040				5	3000	400	2394	1221	1,27	54,60	10,20	-	1311	1508
		048				6	3000	480	2784	1420	1,28	65,70	12,30	-	1489	1712
		056				7	3000	560	3177	1621	1,30	76,50	14,40	-	1668	1918
		064				8	3000	640	3486	1779	1,30	87,60	16,50	-	1844	2121
		072				9	3000	720	3705	1890	1,30	94,20	18,60	-	2025	2329
		080				10	3000	800	4104	2094	1,31	109,50	21,00	-	2201	2531
		088				11	3000	880	4314	2201	1,31	116,10	23,10	-	2379	2736

Conform EN442-1: 2014: radiatoren en convectoren

Voor meer details over onze artikel-data, zie artikel-database: <https://www.installdata.be>
Voor de warmteafgiftes van andere regimes, kijkt u op p. 346 (correctiefactoren)
BELGIË. Prijzen in euro (excl. BTW)

VIOLA-A HORIZONTAAL (H2-RO-A)



H2-RO-A
(thermostaatkop apart te bestellen)

HOE VIOLA-A HORIZONTAAL BESTELLEN

Leveringstermijn 15 - 30 werkdagen
(zonder transportduur)

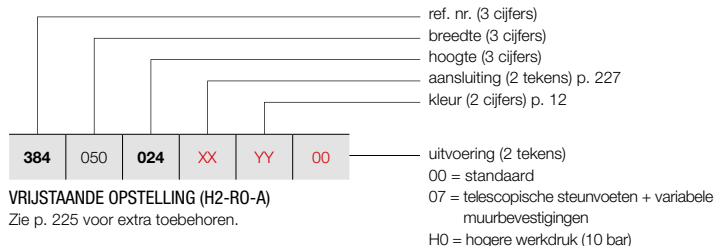

VRIJSTAANDE OPSTELLING (H2-RO-A)

Zie p. 225 voor extra toebehoren.

PRIJSGROEP: VPG2 - STAAL DESIGNRADIATOREN

BESTELCODE MAATWERK VIOLA-A HORIZONTAAL	TECHNISCHE GEGEVENS									STANDAARDKLEUR	ANDERE KLEUREN
	buizen	breedte (L mm)	hoogte (H mm)	75/65/20 (Watt) (Φ50K)	55/45/20 (Watt) (Φ30K)	n-exp.	gewicht (kg)	inhoud (l)	el. weerst. (Watt)	prijs RAL 9016 (€)	prijs kleur (€)
REF. NR. VIOLA-A HORIZONTAAL H2-RO-A : 384											
384	050	024	XX	YY	00						
		032								455	523
		040								519	597
		048								584	672
		056								649	746
		064								712	819
		072								775	891
		080								838	964
		088								903	1038
										969	1114
384	060	024	XX	YY	00						
		032								488	561
		040								561	645
		048								629	723
		056								703	808
		064								773	889
		072								843	969
		080								917	1055
		088								988	1136
										1056	1214
384	070	024	XX	YY	00						
		032								523	601
		040								604	695
		048								683	785
		056								758	872
		064								836	961
		072								917	1055
		080								994	1143
		088								1072	1233
										1150	1323
384	080	024	XX	YY	00						
		032								558	642
		040								644	741
		048								729	838
		056								815	937
		064								899	1034
		072								986	1134
		080								1071	1232
		088								1159	1333
										1242	1428
384	090	024	XX	YY	00						
		032								592	681
		040								686	789
		048								777	894
		056								870	1001
		064								962	1106
		072								1054	1212
		080								1147	1319
		088								1242	1428
										1336	1536

Conform EN442-1: 2014: radiatoren en convectoren

Voor meer details over onze artikel-data, zie artikel-database: <https://www.installdata.be>

Voor de warmteafgiftes van andere regimes, kijkt u op p. 346 (correctiefactoren)
BELGIË. Prijzen in euro (excl. BTW)

HOE VIOLA-A HORIZONTAAL BESTELLEN

Leveringstermijn 15 - 30 werkdagen
(zonder transportduur)

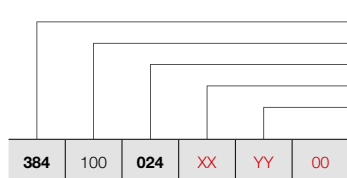

ref. nr. (3 cijfers)
breedte (3 cijfers)
hoogte (3 cijfers)
aansluiting (2 tekens) p. 227
kleur (2 cijfers) p. 12

VRIJSTAANDE OPSTELLING (H2-RO-A)

Zie p. 225 voor extra toebehoren.

uitvoering (2 tekens)
00 = standaard
07 = telescopische steunvoeten + variabele
muurbevestigingen
H0 = hogere werkdruk (10 bar)

VIOLA-A HORIZONTAAL (H2-RO-A)



H2-RO-A
(thermostaatkop apart te bestellen)

PRIJSGROEP: VPG2 - STAAL DESIGNRADIATOREN

BESTELCODE MAATWERK VIOLA-A HORIZONTAAL	TECHNISCHE GEGEVENS							STANDAARDKLEUR	ANDERE KLEUREN			
	buizen	breedte (L mm)	hoogte (H mm)	75/65/20 (Watt) (φ50K)	55/45/20 (Watt) (φ30K)	n-exp.	gewicht (kg)			inhoud (l)	el. weerst. (Watt)	prijs RAL 9016 (€)
REF. NR. VIOLA-A HORIZONTAAL H2-RO-A : 384												
384 100 024 XX YY 00	3	1000	240	436	222	1,23	12,20	3,40	-	624	718	
	4	1000	320	545	278	1,22	16,30	4,50	-	727	836	
	5	1000	400	658	336	1,23	20,30	5,70	-	826	950	
	6	1000	480	778	397	1,25	24,40	6,90	-	923	1061	
	7	1000	560	907	463	1,26	28,50	8,10	-	1028	1182	
	8	1000	640	1046	534	1,27	32,50	9,30	-	1126	1295	
	9	1000	720	1199	612	1,28	36,60	10,50	-	1226	1410	
	10	1000	800	1325	676	1,28	40,70	11,40	-	1322	1520	
	11	1000	880	1451	740	1,29	44,70	12,40	-	1425	1639	
	384 110 024 XX YY 00	3	1100	240	480	245	1,23	13,42	3,74	-	660	759
		4	1100	320	600	306	1,22	17,93	4,95	-	766	881
5		1100	400	724	369	1,23	22,33	6,27	-	876	1007	
6		1100	480	856	437	1,25	26,84	7,59	-	980	1127	
7		1100	560	998	509	1,26	31,35	8,91	-	1088	1251	
8		1100	640	1151	587	1,27	35,75	10,23	-	1196	1375	
9		1100	720	1319	673	1,28	40,26	11,55	-	1305	1501	
10		1100	800	1458	744	1,28	44,77	12,54	-	1409	1620	
11		1100	880	1596	814	1,29	49,17	13,64	-	1515	1742	
384 120 024 XX YY 00		3	1200	240	523	267	1,23	14,64	4,08	-	691	795
		4	1200	320	654	334	1,22	19,56	5,40	-	805	926
	5	1200	400	790	403	1,23	24,36	6,84	-	921	1059	
	6	1200	480	934	476	1,25	29,28	8,28	-	1036	1191	
	7	1200	560	1088	555	1,26	34,20	9,72	-	1150	1323	
	8	1200	640	1255	640	1,27	39,00	11,16	-	1265	1455	
	9	1200	720	1439	734	1,28	43,92	12,60	-	1378	1585	
	10	1200	800	1590	811	1,28	48,84	13,68	-	1493	1717	
	11	1200	880	1741	888	1,29	53,64	14,88	-	1607	1848	
	384 140 024 XX YY 00	3	1400	240	610	311	1,23	17,08	4,76	-	760	874
		4	1400	320	763	389	1,22	22,82	6,30	-	889	1022
5		1400	400	921	470	1,23	28,42	7,98	-	1017	1170	
6		1400	480	1089	556	1,25	34,16	9,66	-	1147	1319	
7		1400	560	1270	648	1,26	39,90	11,34	-	1275	1466	
8		1400	640	1464	747	1,27	45,50	13,02	-	1406	1617	
9		1400	720	1679	856	1,28	51,24	14,70	-	1533	1763	
10		1400	800	1855	946	1,28	56,98	15,96	-	1661	1910	
11		1400	880	2031	1036	1,29	62,58	17,36	-	1790	2059	
384 160 024 XX YY 00		3	1600	240	698	356	1,23	19,52	5,44	-	831	956
		4	1600	320	872	445	1,22	26,08	7,20	-	973	1119
	5	1600	400	1053	537	1,23	32,48	9,12	-	1117	1285	
	6	1600	480	1245	635	1,25	39,04	11,04	-	1259	1448	
	7	1600	560	1451	740	1,26	45,60	12,96	-	1400	1610	
	8	1600	640	1674	854	1,27	52,00	14,88	-	1544	1776	
	9	1600	720	1918	979	1,28	58,56	16,80	-	1686	1939	
	10	1600	800	2120	1082	1,28	65,12	18,24	-	1832	2107	
	11	1600	880	2322	1184	1,29	71,52	19,84	-	1972	2268	

Conform EN442-1: 2014: radiatoren en convectoren

Voor meer details over onze artikel-data, zie artikel-database: <https://www.installdata.be>

Voor de warmteafgiftes van andere regimes, kijkt u op p. 346 (correctiefactoren)
BELGIË. Prijzen in euro (excl. BTW)

VIOLA-A HORIZONTAAL (H2-RO-A)



H2-RO-A
(thermostaatkop apart te bestellen)

HOE VIOLA-A HORIZONTAAL BESTELLEN

Leveringstermijn 15 - 30 werkdagen
(zonder transportduur)

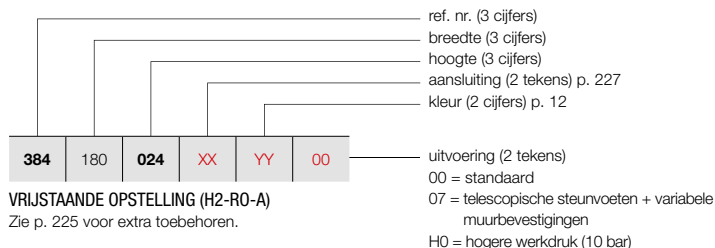

VRIJSTAANDE OPSTELLING (H2-RO-A)

Zie p. 225 voor extra toebehoren.

PRIJSGROEP: VPG2 - STAAL DESIGNRADIATOREN

BESTELCODE MAATWERK VIOLA-A HORIZONTAAL	TECHNISCHE GEGEVENS									STANDAARDKLEUR	ANDERE KLEUREN
	buizen	breedte (L mm)	hoogte (H mm)	75/65/20 (Watt) (Φ50K)	55/45/20 (Watt) (Φ30K)	n-exp.	gewicht (kg)	inhoud (l)	el. weerst. (Watt)	prijs RAL 9016 (€)	prijs kleur (€)
REF. NR. VIOLA-A HORIZONTAAL H2-RO-A : 384											
384	180	024	XX	YY	00						
		032								896	1030
		040								1053	1211
		048								1211	1393
		056								1368	1573
		064								1526	1755
		072								1684	1937
		080								1839	2115
		088								2000	2300
										2154	2477
384	200	024	XX	YY	00						
		032								966	1111
		040								1134	1304
		048								1310	1507
		056								1482	1704
		064								1652	1900
		072								1825	2099
		080								1997	2297
		088								2168	2493
										2339	2690
384	220	024	XX	YY	00						
		032								1032	1187
		040								1216	1398
		048								1407	1618
		056								1591	1830
		064								1777	2044
		072								1965	2260
		080								2149	2471
		088								2334	2684
										2522	2900
384	240	024	XX	YY	00						
		032								1101	1266
		040								1299	1494
		048								1500	1725
		056								1702	1957
		064								1904	2190
		072								2102	2417
		080								2303	2648
		088								2506	2882
										2704	3110
384	260	024	XX	YY	00						
		032								1166	1341
		040								1386	1594
		048								1598	1838
		056								1814	2086
		064								2028	2332
		072								2244	2581
		080								2457	2826
		088								2672	3073
										2887	3320

Conform EN442-1: 2014: radiatoren en convectoren

Voor meer details over onze artikel-data, zie artikel-database: <https://www.installdata.be>

Voor de warmteafgiftes van andere regimes, kijkt u op p. 346 (correctiefactoren)
BELGIË. Prijzen in euro (excl. BTW)

HOE VIOLA-A HORIZONTAAL BESTELLEN

Leveringstermijn 15 - 30 werkdagen
(zonder transportduur)

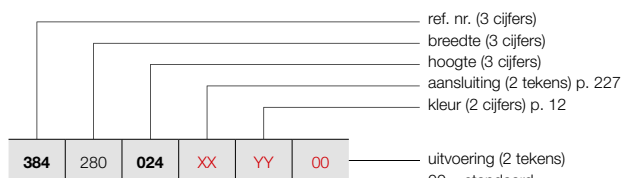

VRIJSTAANDE OPSTELLING (H2-RO-A)

Zie p. 225 voor extra toebehoren.

00 = standaard
 07 = telescopische steunvoeten + variabele muurbevestigingen
 H0 = hogere werkdruk (10 bar)

VIOLA-A HORIZONTAAL (H2-RO-A)



H2-RO-A
(thermostaatkop apart te bestellen)

PRIJSGROEP: VPG2 - STAAL DESIGNRADIATOREN

BESTELCODE MAATWERK VIOLA-A HORIZONTAAL	TECHNISCHE GEGEVENS							STANDAARDKLEUR		ANDERE KLEUREN	
	buizen	breedte (L mm)	hoogte (H mm)	75/65/20 (Watt) (φ50K)	55/45/20 (Watt) (φ30K)	n-exp.	gewicht (kg)	inhoud (l)	el. weerst. (Watt)	prijs RAL 9016 (€)	prijs kleur (€)
REF. NR. VIOLA-A HORIZONTAAL H2-RO-A : 384											
384	280	024	XX	YY	00						
		032								1236	1421
		040								1464	1684
		048								1693	1947
		056								1923	2211
		064								2151	2474
		072								2381	2738
		080								2611	3003
		088								2841	3267
										3069	3529
384	300	024	XX	YY	00						
		032								1306	1502
		040								1547	1779
		048								1791	2060
		056								2037	2343
		064								2281	2623
		072								2522	2900
		080								2764	3179
		088								3009	3460
										3254	3742

Conform EN442-1: 2014: radiatoren en convectoren

Voor meer details over onze artikel-data, zie artikel-database: <https://www.installdata.be>
Voor de warmteafgiftes van andere regimes, kijkt u op p. 346 (correctiefactoren)
BELGIË. Prijzen in euro (excl. BTW)

VIOLA-A HORIZONTAAL (H2L1-RO-A)



H2L1-RO-A
(thermostaatkop apart te bestellen)

HOE VIOLA-A HORIZONTAAL BESTELLEN

Leveringstermijn 15 - 30 werkdagen
(zonder transportduur)

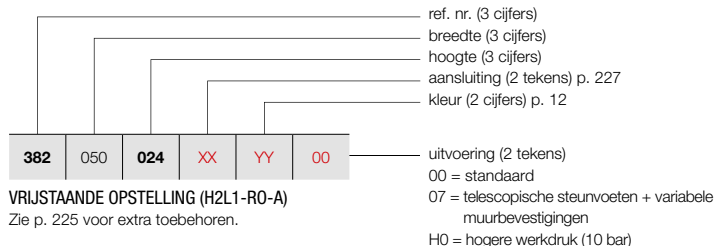

VRIJSTAANDE OPSTELLING (H2L1-RO-A)
 Zie p. 225 voor extra toebehoren.

PRIJSGROEP: VPG2 - STAAL DESIGNRADIATOREN

BESTELCODE MAATWERK VIOLA-A HORIZONTAAL							TECHNISCHE GEGEVENS					STANDAARDKLEUR	ANDERE KLEUREN			
buizen	breedte (L mm)	hoogte (H mm)	75/65/20 (Watt) (Φ50K)	55/45/20 (Watt) (Φ30K)	n-exp.	gewicht (kg)	inhoud (l)	el. weerst. (Watt)	prijs RAL 9016 (€)	prijs kleur (€)						
REF. NR. VIOLA-A HORIZONTAAL H2L1-RO-A : 382																
382	050	024	XX	YY	00	3	500	240	322	164	1,28	7,75	1,70	-	509	585
		032				4	500	320	399	204	1,30	10,35	2,25	-	588	676
		040				5	500	400	474	242	1,32	12,90	2,85	-	667	767
		048				6	500	480	550	280	1,34	15,50	3,45	-	750	863
		056				7	500	560	625	319	1,36	18,10	4,05	-	832	957
		064				8	500	640	677	345	1,36	20,65	4,65	-	912	1049
		072				9	500	720	728	371	1,36	23,25	5,25	-	990	1139
		080				10	500	800	780	398	1,37	25,80	5,70	-	1072	1233
		088				11	500	880	822	419	1,36	27,85	6,20	-	1153	1326
382	060	024	XX	YY	00	3	600	240	386	197	1,28	9,30	2,04	-	545	627
		032				4	600	320	479	244	1,30	12,42	2,70	-	635	730
		040				5	600	400	569	290	1,32	15,48	3,42	-	726	835
		048				6	600	480	659	336	1,34	18,60	4,14	-	815	937
		056				7	600	560	749	382	1,36	21,72	4,86	-	903	1038
		064				8	600	640	812	414	1,36	24,78	5,58	-	991	1140
		072				9	600	720	874	446	1,36	27,90	6,30	-	1084	1247
		080				10	600	800	936	478	1,37	30,96	6,84	-	1172	1348
		088				11	600	880	986	503	1,36	33,42	7,44	-	1263	1452
382	070	024	XX	YY	00	3	700	240	450	230	1,28	10,85	2,38	-	586	674
		032				4	700	320	559	285	1,30	14,49	3,15	-	685	788
		040				5	700	400	664	339	1,32	18,06	3,99	-	782	899
		048				6	700	480	769	393	1,34	21,70	4,83	-	881	1013
		056				7	700	560	874	446	1,36	25,34	5,67	-	977	1124
		064				8	700	640	947	483	1,36	28,91	6,51	-	1076	1237
		072				9	700	720	1019	520	1,36	32,55	7,35	-	1175	1351
		080				10	700	800	1092	557	1,37	36,12	7,98	-	1273	1464
		088				11	700	880	1151	587	1,36	38,99	8,68	-	1369	1574
382	080	024	XX	YY	00	3	800	240	514	262	1,28	12,40	2,72	-	624	718
		032				4	800	320	638	326	1,30	16,56	3,60	-	732	842
		040				5	800	400	758	387	1,32	20,64	4,56	-	837	963
		048				6	800	480	879	449	1,34	24,80	5,52	-	946	1088
		056				7	800	560	999	510	1,36	28,96	6,48	-	1052	1210
		064				8	800	640	1082	552	1,36	33,04	7,44	-	1160	1334
		072				9	800	720	1165	594	1,36	37,20	8,40	-	1265	1455
		080				10	800	800	1248	637	1,37	41,28	9,12	-	1372	1578
		088				11	800	880	1315	671	1,36	44,56	9,92	-	1480	1702
382	090	024	XX	YY	00	3	900	240	579	295	1,28	13,95	3,06	-	665	765
		032				4	900	320	718	366	1,30	18,63	4,05	-	779	896
		040				5	900	400	853	435	1,32	23,22	5,13	-	893	1027
		048				6	900	480	989	505	1,34	27,90	6,21	-	1011	1163
		056				7	900	560	1124	574	1,36	32,58	7,29	-	1126	1295
		064				8	900	640	1218	621	1,36	37,17	8,37	-	1242	1428
		072				9	900	720	1310	669	1,36	41,85	9,45	-	1356	1559
		080				10	900	800	1404	716	1,37	46,44	10,26	-	1471	1692
		088				11	900	880	1480	755	1,36	50,13	11,16	-	1585	1823

Conform EN442-1: 2014: radiatoren en convectoren

Voor meer details over onze artikel-data, zie artikel-database: <https://www.installdata.be>

Voor de warmteafgiftes van andere regimes, kijkt u op p. 346 (correctiefactoren)
 BELGIË. Prijzen in euro (excl. BTW)

HOE VIOLA-A HORIZONTAAL BESTELLEN

Leveringstermijn 15 - 30 werkdagen
(zonder transportduur)

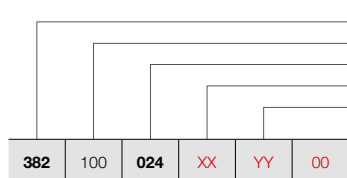

ref. nr. (3 cijfers)
breedte (3 cijfers)
hoogte (3 cijfers)
aansluiting (2 tekens) p. 227
kleur (2 cijfers) p. 12

uitvoering (2 tekens)
00 = standaard
07 = telescopische steunvoeten + variabele
muurbevestigingen
H0 = hogere werkdruk (10 bar)

VRIJSTAANDE OPSTELLING (H2L1-RO-A)

Zie p. 225 voor extra toebehoren.

VIOLA-A HORIZONTAAL (H2L1-RO-A)



H2L1-RO-A
(thermostaatkop apart te bestellen)

PRIJSGROEP: VPG2 - STAAL DESIGNRADIATOREN

BESTELCODE MAATWERK VIOLA-A HORIZONTAAL	TECHNISCHE GEGEVENS							STANDAARDKLEUR	ANDERE KLEUREN			
	buizen	breedte (L mm)	hoogte (H mm)	75/65/20 (Watt) (φ50K)	55/45/20 (Watt) (φ30K)	n-exp.	gewicht (kg)			inhoud (l)	el. weerst. (Watt)	prijs RAL 9016 (€)
REF. NR. VIOLA-A HORIZONTAAL H2L1-RO-A : 382												
382 100 024 XX YY 00	3	1000	240	643	328	1,28	15,50	3,40	-	703	808	
	4	1000	320	798	407	1,30	20,70	4,50	-	827	951	
	5	1000	400	948	484	1,32	25,80	5,70	-	953	1096	
	6	1000	480	1099	561	1,34	31,00	6,90	-	1076	1237	
	7	1000	560	1249	637	1,36	36,20	8,10	-	1199	1379	
	8	1000	640	1353	690	1,36	41,30	9,30	-	1322	1520	
	9	1000	720	1456	743	1,36	46,50	10,50	-	1447	1664	
	10	1000	800	1560	796	1,37	51,60	11,40	-	1571	1807	
	11	1000	880	1644	839	1,36	55,70	12,40	-	1697	1952	
	382 110 024 XX YY 00	3	1100	240	707	361	1,28	17,05	3,74	-	743	854
		4	1100	320	878	448	1,30	22,77	4,95	-	877	1009
5		1100	400	1043	532	1,32	28,38	6,27	-	1010	1162	
6		1100	480	1209	617	1,34	34,10	7,59	-	1139	1310	
7		1100	560	1374	701	1,36	39,82	8,91	-	1274	1465	
8		1100	640	1488	759	1,36	45,43	10,23	-	1407	1618	
9		1100	720	1602	817	1,36	51,15	11,55	-	1539	1770	
10		1100	800	1716	876	1,37	56,76	12,54	-	1672	1923	
11		1100	880	1808	923	1,36	61,27	13,64	-	1805	2076	
382 120 024 XX YY 00		3	1200	240	772	394	1,28	18,60	4,08	-	784	902
		4	1200	320	958	489	1,30	24,84	5,40	-	922	1060
	5	1200	400	1138	580	1,32	30,96	6,84	-	1064	1224	
	6	1200	480	1319	673	1,34	37,20	8,28	-	1207	1388	
	7	1200	560	1499	765	1,36	43,44	9,72	-	1349	1551	
	8	1200	640	1624	828	1,36	49,56	11,16	-	1489	1712	
	9	1200	720	1747	891	1,36	55,80	12,60	-	1630	1875	
	10	1200	800	1872	955	1,37	61,92	13,68	-	1772	2038	
	11	1200	880	1973	1007	1,36	66,84	14,88	-	1913	2200	
	382 140 024 XX YY 00	3	1400	240	900	459	1,28	21,70	4,76	-	863	992
		4	1400	320	1117	570	1,30	28,98	6,30	-	1020	1173
5		1400	400	1327	677	1,32	36,12	7,98	-	1179	1356	
6		1400	480	1539	785	1,34	43,40	9,66	-	1339	1540	
7		1400	560	1749	892	1,36	50,68	11,34	-	1495	1719	
8		1400	640	1894	966	1,36	57,82	13,02	-	1653	1901	
9		1400	720	2038	1040	1,36	65,10	14,70	-	1811	2083	
10		1400	800	2184	1114	1,37	72,24	15,96	-	1971	2267	
11		1400	880	2302	1174	1,36	77,98	17,36	-	2131	2451	
382 160 024 XX YY 00		3	1600	240	1029	525	1,28	24,80	5,44	-	941	1082
		4	1600	320	1277	651	1,30	33,12	7,20	-	1118	1286
	5	1600	400	1517	774	1,32	41,28	9,12	-	1293	1487	
	6	1600	480	1758	897	1,34	49,60	11,04	-	1468	1688	
	7	1600	560	1998	1020	1,36	57,92	12,96	-	1644	1891	
	8	1600	640	2165	1104	1,36	66,08	14,88	-	1819	2092	
	9	1600	720	2330	1189	1,36	74,40	16,80	-	1997	2297	
	10	1600	800	2496	1273	1,37	82,56	18,24	-	2171	2497	
	11	1600	880	2630	1342	1,36	89,12	19,84	-	2346	2698	

Conform EN442-1: 2014: radiatoren en convectoren

Voor meer details over onze artikel-data, zie artikel-database: <https://www.installdata.be>

Voor de warmteafgiftes van andere regimes, kijkt u op p. 346 (correctiefactoren)
BELGIË. Prijzen in euro (excl. BTW)

VIOLA-A HORIZONTAAL (H2L1-RO-A)



H2L1-RO-A
(thermostaatkop apart te bestellen)

HOE VIOLA-A HORIZONTAAL BESTELLEN

Leveringstermijn 15 - 30 werkdagen
(zonder transportduur)

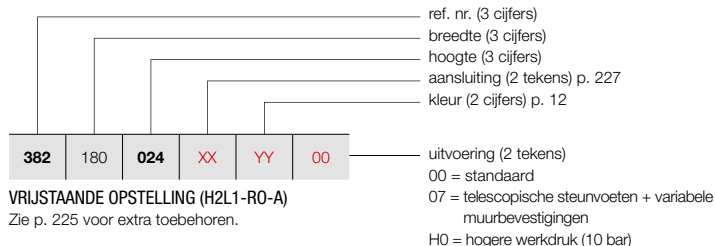

VRIJSTAANDE OPSTELLING (H2L1-RO-A)
Zie p. 225 voor extra toebehoren.

PRIJSGROEP: VPG2 - STAAL DESIGNRADIATOREN

BESTELCODE MAATWERK VIOLA-A HORIZONTAAL							TECHNISCHE GEGEVENS					STANDAARDKLEUR	ANDERE KLEUREN								
buizen	breedte (L mm)	hoogte (H mm)	75/65/20 (Watt) (Φ50K)	55/45/20 (Watt) (Φ30K)	n-exp.	gewicht (kg)	inhoud (l)	el. weerst. (Watt)	prijs RAL 9016 (€)	prijs kleur (€)											
REF. NR. VIOLA-A HORIZONTAAL H2L1-RO-A : 382																					
382	180	024	XX	YY	00	3	1800	240	1157	591	1,28	27,90	6,12	-	1020	1173					
		032				4	1800	320	1436	733	1,30	37,26	8,10	-	1213	1395					
		040				5	1800	400	1706	871	1,32	46,44	10,26	-	1407	1618					
		048				6	1800	480	1978	1009	1,34	55,80	12,42	-	1602	1842					
		056				7	1800	560	2248	1147	1,36	65,16	14,58	-	1791	2060					
		064				8	1800	640	2435	1243	1,36	74,34	16,74	-	1982	2279					
		072				9	1800	720	2621	1337	1,36	83,70	18,90	-	2177	2504					
		080				10	1800	800	2808	1433	1,37	92,88	20,52	-	2368	2723					
		088				11	1800	880	2959	1510	1,36	100,26	22,32	-	2562	2946					
		382				200	024	XX	YY	00	3	2000	240	1286	656	1,28	31,00	6,80	-	1096	1260
							032				4	2000	320	1596	814	1,30	41,40	9,00	-	1311	1508
040	5		2000	400	1896		967				1,32	51,60	11,40	-	1521	1749					
048	6		2000	480	2198		1121				1,34	62,00	13,80	-	1728	1987					
056	7		2000	560	2498		1274				1,36	72,40	16,20	-	1938	2229					
064	8		2000	640	2706		1381				1,36	82,60	18,60	-	2149	2471					
072	9		2000	720	2912		1486				1,36	93,00	21,00	-	2360	2714					
080	10		2000	800	3120		1592				1,37	103,20	22,80	-	2569	2954					
088	11		2000	880	3288		1678				1,36	111,40	24,80	-	2778	3195					
382	220		024	XX	YY		00				3	2200	240	1415	722	1,28	34,10	7,48	-	1179	1356
			032								4	2200	320	1756	896	1,30	45,54	9,90	-	1407	1618
		040	5			2200		400	2086	1064	1,32	56,76	12,54	-	1634	1879					
		048	6			2200		480	2418	1234	1,34	68,20	15,18	-	1862	2141					
		056	7			2200		560	2748	1402	1,36	79,64	17,82	-	2087	2400					
		064	8			2200		640	2977	1519	1,36	90,86	20,46	-	2311	2658					
		072	9			2200		720	3203	1634	1,36	102,30	23,10	-	2541	2922					
		080	10			2200		800	3432	1751	1,37	113,52	25,08	-	2767	3182					
		088	11			2200		880	3617	1845	1,36	122,54	27,28	-	2994	3443					
		382	240			024		XX	YY	00	3	2400	240	1543	787	1,28	37,20	8,16	-	1257	1446
						032					4	2400	320	1915	977	1,30	49,68	10,80	-	1502	1727
040	5			2400	400	2275	1161				1,32	61,92	13,68	-	1746	2008					
048	6			2400	480	2638	1346				1,34	74,40	16,56	-	1990	2289					
056	7			2400	560	2998	1529				1,36	86,88	19,44	-	2235	2570					
064	8			2400	640	3247	1657				1,36	99,12	22,32	-	2480	2852					
072	9			2400	720	3494	1783				1,36	111,60	25,20	-	2724	3133					
080	10			2400	800	3744	1910				1,37	123,84	27,36	-	2969	3414					
088	11			2400	880	3946	2013				1,36	133,68	29,76	-	3213	3695					
382	260			024	XX	YY	00				3	2600	240	1672	853	1,28	40,30	8,84	-	1339	1540
				032							4	2600	320	2075	1059	1,30	53,82	11,70	-	1598	1838
		040	5	2600				400	2465	1258	1,32	67,08	14,82	-	1862	2141					
		048	6	2600				480	2857	1458	1,34	80,60	17,94	-	2121	2439					
		056	7	2600				560	3247	1657	1,36	94,12	21,06	-	2381	2738					
		064	8	2600				640	3518	1795	1,36	107,38	24,18	-	2647	3044					
		072	9	2600				720	3786	1931	1,36	120,90	27,30	-	2906	3342					
		080	10	2600				800	4056	2069	1,37	134,16	29,64	-	3169	3644					
		088	11	2600				880	4274	2181	1,36	144,82	32,24	-	3430	3945					

Conform EN442-1: 2014: radiatoren en convectoren

Voor meer details over onze artikel-data, zie artikel-database: <https://www.installdata.be>

Voor de warmteafgiftes van andere regimes, kijkt u op p. 346 (correctiefactoren)
BELGIË. Prijzen in euro (excl. BTW)

HOE VIOLA-A HORIZONTAAL BESTELLEN

Leveringstermijn 15 - 30 werkdagen
(zonder transportduur)

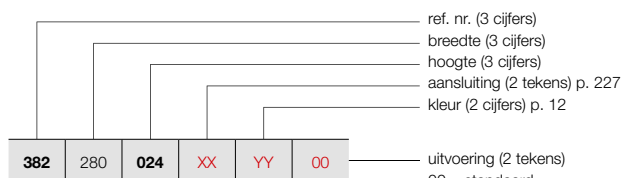

VRIJSTAANDE OPSTELLING (H2L1-RO-A)

Zie p. 225 voor extra toebehoren.

uitvoering (2 tekens)
00 = standaard
07 = telescopische steunvoeten + variabele muurbevestigingen
H0 = hogere werkdruk (10 bar)

VIOLA-A HORIZONTAAL (H2L1-RO-A)



H2L1-RO-A
(thermostaatkop apart te bestellen)

PRIJSGROEP: VPG2 - STAAL DESIGNRADIATOREN

BESTELCODE MAATWERK VIOLA-A HORIZONTAAL	TECHNISCHE GEGEVENS							STANDAARDKLEUR		ANDERE KLEUREN	
	buizen	breedte (L mm)	hoogte (H mm)	75/65/20 (Watt) (Φ50K)	55/45/20 (Watt) (Φ30K)	n-exp.	gewicht (kg)	inhoud (l)	el. weerst. (Watt)	prijs RAL 9016 (€)	prijs kleur (€)
REF. NR. VIOLA-A HORIZONTAAL H2L1-RO-A : 382											
382	280	024	XX	YY	00						
		032								1415	1627
		040								1693	1947
		048								1972	2268
		056								2252	2590
		064								2530	2910
		072								2808	3229
		080								3090	3554
		088								3365	3870
										3645	4192
382	300	024	XX	YY	00						
		032								1494	1718
		040								1791	2060
		048								2087	2400
		056								2381	2738
		064								2676	3077
		072								2974	3420
		080								3270	3761
		088								3566	4101
										3861	4440

Conform EN442-1: 2014: radiatoren en convectoren

Voor meer details over onze artikel-data, zie artikel-database: <https://www.installdata.be>
Voor de warmteafgiftes van andere regimes, kijkt u op p. 346 (correctiefactoren)
BELGIË. Prijzen in euro (excl. BTW)

VIOLA-A HORIZONTAAL (H2L2-RO-A)



H2L2-RO-A
(thermostaatkop apart te bestellen)

HOE VIOLA-A HORIZONTAAL BESTELLEN

Leveringstermijn 15 - 30 werkdagen
(zonder transportduur)

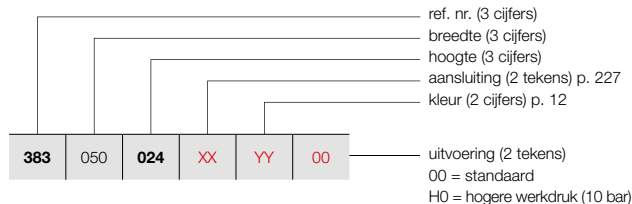

PRIJSGROEP: VPG2 - STAAL DESIGNRADIATOREN

BESTELCODE MAATWERK VIOLA-A HORIZONTAAL							TECHNISCHE GEGEVENS					STANDAARDKLEUR	ANDERE KLEUREN			
buizen	breedte (L mm)	hoogte (H mm)	75/65/20 (Watt) (Φ50K)	55/45/20 (Watt) (Φ30K)	n-exp.	gewicht (kg)	inhoud (l)	el. weerst. (Watt)	prijs RAL 9016 (€)	prijs kleur (€)						
REF. NR. VIOLA-A HORIZONTAAL H2L2-RO-A : 383																
383	050	024	XX	YY	00	3	500	240	433	221	1,25	9,70	2,00	-	549	631
		032				4	500	320	538	274	1,30	12,90	2,75	-	640	736
		040				5	500	400	663	338	1,31	16,10	3,45	-	731	841
		048				6	500	480	788	402	1,33	19,40	4,15	-	823	946
		056				7	500	560	913	466	1,34	22,60	4,85	-	915	1052
		064				8	500	640	993	507	1,34	25,85	5,50	-	1000	1150
		072				9	500	720	1073	547	1,34	29,10	6,20	-	1094	1258
		080				10	500	800	1153	588	1,36	32,30	6,90	-	1187	1365
		088				11	500	880	1204	614	1,36	34,45	7,60	-	1279	1471
383	060	024	XX	YY	00	3	600	240	519	265	1,25	11,64	2,40	-	595	684
		032				4	600	320	645	329	1,30	15,48	3,30	-	694	798
		040				5	600	400	796	406	1,31	19,32	4,14	-	799	919
		048				6	600	480	946	482	1,33	23,28	4,98	-	902	1037
		056				7	600	560	1096	559	1,34	27,12	5,82	-	1000	1150
		064				8	600	640	1192	608	1,34	31,02	6,60	-	1106	1272
		072				9	600	720	1287	657	1,34	34,92	7,44	-	1207	1388
		080				10	600	800	1383	706	1,36	38,76	8,28	-	1311	1508
		088				11	600	880	1445	737	1,36	41,34	9,12	-	1412	1624
383	070	024	XX	YY	00	3	700	240	606	309	1,25	13,58	2,80	-	644	741
		032				4	700	320	753	384	1,30	18,06	3,85	-	757	871
		040				5	700	400	928	474	1,31	22,54	4,83	-	870	1001
		048				6	700	480	1103	563	1,33	27,16	5,81	-	984	1132
		056				7	700	560	1278	652	1,34	31,64	6,79	-	1093	1257
		064				8	700	640	1390	709	1,34	36,19	7,70	-	1207	1388
		072				9	700	720	1502	766	1,34	40,74	8,68	-	1318	1516
		080				10	700	800	1614	823	1,36	45,22	9,66	-	1431	1646
		088				11	700	880	1686	860	1,36	48,23	10,64	-	1544	1776
383	080	024	XX	YY	00	3	800	240	692	353	1,25	15,52	3,20	-	690	794
		032				4	800	320	860	439	1,30	20,64	4,40	-	815	937
		040				5	800	400	1061	541	1,31	25,76	5,52	-	936	1076
		048				6	800	480	1261	643	1,33	31,04	6,64	-	1061	1220
		056				7	800	560	1461	745	1,34	36,16	7,76	-	1186	1364
		064				8	800	640	1589	811	1,34	41,36	8,80	-	1310	1507
		072				9	800	720	1716	876	1,34	46,56	9,92	-	1431	1646
		080				10	800	800	1844	941	1,36	51,68	11,04	-	1554	1787
		088				11	800	880	1926	983	1,36	55,12	12,16	-	1677	1929
383	090	024	XX	YY	00	3	900	240	779	397	1,25	17,46	3,60	-	739	850
		032				4	900	320	968	494	1,30	23,22	4,95	-	875	1006
		040				5	900	400	1193	609	1,31	28,98	6,21	-	1008	1159
		048				6	900	480	1418	724	1,33	34,92	7,47	-	1139	1310
		056				7	900	560	1643	838	1,34	40,68	8,73	-	1275	1466
		064				8	900	640	1787	912	1,34	46,53	9,90	-	1409	1620
		072				9	900	720	1931	985	1,34	52,38	11,16	-	1543	1774
		080				10	900	800	2075	1058	1,36	58,14	12,42	-	1677	1929
		088				11	900	880	2167	1106	1,36	62,01	13,68	-	1811	2083

Conform EN442-1: 2014: radiatoren en convectoren

Voor meer details over onze artikel-data, zie artikel-database: <https://www.installdata.be>

Voor de warmteafgiftes van andere regimes, kijkt u op p. 346 (correctiefactoren)
BELGIË. Prijzen in euro (excl. BTW)

HOE VIOLA-A HORIZONTAAL BESTELLEN

Leveringstermijn 15 - 30 werkdagen
(zonder transportduur)

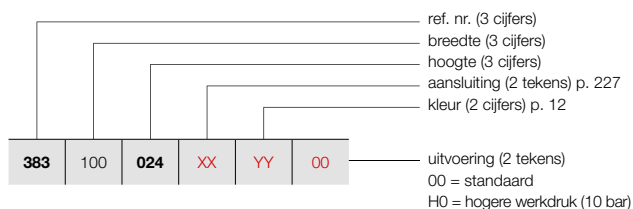

VIOLA-A HORIZONTAAL (H2L2-RO-A)



H2L2-RO-A
(thermostaatkop apart te bestellen)

PRIJSGROEP: VPG2 - STAAL DESIGNRADIATOREN

BESTELCODE MAATWERK VIOLA-A HORIZONTAAL	TECHNISCHE GEGEVENS							STANDAARDKLEUR	ANDERE KLEUREN			
	buizen	breedte (L mm)	hoogte (H mm)	75/65/20 (Watt) (Φ50K)	55/45/20 (Watt) (Φ30K)	n-exp.	gewicht (kg)			inhoud (l)	el. weerst. (Watt)	prijs RAL 9016 (€)
REF. NR. VIOLA-A HORIZONTAAL H2L2-RO-A : 383												
383 100 024 XX YY 00	3	1000	240	865	441	1,25	19,40	4,00	-	787	905	
	4	1000	320	1075	548	1,30	25,80	5,50	-	932	1072	
	5	1000	400	1326	677	1,31	32,20	6,90	-	1076	1237	
	6	1000	480	1576	804	1,33	38,80	8,30	-	1218	1401	
	7	1000	560	1826	932	1,34	45,20	9,70	-	1363	1567	
	8	1000	640	1986	1013	1,34	51,70	11,00	-	1510	1737	
	9	1000	720	2145	1094	1,34	58,20	12,40	-	1655	1903	
	10	1000	800	2305	1176	1,36	64,60	13,80	-	1800	2070	
	11	1000	880	2408	1229	1,36	68,90	15,20	-	1946	2238	
	383 110 024 XX YY 00	3	1100	240	952	485	1,25	21,34	4,40	-	835	960
		4	1100	320	1183	603	1,30	28,38	6,05	-	989	1137
5		1100	400	1459	744	1,31	35,42	7,59	-	1146	1318	
6		1100	480	1734	884	1,33	42,68	9,13	-	1299	1494	
7		1100	560	2009	1025	1,34	49,72	10,67	-	1456	1674	
8		1100	640	2185	1115	1,34	56,87	12,10	-	1610	1852	
9		1100	720	2360	1204	1,34	64,02	13,64	-	1767	2032	
10		1100	800	2536	1294	1,36	71,06	15,18	-	1922	2210	
11		1100	880	2649	1351	1,36	75,79	16,72	-	2078	2390	
383 120 024 XX YY 00		3	1200	240	1038	530	1,25	23,28	4,80	-	883	1015
		4	1200	320	1290	658	1,30	30,96	6,60	-	1049	1206
	5	1200	400	1591	812	1,31	38,64	8,28	-	1214	1396	
	6	1200	480	1891	965	1,33	46,56	9,96	-	1380	1587	
	7	1200	560	2191	1118	1,34	54,24	11,64	-	1545	1777	
	8	1200	640	2383	1216	1,34	62,04	13,20	-	1714	1971	
	9	1200	720	2574	1313	1,34	69,84	14,88	-	1880	2162	
	10	1200	800	2766	1411	1,36	77,52	16,56	-	2044	2351	
	11	1200	880	2890	1474	1,36	82,68	18,24	-	2211	2543	
	383 140 024 XX YY 00	3	1400	240	1211	618	1,25	27,16	5,60	-	978	1125
		4	1400	320	1505	768	1,30	36,12	7,70	-	1165	1340
5		1400	400	1856	947	1,31	45,08	9,66	-	1354	1557	
6		1400	480	2206	1126	1,33	54,32	11,62	-	1540	1771	
7		1400	560	2556	1304	1,34	63,28	13,58	-	1726	1985	
8		1400	640	2780	1419	1,34	72,38	15,40	-	1916	2203	
9		1400	720	3003	1532	1,34	81,48	17,36	-	2102	2417	
10		1400	800	3227	1646	1,36	90,44	19,32	-	2291	2635	
11		1400	880	3371	1720	1,36	96,46	21,28	-	2479	2851	
383 160 024 XX YY 00		3	1600	240	1384	706	1,25	31,04	6,40	-	1074	1235
		4	1600	320	1720	878	1,30	41,28	8,80	-	1282	1474
	5	1600	400	2122	1082	1,31	51,52	11,04	-	1491	1715	
	6	1600	480	2522	1287	1,33	62,08	13,28	-	1701	1956	
	7	1600	560	2922	1491	1,34	72,32	15,52	-	1909	2195	
	8	1600	640	3178	1621	1,34	82,72	17,60	-	2117	2435	
	9	1600	720	3432	1751	1,34	93,12	19,84	-	2327	2676	
	10	1600	800	3688	1882	1,36	103,36	22,08	-	2536	2916	
	11	1600	880	3853	1966	1,36	110,24	24,32	-	2744	3156	

Conform EN442-1: 2014: radiatoren en convectoren

Voor meer details over onze artikel-data, zie artikel-database: <https://www.installdata.be>

Voor de warmteafgiftes van andere regimes, kijkt u op p. 346 (correctiefactoren)
BELGIË. Prijzen in euro (excl. BTW)

VIOLA-A HORIZONTAAL (H2L2-RO-A)



H2L2-RO-A
(thermostaatkop apart te bestellen)

HOE VIOLA-A HORIZONTAAL BESTELLEN

Leveringstermijn 15 - 30 werkdagen
(zonder transportduur)

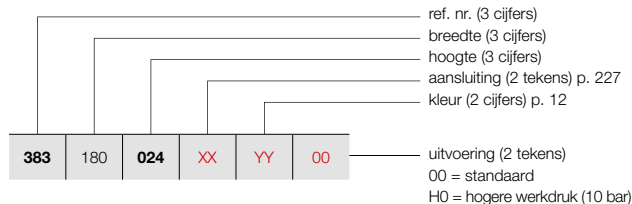

PRIJSGROEP: VPG2 - STAAL DESIGNRADIATOREN

BESTELCODE MAATWERK VIOLA-A HORIZONTAAL							TECHNISCHE GEGEVENS					STANDAARDKLEUR	ANDERE KLEUREN								
buizen	breedte (L mm)	hoogte (H mm)	75/65/20 (Watt) (Ø50K)	55/45/20 (Watt) (Ø30K)	n-exp.	gewicht (kg)	inhoud (l)	el. weerst. (Watt)	prijs RAL 9016 (€)	prijs kleur (€)											
REF. NR. VIOLA-A HORIZONTAAL H2L2-RO-A : 383																					
383	180	024	XX	YY	00	3	1800	240	1557	794	1,25	34,92	7,20	-	1167	1342					
		032				4	1800	320	1935	987	1,30	46,44	9,90	-	1398	1608					
		040				5	1800	400	2387	1218	1,31	57,96	12,42	-	1630	1875					
		048				6	1800	480	2837	1447	1,33	69,84	14,94	-	1862	2141					
		056				7	1800	560	3287	1677	1,34	81,36	17,46	-	2090	2404					
		064				8	1800	640	3575	1824	1,34	93,06	19,80	-	2323	2671					
		072				9	1800	720	3861	1970	1,34	104,76	22,32	-	2553	2936					
		080				10	1800	800	4149	2117	1,36	116,28	24,84	-	2779	3196					
		088				11	1800	880	4334	2211	1,36	124,02	27,36	-	3010	3462					
		383				200	024	XX	YY	00	3	2000	240	1730	883	1,25	38,80	8,00	-	1265	1455
							032				4	2000	320	2150	1097	1,30	51,60	11,00	-	1515	1742
040	5		2000	400	2652		1353				1,31	64,40	13,80	-	1768	2033					
048	6		2000	480	3152		1608				1,33	77,60	16,60	-	2019	2322					
056	7		2000	560	3652		1863				1,34	90,40	19,40	-	2273	2614					
064	8		2000	640	3972		2027				1,34	103,40	22,00	-	2523	2901					
072	9		2000	720	4290		2189				1,34	116,40	24,80	-	2773	3189					
080	10		2000	800	4610		2352				1,36	129,20	27,60	-	3028	3482					
088	11		2000	880	4816		2457				1,36	137,80	30,40	-	3279	3771					
383	220		024	XX	YY		00				3	2200	240	1903	971	1,25	42,68	8,80	-	1360	1564
			032								4	2200	320	2365	1207	1,30	56,76	12,10	-	1635	1880
		040	5			2200		400	2917	1488	1,31	70,84	15,18	-	1908	2194					
		048	6			2200		480	3467	1769	1,33	85,36	18,26	-	2179	2506					
		056	7			2200		560	4017	2050	1,34	99,44	21,34	-	2449	2816					
		064	8			2200		640	4369	2229	1,34	113,74	24,20	-	2725	3134					
		072	9			2200		720	4719	2408	1,34	128,04	27,28	-	2999	3449					
		080	10			2200		800	5071	2587	1,36	142,12	30,36	-	3271	3762					
		088	11			2200		880	5298	2703	1,36	151,58	33,44	-	3545	4077					
		383	240			024		XX	YY	00	3	2400	240	2076	1059	1,25	46,56	9,60	-	1456	1674
						032					4	2400	320	2580	1316	1,30	61,92	13,20	-	1752	2015
040	5			2400	400	3182	1624				1,31	77,28	16,56	-	2044	2351					
048	6			2400	480	3782	1930				1,33	93,12	19,92	-	2340	2691					
056	7			2400	560	4382	2236				1,34	108,48	23,28	-	2634	3029					
064	8			2400	640	4766	2432				1,34	124,08	26,40	-	2927	3366					
072	9			2400	720	5148	2627				1,34	139,68	29,76	-	3221	3704					
080	10			2400	800	5532	2822				1,36	155,04	33,12	-	3513	4040					
088	11			2400	880	5779	2949				1,36	165,36	36,48	-	3810	4382					
383	260			024	XX	YY	00				3	2600	240	2249	1147	1,25	50,44	10,40	-	1553	1786
				032							4	2600	320	2795	1426	1,30	67,08	14,30	-	1869	2149
		040	5	2600				400	3448	1759	1,31	83,72	17,94	-	2183	2510					
		048	6	2600				480	4098	2091	1,33	100,88	21,58	-	2500	2875					
		056	7	2600				560	4748	2422	1,34	117,52	25,22	-	2812	3234					
		064	8	2600				640	5164	2634	1,34	134,42	28,60	-	3131	3601					
		072	9	2600				720	5577	2845	1,34	151,32	32,24	-	3445	3962					
		080	10	2600				800	5993	3058	1,36	167,96	35,88	-	3762	4326					
		088	11	2600				880	6261	3194	1,36	179,14	39,52	-	4077	4689					

Conform EN442-1: 2014: radiatoren en convectoren

Voor meer details over onze artikel-data, zie artikel-database: <https://www.installdata.be>

Voor de warmteafgifte van andere regimes, kijkt u op p. 346 (correctiefactoren)
BELGIË. Prijzen in euro (excl. BTW)

HOE VIOLA-A HORIZONTAAL BESTELLEN

Leveringstermijn 15 - 30 werkdagen
(zonder transportduur)

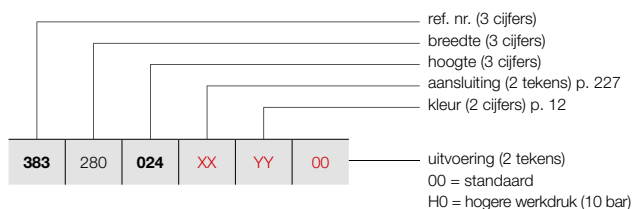

VIOLA-A HORIZONTAAL (H2L2-RO-A)



H2L2-RO-A
(thermostaatkop apart te bestellen)

PRIJSGROEP: VPG2 - STAAL DESIGNRADIATOREN



BESTELCODE MAATWERK VIOLA-A HORIZONTAAL	TECHNISCHE GEGEVENS								STANDAARDKLEUR		ANDERE KLEUREN					
	buizen	breedte (L mm)	hoogte (H mm)	75/65/20 (Watt) (Φ50K)	55/45/20 (Watt) (Φ30K)	n-exp.	gewicht (kg)	inhoud (l)	el. weerst. (Watt)	prijs RAL 9016 (€)	prijs kleur (€)					
REF. NR. VIOLA-A HORIZONTAAL H2L2-RO-A : 383																
383	280	024	XX	YY	00	3	2800	240	2422	1236	1,25	54,32	11,20	-	1647	1894
		032				4	2800	320	3010	1536	1,30	72,24	15,40	-	1984	2282
		040				5	2800	400	3713	1894	1,31	90,16	19,32	-	2325	2674
		048				6	2800	480	4413	2251	1,33	108,64	23,24	-	2659	3058
		056				7	2800	560	5113	2609	1,34	126,56	27,16	-	2998	3448
		064				8	2800	640	5561	2837	1,34	144,76	30,80	-	3332	3832
		072				9	2800	720	6006	3064	1,34	162,96	34,72	-	3670	4221
		080				10	2800	800	6454	3293	1,36	180,88	38,64	-	4008	4609
383	300	024	XX	YY	00	3	3000	240	2595	1324	1,25	58,20	12,00	-	1743	2004
		032				4	3000	320	3225	1645	1,30	77,40	16,50	-	2102	2417
		040				5	3000	400	3978	2030	1,31	96,60	20,70	-	2459	2828
		048				6	3000	480	4728	2412	1,33	116,40	24,90	-	2819	3242
		056				7	3000	560	5478	2795	1,34	135,60	29,10	-	3177	3654
		064				8	3000	640	5958	3040	1,34	155,10	33,00	-	3537	4068
		072				9	3000	720	6435	3283	1,34	174,60	37,20	-	3892	4476

Conform EN442-1: 2014: radiatoren en convectoren

Voor meer details over onze artikel-data, zie artikel-database: <https://www.installdata.be>
Voor de warmteafgiftes van andere regimes, kijkt u op p. 346 (correctiefactoren)
BELGIË. Prijzen in euro (excl. BTW)

VIOLA-A WANDBEVESTIGING IN OPTIE

PRIJSGROEP: VPG10 - ACC.

WANDOPSTELLING	BREEDTE RADIATOR	KLEUR	ART. NR.	€
TELESCOPISCHE STEUNVOETEN + VARIABLE MUURBEVESTIGINGEN 	V2-ZB-A			
	(2 voeten)	RAL 9016	*	81
		KLEUR	*	93
	H2-RO-A, H2L1-RO-A			
	≤ 2000 mm (2 voeten)	RAL 9016	*	81
		KLEUR	*	93
≥ 2200 mm (3 voeten)	RAL 9016	*	123	
	KLEUR	*	141	
* Opgelet: Voeten moeten gelijktijdig met de radiator besteld worden. Gelieve bij bestelling code 07 aan te geven bij "Afwerking".				
AFDEKROZET STANDVOET CHAPE 	V2-ZB-A			
		RAL 9016	11810390000	29
• 56 x 56 mm. Aantal rozetten = aantal standvoeten				
AFDEKROZET STANDVOET AFGEWERKTE VLOER 	H2-RO-A, H2L1-RO-A			
		RAL 9016	11810400000	37
• 104 x 84 mm. Aantal rozetten = aantal standvoeten				

BELGIË. Prijzen in euro (excl. BTW)

PRIJSGROEP: VPG10 - ACC.

VRIJSTAANDE OPSTELLING	HOOGTE VOET	KLEUR	ART. NR.	€
STANDVOET VRIJSTAANDE OPSTELLING 	H1-RO-A, H1L1-RO-A, H2-RO-A, H2L1-RO-A, H2L2-RO-A			
	H = 450 mm	RAL 9016	11810350450	60
		KLEUR	11810350450C	69
	H = 550 mm	RAL 9016	11810350550	60
		KLEUR	11810350550C	69
	H = 600 mm	RAL 9016	11810350600	60
		KLEUR	11810350600C	69
	H = 650 mm	RAL 9016	11810350650	60
		KLEUR	11810350650C	69
	H = 750 mm	RAL 9016	11810350750	60
		KLEUR	11810350750C	69
	H = 850 mm	RAL 9016	11810350850	74
		KLEUR	11810350850C	85
	H = 900 mm	RAL 9016	11810350900	74
	KLEUR	11810350900C	85	
H = 1050 mm	RAL 9016	11810351050	74	
	KLEUR	11810351050C	85	
H = 1200 mm	RAL 9016	11810351200	74	
	KLEUR	11810351200C	85	
<ul style="list-style-type: none"> Afgewerkte vloer: hoogte voet = hoogte radiator + 150 mm Chape: hoogte voet = hoogte radiator + 300 mm Zelf in te korten indien nodig 				

BEVESTIGING STANDVOET VRIJSTAANDE OPSTELLING 	H1-RO-A, H1L1-RO-A, H2-RO-A, H2L1-RO-A, H2L2-RO-A			
		RAL 9016	11810360000	48
		KLEUR	11810360000C	55

AFDEKROZET STANDVOET CHAPE 	H1-RO-A, H1L1-RO-A, H2-RO-A, H2L1-RO-A, H2L2-RO-A			
		RAL 9016	11810370000	12
		KLEUR	11810370000C	14

- 100 x 40 mm. Aantal rozetten = aantal standvoeten

AFDEKROZET STANDVOET AFGEWERKTE VLOER 	H1-RO-A, H1L1-RO-A, H2-RO-A, H2L1-RO-A, H2L2-RO-A			
		RAL 9016	11810380000	15
		KLEUR	11810380000C	17



- 115 x 110 mm. Aantal rozetten = aantal standvoeten

hoogte radiator (mm)	Lengte radiator (mm)	aantal standvoeten	aantal bevestigingen standvoet
240 - 880	500-2000	2x	2x
	2200-3000	3x	3x

BELGIË. Prijzen in euro (excl. BTW)

VIOLA-A ACCESSOIRES IN OPTIE

PRIJSGROEP: VPG10 - ACC.

ACCESSOIRES		KLEUR	ART. NR.	€
THERMOSTAATKOP		V1-ZB-A, V1L1-ZB-A, V2-ZB-A H1-RO-A, H1L1-RO-A, H2-RO-A, H2L1-RO-A, H2L2-RO-A		
		WIT	11911630102	44
THERMOSTAATKOP		V1-ZB-A, V1L1-ZB-A, V2-ZB-A H1-RO-A, H1L1-RO-A, H2-RO-A, H2L1-RO-A, H2L2-RO-A		
		CHROOM	11911631102	60

PRIJSGROEP: VPG10B - HANDDOEKBEUGELS

ACCESSOIRES	BREEDTE HANDDOEKBEUGEL	KLEUR	ART. NR.	€	
KNOP		V1-ZB-A, V1L1-ZB-A, V2-ZB-A			
		CHROOM	118341100000099	87	
		• h = 70 mm; b = 70 mm; d = 51 mm; a = 43 mm;			
HANDDOEKBEUGEL		V1-ZB-A, V1L1-ZB-A, V2-ZB-A H1-RO-A, H1L1-RO-A, H2-RO-A, H2L1-RO-A, H2L2-RO-A			
		500 mm	CHROOM	118327000000099	145
		500 mm	RAL 9016	118327000009016	145
		500 mm	RAL 9005 ^{mat}	118327000009005	145
		• h = 55 mm; b = 500 mm; d = 53 mm; a = 38 mm;			

^{mat} mat zwart

Montagevoorschriften accessoires: zie www.vasco.eu
BELGIË. Prijzen in euro (excl. BTW)

d = afstand voorkant accessoire tot voorkant radiator
a = afstand accessoire tot radiator
uit voorraad leverbaar

VIOLA-A VERTICAAL: V1-ZB-A / V1L1-ZB-A / V2-ZB-A (VOORRAAD)

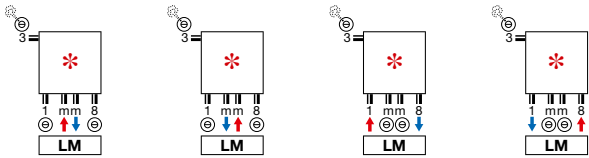

- * Aanvoer en retour kunnen verwisseld worden
- Bovenvermelde aansluiting voor voorraad radiator met even aantal buizen. Ook beschikbaar voor niet-voorraadradiatoren met even aantal buizen.

VIOLA-A VERTICAAL: V1-ZB-A / V1L1-ZB-A / V2-ZB-A (NIET-VOORRAAD)

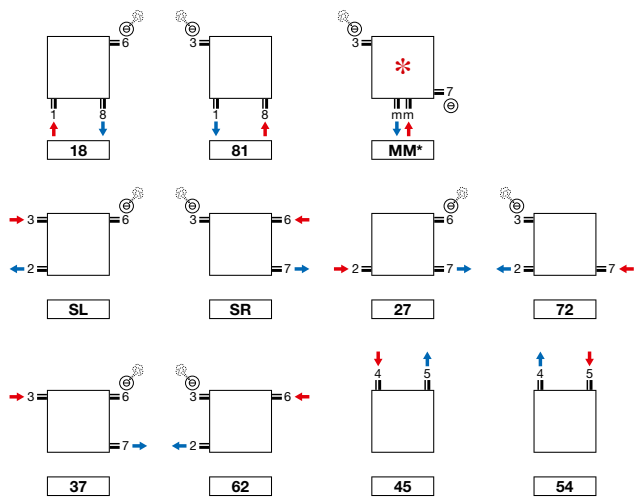

- * Aanvoer en retour kunnen verwisseld worden
- mm aansluiting alleen mogelijk bij even aantal buizen.

VIOLA-A HORIZONTAAL: H1-RO-A / H1L1-RO-A / H2-RO-A / H2L1-RO-A / H2L2-RO-A (NIET-VOORRAAD)

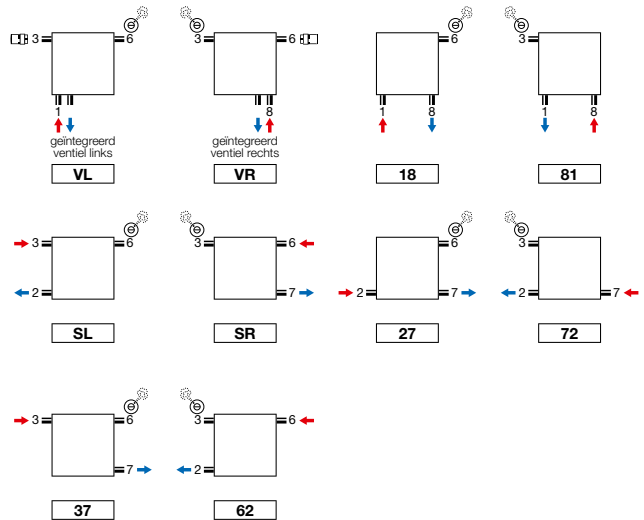

- Aansluiting VL en VR: thermostaatkop apart te bestellen
- Geïntegreerd ventiel (meerprijs) (zie p. 341)

Opmerking: het aansluiten van de radiator kan enkel volgens de getoonde aansluiticonen. Voor elke andere aansluitwijze nemen wij geen verantwoordelijkheid.

VIOLA-A VERTICAAL (V1-ZB-A, V1L1-ZB-A, V2-ZB-A)

V1-ZB-A

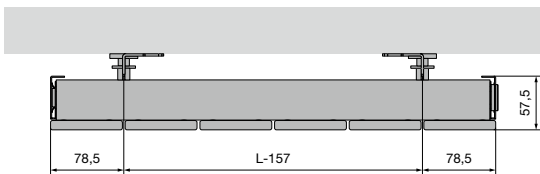

V1L1-ZB-A

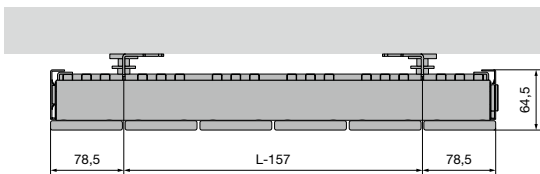

V2-ZB-A

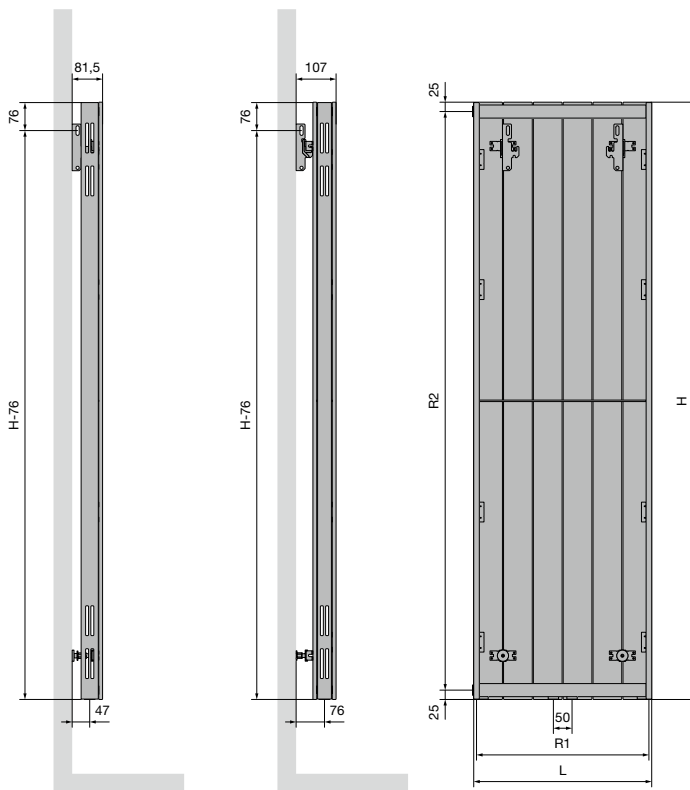
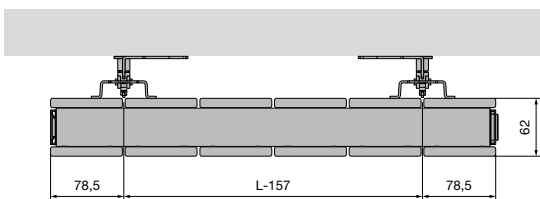

	V1-ZB-A / V1L1-ZB-A / V2-ZB-A										
aantal buizen	3	4	5	6	7	8	9	10	11	12	13
Breedte (L)	237	317	397	477	557	637	717	797	877	957	1037
Hartafstand tussen de onderaansluitingen 18 (R1)	187	267	347	427	507	587	667	747	827	907	987
hoogte (H)	1200	1400	1600	1800	2000	2200	2400				
Hartafstand tussen de zijaansluitingen SL/SR (R2)	1150	1350	1550	1750	1950	2150	2350				
Hartafstand tussen de ophangingen	L-157	H-76									

VIOLA-A HORIZONTAAL (H1-RO-A, H1L1-RO-A, H2-RO-A, H2L1-RO-A, H2L2-RO-A)

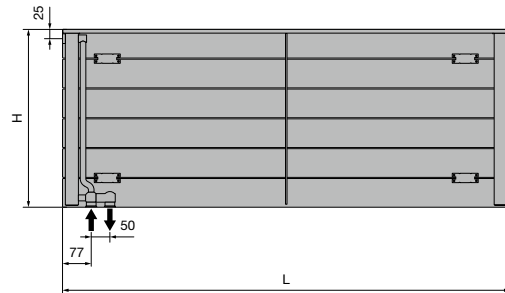
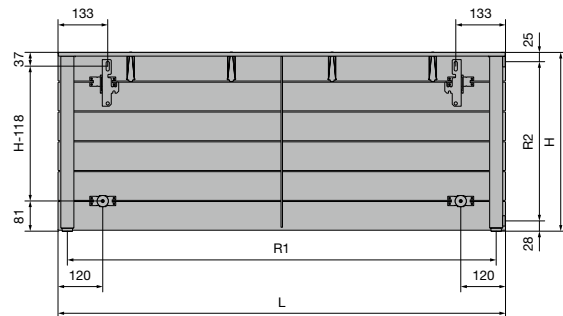
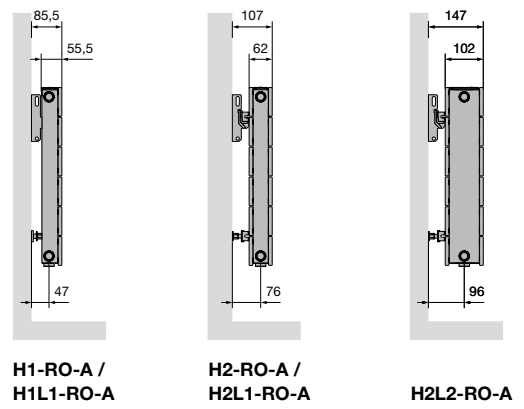
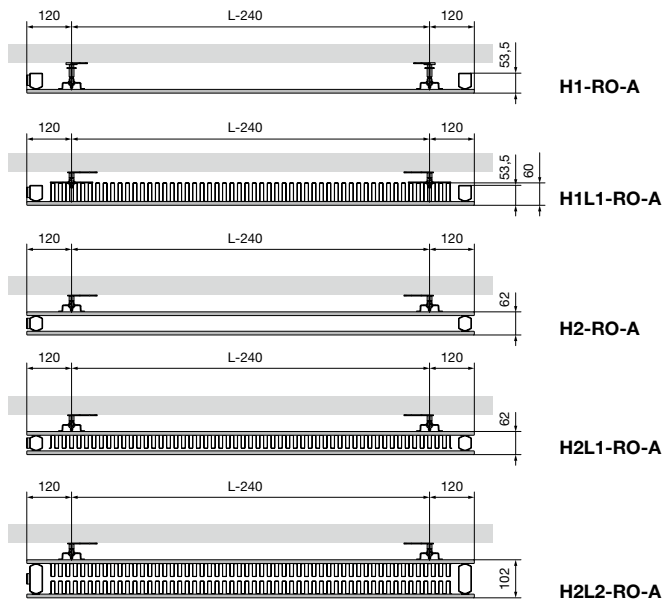

	H1-RO-A / H1L1-RO-A / H2-RO-A / H2L1-RO-A / H2L2-RO-A																
Breedte (L)	500	600	700	800	900	1000	1100	1200	1400	1600	1800	2000	2200	2400	2600	2800	3000
Hartafstand tussen de onderaansluitingen R1	450	550	650	750	850	950	1050	1150	1350	1550	1750	1950	2150	2350	2550	2750	2950
hoogte (H)	240	320	400	480	560	640	720	800	880								
Hartafstand tussen de zijaan sluitingen SL/SR (R2)	187	267	347	427	507	587	667	747	827								
Hartafstand tussen de ophangingen	L-240		H-118														

TULIPA-A VERTICAAL (TV1-A, TV2-A)



TULIPA-A VERTICAAL

Warmte in alle openheid

Een designradiator van de eerste generatie. Geschikt voor alle ruimten en toepassingen. Gekenmerkt door de klassieke open structuur en de loodrechte aansluiting van de buizen op de collector. De waarborg voor een smetteloos verwarmingscomfort waar dan ook in huis.

TYPES

- Eén (TV1-A) of twee rijen buizen (TV2-A)

BUIZEN

- Verticaal, platvaal 60 x 10 mm

COLLECTOREN

- Horizontaal, achterliggend, rond Ø 32 mm

KLEUREN

- Standaardkleur wit RAL 9016
- Uitgebreide kleurenkaart zie p. 12

SPECIAAL

- Tulipa-A 6 en 8 buizen: aansluiting 1mm8, 18, 81 niet mogelijk

BEVESTIGINGEN

- Muurbevestigingen standaard (inbegrepen in de verpakking van de radiator)
- **TV1-A / TV2-A:** ook verkrijgbaar als vrijstaande opstelling, zie p. 244. Extra muurbevestigingssteun nodig voor hoogte radiator > 600 mm

TECHNISCH

- Weerstandsgelast (onzichtbare lasnaden)
- ATL-grondlaag, poedercoating
- Standaardwerkdruk: 6 bar. Meerprijs hogere werkdruk (10 bar): +10%.
- De leveringstermijn van radiator met een hogere werkdruk is 1 week extra.
- Maximale bedrijfstemperatuur: 110°C

ELEKTRISCH

- ✗ Zuiver elektrische radiator in de fabriek voorgevuld
- ✗ Gemengde radiator

TECHNISCHE TEKENINGEN

- Zie p. 247

AANSLUITING

- ✗ Eénpuntsaansluiting voor éénpijpssysteem
- ✗ Eénpuntsaansluiting voor tweepijpssysteem
- ✓ Tweepuntsaansluiting voor éénpijpssysteem (aansluiting via de middenaansluiting) (zie p. 340)
- ✓ Tweepuntsaansluiting voor tweepijpssysteem (standaard) (zie p. 340)
- ✗ Geïntegreerd ventiel
- Aansluitingen: ½" (binnendraad)

AANBEVOLEN AANSLUITING (LM)

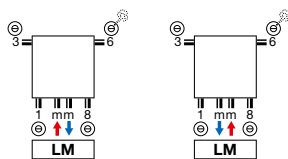

art. nr. 118200100009016
prijs €126
Koppelingen, zie p. 353



art. nr. 11911630102
prijs €44

AANBEVOLEN VOOR BADKAMER EN KEUKEN IN OPTIE



handdoekbeugel (RAL 9005)
art. nr. zie p. 245
prijs €145
Andere accessoires, zie p. 245

Andere aansluitmogelijkheden, zie p. 246



TV1-A / TV2-A

HOE TULIPA-A VERTICAAL BESTELLEN

Leveringstermijn 15 - 30 werkdagen
(zonder transportduur)

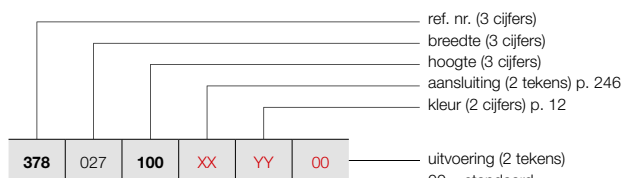

VRIJSTAANDE OPSTELLING (TV1-A)

Zie p. 244 voor extra toebehoren.

HOE VOORRAADRADIATOR TULIPA-A VERTICAAL BESTELLEN

Leveringstermijn 5 werkdagen
(zonder transportduur)

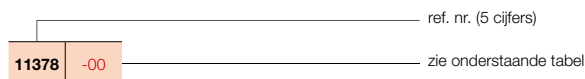

TULIPA-A VERTICAAL (TV1-A)



TV1-A

PRIJSGROEP: VPG2 - STAAL DESIGNRADIATOREN

BESTELCODE MAATWERK TULIPA-A VERTICAAL	TECHNISCHE GEGEVENS								STANDAARDKLEUR		ANDERE KLEUREN	
	buizen	breedte (L mm)	hoogte (H mm)	75/65/20 (Watt) (Φ50K)	55/45/20 (Watt) (Φ30K)	n-exp.	gewicht (kg)	inhoud (l)	el. weerst. (Watt)	prijs RAL 9016 (€)		verkorte ref. nr. RAL 9016 voorraad
REF. NR. TULIPA-A VERTICAAL TV1-A : 378												
378 027 100 XX YY 00	6	270	1000	384	204	1,24	9,60	2,64	-	259	-	298
	6	270	1200	456	240	1,24	11,40	3,12	-	285	-	328
	6	270	1500	564	294	1,25	14,40	3,84	-	323	-	371
	6	270	1600	600	312	1,26	15,00	4,08	-	335	-	385
	6	270	1800	660	342	1,26	16,80	4,56	-	362	-	416
	6	270	2000	738	384	1,27	18,60	4,98	-	388	-	446
	6	270	2200	810	420	1,27	20,40	5,46	-	413	-	475
	6	270	2500	912	474	1,28	23,40	6,18	-	451	-	519
	6	270	3000	1092	558	1,29	27,60	7,32	-	515	-	592
378 036 100 XX YY 00	8	360	1000	512	272	1,24	12,80	3,52	-	321	-	369
	8	360	1200	608	320	1,24	15,20	4,16	-	357	-	411
	8	360	1500	752	392	1,25	19,20	5,12	-	407	-	468
	8	360	1600	800	416	1,26	20,00	5,44	-	424	-	488
	8	360	1800	880	456	1,26	22,40	6,08	-	457	-	526
	8	360	2000	984	512	1,27	24,80	6,64	-	489	-	562
	8	360	2200	1080	560	1,27	27,20	7,28	-	524	-	603
	8	360	2500	1216	632	1,28	31,20	8,24	-	576	-	662
	8	360	3000	1456	744	1,29	36,80	9,76	-	662	-	761
378 045 100 XX YY 00	10	450	1000	640	340	1,24	16,00	4,40	-	380	-	437
	10	450	1200	760	400	1,24	19,00	5,20	-	426	-	490
	10	450	1500	940	490	1,25	24,00	6,40	-	491	-	565
	10	450	1600	1000	520	1,26	25,00	6,80	-	512	-	589
	10	450	1800	1100	570	1,26	28,00	7,60	-	553	-	636
	10	450	2000	1230	640	1,27	31,00	8,30	-	594	-	683
	10	450	2200	1350	700	1,27	34,00	9,10	-	636	-	731
	10	450	2500	1520	790	1,28	39,00	10,30	-	704	-	810
	10	450	3000	1820	930	1,29	46,00	12,20	-	805	-	926
378 054 100 XX YY 00	12	540	1000	768	408	1,24	19,20	5,28	-	441	-	507
	12	540	1200	912	480	1,24	22,80	6,24	-	495	-	569
	12	540	1500	1128	588	1,25	28,80	7,68	-	570	-	656
	12	540	1600	1200	624	1,26	30,00	8,16	-	595	-	684
	12	540	1800	1320	684	1,26	33,60	9,12	-	649	11378-01	746
	12	540	2000	1476	768	1,27	37,20	9,96	-	694	11378-02	798
	12	540	2200	1620	840	1,27	40,80	10,92	-	750	-	863
	12	540	2500	1824	948	1,28	46,80	12,36	-	824	-	948
	12	540	3000	2184	1116	1,29	55,20	14,64	-	954	-	1097

Conform EN442-1: 2014: radiatoren en convectoren

Voor meer details over onze artikel-data, zie artikel-database: <https://www.installdata.be>
Voor de warmteafgiftes van andere regimes, kijkt u op p. 346 (correctiefactoren)
BELGIË. Prijzen in euro (excl. BTW)

TULIPA-A VERTICAAL (TV1-A)



TV1-A

HOE TULIPA-A VERTICAAL BESTELLEN

Leveringstermijn 15 - 30 werkdagen
(zonder transportduur)

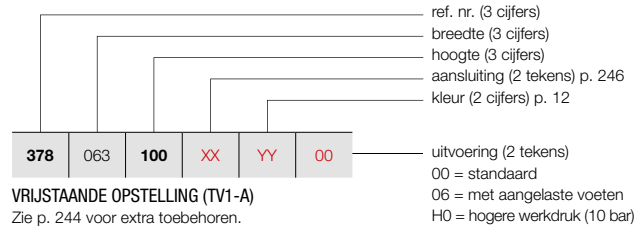

VRIJSTAANDE OPSTELLING (TV1-A)

Zie p. 244 voor extra toebehoren.

PRIJSGROEP: VPG2 - STAAL DESIGNRADIATOREN

BESTELCODE MAATWERK TULIPA-A VERTICAAL							TECHNISCHE GEGEVENS					STANDAARDKLEUR	ANDERE KLEUREN				
378	063	100	XX	YY	00	buizen	breedte (L mm)	hoogte (H mm)	75/65/20 (Watt) (Φ50K)	55/45/20 (Watt) (Φ30K)	n-exp.	gewicht (kg)	inhoud (l)	el. weerst. (Watt)	prijs RAL 9016 (€)	prijs kleur (€)	
REF. NR. TULIPA-A VERTICAAL TV1-A : 378																	
378	063	100	XX	YY	00	14	630	1000	896	476	1,24	22,40	6,16	-	507	583	
		120				14	630	1200	1064	560	1,24	26,60	7,28	-	564	649	
		150				14	630	1500	1316	686	1,25	33,60	8,96	-	654	752	
		160				14	630	1600	1400	728	1,26	35,00	9,52	-	685	788	
		180				14	630	1800	1540	798	1,26	39,20	10,64	-	743	854	
		200				14	630	2000	1722	896	1,27	43,40	11,62	-	801	921	
		220				14	630	2200	1890	980	1,27	47,60	12,74	-	863	992	
		250				14	630	2500	2128	1106	1,28	54,60	14,42	-	950	1093	
		300				14	630	3000	2548	1302	1,29	64,40	17,08	-	1096	1260	
378	072	100	XX	YY	00	16	720	1000	1024	544	1,24	25,60	7,04	-	567	652	
		120				16	720	1200	1216	640	1,24	30,40	8,32	-	634	729	
		150				16	720	1500	1504	784	1,25	38,40	10,24	-	734	844	
		160				16	720	1600	1600	832	1,26	40,00	10,88	-	768	883	
		180				16	720	1800	1760	912	1,26	44,80	12,16	-	836	961	
		200				16	720	2000	1968	1024	1,27	49,60	13,28	-	904	1040	
		220				16	720	2200	2160	1120	1,27	54,40	14,56	-	973	1119	
		250				16	720	2500	2432	1264	1,28	62,40	16,48	-	1076	1237	
		300				16	720	3000	2912	1488	1,29	73,60	19,52	-	1245	1432	
378	081	100	XX	YY	00	18	810	1000	1152	612	1,24	28,80	7,92	-	625	719	
		120				18	810	1200	1368	720	1,24	34,20	9,36	-	703	808	
		150				18	810	1500	1692	882	1,25	43,20	11,52	-	816	938	
		160				18	810	1600	1800	936	1,26	45,00	12,24	-	853	981	
		180				18	810	1800	1980	1026	1,26	50,40	13,68	-	932	1072	
		200				18	810	2000	2214	1152	1,27	55,80	14,94	-	1010	1162	
		220				18	810	2200	2430	1260	1,27	61,20	16,38	-	1085	1248	
		250				18	810	2500	2736	1422	1,28	70,20	18,54	-	1201	1381	
		300				18	810	3000	3276	1674	1,29	82,80	21,96	-	1392	1601	
378	090	100	XX	YY	00	20	900	1000	1280	680	1,24	32,00	8,80	-	688	791	
		120				20	900	1200	1520	800	1,24	38,00	10,40	-	771	887	
		150				20	900	1500	1880	980	1,25	48,00	12,80	-	900	1035	
		160				20	900	1600	2000	1040	1,26	50,00	13,60	-	945	1087	
		180				20	900	1800	2200	1140	1,26	56,00	15,20	-	1029	1183	
		200				20	900	2000	2460	1280	1,27	62,00	16,60	-	1111	1278	
		220				20	900	2200	2700	1400	1,27	68,00	18,20	-	1198	1378	
		250				20	900	2500	3040	1580	1,28	78,00	20,60	-	1323	1521	
		300				20	900	3000	3640	1860	1,29	92,00	24,40	-	1537	1768	

Conform EN442-1: 2014: radiatoren en convectoren

Voor meer details over onze artikel-data, zie artikel-database: <https://www.installdata.be>

Voor de warmteafgifte van andere regimes, kijkt u op p. 346 (correctiefactoren)
BELGIË. Prijzen in euro (excl. BTW)

HOE TULIPA-A VERTICAAL BESTELLEN

Leveringstermijn 15 - 30 werkdagen
(zonder transportduur)

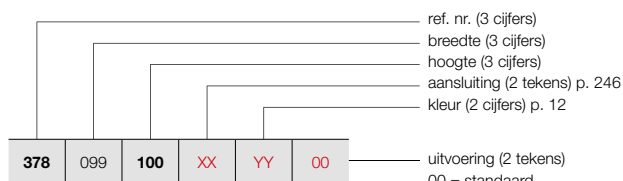

VRIJSTAANDE OPSTELLING (TV1-A)

Zie p. 244 voor extra toebehoren.

TULIPA-A VERTICAAL (TV1-A)



TV1-A

PRIJSGROEP: VPG2 - STAAL DESIGNRADIATOREN

BESTELCODE MAATWERK TULIPA-A VERTICAAL	TECHNISCHE GEGEVENS							STANDAARDKLEUR		ANDERE KLEUREN	
	buizen	breedte (L mm)	hoogte (H mm)	75/65/20 (Watt) (Φ50K)	55/45/20 (Watt) (Φ30K)	n-exp.	gewicht (kg)	inhoud (l)	el. weerst. (Watt)	prijs RAL 9016 (€)	prijs kleur (€)
REF. NR. TULIPA-A VERTICAAL TV1-A : 378											
378	099	100	XX	YY	00						
		120								750	863
		150								841	967
		160								982	1129
		180								1030	1185
		200								1123	1291
		220								1215	1397
		250								1311	1508
										1448	1665
378	108	100	XX	YY	00						
		120								810	932
		150								912	1049
		160								1066	1226
		180								1118	1286
		200								1216	1398
		220								1318	1516
										1420	1633
378	117	100	XX	YY	00						
		120								872	1003
		150								984	1132
		160								1147	1319
		180								1203	1383
		200								1313	1510
										1422	1635
378	126	100	XX	YY	00						
		120								932	1072
		150								1050	1208
		160								1227	1411
		180								1286	1479
										1408	1619

Conform EN442-1: 2014: radiatoren en convectoren

Voor meer details over onze artikel-data, zie artikel-database: <https://www.installdata.be>

Voor de warmteafgiftes van andere regimes, kijkt u op p. 346 (correctiefactoren)

BELGIË. Prijzen in euro (excl. BTW)

TULIPA-A VERTICAAL (TV2-A)



TV2-A

HOE TULIPA-A VERTICAAL BESTELLEN

Leveringstermijn 15 - 30 werkdagen
(zonder transportduur)

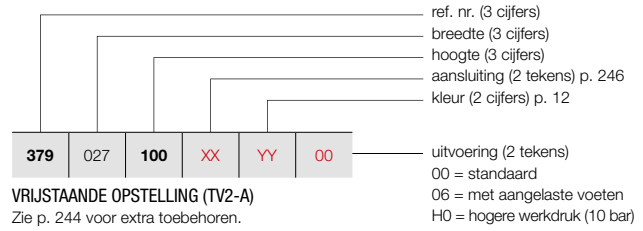

VRIJSTAANDE OPSTELLING (TV2-A)

Zie p. 244 voor extra toebehoren.

HOE VOORRAADRADIATOR VIOLA-A VERTICAAL BESTELLEN

Leveringstermijn 5 werkdagen
(zonder transportduur)

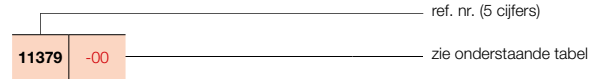

PRIJSGROEP: VPG2 - STAAL DESIGNRADIATOREN

BESTELCODE MAATWERK TULIPA-A VERTICAAL	TECHNISCHE GEGEVENS									STANDAARDKLEUR		ANDERE KLEUREN					
	buizen	breedte (L mm)	hoogte (H mm)	75/65/20 (Watt) (Φ50K)	55/45/20 (Watt) (Φ30K)	n-exp.	gewicht (kg)	inhoud (l)	el. weerst. (Watt)	prijs RAL 9016 (€)	verkorte ref. nr. RAL 9016 voorraad		prijs kleur (€)				
REF. NR. TULIPA-A VERTICAAL TV2-A : 379																	
379	027	100	XX	YY	00	6	270	1000	636	330	1,26	18,60	4,98	-	455	-	523
		120				6	270	1200	750	390	1,26	22,20	5,94	-	499	-	574
		150				6	270	1500	924	480	1,27	27,60	7,32	-	567	-	652
		160				6	270	1600	984	504	1,28	29,40	7,80	-	589	-	677
		180				6	270	1800	1134	582	1,28	33,00	8,70	-	629	-	723
		200				6	270	2000	1212	624	1,29	36,60	9,66	-	680	-	782
		220				6	270	2200	1326	684	1,29	40,20	10,56	-	724	-	833
		250				6	270	2500	1500	768	1,30	45,60	12,00	-	790	-	909
		300				6	270	3000	1788	906	1,31	54,60	14,34	-	900	-	1035
379	036	100	XX	YY	00	8	360	1000	848	440	1,26	24,80	6,64	-	561	-	645
		120				8	360	1200	1000	520	1,26	29,60	7,92	-	619	-	712
		150				8	360	1500	1232	640	1,27	36,80	9,76	-	712	-	819
		160				8	360	1600	1312	672	1,28	39,20	10,40	-	739	-	850
		180				8	360	1800	1512	776	1,28	44,00	11,60	-	799	-	919
		200				8	360	2000	1616	832	1,29	48,80	12,88	-	860	-	989
		220				8	360	2200	1768	912	1,29	53,60	14,08	-	919	-	1057
		250				8	360	2500	2000	1024	1,30	60,80	16,00	-	1007	-	1158
		300				8	360	3000	2384	1208	1,31	72,80	19,12	-	1159	-	1333
379	045	100	XX	YY	00	10	450	1000	1060	550	1,26	31,00	8,30	-	667	-	767
		120				10	450	1200	1250	650	1,26	37,00	9,90	-	740	-	851
		150				10	450	1500	1540	800	1,27	46,00	12,20	-	855	-	983
		160				10	450	1600	1640	840	1,28	49,00	13,00	-	891	-	1025
		180				10	450	1800	1890	970	1,28	55,00	14,50	-	968	-	1113
		200				10	450	2000	2020	1040	1,29	61,00	16,10	-	1041	-	1197
		220				10	450	2200	2210	1140	1,29	67,00	17,60	-	1115	-	1282
		250				10	450	2500	2500	1280	1,30	76,00	20,00	-	1228	-	1412
		300				10	450	3000	2980	1510	1,31	91,00	23,90	-	1412	-	1624
379	054	100	XX	YY	00	12	540	1000	1272	660	1,26	37,20	9,96	-	773	-	889
		120				12	540	1200	1500	780	1,26	44,40	11,88	-	866	-	996
		150				12	540	1500	1848	960	1,27	55,20	14,64	-	1000	-	1150
		160				12	540	1600	1968	1008	1,28	58,80	15,60	-	1044	-	1201
		180				12	540	1800	2268	1164	1,28	66,00	17,40	-	1132	-	1302
		200				12	540	2000	2424	1248	1,29	73,20	19,32	-	1218	11379-01	1401
		220				12	540	2200	2652	1368	1,29	80,40	21,12	-	1311	-	1508
		250				12	540	2500	3000	1536	1,30	91,20	24,00	-	1445	-	1662
		300				12	540	3000	3576	1812	1,31	109,20	28,68	-	1671	-	1922

Conform EN442-1: 2014: radiatoren en convectoren

Voor meer details over onze artikel-data, zie artikel-database: <https://www.installdata.be>

Voor de warmteafgifte van andere regimes, kijkt u op p. 346 (correctiefactoren)
BELGIË. Prijzen in euro (excl. BTW)

HOE TULIPA-A VERTICAAL BESTELLEN

Leveringstermijn 15 - 30 werkdagen
(zonder transportduur)

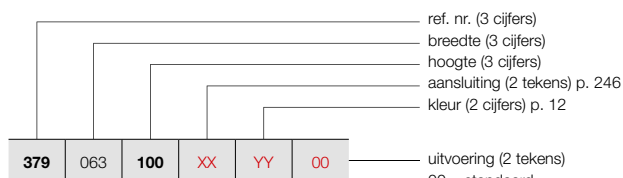

VRIJSTAANDE OPSTELLING (TV2-A)

Zie p. 244 voor extra toebehoren.

HOE VOORRAADRADIATOR VIOLA-A VERTICAAL BESTELLEN

Leveringstermijn 5 werkdagen
(zonder transportduur)

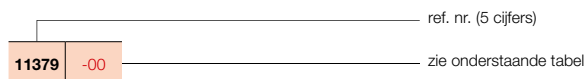

TULIPA-A VERTICAAL (TV2-A)



TV2-A

PRIJSGROEP: VPG2 - STAAL DESIGNRADIATOREN

BESTELCODE MAATWERK TULIPA-A VERTICAAL	TECHNISCHE GEGEVENS							STANDAARDKLEUR		ANDERE KLEUREN		
	buizen	breedte (L mm)	hoogte (H mm)	75/65/20 (Watt) (Φ50K)	55/45/20 (Watt) (Φ30K)	n-exp.	gewicht (kg)	inhoud (l)	el. weerst. (Watt)		prijs RAL 9016 (€)	verkorte ref. nr. RAL 9016 voorraad
REF. NR. TULIPA-A VERTICAAL TV2-A : 379												
379	063	100	XX	YY	00							
		120								882	-	1014
		150								988	-	1136
		160								1144	-	1316
		180								1197	-	1377
		200								1298	-	1493
		220								1406	11379-02	1617
		250								1508	-	1734
		300								1663	-	1912
										1922	-	2210
379	072	100	XX	YY	00							
		120								990	-	1139
		150								1109	-	1275
		160								1289	-	1482
		180								1348	-	1550
		200								1462	-	1681
		220								1581	-	1818
		250								1702	-	1957
		300								1882	-	2164
										2178	-	2505
379	081	100	XX	YY	00							
		120								1095	-	1259
		150								1232	-	1417
		160								1428	-	1642
		180								1495	-	1719
		200								1630	-	1875
		220								1766	-	2031
		250								1901	-	2186
		300								2102	-	2417
										2438	-	2804
379	090	100	XX	YY	00							
		120								1204	-	1385
		150								1352	-	1555
		160								1574	-	1810
		180								1649	-	1896
		200								1798	-	2068
		220								1946	-	2238
		250								2096	-	2410
		300								2320	-	2668
										2690	-	3094

Conform EN442-1: 2014: radiatoren en convectoren

Voor meer details over onze artikel-data, zie artikel-database: <https://www.installdata.be>
Voor de warmteafgiftes van andere regimes, kijkt u op p. 346 (correctiefactoren)
BELGIË. Prijzen in euro (excl. BTW)

TULIPA-A VERTICAAL (TV2-A)



TV2-A

HOE TULIPA-A VERTICAAL BESTELLEN

Leveringstermijn 15 - 30 werkdagen
(zonder transportduur)

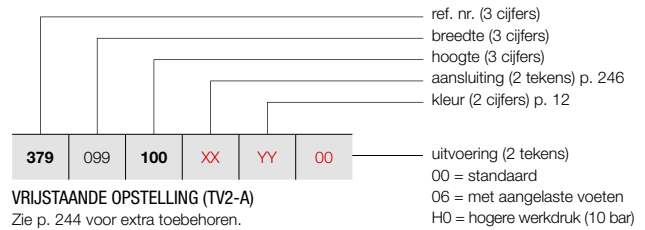

VRIJSTAANDE OPSTELLING (TV2-A)

Zie p. 244 voor extra toebehoren.

PRIJSGROEP: VPG2 - STAAL DESIGNRADIATOREN

BESTELCODE MAATWERK TULIPA-A VERTICAAL							TECHNISCHE GEGEVENS					STANDAARDKLEUR	ANDERE KLEUREN				
379	099	100	XX	YY	00	buizen	breedte (L mm)	hoogte (H mm)	75/65/20 (Watt Ø50K)	55/45/20 (Watt Ø30K)	n-exp.	gewicht (kg)	inhoud (l)	el. weerst. (Watt)	prijs RAL 9016 (€)	prijs kleur (€)	
REF. NR. TULIPA-A VERTICAAL TV2-A : 379																	
379	099	100	XX	YY	00	22	990	1000	2332	1210	1,26	68,20	18,26	-	1311	1508	
		120				22	990	1200	2750	1430	1,26	81,40	21,78	-	1474	1695	
		150				22	990	1500	3388	1760	1,27	101,20	26,84	-	1719	1977	
		160				22	990	1600	3608	1848	1,28	107,80	28,60	-	1801	2071	
		180				22	990	1800	4158	2134	1,28	121,00	31,90	-	1966	2261	
		200				22	990	2000	4444	2288	1,29	134,20	35,42	-	2131	2451	
		220				22	990	2200	4862	2508	1,29	147,40	38,72	-	2294	2638	
		250				22	990	2500	5500	2816	1,30	167,20	44,00	-	2535	2915	
379	108	100	XX	YY	00	24	1080	1000	2544	1320	1,26	74,40	19,92	-	1416	1628	
		120				24	1080	1200	3000	1560	1,26	88,80	23,76	-	1595	1834	
		150				24	1080	1500	3696	1920	1,27	110,40	29,28	-	1864	2144	
		160				24	1080	1600	3936	2016	1,28	117,60	31,20	-	1955	2248	
		180				24	1080	1800	4536	2328	1,28	132,00	34,80	-	2132	2452	
		200				24	1080	2000	4848	2496	1,29	146,40	38,64	-	2308	2654	
		220				24	1080	2200	5304	2736	1,29	160,80	42,24	-	2487	2860	
379	117	100	XX	YY	00	26	1170	1000	2756	1430	1,26	80,60	21,58	-	1524	1753	
		120				26	1170	1200	3250	1690	1,26	96,20	25,74	-	1718	1976	
		150				26	1170	1500	4004	2080	1,27	119,60	31,72	-	2008	2309	
		160				26	1170	1600	4264	2184	1,28	127,40	33,80	-	2104	2420	
		180				26	1170	1800	4914	2522	1,28	143,00	37,70	-	2297	2642	
		200				26	1170	2000	5252	2704	1,29	158,60	41,86	-	2490	2864	
379	126	100	XX	YY	00	28	1260	1000	2968	1540	1,26	86,80	23,24	-	1630	1875	
		120				28	1260	1200	3500	1820	1,26	103,60	27,72	-	1837	2113	
		150				28	1260	1500	4312	2240	1,27	128,80	34,16	-	2150	2473	
		160				28	1260	1600	4592	2352	1,28	137,20	36,40	-	2253	2591	
		180				28	1260	1800	5292	2716	1,28	154,00	40,60	-	2460	2829	

Conform EN442-1: 2014: radiatoren en convectoren

Voor meer details over onze artikel-data, zie artikel-database: <https://www.installdata.be>

Voor de warmteafgifte van andere regimes, kijkt u op p. 346 (correctiefactoren)
BELGIË. Prijzen in euro (excl. BTW)

TYPES

- Eén (TH1-A) of twee rijen buizen (TH2-A)

BUIZEN

- Verticaal, platovaal 60 x 10 mm

COLLECTOREN

- Horizontaal, achterliggend, rond Ø 32 mm

KLEUREN

- Standaardkleur wit RAL 9016
- Uitgebreide kleurenkaart zie p. 12

SPECIAAL

- TH1-A ook verkrijgbaar als toiletradiator (540 x 500 mm)

BEVESTIGINGEN

- Muurbevestigingen standaard (inbegrepen in de verpakking van de radiator)
- **TH1-A / TH2-A:** ook verkrijgbaar als vrijstaande opstelling, zie p. 244. Extra muurbevestigingssteun nodig voor hoogte radiator > 600 mm.

TECHNISCH

- Weerstandsgelast (onzichtbare lasnaden)
- ATL-grondlaag, poedercoating
- Standaardwerkdruk: 6 bar. Meerprijs hogere werkdruk (10 bar): +10%.
- De leveringstermijn van radiator met een hogere werkdruk is 1 week extra.
- Maximale bedrijfstemperatuur: 110°C

ELEKTRISCH

- ✗ Zuiver elektrische radiator in de fabriek voorgevuld
- ✗ Gemengde radiator

TECHNISCHE TEKENINGEN

- Zie p. 247

AANSLUITING

- ✗ Eénpuntsaansluiting voor éénpijpssysteem
- ✗ Eénpuntsaansluiting voor tweepijpssysteem
- ✓ Tweepuntsaansluiting voor éénpijpssysteem (aansluiting via de middenaansluiting) (zie p. 340)
- ✓ Tweepuntsaansluiting voor tweepijpssysteem (standaard) (zie p. 340)
- ✗ Geïntegreerd ventiel
- Aansluitingen: ½" (binnendraad)



TULIPA-A HORIZONTAAL

Eeuwige charme, tijdloze klasse

De horizontale versie van de Tulipa-A. Het schoolvoorbeeld van een designradiator in zijn meest authentieke vorm. Gekenmerkt door de klassieke open structuur en de loodrechte aansluiting van de buizen op de collector. Een designradiator die blijft charmeren. Trendoverstijgend en overall toepasbaar.

AANBEVOLEN AANSLUITING (18)

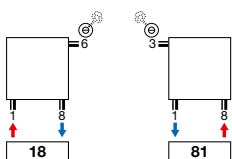

Andere aansluitmogelijkheden, zie p. 246



art. nr. 1182 101 0000 0099
prijs €215
 Koppelingen, zie p. 353

AANBEVOLEN VOOR BADKAMER EN KEUKEN IN OPTIE



handdoekbeugel (RAL 9005)
 art. nr. zie p. 245
prijs €145
 Andere accessoires, zie p. 245



TH1-A / TH2-A

TULIPA-A HORIZONTAAL (TH1-A)

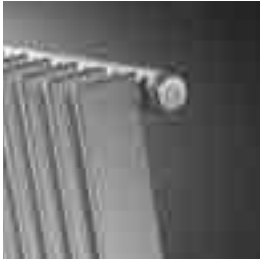

TH1-A

HOE TULIPA-A HORIZONTAAL BESTELLEN

Leveringstermijn 15 - 30 werkdagen
(zonder transportduur)

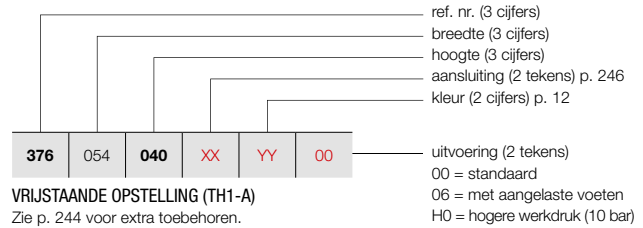

VRIJSTAANDE OPSTELLING (TH1-A)
Zie p. 244 voor extra toebehoren.

PRIJSGROEP: VPG2 - STAAL DESIGNRADIATOREN

BESTELCODE MAATWERK TULIPA-A HORIZONTAAL							TECHNISCHE GEGEVENS					STANDAARDKLEUR	ANDERE KLEUREN				
376	054	040	XX	YY	00	buizen	breedte (L mm)	hoogte (H mm)	75/65/20 (Watt) (Φ50K)	55/45/20 (Watt) (Φ30K)	n-exp.	gewicht (kg)	inhoud (l)	el. weerst. (Watt)	prijs RAL 9016 (€)	prijs kleur (€)	
REF. NR. TULIPA-A HORIZONTAAL TH1-A : 376																	
376	054	040	XX	YY	00	12	540	400	348	180	1,22	9,60	2,52	-	292	336	
		050				12	540	500	420	216	1,23	10,80	3,00	-	316	363	
		060				12	540	600	492	264	1,23	12,00	3,48	-	342	393	
		070				12	540	700	564	300	1,23	14,40	3,96	-	365	420	
		080				12	540	800	636	336	1,23	15,60	4,44	-	393	452	
		090				12	540	900	696	372	1,24	18,00	4,92	-	419	482	
376	063	040	XX	YY	00	14	630	400	406	210	1,22	11,20	2,94	-	324	373	
		050				14	630	500	490	252	1,23	12,60	3,50	-	357	411	
		060				14	630	600	574	308	1,23	15,40	4,06	-	384	442	
		070				14	630	700	658	350	1,23	16,80	4,62	-	414	476	
		080				14	630	800	742	392	1,23	18,20	5,18	-	445	512	
		090				14	630	900	812	434	1,24	21,00	5,74	-	473	544	
376	072	040	XX	YY	00	16	720	400	464	240	1,22	12,80	3,36	-	362	416	
		050				16	720	500	560	288	1,23	14,40	4,00	-	395	454	
		060				16	720	600	656	352	1,23	17,60	4,64	-	431	496	
		070				16	720	700	752	400	1,23	19,20	5,28	-	463	532	
		080				16	720	800	848	448	1,23	20,80	5,92	-	498	573	
		090				16	720	900	928	496	1,24	24,00	6,56	-	530	610	
376	081	040	XX	YY	00	18	810	400	522	270	1,22	14,40	3,78	-	396	455	
		050				18	810	500	630	324	1,23	16,20	4,50	-	434	499	
		060				18	810	600	738	396	1,23	19,80	5,22	-	473	544	
		070				18	810	700	846	450	1,23	21,60	5,94	-	513	590	
		080				18	810	800	954	504	1,23	23,40	6,66	-	552	635	
		090				18	810	900	1044	558	1,24	27,00	7,38	-	589	677	
376	090	040	XX	YY	00	20	900	400	580	300	1,22	16,00	4,20	-	433	498	
		050				20	900	500	700	360	1,23	18,00	5,00	-	474	545	
		060				20	900	600	820	440	1,23	22,00	5,80	-	518	596	
		070				20	900	700	940	500	1,23	24,00	6,60	-	559	643	
		080				20	900	800	1060	560	1,23	26,00	7,40	-	604	695	
		090				20	900	900	1160	620	1,24	30,00	8,20	-	647	744	
376	099	040	XX	YY	00	22	990	400	638	330	1,22	17,60	4,62	-	469	539	
		050				22	990	500	770	396	1,23	19,80	5,50	-	515	592	
		060				22	990	600	902	484	1,23	24,20	6,38	-	561	645	
		070				22	990	700	1034	550	1,23	26,40	7,26	-	608	699	
		080				22	990	800	1166	616	1,23	28,60	8,14	-	656	754	
		090				22	990	900	1276	682	1,24	33,00	9,02	-	700	805	
376	108	040	XX	YY	00	24	1080	400	696	360	1,22	19,20	5,04	-	507	583	
		050				24	1080	500	840	432	1,23	21,60	6,00	-	555	638	
		060				24	1080	600	984	528	1,23	26,40	6,96	-	606	697	
		070				24	1080	700	1128	600	1,23	28,80	7,92	-	657	756	
		080				24	1080	800	1272	672	1,23	31,20	8,88	-	708	814	
		090				24	1080	900	1392	744	1,24	36,00	9,84	-	758	872	

Conform EN442-1: 2014: radiatoren en convectoren

Voor meer details over onze artikel-data, zie artikel-database: <https://www.installdata.be>

Voor de warmteafgifte van andere regimes, kijkt u op p. 346 (correctiefactoren)
BELGIË. Prijzen in euro (excl. BTW)

HOE TULIPA-A HORIZONTAAL BESTELLEN

Leveringstermijn 15 - 30 werkdagen
(zonder transportduur)

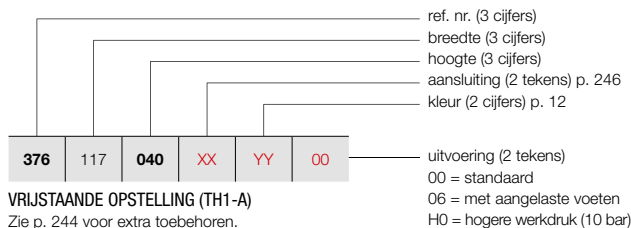

VRIJSTAANDE OPSTELLING (TH1-A)
Zie p. 244 voor extra toebehoren.

TULIPA-A HORIZONTAAL (TH1-A)

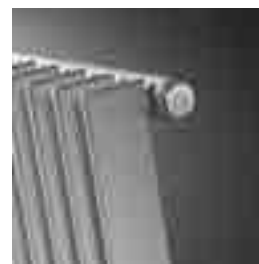

TH1-A

PRIJSGROEP: VPG2 - STAAL DESIGNRADIATOREN

BESTELCODE MAATWERK TULIPA-A HORIZONTAAL	TECHNISCHE GEGEVENS							STANDAARDKLEUR		ANDERE KLEUREN	
	buizen	breedte (L mm)	hoogte (H mm)	75/65/20 (Watt) (Φ50K)	55/45/20 (Watt) (Φ30K)	n-exp.	gewicht (kg)	inhoud (l)	el. weerst. (Watt)	prijs RAL 9016 (€)	prijs kleur (€)
REF. NR. TULIPA-A HORIZONTAAL TH1-A : 376											
376	117	040	XX	YY	00						
		050									
		060									
		070									
		080									
		090									
376	126	040	XX	YY	00						
		050									
		060									
		070									
		080									
		090									
376	144	040	XX	YY	00						
		050									
		060									
		070									
		080									
		090									
376	162	040	XX	YY	00						
		050									
		060									
		070									
		080									
		090									
376	180	040	XX	YY	00						
		050									
		060									
		070									
		080									
		090									
376	198	040	XX	YY	00						
		050									
		060									
		070									
		080									
		090									
376	216	040	XX	YY	00						
		050									
		060									
		070									
		080									
		090									

Conform EN442-1: 2014: radiatoren en convectoren

Voor meer details over onze artikel-data, zie artikel-database: <https://www.installdata.be>
Voor de warmteafgiftes van andere regimes, kijkt u op p. 346 (correctiefactoren)
BELGIË. Prijzen in euro (excl. BTW)

TULIPA-A HORIZONTAAL (TH1-A)

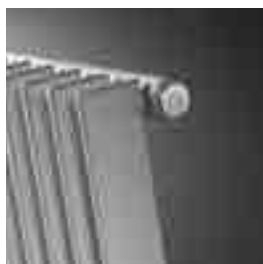

TH1-A

HOE TULIPA-A HORIZONTAAL BESTELLEN

Leveringstermijn 15 - 30 werkdagen
(zonder transportduur)

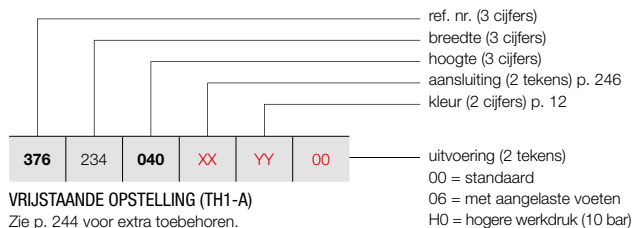

VRIJSTAANDE OPSTELLING (TH1-A)

Zie p. 244 voor extra toebehoren.

PRIJSGROEP: VPG2 - STAAL DESIGNRADIATOREN

BESTELCODE MAATWERK TULIPA-A HORIZONTAAL	TECHNISCHE GEGEVENS									STANDAARDKLEUR	ANDERE KLEUREN
	buizen	breedte (L mm)	hoogte (H mm)	75/65/20 (Watt (Φ50K))	55/45/20 (Watt (Φ30K))	n-exp.	gewicht (kg)	inhoud (l)	el. weerst. (Watt)	prijs RAL 9016 (€)	prijs kleur (€)
REF. NR. TULIPA-A HORIZONTAAL TH1-A : 376											
376	234	040	XX	YY	00						
		050									
		060									
		070									
		080									
		090									
376	252	040	XX	YY	00						
		050									
		060									
		070									
		080									
		090									
376	270	040	XX	YY	00						
		050									
		060									
		070									
		080									
376	288	040	XX	YY	00						
		050									
		060									
		070									
376	306	040	XX	YY	00						
		050									
		060									
		070									

Conform EN442-1: 2014: radiatoren en convectoren

Voor meer details over onze artikel-data, zie artikel-database: <https://www.installdata.be>

Voor de warmteafgiftes van andere regimes, kijkt u op p. 346 (correctiefactoren)
BELGIË. Prijzen in euro (excl. BTW)

HOE TULIPA-A HORIZONTAAL BESTELLEN

Leveringstermijn 15 - 30 werkdagen
(zonder transportduur)

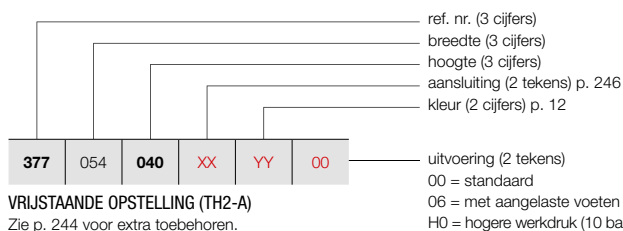

VRIJSTAANDE OPSTELLING (TH2-A)

Zie p. 244 voor extra toebehoren.

TULIPA-A HORIZONTAAL (TH2-A)



TH2-A

PRIJSGROEP: VPG2 - STAAL DESIGNRADIATOREN

BESTELCODE MAATWERK TULIPA-A HORIZONTAAL	TECHNISCHE GEGEVENS							STANDAARDKLEUR		ANDERE KLEUREN	
	buizen	breedte (L mm)	hoogte (H mm)	75/65/20 (Watt) (Φ50K)	55/45/20 (Watt) (Φ30K)	n-exp.	gewicht (kg)	inhoud (l)	el. weerst. (Watt)	prijs RAL 9016 (€)	prijs kleur (€)
REF. NR. TULIPA-A HORIZONTAAL TH2-A : 377											
377	054	040	XX	YY	00						
		050								512	589
		060								554	637
		070								596	685
		080								642	738
		090								687	790
										731	841
377	063	040	XX	YY	00						
		050								570	656
		060								619	712
		070								672	773
		080								727	836
		090								777	894
										831	956
377	072	040	XX	YY	00						
		050								629	723
		060								691	795
		070								752	865
		080								810	932
		090								872	1003
										931	1071
377	081	040	XX	YY	00						
		050								693	797
		060								760	874
		070								831	956
		080								893	1027
		090								962	1106
										1030	1185
377	090	040	XX	YY	00						
		050								758	872
		060								833	958
		070								904	1040
		080								980	1127
		090								1053	1211
										1130	1300
377	099	040	XX	YY	00						
		050								818	941
		060								900	1035
		070								984	1132
		080								1064	1224
		090								1146	1318
										1229	1413
377	108	040	XX	YY	00						
		050								882	1014
		060								972	1118
		070								1056	1214
		080								1148	1320
		090								1241	1427
										1324	1523

Conform EN442-1: 2014: radiatoren en convectoren

Voor meer details over onze artikel-data, zie artikel-database: <https://www.installdata.be>

Voor de warmteafgiftes van andere regimes, kijkt u op p. 346 (correctiefactoren)
BELGIË. Prijzen in euro (excl. BTW)

TULIPA-A HORIZONTAAL (TH2-A)

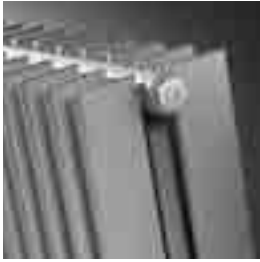

TH2-A

HOE TULIPA-A HORIZONTAAL BESTELLEN

Leveringstermijn 15 - 30 werkdagen
(zonder transportduur)

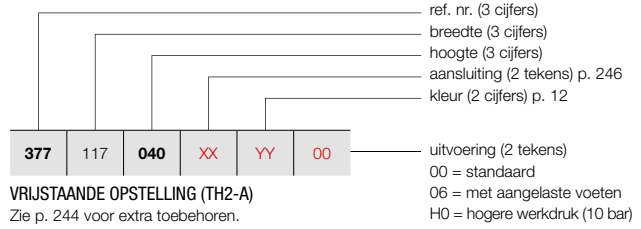

VRIJSTAANDE OPSTELLING (TH2-A)
 Zie p. 244 voor extra toebehoren.

PRIJSGROEP: VPG2 - STAAL DESIGNRADIATOREN

BESTELCODE MAATWERK TULIPA-A HORIZONTAAL							TECHNISCHE GEGEVENS					STANDAARDKLEUR	ANDERE KLEUREN			
377	117	040	XX	YY	00	buizen	breedte (L mm)	hoogte (H mm)	75/65/20 (Watt) (Φ50K)	55/45/20 (Watt) (Φ30K)	n-exp.	gewicht (kg)	inhoud (l)	el. weerst. (Watt)	prijs RAL 9016 (€)	prijs kleur (€)
REF. NR. TULIPA-A HORIZONTAAL TH2-A : 377																
377	117	040	XX	YY	00	26	1170	400	1274	676	1,24	36,40	9,36	-	946	1088
		050				26	1170	500	1404	806	1,25	44,20	11,44	-	1041	1197
		060				26	1170	600	1768	936	1,25	52,00	13,52	-	1137	1308
		070				26	1170	700	2028	1066	1,25	57,20	15,60	-	1233	1418
		080				26	1170	800	2262	1196	1,25	65,00	17,68	-	1333	1533
		090				26	1170	900	2522	1300	1,26	72,80	19,50	-	1429	1643
377	126	040	XX	YY	00	28	1260	400	1372	728	1,24	39,20	10,08	-	1008	1159
		050				28	1260	500	1512	868	1,25	47,60	12,32	-	1111	1278
		060				28	1260	600	1904	1008	1,25	56,00	14,56	-	1214	1396
		070				28	1260	700	2184	1148	1,25	61,60	16,80	-	1318	1516
		080				28	1260	800	2436	1288	1,25	70,00	19,04	-	1422	1635
		090				28	1260	900	2716	1400	1,26	78,40	21,00	-	1527	1756
377	144	040	XX	YY	00	32	1440	400	1568	832	1,24	44,80	11,52	-	1130	1300
		050				32	1440	500	1728	992	1,25	54,40	14,08	-	1251	1439
		060				32	1440	600	2176	1152	1,25	64,00	16,64	-	1365	1570
		070				32	1440	700	2496	1312	1,25	70,40	19,20	-	1489	1712
		080				32	1440	800	2784	1472	1,25	80,00	21,76	-	1606	1847
		090				32	1440	900	3104	1600	1,26	89,60	24,00	-	1724	1983
377	162	040	XX	YY	00	36	1620	400	1764	936	1,24	50,40	12,96	-	1256	1444
		050				36	1620	500	1944	1116	1,25	61,20	15,84	-	1391	1600
		060				36	1620	600	2448	1296	1,25	72,00	18,72	-	1524	1753
		070				36	1620	700	2808	1476	1,25	79,20	21,60	-	1657	1906
		080				36	1620	800	3132	1656	1,25	90,00	24,48	-	1791	2060
		090				36	1620	900	3492	1800	1,26	100,80	27,00	-	1922	2210
377	180	040	XX	YY	00	40	1800	400	1960	1040	1,24	56,00	14,40	-	1378	1585
		050				40	1800	500	2160	1240	1,25	68,00	17,60	-	1528	1757
		060				40	1800	600	2720	1440	1,25	80,00	20,80	-	1677	1929
		070				40	1800	700	3120	1640	1,25	88,00	24,00	-	1825	2099
		080				40	1800	800	3480	1840	1,25	100,00	27,20	-	1975	2271
		090				40	1800	900	3880	2000	1,26	112,00	30,00	-	2122	2440
377	198	040	XX	YY	00	44	1980	400	2156	1144	1,24	61,60	15,84	-	1506	1732
		050				44	1980	500	2376	1364	1,25	74,80	19,36	-	1671	1922
		060				44	1980	600	2992	1584	1,25	88,00	22,88	-	1834	2109
		070				44	1980	700	3432	1804	1,25	96,80	26,40	-	1997	2297
		080				44	1980	800	3828	2024	1,25	110,00	29,92	-	2157	2481
		090				44	1980	900	4268	2200	1,26	123,20	33,00	-	2325	2674
377	216	040	XX	YY	00	48	2160	400	2352	1248	1,24	67,20	17,28	-	1630	1875
		050				48	2160	500	2592	1488	1,25	81,60	21,12	-	1809	2080
		060				48	2160	600	3264	1728	1,25	96,00	24,96	-	1987	2285
		070				48	2160	700	3744	1968	1,25	105,60	28,80	-	2164	2489
		080				48	2160	800	4176	2208	1,25	120,00	32,64	-	2341	2692
		090				48	2160	900	4656	2400	1,26	134,40	36,00	-	2523	2901

Conform EN442-1: 2014: radiatoren en convectoren

Voor meer details over onze artikel-data, zie artikel-database: <https://www.installdata.be>

Voor de warmteafgifte van andere regimes, kijkt u op p. 346 (correctiefactoren)
 BELGIË. Prijzen in euro (excl. BTW)

HOE TULIPA-A HORIZONTAAL BESTELLEN

Leveringstermijn 15 - 30 werkdagen
(zonder transportduur)



377	270	040	XX	YY	00
-----	-----	-----	----	----	----

VRIJSTAANDE OPSTELLING (TH2-A)

Zie p. 244 voor extra toebehoren.

uitvoering (2 tekens)
00 = standaard
06 = met aangelaste voeten
H0 = hogere werkdruk (10 bar)

TULIPA-A HORIZONTAAL (TH2-A)



TH2-A

PRIJSGROEP: VPG2 - STAAL DESIGNRADIATOREN

BESTELCODE MAATWERK TULIPA-A HORIZONTAAL	TECHNISCHE GEGEVENS								STANDAARDKLEUR		ANDERE KLEUREN					
	buizen	breedte (L mm)	hoogte (H mm)	75/65/20 (Watt) (φ50K)	55/45/20 (Watt) (φ30K)	n-exp.	gewicht (kg)	inhoud (l)	el. weerst. (Watt)	prijs RAL 9016 (€)	prijs kleur (€)					
REF. NR. TULIPA-A HORIZONTAAL TH2-A : 377																
377	234	040	XX	YY	00	52	2340	400	2548	1352	1,24	72,80	18,72	-	1755	2018
		050				52	2340	500	2808	1612	1,25	88,40	22,88	-	1948	2240
		060				52	2340	600	3536	1872	1,25	104,00	27,04	-	2139	2460
		070				52	2340	700	4056	2132	1,25	114,40	31,20	-	2333	2683
		080				52	2340	800	4524	2392	1,25	130,00	35,36	-	2527	2906
		090				52	2340	900	5044	2600	1,26	145,60	39,00	-	2722	3130
377	252	040	XX	YY	00	56	2520	400	2744	1456	1,24	78,40	20,16	-	1880	2162
		050				56	2520	500	3024	1736	1,25	95,20	24,64	-	2087	2400
		060				56	2520	600	3808	2016	1,25	112,00	29,12	-	2295	2639
		070				56	2520	700	4368	2296	1,25	123,20	33,60	-	2503	2878
		080				56	2520	800	4872	2576	1,25	140,00	38,08	-	2710	3117
		090				56	2520	900	5432	2800	1,26	156,80	42,00	-	2918	3356
377	270	040	XX	YY	00	60	2700	400	2940	1560	1,24	84,00	21,60	-	2002	2302
		050				60	2700	500	3240	1860	1,25	102,00	26,40	-	2229	2563
		060				60	2700	600	4080	2160	1,25	120,00	31,20	-	2446	2813
		070				60	2700	700	4680	2460	1,25	132,00	36,00	-	2672	3073
		080				60	2700	800	5220	2760	1,25	150,00	40,80	-	2894	3328
377	288	040	XX	YY	00	64	2880	400	3136	1664	1,24	89,60	23,04	-	2131	2451
		050				64	2880	500	3456	1984	1,25	108,80	28,16	-	2366	2721
		060				64	2880	600	4352	2304	1,25	128,00	33,28	-	2605	2996
		070				64	2880	700	4992	2624	1,25	140,80	38,40	-	2841	3267
377	306	040	XX	YY	00	68	3060	400	3332	1768	1,24	95,20	24,48	-	2251	2589
		050				68	3060	500	3672	2108	1,25	115,60	29,92	-	2507	2883
		060				68	3060	600	4624	2448	1,25	136,00	35,36	-	2758	3172
		070				68	3060	700	5304	2788	1,25	149,60	40,80	-	3009	3460

Conform EN442-1: 2014: radiatoren en convectoren

Voor meer details over onze artikel-data, zie artikel-database: <https://www.installdata.be>

Voor de warmteafgiftes van andere regimes, kijkt u op p. 346 (correctiefactoren)

BELGIË. Prijzen in euro (excl. BTW)

TULIPA-A VRIJSTAANDE OPSTELLING

IN OPTIE

PRIJSGROEP: VPG10 - ACC.



VRIJSTAANDE OPSTELLING		KLEUR	ART. NR.	€	
VASTE VOET		TV1-A / TH1-A			
		150 mm	RAL 9016	*	71
		(geen zijbevestiging)	KLEUR	*	82
		TV2-A / TH2-A			
		150 mm	RAL 9016	*	140
		(geen zijbevestiging)	KLEUR	*	161

- Extra muurbevestigingssteun nodig voor hoogte radiator > 600 mm (meegeleverd).
- Gelieve bij bestelling code **06** aan te geven bij "Afwerking" (vaste voet in de prijs inbegrepen).
- Geen rozetten beschikbaar.

	TV1-A / TV2-A	TH1-A / TH2-A		
lengte radiator (mm)		540 - 1440	1620 - 2340	> 2340
aantal voeten	2x	2x	3x	4x

BELGIË. Prijzen in euro (excl. BTW)

PRIJSGROEP: VPG10 - ACC.

ACCESSOIRES		KLEUR	ART. NR.	€
THERMOSTAATKOP		TV1-A / TV2-A		
		WIT	11911630102	44
THERMOSTAATKOP		TV1-A / TV2-A		
		CHROOM	11911631102	60

PRIJSGROEP: VPG10B - HANDDOEKBEUGELS

ACCESSOIRES	BREEDTE HANDDOEKBEUGEL	KLEUR	ART. NR.	€	
HANDDOEKBEUGEL		TV1-A / TV2-A / TH1-A / TH2-A			
		500 mm	CHROOM	1183 269 0000 0099	145
		500 mm	RAL 9016	1183 269 0000 9016	145
		500 mm	RAL 9005 ^M	1183 269 0000 9005	145

- h = 55 mm; b = 500 mm; d = 58 mm; a = 43 mm;

^M mat zwart

Montagevoorschriften accessoires: zie www.vasco.eu
BELGIË. Prijzen in euro (excl. BTW)

d = afstand voorkant accessoire tot voorkant radiator

a = afstand accessoire tot radiator

uit voorraad leverbaar

TULIPA-A AANSLUITINGEN

TULIPA-A VERTICAAL: TV1-A / TV2-A (VOORRAAD)

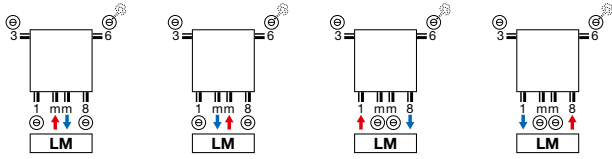

TULIPA-A HORIZONTAAL: TH1-A / TH2-A (NIET-VOORRAAD)

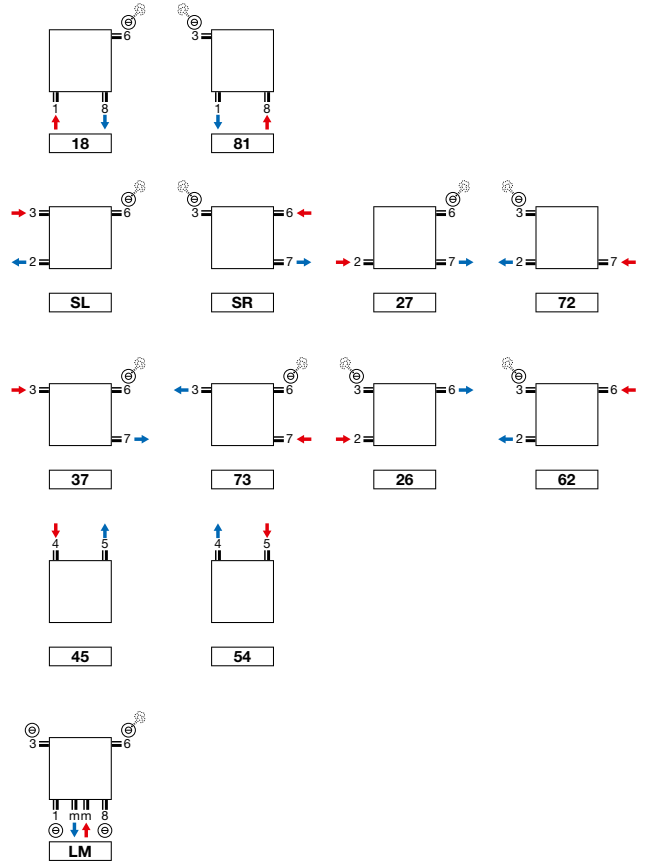

TULIPA-A VERTICAAL: TV1-A / TV2-A (NIET-VOORRAAD)

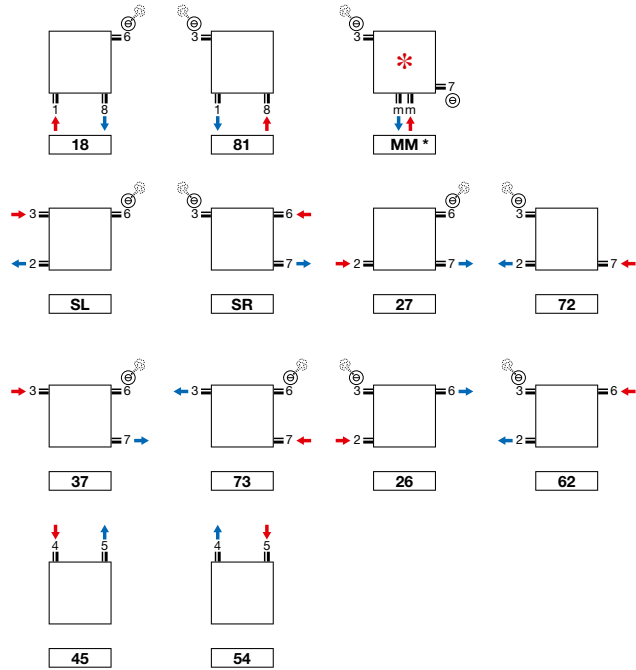

- * Aansluiting MM: aanvoer moet aan de rechterkant!
- Tulipa-A 6 en 8 buizen: aansluiting 1mm8, 18, 81 niet mogelijk

Opmerking: het aansluiten van de radiator kan enkel volgens de getoonde aansluiticonen. Voor elke andere aansluitwijze nemen wij geen verantwoordelijkheid.

TULIPA-A VERTICAAL (TV1-A, TV2-A)

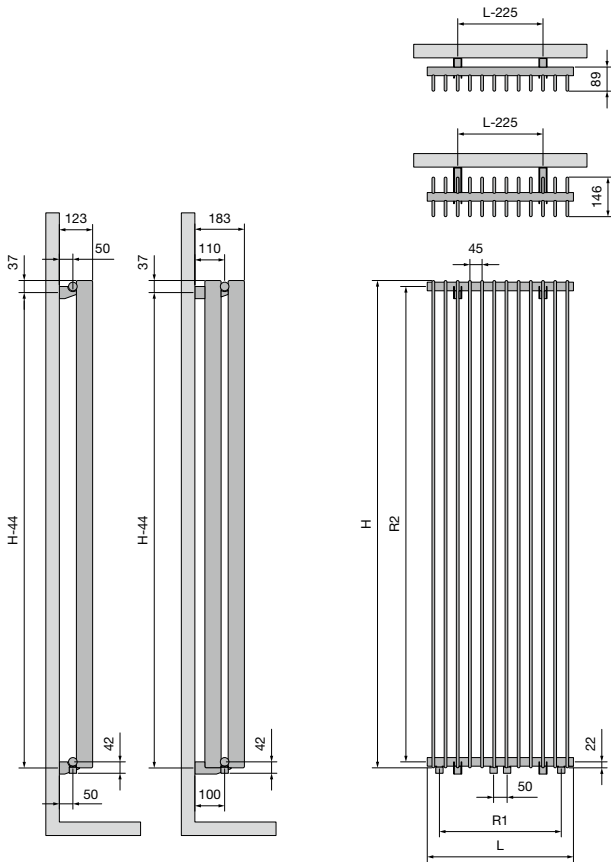

TV1-A / TV2-A

Breedte (L)	270	360	450	540	630	720	810	900	990	1080	1170	1260
Hartafstand tussen de onderaansluitingen 18 (R1)	180	270	360	450	540	630	720	810	900	990	1080	1170
hoogte (H)	1000	1200	1500	1600	1800	2000	2200	2500	3000			
Hartafstand tussen de zijaansluitingen SL/SR (R2)	956	1156	1456	1556	1756	1956	2156	2456	2956			
Hartafstand tussen de ophangingen	H-44											

TULIPA-A HORIZONTAAL (TH1-A, TH2-A)

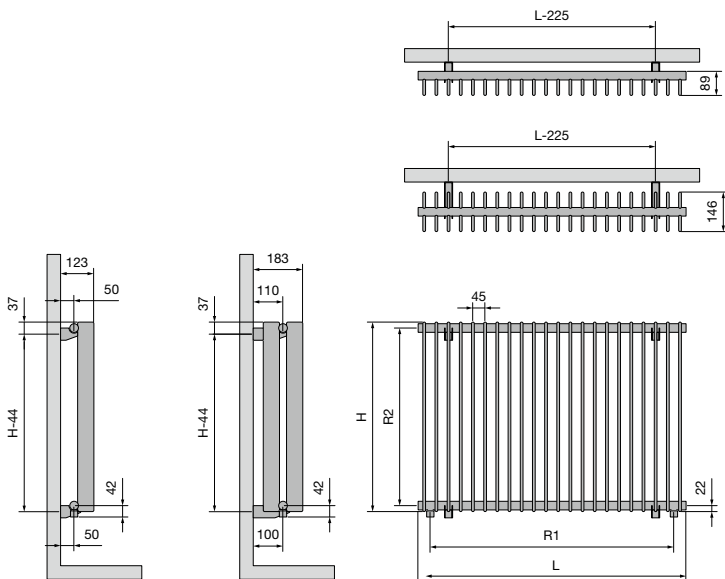

TH1-A / TH2-A

Breedte (L)	540	630	720	810	900	990	1080	1170	1260	1440	1620	1800	1980	2160	2340	2520	2700	2880	3060	
Hartafstand tussen de onderaansluitingen 18 (R1)	450	540	630	720	810	900	990	1080	1170	1350	1530	1710	1890	2070	2250	2430	2610	2790	2970	
hoogte (H)	400	500	600	700	800	900														
Hartafstand tussen de zijaansluitingen SL/SR (R2)	356	456	556	656	756	856														
Hartafstand tussen de ophangingen	H-44																			