

Kolomradiatoren



De VASCO kolomradiator koppelt een groot vermogen aan een snelle warmteafgifte.

Hij kan zowel tegen de wand als vrijstaand worden geïnstalleerd en levert ook topprestaties in combinatie met lage watertemperatuursystemen zoals warmtepompen. **Een retro radiator in de meest duurzame zin van het woord.**

De VASCO kolomradiator is tot in het kleinste detail op een zuinig en duurzaam energieverbruik afgestemd.

Met slimme aansluitingen en bevestigingssystemen en innoverende technologische oplossingen.

Kolomradiatoren

Ritmo	302
Vintage	320

RITMO VERTICAAL (VB-2K/65, VB-3K/105, VB-4K/145)



RITMO VERTICAAL

Hoge warmteafgifte

Met hun hoge warmteafgifte brengen VASCO's Ritmo-kolomradiatoren zelfs de grootste ruimtes in een mum van tijd op de gewenste temperatuur, zonder dat je dat merkt aan je energiefactuur. Door hun groot verwarmingsoppervlak zijn ze uitermate geschikt voor lage temperatuurverwarming. Zo geniet je van aangename temperaturen en een comfortabel binnenklimaat.

TYPES

- 2 / 3 / 4 kolommen
- Bouwdiepte: 65 / 105 / 145 mm
- Bouwhoogte: 1500, 1800, 2000, 2200 mm
- Bouwlengte: 270, 360, 450, 540, 630, 720 mm

BUIZEN

- Verticaal, 25 mm

KLEUREN

- Standaardkleur wit RAL 9016
- Uitgebreide kleurenkaart zie p. 12

BEVESTIGINGEN

- Wandmontage
- Muurbevestigingen standaard
- Bij witte radiatoren wordt standaard een witte klemconsole 30 mm en een witte afstandshouder geleverd
- Bij gekleurde radiatoren wordt standaard een klemconsole 30 mm in de kleur van de radiator en een afstandshouder in RAL 7024 geleverd

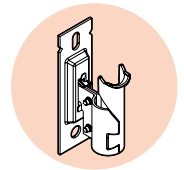

TECHNISCH

- Bestaande uit kopstukken (bandstaal persdelen) en ronde buizen.
- ATL-grondlaag, poedercoating
- Standaardwerkdruk: 10 bar
- Maximale bedrijfstemperatuur: 110°C

TECHNISCHE TEKENINGEN

- Zie p. 318

AANSLUITING

- ✗ Eénpuntsaansluiting voor éénpijpsysteem
- ✗ Eénpuntsaansluiting voor tweepijpsysteem
- ✓ Tweepuntsaansluiting voor éénpijpsysteem (aansluiting via de middenaansluiting) (zie p. 340)
- ✓ Tweepuntsaansluiting voor tweepijpsysteem (standaard) (zie p. 340)
- ✗ Geïntegreerd ventiel
- Aansluitingen: ½" (binnendraad)

AANBEVOLEN AANSLUITING (MM)

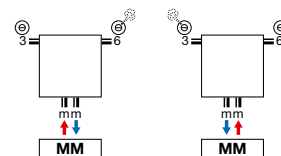

Andere aansluitmogelijkheden, zie p. 317



wit
art. nr. 1182 001 0000 9016
prijs €126



chrom
art. nr. 1182 001 0000 0099
prijs €145

AANBEVOLEN VOOR BADKAMER EN KEUKEN IN OPTIE



handdoekbeugel (chrom)
art. nr. zie p. 316
prijs €137



wit
art. nr. 11911630102
prijs €44



chrom
art. nr. 11911631102
prijs €60



HOE RITMO VERTICAAL BESTELLEN

Leveringstermijn 15 - 30 werkdagen
(zonder transportduur)

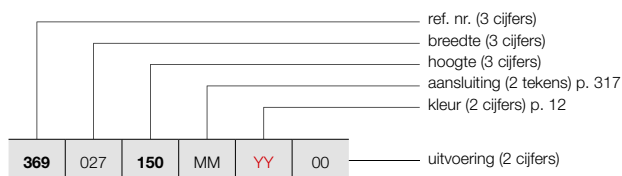

RITMO VERTICAAL (2-KOLOM)



RITMO VB-2K/65
(2-KOLOM)

PRIJSGROEP: VPG5 - KOLOMRADIATOREN

BESTELCODE MAATWERK RITMO VERTICAAL	TECHNISCHE GEGEVENS								STANDAARDKLEUR		ANDERE KLEUREN					
	buizen	breedte (L mm)	hoogte (H mm)	75/65/20 (Watt) (φ50K)	55/45/20 (Watt) (φ30K)	n-exp.	gewicht (kg)	inhoud (l)	el. weerst. (Watt)	prijs RAL 9016 (€)	prijs kleur (€)					
REF. NR. RITMO VERTICAAL VB-2K/65 : 369																
369	027	150	MM	YY	00	6	270	1500	654	333	1,32	11,58	7,92	-	390	449
		180				6	270	1800	780	397	1,32	13,74	9,36	-	439	505
		200				6	270	2000	864	440	1,32	15,18	10,32	-	493	567
		220				6	270	2200	948	483	1,32	16,68	11,28	-	655	753
369	036	150	MM	YY	00	8	360	1500	872	444	1,32	15,44	10,56	-	460	529
		180				8	360	1800	1040	530	1,32	18,32	12,48	-	520	598
		200				8	360	2000	1152	587	1,32	20,24	13,76	-	580	667
		220				8	360	2200	1264	644	1,32	22,24	15,04	-	735	845
369	045	150	MM	YY	00	10	450	1500	1090	555	1,32	19,30	13,20	-	530	610
		180				10	450	1800	1300	662	1,32	22,90	15,60	-	605	696
		200				10	450	2000	1440	734	1,32	25,30	17,20	-	650	748
		220				10	450	2200	1580	805	1,32	27,80	18,80	-	817	940
369	054	150	MM	YY	00	12	540	1500	1308	666	1,32	23,16	15,84	-	620	713
		180				12	540	1800	1560	795	1,32	27,48	18,72	-	700	805
		200				12	540	2000	1728	880	1,32	30,36	20,64	-	770	886
		220				12	540	2200	1896	966	1,32	33,36	22,56	-	895	1029
369	063	150	MM	YY	00	14	630	1500	1526	778	1,32	27,02	18,48	-	710	817
		180				14	630	1800	1820	927	1,32	32,06	21,84	-	795	914
		200				14	630	2000	2016	1027	1,32	35,42	24,08	-	890	1024
		220				14	630	2200	2212	1127	1,32	38,92	26,32	-	976	1122
369	072	150	MM	YY	00	16	720	1500	1744	889	1,32	30,88	21,12	-	800	920
		180				16	720	1800	2080	1060	1,32	36,64	24,96	-	895	1029
		200				16	720	2000	2304	1174	1,32	40,48	27,52	-	990	1139
		220				16	720	2200	2528	1288	1,32	44,48	30,08	-	1054	1212

Conform EN442-1: 2014: radiatoren en convectoren

Voor meer details over onze artikel-data, zie artikel-database: <https://www.installdata.be>

Voor de warmteafgiftes van andere regimes, kijkt u op p. 346 (correctiefactoren)

BELGIË. Prijzen in euro (excl. BTW)

RITMO VERTICAAL (3-KOLOM)



RITMO VB-3K/105
(3-KOLOM)

HOE RITMO VERTICAAL BESTELLEN
Leveringstermijn 15 - 30 werkdagen
(zonder transportduur)

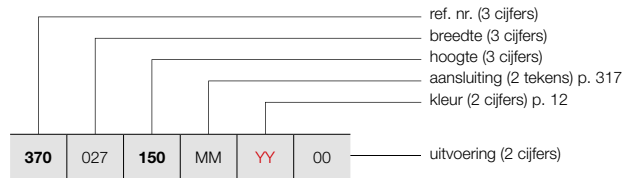

PRIJSGROEP: VPG5 - KOLOMRADIATOREN

BESTELCODE MAATWERK RITMO VERTICAAL	TECHNISCHE GEGEVENS									STANDAARDKLEUR	ANDERE KLEUREN
	buizen	breedte (L mm)	hoogte (H mm)	75/65/20 (Watt) (Φ50K)	55/45/20 (Watt) (Φ30K)	n-exp.	gewicht (kg)	inhoud (l)	el. weerst. (Watt)	prijs RAL 9016 (€)	prijs kleur (€)
REF. NR. RITMO VERTICAAL VB-3K/105 : 370											
370	027	150	MM	YY	00						
		180								510	587
		200								589	677
		220								602	692
										717	825
370	036	150	MM	YY	00						
		180								600	690
		200								699	804
		220								732	842
										846	973
370	045	150	MM	YY	00						
		180								685	788
		200								800	920
		220								845	972
										983	1130
370	054	150	MM	YY	00						
		180								800	920
		200								950	1093
		220								994	1143
										1150	1323
370	063	150	MM	YY	00						
		180								920	1058
		200								1068	1228
		220								1127	1296
										1286	1479
370	072	150	MM	YY	00						
		180								1025	1179
		200								1212	1394
		220								1242	1428
										1436	1651

Conform EN442-1: 2014: radiatoren en convectoren

Voor meer details over onze artikel-data, zie artikel-database: <https://www.installdata.be>
Voor de warmteafgiftes van andere regimes, kijkt u op p. 346 (correctiefactoren)
BELGIË. Prijzen in euro (excl. BTW)

HOE RITMO VERTICAAL BESTELLEN

Leveringstermijn 15 - 30 werkdagen
(zonder transportduur)

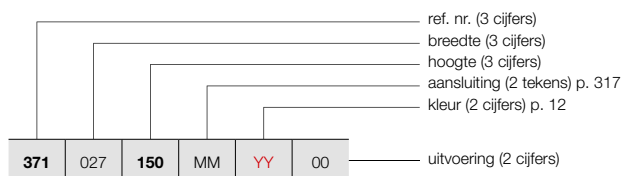

RITMO VERTICAAL (4-KOLOM)



RITMO VB-4K/145
(4-KOLOM)

PRIJSGROEP: VPG5 - KOLOMRADIATOREN

BESTELCODE MAATWERK RITMO VERTICAAL	TECHNISCHE GEGEVENS								STANDAARDKLEUR	ANDERE KLEUREN						
	buizen	breedte (L mm)	hoogte (H mm)	75/65/20 (Watt) (Φ50K)	55/45/20 (Watt) (Φ30K)	n-exp.	gewicht (kg)	inhoud (l)			el. weerst. (Watt)	prijs RAL 9016 (€)	prijs kleur (€)			
REF. NR. RITMO VERTICAAL VB-4K/145 : 371																
371	027	150	MM	YY	00	6	270	1500	1116	560	1,35	23,10	15,60	-	622	715
		180				6	270	1800	1314	663	1,34	27,48	18,48	-	746	858
		200				6	270	2000	1446	729	1,34	30,36	20,40	-	792	911
		220				6	270	2200	1572	793	1,34	33,30	22,32	-	958	1102
371	036	150	MM	YY	00	8	360	1500	1488	747	1,35	30,80	20,80	-	733	843
		180				8	360	1800	1752	884	1,34	36,64	24,64	-	888	1021
		200				8	360	2000	1928	972	1,34	40,48	27,20	-	952	1095
		220				8	360	2200	2096	1057	1,34	44,40	29,76	-	1106	1272
371	045	150	MM	YY	00	10	450	1500	1860	933	1,35	38,50	26,00	-	850	978
		180				10	450	1800	2190	1105	1,34	45,80	30,80	-	997	1147
		200				10	450	2000	2410	1215	1,34	50,60	34,00	-	1110	1277
		220				10	450	2200	2620	1321	1,34	55,50	37,20	-	1250	1438
371	054	150	MM	YY	00	12	540	1500	2232	1120	1,35	46,20	31,20	-	989	1137
		180				12	540	1800	2628	1325	1,34	54,96	36,96	-	1133	1303
		200				12	540	2000	2892	1459	1,34	60,72	40,80	-	1365	1570
		220				12	540	2200	3144	1586	1,34	66,60	44,64	-	1450	1668
371	063	150	MM	YY	00	14	630	1500	2604	1307	1,35	53,90	36,40	-	1138	1309
		180				14	630	1800	3066	1546	1,34	64,12	43,12	-	1336	1536
		200				14	630	2000	3374	1702	1,34	70,84	47,60	-	1540	1771
		220				14	630	2200	3668	1850	1,34	77,70	52,08	-	1700	1955
371	072	150	MM	YY	00	16	720	1500	2976	1493	1,35	61,60	41,60	-	1262	1451
		180				16	720	1800	3504	1767	1,34	73,28	49,28	-	1572	1808
		200				16	720	2000	3856	1945	1,34	80,96	54,40	-	1756	2019
		220				16	720	2200	4192	2114	1,34	88,80	59,52	-	1911	2198

Conform EN442-1: 2014: radiatoren en convectoren

Voor meer details over onze artikel-data, zie artikel-database: <https://www.installdata.be>

Voor de warmteafgiftes van andere regimes, kijkt u op p. 346 (correctiefactoren)

BELGIË. Prijzen in euro (excl. BTW)

RITMO HORIZONTAAL (HB-2K/65, HB-3K/105, HB-4K/145)

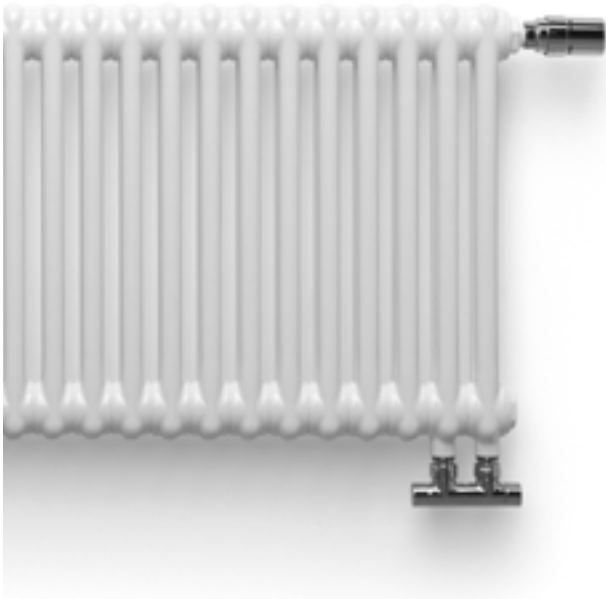

TYPES

- 2 / 3 / 4 kolommen
- Bouwdiepte: 65 / 105 / 145 mm
- Bouwhoogte: 300, 400, 500, 600, 900 mm
- Bouwlengte: 450, 540, 630, 720, 810, 900, 990, 1080, 1170, 1260, 1350, 1440, 1530, 1620, 1710, 1800 mm

BUIZEN

- Verticaal, 25 mm

KLEUREN

- Standaardkleur wit RAL 9016
- Uitgebreide kleurenkaart zie p. 12

BEVESTIGINGEN

- Vloer- of wandmontage
- Muurbevestigingen standaard
- Bij witte radiatoren wordt standaard een witte klemconsole 30 mm en een witte afstandshouder geleverd
- Bij gekleurde radiatoren wordt standaard een klemconsole 30 mm in de kleur van de radiator en een afstandshouder in RAL 7024 geleverd

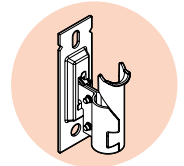

TECHNISCH

- Bestaande uit kopstukken (bandstaal persdelen) en ronde buizen.
- ATL-grondlaag, poedercoating
- Standaardwerkdruk: 10 bar
- Maximale bedrijfstemperatuur: 110°C

TECHNISCHE TEKENINGEN

- Zie p. 318

AANSLUITING

- ✗ Eénpuntsaansluiting voor éénpijpssysteem
- ✗ Eénpuntsaansluiting voor tweepijpssysteem
- ✓ Tweepuntsaansluiting voor éénpijpssysteem (aansluiting via het geïntegreerd ventiel) (zie p. 341)
- ✓ Tweepuntsaansluiting voor tweepijpssysteem (standaard) (zie p. 340)
- ✓ Geïntegreerd ventiel (aansluiting VR) (**meerprijs: €77**) (thermostaatkop apart te bestellen, zie p. 316)
- Aansluitingen: 1/2" (binnendraad)

RITMO HORIZONTAAL

Van klassiek tot modern

Het authentieke karakter van de Ritmo-kolomradiator is voor heel wat design-liefhebbers een schot in de roos. Omdat ze in hoge hoogtematen beschikbaar zijn, komen deze designradiatoren optimaal tot hun recht in grote, hoge en open interieurs, van klassieke herenhuisen tot moderne industriële lofts. Deze radiatoren worden ook vaak toegepast in openbare ruimtes, aangezien ze met hun relatief brede openingen makkelijk te reinigen en dus erg onderhoudsvriendelijk zijn. Met hun karakteristieke retro-uitstraling zijn deze kolomradiatoren in vele uitvoeringen beschikbaar: in horizontale of verticale variant en in 2, 3 of 4 kolommen.

AANBEVOLEN AANSLUITING GEÏNTEGREERD VENTIEL

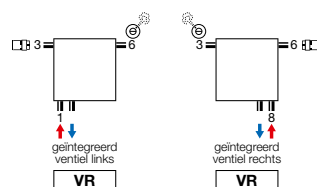

Andere aansluitmogelijkheden, zie p. 317

AANBEVOLEN VOOR BADKAMER EN KEUKEN IN OPTIE



handdoekbeugel (chrom) art. nr. zie p. 316
prijs €137



art. nr. 118230100000099
prijs €145



wit art. nr. 11911630102
prijs €44



chrom art. nr. 11911631102
prijs €60



HOE RITMO HORIZONTAAL BESTELLEN

Leveringstermijn 15 - 30 werkdagen
(zonder transportduur)

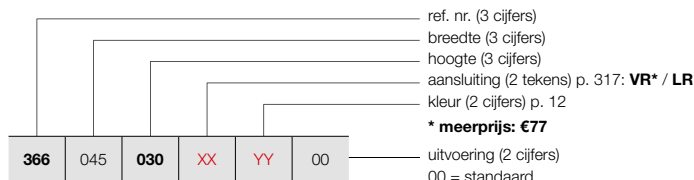

RITMO HORIZONTAAL (2-KOLOM)



RITMO HB-2K/65
(2-KOLOM) 4-AANSLUITINGEN



RITMO HB-2K/65
(2-KOLOM) GEÏNTEGREERD VENTIEL
(thermostaatkop apart te bestellen)

PRIJSGROEP: VPG5 - KOLOMRADIATOREN

BESTELCODE MAATWERK RITMO HORIZONTAAL	TECHNISCHE GEGEVENS							STANDAARDKLEUR		ANDERE KLEUREN	
	buizen	breedte (L mm)	hoogte (H mm)	75/65/20 (Watt) (Φ50K)	55/45/20 (Watt) (Φ30K)	n-exp.	gewicht (kg)	inhoud (l)	el. weerst. (Watt)	prijs RAL 9016 (€)	prijs kleur (€)
REF. NR. RITMO HORIZONTAAL HB-2K/65 : 366											
366 045 030 XX YY 00	10	450	300	240	123	1,26	4,70	3,70	-	270	311
	10	450	400	310	158	1,31	5,90	4,50	-	280	322
	10	450	500	390	200	1,31	7,10	5,30	-	290	334
	10	450	600	460	235	1,31	8,30	6,10	-	300	345
	10	450	900	670	343	1,31	12,00	8,40	-	333	383
	10	450	900	670	343	1,31	12,00	8,40	-	333	383
366 054 030 XX YY 00	12	540	300	288	147	1,26	5,64	4,44	-	320	368
	12	540	400	372	190	1,31	7,08	5,40	-	330	380
	12	540	500	468	240	1,31	8,52	6,36	-	340	391
	12	540	600	552	283	1,31	9,96	7,32	-	350	403
	12	540	900	804	412	1,31	14,40	10,08	-	383	440
	12	540	900	804	412	1,31	14,40	10,08	-	383	440
366 063 030 XX YY 00	14	630	300	336	172	1,26	6,58	5,18	-	380	437
	14	630	400	434	222	1,31	8,26	6,30	-	390	449
	14	630	500	546	280	1,31	9,94	7,42	-	400	460
	14	630	600	644	330	1,31	11,62	8,54	-	410	472
	14	630	900	938	481	1,31	16,80	11,76	-	443	509
	14	630	900	938	481	1,31	16,80	11,76	-	443	509
366 072 030 XX YY 00	16	720	300	384	196	1,26	7,52	5,92	-	440	506
	16	720	400	496	254	1,31	9,44	7,20	-	450	518
	16	720	500	624	320	1,31	11,36	8,48	-	460	529
	16	720	600	736	377	1,31	13,28	9,76	-	470	541
	16	720	900	1072	549	1,31	19,20	13,44	-	503	578
	16	720	900	1072	549	1,31	19,20	13,44	-	503	578
366 081 030 XX YY 00	18	810	300	432	221	1,26	8,46	6,66	-	500	575
	18	810	400	558	286	1,31	10,62	8,10	-	510	587
	18	810	500	702	360	1,31	12,78	9,54	-	520	598
	18	810	600	828	424	1,31	14,94	10,98	-	530	610
	18	810	900	1206	618	1,31	21,60	15,12	-	563	647
	18	810	900	1206	618	1,31	21,60	15,12	-	563	647
366 090 030 XX YY 00	20	900	300	480	246	1,26	9,40	7,40	-	540	621
	20	900	400	620	317	1,31	11,80	9,00	-	550	633
	20	900	500	780	400	1,31	14,20	10,60	-	560	644
	20	900	600	920	471	1,31	16,60	12,20	-	570	656
	20	900	900	1340	687	1,31	24,00	16,80	-	603	693
	20	900	900	1340	687	1,31	24,00	16,80	-	603	693
366 099 030 XX YY 00	22	990	300	528	270	1,26	10,34	8,14	-	570	656
	22	990	400	682	349	1,31	12,98	9,90	-	580	667
	22	990	500	858	440	1,31	15,62	11,66	-	590	679
	22	990	600	1012	518	1,31	18,26	13,42	-	600	690
	22	990	900	1474	755	1,31	26,40	18,48	-	633	728
	22	990	900	1474	755	1,31	26,40	18,48	-	633	728
366 108 030 XX YY 00	24	1080	300	576	295	1,26	11,28	8,88	-	600	690
	24	1080	400	744	381	1,31	14,16	10,80	-	610	702
	24	1080	500	936	480	1,31	17,04	12,72	-	620	713
	24	1080	600	1104	566	1,31	19,92	14,64	-	630	725
	24	1080	900	1608	824	1,31	28,80	20,16	-	663	762
	24	1080	900	1608	824	1,31	28,80	20,16	-	663	762

Conform EN442-1: 2014: radiatoren en convectoren

Voor meer details over onze artikel-data, zie artikel-database: <https://www.installdata.be>

Voor de warmteafgiftes van andere regimes, kijkt u op p. 346 (correctiefactoren)
BELGIË. Prijzen in euro (excl. BTW)

RITMO HORIZONTAAL (2-KOLOM)

HOE RITMO HORIZONTAAL BESTELLEN

Leveringstermijn 15 - 30 werkdagen
(zonder transportduur)

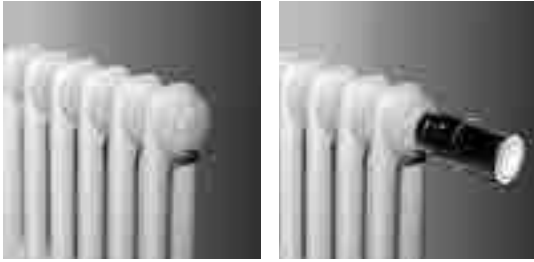

RITMO HB-2K/65
(2-KOLOM) 4-AANSLUITINGEN

RITMO HB-2K/65
(2-KOLOM) GEÏNTEGREERD VENTIEL
(thermostaatkop apart te bestellen)

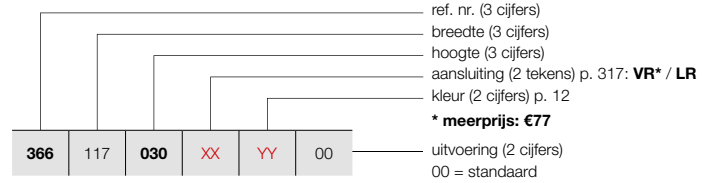

PRIJSGROEP: VPG5 - KOLOMRADIATOREN

BESTELCODE MAATWERK RITMO HORIZONTAAL	TECHNISCHE GEGEVENS									STANDAARDKLEUR	ANDERE KLEUREN
	buizen	breedte (L mm)	hoogte (H mm)	75/65/20 (Watt) (Ø50K)	55/45/20 (Watt) (Ø30K)	n-exp.	gewicht (kg)	inhoud (l)	el. weerst. (Watt)	prijs RAL 9016 (€)	prijs kleur (€)
REF. NR. RITMO HORIZONTAAL HB-2K/65 : 366											
366	117	030	XX	YY	00						
		040								655	753
		050								665	765
		060								675	776
		090								685	788
										718	826
366	126	030	XX	YY	00						
		040								710	817
		050								720	828
		060								730	840
		090								740	851
										773	889
366	135	030	XX	YY	00						
		040								770	886
		050								780	897
		060								790	909
		090								800	920
										833	958
366	144	030	XX	YY	00						
		040								830	955
		050								840	966
		060								850	978
		090								860	989
										893	1027
366	153	030	XX	YY	00						
		040								890	1024
		050								900	1035
		060								910	1047
		090								920	1058
										953	1096
366	162	030	XX	YY	00						
		040								950	1093
		050								960	1104
		060								970	1116
		090								980	1127
										1013	1165
366	171	030	XX	YY	00						
		040								1010	1162
		050								1020	1173
		060								1030	1185
		090								1040	1196
										1073	1234
366	180	030	XX	YY	00						
		040								1070	1231
		050								1080	1242
		060								1090	1254
		090								1100	1265
										1133	1303

Conform EN442-1: 2014: radiatoren en convectoren

Voor meer details over onze artikel-data, zie artikel-database: <https://www.installdata.be>

Voor de warmteafgiftes van andere regimes, kijkt u op p. 346 (correctiefactoren)
BELGIË. Prijzen in euro (excl. BTW)

HOE RITMO HORIZONTAAL BESTELLEN

Leveringstermijn 15 - 30 werkdagen
(zonder transportduur)

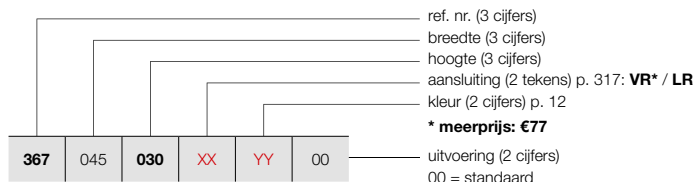

RITMO HORIZONTAAL (3-KOLOM)



RITMO HB-3K/105
(3-KOLOM) 4-AANSLUITINGEN



RITMO HB-3K/105
(3-KOLOM) GEÏNTEGREERD VENTIEL
(thermostaatkop apart te bestellen)

PRIJSGROEP: VPG5 - KOLOMRADIATOREN

BESTELCODE MAATWERK RITMO HORIZONTAAL	TECHNISCHE GEGEVENS							STANDAARDKLEUR		ANDERE KLEUREN	
	buizen	breedte (L mm)	hoogte (H mm)	75/65/20 (Watt) (φ50K)	55/45/20 (Watt) (φ30K)	n-exp.	gewicht (kg)	inhoud (l)	el. weerst. (Watt)	prijs RAL 9016 (€)	prijs kleur (€)
REF. NR. RITMO HORIZONTAAL HB-3K/105 : 367											
367 045 030 XX YY 00	10	450	300	330	167	1,33	7,00	5,30	-	316	363
	10	450	400	430	215	1,36	8,80	6,50	-	326	375
	10	450	500	530	265	1,36	10,60	7,70	-	336	386
	10	450	600	630	315	1,36	12,50	8,90	-	346	398
	10	450	900	920	459	1,36	17,90	12,50	-	395	454
367 054 030 XX YY 00	12	540	300	396	201	1,33	8,40	6,36	-	368	423
	12	540	400	516	258	1,36	10,56	7,80	-	378	435
	12	540	500	636	258	1,36	12,72	9,24	-	388	446
	12	540	600	756	377	1,36	15,00	10,68	-	398	458
	12	540	900	1104	551	1,36	21,48	15,00	-	445	512
367 063 030 XX YY 00	14	630	300	462	234	1,33	9,80	7,42	-	420	483
	14	630	400	602	301	1,36	12,32	9,10	-	430	495
	14	630	500	742	301	1,36	14,84	10,78	-	440	506
	14	630	600	882	440	1,36	17,50	12,46	-	450	518
	14	630	900	1288	643	1,36	25,06	17,50	-	500	575
367 072 030 XX YY 00	16	720	300	528	268	1,33	11,20	8,48	-	478	550
	16	720	400	688	343	1,36	14,08	10,40	-	488	561
	16	720	500	848	343	1,36	16,96	12,32	-	498	573
	16	720	600	1008	503	1,36	20,00	14,24	-	508	584
	16	720	900	1472	735	1,36	28,64	20,00	-	568	653
367 081 030 XX YY 00	18	810	300	594	301	1,33	12,60	9,54	-	535	615
	18	810	400	774	386	1,36	15,84	11,70	-	545	627
	18	810	500	954	386	1,36	19,08	13,86	-	555	638
	18	810	600	1134	566	1,36	22,50	16,02	-	565	650
	18	810	900	1656	827	1,36	32,22	22,50	-	628	722
367 090 030 XX YY 00	20	900	300	660	335	1,33	14,00	10,60	-	590	679
	20	900	400	860	429	1,36	17,60	13,00	-	600	690
	20	900	500	1060	429	1,36	21,20	15,40	-	610	702
	20	900	600	1260	629	1,36	25,00	17,80	-	620	713
	20	900	900	1840	919	1,36	35,80	25,00	-	690	794
367 099 030 XX YY 00	22	990	300	726	368	1,33	15,40	11,66	-	625	719
	22	990	400	946	472	1,36	19,36	14,30	-	635	730
	22	990	500	1166	472	1,36	23,32	16,94	-	645	742
	22	990	600	1386	692	1,36	27,50	19,58	-	655	753
	22	990	900	2024	1010	1,36	39,38	27,50	-	720	828
367 108 030 XX YY 00	24	1080	300	792	401	1,33	16,80	12,72	-	660	759
	24	1080	400	1032	515	1,36	21,12	15,60	-	670	771
	24	1080	500	1272	515	1,36	25,44	18,48	-	680	782
	24	1080	600	1512	755	1,36	30,00	21,36	-	690	794
	24	1080	900	2208	1102	1,36	42,96	30,00	-	773	889

Conform EN442-1: 2014: radiatoren en convectoren

Voor meer details over onze artikel-data, zie artikel-database: <https://www.installdata.be>
Voor de warmteafgiftes van andere regimes, kijkt u op p. 346 (correctiefactoren)
BELGIË. Prijzen in euro (excl. BTW)

RITMO HORIZONTAAL (3-KOLOM)

HOE RITMO HORIZONTAAL BESTELLEN

Leveringstermijn 15 - 30 werkdagen
(zonder transportduur)

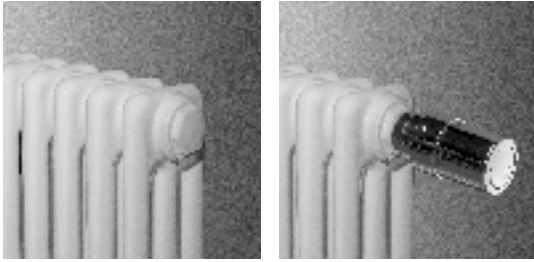

RITMO HB-3K/105
(3-KOLOM) 4-AANSLUITINGEN

RITMO HB-3K/105
(3-KOLOM) GEÏNTEGREERD VENTIEL
(thermostaatkop apart te bestellen)

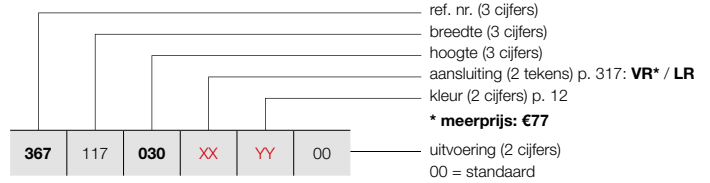

PRIJSGROEP: VPG5 - KOLOMRADIATOREN

BESTELCODE MAATWERK RITMO HORIZONTAAL	TECHNISCHE GEGEVENS									STANDAARDKLEUR	ANDERE KLEUREN
	buizen	breedte (L mm)	hoogte (H mm)	75/65/20 (Watt) (Φ50K)	55/45/20 (Watt) (Φ30K)	n-exp.	gewicht (kg)	inhoud (l)	el. weerst. (Watt)	prijs RAL 9016 (€)	prijs kleur (€)
REF. NR. RITMO HORIZONTAAL HB-3K/105 : 367											
367	117	030	XX	YY	00						
		040								718	826
		050								728	837
		060								738	849
		090								748	860
										875	1006
367	126	030	XX	YY	00						
		040								770	886
		050								780	897
		060								790	909
		090								800	920
										940	1081
367	135	030	XX	YY	00						
		040								824	948
		050								834	959
		060								844	971
		090								854	982
										1000	1150
367	144	030	XX	YY	00						
		040								877	1009
		050								887	1020
		060								897	1032
		090								907	1043
										1060	1219
367	153	030	XX	YY	00						
		040								930	1070
		050								940	1081
		060								950	1093
		090								960	1104
										1130	1300
367	162	030	XX	YY	00						
		040								981	1128
		050								991	1140
		060								1001	1151
		090								1011	1163
										1200	1380
367	171	030	XX	YY	00						
		040								1040	1196
		050								1050	1208
		060								1060	1219
		090								1070	1231
										1260	1449
367	180	030	XX	YY	00						
		040								1105	1271
		050								1115	1282
		060								1125	1294
		090								1135	1305
										1335	1535

Conform EN442-1: 2014: radiatoren en convectoren

Voor meer details over onze artikel-data, zie artikel-database: <https://www.installdata.be>
Voor de warmteafgiftes van andere regimes, kijkt u op p. 346 (correctiefactoren)
BELGIË. Prijzen in euro (excl. BTW)

HOE RITMO HORIZONTAAL BESTELLEN

Leveringstermijn 15 - 30 werkdagen
(zonder transportduur)

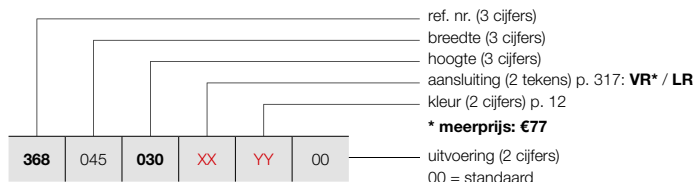

RITMO HORIZONTAAL (4-KOLOM)



RITMO HB-4K/145
(4-KOLOM) 4-AANSLUITINGEN



RITMO HB-4K/145
(4-KOLOM) GEÏNTEGREERD VENTIEL
(thermostaatkop apart te bestellen)

PRIJSGROEP: VPG5 - KOLOMRADIATOREN

BESTELCODE MAATWERK RITMO HORIZONTAAL	TECHNISCHE GEGEVENS							STANDAARDKLEUR		ANDERE KLEUREN						
	buizen	breedte (L mm)	hoogte (H mm)	75/65/20 (Watt) (Φ50K)	55/45/20 (Watt) (Φ30K)	n-exp.	gewicht (kg)	inhoud (l)	el. weerst. (Watt)	prijs RAL 9016 (€)	prijs kleur (€)					
REF. NR. RITMO HORIZONTAAL HB-4K/145 : 368																
368	045	030	XX	YY	00	10	450	300	430	218	1,33	9,30	6,90	-	373	429
						10	450	400	560	281	1,35	11,80	8,50	-	383	440
						10	450	500	690	346	1,35	14,20	10,10	-	393	452
						10	450	600	810	406	1,35	16,60	11,70	-	403	463
						10	450	900	1170	587	1,35	23,90	16,50	-	465	535
368	054	030	XX	YY	00	12	540	300	516	262	1,33	11,16	8,28	-	425	489
						12	540	400	672	337	1,35	14,16	10,20	-	435	500
						12	540	500	828	415	1,35	17,04	12,12	-	445	512
						12	540	600	972	488	1,35	19,92	14,04	-	455	523
						12	540	900	1404	704	1,35	28,68	19,80	-	540	621
368	063	030	XX	YY	00	14	630	300	602	305	1,33	13,02	9,66	-	480	552
						14	630	400	784	393	1,35	16,52	11,90	-	490	564
						14	630	500	966	485	1,35	19,88	14,14	-	500	575
						14	630	600	1134	569	1,35	23,24	16,38	-	510	587
						14	630	900	1638	822	1,35	33,46	23,10	-	645	742
368	072	030	XX	YY	00	16	720	300	688	349	1,33	14,88	11,04	-	530	610
						16	720	400	896	450	1,35	18,88	13,60	-	540	621
						16	720	500	1104	554	1,35	22,72	16,16	-	550	633
						16	720	600	1296	650	1,35	26,56	18,72	-	560	644
						16	720	900	1872	939	1,35	38,24	26,40	-	735	845
368	081	030	XX	YY	00	18	810	300	774	392	1,33	16,74	12,42	-	600	690
						18	810	400	1008	506	1,35	21,24	15,30	-	610	702
						18	810	500	1242	623	1,35	25,56	18,18	-	620	713
						18	810	600	1458	732	1,35	29,88	21,06	-	630	725
						18	810	900	2106	1057	1,35	43,02	29,70	-	825	949
368	090	030	XX	YY	00	20	900	300	860	436	1,33	18,60	13,80	-	690	794
						20	900	400	1120	562	1,35	23,60	17,00	-	700	805
						20	900	500	1380	692	1,35	28,40	20,20	-	710	817
						20	900	600	1620	813	1,35	33,20	23,40	-	720	828
						20	900	900	2340	1174	1,35	47,80	33,00	-	915	1052
368	099	030	XX	YY	00	22	990	300	946	480	1,33	20,46	15,18	-	720	828
						22	990	400	1232	618	1,35	25,96	18,70	-	730	840
						22	990	500	1518	762	1,35	31,24	22,22	-	740	851
						22	990	600	1782	894	1,35	36,52	25,74	-	750	863
						22	990	900	2574	1292	1,35	52,58	36,30	-	965	1110
368	108	030	XX	YY	00	24	1080	300	1032	523	1,33	22,32	16,56	-	750	863
						24	1080	400	1344	674	1,35	28,32	20,40	-	760	874
						24	1080	500	1656	831	1,35	34,08	24,24	-	770	886
						24	1080	600	1944	975	1,35	39,84	28,08	-	780	897
						24	1080	900	2808	1409	1,35	57,36	39,60	-	1010	1162

Conform EN442-1: 2014: radiatoren en convectoren

Voor meer details over onze artikel-data, zie artikel-database: <https://www.installdata.be>
Voor de warmteafgiftes van andere regimes, kijkt u op p. 346 (correctiefactoren)
BELGIË. Prijzen in euro (excl. BTW)

RITMO HORIZONTAAL (4-KOLOM)

HOE RITMO HORIZONTAAL BESTELLEN

Leveringstermijn 15 - 30 werkdagen
(zonder transportduur)

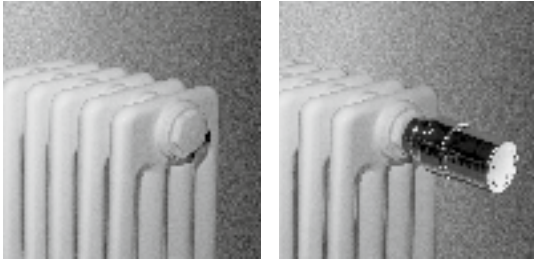

RITMO HB-4K/145
(4-KOLOM) 4-AANSLUITINGEN

RITMO HB-4K/145
(4-KOLOM) GEÏNTEGREERD VENTIEL
(thermostaatkop apart te bestellen)

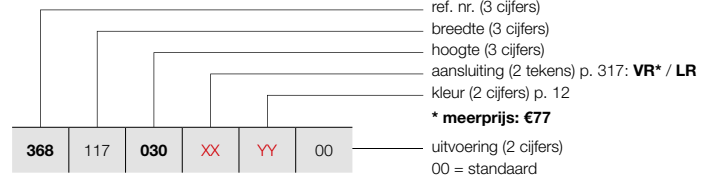

PRIJSGROEP: VPG5 - KOLOMRADIATOREN

BESTELCODE MAATWERK RITMO HORIZONTAAL	TECHNISCHE GEGEVENS									STANDAARDKLEUR	ANDERE KLEUREN					
	buizen	breedte (L mm)	hoogte (H mm)	75/65/20 (Watt) (Φ50K)	55/45/20 (Watt) (Φ30K)	n-exp.	gewicht (kg)	inhoud (l)	el. weerst. (Watt)	prijs RAL 9016 (€)	prijs kleur (€)					
REF. NR. RITMO HORIZONTAAL HB-4K/145 : 368																
368	117	030	XX	YY	00	26	1170	300	1118	567	1,33	24,18	17,94	-	880	1012
		040				26	1170	400	1456	731	1,35	30,68	22,10	-	890	1024
		050				26	1170	500	1794	900	1,35	36,92	26,26	-	900	1035
		060				26	1170	600	2106	1057	1,35	43,16	30,42	-	910	1047
		090				26	1170	900	3042	1526	1,35	62,14	42,90	-	1170	1346
368	126	030	XX	YY	00	28	1260	300	1204	610	1,33	26,04	19,32	-	945	1087
		040				28	1260	400	1568	787	1,35	33,04	23,80	-	955	1098
		050				28	1260	500	1932	969	1,35	39,76	28,28	-	965	1110
		060				28	1260	600	2268	1138	1,35	46,48	32,76	-	975	1121
		090				28	1260	900	3276	1644	1,35	66,92	46,20	-	1235	1420
368	135	030	XX	YY	00	30	1350	300	1290	654	1,33	27,90	20,70	-	1000	1150
		040				30	1350	400	1680	843	1,35	35,40	25,50	-	1010	1162
		050				30	1350	500	2070	1039	1,35	42,60	30,30	-	1020	1173
		060				30	1350	600	2430	1219	1,35	49,80	35,10	-	1030	1185
		090				30	1350	900	3510	1761	1,35	71,70	49,50	-	1290	1484
368	144	030	XX	YY	00	32	1440	300	1376	698	1,33	29,76	22,08	-	1070	1231
		040				32	1440	400	1792	899	1,35	37,76	27,20	-	1080	1242
		050				32	1440	500	2208	1108	1,35	45,44	32,32	-	1090	1254
		060				32	1440	600	2592	1301	1,35	53,12	37,44	-	1100	1265
		090				32	1440	900	3744	1879	1,35	76,48	52,80	-	1360	1564
368	153	030	XX	YY	00	34	1530	300	1462	741	1,33	31,62	23,46	-	1135	1305
		040				34	1530	400	1904	955	1,35	40,12	28,90	-	1145	1317
		050				34	1530	500	2346	1177	1,35	48,28	34,34	-	1155	1328
		060				34	1530	600	2754	1382	1,35	56,44	39,78	-	1165	1340
		090				34	1530	900	3978	1996	1,35	81,26	56,10	-	1430	1645
368	162	030	XX	YY	00	36	1620	300	1548	785	1,33	33,48	24,84	-	1208	1389
		040				36	1620	400	2016	1012	1,35	42,48	30,60	-	1218	1401
		050				36	1620	500	2484	1246	1,35	51,12	36,36	-	1228	1412
		060				36	1620	600	2916	1463	1,35	59,76	42,12	-	1238	1424
		090				36	1620	900	4212	2113	1,35	86,04	59,40	-	1505	1731
368	171	030	XX	YY	00	38	1710	300	1634	828	1,33	35,34	26,22	-	1265	1455
		040				38	1710	400	2128	1068	1,35	44,84	32,30	-	1275	1466
		050				38	1710	500	2622	1316	1,35	53,96	38,38	-	1285	1478
		060				38	1710	600	3078	1544	1,35	63,08	44,46	-	1295	1489
		090				38	1710	900	4446	2231	1,35	90,82	62,70	-	1555	1788
368	180	030	XX	YY	00	40	1800	300	1720	872	1,33	37,20	27,60	-	1309	1505
		040				40	1800	400	2240	1124	1,35	47,20	34,00	-	1319	1517
		050				40	1800	500	2760	1385	1,35	56,80	40,40	-	1329	1528
		060				40	1800	600	3240	1626	1,35	66,40	46,80	-	1339	1540
		090				40	1800	900	4680	2348	1,35	95,60	66,00	-	1609	1850

Conform EN442-1: 2014: radiatoren en convectoren

Voor meer details over onze artikel-data, zie artikel-database: <https://www.installdata.be>
Voor de warmteafgiftes van andere regimes, kijkt u op p. 346 (correctiefactoren)
BELGIË. Prijzen in euro (excl. BTW)

PRIJSGROEP: VPG10 - ACC.

BEVESTIGINGEN		KLEUR	ART. NR.	€
KLEMCONSOLE VARIABEL				
KLEMCONSOLE VARIABEL 	RITMO VERTICAAL / RITMO HORIZONTAAL			
	35 - 45 mm	RAL 9016	1187 212 0000 9016	32
		KLEUR	1187 212 0000 XXXX	42
	45 - 60 mm	RAL 9016	1187 213 0000 9016	37
		KLEUR	1187 213 0000 XXXX	49
<ul style="list-style-type: none"> • Wandafstand: 35 - 45 mm of 45 - 60 mm 				
AFSTANDHOUDER				
	RITMO VERTICAAL / RITMO HORIZONTAAL			
		RAL 9016	1187 209 0000 9016	11
		RAL 7024	1187 209 0000 7024	12

hoogte (H mm)	2-kolom / 3-kolom / 4-kolom		
	300 – 900	1500 – 2200	
aantal buizen (n)	10 – 28	30 – 40	6 – 16
klemconsole variabel 35 - 45 mm	2x	3x	2x
klemconsole variabel 45 - 60 mm	2x	3x	2x
afstandhouder	2x	3x	2x

HOE BESTELLEN

1. Kies de gewenste klemconsole in bovenstaande tabel.
2. Afstandhouders dienen apart mee besteld te worden.

BELGIË. Prijzen in euro (excl. BTW)

RITMO VRIJSTAANDE OPSTELLING

IN OPTIE

PRIJSGROEP: VPG10 - ACC.

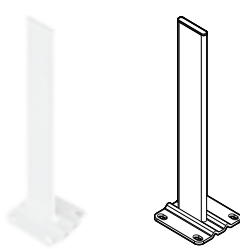
VRIJSTAANDE OPSTELLING	HOOGTE VOET	KLEUR	ART. NR.	€
STANDVOET VRIJSTAANDE OPSTELLING 	RITMO HORIZONTAAL			
	H = 450 mm	RAL 9016	11810350450	60
		KLEUR	11810350450C	69
	H = 550 mm	RAL 9016	11810350550	60
		KLEUR	11810350550C	69
	H = 600 mm	RAL 9016	11810350600	60
		KLEUR	11810350600C	69
	H = 650 mm	RAL 9016	11810350650	60
		KLEUR	11810350650C	69
	H = 750 mm	RAL 9016	11810350750	60
		KLEUR	11810350750C	69
	H = 850 mm	RAL 9016	11810350850	74
		KLEUR	11810350850C	85
	H = 900 mm	RAL 9016	11810350900	74
	KLEUR	11810350900C	85	
H = 1050 mm	RAL 9016	11810351050	74	
	KLEUR	11810351050C	85	
H = 1200 mm	RAL 9016	11810351200	74	
	KLEUR	11810351200C	85	

- Afgewerkte vloer: hoogte voet = hoogte radiator + 150 mm
- Chape: hoogte voet = hoogte radiator + 300 mm
- Zelf in te korten indien nodig

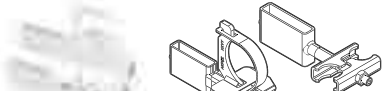
BEVESTIGING STANDVOET VRIJSTAANDE OPSTELLING 	RITMO HORIZONTAAL			
		RAL 9016	1181 029 0000 9016	78
		KLEUR	1181 029 0000 XXXX	83

AFDEKROZET STANDVOET CHAPE 	RITMO HORIZONTAAL			
		RAL 9016	11810370000	12
		KLEUR	11810370000C	14

- 100 x 40 mm. Aantal rozetten = aantal standvoeten



AFDEKROZET STANDVOET AFGEWERKTE VLOER 	RITMO HORIZONTAAL			
		RAL 9016	11810380000	15
		KLEUR	11810380000C	17

- 115 x 110 mm. Aantal rozetten = aantal standvoeten

hoogte (H mm)	2-kolom / 3-kolom / 4-kolom	
	300 – 900	
aantal buizen (n)	10 – 26	28 – 40
standvoet	2x	3x

BELGIË. Prijzen in euro (excl. BTW)

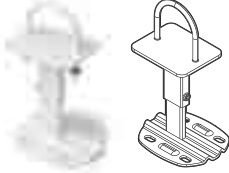

PRIJSGROEP: VPG10 - ACC.

		KLEUR	ART. NR.	€
TELESCOPISCHE ONDERSTEUNVOET  <ul style="list-style-type: none"> • Hoogte: min. 200 mm, max. 230 mm • Telescopische ondersteunvoet steeds in combinatie met de wand- en klemconsoles 	RITMO VERTICAAL / RITMO HORIZONTAAL			
		RAL 9016	1181 030 0000 9016	69
		KLEUR	1181 030 0000 XXXX	90
AFDEKROZET ONDERSTEUNVOET CHAPE  <ul style="list-style-type: none"> • 70 x 40 mm. Aantal rozetten = aantal standvoeten 	RITMO VERTICAAL / RITMO HORIZONTAAL			
		RAL 9016	1181 032 0000 9016	12
AFDEKROZET ONDERSTEUNVOET AFGEWERKTE VLOER  <ul style="list-style-type: none"> • 130 x 110 mm. Aantal rozetten = aantal standvoeten 	RITMO VERTICAAL / RITMO HORIZONTAAL			
		RAL 9016	1181 031 0000 9016	15

hoogte (H mm)	2-kolom / 3-kolom					4-kolom				
	300 – 600		900 – 2000		2200	300 – 600		900 – 2000		2200
aantal buizen (n)	10 – 24	26 – 40	6 – 24	26 – 40	6 – 16	10 – 24	26 – 40	6 – 24	26 – 40	6 – 16
telescopische ondersteunvoet	2x	3x	2x	3x	2x	2x	3x	2x	3x	3x

BELGIË. Prijzen in euro (excl. BTW)

PRIJSGROEP: VPG10 - ACC.

ACCESSOIRES		KLEUR	ART. NR.	€
		RITMO VERTICAAL / RITMO HORIZONTAAL		
THERMOSTAATKOP		WIT	11911630102	44
		RITMO VERTICAAL / RITMO HORIZONTAAL		
THERMOSTAATKOP		CHROOM	11911631102	60

PRIJSGROEP: VPG10B - HANDDOEKBEUGELS

ACCESSOIRES		KLEUR	ART. NR.	€
		RITMO VERTICAAL / RITMO HORIZONTAAL		
HANDDOEKBEUGEL		CHROOM	11832650000099	137

- b = 1000 mm (zelf in te korten)

Montagevoorschriften accessoires: zie www.vasco.eu
BELGIË. Prijzen in euro (excl. BTW)

uit voorraad leverbaar

RITMO: VERTICAAL

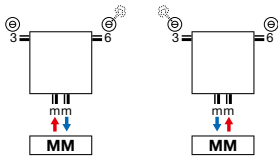

- Ontluchter in aansluiting 3 of 6.

RITMO: HORIZONTAAL

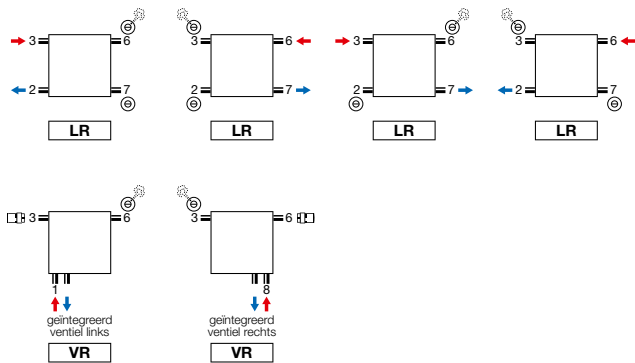

- Ontluchter in aansluiting 3 of 6.
- Geïntegreerd ventiel (aansluiting VR) (meerprijs: €77) (thermostaatkop apart te bestellen, zie p. 316). Plaatsing thermostaatkop links, door spiegelen van radiator. Opgelet: de aanvoer is aan de buitenkant van de radiator!

Opmerking: het aansluiten van de radiator kan enkel volgens de getoonde aansluiticonen. Voor elke andere aansluitwijze nemen wij geen verantwoordelijkheid.

RITMO VERTICAAL

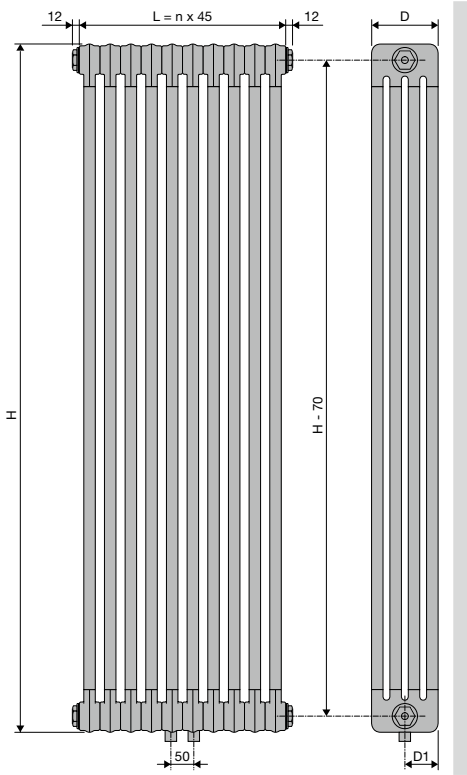

	VB-2K/65 / VB-3K/105 / VB-4K/145					
	H	1500	1800	2000	2200	
diepte (D)	65	105	145			
D1	32,5	52,5	72,5			
aantal leden (n)	6	8	10	12	14	16

RITMO HORIZONTAAL

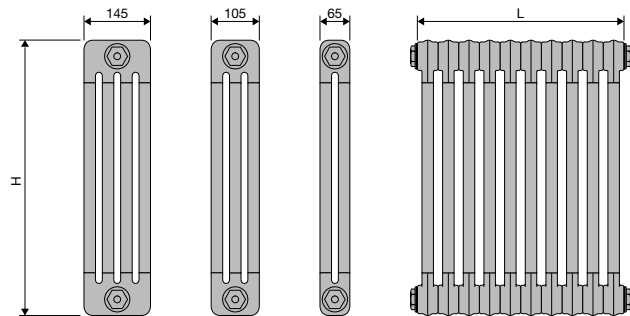
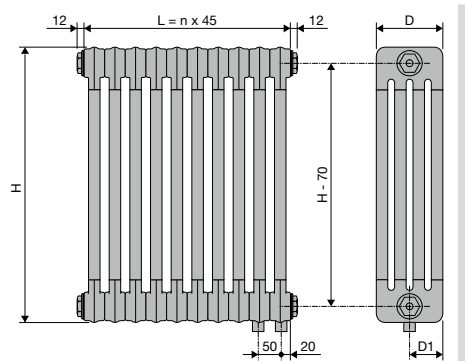
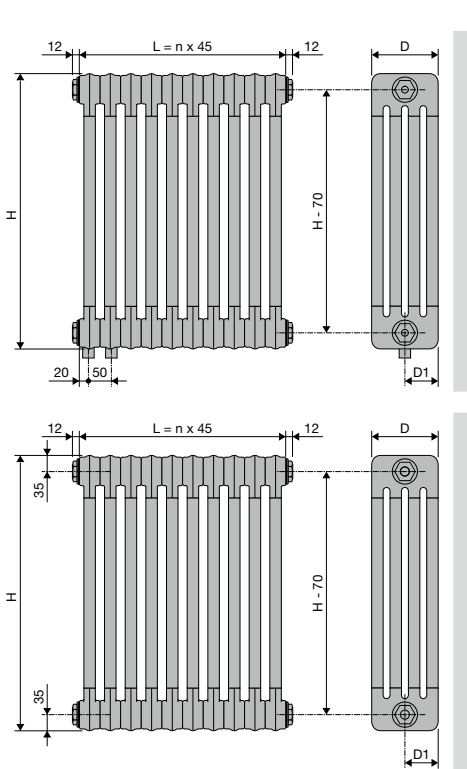

	HB-2K/65 / HB-3K/105 / HB-4K/145															
H	300	400	500	600	900											
diepte (D)	65	105	145													
D1	32,5	52,5	72,5													
aantal leden (n)	10	12	14	16	18	20	22	24	26	28	30	32	34	36	38	40



VINTAGE (VINTAGE 50)



TYPES

- Vintage 50: afstand tussen de leden 50 mm
- 4 dieptes (D110, D160, D220, D250)

KLEUREN

- Standaardkleur S600 (witte fijn structuurlak) (RAL 9016: geen meerprijs 15%)
- Verkrijgbaar in transparante coating (kleurcode 57)
- **Opgelet: een radiator in transparante coating niet in vochtige ruimtes plaatsen!**
- Uitgebreide kleurenkaart zie p. 12

SPECIAAL

- Vloer- of wandmontage

BEVESTIGINGEN

- Standaard wandbevestigingen of ledenvoeten, 1/2" blindstop, 1/2" ontluchter
- Bevestigingen in de kleur van de radiator (aantal afhankelijk van de lengte van de radiator)
- De voeten en bevestigingen van radiatoren in transparante coating zijn gelakt in de kleur N507.

TECHNISCH

- KTL-grondlaag, epoxy-polyester poedercoating
- Standaardwerkdruk: 5 bar
- Maximale bedrijfstemperatuur: 110°C

TECHNISCHE TEKENINGEN

- Zie p. 336

AANSLUITING

- 4x 1/2" (SL, SR, 26, 37)
- Ontluchter in aansluiting 3 of 6
- Aansluitingen: 1/2" (binnendraad)
- Aansluiting 27, 72: **meerprijs €69**

VINTAGE

Vroeger is weer helemaal van nu

Terug naar de 'oerradiator'. Erg populair omwille van de tot de verbeelding sprekende, authentieke look. Standaard aangeboden in een witte uitvoering, maar ook verkrijgbaar met een transparante coating voor een nog meer uitgesproken vintage look. De Vintage staat borg voor een zeer hoge warmteafgifte. Ideaal voor de verwarming van grote, hoge ruimten, ook in combinatie met energiezuinige technologieën. Een designradiator die als geen andere tot zijn recht komt in een retro-interieur en zich graag voor een raam laat plaatsen.

AANBEVOLEN AANSLUITING (LR)

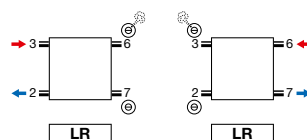

Andere aansluitmogelijkheden, zie p. 335



HOE VINTAGE 50 BESTELLEN

Leveringstermijn 15 - 30 werkdagen
(zonder transportduur)

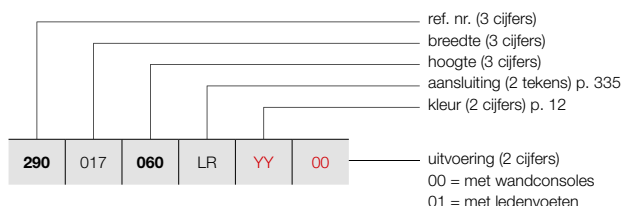

VINTAGE (VINTAGE 50 / D110)

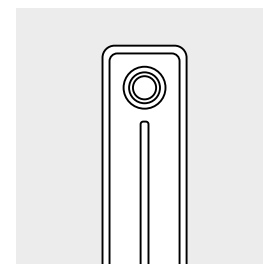

VINTAGE 50 / D110

PRIJSGROEP: VPG5 - KOLOMRADIATOREN

BESTELCODE MAATWERK VINTAGE 50	TECHNISCHE GEGEVENS								STANDAARDKLEUR	ANDERE KLEUREN	
	buizen	breedte (L mm)	hoogte (H mm)	75/65/20 (Watt) (Φ50K)	55/45/20 (Watt) (Φ30K)	n-exp.	gewicht (kg)	inhoud (l)			el. weerst. (Watt)
REF. NR. VINTAGE 50 VINTAGE 50/D110 : 290											
290 017 060 LR YY 00	3	178	600	165	87	1,25	4,17	2,49	-	367	422
	3	178	1000	252	131	1,28	6,57	3,39	-	393	452
290 022 060 LR YY 00	4	228	600	220	116	1,25	5,56	3,32	-	387	445
	4	228	1000	336	175	1,28	8,76	4,52	-	419	482
290 027 060 LR YY 00	5	278	600	275	145	1,25	6,95	4,15	-	405	466
	5	278	1000	420	218	1,28	10,95	5,65	-	446	513
290 032 060 LR YY 00	6	328	600	330	174	1,25	8,34	4,98	-	426	490
	6	328	1000	504	262	1,28	13,14	6,78	-	471	542
290 037 060 LR YY 00	7	378	600	385	203	1,25	9,73	5,81	-	441	507
	7	378	1000	588	306	1,28	15,33	7,91	-	497	572
290 042 060 LR YY 00	8	428	600	440	232	1,25	11,12	6,64	-	469	539
	8	428	1000	672	349	1,28	17,52	9,04	-	527	606
290 047 060 LR YY 00	9	478	600	495	261	1,25	12,51	7,47	-	483	555
	9	478	1000	756	393	1,28	19,71	10,17	-	554	637
290 052 060 LR YY 00	10	528	600	550	290	1,25	13,90	8,30	-	507	583
	10	528	1000	840	437	1,28	21,90	11,30	-	578	665
290 057 060 LR YY 00	11	578	600	605	319	1,25	15,29	9,13	-	526	605
	11	578	1000	924	481	1,28	24,09	12,43	-	610	702
290 062 060 LR YY 00	12	628	600	660	349	1,25	16,68	9,96	-	545	627
	12	628	1000	1008	524	1,28	26,28	13,56	-	635	730
290 067 060 LR YY 00	13	678	600	715	378	1,25	18,07	10,79	-	564	649
	13	678	1000	1092	568	1,28	28,47	14,69	-	662	761
290 072 060 LR YY 00	14	728	600	770	407	1,25	19,46	11,62	-	581	668
	14	728	1000	1176	612	1,28	30,66	15,82	-	687	790
290 077 060 LR YY 00	15	778	600	825	436	1,25	20,85	12,45	-	597	687
	15	778	1000	1260	655	1,28	32,85	16,95	-	712	819
290 082 060 LR YY 00	16	828	600	880	465	1,25	22,24	13,28	-	617	710
	16	828	1000	1344	699	1,28	35,04	18,08	-	737	848
290 087 060 LR YY 00	17	878	600	935	494	1,25	23,63	14,11	-	635	730
	17	878	1000	1428	743	1,28	37,23	19,21	-	760	874
290 092 060 LR YY 00	18	928	600	990	523	1,25	25,02	14,94	-	654	752
	18	928	1000	1512	786	1,28	39,42	20,34	-	788	906
290 097 060 LR YY 00	19	978	600	1045	552	1,25	26,41	15,77	-	670	771
	19	978	1000	1596	830	1,28	41,61	21,47	-	814	936

Conform EN442-1: 2014: radiatoren en convectoren

* RAL 9016: geen meerprijs 15%
 Voor meer details over onze artikel-data, zie artikel-database: <https://www.installdata.be>
Voor de warmteafgiftes van andere regimes, kijkt u op p. 346 (correctiefactoren)
BELGIË. Prijzen in euro (excl. BTW)

VINTAGE (VINTAGE 50 / D110)

HOE VINTAGE 50 BESTELLEN
Leveringstermijn 15 - 30 werkdagen
(zonder transportduur)

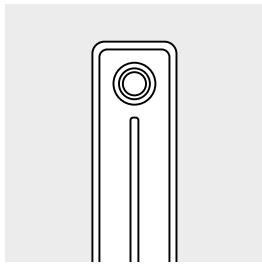

VINTAGE 50 / D110

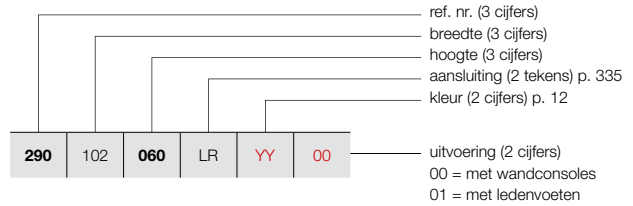

PRIJSGROEP: VPG5 - KOLOMRADIATOREN

BESTELCODE MAATWERK VINTAGE 50	TECHNISCHE GEGEVENS									STANDAARDKLEUR	ANDERE KLEUREN
	buizen	breedte (L mm)	hoogte (H mm)	75/65/20 (Watt) (Ø50K)	55/45/20 (Watt) (Ø30K)	n-exp.	gewicht (kg)	inhoud (l)	el. weerst. (Watt)	prijs S600* (€)	prijs kleur (€)
REF. NR. VINTAGE 50 VINTAGE 50/D110 : 290											
290 102 060 LR YY 00	20	1028	600	1100	581	1,25	27,80	16,60	-	689	792
	20	1028	1000	1680	874	1,28	43,80	22,60	-	837	963
290 107 060 LR YY 00	21	1078	600	1155	610	1,25	29,19	17,43	-	723	831
	21	1078	1000	1764	917	1,28	45,99	23,73	-	879	1011
290 112 060 LR YY 00	22	1128	600	1210	639	1,25	30,58	18,26	-	738	849
	22	1128	1000	1848	961	1,28	48,18	24,86	-	902	1037
290 117 060 LR YY 00	23	1178	600	1265	668	1,25	31,97	19,09	-	757	871
	23	1178	1000	1932	1005	1,28	50,37	25,99	-	924	1063
290 122 060 LR YY 00	24	1228	600	1320	697	1,25	33,36	19,92	-	773	889
	24	1228	1000	2016	1048	1,28	52,56	27,12	-	953	1096
290 127 060 LR YY 00	25	1278	600	1375	726	1,25	34,75	20,75	-	793	912
	25	1278	1000	2100	1092	1,28	54,75	28,25	-	977	1124
290 132 060 LR YY 00	26	1328	600	1430	755	1,25	36,14	21,58	-	826	950
	26	1328	1000	2184	1136	1,28	56,94	29,38	-	1017	1170
290 137 060 LR YY 00	27	1378	600	1485	784	1,25	37,53	22,41	-	842	968
	27	1378	1000	2268	1179	1,28	59,13	30,51	-	1045	1202
290 142 060 LR YY 00	28	1428	600	1540	813	1,25	38,92	23,24	-	863	992
	28	1428	1000	2352	1223	1,28	61,32	31,64	-	1068	1228
290 147 060 LR YY 00	29	1478	600	1595	842	1,25	40,31	24,07	-	881	1013
	29	1478	1000	2436	1267	1,28	63,51	32,77	-	1093	1257
290 152 060 LR YY 00	30	1528	600	1650	871	1,25	41,70	24,90	-	897	1032
	30	1528	1000	2520	1310	1,28	65,70	33,90	-	1120	1288
290 157 060 LR YY 00	31	1578	600	1705	900	1,25	43,09	25,73	-	917	1055
	31	1578	1000	2604	1354	1,28	67,89	35,03	-	1150	1323
290 162 060 LR YY 00	32	1628	600	1760	929	1,25	44,48	26,56	-	933	1073
	32	1628	1000	2688	1398	1,28	70,08	36,16	-	1177	1354
290 167 060 LR YY 00	33	1678	600	1815	958	1,25	45,87	27,39	-	990	1139
	33	1678	1000	2772	1442	1,28	72,27	37,29	-	1242	1428
290 172 060 LR YY 00	34	1728	600	1870	987	1,25	47,26	28,22	-	1010	1162
	34	1728	1000	2856	1485	1,28	74,46	38,42	-	1266	1456
290 177 060 LR YY 00	35	1778	600	1925	1017	1,25	48,65	29,05	-	1029	1183
	35	1778	1000	2940	1529	1,28	76,65	39,55	-	1292	1486
290 182 060 LR YY 00	36	1828	600	1980	1046	1,25	50,04	29,88	-	1050	1208
	36	1828	1000	3024	1573	1,28	78,84	40,68	-	1315	1512
290 187 060 LR YY 00	37	1878	600	2035	1075	1,25	51,43	30,71	-	1066	1226
	37	1878	1000	3108	1616	1,28	81,03	41,81	-	1342	1543

Conform EN442-1: 2014: radiatoren en convectoren

* RAL 9016: geen meerprijs 15%

Voor meer details over onze artikel-data, zie artikel-database: <https://www.installdata.be>

Voor de warmteafgiftes van andere regimes, kijkt u op p. 346 (correctiefactoren)

BELGIË. Prijzen in euro (excl. BTW)

HOE VINTAGE 50 BESTELLEN

Leveringstermijn 15 - 30 werkdagen
(zonder transportduur)

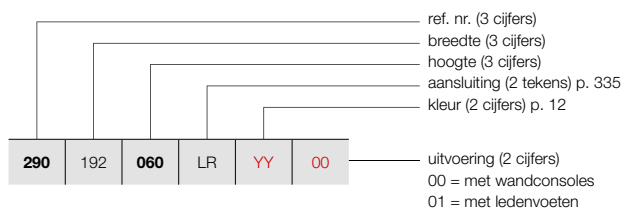

VINTAGE (VINTAGE 50 / D110)

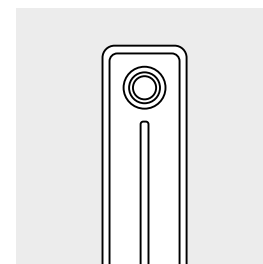

VINTAGE 50 / D110

PRIJSGROEP: VPG5 - KOLOMRADIATOREN

BESTELCODE MAATWERK VINTAGE 50	TECHNISCHE GEGEVENS							STANDAARDKLEUR		ANDERE KLEUREN						
	buizen	breedte (L mm)	hoogte (H mm)	75/65/20 (Watt) (φ50K)	55/45/20 (Watt) (φ30K)	n-exp.	gewicht (kg)	inhoud (l)	el. weerst. (Watt)	prijs S600* (€)	prijs kleur (€)					
REF. NR. VINTAGE 50 VINTAGE 50/D110 : 290																
290	192	060	LR	YY	00											
		100														
						38	1928	600	2090	1104	1,25	52,82	31,54	-	1086	1249
						38	1928	1000	3192	1660	1,28	83,22	42,94	-	1365	1570
290	197	060	LR	YY	00											
		100														
						39	1978	600	2145	1133	1,25	54,21	32,37	-	1105	1271
						39	1978	1000	3276	1704	1,28	85,41	44,07	-	1393	1602
290	202	060	LR	YY	00											
		100														
						40	2028	600	2200	1162	1,25	55,60	33,20	-	1123	1291
						40	2028	1000	3360	1747	1,28	87,60	45,20	-	1416	1628
290	207	060	LR	YY	00											
		100														
						41	2078	600	2255	1191	1,25	56,99	34,03	-	1138	1309
						41	2078	1000	3444	1791	1,28	89,79	46,33	-	1444	1661
290	212	060	LR	YY	00											
		100														
						42	2128	600	2310	1220	1,25	58,38	34,86	-	1160	1334
						42	2128	1000	3528	1835	1,28	91,98	47,46	-	1468	1688
290	217	060	LR	YY	00											
		100														
						43	2178	600	2365	1249	1,25	59,77	35,69	-	1177	1354
						43	2178	1000	3612	1878	1,28	94,17	48,59	-	1494	1718
290	222	060	LR	YY	00											
		100														
						44	2228	600	2420	1278	1,25	61,16	36,52	-	1196	1375
						44	2228	1000	3696	1922	1,28	96,36	49,72	-	1521	1749
290	227	060	LR	YY	00											
		100														
						45	2278	600	2475	1307	1,25	62,55	37,35	-	1211	1393
						45	2278	1000	3780	1966	1,28	98,55	50,85	-	1544	1776
290	232	060	LR	YY	00											
						46	2328	600	2530	1336	1,25	63,94	38,18	-	1231	1416
290	237	060	LR	YY	00											
						47	2378	600	2585	1365	1,25	65,33	39,01	-	1247	1434
290	242	060	LR	YY	00											
						48	2428	600	2640	1394	1,25	66,72	39,84	-	1266	1456
290	247	060	LR	YY	00											
						49	2478	600	2695	1423	1,25	68,11	40,67	-	1282	1474
290	252	060	LR	YY	00											
						50	2528	600	2750	1452	1,25	69,50	41,50	-	1305	1501
290	257	060	LR	YY	00											
						51	2578	600	2805	1481	1,25	70,89	42,33	-	1338	1539
290	262	060	LR	YY	00											
						52	2628	600	2860	1510	1,25	72,28	43,16	-	1354	1557
290	267	060	LR	YY	00											
						53	2678	600	2915	1539	1,25	73,67	43,99	-	1369	1574
290	272	060	LR	YY	00											
						54	2728	600	2970	1568	1,25	75,06	44,82	-	1391	1600
290	277	060	LR	YY	00											
						55	2778	600	3025	1597	1,25	76,45	45,65	-	1408	1619
290	282	060	LR	YY	00											
						56	2828	600	3080	1626	1,25	77,84	46,48	-	1427	1641
290	287	060	LR	YY	00											
						57	2878	600	3135	1655	1,25	79,23	47,31	-	1444	1661
290	292	060	LR	YY	00											
						58	2928	600	3190	1685	1,25	80,62	48,14	-	1460	1679
290	297	060	LR	YY	00											
						59	2978	600	3245	1714	1,25	82,01	48,97	-	1480	1702
290	302	060	LR	YY	00											
						60	3028	600	3300	1743	1,25	83,40	49,80	-	1496	1720

Conform EN442-1: 2014: radiatoren en convectoren

* RAL 9016: geen meerprijs 15%

Voor meer details over onze artikel-data, zie artikel-database: <https://www.installdata.be>

Voor de warmteafgiftes van andere regimes, kijkt u op p. 346 (correctiefactoren)
BELGIË. Prijzen in euro (excl. BTW)

VINTAGE (VINTAGE 50 / D160)

HOE VINTAGE 50 BESTELLEN

Leveringstermijn 15 - 30 werkdagen
(zonder transportduur)

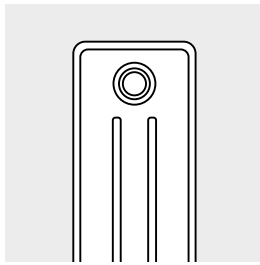

VINTAGE 50 / D160

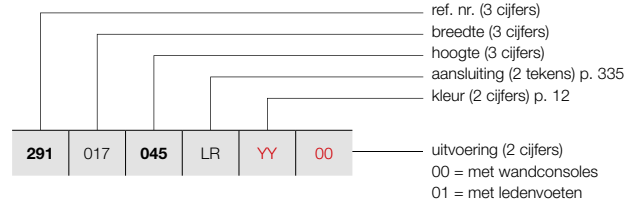

PRIJSGROEP: VPG5 - KOLOMRADIATOREN

BESTELCODE MAATWERK VINTAGE 50							TECHNISCHE GEGEVENS				STANDAARDKLEUR	ANDERE KLEUREN
buizen	breedte (L mm)	hoogte (H mm)	75/65/20 (Watt) (Ø50K)	55/45/20 (Watt) (Ø30K)	n-exp.	gewicht (kg)	inhoud (l)	el. weerst. (Watt)	prijs S600* (€)	prijs kleur (€)		
REF. NR. VINTAGE 50 VINTAGE 50/D160 : 291												
291	017	045	LR	YY	00							
		060										
		100										
3	178	450	174	92	1,24	4,47	2,82	-	370	426		
3	178	600	219	115	1,26	6,00	3,42	-	387	445		
3	178	1000	333	172	1,29	9,63	4,89	-	422	485		
291	022	045	LR	YY	00							
		060										
		100										
4	228	450	232	123	1,24	5,96	3,76	-	392	451		
4	228	600	292	153	1,26	8,00	4,56	-	406	467		
4	228	1000	444	230	1,29	12,84	6,52	-	450	518		
291	027	045	LR	YY	00							
		060										
		100										
5	278	450	290	154	1,24	7,45	4,70	-	408	469		
5	278	600	365	192	1,26	10,00	5,70	-	432	497		
5	278	1000	555	287	1,29	16,05	8,15	-	483	555		
291	032	045	LR	YY	00							
		060										
		100										
6	328	450	348	185	1,24	8,94	5,64	-	428	492		
6	328	600	438	230	1,26	12,00	6,84	-	454	522		
6	328	1000	666	345	1,29	19,26	9,78	-	517	595		
291	037	045	LR	YY	00							
		060										
		100										
7	378	450	406	215	1,24	10,43	6,58	-	445	512		
7	378	600	511	268	1,26	14,00	7,98	-	474	545		
7	378	1000	777	402	1,29	22,47	11,41	-	551	634		
291	042	045	LR	YY	00							
		060										
		100										
8	428	450	464	246	1,24	11,92	7,52	-	470	541		
8	428	600	584	307	1,26	16,00	9,12	-	508	584		
8	428	1000	888	459	1,29	25,68	13,04	-	588	676		
291	047	045	LR	YY	00							
		060										
		100										
9	478	450	522	277	1,24	13,41	8,46	-	485	558		
9	478	600	657	345	1,26	18,00	10,26	-	526	605		
9	478	1000	999	517	1,29	28,89	14,67	-	618	711		
291	052	045	LR	YY	00							
		060										
		100										
10	528	450	580	308	1,24	14,90	9,40	-	507	583		
10	528	600	730	384	1,26	20,00	11,40	-	551	634		
10	528	1000	1110	574	1,29	32,10	16,30	-	651	749		
291	057	045	LR	YY	00							
		060										
		100										
11	578	450	638	339	1,24	16,39	10,34	-	527	606		
11	578	600	803	422	1,26	22,00	12,54	-	577	664		
11	578	1000	1221	632	1,29	35,31	17,93	-	689	792		
291	062	045	LR	YY	00							
		060										
		100										
12	628	450	696	369	1,24	17,88	11,28	-	545	627		
12	628	600	876	460	1,26	24,00	13,68	-	597	687		
12	628	1000	1332	689	1,29	38,52	19,56	-	723	831		
291	067	045	LR	YY	00							
		060										
		100										
13	678	450	754	400	1,24	19,37	12,22	-	562	646		
13	678	600	949	499	1,26	26,00	14,82	-	619	712		
13	678	1000	1443	747	1,29	41,73	21,19	-	752	865		
291	072	045	LR	YY	00							
		060										
		100										
14	728	450	812	431	1,24	20,86	13,16	-	579	666		
14	728	600	1022	537	1,26	28,00	15,96	-	644	741		
14	728	1000	1554	804	1,29	44,94	22,82	-	786	904		
291	077	045	LR	YY	00							
		060										
		100										
15	778	450	870	462	1,24	22,35	14,10	-	597	687		
15	778	600	1095	575	1,26	30,00	17,10	-	665	765		
15	778	1000	1665	861	1,29	48,15	24,45	-	816	938		

Conform EN442-1: 2014: radiatoren en convectoren

* RAL 9016: geen meerprijs 15%

Voor meer details over onze artikel-data, zie artikel-database: <https://www.installdata.be>

Voor de warmteafgifte van andere regimes, kijkt u op p. 346 (correctiefactoren)
 BELGIË. Prijzen in euro (excl. BTW)

HOE VINTAGE 50 BESTELLEN

Leveringstermijn 15 - 30 werkdagen
(zonder transportduur)

VINTAGE (VINTAGE 50 / D160)

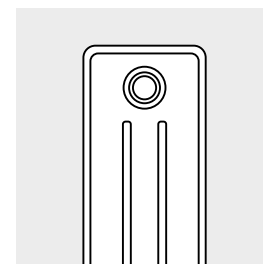
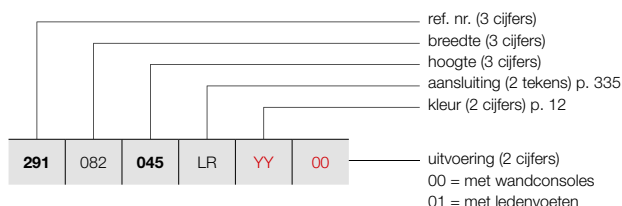

VINTAGE 50 / D160

PRIJSGROEP: VPG5 - KOLOMRADIATOREN

BESTELCODE MAATWERK VINTAGE 50							TECHNISCHE GEGEVENS					STANDAARDKLEUR	ANDERE KLEUREN			
buizen	breedte (L mm)	hoogte (H mm)	75/65/20 (Watt) (φ50K)	55/45/20 (Watt) (φ30K)	n-exp.	gewicht (kg)	inhoud (l)	el. weerst. (Watt)	prijs S600* (€)	prijs kleur (€)						
REF. NR. VINTAGE 50 VINTAGE 50/D160 : 291																
291	082	045	LR	YY	00	16	828	450	928	493	1,24	23,84	15,04	-	616	708
		060				16	828	600	1168	614	1,26	32,00	18,24	-	687	790
		100				16	828	1000	1776	919	1,29	51,36	26,08	-	847	974
291	087	045	LR	YY	00	17	878	450	986	523	1,24	25,33	15,98	-	634	729
		060				17	878	600	1241	652	1,26	34,00	19,38	-	708	814
		100				17	878	1000	1887	976	1,29	54,57	27,71	-	881	1013
291	092	045	LR	YY	00	18	928	450	1044	554	1,24	26,82	16,92	-	651	749
		060				18	928	600	1314	690	1,26	36,00	20,52	-	731	841
		100				18	928	1000	1998	1034	1,29	57,78	29,34	-	915	1052
291	097	045	LR	YY	00	19	978	450	1102	585	1,24	28,31	17,86	-	667	767
		060				19	978	600	1387	729	1,26	38,00	21,66	-	752	865
		100				19	978	1000	2109	1091	1,29	60,99	30,97	-	946	1088
291	102	045	LR	YY	00	20	1028	450	1160	616	1,24	29,80	18,80	-	687	790
		060				20	1028	600	1460	767	1,26	40,00	22,80	-	773	889
		100				20	1028	1000	2220	1149	1,29	64,20	32,60	-	977	1124
291	107	045	LR	YY	00	21	1078	450	1218	646	1,24	31,29	19,74	-	717	825
		060				21	1078	600	1533	805	1,26	42,00	23,94	-	809	930
		100				21	1078	1000	2331	1206	1,29	67,41	34,23	-	1020	1173
291	112	045	LR	YY	00	22	1128	450	1276	677	1,24	32,78	20,68	-	735	845
		060				22	1128	600	1606	844	1,26	44,00	25,08	-	832	957
		100				22	1128	1000	2442	1263	1,29	70,62	35,86	-	1053	1211
291	117	045	LR	YY	00	23	1178	450	1334	708	1,24	34,27	21,62	-	752	865
		060				23	1178	600	1679	882	1,26	46,00	26,22	-	850	978
		100				23	1178	1000	2553	1321	1,29	73,83	37,49	-	1085	1248
291	122	045	LR	YY	00	24	1228	450	1392	739	1,24	35,76	22,56	-	768	883
		060				24	1228	600	1752	920	1,26	48,00	27,36	-	876	1007
		100				24	1228	1000	2664	1378	1,29	77,04	39,12	-	1119	1287
291	127	045	LR	YY	00	25	1278	450	1450	770	1,24	37,25	23,50	-	787	905
		060				25	1278	600	1825	959	1,26	50,00	28,50	-	896	1030
		100				25	1278	1000	2775	1436	1,29	80,25	40,75	-	1148	1320
291	132	045	LR	YY	00	26	1328	450	1508	800	1,24	38,74	24,44	-	823	946
		060				26	1328	600	1898	997	1,26	52,00	29,64	-	934	1074
		100				26	1328	1000	2886	1493	1,29	83,46	42,38	-	1198	1378
291	137	045	LR	YY	00	27	1378	450	1566	831	1,24	40,23	25,38	-	838	964
		060				27	1378	600	1971	1036	1,26	54,00	30,78	-	956	1099
		100				27	1378	1000	2997	1551	1,29	86,67	44,01	-	1231	1416
291	142	045	LR	YY	00	28	1428	450	1624	862	1,24	41,72	26,32	-	855	983
		060				28	1428	600	2044	1074	1,26	56,00	31,92	-	978	1125
		100				28	1428	1000	3108	1608	1,29	89,88	45,64	-	1263	1452

Conform EN442-1: 2014: radiatoren en convectoren

* RAL 9016: geen meerprijs 15%

Voor meer details over onze artikel-data, zie artikel-database: <https://www.installdata.be>

Voor de warmteafgiftes van andere regimes, kijkt u op p. 346 (correctiefactoren)

BELGIË. Prijzen in euro (excl. BTW)

VINTAGE (VINTAGE 50 / D160)

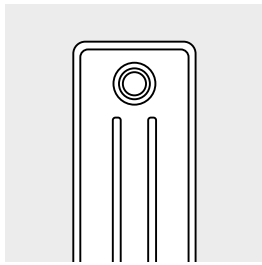

VINTAGE 50 / D160

HOE VINTAGE 50 BESTELLEN
Leveringstermijn 15 - 30 werkdagen
(zonder transportduur)

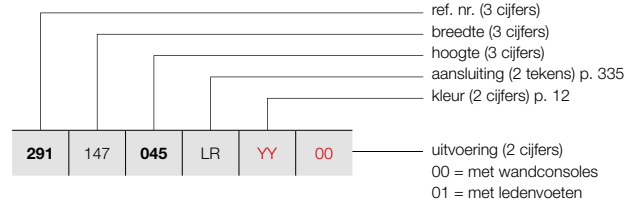

PRIJSGROEP: VPG5 - KOLOMRADIATOREN

BESTELCODE MAATWERK VINTAGE 50							TECHNISCHE GEGEVENS					STANDAARDKLEUR	ANDERE KLEUREN			
ref. nr.	breedte (L mm)	hoogte (H mm)	75/65/20 (Watt) (Φ50K)	55/45/20 (Watt) (Φ30K)	n-exp.	gewicht (kg)	inhoud (l)	el. weerst. (Watt)	prijs S600* (€)	prijs kleur (€)						
REF. NR. VINTAGE 50 VINTAGE 50/D160 : 291																
291	147	045	LR	YY	00	29	1478	450	1682	893	1,24	43,21	27,26	-	876	1007
		060				29	1478	600	2117	1112	1,26	58,00	33,06	-	998	1148
		100				29	1478	1000	3219	1665	1,29	93,09	47,27	-	1294	1488
291	152	045	LR	YY	00	30	1528	450	1740	924	1,24	44,70	28,20	-	890	1024
		060				30	1528	600	2190	1151	1,26	60,00	34,20	-	1023	1176
		100				30	1528	1000	3330	1723	1,29	96,30	48,90	-	1323	1521
291	157	045	LR	YY	00	31	1578	450	1798	954	1,24	46,19	29,14	-	909	1045
		060				31	1578	600	2263	1189	1,26	62,00	34,34	-	1045	1202
291	162	045	LR	YY	00	32	1628	450	1856	985	1,24	47,68	30,08	-	924	1063
		060				32	1628	600	2336	1227	1,26	64,00	36,48	-	1065	1225
291	167	045	LR	YY	00	33	1678	450	1914	1016	1,24	49,17	31,02	-	985	1133
		060				33	1678	600	2409	1266	1,26	66,00	37,62	-	1128	1297
291	172	045	LR	YY	00	34	1728	450	1972	1047	1,24	50,66	31,96	-	998	1148
		060				34	1728	600	2482	1304	1,26	68,00	38,76	-	1150	1323
291	177	045	LR	YY	00	35	1778	450	2030	1077	1,24	52,15	32,90	-	1017	1170
		060				35	1778	600	2555	1342	1,26	70,00	39,90	-	1170	1346
291	182	045	LR	YY	00	36	1828	450	2088	1108	1,24	53,64	33,84	-	1044	1201
		060				36	1828	600	2628	1381	1,26	72,00	41,04	-	1199	1379
291	187	045	LR	YY	00	37	1878	450	2146	1139	1,24	55,13	34,78	-	1059	1218
		060				37	1878	600	2701	1419	1,26	74,00	42,18	-	1218	1401
291	192	045	LR	YY	00	38	1928	450	2204	1170	1,24	56,62	35,72	-	1079	1241
		060				38	1928	600	2774	1457	1,26	76,00	43,32	-	1243	1429
291	197	045	LR	YY	00	39	1978	450	2262	1201	1,24	58,11	36,66	-	1093	1257
		060				39	1978	600	2847	1496	1,26	78,00	44,46	-	1265	1455
291	202	045	LR	YY	00	40	2028	450	2320	1231	1,24	59,60	37,60	-	1111	1278
		060				40	2028	600	2920	1534	1,26	80,00	45,60	-	1285	1478
291	207	045	LR	YY	00	41	2078	450	2378	1262	1,24	61,09	38,54	-	1130	1300
		060				41	2078	600	2993	1572	1,26	82,00	46,74	-	1310	1507
291	212	045	LR	YY	00	42	2128	450	2436	1293	1,24	62,58	39,48	-	1147	1319
		060				42	2128	600	3066	1611	1,26	84,00	47,88	-	1333	1533
291	217	045	LR	YY	00	43	2178	450	2494	1324	1,24	64,07	40,42	-	1164	1339
		060				43	2178	600	3139	1649	1,26	86,00	49,02	-	1352	1555
291	222	045	LR	YY	00	44	2228	450	2552	1355	1,24	65,56	41,36	-	1183	1360
		060				44	2228	600	3212	1688	1,26	88,00	50,16	-	1373	1579

Conform EN442-1: 2014: radiatoren en convectoren

* RAL 9016: geen meerprijs 15%

Voor meer details over onze artikel-data, zie artikel-database: <https://www.installdata.be>

Voor de warmteafgiftes van andere regimes, kijkt u op p. 346 (correctiefactoren)
BELGIË. Prijzen in euro (excl. BTW)

HOE VINTAGE 50 BESTELLEN

Leveringstermijn 15 - 30 werkdagen
(zonder transportduur)

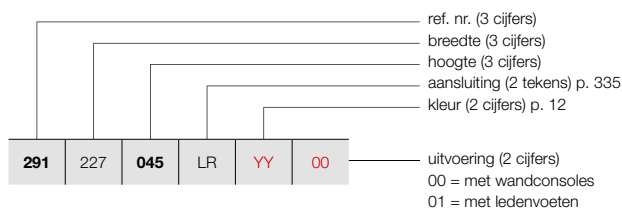

VINTAGE (VINTAGE 50 / D160)

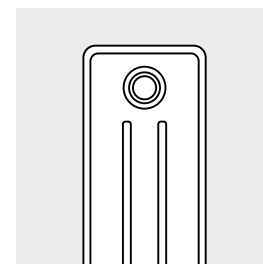

VINTAGE 50 / D160

PRIJSGROEP: VPG5 - KOLOMRADIATOREN

BESTELCODE MAATWERK VINTAGE 50	TECHNISCHE GEGEVENS							STANDAARDKLEUR		ANDERE KLEUREN						
	buizen	breedte (L mm)	hoogte (H mm)	75/65/20 (Watt) (Φ50K)	55/45/20 (Watt) (Φ30K)	n-exp.	gewicht (kg)	inhoud (l)	el. weerst. (Watt)	prijs S600* (€)	prijs kleur (€)					
REF. NR. VINTAGE 50 VINTAGE 50/D160 : 291																
291	227	045	LR	YY	00											
		060														
						45	2278	450	2610	1385	1,24	67,05	42,30	-	1200	1380
						45	2278	600	3285	1726	1,26	90,00	51,30	-	1395	1604
291	232	045	LR	YY	00											
		060														
						46	2328	450	2668	1416	1,24	68,54	43,24	-	1216	1398
						46	2328	600	3358	1764	1,26	92,00	52,44	-	1416	1628
291	237	045	LR	YY	00											
		060														
						47	2378	450	2726	1447	1,24	70,03	44,18	-	1236	1421
						47	2378	600	3431	1803	1,26	94,00	53,58	-	1440	1656
291	242	045	LR	YY	00											
		060														
						48	2428	450	2784	1478	1,24	71,52	45,12	-	1253	1441
						48	2428	600	3504	1841	1,26	96,00	54,72	-	1460	1679
291	247	045	LR	YY	00											
						49	2478	450	2842	1508	1,24	73,01	46,06	-	1271	1462
291	252	045	LR	YY	00											
						50	2528	450	2900	1539	1,24	74,50	47,00	-	1286	1479
291	257	045	LR	YY	00											
						51	2578	450	2958	1570	1,24	75,99	47,94	-	1320	1518
291	262	045	LR	YY	00											
						52	2628	450	3016	1601	1,24	77,48	48,88	-	1341	1542
291	267	045	LR	YY	00											
						53	2678	450	3074	1632	1,24	78,97	49,82	-	1356	1559
291	272	045	LR	YY	00											
						54	2728	450	3132	1662	1,24	80,46	50,76	-	1374	1580
291	277	045	LR	YY	00											
						55	2778	450	3190	1693	1,24	81,95	51,70	-	1393	1602
291	282	045	LR	YY	00											
						56	2828	450	3248	1724	1,24	83,44	52,64	-	1410	1622
291	287	045	LR	YY	00											
						57	2878	450	3306	1755	1,24	84,93	53,58	-	1428	1642
291	292	045	LR	YY	00											
						58	2928	450	3364	1786	1,24	86,42	54,52	-	1446	1663
291	297	045	LR	YY	00											
						59	2978	450	3422	1816	1,24	87,91	55,46	-	1462	1681
291	302	045	LR	YY	00											
						60	3028	450	3480	1847	1,24	89,40	56,40	-	1482	1704

Conform EN442-1: 2014: radiatoren en convectoren

* RAL 9016: geen meerprijs 15%

Voor meer details over onze artikel-data, zie artikel-database: <https://www.installdata.be>

Voor de warmteafgiftes van andere regimes, kijkt u op p. 346 (correctiefactoren)
BELGIË. Prijzen in euro (excl. BTW)

VINTAGE (VINTAGE 50 / D220)

HOE VINTAGE 50 BESTELLEN

Leveringstermijn 15 - 30 werkdagen
(zonder transportduur)

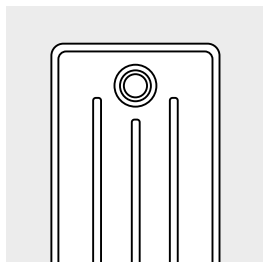

VINTAGE 50 / D220

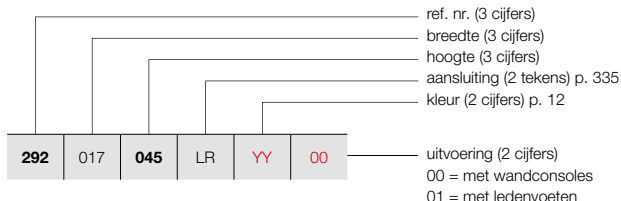

PRIJSGROEP: VPG5 - KOLOMRADIATOREN

BESTELCODE MAATWERK VINTAGE 50							TECHNISCHE GEGEVENS					STANDAARDKLEUR	ANDERE KLEUREN			
buizen	breedte (L mm)	hoogte (H mm)	75/65/20 (Watt) (Ø50K)	55/45/20 (Watt) (Ø30K)	n-exp.	gewicht (kg)	inhoud (l)	el. weerst. (Watt)	prijs S600* (€)	prijs kleur (€)						
REF. NR. VINTAGE 50 VINTAGE 50/D220 : 292																
292	017	045	LR	YY	00	3	178	450	225	119	1,25	6,00	3,69	-	384	442
		060				3	178	600	282	148	1,26	7,86	4,44	-	401	461
		100				3	178	1000	435	226	1,28	13,68	7,26	-	445	512
292	022	045	LR	YY	00	4	228	450	300	158	1,25	8,00	4,92	-	404	465
		060				4	228	600	376	198	1,26	10,48	5,92	-	431	496
		100				4	228	1000	580	302	1,28	18,24	9,68	-	485	558
292	027	045	LR	YY	00	5	278	450	375	198	1,25	10,00	6,15	-	430	495
		060				5	278	600	470	247	1,26	13,10	7,40	-	458	527
		100				5	278	1000	725	377	1,28	22,80	12,10	-	527	606
292	032	045	LR	YY	00	6	328	450	450	238	1,25	12,00	7,38	-	450	518
		060				6	328	600	564	296	1,26	15,72	8,88	-	483	555
		100				6	328	1000	870	452	1,28	27,36	14,52	-	570	656
292	037	045	LR	YY	00	7	378	450	525	277	1,25	14,00	8,61	-	471	542
		060				7	378	600	658	346	1,26	18,34	10,36	-	513	590
		100				7	378	1000	1015	528	1,28	31,92	16,94	-	610	702
292	042	045	LR	YY	00	8	428	450	600	317	1,25	16,00	9,84	-	499	574
		060				8	428	600	752	395	1,26	20,96	11,84	-	545	627
		100				8	428	1000	1160	603	1,28	36,48	19,36	-	657	756
292	047	045	LR	YY	00	9	478	450	675	356	1,25	18,00	11,07	-	519	597
		060				9	478	600	846	444	1,26	23,58	13,32	-	572	658
		100				9	478	1000	1305	679	1,28	41,04	21,78	-	696	800
292	052	045	LR	YY	00	10	528	450	750	396	1,25	20,00	12,30	-	539	620
		060				10	528	600	940	494	1,26	26,20	14,80	-	597	687
		100				10	528	1000	1450	754	1,28	45,60	24,20	-	739	850
292	057	045	LR	YY	00	11	578	450	825	436	1,25	22,00	13,53	-	570	656
		060				11	578	600	1034	543	1,26	28,82	16,28	-	629	723
		100				11	578	1000	1595	829	1,28	50,16	26,62	-	787	905
292	062	045	LR	YY	00	12	628	450	900	475	1,25	24,00	14,76	-	591	680
		060				12	628	600	1128	593	1,26	31,44	17,76	-	660	759
		100				12	628	1000	1740	905	1,28	54,72	29,04	-	827	951
292	067	045	LR	YY	00	13	678	450	975	515	1,25	26,00	15,99	-	611	703
		060				13	678	600	1222	642	1,26	34,06	19,24	-	687	790
		100				13	678	1000	1885	980	1,28	59,28	31,46	-	869	999
292	072	045	LR	YY	00	14	728	450	1050	554	1,25	28,00	17,22	-	629	723
		060				14	728	600	1316	691	1,26	36,68	20,72	-	714	821
		100				14	728	1000	2030	1056	1,28	63,84	33,88	-	908	1044
292	077	045	LR	YY	00	15	778	450	1125	594	1,25	30,00	18,45	-	654	752
		060				15	778	600	1410	741	1,26	39,30	22,20	-	739	850
		100				15	778	1000	2175	1131	1,28	68,40	36,30	-	950	1093

Conform EN442-1: 2014: radiatoren en convectoren

* RAL 9016: geen meerprijs 15%

Voor meer details over onze artikel-data, zie artikel-database: <https://www.installdata.be>

Voor de warmteafgifte van andere regimes, kijkt u op p. 346 (correctiefactoren)
 BELGIË. Prijzen in euro (excl. BTW)

HOE VINTAGE 50 BESTELLEN

Leveringstermijn 15 - 30 werkdagen
(zonder transportduur)

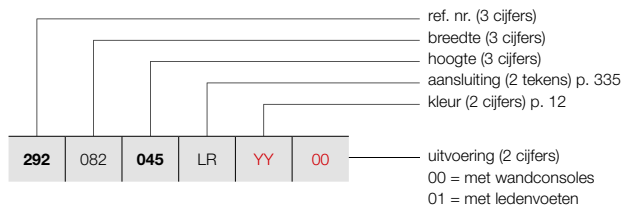

VINTAGE (VINTAGE 50 / D220)

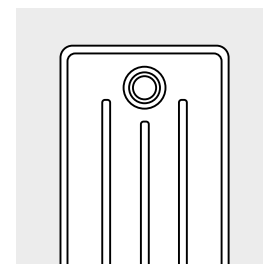

VINTAGE 50 / D220

PRIJSGROEP: VPG5 - KOLOMRADIATOREN

BESTELCODE MAATWERK VINTAGE 50	TECHNISCHE GEGEVENS							STANDAARDKLEUR	ANDERE KLEUREN							
	buizen	breedte (L mm)	hoogte (H mm)	75/65/20 (Watt) (φ50K)	55/45/20 (Watt) (φ30K)	n-exp.	gewicht (kg)			inhoud (l)	el. weerst. (Watt)	prijs S600* (€)	prijs kleur (€)			
REF. NR. VINTAGE 50 VINTAGE 50/D220 : 292																
292	082	045	LR	YY	00	16	828	450	1200	634	1,25	32,00	19,68	-	672	773
		060				16	828	600	1504	790	1,26	41,92	23,68	-	766	881
		100				16	828	1000	2320	1206	1,28	72,96	38,72	-	990	1139
292	087	045	LR	YY	00	17	878	450	1275	673	1,25	34,00	20,91	-	693	797
		060				17	878	600	1598	840	1,26	44,54	25,16	-	794	913
		100				17	878	1000	2465	1282	1,28	77,52	41,14	-	1032	1187
292	092	045	LR	YY	00	18	928	450	1350	713	1,25	36,00	22,14	-	717	825
		060				18	928	600	1692	889	1,26	47,16	26,64	-	823	946
		100				18	928	1000	2610	1357	1,28	82,08	43,56	-	1072	1233
292	097	045	LR	YY	00	19	978	450	1425	752	1,25	38,00	23,37	-	738	849
		060				19	978	600	1786	938	1,26	49,78	28,12	-	846	973
		100				19	978	1000	2755	1433	1,28	86,64	45,98	-	1115	1282
292	102	045	LR	YY	00	20	1028	450	1500	792	1,25	40,00	24,60	-	758	872
		060				20	1028	600	1880	988	1,26	52,40	29,60	-	876	1007
		100				20	1028	1000	2900	1508	1,28	91,20	48,40	-	1153	1326
292	107	045	LR	YY	00	21	1078	450	1575	832	1,25	42,00	25,83	-	793	912
		060				21	1078	600	1974	1037	1,26	55,02	31,08	-	915	1052
		100				21	1078	1000	3045	1584	1,28	95,76	50,82	-	1209	1390
292	112	045	LR	YY	00	22	1128	450	1650	871	1,25	44,00	27,06	-	815	937
		060				22	1128	600	2068	1086	1,26	57,64	32,56	-	941	1082
		100				22	1128	1000	3190	1659	1,28	100,32	53,24	-	1248	1435
292	117	045	LR	YY	00	23	1178	450	1725	911	1,25	46,00	28,29	-	835	960
		060				23	1178	600	2162	1136	1,26	60,26	34,04	-	969	1114
		100				23	1178	1000	3335	1734	1,28	104,88	55,66	-	1291	1485
292	122	045	LR	YY	00	24	1228	450	1800	951	1,25	48,00	29,52	-	855	983
		060				24	1228	600	2256	1185	1,26	62,88	35,52	-	994	1143
		100				24	1228	1000	3480	1810	1,28	109,44	58,08	-	1333	1533
292	127	045	LR	YY	00	25	1278	450	1875	990	1,25	50,00	30,75	-	879	1011
		060				25	1278	600	2350	1235	1,26	65,50	37,00	-	1020	1173
		100				25	1278	1000	3625	1885	1,28	114,00	60,50	-	1369	1574
292	132	045	LR	YY	00	26	1328	450	1950	1030	1,25	52,00	31,98	-	916	1053
		060				26	1328	600	2444	1284	1,26	68,12	38,48	-	1064	1224
		100				26	1328	1000	3770	1961	1,28	118,56	62,92	-	1429	1643
292	137	045	LR	YY	00	27	1378	450	2025	1069	1,25	54,00	33,21	-	935	1075
		060				27	1378	600	2538	1333	1,26	70,74	39,96	-	1090	1254
		100				27	1378	1000	3915	2036	1,28	123,12	65,34	-	1470	1691
292	142	045	LR	YY	00	28	1428	450	2100	1109	1,25	56,00	34,44	-	956	1099
		060				28	1428	600	2632	1383	1,26	73,36	41,44	-	1119	1287
		100				28	1428	1000	4060	2111	1,28	127,68	67,76	-	1510	1737

Conform EN442-1: 2014: radiatoren en convectoren

* RAL 9016: geen meerprijs 15%

Voor meer details over onze artikel-data, zie artikel-database: <https://www.installdata.be>

Voor de warmteafgiftes van andere regimes, kijkt u op p. 346 (correctiefactoren)

BELGIË. Prijzen in euro (excl. BTW)

VINTAGE (VINTAGE 50 / D220)

HOE VINTAGE 50 BESTELLEN
Leveringstermijn 15 - 30 werkdagen
(zonder transportduur)

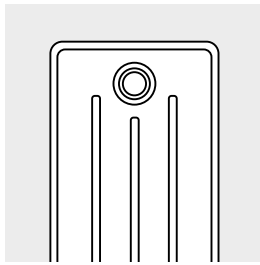

VINTAGE 50 / D220

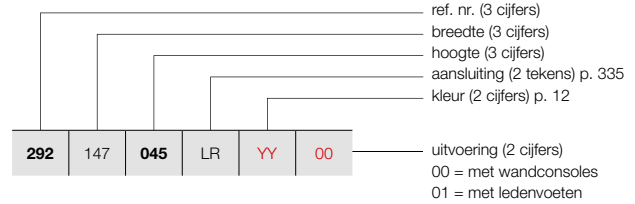

PRIJSGROEP: VPG5 - KOLOMRADIATOREN

BESTELCODE MAATWERK VINTAGE 50							TECHNISCHE GEGEVENS				STANDAARDKLEUR	ANDERE KLEUREN							
292	147	045	LR	YY	00	060	100	buizen	breedte (L mm)	hoogte (H mm)	75/65/20 (Watt) (Φ50K)	55/45/20 (Watt) (Φ30K)	n-exp.	gewicht (kg)	inhoud (l)	el. weerst. (Watt)	prijs S600* (€)	prijs kleur (€)	
REF. NR. VINTAGE 50 VINTAGE 50/D220 : 292																			
292	147	045	LR	YY	00	060	100	29	1478	450	2175	1149	1,25	58,00	35,67	-	978	1125	
		060						29	1478	600	2726	1432	1,26	75,98	42,92	-	1144	1316	
		100						29	1478	1000	4205	2187	1,28	132,24	70,18	-	1552	1785	
292	152	045	LR	YY	00	060	100	30	1528	450	2250	1188	1,25	60,00	36,90	-	997	1147	
		060						30	1528	600	2820	1482	1,26	78,60	44,40	-	1170	1346	
		100						30	1528	1000	4350	2262	1,28	136,80	72,60	-	1591	1830	
292	157	045	LR	YY	00	060	100	31	1578	450	2325	1228	1,25	62,00	38,13	-	1020	1173	
		060						31	1578	600	2914	1531	1,26	81,22	45,88	-	1199	1379	
292	162	045	LR	YY	00	060	100	32	1628	450	2400	1267	1,25	64,00	39,36	-	1044	1201	
		060						32	1628	600	3008	1580	1,26	83,84	47,36	-	1226	1410	
292	167	045	LR	YY	00	060	100	33	1678	450	2475	1307	1,25	66,00	40,59	-	1104	1270	
		060						33	1678	600	3102	1630	1,26	86,46	48,84	-	1292	1486	
292	172	045	LR	YY	00	060	100	34	1728	450	2550	1347	1,25	68,00	41,82	-	1125	1294	
		060						34	1728	600	3196	1679	1,26	89,08	50,32	-	1317	1515	
292	177	045	LR	YY	00	060	100	35	1778	450	2625	1386	1,25	70,00	43,05	-	1144	1316	
		060						35	1778	600	3290	1728	1,26	91,70	51,80	-	1347	1549	
292	182	045	LR	YY	00	060	100	36	1828	450	2700	1426	1,25	72,00	44,28	-	1170	1346	
		060						36	1828	600	3384	1778	1,26	94,32	53,28	-	1377	1584	
292	187	045	LR	YY	00	060	100	37	1878	450	2775	1465	1,25	74,00	45,51	-	1194	1373	
		060						37	1878	600	3478	1827	1,26	96,36	54,76	-	1406	1617	
292	192	045	LR	YY	00	060	100	38	1928	450	2850	1505	1,25	76,00	46,74	-	1213	1395	
		060						38	1928	600	3572	1877	1,26	99,56	56,24	-	1430	1645	
292	197	045	LR	YY	00	060	100	39	1978	450	2925	1545	1,25	78,00	47,97	-	1236	1421	
		060						39	1978	600	3666	1926	1,26	102,18	57,72	-	1457	1676	
292	202	045	LR	YY	00	060	100	40	2028	450	3000	1584	1,25	80,00	49,20	-	1256	1444	
		060						40	2028	600	3760	1975	1,26	104,80	59,20	-	1487	1710	
292	207	045	LR	YY	00	060	100	41	2078	450	3075	1624	1,25	82,00	50,43	-	1278	1470	
		060						41	2078	600	3854	2025	1,26	107,42	60,68	-	1511	1738	
292	212	045	LR	YY	00	060	100	42	2128	450	3150	1663	1,25	84,00	51,66	-	1298	1493	
		060						42	2128	600	3948	2074	1,26	110,04	62,16	-	1539	1770	
292	217	045	LR	YY	00	060	100	43	2178	450	3225	1703	1,25	86,00	52,89	-	1318	1516	
		060						43	2178	600	4042	2124	1,26	112,66	63,64	-	1565	1800	
292	222	045	LR	YY	00	060	100	44	2228	450	3300	1743	1,25	88,00	54,12	-	1342	1543	
		060						44	2228	600	4136	2173	1,26	115,28	65,12	-	1592	1831	

Conform EN442-1: 2014: radiatoren en convectoren

* RAL 9016: geen meerprijs 15%

Voor meer details over onze artikel-data, zie artikel-database: <https://www.installdata.be>

Voor de warmteafgiftes van andere regimes, kijkt u op p. 346 (correctiefactoren)
BELGIË. Prijzen in euro (excl. BTW)

HOE VINTAGE 50 BESTELLEN

Leveringstermijn 15 - 30 werkdagen
(zonder transportduur)

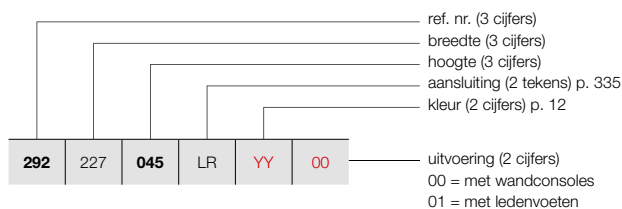

VINTAGE (VINTAGE 50 / D220)

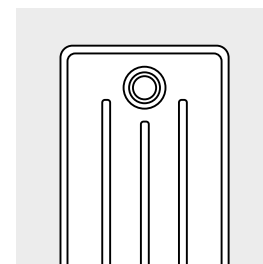

VINTAGE 50 / D220

PRIJSGROEP: VPG5 - KOLOMRADIATOREN

BESTELCODE MAATWERK VINTAGE 50	TECHNISCHE GEGEVENS							STANDAARDKLEUR	ANDERE KLEUREN							
	buizen	breedte (L mm)	hoogte (H mm)	75/65/20 (Watt) (Φ50K)	55/45/20 (Watt) (Φ30K)	n-exp.	gewicht (kg)			inhoud (l)	el. weerst. (Watt)	prijs S600* (€)	prijs kleur (€)			
REF. NR. VINTAGE 50 VINTAGE 50/D220 : 292																
292	227	045	LR	YY	00											
		060														
						45	2278	450	3375	1782	1,25	90,00	55,35	-	1360	1564
						45	2278	600	4230	2222	1,26	117,90	66,60	-	1619	1862
292	232	045	LR	YY	00											
		060														
						46	2328	450	3450	1822	1,25	93,84	56,58	-	1386	1594
						46	2328	600	4324	2272	1,26	120,52	68,08	-	1646	1893
292	237	045	LR	YY	00											
		060														
						47	2378	450	3525	1861	1,25	94,00	57,81	-	1406	1617
						47	2378	600	4418	2321	1,26	123,14	69,56	-	1673	1924
292	242	045	LR	YY	00											
		060														
						48	2428	450	3600	1901	1,25	96,00	59,04	-	1427	1641
						48	2428	600	4512	2370	1,26	125,76	71,04	-	1700	1955
292	247	045	LR	YY	00											
		060														
						49	2478	450	3675	1941	1,25	99,96	60,27	-	1446	1663
						49	2478	600	4606	2420	1,26	128,38	72,52	-	1724	1983
292	252	045	LR	YY	00											
		060														
						50	2528	450	3750	1980	1,25	102,00	61,50	-	1468	1688
						50	2528	600	4700	2469	1,26	131,00	74,00	-	1755	2018
292	257	045	LR	YY	00											
		060														
						51	2578	450	3825	2020	1,25	104,04	62,73	-	1506	1732
292	262	045	LR	YY	00											
		060														
						52	2628	450	3900	2059	1,25	106,08	63,96	-	1526	1755
292	267	045	LR	YY	00											
		060														
						53	2678	450	3975	2099	1,25	108,12	65,19	-	1547	1779
292	272	045	LR	YY	00											
		060														
						54	2728	450	4050	2139	1,25	110,16	66,42	-	1569	1804
292	277	045	LR	YY	00											
		060														
						55	2778	450	4125	2178	1,25	112,20	67,65	-	1590	1829
292	282	045	LR	YY	00											
		060														
						56	2828	450	4200	2218	1,25	114,24	68,88	-	1609	1850
292	287	045	LR	YY	00											
		060														
						57	2878	450	4275	2257	1,25	116,28	70,11	-	1634	1879
292	292	045	LR	YY	00											
		060														
						58	2928	450	4350	2297	1,25	118,32	71,34	-	1653	1901
292	297	045	LR	YY	00											
		060														
						59	2978	450	4425	2337	1,25	120,36	72,57	-	1675	1926
292	302	045	LR	YY	00											
		060														
						60	3028	450	4500	2376	1,25	122,40	73,80	-	1697	1952

Conform EN442-1: 2014: radiatoren en convectoren

* RAL 9016: geen meerprijs 15%

Voor meer details over onze artikel-data, zie artikel-database: <https://www.installdata.be>

Voor de warmteafgiftes van andere regimes, kijkt u op p. 346 (correctiefactoren)

BELGIË. Prijzen in euro (excl. BTW)

VINTAGE (VINTAGE 50 / D250)

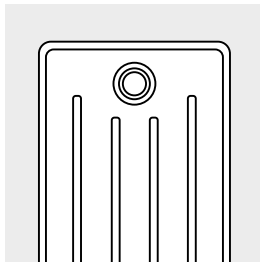

VINTAGE 50 / D250

HOE VINTAGE 50 BESTELLEN
Leveringstermijn 15 - 30 werkdagen
(zonder transportduur)

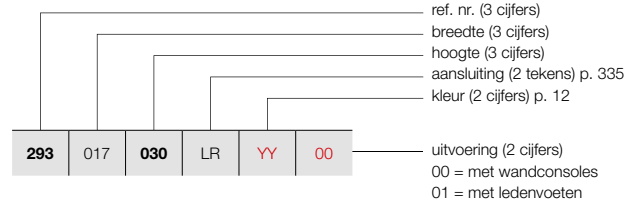

PRIJSGROEP: VPG5 - KOLOMRADIATOREN

BESTELCODE MAATWERK VINTAGE 50	TECHNISCHE GEGEVENS										STANDAARDKLEUR	ANDERE KLEUREN
	buizen	breedte (L mm)	hoogte (H mm)	75/65/20 (Watt) (Φ50K)	55/45/20 (Watt) (Φ30K)	n-exp.	gewicht (kg)	inhoud (l)	el. weerst. (Watt)	prijs S600* (€)	prijs kleur (€)	
REF. NR. VINTAGE 50 VINTAGE 50/D250 : 293												
293 017 030 LR YY 00	3	178	300	186	98	1,26	4,56	2,97	-	392	451	
293 022 030 LR YY 00	4	228	300	248	130	1,26	6,08	3,96	-	413	475	
293 027 030 LR YY 00	5	278	300	310	163	1,26	7,60	4,95	-	434	499	
293 032 030 LR YY 00	6	328	300	372	195	1,26	9,12	5,94	-	455	523	
293 037 030 LR YY 00	7	378	300	434	228	1,26	10,64	6,93	-	474	545	
293 042 030 LR YY 00	8	428	300	496	261	1,26	12,16	7,92	-	504	580	
293 047 030 LR YY 00	9	478	300	558	293	1,26	13,68	8,91	-	522	600	
293 052 030 LR YY 00	10	528	300	620	326	1,26	15,20	9,90	-	541	622	
293 057 030 LR YY 00	11	578	300	682	358	1,26	16,72	10,89	-	570	656	
293 062 030 LR YY 00	12	628	300	744	391	1,26	18,34	11,88	-	592	681	
293 067 030 LR YY 00	13	678	300	806	423	1,26	19,76	12,87	-	610	702	
293 072 030 LR YY 00	14	728	300	868	456	1,26	21,28	13,86	-	629	723	
293 077 030 LR YY 00	15	778	300	930	489	1,26	22,80	14,85	-	653	751	
293 082 030 LR YY 00	16	828	300	992	521	1,26	24,32	15,84	-	671	772	
293 087 030 LR YY 00	17	878	300	1054	554	1,26	25,84	16,83	-	691	795	
293 092 030 LR YY 00	18	928	300	1116	586	1,26	27,36	17,82	-	714	821	
293 097 030 LR YY 00	19	978	300	1178	619	1,26	28,88	18,81	-	733	843	
293 102 030 LR YY 00	20	1028	300	1240	651	1,26	30,40	19,80	-	753	866	
293 107 030 LR YY 00	21	1078	300	1302	684	1,26	31,92	20,79	-	787	905	
293 112 030 LR YY 00	22	1128	300	1364	717	1,26	33,44	21,78	-	805	926	
293 117 030 LR YY 00	23	1178	300	1426	749	1,26	34,96	22,77	-	831	956	
293 122 030 LR YY 00	24	1228	300	1488	782	1,26	36,68	23,76	-	847	974	
293 127 030 LR YY 00	25	1278	300	1550	814	1,26	38,00	24,75	-	870	1001	
293 132 030 LR YY 00	26	1328	300	1612	847	1,26	39,52	25,74	-	909	1045	
293 137 030 LR YY 00	27	1378	300	1674	879	1,26	41,04	26,73	-	931	1071	
293 142 030 LR YY 00	28	1428	300	1736	912	1,26	42,56	27,72	-	951	1094	
293 147 030 LR YY 00	29	1478	300	1798	945	1,26	44,08	28,71	-	972	1118	

Conform EN442-1: 2014: radiatoren en convectoren

* RAL 9016: geen meerprijs 15%
Voor meer details over onze artikel-data, zie artikel-database: <https://www.installdata.be>
Voor de warmteafgiftes van andere regimes, kijkt u op p. 346 (correctiefactoren)
BELGIË. Prijzen in euro (excl. BTW)

HOE VINTAGE 50 BESTELLEN

Leveringstermijn 15 - 30 werkdagen
(zonder transportduur)

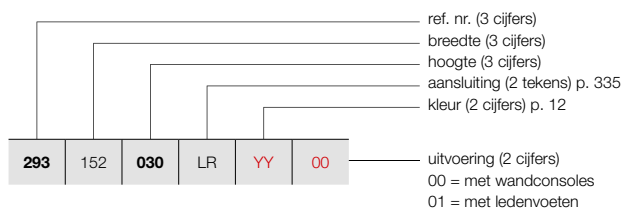

VINTAGE (VINTAGE 50 / D250)

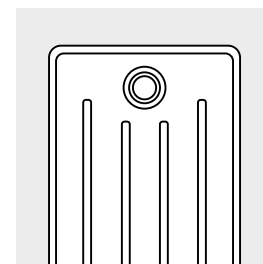

VINTAGE 50 / D250

PRIJSGROEP: VPG5 - KOLOMRADIATOREN

BESTELCODE MAATWERK VINTAGE 50	TECHNISCHE GEGEVENS										STANDAARDKLEUR	ANDERE KLEUREN				
	buizen	breedte (L mm)	hoogte (H mm)	75/65/20 (Watt) (φ50K)	55/45/20 (Watt) (φ30K)	n-exp.	gewicht (kg)	inhoud (l)	el. weerst. (Watt)	prijs S600* (€)			prijs kleur (€)			
REF. NR. VINTAGE 50 VINTAGE 50/D250 : 293																
293	152	030	LR	YY	00	30	1528	300	1860	977	1,26	45,60	29,70	-	990	1139
293	157	030	LR	YY	00	31	1578	300	1922	1010	1,26	47,12	30,69	-	1013	1165
293	162	030	LR	YY	00	32	1628	300	1984	1042	1,26	48,64	31,68	-	1034	1189
293	167	030	LR	YY	00	33	1678	300	2046	1075	1,26	50,16	32,67	-	1092	1256
293	172	030	LR	YY	00	34	1728	300	2108	1107	1,26	51,68	33,66	-	1115	1282
293	177	030	LR	YY	00	35	1778	300	2170	1140	1,26	53,20	34,65	-	1132	1302
293	182	030	LR	YY	00	36	1828	300	2232	1173	1,26	55,02	35,64	-	1161	1335
293	187	030	LR	YY	00	37	1878	300	2294	1205	1,26	56,24	36,63	-	1180	1357
293	192	030	LR	YY	00	38	1928	300	2356	1238	1,26	57,76	37,62	-	1200	1380
293	197	030	LR	YY	00	39	1978	300	2418	1270	1,26	59,28	38,61	-	1218	1401
293	202	030	LR	YY	00	40	2028	300	2480	1303	1,26	60,80	39,60	-	1242	1428
293	207	030	LR	YY	00	41	2078	300	2542	1336	1,26	62,32	40,59	-	1263	1452
293	212	030	LR	YY	00	42	2128	300	2604	1368	1,26	63,84	41,58	-	1281	1473
293	217	030	LR	YY	00	43	2178	300	2666	1401	1,26	65,36	42,57	-	1305	1501
293	222	030	LR	YY	00	44	2228	300	2728	1433	1,26	66,88	43,56	-	1320	1518
293	227	030	LR	YY	00	45	2278	300	2790	1466	1,26	68,40	44,55	-	1346	1548
293	232	030	LR	YY	00	46	2328	300	2852	1498	1,26	69,92	45,54	-	1361	1565
293	237	030	LR	YY	00	47	2378	300	2914	1531	1,26	71,44	46,53	-	1386	1594
293	242	030	LR	YY	00	48	2428	300	2976	1564	1,26	73,36	47,52	-	1406	1617
293	247	030	LR	YY	00	49	2478	300	3038	1596	1,26	74,48	48,51	-	1425	1639
293	252	030	LR	YY	00	50	2528	300	3100	1629	1,26	76,00	49,50	-	1446	1663
293	257	030	LR	YY	00	51	2578	300	3162	1661	1,26	77,52	50,49	-	1488	1711
293	262	030	LR	YY	00	52	2628	300	3224	1694	1,26	79,04	51,48	-	1508	1734
293	267	030	LR	YY	00	53	2678	300	3286	1726	1,26	80,56	52,47	-	1527	1756
293	272	030	LR	YY	00	54	2728	300	3348	1759	1,26	82,08	53,46	-	1547	1779
293	277	030	LR	YY	00	55	2778	300	3410	1792	1,26	83,60	54,45	-	1569	1804
293	282	030	LR	YY	00	56	2828	300	3472	1824	1,26	85,12	55,44	-	1588	1826

Conform EN442-1: 2014: radiatoren en convectoren

* RAL 9016: geen meerprijs 15%
Voor meer details over onze artikel-data, zie artikel-database: <https://www.installdata.be>
Voor de warmteafgiftes van andere regimes, kijkt u op p. 346 (correctiefactoren)
BELGIË. Prijzen in euro (excl. BTW)

VINTAGE (VINTAGE 50 / D250)

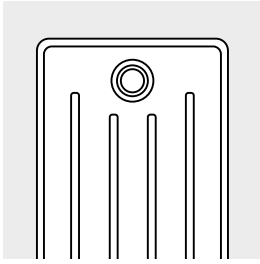

VINTAGE 50 / D250

HOE VINTAGE 50 BESTELLEN

Leveringstermijn 15 - 30 werkdagen
(zonder transportduur)

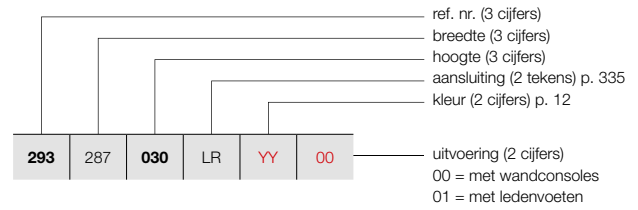

PRIJSGROEP: VPG5 - KOLOMRADIATOREN

BESTELCODE MAATWERK VINTAGE 50	TECHNISCHE GEGEVENS										STANDAARDKLEUR	ANDERE KLEUREN
	buizen	breedte (L mm)	hoogte (H mm)	75/65/20 (Watt) (Φ50K)	55/45/20 (Watt) (Φ30K)	n-exp.	gewicht (kg)	inhoud (l)	el. weerst. (Watt)	prijs S600* (€)	prijs kleur (€)	
REF. NR. VINTAGE 50 VINTAGE 50/D250 : 293												
293 287 030 LR YY 00	57	2878	300	3534	1857	1,26	86,64	56,43	-	1609	1850	
293 292 030 LR YY 00	58	2928	300	3596	1889	1,26	88,16	57,42	-	1630	1875	
293 297 030 LR YY 00	59	2978	300	3658	1922	1,26	89,68	58,41	-	1651	1899	
293 302 030 LR YY 00	60	3028	300	3720	1954	1,26	91,70	59,40	-	1672	1923	



Conform EN442-1: 2014: radiatoren en convectoren

* RAL 9016: geen meerprijs 15%

Voor meer details over onze artikel-data, zie artikel-database: <https://www.installdata.be>

Voor de warmteafgifte van andere regimes, kijkt u op p. 346 (correctiefactoren)
BELGIË. Prijzen in euro (excl. BTW)

PRIJSGROEP: VPG10 - ACC.

BEVESTIGINGEN		VINTAGE 50	KLEUR
WANDBEVESTIGING			in de kleur van de radiator*
LEDENVOETEN		<p>VINTAGE 50</p> <p>2 voeten voor 25 leden</p> <p>3 voeten voor 50 leden</p> <p>4 voeten voor 60 leden</p>	<p>in de kleur van de radiator*</p> <p>in de kleur van de radiator*</p> <p>in de kleur van de radiator*</p>

* Voeten en bevestigingen voor radiatoren in transparante coating zijn gelakt in de kleur N507.

VINTAGE AANSLUITINGEN

VINTAGE: VINTAGE 50

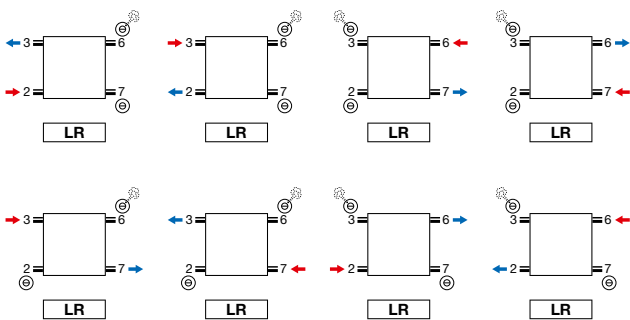

- Ontluchter in aansluiting 3 of 6.

VINTAGE: VINTAGE 50

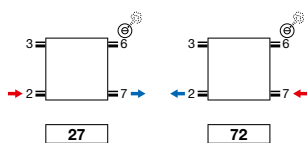

- Ontluchter in aansluiting 3 of 6.
- Aansluitingen op speciale aanvraag: meerprijs €69

Opmerking: het aansluiten van de radiator kan enkel volgens de getoonde aansluiticonen. Voor elke andere aansluitwijze nemen wij geen verantwoordelijkheid.

VINTAGE (VINTAGE 50)

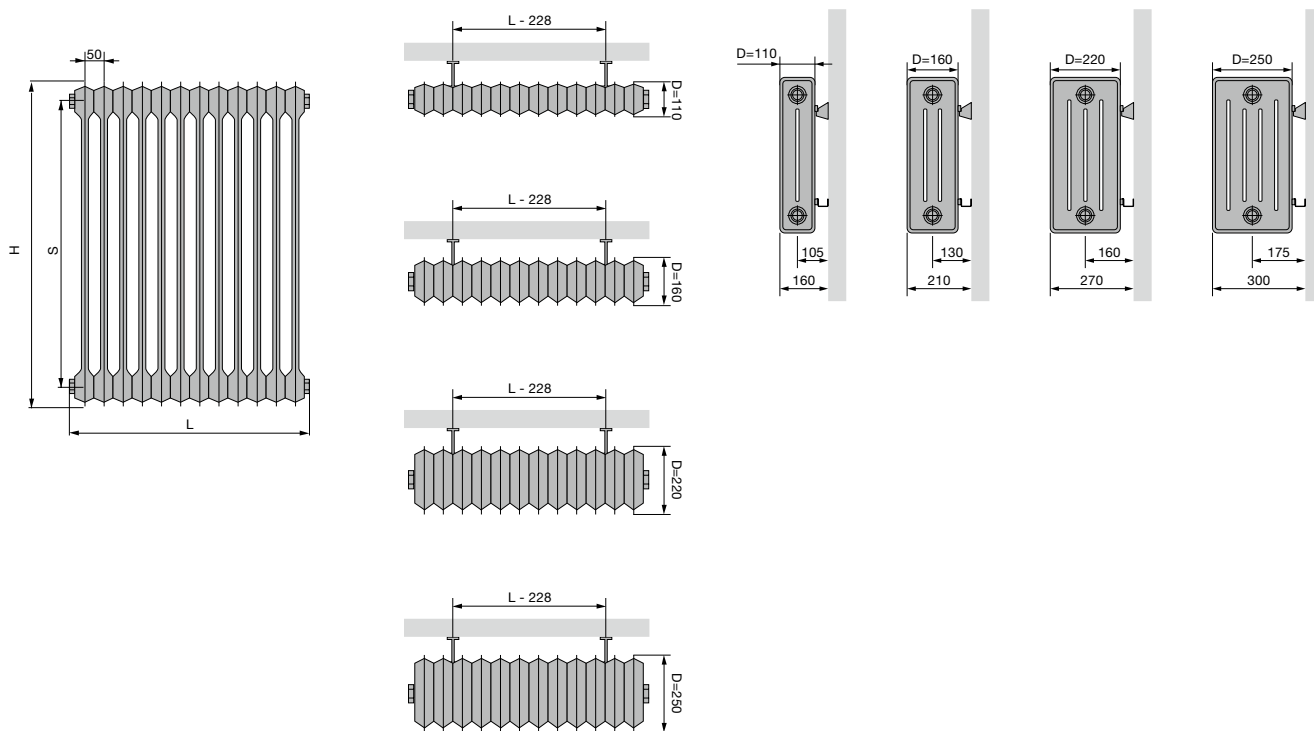

VINTAGE 50

hoogte (H)	300	450	600	1000
Hartafstand tussen de zijaansluitingen (S)	200	350	500	900

VINTAGE (VINTAGE 50)

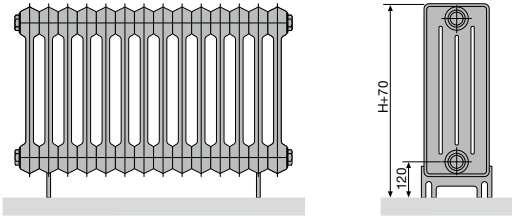

VINTAGE 50 (VLOERMONTAGE)

Aantal leden	2-25	26-50	51-60
Aantal voeten	2	3	4

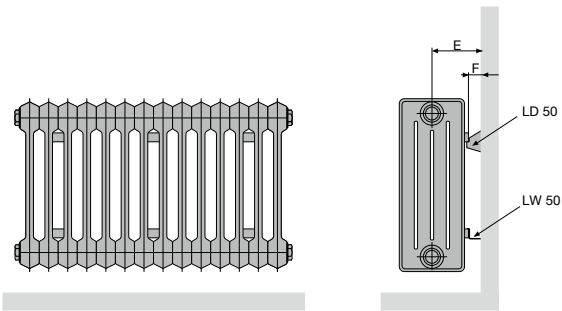

VINTAGE 50 (WANDMONTAGE) LD 50 + LW 50

Diepte (D)	110	160	220	250
Afstand tussen wand en aansluiting (E)	105	130	160	175
Afstand tussen wand en achterkant radiator (F)	50			

VINTAGE 50 (WANDMONTAGE)

Aantal leden	3-5	6-25	26-50	51-60
Aantal muurbevestigingen set LD 50 + LW 50	1	2	3	4

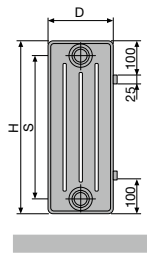

VINTAGE 50

hoogte (H)	300	450	600	1000
Hartafstand tussen de zijaansluitingen (S)	200	350	500	900

