





Staal designradiatoren

De kracht van staal, de finesse van design.

VASCO staal designradiatoren combineren eigentijds warmtecomfort met een doordachte, tijdloze vormgeving.

Elke collectie is een verfijnde balans tussen efficiëntie en esthetiek, ontworpen op maat van elke woonruimte en geschikt voor uiteenlopende toepassingen.

Het samenspel van ervaren technici, innovatieve ontwerpers en wetenschappelijke specialisten resulteert in radiatoren waarin elk detail telt.

Stuk voor stuk meesterwerken van technisch vernuft en creativiteit, bekroond met internationale designprijzen en herkenbaar aan hun zuivere vormgeving en optimaal gebruiksgemak.

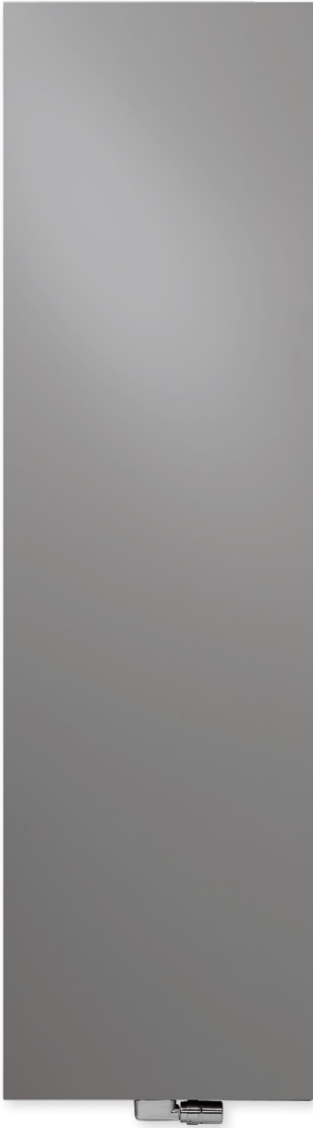

TYPES

- Enkel (N1L1) en dubbel (N2L1)

KLEUREN

- Standaardkleur S600 (witte fijn structuurlak) (RAL 9016: geen meerprijs 15%)
- Uitgebreide kleurenkaart zie p. 12

SPECIAAL

- De Niva Lak Verticaal is beschikbaar met een gelakte voorplaat (dwz. plaatradiator + gelakte voorplaat).

BEVESTIGINGEN

- Muurbevestigingen in de kleur RAL 7016 (antraciet grijs) standaard. Ook in optie verkrijgbaar in de kleur S600 (zie p. 181).

TECHNISCH

- Elektrisch weerstandsgelast (onzichtbare lasnaden) en rolnaadgelast
- KTL-grondlaag, poedercoating
- Standaardwerkdruk: 10 bar
- Maximale bedrijfstemperatuur: 110°C

ELEKTRISCH (beschikbare uitvoeringen: zie hoofdstuk elektrische radiatoren)

- ✓ Zuiver elektrische radiator (zie p. 80)
- ✓ Gemengde radiator (zie p. 116)

TECHNISCHE TEKENINGEN

- Zie p. 185

AANSLUITING

- ✗ Eénpuntsaansluiting voor éénpijpssysteem
- ✗ Eénpuntsaansluiting voor tweepijpssysteem
- ✓ Tweepuntsaansluiting voor éénpijpssysteem (aansluiting via de middenaansluiting) (zie p. 362)
- ✓ Tweepuntsaansluiting voor tweepijpssysteem (standaard) (zie p. 362)
- ✗ Geïntegreerd ventiel
- Aansluitingen: 1/2" (binnendraad)

NIVA LAK VERTICAAL

Puur technische klasse, puur design, puur sfeer

De ultracompacte, gestyleerde Niva is nog steeds een stichtend voorbeeld voor heel wat ontwerpers en collega-producenten. Eén en al functionaliteit door de optimale luchtdoorstroming en de extra hoge warmteafgifte die meteen op gang komt. Eén en al design door de integere, zuivere vormgeving, het zwevend karakter –dankzij de achterliggende, onzichtbare ophanging- en de organisch geïntegreerde handdoekbeugel.

AANBEVOLEN AANSLUITING (LB)

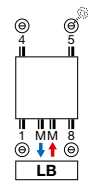

Andere aansluitmogelijkheden, zie p. 184



art. nr. 1182 103 0000 0099

prijs €190

Koppelingen, zie p. 377

AANBEVOLEN VOOR BADKAMER EN KEUKEN IN OPTIE



handdoekbeugel (chrom) N1L1 art. nr. zie p. 182

prijs €200

N2L1 art. nr. zie p. 182

prijs €200

Andere accessoires, zie p. 182



HOE NIVA LAK VERTICAAL BESTELLEN

Leveringstermijn 15 - 30 werkdagen
(zonder transportduur)

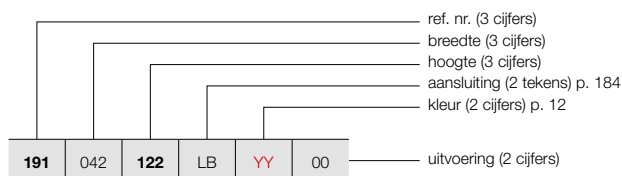

NIVA LAK VERTICAAL (N1L1, N2L1)

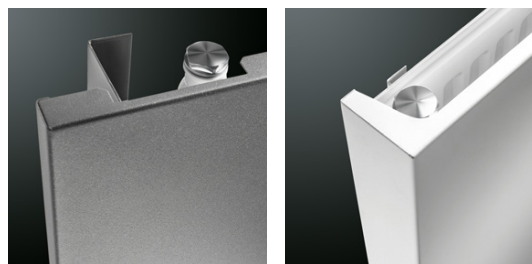

N1L1

N2L1

HOE VOORRAADRADIATOR NIVA LAK VERTICAAL BESTELLEN

Leveringstermijn 5 werkdagen
(zonder transportduur)

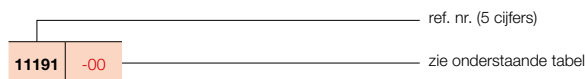

PRIJSGROEP: VPG2 - STAAL DESIGNRADIATOREN

BESTELCODE MAATWERK NIVA LAK VERTICAAL	TECHNISCHE GEGEVENS									STANDAARDKLEUR		ANDERE KLEUREN	
	buizen	breedte (L mm)	hoogte (H mm)	75/65/20 (Watt) (Φ50K)	55/45/20 (Watt) (Φ30K)	n-exp.	gewicht (kg)	inhoud (l)	el. weerst. (Watt)	prijs S600* (€)	verkorte ref. nr. S600 voorraad	prijs kleur (€)	verkorte ref. nr. M301 voorraad
REF. NR. NIVA LAK VERTICAAL N1L1 : 191													
191 042 122 LB YY 00	-	420	1220	645	337	1,27	18,10	2,55	-	553	11191-02	636	-
	-	420	1820	934	486	1,28	27,35	3,70	-	643	11191-03	739	11191-05
	-	420	2020	1023	532	1,28	30,20	4,00	-	677	11191-06	779	-
	-	420	2220	1070	559	1,27	33,20	4,50	-	732	-	842	-
191 052 122 LB YY 00	-	520	1220	815	424	1,28	21,97	3,32	-	623	11191-21	716	-
	-	520	1820	1128	587	1,28	33,67	4,61	-	722	11191-16	830	11191-01
	-	520	2020	1257	654	1,28	37,12	5,05	-	763	11191-22	877	-
	-	520	2220	1310	681	1,28	40,88	5,57	-	825	-	949	-
191 062 122 LB YY 00	-	620	1220	985	510	1,29	25,83	3,85	-	648	11191-07	745	-
	-	620	1820	1322	687	1,28	39,98	5,52	-	753	11191-17	866	11191-04
	-	620	2020	1490	775	1,28	44,03	6,10	-	798	11191-20	918	-
	-	620	2220	1550	806	1,28	48,57	6,63	-	864	-	994	-
191 072 182 LB YY 00	-	720	1820	1515	784	1,29	46,30	6,43	-	781	11191-08	898	-
	-	720	2020	1724	897	1,28	50,95	7,15	-	831	11191-09	956	-
	-	720	2220	1790	926	1,29	56,25	7,70	-	904	-	1040	-
REF. NR. NIVA LAK VERTICAAL N2L1 : 192													
192 042 122 LB YY 00	-	420	1220	988	506	1,31	26,50	4,90	-	828	-	952	-
	-	420	1820	1330	681	1,31	42,23	7,28	-	961	11192-02	1105	-
	-	420	2020	1438	736	1,31	46,75	8,00	-	997	11192-04	1147	-
	-	420	2220	1543	823	1,23	51,40	8,90	-	1054	-	1212	-
192 052 122 LB YY 00	-	520	1220	1213	621	1,31	33,00	6,48	-	929	11192-05	1068	-
	-	520	1820	1633	836	1,31	51,68	9,07	-	1082	11192-31	1244	-
	-	520	2020	1764	903	1,31	57,23	10,00	-	1121	11192-32	1289	-
	-	520	2220	1893	995	1,26	62,73	11,00	-	1187	-	1365	-
192 062 122 LB YY 00	-	620	1220	1437	732	1,32	39,50	7,02	-	968	11192-37	1113	-
	-	620	1820	1935	991	1,31	61,14	10,86	-	1127	11192-33	1296	-
	-	620	2020	2091	1071	1,31	67,72	12,00	-	1168	11192-34	1343	-
	-	620	2220	2243	1160	1,29	74,07	13,10	-	1243	11192-39	1429	-
192 072 182 LB YY 00	-	720	1820	2237	1146	1,31	70,60	12,65	-	1167	11192-07	1342	-
	-	720	2020	2417	1238	1,31	78,20	14,00	-	1223	11192-35	1406	-
	-	720	2220	2594	1322	1,32	85,40	15,20	-	1302	11192-36	1497	-

Conform EN442-1: 2014: radiatoren en convectoren

* RAL 9016: geen meerprijs 15%

Voor meer details over onze artikel-data, zie artikel-database: <https://www.installdata.be>

Voor de warmteafgiftes van andere regimes, kijkt u op p. 370 (correctiefactoren)

BELGIË. Prijzen in euro (excl. BTW)



TYPES

- Enkel (N1L1-ES) en dubbel (N2L1-ES)

KLEUREN

- Inox / RVS type 316L, mat geborsteld met korrel 360

SPECIAAL

- De Niva Inox Verticaal is beschikbaar met een inox voorplaat (dwz. stalen plaatradiator + inox-voorplaat).
- De Niva Inox Verticaal is te reinigen met een inox cleaner.

BEVESTIGINGEN

- Muurbevestigingen in de kleur RAL 7016 (antraciet grijs) standaard. Ook in optie verkrijgbaar in de kleur S600 (zie p. 181).

TECHNISCH

- Elektrisch weerstandsgelast (onzichtbare lasnaden) en rolnaadgelast
- Standaardwerkdruk: 10 bar
- Maximale bedrijfstemperatuur: 110°C

ELEKTRISCH

- ✗ Zuiver elektrische radiator
- ✗ Gemengde radiator

TECHNISCHE TEKENINGEN

- Zie p. 185

AANSLUITING

- ✗ Eénpuntsaansluiting voor éénpijpsysteem
- ✗ Eénpuntsaansluiting voor tweepijpsysteem
- ✓ Tweepuntsaansluiting voor éénpijpsysteem (aansluiting via de middenaansluiting) (zie p. 362)
- ✓ Tweepuntsaansluiting voor tweepijpsysteem (standaard) (zie p. 362)
- ✗ Geïntegreerd ventiel
- Aansluitingen: ½" (binnendraad)

NIVA INOX VERTICAAL

Pure klasse in al haar pracht

De Niva Inox Verticaal combineert een stalen plaatradiator met een inox voorplaat, die de integere, zuivere vormgeving en het zwevende karakter van de Niva letterlijk 'extra glans' geeft. De Niva Inox Verticaal designradiator is ook leverbaar met organisch geïntegreerde inox handdoekbeugel (in optie).

AANBEVOLEN AANSLUITING (LB)

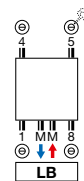

Andere aansluitmogelijkheden, zie p. 184

AANBEVOLEN VOOR BADKAMER EN KEUKEN IN OPTIE



handdoekbeugel (chrom) N1L1 art. nr. zie p. 182

prijs €200

N2L1 art. nr. zie p. 182

prijs €200

Andere accessoires, zie p. 182



HOE NIVA INOX VERTICAAL BESTELLEN

Leveringstermijn 15 - 30 werkdagen
(zonder transportduur)

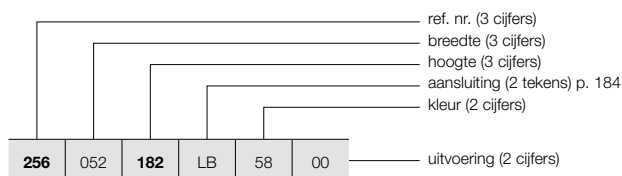

NIVA INOX VERTICAAL (N1L1-ES, N2L1-ES)

175

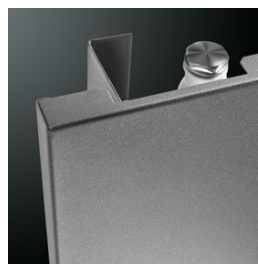

N1L1-ES

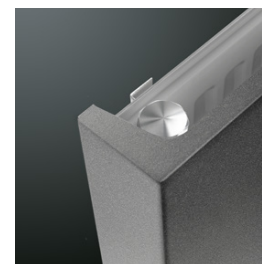

N2L1-ES

PRIJSGROEP: VPG2 - STAAL DESIGNRADIATOREN

BESTELCODE MAATWERK NIVA INOX VERTICAAL	TECHNISCHE GEGEVENS									STANDAARDKLEUR					
	buizen	breedte (L mm)	hoogte (H mm)	75/65/20 (Watt) (Φ50K)	55/45/20 (Watt) (Φ30K)	n-exp.	gewicht (kg)	inhoud (l)	el. weerst. (Watt)	prijs inox (€)					
REF. NR. NIVA INOX VERTICAAL N1L1-ES : 256															
256	052	182	LB	58	00	-	520	1820	1128	587	1,28	33,67	4,61	-	1334
		202				-	520	2020	1257	654	1,28	37,12	5,05	-	1415
256	062	182	LB	58	00	-	620	1820	1322	687	1,28	39,98	5,52	-	1392
		202				-	620	2020	1490	775	1,28	44,03	6,10	-	1477
REF. NR. NIVA INOX VERTICAAL N2L1-ES : 257															
257	052	182	LB	58	00	-	520	1820	1633	836	1,31	51,68	9,07	-	2000
		202				-	520	2020	1764	903	1,31	57,23	10,00	-	2072
257	062	182	LB	58	00	-	620	1820	1935	991	1,31	61,14	10,86	-	2084
		202				-	620	2020	2091	1071	1,31	67,72	12,00	-	2162

Conform EN442-1: 2014: radiatoren en convectoren

Voor meer details over onze artikel-data, zie artikel-database: <https://www.installdata.be>

Voor de warmteafgiftes van andere regimes, kijkt u op p. 370 (correctiefactoren)
BELGIË. Prijzen in euro (excl. BTW)

NIVA LAK HORIZONTAAL (NH1L1, NH2L1, NH2L2)



GEÏNTEGREERD VENTIEL

NIVA LAK HORIZONTAAL

- Radiator in wit: thermostaatkop in wit standaard, in de prijs inbegrepen
- Radiator in kleur: thermostaatkop in chroom standaard, in de prijs inbegrepen



TYPES

- NH1L1, NH2L1, NH2L2

KLEUREN

- Standaardkleur S600 (witte fijn structuurlak) (RAL 9016: geen meerprijs 15%)
- Uitgebreide kleurenkaart zie p. 12

SPECIAAL

- De Niva Lak Horizontaal is verkrijgbaar met 1 (NH1L1, NH2L1) of 2 rijen (NH2L2) lamellen ter verhoging van de warmteafgifte.
- NH1L1 ook verkrijgbaar als toiletradiator (520 x 450 mm)

BEVESTIGINGEN

- Muurbevestigingen in de kleur RAL 7016 (antraciet grijs) standaard. Ook in optie verkrijgbaar in de kleur S600 (zie p. 181).

TECHNISCH

- Elektrisch weerstandsgelast (onzichtbare lasnaden) en rolnaadgelast
- KTL-grondlaag, poedercoating
- Standaardwerkdruk: 10 bar
- Maximale bedrijfstemperatuur: 110°C

ELEKTRISCH

- ✗ Zuiver elektrische radiator
- ✗ Gemengde radiator

TECHNISCHE TEKENINGEN

- Zie p. 186

AANSLUITING

- ✗ Eénpuntsaansluiting voor éénpijpsysteem
- ✗ Eénpuntsaansluiting voor tweepijpsysteem
- ✓ Tweepuntsaansluiting voor éénpijpsysteem (aansluiting via het geïntegreerd ventiel) (zie p. 363)
- ✓ Tweepuntsaansluiting voor tweepijpsysteem (standaard) (zie p. 362)
- ✓ Geïntegreerd ventiel (**geen meerprijs**) (zie p. 363)
- Aansluitingen: 4x½" zijdelings (binnendraad), 2x¾" Euroconus (50mm rechtsonder)

NIVA LAK HORIZONTAAL

Pure klasse in al haar eenvoud

Ook in de horizontale versie is en blijft de Niva een toonbeeld van efficiënte toegepaste vormgeving. Een geslaagde combinatie van functionaliteit en design, met de keuze uit 1 of 2 lamellen voor een aangepaste warmteafgifte, ook beschikbaar in toiletversie. Met optionele handdoekbeugel in chroomuitvoering.

AANBEVOLEN AANSLUITING (VR) GEÏNTEGREERD VENTIEL

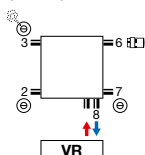

Andere aansluitmogelijkheden, zie p. 184



art. nr. 1182 300 0000 0099

prijs €157

Koppelingen, zie p. 377

AANBEVOLEN VOOR BADKAMER EN KEUKEN IN OPTIE



handdoekbeugel (chroom)

art. nr. zie p. 182

prijs €200



HOE NIVA LAK HORIZONTAAL BESTELLEN

Leveringstermijn 15 - 30 werkdagen
(zonder transportduur)

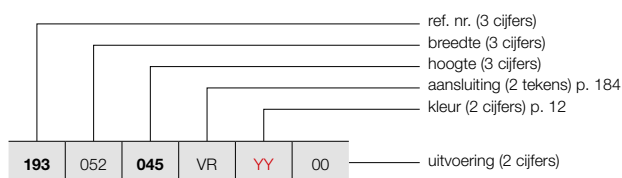

HOE VOORRAADRADIATOR NIVA LAK HORIZONTAAL BESTELLEN

Leveringstermijn 5 werkdagen
(zonder transportduur)

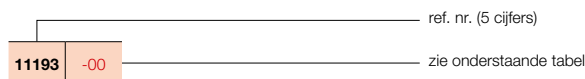

NIVA LAK HORIZONTAAL (NH1L1, NH2L1, NH2L2)



NH1L1 / NH2L1

PRIJSGROEP: VPG2 - STAAL DESIGNRADIATOREN

BESTELCODE MAATWERK NIVA LAK HORIZONTAAL	TECHNISCHE GEGEVENS								STANDAARDKLEUR		ANDERE KLEUREN						
	buizen	breedte (L mm)	hoogte (H mm)	75/65/20 (Watt) (Φ50K)	55/45/20 (Watt) (Φ30K)	n-exp.	gewicht (kg)	inhoud (l)	el. weerst. (Watt)	prijs S600* (€)		verkorte ref. nr. S600 voorraad	prijs kleur (€)				
REF. NR. NIVA LAK HORIZONTAAL NH1L1 : 193																	
193	052	045	VR	YY	00	-	520	450	301	158	1,26	7,50	1,19	-	505	11193-01	581
193	062	055	VR	YY	00	-	620	550	425	223	1,26	11,11	1,66	-	564	-	649
		065				-	620	650	490	256	1,27	13,28	1,92	-	633	-	728
193	082	055	VR	YY	00	-	820	550	562	295	1,26	14,69	2,20	-	656	-	754
		065				-	820	650	649	339	1,27	17,56	2,53	-	725	-	834
193	102	055	VR	YY	00	-	1020	550	699	367	1,26	18,28	2,73	-	751	-	864
		065				-	1020	650	807	422	1,27	21,85	3,15	-	819	-	942
		095				-	1020	950	1124	585	1,28	31,85	4,40	-	1009	-	1160
193	122	055	VR	YY	00	-	1220	550	836	439	1,26	21,86	3,27	-	840	-	966
		065				-	1220	650	965	504	1,27	26,13	3,77	-	912	-	1049
		095				-	1220	950	1344	699	1,28	38,10	5,26	-	1107	-	1273
REF. NR. NIVA LAK HORIZONTAAL NH2L1 : 194																	
194	062	055	VR	YY	00	-	620	550	611	318	1,28	17,25	3,27	-	736	-	846
		065				-	620	650	708	370	1,27	20,70	3,83	-	864	-	994
194	082	055	VR	YY	00	-	820	550	809	421	1,28	22,81	4,32	-	840	-	966
		065				-	820	650	936	489	1,27	27,37	5,07	-	968	-	1113
194	102	055	VR	YY	00	-	1020	550	1006	523	1,28	28,38	5,38	-	946	-	1088
		065				-	1020	650	1165	609	1,27	34,05	6,30	-	1071	11194-23	1232
		095				-	1020	950	1630	839	1,30	50,20	9,05	-	1288	-	1481
194	122	055	VR	YY	00	-	1220	550	1203	626	1,28	33,94	6,43	-	1048	-	1205
		065				-	1220	650	1393	728	1,27	40,72	7,54	-	1174	-	1350
		095				-	1220	950	1950	1004	1,30	60,05	10,82	-	1381	-	1588
194	142	055	VR	YY	00	-	1420	550	1400	728	1,28	39,50	7,48	-	1223	-	1406
		065				-	1420	650	1622	848	1,27	47,40	8,78	-	1367	-	1572
194	162	055	VR	YY	00	-	1620	550	1597	830	1,28	45,07	8,54	-	1392	-	1601
		065				-	1620	650	1850	967	1,27	54,08	10,01	-	1562	-	1796

Conform EN442-1: 2014: radiatoren en convectoren

* RAL 9016: geen meerprijs 15%

Voor meer details over onze artikel-data, zie artikel-database: <https://www.installdata.be>

Voor de warmteafgiftes van andere regimes, kijkt u op p. 370 (correctiefactoren)
BELGIË. Prijzen in euro (excl. BTW)

NIVA LAK HORIZONTAAL (NH2L2)



NH2L2

HOE NIVA LAK HORIZONTAAL BESTELLEN

Leveringstermijn 15 - 30 werkdagen
(zonder transportduur)

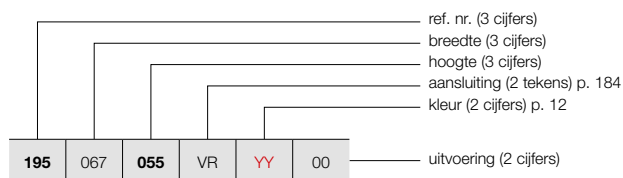

HOE VOORRAADRADIATOR NIVA LAK HORIZONTAAL BESTELLEN

Leveringstermijn 5 werkdagen
(zonder transportduur)

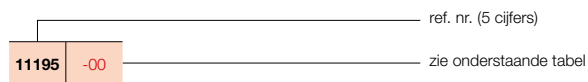

PRIJSGROEP: VPG2 - STAAL DESIGNRADIATOREN

BESTELCODE MAATWERK NIVA LAK HORIZONTAAL	TECHNISCHE GEGEVENS									STANDAARDKLEUR		ANDERE KLEUREN prijs kleur (€)					
	buizen	breedte (L mm)	hoogte (H mm)	75/65/20 (Watt Φ50K)	55/45/20 (Watt Φ30K)	n-exp.	gewicht (kg)	inhoud (l)	el. weerst. (Watt)	prijs S600* (€)	verkorte ref. nr. S600 voorraad						
REF. NR. NIVA LAK HORIZONTAAL NH2L2 : 195																	
195	067	055	VR	YY	00	-	678	550	804	416	1,29	20,50	3,40	-	921	-	1059
		065				-	678	650	941	487	1,29	24,28	3,93	-	1083	-	1245
195	087	055	VR	YY	00	-	878	550	1041	539	1,29	26,55	4,40	-	1061	-	1220
		065				-	878	650	1219	631	1,29	31,44	5,09	-	1225	-	1409
195	107	055	VR	YY	00	-	1078	550	1279	662	1,29	32,60	5,40	-	1198	-	1378
		065				-	1078	650	1496	774	1,29	38,60	6,25	-	1361	11195-16	1565
		095				-	1078	950	2027	1043	1,30	57,90	9,00	-	1611	-	1853
195	127	055	VR	YY	00	-	1278	550	1516	784	1,29	38,65	6,40	-	1334	-	1534
		065				-	1278	650	1774	918	1,29	45,77	7,41	-	1494	-	1718
		095				-	1278	950	2403	1237	1,30	68,64	10,67	-	1748	-	2010
195	147	055	VR	YY	00	-	1478	550	1753	907	1,29	44,69	7,40	-	1546	-	1778
		065				-	1478	650	2051	1061	1,29	52,93	8,57	-	1731	-	1991
195	167	055	VR	YY	00	-	1678	550	1990	1030	1,29	50,74	8,41	-	1756	-	2019
		065				-	1678	650	2329	1205	1,29	60,09	9,73	-	1966	-	2261

Conform EN442-1: 2014: radiatoren en convectoren

* RAL 9016: geen meerprijs 15%
Voor meer details over onze artikel-data, zie artikel-database: <https://www.installdata.be>
Voor de warmteafgiftes van andere regimes, kijkt u op p. 370 (correctiefactoren)
BELGIË. Prijzen in euro (excl. BTW)

TYPES

- Enkel (NS1L1) en dubbel (NS2L1)

KLEUREN

- Standaardkleur S600 (witte fijn structuurlak) (RAL 9016: geen meerprijs 15%)
- Uitgebreide kleurenkaart zie p. 12

SPECIAAL

- De Niva Soft Verticaal is beschikbaar met een gelakte voorplaat (dwz. stalen plaatradiator + gelakte voorplaat).
- Vlakke voorplaat en afgeronde zijkanalen als hedendaagse troef
- Thermostaatkop op deurknophoogte in optie (niet bij NS1L1) (zie p. 363).

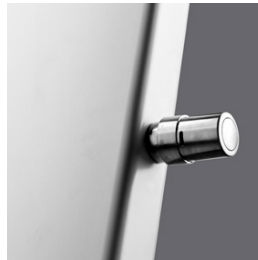

BEVESTIGINGEN

- Muurbevestigingen in de kleur RAL 7016 (antraciet grijs) standaard. Ook in optie verkrijgbaar in de kleur S600 (zie p. 181).

TECHNISCH

- Elektrisch weerstandsgelast (onzichtbare lasnaden) en rolnaadgelast
- KTL-grondlaag, poedercoating
- Standaardwerkdruk: 10 bar
- Maximale bedrijfstemperatuur: 110°C

ELEKTRISCH

- ✗ Zuiver elektrische radiator
- ✗ Gemengde radiator

TECHNISCHE TEKENINGEN

- Zie p. 187

AANSLUITING

- ✗ Eénpuntsaansluiting voor éénpijpsysteem
- ✗ Eénpuntsaansluiting voor tweepijpsysteem
- ✓ Tweepuntsaansluiting voor éénpijpsysteem (aansluiting via de middenaansluiting) (zie p. 362)
- ✓ Tweepuntsaansluiting voor tweepijpsysteem (standaard) (zie p. 362)
- ✓ Geïntegreerd ventiel (**meerprijs €169**) (niet bij NS1L1) (zie p. 363)
- Aansluitingen: 1/2" (binnendraad)

AANBEVOLEN AANSLUITING NS1L1/NS2L1 (LB)

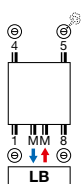

art. nr. 1182 103 0000 0099
prijs €190
 Koppelingen, zie p. 377

AANBEVOLEN VOOR BADKAMER EN KEUKEN IN OPTIE



handdoekbeugel (aluminium)

NS1L1 art. nr. zie p. 182
prijs €200

NS2L1 art. nr. zie p. 182
prijs €200

Andere accessoires, zie p. 182

OPTIE: AANSLUITING NS2L1 (VR) GEÏNTEGREERD VENTIEL (MEERPRIJS)

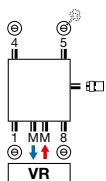

art. nr. 1182 301 0000 0099
prijs €157
 Koppelingen, zie p. 377

Meerprijs: €169 (zie p. 363)

Andere aansluitmogelijkheden, zie p. 184



STAAL DESIGNRADIATOREN

NIVA SOFT VERTICAAL

Pure klasse in al haar creativiteit

De Niva in al zijn compacte, gestyleerde eenvoud, maar nu in een uitvoering met zacht afgeronde zijkanalen. Een designradiator die uitstekend tot zijn recht komt zowel in een minimalistisch interieur als in een eigentijdse retro-omgeving. Leverbaar met thermostaatkop op deurknophoogte.



NIVA SOFT VERTICAAL (NS1L1, NS2L1)

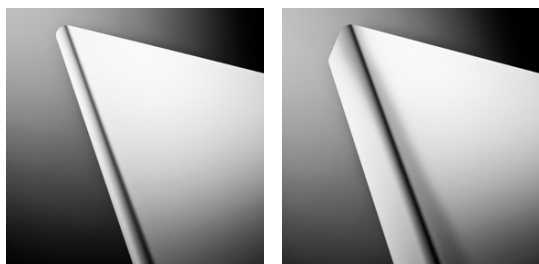

NS1L1

NS2L1

HOE NIVA SOFT BESTELLEN

Leveringstermijn 15 - 30 werkdagen
(zonder transportduur)

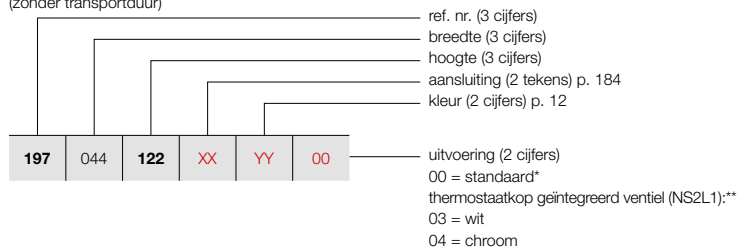

HOE VOORRAADRADIATOR NIVA SOFT BESTELLEN

Leveringstermijn 5 werkdagen
(zonder transportduur)

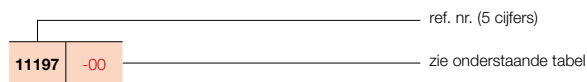

PRIJSGROEP: VPG2 - STAAL DESIGNRADIATOREN

BESTELCODE MAATWERK NIVA SOFT VERTICAAL	TECHNISCHE GEGEVENS									STANDAARDKLEUR		ANDERE KLEUREN prijs kleur (€)					
	buizen	breedte (L mm)	hoogte (H mm)	75/65/20 (Watt) (φ50K)	55/45/20 (Watt) (φ30K)	n-exp.	gewicht (kg)	inhoud (l)	el. weerst. (Watt)	prijs S600* (€)	verkorte ref. nr. S600 voorraad						
REF. NR. NIVA SOFT VERTICAAL NS1L1 : 197																	
197	044	122	XX	YY	00	-	440	1220	645	337	1,27	18,10	2,55	-	553	11197-06	636
		182				-	440	1820	934	486	1,28	27,35	3,70	-	643	11197-07	739
		202				-	440	2020	1023	532	1,28	30,20	4,00	-	677	11197-08	779
		222				-	440	2220	1070	559	1,27	33,20	4,50	-	732	-	842
197	054	122	XX	YY	00	-	540	1220	815	424	1,28	21,97	3,32	-	623	11197-04	716
		182				-	540	1820	1128	587	1,28	33,67	4,61	-	722	11197-01	830
		202				-	540	2020	1257	654	1,28	37,12	5,05	-	763	11197-05	877
		222				-	540	2220	1310	681	1,28	40,88	5,57	-	825	-	949
197	064	122	XX	YY	00	-	640	1220	985	510	1,29	25,83	3,85	-	648	11197-09	745
		182				-	640	1820	1322	687	1,28	39,98	5,52	-	753	11197-02	866
		202				-	640	2020	1490	775	1,28	44,03	6,10	-	798	11197-03	918
		222				-	640	2220	1550	806	1,28	48,57	6,63	-	864	-	994
197	074	182	XX	YY	00	-	740	1820	1515	784	1,29	46,30	6,43	-	781	11197-10	898
		202				-	740	2020	1724	897	1,28	50,95	7,15	-	831	11197-11	956
		222				-	740	2220	1790	926	1,29	56,25	7,70	-	904	-	1040
REF. NR. NIVA SOFT VERTICAAL NS2L1 : 198																	
198	044	122	XX	YY	00	-	440	1220	988	506	1,31	28,40	4,90	-	828	-	952
		182				-	440	1820	1330	681	1,31	42,23	7,28	-	961	11198-08	1105
		202				-	440	2020	1438	736	1,31	46,75	8,00	-	997	11198-09	1147
		222				-	440	2220	1543	823	1,23	51,40	8,90	-	1054	-	1212
198	054	122	XX	YY	00	-	540	1220	1213	621	1,31	36,83	6,48	-	929	11198-10	1068
		182				-	540	1820	1633	836	1,31	51,68	9,07	-	1082	11198-01	1244
		202				-	540	2020	1764	903	1,31	57,23	10,00	-	1121	11198-02	1289
		222				-	540	2220	1893	995	1,26	62,73	11,00	-	1187	-	1365
198	064	122	XX	YY	00	-	640	1220	1437	732	1,32	38,17	7,02	-	968	-	1113
		182				-	640	1820	1935	991	1,31	61,14	10,86	-	1127	11198-03	1296
		202				-	640	2020	2091	1071	1,31	67,72	12,00	-	1168	11198-04	1343
		222				-	640	2220	2243	1160	1,29	74,07	13,10	-	1243	-	1429
198	074	182	XX	YY	00	-	740	1820	2237	1146	1,31	70,60	12,65	-	1167	11198-11	1342
		202				-	740	2020	2417	1238	1,31	78,20	14,00	-	1223	11198-05	1406
		222				-	740	2220	2594	1322	1,32	85,40	15,20	-	1302	-	1497



Conform EN442-1: 2014: radiatoren en convectoren

* RAL 9016: geen meerprijs 15%

Voor meer details over onze artikel-data, zie artikel-database: <https://www.installdata.be>

Voor de warmteafgifte van andere regimes, kijkt u op p. 370 (correctiefactoren)
BELGIË. Prijzen in euro (excl. BTW)





PRIJSGROEP: VPG10 - ACC.

BEVESTIGINGEN		HOOGTE RADIATOR	KLEUR	ART. NR.
		N1L1 / N1L1-ES / NS1L1*		
MUURBEVESTIGING		1220 mm	S600	1187 104 1100 0600
		1820 mm	S600	1187 104 1700 0600
		2020 mm	S600	1187 104 1900 0600
		2220 mm	S600	1187 104 2100 0600
		N2L1 / N2L1-ES / NS2L1		
MUURBEVESTIGING		1220 mm	S600	1187 105 1100 0600
		1820 mm	S600	1187 105 1700 0600
		2020 mm	S600	1187 105 1900 0600
		2220 mm	S600	1187 105 2100 0600
		NH1L1		
MUURBEVESTIGING		450 mm	S600	1187 102 0400 0600
		550 mm	S600	1187 102 0500 0600
		650 mm	S600	1187 102 0600 0600
		950 mm	S600	1187 102 0900 0600
		NH2L1 / NH2L2		
MUURBEVESTIGING		550 mm	S600	118710305000600
		650 mm	S600	118710306000600
		950 mm	S600	118710309000600

Prijzen: zie prijslijst "spare parts"

* niet beschikbaar voor NS1L1 met geïntegreerd ventiel

PRIJSGROEP: VPG10B - HANDDOEKBEUGELS





ACCESSOIRES	BREEDTE HANDDOEKBEUGEL	KLEUR	ART. NR.	€
HANDDOEKBEUGEL MULTI+ RECHTS 	N1L1 / N2L1 / N1L1-ES / N2L1-ES / NS1L1 / NS2L1			
	600 mm	S600	1183 734 0000 0600	215
	600 mm	RAL 9005 ^S	1183 734 0000 9005	215
	<ul style="list-style-type: none"> • h = 70 mm; b = 600 mm (b tablet = 194 mm); e = 176 mm; c = 170 mm; • Bevestiging aan de muur, rechts van de radiator. 			
HANDDOEKBEUGEL MULTI+ LINKS 	N1L1 / N2L1 / N1L1-ES / N2L1-ES / NS1L1 / NS2L1			
	600 mm	S600	1183 735 0000 0600	215
	600 mm	RAL 9005 ^S	1183 735 0000 9005	215
	<ul style="list-style-type: none"> • h = 70 mm; b = 600 mm (b tablet = 194 mm); e = 176 mm; c = 170 mm; • Bevestiging aan de muur, links van de radiator. 			
KORTE BEUGEL 	N1L1 / N1L1-ES / NS1L1			
	240 mm	S600	1183 710 0000 0600	143
	240 mm	RAL 9005 ^S	1183 710 0000 9005	143
	N2L1 / N2L1-ES / NS2L1			
	240 mm	S600	1183 720 0000 0600	143
	240 mm	RAL 9005 ^S	1183 720 0000 9005	143
LANGE BEUGEL 	N1L1 / N1L1-ES / NS1L1			
	440 mm	S600	1183 711 0000 0600	143
	440 mm	RAL 9005 ^S	1183 711 0000 9005	143
	N2L1 / N2L1-ES / NS2L1			
	440 mm	S600	1183 721 0000 0600	143
	440 mm	RAL 9005 ^S	1183 721 0000 9005	143
<ul style="list-style-type: none"> • N1L1 / N1L1-ES: d = 66,5 mm; a = 56,5 mm • NS1L1: d = 68 mm; a = 58 mm • N2L1 / N2L1-ES: d = 59,5 mm; a = 49,5 mm • NS2L1: d = 58 mm; a = 48 mm 				

 structuur zwart

Montagevoorschriften accessoires: zie www.vasco.eu
 BELGIË. Prijzen in euro (excl. BTW)

e = afstand voorkant accessoire tot wand
 d = afstand voorkant accessoire tot voorkant radiator
 c = afstand wand tot achterkant beugel
 a = afstand accessoire tot radiator
uit voorraad leverbaar

PRIJSGROEP: VPG10B - HANDDOEKBEUGELS

ACCESSOIRES	BREEDTE HANDDOEKBEUGEL	KLEUR	ART. NR.	€
HANDDOEKBEUGEL 	N1L1 / N1L1-ES / NS1L1			
	372 mm	ALUMINIUM	1183 239 0000 0000	200
	372 mm	CHROOM	1183 239 0000 0099	200
	372 mm	RAL 9005 [■]	1183 239 0000 9005	200
	526 mm	CHROOM	1183 271 0000 0099	200
	526 mm	S600	1183 271 0000 0600	200
	526 mm	RAL 9005 [■]	1183 271 0000 9005	200
<ul style="list-style-type: none"> Handdoekbeugel in geanodiseerd aluminium h = 55 mm; b = 372, 526 mm; d = 56 mm; a = 50 mm; 	N2L1 / N2L1-ES / NS2L1			
HANDDOEKBEUGEL 	372 mm	ALUMINIUM	1183 240 0000 0000	200
	372 mm	CHROOM	1183 240 0000 0099	200
	372 mm	S600	1183 240 0000 0600	200
	372 mm	RAL 9005 [■]	1183 240 0000 9005	200
	526 mm	CHROOM	1183 272 0000 0099	200
	526 mm	S600	1183 272 0000 0600	200
	526 mm	RAL 9005 [■]	1183 272 0000 9005	200
<ul style="list-style-type: none"> Handdoekbeugel in geanodiseerd aluminium h = 55 mm; b = 372, 526 mm; d = 56 mm; a = 50 mm; 	BREEDTE RADIATOR			
HANDDOEKBEUGEL 	KLEUR			
	ART. NR.			
	€			
	N1L1 / N1L1-ES			
	420 mm	CHROOM	1183 213 0000 0099	200
	520 mm	CHROOM	1183 214 0000 0099	200
	520 mm	INOX/RVS	1183 214 0000 9993	200
620 mm	CHROOM	1183 215 0000 0099	200	
620 mm	INOX/RVS	1183 215 0000 9993	200	
720 mm	CHROOM	1183 216 0000 0099	200	
<ul style="list-style-type: none"> h = 25 mm; b = 440, 540, 640, 740 mm; d = 73 mm; a = 57 mm 	N2L1 / N2L1-ES			
HANDDOEKBEUGEL 	420 mm	CHROOM	1183 218 0000 0099	200
	520 mm	CHROOM	1183 219 0000 0099	200
	620 mm	CHROOM	1183 220 0000 0099	200
	720 mm	CHROOM	1183 221 0000 0099	200
	<ul style="list-style-type: none"> h = 25 mm; b = 440, 540, 640, 740 mm; d = 73 mm; a = 57 mm 	NH1L1 / NH2L1 / NH2L2		
HANDDOEKBEUGEL 		CHROOM	1183 217 0000 0099	200
<ul style="list-style-type: none"> h = 25 mm; b = 740 mm (zelf in te korten); d = 73 mm; a = 57 mm 				

■ mat zwart

Montagevoorschriften accessoires: zie www.vasco.eu
BELGIË. Prijzen in euro (excl. BTW)

d = afstand voorkant accessoire tot voorkant radiator
a = afstand accessoire tot radiator
uit voorraad leverbaar

NIVA LAK VERTICAAL: N1L1 / N2L1

NIVA INOX VERTICAAL: N1L1-ES / N2L1-ES

NIVA SOFT VERTICAAL: NS1L1 / NS2L1 (zonder geïntegreerd ventiel)

NIVA MIXED HYBRIDE: N1L1-EL-MIX

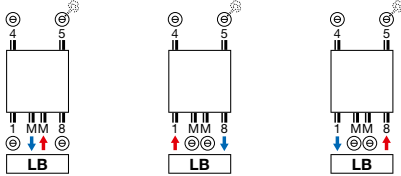

- **Opmerking: MM met aanvoer rechts.**

NIVA SOFT VERTICAAL: NS2L1

GEÏNTEGREERD VENTIEL

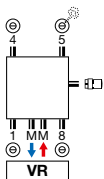

- **Meerprijs: €169 (zie p. 363)**
- **Opmerking: MM met aanvoer rechts (op deze aansluiting bevindt zich op de achterzijde een stijgbuis).**

NIVA LAK HORIZONTAAL: NH1L1 / NH2L1 / NH2L2

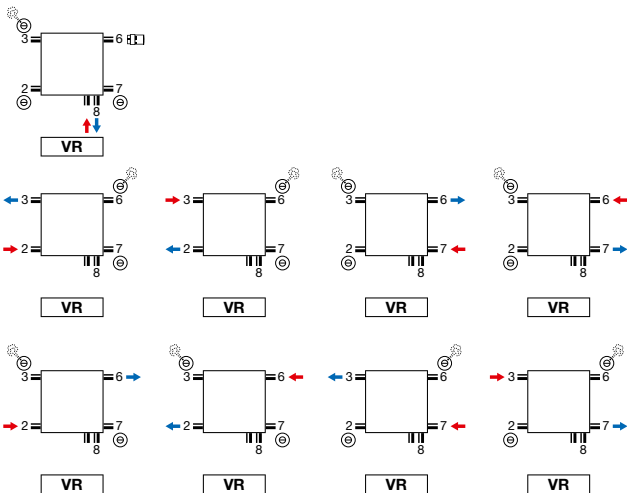

- **Geïntegreerd ventiel: geen meerprijs (zie p. 363)**
- **Thermostaatkop enkel te gebruiken bij aansluiting op het ventiel (aanvoer links, retour rechts). Andere aansluitingen, vb. SL, thermostaatkop uit de aansluiting 6 nemen. Hier is wel de mogelijkheid om aanvoer en retour te wisselen.**

Opmerking: het aansluiten van de radiator kan enkel volgens de getoonde aansluiticonen. Voor elke andere aansluitwijze nemen wij geen verantwoordelijkheid.

NIVA LAK VERTICAAL (N1L1, N2L1)

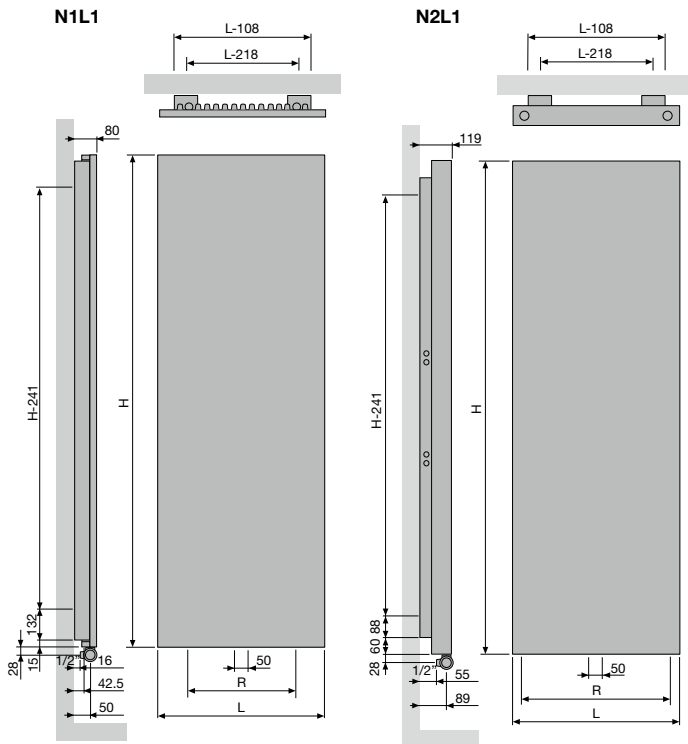

N1L1				
Breedte (L)	420	520	620	720
Hartafstand tussen de onderaansluitingen 18 (R)	200	300	400	500
Hartafstand tussen de ophangingen	L-218	H-241		

N2L1				
Breedte (L)	420	520	620	720
Hartafstand tussen de onderaansluitingen 18 (R)	338	438	538	638
Hartafstand tussen de ophangingen	L-218	H-241		

NIVA INOX VERTICAAL (N1L1-ES, N2L1-ES)

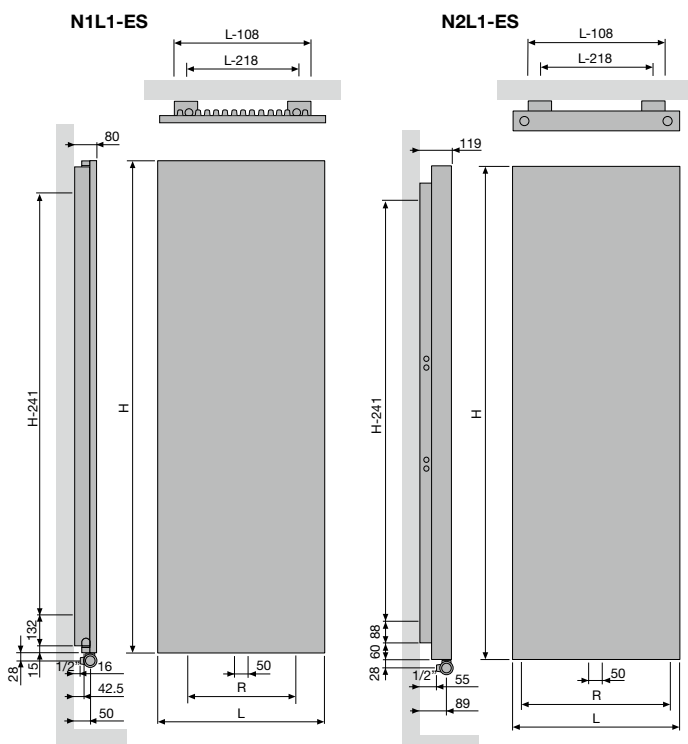

N1L1-ES				
Breedte (L)	520	620		
Hartafstand tussen de onderaansluitingen 18 (R)	300	400		
Hartafstand tussen de ophangingen	L-218	H-241		

N2L1-ES				
Breedte (L)	520	620		
Hartafstand tussen de onderaansluitingen 18 (R)	438	538		
Hartafstand tussen de ophangingen	L-218	H-241		

NIVA LAK HORIZONTAAL (NH1L1, NH2L1)

NH1L1 / NH2L1

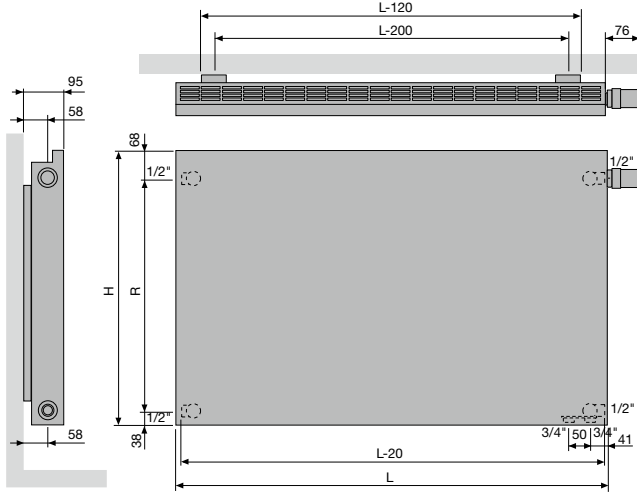

NH1L1				
Hoogte (H)	450	550	650	950
Hartafstand tussen de zijaansluitingen SL/SR (R)	343	443	543	843
Hartafstand tussen de ophangingen	L-200			

NH2L1				
Hoogte (H)	550	650	950	
Hartafstand tussen de zijaansluitingen SL/SR (R)	443	543	843	
Hartafstand tussen de ophangingen	L-200			

NIVA LAK HORIZONTAAL (NH2L2)

NH2L2

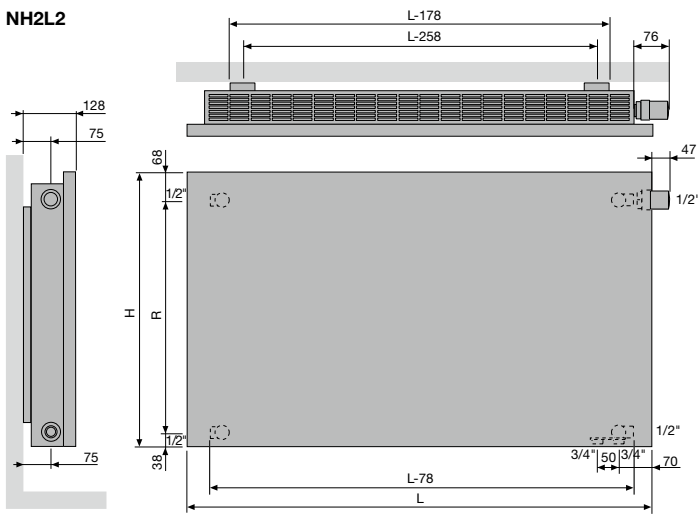

NH2L2				
Hoogte (H)	550	650	950	
Hartafstand tussen de zijaansluitingen SL/SR (R)	443	543	843	
Hartafstand tussen de ophangingen	L-258			

NIVA SOFT VERTICAAL (NS1L1)

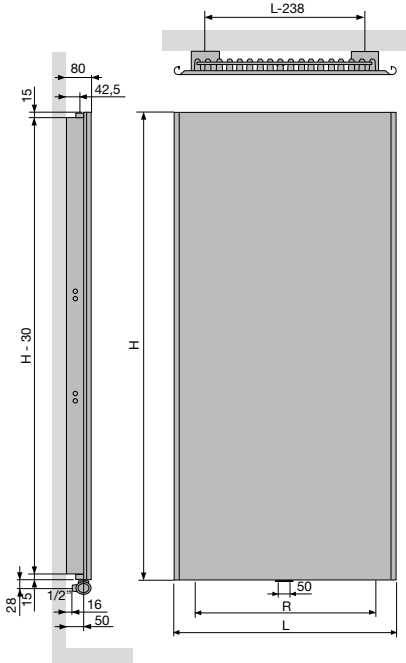

NS1L1				
Breedte (L)	440	540	640	740
Hartafstand tussen de onderaansluitingen 18 (R)	200	300	400	500
Hartafstand tussen de ophangingen	L-238	H-241		

NIVA SOFT VERTICAAL (NS2L1)

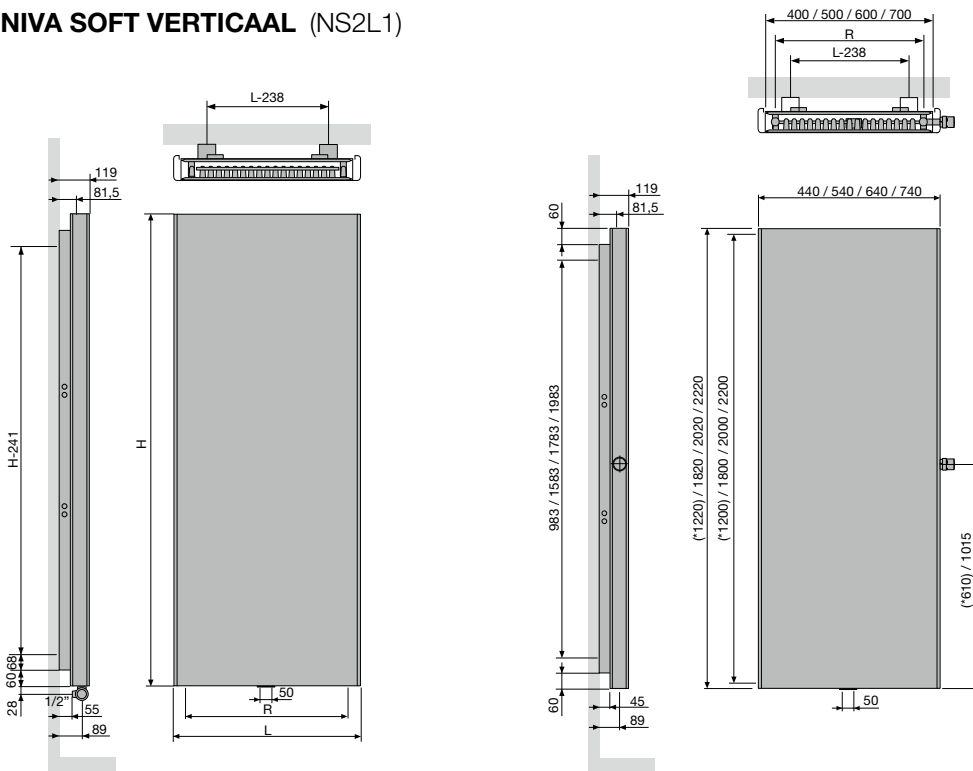

NS2L1				
Breedte (L)	440	540	640	740
Hartafstand tussen de onderaansluitingen 18 (R)	338	438	538	638
Hartafstand tussen de ophangingen	L-238	H-241		

**TYPES**

- Verticaal: Carré Plus (CPVN-PLUS)

BUIZEN

- Verticaal, vierkant 25 x 25 mm

COLLECTOREN

- Horizontaal, rond Ø 35 mm

KLEUREN

- Standaardkleur wit RAL 9016
- Uitgebreide kleurenkaart zie p. 12

BEVESTIGINGEN

- Muurbevestigingen standaard

TECHNISCH

- Weerstandsgelast (onzichtbare lasnaden)
- ATL-grondlaag, poedercoating
- Standaardwerkdruk: 10 bar
- Maximale bedrijfstemperatuur: 110°C

ELEKTRISCH

- ✗ Zuiver elektrische radiator in de fabriek vorgevuld
- ✗ Gemengde radiator

TECHNISCHE TEKENINGEN

- Zie p. 203

AANSLUITING

- ✗ Eénpuntsaansluiting voor éénpijpssysteem
- ✗ Eénpuntsaansluiting voor tweepijpssysteem
- ✓ Tweepuntsaansluiting voor éénpijpssysteem (aansluiting via de middenaansluiting) (zie p. 362)
- ✓ Tweepuntsaansluiting voor tweepijpssysteem (standaard) (zie p. 362)
- ✗ Geïntegreerd ventiel
- Aansluitingen: ½" (binnendraad)

CARRÉ PLUS VERTICAAL**Minimale tussenruimte,
maximaal effect**

Een icoon in de wereld van de designradiatoren. Speciaal voor de Carré ontwikkelde VASCO een heel nieuw type buis met scherpe hoeken voor een strakker design en met een optimaal warmerendement bij een minimale tussenruimte. De vlakke look creëert een gevoel van rust, versterkt door de weggewerkte, mooi in het geheel geïntegreerde collector. Een veel gelauwerde designradiator, waarvoor VASCO, zoals steeds, ook de passende accessoires ontwikkelde.

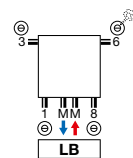
AANBEVOLEN AANSLUITING (LB)

Andere aansluitmogelijkheden, zie p. 202



art. nr. 1182 103 0000 0099

prijs €190

Koppelingen, zie p. 377

**AANBEVOLEN VOOR BADKAMER EN KEUKEN
IN OPTIE**

handdoekbeugel recht (chrom)

art. nr. zie p. 201

prijs €200

Andere accessoires, zie p. 201



HOE CARRÉ PLUS VERTICAAL BESTELLEN

Leveringstermijn 15 - 30 werkdagen
(zonder transportduur)

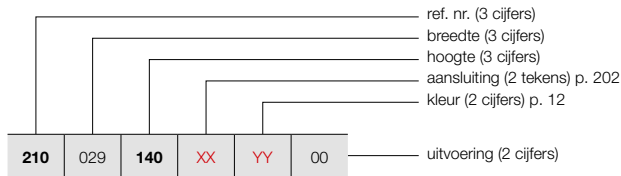

CARRÉ PLUS VERTICAAL (CPVN-PLUS)



CPVN-PLUS

HOE VOORRAADRADIATOR CARRÉ PLUS VERTICAAL BESTELLEN

Leveringstermijn 5 werkdagen
(zonder transportduur)

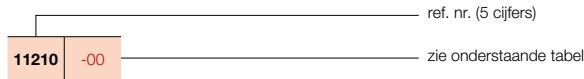

PRIJSGROEP: VPG2 - STAAL DESIGNRADIATOREN

BESTELCODE MAATWERK CARRÉ PLUS VERTICAAL	TECHNISCHE GEGEVENS							STANDAARDKLEUR		ANDERE KLEUREN		
	buizen	breedte (L mm)	hoogte (H mm)	75/65/20 (Watt) (Φ50K)	55/45/20 (Watt) (Φ30K)	n-exp.	gewicht (kg)	inhoud (l)	el. weerst. (Watt)		prijs RAL 9016 (€)	verkorte ref. nr. RAL 9016 voorraad
REF. NR. CARRÉ PLUS VERTICAAL CPVN-PLUS : 210												
210 029 140 XX YY 00	10	295	1400	871	443	1,31	19,70	8,40	-	519	-	597
	10	295	1600	986	505	1,31	21,60	9,40	-	572	-	658
	10	295	1800	1097	559	1,32	23,60	10,50	-	619	-	712
	10	295	2000	1206	614	1,32	26,20	12,00	-	666	-	766
	10	295	2200	1312	672	1,31	28,90	13,50	-	713	-	820
210 035 140 XX YY 00	12	355	1400	1026	521	1,31	23,16	10,08	-	626	-	720
	12	355	1600	1161	595	1,31	25,44	11,28	-	684	-	787
	12	355	1800	1293	659	1,32	27,72	12,48	-	744	11210-16	856
	12	355	2000	1421	724	1,32	30,96	14,40	-	799	-	919
	12	355	2200	1545	791	1,31	34,08	16,20	-	852	-	980
210 041 140 XX YY 00	14	415	1400	1179	599	1,31	26,46	11,76	-	729	-	838
	14	415	1600	1334	683	1,31	29,12	13,16	-	799	-	919
	14	415	1800	1485	757	1,32	31,64	14,56	-	867	-	997
	14	415	2000	1632	836	1,31	35,42	16,66	-	930	11210-05	1070
	14	415	2200	1775	909	1,31	39,20	18,90	-	995	-	1144
210 047 140 XX YY 00	16	475	1400	1330	676	1,31	29,60	13,28	-	832	-	957
	16	475	1600	1505	771	1,31	32,48	14,88	-	914	-	1051
	16	475	1800	1675	853	1,32	35,52	16,48	-	990	-	1139
	16	475	2000	1841	943	1,31	39,84	19,04	-	1066	-	1226
	16	475	2200	2002	1025	1,31	44,00	21,60	-	1136	-	1306
210 053 140 XX YY 00	18	535	1400	1478	751	1,31	32,58	14,94	-	935	-	1075
	18	535	1600	1673	857	1,31	35,82	16,74	-	1026	-	1180
	18	535	1800	1862	954	1,31	39,06	18,54	-	1114	11210-07	1281
	18	535	2000	2046	1048	1,31	43,92	21,42	-	1198	11210-09	1378
	18	535	2200	2226	1140	1,31	48,78	24,30	-	1277	-	1469
210 059 140 XX YY 00	20	595	1400	1625	826	1,31	35,20	16,60	-	1043	-	1199
	20	595	1600	1839	942	1,31	39,00	18,60	-	1143	-	1314
	20	595	1800	2047	1048	1,31	42,60	20,40	-	1237	11210-11	1423
	20	595	2000	2250	1152	1,31	48,00	23,60	-	1330	11210-12	1530
	20	595	2200	2447	1260	1,30	53,40	27,00	-	1421	-	1634
210 065 140 XX YY 00	22	655	1400	1771	900	1,31	37,84	18,26	-	1147	-	1319
	22	655	1600	2004	1026	1,31	41,80	20,24	-	1256	-	1444
	22	655	1800	2231	1143	1,31	45,76	22,44	-	1362	-	1566
	22	655	2000	2451	1255	1,31	51,70	25,96	-	1467	-	1687
	22	655	2200	2666	1372	1,30	57,64	29,48	-	1564	-	1799
210 071 140 XX YY 00	24	715	1400	1915	973	1,31	40,32	19,68	-	1249	-	1436
	24	715	1600	2167	1110	1,31	44,64	22,08	-	1371	-	1577
	24	715	1800	2412	1235	1,31	48,96	24,24	-	1484	-	1707
	24	715	2000	2651	1365	1,30	55,44	28,32	-	1596	-	1835
	24	715	2200	2883	1484	1,30	61,92	32,16	-	1703	-	1958

Conform EN442-1: 2014: radiatoren en convectoren

Voor meer details over onze artikel-data, zie artikel-database: <https://www.installdata.be>

Voor de warmteafgiftes van andere regimes, kijkt u op p. 370 (correctiefactoren)
BELGIË. Prijzen in euro (excl. BTW)

CARRÉ PLUS VERTICAAL (CPVN-PLUS)



CPVN-PLUS

HOE CARRÉ PLUS VERTICAAL BESTELLEN

Leveringstermijn 15 - 30 werkdagen
(zonder transportduur)

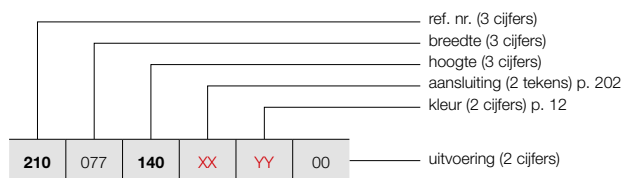

PRIJSGROEP: VPG2 - STAAL DESIGNRADIATOREN

BESTELCODE MAATWERK CARRÉ PLUS VERTICAAL	TECHNISCHE GEGEVENS									STANDAARDKLEUR	ANDERE KLEUREN
	buizen	breedte (L mm)	hoogte (H mm)	75/65/20 (Watt) (Ø50K)	55/45/20 (Watt) (Ø30K)	n-exp.	gewicht (kg)	inhoud (l)	el. weerst. (Watt)	prijs RAL 9016 (€)	prijs kleur (€)
REF. NR. CARRÉ PLUS VERTICAAL CPVN-PLUS : 210											
210	077	140	XX	YY	00						
		160								1355	1558
		180								1484	1707
		200								1609	1850
		220								1729	1988
										1848	2125
210	089	140	XX	YY	00						
		160								1564	1799
		180								1713	1970
		200								1855	2133
		220								1994	2293
										2133	2453

Conform EN442-1: 2014: radiatoren en convectoren

Voor meer details over onze artikel-data, zie artikel-database: <https://www.installdata.be>

Voor de warmteafgifte van andere regimes, kijkt u op p. 370 (correctiefactoren)
BELGIË. Prijzen in euro (excl. BTW)

TYPES

- Twee rijen buizen (CPVN2-ZB)

BUIZEN

- Verticaal, vierkant 25 x 25 mm

COLLECTOREN

- Horizontaal, rond Ø 35 mm

KLEUREN

- Standaardkleur wit RAL 9016
- Uitgebreide kleurenkaart zie p. 12

BEVESTIGINGEN

- Muurbevestigingen in de kleur RAL 9016 standaard. Ook in optie verkrijgbaar in de kleur RAL 7016 (zie p. 201).

TECHNISCH

- Weerstandsgelast (onzichtbare lasnaden)
- ATL-grondlaag, poedercoating
- Standaardwerkdruk: 10 bar
- Maximale bedrijfstemperatuur: 110°C

ELEKTRISCH

- ✗ Zuiver elektrische radiator in de fabriek vorgevuld
- ✗ Gemengde radiator

TECHNISCHE TEKENINGEN

- Zie p. 203

AANSLUITING

- ✗ Eénpuntsaansluiting voor éénpijpsysteem
- ✗ Eénpuntsaansluiting voor tweepijpsysteem
- ✓ Tweepuntsaansluiting voor éénpijpsysteem (aansluiting via de middenaansluiting) (zie p. 362)
- ✓ Tweepuntsaansluiting voor tweepijpsysteem (standaard) (zie p. 362)
- ✗ Geïntegreerd ventiel
- Aansluitingen: ½" (binnendraad)

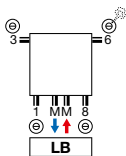
**AANBEVOLEN AANSLUITING (LB)**

Andere aansluitmogelijkheden, zie p. 202



art. nr. 1182 103.0000 0099

prijs €190

Koppelingen, zie p. 377

AANBEVOLEN VOOR BADKAMER EN KEUKEN IN OPTIE

handdoekbeugel recht (chrom) art. nr. zie p. 201

prijs €200

Andere accessoires, zie p. 201

CARRÉ VERTICAAL**Topdesign met dubbele warmtecapaciteit**

De strakke, vlakke look van de Carré Plus, voorzien van een dubbele buizenrij voor een maximale warmteafgifte. De Carré Verticaal designradiator blijft in alles zijn tijdloze, functionele zelf, maar garandeert door die extra capaciteit ook in grotere ruimten een optimaal rendement.



CARRÉ VERTICAAL (CPVN2-ZB)



CPVN2-ZB

HOE CARRÉ VERTICAAL BESTELLEN

Leveringstermijn 15 - 30 werkdagen
(zonder transportduur)

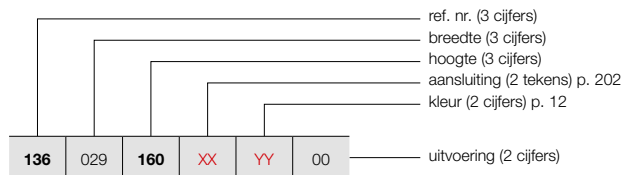

PRIJSGROEP: VPG2 - STAAL DESIGNRADIATOREN

BESTELCODE MAATWERK CARRÉ VERTICAAL	TECHNISCHE GEGEVENS									STANDAARDKLEUR	ANDERE KLEUREN
	buizen	breedte (L mm)	hoogte (H mm)	75/65/20 (Watt) (Ø50K)	55/45/20 (Watt) (Ø30K)	n-exp.	gewicht (kg)	inhoud (l)	el. weerst. (Watt)	prijs RAL 9016 (€)	prijs kleur (€)
REF. NR. CARRÉ VERTICAAL CPVN2-ZB : 136											
136	029	160	XX	YY	00						
		180								914	1051
		200								990	1139
		220								1066	1226
		240								1136	1306
		260								1207	1388
		280								1275	1466
		300								1342	1543
										1404	1615
136	035	160	XX	YY	00						
		180								1094	1258
		200								1188	1366
		220								1277	1469
		240								1363	1567
		260								1446	1663
		280								1527	1756
		300								1608	1849
										1687	1940
136	041	160	XX	YY	00						
		180								1277	1469
		200								1388	1596
		220								1490	1714
		240								1593	1832
		260								1687	1940
		280								1783	2050
		300								1878	2160
										1966	2261
136	047	160	XX	YY	00						
		180								1463	1682
		200								1584	1822
		220								1703	1958
		240								1816	2088
		260								1928	2217
		280								2041	2347
		300								2146	2468
										2250	2588
136	053	160	XX	YY	00						
		180								1645	1892
		200								1783	2050
		220								1919	2207
		240								2046	2353
		260								2172	2498
		280								2296	2640
		300								2413	2775
										2529	2908

Conform EN442-1: 2014: radiatoren en convectoren

Voor meer details over onze artikel-data, zie artikel-database: <https://www.installdata.be>

Voor de warmteafgifte van andere regimes, kijkt u op p. 370 (correctiefactoren)
BELGIË. Prijzen in euro (excl. BTW)

HOE CARRÉ VERTICAAL BESTELLEN

Leveringstermijn 15 - 30 werkdagen
(zonder transportduur)

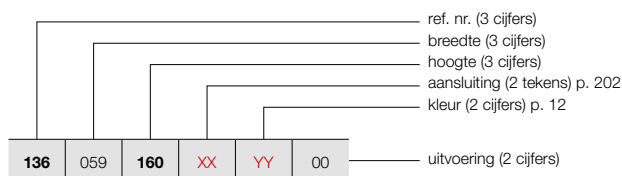

CARRÉ VERTICAAL (CPVN2-ZB)

193



CPVN2-ZB

PRIJSGROEP: VPG2 - STAAL DESIGNRADIATOREN

BESTELCODE MAATWERK CARRÉ VERTICAAL	TECHNISCHE GEGEVENS							STANDAARDKLEUR		ANDERE KLEUREN						
	buizen	breedte (L mm)	hoogte (H mm)	75/65/20 (Watt) (Φ50K)	55/45/20 (Watt) (Φ30K)	n-exp.	gewicht (kg)	inhoud (l)	el. weerst. (Watt)	prijs RAL 9016 (€)	prijs kleur (€)					
REF. NR. CARRÉ VERTICAAL CPVN2-ZB : 136																
136	059	160	XX	YY	00	20	595	1600	2125	1066	1,35	60,40	31,60	-	1829	2103
		180				20	595	1800	2348	1178	1,35	67,60	35,80	-	1981	2278
		200				20	595	2000	2557	1283	1,35	74,60	40,20	-	2129	2448
		220				20	595	2200	2754	1382	1,35	81,20	42,60	-	2273	2614
		240				20	595	2400	2938	1474	1,35	87,60	45,20	-	2412	2774
		260				20	595	2600	3110	1561	1,35	94,20	47,80	-	2549	2931
		280				20	595	2800	3269	1640	1,35	100,60	50,20	-	2679	3081
		300				20	595	3000	3417	1715	1,35	107,20	52,80	-	2811	3233
136	065	160	XX	YY	00	22	655	1600	2337	1173	1,35	66,44	34,76	-	2011	2313
		180				22	655	1800	2582	1296	1,35	74,36	39,38	-	2178	2505
		200				22	655	2000	2812	1411	1,35	82,06	44,22	-	2343	2694
		220				22	655	2200	3029	1520	1,35	89,32	46,86	-	2501	2876
		240				22	655	2400	3232	1622	1,35	96,36	49,72	-	2654	3052
		260				22	655	2600	3421	1717	1,35	103,62	52,58	-	2805	3226
		280				22	655	2800	3596	1804	1,35	110,66	55,22	-	2950	3393
		300				22	655	3000	3759	1886	1,35	117,92	58,08	-	3092	3556
136	071	160	XX	YY	00	24	715	1600	2550	1280	1,35	72,48	37,92	-	2193	2522
		180				24	715	1800	2817	1413	1,35	81,12	42,96	-	2374	2730
		200				24	715	2000	3069	1540	1,35	89,52	48,24	-	2555	2938
		220				24	715	2200	3305	1658	1,35	97,44	51,12	-	2723	3131
		240				24	715	2400	3526	1769	1,35	105,12	54,24	-	2899	3334
		260				24	715	2600	3732	1873	1,35	113,04	57,36	-	3061	3520
		280				24	715	2800	3923	1968	1,35	120,72	60,24	-	3217	3700
		300				24	715	3000	4101	2058	1,35	128,64	63,36	-	3376	3882
136	077	160	XX	YY	00	26	775	1600	2762	1386	1,35	78,52	41,08	-	2374	2730
		180				26	775	1800	3052	1531	1,35	87,88	46,54	-	2574	2960
		200				26	775	2000	3324	1668	1,35	96,98	52,26	-	2768	3183
		220				26	775	2200	3580	1796	1,35	105,56	55,38	-	2955	3398
		240				26	775	2400	3820	1917	1,35	113,88	58,76	-	3134	3604
		260				26	775	2600	4043	2029	1,35	122,46	62,14	-	3314	3811
		280				26	775	2800	4250	2133	1,35	130,78	65,26	-	3486	4009
		300				26	775	3000	4442	2229	1,35	139,36	68,64	-	3653	4201
136	089	160	XX	YY	00	30	895	1600	3187	1599	1,35	90,60	47,40	-	2738	3149
		180				30	895	1800	3521	1767	1,35	101,40	53,70	-	2971	3417
		200				30	895	2000	3836	1925	1,35	111,90	60,30	-	3191	3670
		220				30	895	2200	4131	2073	1,35	121,80	63,90	-	3413	3925
		240				30	895	2400	4407	2211	1,35	131,40	67,80	-	3616	4158
		260				30	895	2600	4665	2341	1,35	141,30	71,70	-	3825	4399

Conform EN442-1: 2014: radiatoren en convectoren

Voor meer details over onze artikel-data, zie artikel-database: <https://www.installdata.be>
Voor de warmteafgiftes van andere regimes, kijkt u op p. 370 (correctiefactoren)
BELGIË. Prijzen in euro (excl. BTW)

CARRÉ HORIZONTAAL (CPHN1-RO, CPHN2-RO)



TYPES

- Eén (CPHN1-RO) of twee rijen buizen (CPHN2-RO)

BUIZEN

- Horizontaal, vierkant 25 x 25 mm

COLLECTOREN

- Verticaal, rond Ø 35 mm

KLEUREN

- Standaardkleur wit RAL 9016
- Uitgebreide kleurenkaart zie p. 12

SPECIAAL

- CPHN1-RO ook verkrijgbaar als toileradiator (600 x 415 mm)

BEVESTIGINGEN

- Muurbevestigingen in de kleur RAL 9016 standaard. Ook in optie verkrijgbaar in de kleur RAL 7016 (zie p. 201).

TECHNISCH

- Weerstandsgelast (onzichtbare lasnaden)
- ATL-grondlaag, poedercoating
- Standaardwerkdruk: 10 bar
- Maximale bedrijfstemperatuur: 110°C

ELEKTRISCH

- ✗ Zuiver elektrische radiator in de fabriek voorgevuld
- ✗ Gemengde radiator

TECHNISCHE TEKENINGEN

- Zie p. 204

AANSLUITING

- ✗ Eénpuntsaansluiting voor éénpijpsysteem
- ✗ Eénpuntsaansluiting voor tweepijpsysteem
- ✗ Tweepuntsaansluiting voor éénpijpsysteem
- ✓ Tweepuntsaansluiting voor tweepijpsysteem (standaard) (zie p. 362)
- ✗ Geïntegreerd ventiel
- Aansluitingen: ½" (binnendraad)

CARRÉ HORIZONTAAL

Topdesign voor elke warmtebehoefte

De horizontale versie van de Carré, met keuze uit één of twee buizenrijen voor een warmteafgifte op maat in elke ruimte. Een designradiator die ook in de horizontale uitvoering uitblinkt door zijn strak design en zijn vlakke look, nog versterkt door de in het geheel geïntegreerde collector.

AANBEVOLEN AANSLUITING (18)

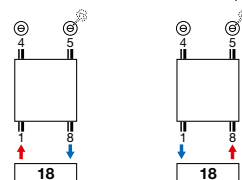

Andere aansluitmogelijkheden, zie p. 202



art. nr. 1182 101 0000 0099

prijs €234

Koppelingen, zie p. 377

AANBEVOLEN VOOR BADKAMER EN KEUKEN IN OPTIE



handdoekbeugel recht (chrom) art. nr. zie p. 201

prijs €200

Andere accessoires, zie p. 201



HOE CARRÉ HORIZONTAAL BESTELLEN

Leveringstermijn 15 - 30 werkdagen
(zonder transportduur)

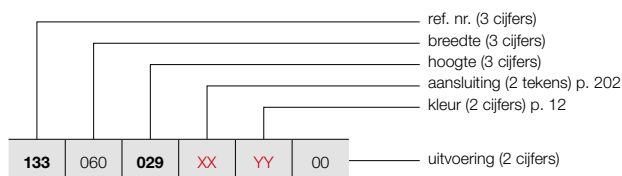

CARRÉ HORIZONTAAL (CPHN1-RO)

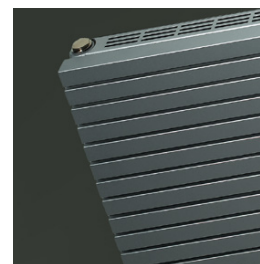

CPHN1-RO

PRIJSGROEP: VPG2 - STAAL DESIGNRADIATOREN

BESTELCODE MAATWERK CARRÉ HORIZONTAAL	TECHNISCHE GEGEVENS							STANDAARDKLEUR		ANDERE KLEUREN	
	buizen	breedte (L mm)	hoogte (H mm)	75/65/20 (Watt) (φ50K)	55/45/20 (Watt) (φ30K)	n-exp.	gewicht (kg)	inhoud (l)	el. weerst. (Watt)	prijs RAL 9016 (€)	prijs kleur (€)
REF. NR. CARRÉ HORIZONTAAL CPHN1-RO : 133											
133 060 029 XX YY 00	10	600	295	221	117	1,25	6,19	2,85	-	250	288
	12	600	355	259	137	1,25	7,41	3,60	-	300	345
	14	600	415	296	156	1,25	8,63	4,35	-	350	403
	16	600	475	333	176	1,25	9,86	5,10	-	399	459
	18	600	535	369	195	1,25	11,08	5,85	-	447	514
	20	600	595	404	213	1,25	12,30	6,60	-	498	573
	22	600	655	439	231	1,26	13,42	6,94	-	552	635
	26	600	775	507	266	1,26	15,67	7,63	-	650	748
	30	600	895	574	302	1,26	17,91	8,31	-	751	864
	133 080 029 XX YY 00	10	800	295	295	156	1,25	8,25	3,80	-	306
12		800	355	346	183	1,25	9,88	4,80	-	362	416
14		800	415	395	209	1,25	11,51	5,80	-	426	490
16		800	475	444	234	1,25	13,14	6,80	-	485	558
18		800	535	492	260	1,25	14,77	7,80	-	547	629
20		800	595	538	284	1,25	16,40	8,80	-	608	699
22		800	655	585	307	1,26	17,90	9,26	-	669	769
26		800	775	676	355	1,26	20,89	10,17	-	792	911
30		800	895	766	402	1,26	23,88	11,08	-	913	1050
133 100 029 XX YY 00		10	1000	295	369	195	1,25	10,31	4,75	-	354
	12	1000	355	432	228	1,25	12,35	6,00	-	426	490
	14	1000	415	494	261	1,25	14,39	7,25	-	496	570
	16	1000	475	555	293	1,25	16,43	8,50	-	567	652
	18	1000	535	615	325	1,25	18,46	9,75	-	636	731
	20	1000	595	673	355	1,25	20,50	11,00	-	712	819
	22	1000	655	731	384	1,26	22,37	11,57	-	781	898
	26	1000	775	845	444	1,26	26,11	12,71	-	921	1059
	30	1000	895	957	503	1,26	29,85	13,85	-	1064	1224
	133 120 029 XX YY 00	10	1200	295	443	234	1,25	12,37	5,70	-	400
12		1200	355	518	274	1,25	14,82	7,20	-	483	555
14		1200	415	593	313	1,25	17,27	8,70	-	563	647
16		1200	475	666	352	1,25	19,72	10,20	-	645	742
18		1200	535	738	390	1,25	22,15	11,70	-	723	831
20		1200	595	808	427	1,25	24,60	13,20	-	804	925
22		1200	655	877	461	1,26	26,84	13,88	-	882	1014
26		1200	775	1014	533	1,26	31,33	15,25	-	1046	1203
30		1200	895	1148	603	1,26	35,82	16,62	-	1202	1382
133 140 029 XX YY 00		10	1400	295	517	273	1,25	14,43	6,65	-	444
	12	1400	355	605	319	1,25	17,29	8,40	-	535	615
	14	1400	415	692	365	1,25	20,15	10,15	-	626	720
	16	1400	475	777	410	1,25	23,00	11,90	-	715	822
	18	1400	535	861	455	1,25	25,84	13,65	-	804	925
	20	1400	595	942	497	1,25	28,70	15,40	-	893	1027
	22	1400	655	1023	537	1,26	31,32	16,20	-	982	1129
	26	1400	775	1183	622	1,26	36,55	17,79	-	1161	1335
	30	1400	895	1340	704	1,26	41,79	19,39	-	1337	1538

Conform EN442-1: 2014: radiatoren en convectoren

Voor meer details over onze artikel-data, zie artikel-database: <https://www.installdata.be>

Voor de warmteafgiftes van andere regimes, kijkt u op p. 370 (correctiefactoren)
BELGIË. Prijzen in euro (excl. BTW)

STAAL DESIGNRADIATOREN

CARRÉ HORIZONTAAL (CPHN1-RO)

HOE CARRÉ HORIZONTAAL BESTELLEN

Leveringstermijn 15 - 30 werkdagen
(zonder transportduur)

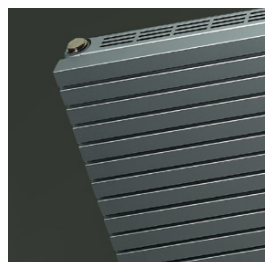

CPHN1-RO

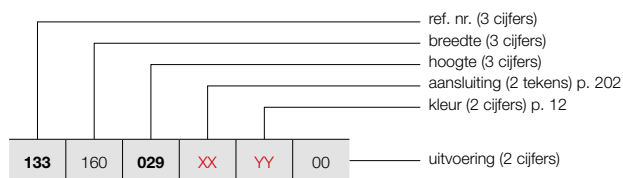

PRIJSGROEP: VPG2 - STAAL DESIGNRADIATOREN

BESTELCODE MAATWERK CARRÉ HORIZONTAAL							TECHNISCHE GEGEVENS				STANDAARDKLEUR	ANDERE KLEUREN				
buizen	breedte (L mm)	hoogte (H mm)	75/65/20 (Watt) (Φ50K)	55/45/20 (Watt) (Φ30K)	n-exp.	gewicht (kg)	inhoud (l)	el. weerst. (Watt)	prijs RAL 9016 (€)	prijs kleur (€)						
REF. NR. CARRÉ HORIZONTAAL CPHN1-RO : 133																
133	160	029	XX	YY	00	10	1600	295	590	312	1,25	16,50	7,60	-	489	562
		035				12	1600	355	691	365	1,25	19,76	9,60	-	586	674
		041				14	1600	415	790	417	1,25	23,02	11,60	-	684	787
		047				16	1600	475	888	469	1,25	26,29	13,60	-	785	903
		053				18	1600	535	984	520	1,25	29,54	15,60	-	879	1011
		059				20	1600	595	1077	569	1,25	32,80	17,60	-	977	1124
		065				22	1600	655	1170	615	1,26	35,79	18,51	-	1078	1240
		077				26	1600	775	1352	710	1,26	41,78	20,34	-	1274	1465
		089				30	1600	895	1531	804	1,26	47,76	22,16	-	1469	1689
133	180	029	XX	YY	00	10	1800	295	664	351	1,25	18,56	8,55	-	530	610
		035				12	1800	355	778	411	1,25	22,23	10,80	-	636	731
		041				14	1800	415	889	469	1,25	25,90	13,05	-	744	856
		047				16	1800	475	999	528	1,25	29,57	15,30	-	847	974
		053				18	1800	535	1107	585	1,25	33,23	17,55	-	956	1099
		059				20	1800	595	1211	639	1,25	36,90	19,80	-	1062	1221
		065				22	1800	655	1316	691	1,26	40,27	20,83	-	1166	1341
		077				26	1800	775	1521	799	1,26	47,00	22,88	-	1380	1587
		089				30	1800	895	1723	905	1,26	53,73	24,93	-	1589	1827
133	200	029	XX	YY	00	10	2000	295	738	390	1,25	20,62	9,50	-	572	658
		035				12	2000	355	864	456	1,25	24,70	12,00	-	683	785
		041				14	2000	415	988	522	1,25	28,78	14,50	-	799	919
		047				16	2000	475	1110	586	1,25	32,86	17,00	-	913	1050
		053				18	2000	535	1230	650	1,25	36,92	19,50	-	1025	1179
		059				20	2000	595	1346	711	1,25	41,00	22,00	-	1141	1312
		065				22	2000	655	1462	768	1,26	44,74	23,14	-	1254	1442
		077				26	2000	775	1690	888	1,26	52,22	25,42	-	1482	1704
		089				30	2000	895	1914	1006	1,26	59,70	27,70	-	1711	1968
133	220	029	XX	YY	00	10	2200	295	812	429	1,25	22,68	10,45	-	608	699
		035				12	2200	355	950	502	1,25	27,17	13,20	-	730	840
		041				14	2200	415	1087	574	1,25	31,66	15,95	-	852	980
		047				16	2200	475	1221	645	1,25	36,15	18,70	-	974	1120
		053				18	2200	535	1353	714	1,25	40,61	21,45	-	1094	1258
		059				20	2200	595	1481	782	1,25	45,10	24,20	-	1217	1400
		065				22	2200	655	1608	845	1,26	49,21	25,45	-	1337	1538
		077				26	2200	775	1859	977	1,26	57,44	27,96	-	1583	1820
		089				30	2200	895	2105	1106	1,26	65,67	30,47	-	1829	2103
133	240	029	XX	YY	00	10	2400	295	886	468	1,25	24,74	11,40	-	648	745
		035				12	2400	355	1037	548	1,25	29,64	14,40	-	774	890
		041				14	2400	415	1186	626	1,25	34,54	17,40	-	905	1041
		047				16	2400	475	1332	703	1,25	39,43	20,40	-	1036	1191
		053				18	2400	535	1476	779	1,25	44,30	23,40	-	1163	1337
		059				20	2400	595	1615	853	1,25	49,20	26,40	-	1293	1487
		065				22	2400	655	1754	922	1,26	53,69	27,77	-	1421	1634
		077				26	2400	775	2028	1065	1,26	62,66	30,50	-	1680	1932
		089				30	2400	895	2297	1207	1,26	71,64	33,24	-	1938	2229

Conform EN442-1: 2014: radiatoren en convectoren

Voor meer details over onze artikel-data, zie artikel-database: <https://www.installdata.be>

Voor de warmteafgifte van andere regimes, kijkt u op p. 370 (correctiefactoren)
BELGIË. Prijzen in euro (excl. BTW)

HOE CARRÉ HORIZONTAAL BESTELLEN

Leveringstermijn 15 - 30 werkdagen
(zonder transportduur)

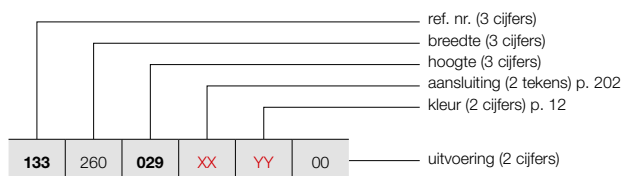

CARRÉ HORIZONTAAL (CPHN1-RO)

197



CPHN1-RO

PRIJSGROEP: VPG2 - STAAL DESIGNRADIATOREN

BESTELCODE MAATWERK CARRÉ HORIZONTAAL	TECHNISCHE GEGEVENS							STANDAARDKLEUR		ANDERE KLEUREN						
	buizen	breedte (L mm)	hoogte (H mm)	75/65/20 (Watt) (Φ50K)	55/45/20 (Watt) (Φ30K)	n-exp.	gewicht (kg)	inhoud (l)	el. weerst. (Watt)	prijs RAL 9016 (€)	prijs kleur (€)					
REF. NR. CARRÉ HORIZONTAAL CPHN1-RO : 133																
133	260	029	XX	YY	00	10	2600	295	959	506	1,25	26,81	12,35	-	681	783
						12	2600	355	1123	593	1,25	32,11	15,60	-	819	942
						14	2600	415	1284	678	1,25	37,41	18,85	-	956	1099
						16	2600	475	1443	762	1,25	42,72	22,10	-	1091	1255
						18	2600	535	1599	844	1,25	48,00	25,35	-	1230	1415
						20	2600	595	1750	924	1,25	53,30	28,60	-	1366	1571
						22	2600	655	1901	999	1,26	58,16	30,08	-	1501	1726
						26	2600	775	2197	1154	1,26	67,89	33,05	-	1774	2040
						30	2600	895	2488	1307	1,26	77,61	36,01	-	2049	2356
						133	280	029	XX	YY	00	10	2800	295	1033	545
12	2800	355	1210	639	1,25							34,58	16,80	-	863	992
14	2800	415	1383	730	1,25							40,29	20,30	-	1005	1156
16	2800	475	1554	821	1,25							46,00	23,80	-	1150	1323
18	2800	535	1722	909	1,25							51,69	27,30	-	1293	1487
20	2800	595	1884	995	1,25							57,40	30,80	-	1437	1653
22	2800	655	2047	1075	1,26							62,64	32,40	-	1582	1819
26	2800	775	2366	1243	1,26							73,11	35,59	-	1865	2145
30	2800	895	2680	1408	1,26							83,58	38,78	-	2155	2478
133	300	029	XX	YY	00							10	3000	295	1107	585
						12	3000	355	1296	684	1,25	37,05	18,00	-	904	1040
						14	3000	415	1482	783	1,25	43,17	21,75	-	1054	1212
						16	3000	475	1665	879	1,25	49,29	25,50	-	1202	1382
						18	3000	535	1845	974	1,25	55,38	29,25	-	1356	1559
						20	3000	595	2019	1066	1,25	61,50	33,00	-	1505	1731
						22	3000	655	2193	1152	1,26	67,11	34,71	-	1656	1904
						26	3000	775	2535	1332	1,26	78,33	38,13	-	1959	2253
						30	3000	895	2871	1508	1,26	89,55	41,55	-	2260	2599

Conform EN442-1: 2014: radiatoren en convectoren

Voor meer details over onze artikel-data, zie artikel-database: <https://www.installdata.be>

Voor de warmteafgiftes van andere regimes, kijkt u op p. 370 (correctiefactoren)
BELGIË. Prijzen in euro (excl. BTW)

CARRÉ HORIZONTAAL (CPHN2-RO)

HOE CARRÉ HORIZONTAAL BESTELLEN

Leveringstermijn 15 - 30 werkdagen
(zonder transportduur)



CPHN2-RO

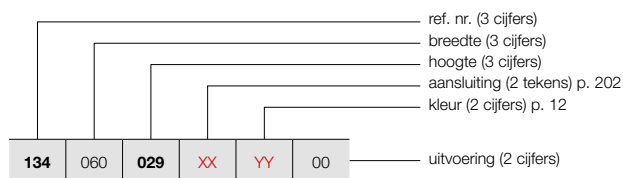

PRIJSGROEP: VPG2 - STAAL DESIGNRADIATOREN

BESTELCODE MAATWERK CARRÉ HORIZONTAAL						TECHNISCHE GEGEVENS					STANDAARDKLEUR		ANDERE KLEUREN			
						buizen	breedte (L mm)	hoogte (H mm)	75/65/20 (Watt) (Φ50K)	55/45/20 (Watt) (Φ30K)	n-exp.	gewicht (kg)	inhoud (l)	el. weerst. (Watt)	prijs RAL 9016 (€)	prijs kleur (€)
REF. NR. CARRÉ HORIZONTAAL CPHN2-RO : 134																
134	060	029	XX	YY	00	10	600	295	377	200	1,24	11,94	6,06	-	488	561
		035				12	600	355	459	242	1,25	14,26	7,27	-	582	669
		041				14	600	415	539	282	1,27	16,57	8,48	-	681	783
		047				16	600	475	617	321	1,28	18,89	9,70	-	779	896
		053				18	600	535	693	359	1,29	21,20	10,91	-	877	1009
		059				20	600	595	766	394	1,30	23,52	12,12	-	974	1120
		065				22	600	655	836	430	1,30	25,85	13,39	-	1071	1232
		077				26	600	775	967	498	1,30	30,50	15,94	-	1268	1458
		089				30	600	895	1087	560	1,30	35,16	18,48	-	1463	1682
		134				080	029	XX	YY	00	10	800	295	503	267	1,24
035	12		800	355	612		323				1,25	19,01	9,70	-	713	820
041	14		800	415	719		376				1,27	22,10	11,31	-	830	955
047	16		800	475	823		428				1,28	25,18	12,93	-	948	1090
053	18		800	535	924		478				1,29	28,27	14,54	-	1068	1228
059	20		800	595	1021		526				1,30	31,36	16,16	-	1188	1366
065	22		800	655	1114		573				1,30	34,46	17,86	-	1304	1500
077	26		800	775	1290		664				1,30	40,67	21,25	-	1542	1773
089	30		800	895	1449		746				1,30	46,88	24,64	-	1777	2044
134	100		029	XX	YY		00				10	1000	295	629	334	1,24
		035	12			1000		355	765	404	1,25	23,76	12,12	-	830	955
		041	14			1000		415	899	470	1,27	27,62	14,14	-	967	1112
		047	16			1000		475	1029	535	1,28	31,48	16,16	-	1109	1275
		053	18			1000		535	1155	598	1,29	35,34	18,18	-	1240	1426
		059	20			1000		595	1276	657	1,30	39,20	20,20	-	1385	1593
		065	22			1000		655	1393	717	1,30	43,08	22,32	-	1524	1753
		077	26			1000		775	1612	830	1,30	50,84	26,56	-	1798	2068
		089	30			1000		895	1811	932	1,30	58,60	30,80	-	2071	2382
		134	120			029		XX	YY	00	10	1200	295	755	401	1,24
035	12			1200	355	918	485				1,25	28,51	14,54	-	942	1083
041	14			1200	415	1079	564				1,27	33,14	16,97	-	1094	1258
047	16			1200	475	1235	642				1,28	37,78	19,39	-	1252	1440
053	18			1200	535	1386	717				1,29	42,41	21,82	-	1409	1620
059	20			1200	595	1531	788				1,30	47,04	24,24	-	1568	1803
065	22			1200	655	1672	861				1,30	51,70	26,78	-	1722	1980
077	26			1200	775	1934	996				1,30	61,01	31,87	-	2038	2344
089	30			1200	895	2173	1119				1,30	70,32	36,96	-	2349	2701
134	140			029	XX	YY	00				10	1400	295	881	468	1,24
		035	12	1400				355	1071	566	1,25	33,26	16,97	-	1046	1203
		041	14	1400				415	1259	658	1,27	38,67	19,80	-	1223	1406
		047	16	1400				475	1441	749	1,28	44,07	22,62	-	1393	1602
		053	18	1400				535	1617	837	1,29	49,48	25,45	-	1568	1803
		059	20	1400				595	1786	919	1,30	54,88	28,28	-	1742	2003
		065	22	1400				655	1950	1004	1,30	60,31	31,25	-	1914	2201
		077	26	1400				775	2257	1162	1,30	71,18	37,18	-	2265	2605
		089	30	1400				895	2535	1305	1,30	82,04	43,12	-	2610	3002

Conform EN442-1: 2014: radiatoren en convectoren

Voor meer details over onze artikel-data, zie artikel-database: <https://www.installdata.be>

Voor de warmteafgiftes van andere regimes, kijkt u op p. 370 (correctiefactoren)
BELGIË. Prijzen in euro (excl. BTW)

HOE CARRÉ HORIZONTAAL BESTELLEN

Leveringstermijn 15 - 30 werkdagen
(zonder transportduur)

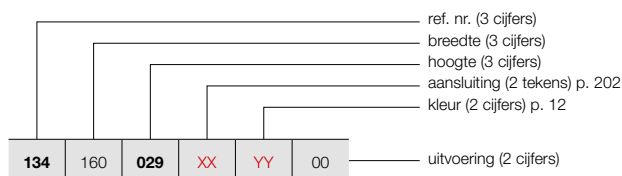

CARRÉ HORIZONTAAL (CPHN2-RO)



CPHN2-RO

PRIJSGROEP: VPG2 - STAAL DESIGNRADIATOREN

BESTELCODE MAATWERK CARRÉ HORIZONTAAL	TECHNISCHE GEGEVENS							STANDAARDKLEUR		ANDERE KLEUREN	
	buizen	breedte (L mm)	hoogte (H mm)	75/65/20 (Watt) (Ø50K)	55/45/20 (Watt) (Ø30K)	n-exp.	gewicht (kg)	inhoud (l)	el. weerst. (Watt)	prijs RAL 9016 (€)	prijs kleur (€)
REF. NR. CARRÉ HORIZONTAAL CPHN2-RO : 134											
134 160 029 XX YY 00	10	1600	295	1006	534	1,24	31,84	16,16	-	954	1097
	12	1600	355	1224	646	1,25	38,02	19,39	-	1145	1317
	14	1600	415	1438	752	1,27	44,19	22,62	-	1334	1534
	16	1600	475	1646	856	1,28	50,37	25,86	-	1527	1756
	18	1600	535	1848	956	1,29	56,54	29,09	-	1719	1977
	20	1600	595	2042	1051	1,30	62,72	32,32	-	1907	2193
	22	1600	655	2229	1147	1,30	68,93	35,71	-	2100	2415
	26	1600	775	2579	1328	1,30	81,34	42,50	-	2482	2854
	30	1600	895	2898	1492	1,30	93,76	49,28	-	2861	3290
	134 180 029 XX YY 00	10	1800	295	1132	601	1,24	35,82	18,18	-	1037
12		1800	355	1377	727	1,25	42,77	21,82	-	1240	1426
14		1800	415	1618	846	1,27	49,72	25,45	-	1446	1663
16		1800	475	1852	963	1,28	56,66	29,09	-	1655	1903
18		1800	535	2079	1076	1,29	63,61	32,72	-	1862	2141
20		1800	595	2297	1182	1,30	70,56	36,36	-	2068	2378
22		1800	655	2507	1290	1,30	77,54	40,18	-	2275	2616
26		1800	775	2902	1494	1,30	91,51	47,81	-	2687	3090
30		1800	895	3260	1678	1,30	105,48	55,44	-	3104	3570
134 200 029 XX YY 00		10	2000	295	1258	668	1,24	39,80	20,20	-	1113
	12	2000	355	1530	808	1,25	47,52	24,24	-	1332	1532
	14	2000	415	1798	940	1,27	55,24	28,28	-	1557	1791
	16	2000	475	2058	1070	1,28	62,96	32,32	-	1777	2044
	18	2000	535	2310	1195	1,29	70,68	36,36	-	2001	2301
	20	2000	595	2552	1314	1,30	78,40	40,40	-	2223	2556
	22	2000	655	2786	1434	1,30	86,16	44,64	-	2445	2812
	26	2000	775	3224	1660	1,30	101,68	53,12	-	2888	3321
	30	2000	895	3622	1864	1,30	117,20	61,60	-	3334	3834
	134 220 029 XX YY 00	10	2200	295	1384	735	1,24	43,78	22,22	-	1188
12		2200	355	1683	889	1,25	52,27	26,66	-	1423	1636
14		2200	415	1978	1034	1,27	60,76	31,11	-	1659	1908
16		2200	475	2264	1177	1,28	69,26	35,55	-	1899	2184
18		2200	535	2541	1315	1,29	77,75	40,00	-	2138	2459
20		2200	595	2807	1445	1,30	86,24	44,44	-	2374	2730
22		2200	655	3065	1578	1,30	94,78	49,10	-	2610	3002
26		2200	775	3546	1825	1,30	111,85	58,43	-	3082	3544
30		2200	895	3984	2051	1,30	128,92	67,76	-	3562	4096
134 240 029 XX YY 00		10	2400	295	1510	801	1,24	47,76	24,24	-	1258
	12	2400	355	1836	970	1,25	57,02	29,09	-	1513	1740
	14	2400	415	2158	1128	1,27	66,29	33,94	-	1764	2029
	16	2400	475	2470	1284	1,28	75,55	38,78	-	2014	2316
	18	2400	535	2772	1434	1,29	84,82	43,63	-	2267	2607
	20	2400	595	3062	1576	1,30	94,08	48,48	-	2519	2897
	22	2400	655	3343	1721	1,30	103,39	53,57	-	2769	3184
	26	2400	775	3869	1992	1,30	122,02	63,74	-	3276	3767

Conform EN442-1: 2014: radiatoren en convectoren

Voor meer details over onze artikel-data, zie artikel-database: <https://www.installdata.be>

Voor de warmteafgiftes van andere regimes, kijkt u op p. 370 (correctiefactoren)
BELGIË. Prijzen in euro (excl. BTW)

CARRÉ HORIZONTAAL (CPHN2-RO)



CPHN2-RO

HOE CARRÉ HORIZONTAAL BESTELLEN

Leveringstermijn 15 - 30 werkdagen
(zonder transportduur)

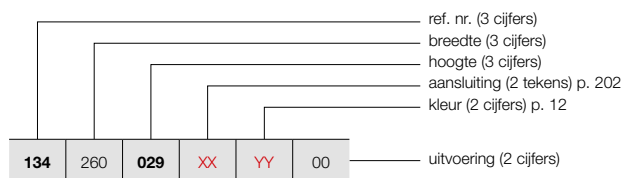

PRIJSGROEP: VPG2 - STAAL DESIGNRADIATOREN

BESTELCODE MAATWERK CARRÉ HORIZONTAAL	TECHNISCHE GEGEVENS									STANDAARDKLEUR	ANDERE KLEUREN
	buizen	breedte (L mm)	hoogte (H mm)	75/65/20 (Watt) (Φ50K)	55/45/20 (Watt) (Φ30K)	n-exp.	gewicht (kg)	inhoud (l)	el. weerst. (Watt)	prijs RAL 9016 (€)	prijs kleur (€)
REF. NR. CARRÉ HORIZONTAAL CPHN2-RO : 134											
134	260	029	XX	YY	00						
		035								1330	1530
		041								1595	1834
		047								1862	2141
		053								2128	2447
		059								2397	2757
		065								2665	3065
		077								2929	3368
										3464	3984
134	280	029	XX	YY	00						
		035								1401	1611
		041								1680	1932
		047								1960	2254
		053								2240	2576
		059								2519	2897
		065								2802	3222
										3081	3543
134	300	029	XX	YY	00						
		035								1470	1691
		041								1762	2026
		047								2056	2364
		053								2349	2701
		059								2643	3039
		065								2933	3373
										3235	3720

Conform EN442-1: 2014: radiatoren en convectoren

Voor meer details over onze artikel-data, zie artikel-database: <https://www.installdata.be>

Voor de warmteafgifte van andere regimes, kijkt u op p. 370 (correctiefactoren)
BELGIË. Prijzen in euro (excl. BTW)





PRIJSGROEP: VPG10 - ACC.

BEVESTIGINGEN	HOOGTE / BREEDTE RADIATOR	KLEUR	ART. NR.	€
CPVN2-ZB / CPHN1-RO / CPHN2-RO				
WANDOPSTELLING	≤ 2400 mm (4 bevestigingen)	RAL 7016	1187 007 0000 7016	42
	≥ 2600 mm (6 bevestigingen)	RAL 7016	1187 008 0000 7016	63

BELGIË. Prijzen in euro (excl. BTW)

CARRÉ ACCESSOIRES
IN OPTIE

PRIJSGROEP: VPG10B - HANDDOEKBEUGELS

ACCESSOIRES	BREEDTE RADIATOR	KLEUR	ART. NR.	€
CPVN-PLUS / CPVN2-ZB / CPHN1-RO / CPHN2-RO				
KNOP VIERKANT 		CHROOM	1183 500 0000 0099	71
	• h = 24 mm; b = 24 mm; d = 65 mm			
CPVN-PLUS / CPVN2-ZB / CPHN1-RO / CPHN2-RO				
HANDDOEKBEUGEL RECHT 		CHROOM	1183 207 0000 0099	200
	• h = 24 mm; b = 720 mm (zelf in te korten); d = 66 mm; a = 48 mm			
CPVN-PLUS / CPVN2-ZB				
HANDDOEKBEUGEL MULTI+ RECHTS 	600 mm	S600	1183 734 0000 0600	215
	600 mm	RAL 9005 ^S	1183 734 0000 9005	215
• h = 70 mm; b = 600 mm (b tablet = 194 mm); e = 176 mm; c = 170 mm;				
• Bevestiging aan de muur, rechts van de radiator.				
CPVN-PLUS / CPVN2-ZB				
HANDDOEKBEUGEL MULTI+ LINKS 	600 mm	S600	1183 735 0000 0600	215
	600 mm	RAL 9005 ^S	1183 735 0000 9005	215
• h = 70 mm; b = 600 mm (b tablet = 194 mm); e = 176 mm; c = 170 mm;				
• Bevestiging aan de muur, links van de radiator.				

^S structuur zwart

Montagevoorschriften accessoires: zie www.vasco.eu

BELGIË. Prijzen in euro (excl. BTW)

e = afstand voorkant accessoire tot wand
d = afstand voorkant accessoire tot voorkant radiator
c = afstand wand tot achterkant beugel
a = afstand accessoire tot radiator
uit voorraad leverbaar

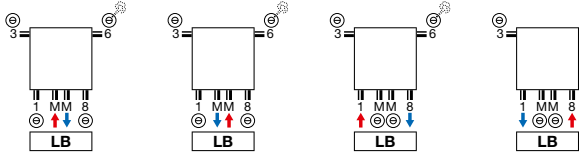
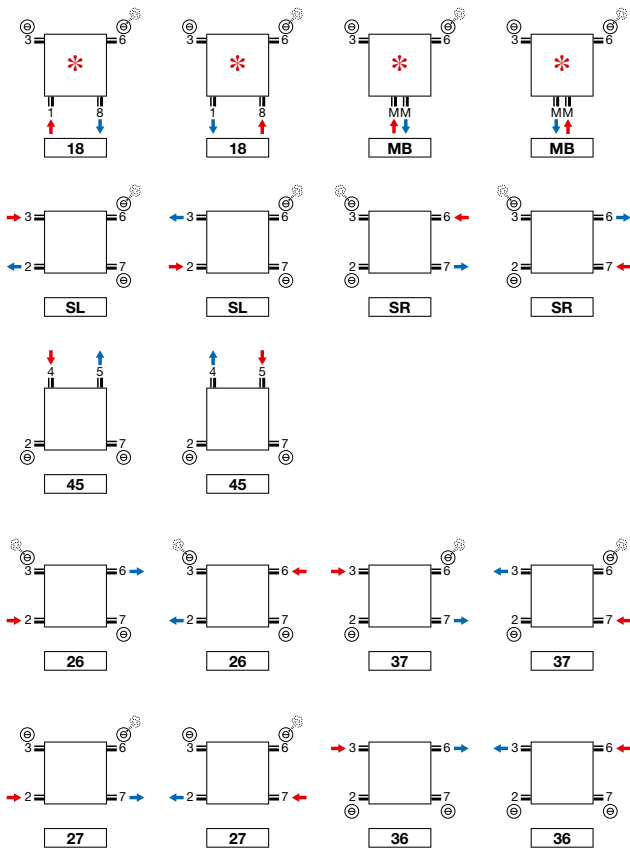
CARRÉ PLUS VERTICAAL: CPVN-PLUS (VOORRAAD)**CARRÉ VERTICAAL: CPVN2-ZB****CARRÉ PLUS VERTICAAL: CPVN-PLUS (NIET-VOORRAAD)****CARRÉ VERTICAAL: CPVN2-ZB**

* **Opmerking CPVN-PLUS/CPVN2-ZB 10 buizen:** 2/3/6/7 altijd open.

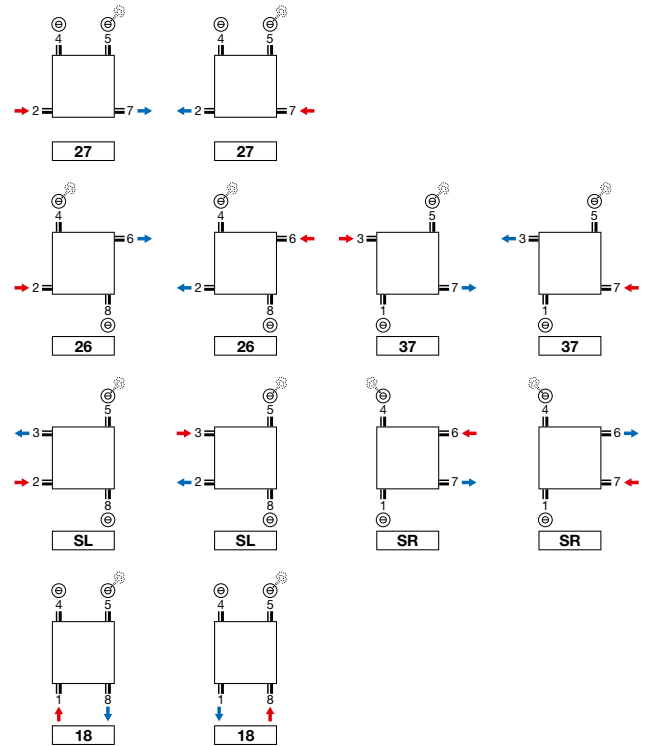
CARRÉ HORIZONTAAL: CPHN1-RO / CPHN2-RO

Opmerking: het aansluiten van de radiator kan enkel volgens de getoonde aansluiticonen. Voor elke andere aansluitwijze nemen wij geen verantwoordelijkheid.

CARRÉ PLUS VERTICAAL (CPVN-PLUS)

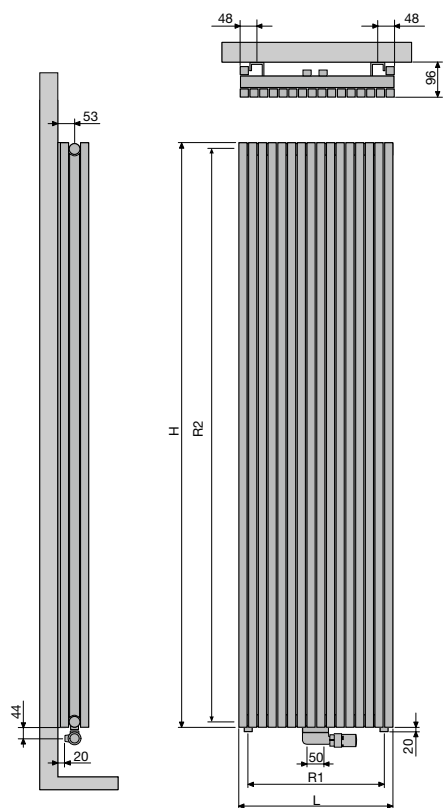

		CPVN-PLUS									
	Aantal buizen	10	12	14	16	18	20	22	26	30	
	Breedte (L)	295	355	415	475	535	595	655	775	895	
	Hartafstand tussen de onderaansluitingen 18 (R1)	240	300	360	420	480	540	600	720	840	
	Hoogte (H)	1400	1600	1800	2000	2200					
	Hartafstand tussen de zijansluitingen SL/SR (R2)	1365	1565	1765	1965	2165					
	Hartafstand tussen de ophangingen	L-200	H-290								

CARRÉ VERTICAAL (CPVN2-ZB)

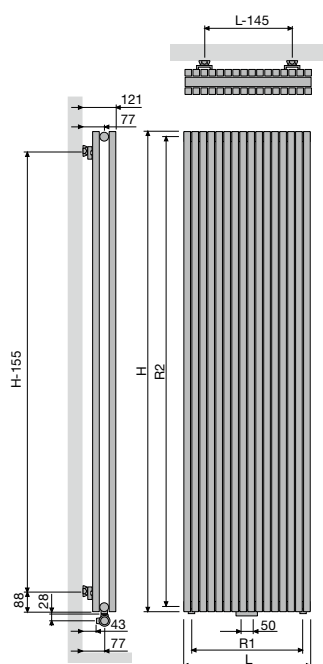

		CPVN2-ZB									
	Aantal buizen	10	12	14	16	18	20	22	26	30	
	Breedte (L)	295	355	415	475	535	595	655	775	895	
	Hartafstand tussen de onderaansluitingen 18 (R1)	240	300	360	420	480	540	600	720	840	
	Hoogte (H)	1400	1600	1800	2000	2200	2400	2600	2800	3000	
	Hartafstand tussen de zijansluitingen SL/SR (R2)	1365	1565	1765	1965	2165	2365	2565	2765	2965	
	Hartafstand tussen de ophangingen	L-145	H-155								

BUIZEN

- VV: Verticaal, rechthoekig 45 x 20 mm

KLEUREN

- Standaardkleur wit RAL 9016
- Uitgebreide kleurenkaart zie p. 12

SPECIAAL

- De Arche is bekroond met Design Plus Award 2005, Reddot Design Award 2006, Silver Award Designpreis Deutschland 2006 en genomineerd voor de Henry van de Velde prijs 2005.

BEVESTIGINGEN

- Muurbevestigingen standaard (telescopisch)

TECHNISCH

- ATL-grondlaag, poedercoating
- Standaardwerkdruk: 4 bar
- Maximale bedrijfstemperatuur: 110°C

ELEKTRISCH

- ✗ Zuiver elektrische radiator in de fabriek vorgevuld
- ✗ Gemengde radiator

TECHNISCHE TEKENINGEN

- Zie p. 210

AANSLUITING

- ✗ Eénpuntsaansluiting voor éénpijpsysteem
- ✗ Eénpuntsaansluiting voor tweepijpsysteem
- ✓ Tweepuntsaansluiting voor éénpijpsysteem (aansluiting via de middenaansluiting) (zie p. 362)
- ✓ Tweepuntsaansluiting voor tweepijpsysteem (standaard) (zie p. 362)
- ✗ Geïntegreerd ventiel
- Aansluitingen: 1/2" (binnendraad)

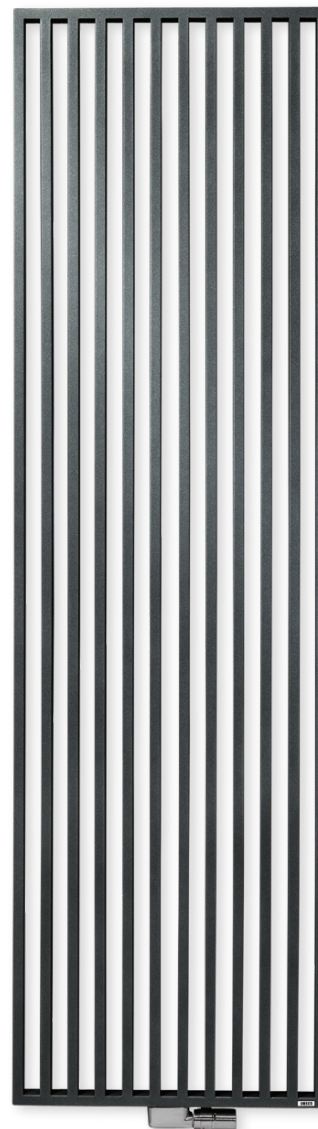

STAAL DESIGNRADIATOREN

AANBEVOLEN AANSLUITING (LB)

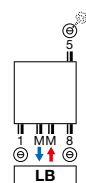

Andere aansluitmogelijkheden, zie p. 209



art. nr. 1182 103 0000 0099

prijs €190

Koppelingen, zie p. 377

**AANBEVOLEN VOOR BADKAMER EN KEUKEN
IN OPTIE**



handdoekbeugel (chrom) art. nr. zie p. 209

prijs €200

Andere accessoires, zie p. 209

ARCHE VERTICAAL

Techniek en esthetiek naadloos verenigd

Een designradiatorconcept, enig in zijn soort. De buizen zijn niet op, maar in elkaar gemonteerd en vormen samen één naadloze, vlakke structuur. Ook de accessoires zijn mooi in het geheel geïntegreerd. Die perfecte verstandhouding tussen techniek en esthetiek leveren een uniek product op dat inmiddels zowat alle belangrijke designprijzen heeft weggekaapt en ook beschikbaar is in een badkameruitvoering met middenaansluiting.



TYPES

- VVR (beugel rechts), VVL (beugel links)

BUIZEN

- Verticaal, rechthoekig 45 x 20 mm

KLEUREN

- Standaardkleur wit RAL 9016
- Uitgebreide kleurenkaart zie p. 12

SPECIAAL

- Vaste handdoekbeugel in de kleur van de radiator
- Opgelet: deze beugel wordt niet warm!

BEVESTIGINGEN

- Muurbevestigingen standaard (telescopisch)

TECHNISCH

- ATL-grondlaag, poedercoating
- Standaardwerkdruk: 4 bar
- Maximale bedrijfstemperatuur: 110°C

ELEKTRISCH

- ✗ Zuiver elektrische radiator in de fabriek voorgevuld
- ✗ Gemengde radiator

TECHNISCHE TEKENINGEN

- Zie p. 210

AANSLUITING

- ✗ Eénpuntsaansluiting voor éénpijpsysteem
- ✗ Eénpuntsaansluiting voor tweepijpsysteem
- ✓ Tweepuntsaansluiting voor éénpijpsysteem (aansluiting via de middenaansluiting) (zie p. 362)
- ✓ Tweepuntsaansluiting voor tweepijpsysteem (standaard) (zie p. 362)
- ✗ Geïntegreerd ventiel
- Aansluitingen: 1/2" (binnendraad)

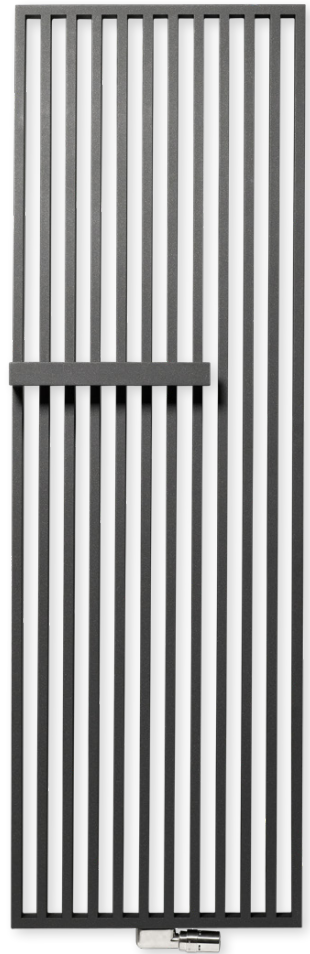

STAAL DESIGNRADIATOREN

AANBEVOLEN AANSLUITING (LB)

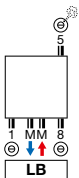

Andere aansluitmogelijkheden, zie p. 209



art. nr. 1182 103 0000 0099

prijs €190

Koppelingen, zie p. 377

ARCHE PLUS VERTICAAL

Functioneel mooi over de hele lijn

Een designradiator waarbij de unieke, vlakke vormgeving van de Arche wordt aangevuld met een naadloos op de structuur gelaste handdoekbeugel. Samen vormen ze een mooi afgewerkt geheel dat de perfecte verstandhouding tussen de Arche vormgeving en functionaliteit extra benadrukt.



ARCHE PLUS VERTICAAL (VWL, VVR)

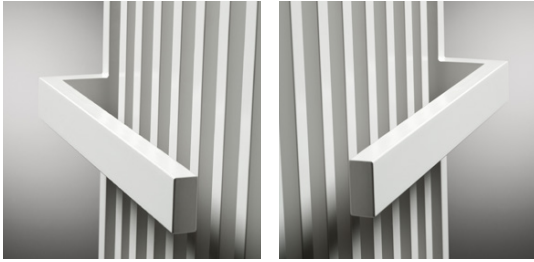

VWL

VVR

HOE ARCHE PLUS VERTICAAL BESTELLEN

Leveringstermijn 15 - 30 werkdagen
(zonder transportduur)

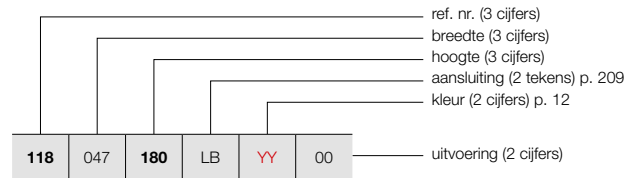

HOE VOORRAADRADIATOR ARCHE PLUS VERTICAAL BESTELLEN

Leveringstermijn 5 werkdagen
(zonder transportduur)

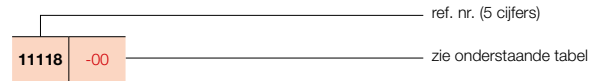



PRIJSGROEP: VPG2 - STAAL DESIGNRADIATOREN

BESTELCODE MAATWERK ARCHE PLUS VERTICAAL	TECHNISCHE GEGEVENS									STANDAARDKLEUR		ANDERE KLEUREN prijs kleur (€)
	buizen	breedte (L mm)	hoogte (H mm)	75/65/20 (Watt (Φ50K))	55/45/20 (Watt (Φ30K))	n-exp.	gewicht (kg)	inhoud (l)	el. weerst. (Watt)	prijs RAL 9016 (€)	verkorte ref. nr. RAL 9016 voorraad	
REF. NR. ARCHE PLUS VERTICAAL VWL : 118												
118 047 180 200 220 LB YY 00	10	470	1800	1050	560	1,23	23,49	13,94	-	779	11118-01	896
	10	470	2000	1164	618	1,24	25,95	15,42	-	832	-	957
	10	470	2200	1279	679	1,24	28,40	16,91	-	876	-	1007
118 057 180 200 220 LB YY 00	12	570	1800	1273	679	1,23	28,44	16,90	-	943	-	1084
	12	570	2000	1412	749	1,24	31,42	18,70	-	1008	-	1159
	12	570	2200	1552	824	1,24	34,40	20,50	-	1064	-	1224
118 067 180 200 220 LB YY 00	14	670	1800	1496	798	1,23	33,39	19,87	-	1110	-	1277
	14	670	2000	1660	881	1,24	36,89	21,98	-	1187	-	1365
	14	670	2200	1824	968	1,24	40,39	24,10	-	1248	-	1435
REF. NR. ARCHE PLUS VERTICAAL VVR : 119												
119 047 180 200 220 LB YY 00	10	470	1800	1050	560	1,23	23,49	13,94	-	779	11119-01	896
	10	470	2000	1164	618	1,24	25,95	15,42	-	832	-	957
	10	470	2200	1279	679	1,24	28,40	16,91	-	876	-	1007
119 057 180 200 220 LB YY 00	12	570	1800	1273	679	1,23	28,44	16,90	-	943	-	1084
	12	570	2000	1412	749	1,24	31,42	18,70	-	1008	-	1159
	12	570	2200	1552	824	1,24	34,40	20,50	-	1064	-	1224
119 067 180 200 220 LB YY 00	14	670	1800	1496	798	1,23	33,39	19,87	-	1110	-	1277
	14	670	2000	1660	881	1,24	36,89	21,98	-	1187	-	1365
	14	670	2200	1824	968	1,24	40,39	24,10	-	1248	-	1435

Conform EN442-1: 2014: radiatoren en convectoren

Voor meer details over onze artikel-data, zie artikel-database: <https://www.installdata.be>
Voor de warmteafgiftes van andere regimes, kijkt u op p. 370 (correctiefactoren)
BELGIË. Prijzen in euro (excl. BTW)

PRIJSGROEP: VPG10B - HANDDOEKBEUGELS

ACCESSOIRES		KLEUR	ART. NR.	€
KNOP		VV / VWL / VWR		
		CHROOM	11834100000099	94
HANDDOEKBEUGEL		W		
		CHROOM	11832280000099	200

- h = 70 mm; b = 70 mm; d = 59 mm; a = 51 mm;

- h = 22 mm; b = 720 mm (zelf in te korten) d = 75 mm; a = 56 mm

Montagevoorschriften accessoires: zie www.vasco.eu
BELGIË. Prijzen in euro (excl. BTW)

d = afstand voorkant accessoire tot voorkant radiator
a = afstand accessoire tot radiator
uit voorraad leverbaar

ARCHE AANSLUITINGEN

ARCHE VERTICAAL: W
ARCHE PLUS VERTICAAL: VWL / VWR

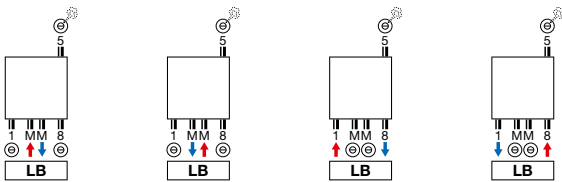

Opmerking: het aansluiten van de radiator kan enkel volgens de getoonde aansluiticonen. Voor elke andere aansluitwijze nemen wij geen verantwoordelijkheid.

ARCHE VERTICAAL (VV)

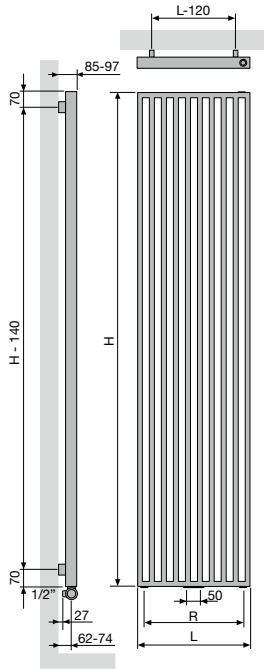

	VV		
Aantal buizen	10	12	14
Breedte (L)	470	570	670
Hartafstand tussen de onderaansluitingen 18 (R)	370	470	570
Hartafstand tussen de ophangingen	L-120	H-140	

ARCHE PLUS VERTICAAL (WL, VWR)

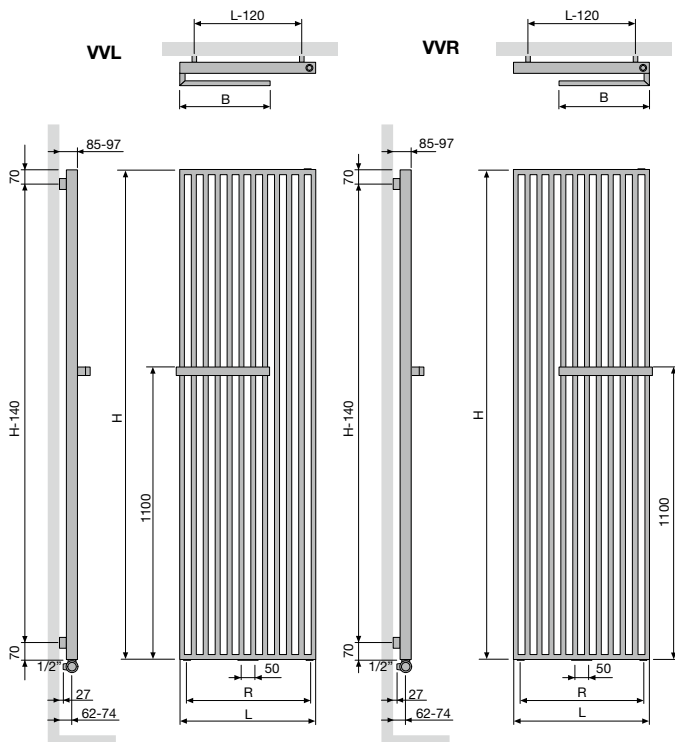

	WL / VWR		
Aantal buizen	10	12	14
Breedte (L)	470	570	670
Hartafstand tussen de onderaansluitingen 18 (R)	370	470	570
Breedte handdoekbeugel (B)	335	385	435
Hartafstand tussen de ophangingen	L-120	H-140	

TYPES

- Eén (ZV-1) of twee rijen buizen (ZV-2)

BUIZEN

- Verticaal, rechthoekig 45 x 20 mm

COLLECTOREN

- Horizontaal, achterliggend, rond Ø 35 mm

KLEUREN

- Standaardkleur wit RAL 9016
- Uitgebreide kleurenkaart zie p. 12

BEVESTIGINGEN

- Muurbevestigingen standaard

TECHNISCH

- Elektrisch lasergelast (onzichtbare lasnaden)
- ATL-grondlaag, poedercoating
- Standaardwerkdruk: 4 bar
- Maximale bedrijfstemperatuur: 110°C

ELEKTRISCH

- ✗ Zuiver elektrische radiator in de fabriek voorgevuld
- ✗ Gemengde radiator

TECHNISCHE TEKENINGEN

- Zie p. 223

AANSLUITING

- ✗ Eénpuntsaansluiting voor éénpijpsysteem
- ✗ Eénpuntsaansluiting voor tweepijpsysteem
- ✓ Tweepuntsaansluiting voor éénpijpsysteem (aansluiting via de middenaansluiting) (zie p. 362)
- ✓ Tweepuntsaansluiting voor tweepijpsysteem (standaard) (zie p. 362)
- ✗ Geïntegreerd ventiel
- Aansluitingen: 1/2" (binnendraad)

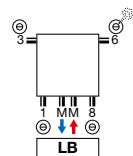
**AANBEVOLEN AANSLUITING (LB)**

Andere aansluitmogelijkheden, zie p. 222



art. nr. 1182 103 0000 0099

prijs €190

Koppelingen, zie p. 377

**AANBEVOLEN VOOR BADKAMER EN KEUKEN
IN OPTIE**

handdoekbeugel recht (chrom) art. nr. zie p. 221

prijs €200

Andere accessoires, zie p. 221

ZANA VERTICAAL**Traditie en trends in perfecte harmonie**

De Zana combineert een onklopbaar vermogen met een tijdloze lijnvoering. Een klassieker die blijft bekoren door zijn kracht, zijn klasse en zijn comfort. Het retrogevoel is nooit ver weg. Maar ook de moderniteit is volop aanwezig in dit unieke gamma designradiatoren voor elke woonomgeving, elke ruimte, elke toepassing.



ZANA VERTICAAL (ZV-1)



ZV-1

HOE ZANA VERTICAAL BESTELLEN

Leveringstermijn 15 - 30 werkdagen
(zonder transportduur)

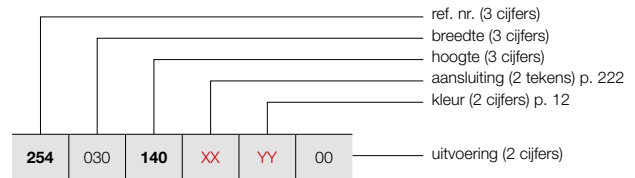

HOE VOORRAADRADIATOR ZANA VERTICAAL BESTELLEN

Leveringstermijn 5 werkdagen
(zonder transportduur)

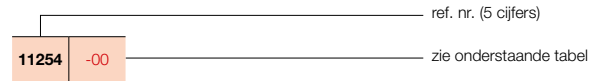

PRIJSGROEP: VPG2 - STAAL DESIGNRADIATOREN

BESTELCODE MAATWERK ZANA VERTICAAL	TECHNISCHE GEGEVENS									STANDAARDKLEUR		ANDERE KLEUREN
	buizen	breedte (L mm)	hoogte (H mm)	75/65/20 (Watt) (Φ50K)	55/45/20 (Watt) (Φ30K)	n-exp.	gewicht (kg)	inhoud (l)	el. weerst. (Watt)	prijs RAL 9016 (€)	verkorte ref. nr. RAL 9016 voorraad	
REF. NR. ZANA VERTICAAL ZV-1 : 254												
254 030 140 XX YY 00	8	304	1400	680	359	1,27	18,16	8,24	-	489	-	562
	8	304	1600	769	406	1,27	20,72	9,44	-	530	-	610
	8	304	1800	859	454	1,28	23,20	10,64	-	574	-	660
	8	304	2000	950	502	1,28	25,68	11,68	-	617	-	710
	8	304	2200	1042	550	1,28	28,08	12,72	-	659	-	758
	8	304	2400	1136	600	1,29	30,56	13,76	-	703	-	808
	8	304	2600	1231	650	1,29	33,04	14,80	-	748	-	860
	8	304	2800	1327	701	1,29	35,44	15,84	-	787	-	905
	8	304	3000	1426	753	1,29	37,92	16,88	-	830	-	955
254 038 140 XX YY 00	10	384	1400	850	449	1,27	22,70	10,30	-	586	-	674
	10	384	1600	962	508	1,27	25,90	11,80	-	643	-	739
	10	384	1800	1074	567	1,28	29,00	13,30	-	695	11254-03	799
	10	384	2000	1188	627	1,28	32,10	14,60	-	750	-	863
	10	384	2200	1303	688	1,28	35,10	15,90	-	802	-	922
	10	384	2400	1420	750	1,29	38,20	17,20	-	853	-	981
	10	384	2600	1539	813	1,29	41,30	18,50	-	907	-	1043
	10	384	2800	1659	876	1,29	44,30	19,80	-	961	-	1105
	10	384	3000	1782	941	1,29	47,40	21,10	-	1011	-	1163
254 046 140 XX YY 00	12	464	1400	1020	539	1,27	27,24	12,36	-	684	-	787
	12	464	1600	1154	609	1,27	31,08	14,16	-	751	-	864
	12	464	1800	1289	681	1,28	34,80	15,96	-	814	11254-12	936
	12	464	2000	1425	752	1,28	38,52	17,52	-	877	11254-01	1009
	12	464	2200	1563	825	1,28	42,12	19,08	-	942	-	1083
	12	464	2400	1704	900	1,29	45,84	20,64	-	1005	-	1156
	12	464	2600	1846	975	1,29	49,56	22,20	-	1069	-	1229
	12	464	2800	1991	1051	1,29	53,16	23,76	-	1134	-	1304
	12	464	3000	2139	1130	1,29	56,88	25,32	-	1198	-	1378
254 054 140 XX YY 00	14	544	1400	1190	628	1,27	31,78	14,42	-	785	-	903
	14	544	1600	1346	711	1,27	36,26	16,52	-	859	-	988
	14	544	1800	1504	794	1,28	40,60	18,62	-	930	11254-07	1070
	14	544	2000	1663	878	1,28	44,94	20,44	-	1006	11254-08	1157
	14	544	2200	1824	963	1,28	49,14	22,26	-	1082	-	1244
	14	544	2400	1988	1050	1,29	53,48	24,08	-	1156	-	1329
	14	544	2600	2154	1137	1,29	57,82	25,90	-	1231	-	1416
	14	544	2800	2323	1227	1,29	62,02	27,72	-	1307	-	1503
	14	544	3000	2495	1318	1,29	66,36	29,54	-	1381	-	1588
254 062 140 XX YY 00	16	624	1400	1360	718	1,27	36,32	16,48	-	881	-	1013
	16	624	1600	1539	813	1,27	41,44	18,88	-	967	-	1112
	16	624	1800	1719	908	1,28	46,40	21,28	-	1052	11254-09	1210
	16	624	2000	1900	1003	1,28	51,36	23,36	-	1138	11254-02	1309
	16	624	2200	2085	1101	1,28	56,16	25,44	-	1226	-	1410
	16	624	2400	2272	1200	1,29	61,12	27,52	-	1309	-	1505
	16	624	2600	2462	1300	1,29	66,08	29,60	-	1395	-	1604
	16	624	2800	2655	1402	1,29	70,88	31,68	-	1480	-	1702
	16	624	3000	2852	1506	1,29	75,84	33,76	-	1565	-	1800

Conform EN442-1: 2014: radiatoren en convectoren

Voor meer details over onze artikel-data, zie artikel-database: <https://www.installdata.be>

Voor de warmteafgiftes van andere regimes, kijkt u op p. 370 (correctiefactoren)
BELGIË. Prijzen in euro (excl. BTW)

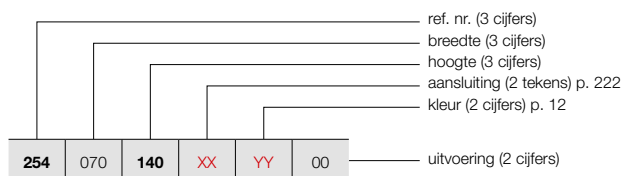

ZV-1

PRIJSGROEP: VPG2 - STAAL DESIGNRADIATOREN

BESTELCODE MAATWERK ZANA VERTICAAL	TECHNISCHE GEGEVENS							STANDAARDKLEUR		ANDERE KLEUREN						
	buizen	breedte (L mm)	hoogte (H mm)	75/65/20 (Watt) (φ50K)	55/45/20 (Watt) (φ30K)	n-exp.	gewicht (kg)	inhoud (l)	el. weerst. (Watt)	prijs RAL 9016 (€)	prijs kleur (€)					
REF. NR. ZANA VERTICAAL ZV-1 : 254																
254	070	140	XX	YY	00	18	704	1400	1531	808	1,27	40,86	18,54	-	979	1126
		160				18	704	1600	1731	914	1,27	46,62	21,24	-	1074	1235
		180				18	704	1800	1933	1021	1,28	52,20	23,94	-	1169	1344
		200				18	704	2000	2138	1129	1,28	57,78	26,28	-	1271	1462
		220				18	704	2200	2345	1238	1,28	63,18	28,62	-	1365	1570
		240				18	704	2400	2555	1349	1,29	68,76	30,96	-	1461	1680
		260				18	704	2600	2769	1462	1,29	74,34	33,30	-	1553	1786
		280				18	704	2800	2987	1577	1,29	79,74	35,64	-	1653	1901
		300				18	704	3000	3208	1694	1,29	85,32	37,98	-	1748	2010
		254				078	140	XX	YY	00	20	784	1400	1701	898	1,27
160	20		784	1600	1923		1015				1,27	51,80	23,60	-	1186	1364
180	20		784	1800	2148		1134				1,28	58,00	26,60	-	1292	1486
200	20		784	2000	2375		1254				1,28	64,20	29,20	-	1397	1607
220	20		784	2200	2606		1376				1,28	70,20	31,80	-	1504	1730
240	20		784	2400	2839		1499				1,29	76,40	34,40	-	1612	1854
260	20		784	2600	3077		1625				1,29	82,60	37,00	-	1720	1978
280	20		784	2800	3319		1753				1,29	88,60	39,60	-	1827	2101
300	20		784	3000	3564		1882				1,29	94,80	42,20	-	1930	2220
254	086		140	XX	YY		00				22	864	1400	1871	988	1,27
		160	22			864		1600	2116	1117	1,27	56,98	25,96	-	1293	1487
		180	22			864		1800	2363	1248	1,28	63,80	29,26	-	1409	1620
		200	22			864		2000	2613	1380	1,28	70,62	32,12	-	1527	1756
		220	22			864		2200	2866	1513	1,28	77,22	34,98	-	1645	1892
		240	22			864		2400	3123	1649	1,29	84,04	37,84	-	1763	2027
		260	22			864		2600	3385	1788	1,29	90,86	40,70	-	1881	2163
		280	22			864		2800	3650	1927	1,29	97,46	43,56	-	1999	2299
		300	22			864		3000	3921	2071	1,29	104,28	46,42	-	2115	2432
		254	094			140		XX	YY	00	24	944	1400	2041	1078	1,27
160	24			944	1600	2308	1219				1,27	62,16	28,32	-	1402	1612
180	24			944	1800	2578	1361				1,28	69,60	31,92	-	1529	1758
200	24			944	2000	2850	1505				1,28	77,04	35,04	-	1657	1906
220	24			944	2200	3127	1651				1,28	84,24	38,16	-	1787	2055
240	24			944	2400	3407	1799				1,29	91,68	41,28	-	1914	2201
260	24			944	2600	3692	1950				1,29	99,12	44,40	-	2045	2352
280	24			944	2800	3982	2103				1,29	106,32	47,52	-	2170	2496
300	24			944	3000	4277	2259				1,29	113,76	50,64	-	2300	2645
254	102			140	XX	YY	00				26	1024	1400	2211	1168	1,27
		160	26	1024				1600	2500	1320	1,27	67,34	30,68	-	1511	1738
		180	26	1024				1800	2793	1475	1,28	75,40	34,58	-	1649	1896
		200	26	1024				2000	3088	1631	1,28	83,46	37,96	-	1791	2060
		220	26	1024				2200	3388	1789	1,28	91,26	41,34	-	1926	2215
		240	26	1024				2400	3691	1949	1,29	99,32	44,72	-	2066	2376
		260	26	1024				2600	4000	2112	1,29	107,38	48,10	-	2205	2536
		280	26	1024				2800	4314	2278	1,29	115,18	51,48	-	2344	2696
		300	26	1024				3000	4634	2447	1,29	123,24	54,86	-	2482	2854

ZANA VERTICAAL (ZV-2)



ZV-2

HOE ZANA VERTICAAL BESTELLEN

Leveringstermijn 15 - 30 werkdagen
(zonder transportduur)

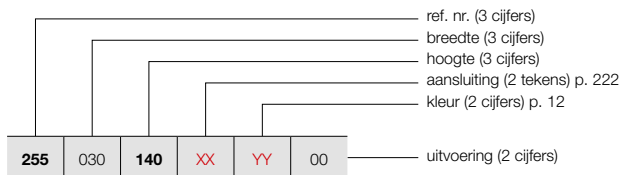

HOE VOORRAADRADIATOR ZANA VERTICAAL BESTELLEN

Leveringstermijn 5 werkdagen
(zonder transportduur)

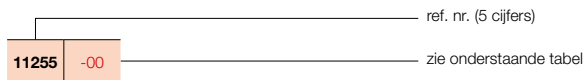

PRIJSGROEP: VPG2 - STAAL DESIGNRADIATOREN

BESTELCODE MAATWERK ZANA VERTICAAL	TECHNISCHE GEGEVENS									STANDAARDKLEUR		ANDERE KLEUREN prijs kleur (€)
	buizen	breedte (L mm)	hoogte (H mm)	75/65/20 (Watt) (Φ50K)	55/45/20 (Watt) (Φ30K)	n-exp.	gewicht (kg)	inhoud (l)	el. weerst. (Watt)	prijs RAL 9016 (€)	verkorte ref. nr. RAL 9016 voorraad	
REF. NR. ZANA VERTICAAL ZV-2 : 255												
255 030 140 XX YY 00	8	304	1400	1105	584	1,30	35,20	16,16	-	831	-	956
	8	304	1600	1242	656	1,30	40,16	18,40	-	903	-	1038
	8	304	1800	1379	728	1,30	45,12	20,64	-	976	-	1122
	8	304	2000	1515	800	1,30	50,00	23,28	-	1050	-	1208
	8	304	2200	1651	872	1,30	54,80	25,92	-	1118	-	1286
	8	304	2400	1788	944	1,30	59,68	28,56	-	1192	-	1371
	8	304	2600	1925	1017	1,30	64,48	31,12	-	1271	-	1462
	8	304	2800	2062	1089	1,30	69,36	33,76	-	1336	-	1536
	8	304	3000	2200	1162	1,30	74,16	36,40	-	1409	-	1620
255 038 140 XX YY 00	10	384	1400	1381	729	1,30	44,00	20,20	-	1000	-	1150
	10	384	1600	1553	820	1,30	50,20	23,00	-	1090	-	1254
	10	384	1800	1724	910	1,30	56,40	25,80	-	1180	-	1357
	10	384	2000	1894	1000	1,30	62,50	29,10	-	1272	-	1463
	10	384	2200	2064	1090	1,30	68,50	32,40	-	1362	-	1566
	10	384	2400	2235	1180	1,30	74,60	35,70	-	1449	-	1666
	10	384	2600	2406	1271	1,30	80,60	38,90	-	1543	-	1774
	10	384	2800	2577	1361	1,30	86,70	42,20	-	1632	-	1877
	10	384	3000	2750	1452	1,30	92,70	45,50	-	1722	-	1980
255 046 140 XX YY 00	12	464	1400	1657	875	1,30	52,80	24,24	-	1164	-	1339
	12	464	1600	1863	984	1,30	60,24	27,60	-	1274	-	1465
	12	464	1800	2068	1092	1,30	67,68	30,96	-	1385	-	1593
	12	464	2000	2273	1200	1,30	75,00	34,92	-	1490	-	1714
	12	464	2200	2477	1308	1,30	82,20	38,88	-	1598	-	1838
	12	464	2400	2682	1416	1,30	89,52	42,84	-	1710	-	1967
	12	464	2600	2887	1525	1,30	96,72	46,68	-	1816	-	2088
	12	464	2800	3093	1633	1,30	104,04	50,64	-	1926	-	2215
	12	464	3000	3300	1743	1,30	111,24	54,60	-	2036	-	2341
255 054 140 XX YY 00	14	544	1400	1933	1021	1,30	61,60	28,28	-	1332	-	1532
	14	544	1600	2174	1148	1,30	70,28	32,20	-	1461	-	1680
	14	544	1800	2413	1274	1,30	78,96	36,12	-	1584	-	1822
	14	544	2000	2651	1400	1,30	87,50	40,74	-	1713	11255-02	1970
	14	544	2200	2890	1526	1,30	95,90	45,36	-	1838	-	2114
	14	544	2400	3129	1652	1,30	104,44	49,98	-	1966	-	2261
	14	544	2600	3368	1779	1,30	112,84	54,46	-	2093	-	2407
	14	544	2800	3608	1905	1,30	121,38	59,08	-	2222	-	2555
	14	544	3000	3849	2033	1,30	129,78	63,70	-	2348	-	2700
255 062 140 XX YY 00	16	624	1400	2209	1167	1,30	70,40	32,32	-	1496	-	1720
	16	624	1600	2484	1312	1,30	80,32	36,80	-	1643	-	1889
	16	624	1800	2758	1456	1,30	90,24	41,28	-	1787	-	2055
	16	624	2000	3030	1600	1,30	100,00	46,56	-	1936	-	2226
	16	624	2200	3303	1744	1,30	109,60	51,84	-	2081	-	2393
	16	624	2400	3576	1888	1,30	119,36	57,12	-	2223	-	2556
	16	624	2600	3849	2033	1,30	128,96	62,24	-	2371	-	2727
	16	624	2800	4124	2178	1,30	138,72	67,52	-	2514	-	2891
	16	624	3000	4399	2323	1,30	148,32	72,80	-	2662	-	3061

Conform EN442-1: 2014: radiatoren en convectoren

Voor meer details over onze artikel-data, zie artikel-database: <https://www.installdata.be>
Voor de warmteafgifte van andere regimes, kijkt u op p. 370 (correctiefactoren)
BELGIË. Prijzen in euro (excl. BTW)

HOE ZANA VERTICAAL BESTELLEN
Leveringstermijn 15 - 30 werkdagen
(zonder transportduur)

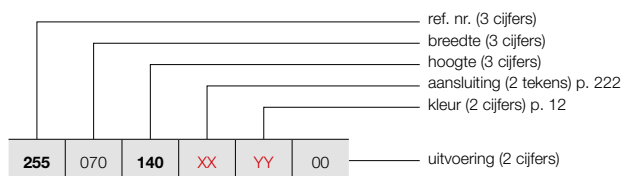

ZANA VERTICAAL (ZV-2)



ZV-2

HOE VOORRAADRADIATOR ZANA VERTICAAL BESTELLEN

Leveringstermijn 5 werkdagen
(zonder transportduur)

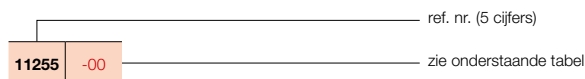

PRIJSGROEP: VPG2 - STAAL DESIGNRADIATOREN

BESTELCODE MAATWERK ZANA VERTICAAL	TECHNISCHE GEGEVENS								STANDAARDKLEUR		ANDERE KLEUREN	
	buizen	breedte (L mm)	hoogte (H mm)	75/65/20 (Watt) (Φ50K)	55/45/20 (Watt) (Φ30K)	n-exp.	gewicht (kg)	inhoud (l)	el. weerst. (Watt)	prijs RAL 9016 (€)		verkorte ref. nr. RAL 9016 voorraad
REF. NR. ZANA VERTICAAL ZV-2 : 255												
255 070 140 XX YY 00	18	704	1400	2486	1313	1,30	79,20	36,36	-	1668	-	1918
	18	704	1600	2795	1476	1,30	90,36	41,40	-	1829	-	2103
	18	704	1800	3102	1638	1,30	101,52	46,44	-	1992	-	2291
	18	704	2000	3409	1800	1,30	112,50	52,38	-	2155	11255-01	2478
	18	704	2200	3716	1962	1,30	123,30	58,32	-	2319	-	2667
	18	704	2400	4023	2124	1,30	134,28	64,26	-	2481	-	2853
	18	704	2600	4330	2287	1,30	145,08	70,02	-	2644	-	3041
	18	704	2800	4639	2450	1,30	156,06	75,96	-	2809	-	3230
255 078 140 XX YY 00	20	784	1400	2762	1459	1,30	88,00	40,40	-	1834	-	2109
	20	784	1600	3105	1640	1,30	100,40	46,00	-	2013	-	2315
	20	784	1800	3447	1820	1,30	112,80	51,60	-	2195	-	2524
	20	784	2000	3788	2000	1,30	125,00	58,20	-	2376	-	2732
	20	784	2200	4129	2180	1,30	137,00	64,80	-	2556	-	2939
	20	784	2400	4470	2360	1,30	149,20	71,40	-	2741	-	3152
	20	784	2600	4812	2541	1,30	161,20	77,80	-	2922	-	3360
255 086 140 XX YY 00	22	864	1400	3038	1604	1,30	96,80	44,44	-	2000	-	2300
	22	864	1600	3416	1804	1,30	110,44	50,60	-	2197	-	2527
	22	864	1800	3792	2002	1,30	124,08	56,76	-	2398	-	2758
	22	864	2000	4167	2200	1,30	137,50	64,02	-	2596	-	2985
	22	864	2200	4541	2398	1,30	150,70	71,28	-	2799	-	3219
255 094 140 XX YY 00	24	944	1400	3314	1750	1,30	105,60	48,48	-	2165	-	2490
	24	944	1600	3726	1968	1,30	120,48	55,20	-	2386	-	2744
	24	944	1800	4136	2184	1,30	135,36	61,92	-	2601	-	2991
	24	944	2000	4545	2400	1,30	150,00	69,84	-	2822	-	3245
255 102 140 XX YY 00	26	1024	1400	3590	1896	1,30	114,40	52,52	-	2336	-	2686
	26	1024	1600	4037	2132	1,30	130,52	59,80	-	2570	-	2956
	26	1024	1800	4481	2366	1,30	146,64	67,08	-	2805	-	3226

Conform EN442-1: 2014: radiatoren en convectoren

Voor meer details over onze artikel-data, zie artikel-database: <https://www.installdata.be>

Voor de warmteafgiftes van andere regimes, kijkt u op p. 370 (correctiefactoren)

BELGIË. Prijzen in euro (excl. BTW)

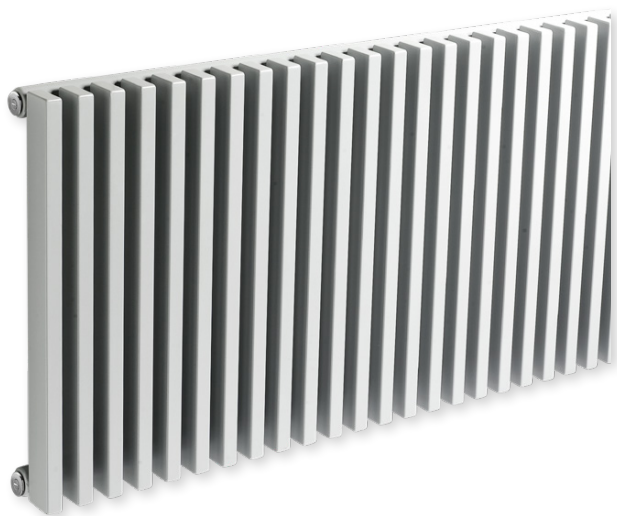

TYPES

- Eén (ZH-1) of twee rijen buizen (ZH-2)

BUIZEN

- Verticaal, rechthoekig 45 x 20 mm
- Opgelet: horizontale vormgeving, maar steeds met verticale buizen!

COLLECTOREN

- Horizontaal, achterliggend, rond Ø 35 mm

KLEUREN

- Standaardkleur wit RAL 9016
- Uitgebreide kleurenkaart zie p. 12

SPECIAAL

- ZH-1 ook verkrijgbaar als toiletradiator (384 x 500 mm)

BEVESTIGINGEN

- Muurbevestigingen standaard

TECHNISCH

- Elektrisch lasergelast (onzichtbare lasnaden)
- ATL-grondlaag, poedercoating
- Standaardwerkdruk: 4 bar
- Maximale bedrijfstemperatuur: 110°C

ELEKTRISCH

- ✗ Zuiver elektrische radiator in de fabriek voorgevuld
- ✗ Gemengde radiator

TECHNISCHE TEKENINGEN

- Zie p. 223

AANSLUITING

- ✗ Eénpuntsaansluiting voor éénpijpsysteem
- ✗ Eénpuntsaansluiting voor tweepijpsysteem
- ✗ Tweepuntsaansluiting voor éénpijpsysteem
- ✓ Tweepuntsaansluiting voor tweepijpsysteem (standaard) (zie p. 362)
- ✗ Geïntegreerd ventiel
- Aansluitingen: ½" (binnendraad)

ZANA HORIZONTAAL

Mooi tot in lengte van dagen

Ook in de horizontale uitvoering is de Zana designradiator een toonbeeld van klasse, kracht en comfort. De verticale buizen en de horizontale collectoren vormen samen een mooi gestructureerd geometrisch geheel en dragen bij tot de specifieke Zana retro-look. De Zana Horizontaal is verkrijgbaar met 1 of 2 rijen buizen en in een aparte toiletversie.

AANBEVOLEN AANSLUITING (18)

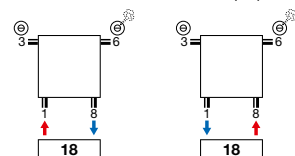

Andere aansluitmogelijkheden, zie p. 222



art. nr. 1182 101 0000 0099

prijs €234

Koppelingen, zie p. 377

AANBEVOLEN VOOR BADKAMER EN KEUKEN IN OPTIE



handdoekbeugel recht (chrom) art. nr. zie p. 221

prijs €200

Andere accessoires, zie p. 221



HOE ZANA HORIZONTAAL BESTELLEN

Leveringstermijn 15 - 30 werkdagen
(zonder transportduur)

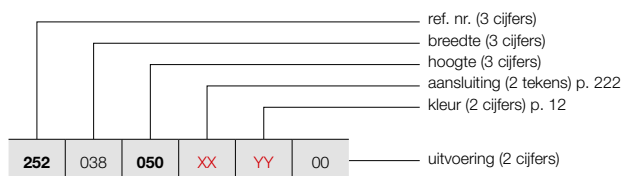

ZANA HORIZONTAAL (ZH-1)

217



ZH-1

PRIJSGROEP: VPG2 - STAAL DESIGNRADIATOREN

BESTELCODE MAATWERK ZANA HORIZONTAAL	TECHNISCHE GEGEVENS							STANDAARDKLEUR	ANDERE KLEUREN							
	buizen	breedte (L mm)	hoogte (H mm)	75/65/20 (Watt) (Φ50K)	55/45/20 (Watt) (Φ30K)	n-exp.	gewicht (kg)			inhoud (l)	el. weerst. (Watt)	prijs RAL 9016 (€)	prijs kleur (€)			
REF. NR. ZANA HORIZONTAAL ZH-1 : 252																
252	038	050	XX	YY	00	10	384	500	347	183	1,25	9,00	4,10	-	346	398
252	070	050	XX	YY	00	18	704	500	624	330	1,25	16,20	7,38	-	547	629
		060				18	704	600	728	384	1,25	18,90	8,46	-	597	687
		070				18	704	700	831	439	1,25	21,60	9,72	-	645	742
252	078	050	XX	YY	00	20	784	500	694	366	1,25	18,00	8,20	-	598	688
		060				20	784	600	809	427	1,25	21,00	9,40	-	651	749
		070				20	784	700	923	487	1,25	24,00	10,80	-	706	812
252	086	050	XX	YY	00	22	864	500	763	403	1,25	19,80	9,02	-	649	746
		060				22	864	600	890	470	1,25	23,10	10,34	-	707	813
		070				22	864	700	1015	536	1,25	26,40	11,88	-	761	875
252	094	050	XX	YY	00	24	944	500	832	439	1,25	21,60	9,84	-	697	802
		060				24	944	600	971	513	1,25	25,20	11,28	-	759	873
		070				24	944	700	1107	585	1,25	28,80	12,96	-	826	950
252	102	050	XX	YY	00	26	1024	500	902	476	1,25	23,40	10,66	-	750	863
		060				26	1024	600	1052	556	1,25	27,30	12,22	-	817	940
		070				26	1024	700	1200	634	1,25	31,20	14,04	-	887	1020
252	110	050	XX	YY	00	28	1104	500	971	513	1,25	25,20	11,48	-	798	918
		060				28	1104	600	1133	598	1,25	29,40	13,16	-	872	1003
		070				28	1104	700	1292	682	1,25	33,60	15,12	-	948	1090
252	118	050	XX	YY	00	30	1184	500	1040	549	1,25	27,00	12,30	-	845	972
		060				30	1184	600	1214	641	1,25	31,50	14,10	-	924	1063
		070				30	1184	700	1384	731	1,25	36,00	16,20	-	1007	1158
252	126	050	XX	YY	00	32	1264	500	1110	586	1,25	28,80	13,12	-	897	1032
		060				32	1264	600	1295	684	1,25	33,60	15,04	-	983	1130
		070				32	1264	700	1476	779	1,25	38,40	17,28	-	1068	1228
252	142	050	XX	YY	00	36	1424	500	1248	659	1,25	32,40	14,76	-	1000	1150
		060				36	1424	600	1457	769	1,25	37,80	16,92	-	1092	1256
		070				36	1424	700	1661	877	1,25	43,20	19,44	-	1189	1367
252	158	050	XX	YY	00	40	1584	500	1387	732	1,25	36,00	16,40	-	1095	1259
		060				40	1584	600	1618	854	1,25	42,00	18,80	-	1202	1382
		070				40	1584	700	1846	975	1,25	48,00	21,60	-	1313	1510
252	174	050	XX	YY	00	44	1744	500	1526	806	1,25	39,60	18,04	-	1198	1378
		060				44	1744	600	1780	940	1,25	46,20	20,68	-	1316	1513
		070				44	1744	700	2030	1072	1,25	52,80	23,76	-	1435	1650
252	190	050	XX	YY	00	48	1904	500	1665	879	1,25	43,20	19,68	-	1298	1493
		060				48	1904	600	1942	1026	1,25	50,40	22,56	-	1424	1638
		070				48	1904	700	2215	1170	1,25	57,60	25,92	-	1552	1785

Conform EN442-1: 2014: radiatoren en convectoren

Voor meer details over onze artikel-data, zie artikel-database: <https://www.installdata.be>

Voor de warmteafgiftes van andere regimes, kijkt u op p. 370 (correctiefactoren)
BELGIË. Prijzen in euro (excl. BTW)

ZANA HORIZONTAAL (ZH-1)



ZH-1

HOE ZANA HORIZONTAAL BESTELLEN

Leveringstermijn 15 - 30 werkdagen
(zonder transportduur)

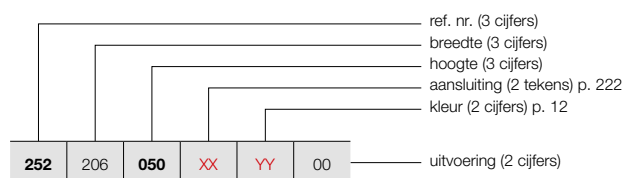

PRIJSGROEP: VPG2 - STAAL DESIGNRADIATOREN

BESTELCODE MAATWERK ZANA HORIZONTAAL	TECHNISCHE GEGEVENS									STANDAARDKLEUR	ANDERE KLEUREN	
	buizen	breedte (L mm)	hoogte (H mm)	75/65/20 (Watt) (Φ50K)	55/45/20 (Watt) (Φ30K)	n-exp.	gewicht (kg)	inhoud (l)	el. weerst. (Watt)	prijs RAL 9016 (€)	prijs kleur (€)	
REF. NR. ZANA HORIZONTAAL ZH-1 : 252												
252 206 050 XX YY 00	060	52	2064	500	1803	952	1,25	46,80	21,32	-	1397	1607
	070	52	2064	600	2104	1111	1,25	54,60	24,44	-	1536	1766
		52	2064	700	2399	1267	1,25	62,40	28,08	-	1675	1926
252 222 050 XX YY 00	060	56	2224	500	1942	1026	1,25	50,40	22,96	-	1496	1720
	070	56	2224	600	2266	1197	1,25	58,80	26,32	-	1647	1894
		56	2224	700	2584	1365	1,25	67,20	30,24	-	1798	2068
252 238 050 XX YY 00	060	60	2384	500	2081	1099	1,25	54,00	24,60	-	1597	1837
	070	60	2384	600	2428	1282	1,25	63,00	28,20	-	1760	2024
		60	2384	700	2768	1462	1,25	72,00	32,40	-	1920	2208
252 254 050 XX YY 00	060	64	2544	500	2220	1172	1,25	57,60	26,24	-	1697	1952
	070	64	2544	600	2589	1367	1,25	67,20	30,08	-	1871	2152
		64	2544	700	2953	1559	1,25	76,80	34,56	-	2041	2347
252 270 050 XX YY 00	060	68	2704	500	2358	1245	1,25	61,20	27,88	-	1799	2069
	070	68	2704	600	2751	1453	1,25	71,40	31,96	-	1981	2278
		68	2704	700	3138	1657	1,25	81,60	36,72	-	2161	2485
252 286 050 XX YY 00	060	72	2864	500	2497	1319	1,25	64,80	29,52	-	1899	2184
	070	72	2864	600	2913	1538	1,25	75,60	33,84	-	2091	2405
		72	2864	700	3322	1754	1,25	86,40	38,88	-	2283	2625

Conform EN442-1: 2014: radiatoren en convectoren

Voor meer details over onze artikel-data, zie artikel-database: <https://www.installdata.be>

Voor de warmteafgiftes van andere regimes, kijkt u op p. 370 (correctiefactoren)
BELGIË. Prijzen in euro (excl. BTW)

HOE ZANA HORIZONTAAL BESTELLEN

Leveringstermijn 15 - 30 werkdagen
(zonder transportduur)

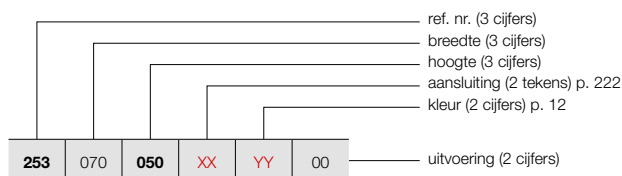

ZANA HORIZONTAAL (ZH-2)



ZH-2

PRIJSGROEP: VPG2 - STAAL DESIGNRADIATOREN

BESTELCODE MAATWERK ZANA HORIZONTAAL	TECHNISCHE GEGEVENS							STANDAARDKLEUR		ANDERE KLEUREN	
	buizen	breedte (L mm)	hoogte (H mm)	75/65/20 (Watt) (Φ50K)	55/45/20 (Watt) (Φ30K)	n-exp.	gewicht (kg)	inhoud (l)	el. weerst. (Watt)	prijs RAL 9016 (€)	prijs kleur (€)
REF. NR. ZANA HORIZONTAAL ZH-2 : 253											
253 070 050 XX YY 00	18	704	500	1035	547	1,28	30,42	13,50	-	929	1068
	18	704	600	1205	636	1,28	35,64	16,02	-	1011	1163
	18	704	700	1372	725	1,28	41,04	18,54	-	1091	1255
253 078 050 XX YY 00	20	784	500	1150	607	1,28	33,80	15,00	-	1012	1164
	20	784	600	1339	707	1,28	39,60	17,80	-	1109	1275
	20	784	700	1525	805	1,28	45,60	20,60	-	1194	1373
253 086 050 XX YY 00	22	864	500	1265	668	1,28	37,18	16,50	-	1096	1260
	22	864	600	1473	778	1,28	43,56	19,58	-	1199	1379
	22	864	700	1677	886	1,28	50,16	22,66	-	1298	1493
253 094 050 XX YY 00	24	944	500	1380	729	1,28	40,56	18,00	-	1186	1364
	24	944	600	1607	849	1,28	47,52	21,36	-	1293	1487
	24	944	700	1830	966	1,28	54,72	24,72	-	1402	1612
253 102 050 XX YY 00	26	1024	500	1494	789	1,28	43,94	19,50	-	1272	1463
	26	1024	600	1741	919	1,28	51,48	23,14	-	1390	1599
	26	1024	700	1982	1047	1,28	59,28	26,78	-	1506	1732
253 110 050 XX YY 00	28	1104	500	1609	850	1,28	47,32	21,00	-	1355	1558
	28	1104	600	1875	990	1,28	55,44	24,92	-	1482	1704
	28	1104	700	2135	1127	1,28	63,84	28,84	-	1609	1850
253 118 050 XX YY 00	30	1184	500	1724	910	1,28	50,70	22,50	-	1439	1655
	30	1184	600	2009	1061	1,28	59,40	26,70	-	1575	1811
	30	1184	700	2287	1208	1,28	68,40	30,90	-	1714	1971
253 126 050 XX YY 00	32	1264	500	1839	971	1,28	54,08	24,00	-	1525	1754
	32	1264	600	2143	1132	1,28	63,36	28,48	-	1673	1924
	32	1264	700	2440	1288	1,28	72,96	32,96	-	1814	2086
253 142 050 XX YY 00	36	1424	500	2069	1093	1,28	60,84	27,00	-	1696	1950
	36	1424	600	2411	1273	1,28	71,28	32,04	-	1856	2134
	36	1424	700	2745	1450	1,28	82,08	37,08	-	2022	2325
253 158 050 XX YY 00	40	1584	500	2299	1214	1,28	67,60	30,00	-	1865	2145
	40	1584	600	2678	1414	1,28	79,20	35,60	-	2049	2356
	40	1584	700	3050	1611	1,28	91,20	41,20	-	2232	2567
253 174 050 XX YY 00	44	1744	500	2529	1335	1,28	74,36	33,00	-	2036	2341
	44	1744	600	2946	1556	1,28	87,12	39,16	-	2237	2573
	44	1744	700	3355	1772	1,28	100,32	45,32	-	2434	2799
253 190 050 XX YY 00	48	1904	500	2759	1457	1,28	81,12	36,00	-	2206	2537
	48	1904	600	3214	1697	1,28	95,04	42,72	-	2424	2788
	48	1904	700	3660	1933	1,28	109,44	49,44	-	2641	3037

Conform EN442-1: 2014: radiatoren en convectoren

Voor meer details over onze artikel-data, zie artikel-database: <https://www.installdata.be>

Voor de warmteafgiftes van andere regimes, kijkt u op p. 370 (correctiefactoren)

BELGIË. Prijzen in euro (excl. BTW)

ZANA HORIZONTAAL (ZH-2)



ZH-2

HOE ZANA HORIZONTAAL BESTELLEN

Leveringstermijn 15 - 30 werkdagen
(zonder transportduur)

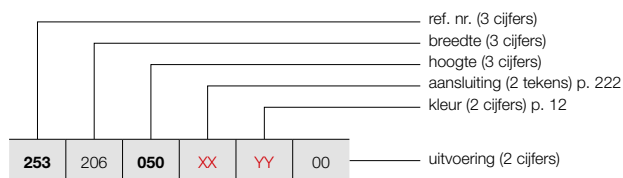

PRIJSGROEP: VPG2 - STAAL DESIGNRADIATOREN

BESTELCODE MAATWERK ZANA HORIZONTAAL	TECHNISCHE GEGEVENS									STANDAARDKLEUR	ANDERE KLEUREN	
	buizen	breedte (L mm)	hoogte (H mm)	75/65/20 (Watt) (Φ50K)	55/45/20 (Watt) (Φ30K)	n-exp.	gewicht (kg)	inhoud (l)	el. weerst. (Watt)	prijs RAL 9016 (€)	prijs kleur (€)	
REF. NR. ZANA HORIZONTAAL ZH-2 : 253												
253 206 050 XX YY 00	060	52	2064	500	2989	1578	1,28	87,88	39,00	-	2376	2732
	070	52	2064	600	3482	1839	1,28	102,96	46,28	-	2611	3003
		52	2064	700	3964	2093	1,28	118,56	53,56	-	2848	3275
253 222 050 XX YY 00	060	56	2224	500	3219	1700	1,28	94,64	42,00	-	2550	2933
	070	56	2224	600	3750	1980	1,28	110,88	49,84	-	2802	3222
		56	2224	700	4269	2254	1,28	127,68	57,68	-	3056	3514
253 238 050 XX YY 00	060	60	2384	500	3449	1821	1,28	101,40	45,00	-	2719	3127
	070	60	2384	600	4018	2122	1,28	118,80	53,40	-	2990	3439
		60	2384	700	4574	2415	1,28	136,80	61,80	-	3260	3749
253 254 050 XX YY 00	060	64	2544	500	3679	1943	1,28	108,16	48,00	-	2887	3320
	070	64	2544	600	4285	2263	1,28	126,72	56,96	-	3179	3656
		64	2544	700	4879	2576	1,28	145,92	65,92	-	3468	3988
253 270 050 XX YY 00	060	68	2704	500	3909	2064	1,28	114,92	51,00	-	3061	3520
	070	68	2704	600	4553	2404	1,28	134,64	60,52	-	3364	3869
		68	2704	700	5184	2737	1,28	155,04	70,04	-	3674	4225
253 286 050 XX YY 00	060	72	2864	500	4139	2186	1,28	121,68	54,00	-	3227	3711
		72	2864	600	4821	2546	1,28	142,56	64,08	-	3556	4089

Conform EN442-1: 2014: radiatoren en convectoren

Voor meer details over onze artikel-data, zie artikel-database: <https://www.installdata.be>

Voor de warmteafgiftes van andere regimes, kijkt u op p. 370 (correctiefactoren)
BELGIË. Prijzen in euro (excl. BTW)

PRIJSGROEP: VPG10B - HANDDOEKBEUGELS

ACCESSOIRES	BREEDTE RADIATOR	KLEUR	ART. NR.	€
ZV-1 / ZV-2 / ZH-1 / ZH-2				
HANDDOEKBEUGEL RECHT		CHROOM	1183 228 0000 0099	200
<ul style="list-style-type: none"> h = 22 mm; b = 720 mm (zelf in te korten); d = 75 mm; a = 56 mm 				
ZV-1 / ZV-2 / ZH-1 / ZH-2				
KNOP		CHROOM	1183 410 0000 0099	94
<ul style="list-style-type: none"> h = 70 mm; b = 70 mm; d = 59 mm; a = 51 mm; 				
ZV-1				
HANDDOEKBEUGEL MULTI+ RECHTS	600 mm	S600	1183 734 0000 0600	215
	600 mm	RAL 9005 ^S	1183 734 0000 9005	215
<ul style="list-style-type: none"> h = 70 mm; b = 600 mm (b tablet = 194 mm); e = 176 mm; c = 170 mm; Bevestiging aan de muur, rechts van de radiator. 				
ZV-1				
HANDDOEKBEUGEL MULTI+ LINKS	600 mm	S600	1183 735 0000 0600	215
	600 mm	RAL 9005 ^S	1183 735 0000 9005	215
<ul style="list-style-type: none"> h = 70 mm; b = 600 mm (b tablet = 194 mm); e = 176 mm; c = 170 mm; Bevestiging aan de muur, links van de radiator. 				

^S structuur zwart

Montagevoorschriften accessoires: zie www.vasco.eu
BELGIË. Prijzen in euro (excl. BTW)

e = afstand voorkant accessoire tot wand
d = afstand voorkant accessoire tot voorkant radiator
c = afstand wand tot achterkant beugel
a = afstand accessoire tot radiator
uit voorraad leverbaar

ZANA VERTICAAL: ZV-1 / ZV-2 (VOORRAAD)

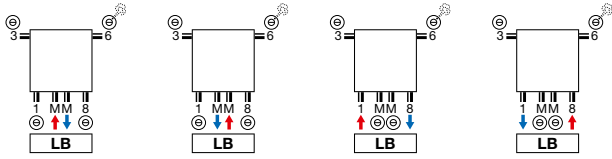

ZANA HORIZONTAAL: ZH-1 / ZH-2

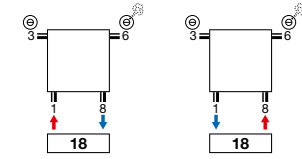

ZANA VERTICAAL: ZV-1 / ZV-2 (NIET-VOORRAAD)

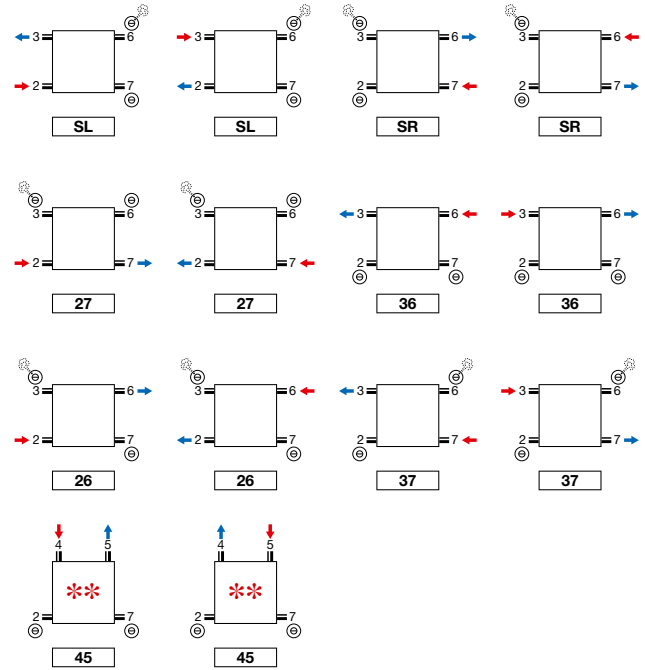
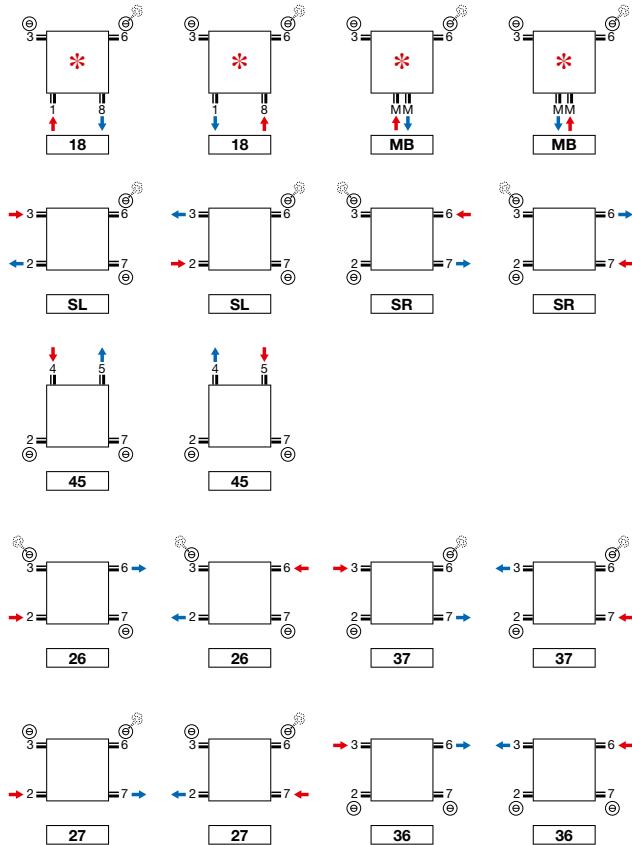

** Niet voor ZH-1 toiletradiator.

* Opmerking ZV-1/ZV-2 8 buizen: 2/3/6/7 altijd open.

Opmerking: het aansluiten van de radiator kan enkel volgens de getoonde aansluiticonen. Voor elke andere aansluitwijze nemen wij geen verantwoordelijkheid.

ZANA VERTICAAL (ZV-1, ZV-2)

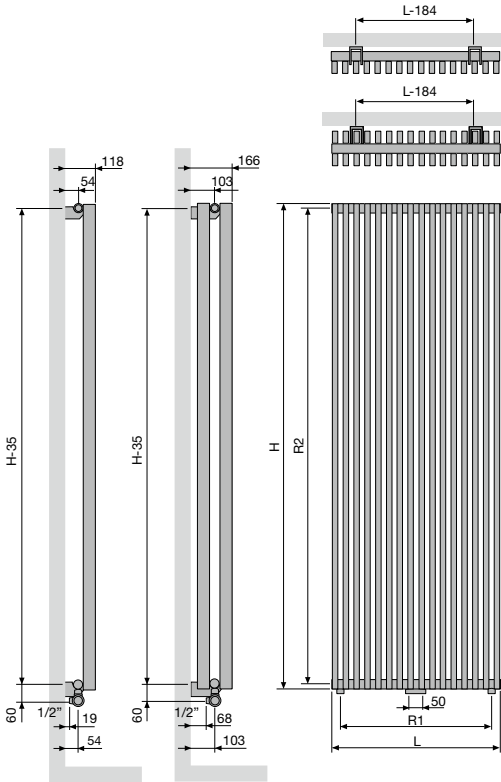

ZV-1 / ZV-2

Aantal buizen	8	10	12	14	16	18	20	22	24	26
Breedte (L)	304	384	464	544	624	704	784	864	944	1024
Hartafstand tussen de onderaansluitingen 18 (R1)	240	320	400	480	560	640	720	800	880	960
Hoogte (H)	1400	1600	1800	2000	2200	2400	2600	2800	3000	
Hartafstand tussen de zijaansluitingen SL/SR (R2)	1365	1565	1765	1965	2165	2365	2565	2765	2965	
Hartafstand tussen de ophangingen	L-184	H-35								

ZANA HORIZONTAAL (ZH-1, ZH-2)

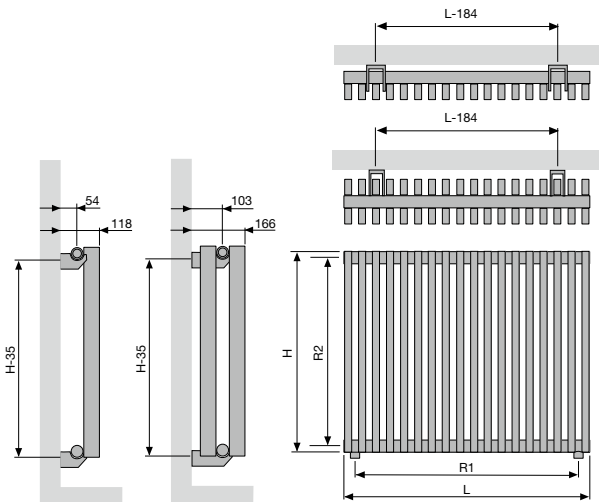

ZH-1 / ZH-2

Breedte (L)	384	704	784	864	944	1024	1104	1184	1264	1424	1584	1744	1904	2064	2224	2384	2544	2704	2864
Hartafstand tussen de onderaansluitingen 18 (R1)	320	640	720	800	880	960	1040	1120	1200	1360	1520	1680	1840	2000	2160	2320	2480	2640	2800
Hoogte (H)	500	600	700																
Hartafstand tussen de zijaansluitingen SL/SR (R2)	465	565	665																
Hartafstand tussen de ophangingen	L-184	H-35																	

VIOLA-A VERTICAAL (V1-ZB-A, V1L1-ZB-A, V2-ZB-A)

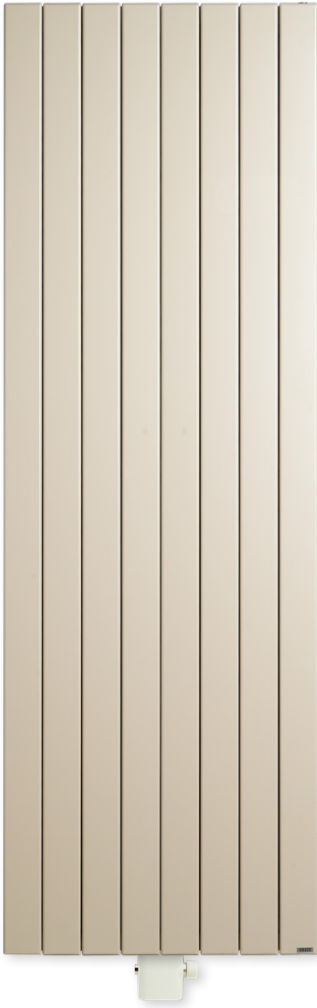

TYPES

- V1-ZB-A enkele rij buizen, V2-ZB-A dubbele rij buizen, V1L1-ZB-A met lamellen

BUIZEN

- Verticaal, rechthoekig 77 x 10 mm

COLLECTOREN

- V1-ZB-A: 35 x 43 mm
- V1L1-ZB-A: 35 x 43 mm
- V2-ZB-A: 35 x 41 mm

KLEUREN

- Standaardkleur wit RAL 9016
- Uitgebreide kleurenkaart zie p. 12

SPECIAAL

- Wordt standaard geleverd met 2 zijbekledingen.
- mm aansluiting alleen mogelijk bij even aantal buizen.
- Bij type V1L1-ZB-A is 1 rij stalen lamellen ter verhoging van de warmteafgifte op de platovale buizen gepuntlast.

BEVESTIGINGEN

- Muurbevestigingen standaard (inbegrepen in de verpakking van de radiator)
- Bovenste beugel in kleur van de radiator, onderaan:
 - Afstandshouder radiator wit = afstandshouder wit.
 - Afstandshouder radiator in kleur = afstandshouder RAL 7024.
- **V2-ZB-A:** Radiator met telescopische steunvoeten + variabele muurbevestiging: gelieve bij bestelling code **07** aan te geven bij "Afwerking" (zie p. 253).

TECHNISCH

- Weerstandsgelast (onzichtbare lasnaden)
- ATL-grondlaag, poedercoating
- Standaardwerkdruk: 4 bar. Meerprijs hogere werkdruk (10 bar): +10%
- De leveringstermijn van radiator met een hogere werkdruk is 1 week extra.
- Maximale bedrijfstemperatuur: 110°C

ELEKTRISCH

- ✗ Zuiver elektrische radiator in de fabriek voorgevuld
- ✗ Gemengde radiator

VIOLA-A VERTICAAL

In de soberheid toont zich de klasse

Een buizenradiator die naadloos combineert met elke woonstijl, door zijn sobere klasse en zijn vanzelfsprekend design. De strak gelijkende voorkant en de ingewerkte zijpanelen staan borg voor een uniforme look en een optimale warmteafgifte. Viola-A, zo simpel, krachtig en aantrekkelijk kan verwarmingscomfort zijn.

TECHNISCHE TEKENINGEN

- Zie p. 256

AANSLUITING

- ✗ Eénpuntsaansluiting voor éénpijpsysteem
 - ✗ Eénpuntsaansluiting voor tweepijpsysteem
 - ✓ Tweepuntsaansluiting voor éénpijpsysteem (aansluiting via de middenaansluiting) (zie p. 362)
 - ✓ Tweepuntsaansluiting voor tweepijpsysteem (standaard) (zie p. 362)
 - ✗ Geïntegreerd ventiel
- Aansluitingen: ½" (binnendraad)

AANBEVOLEN AANSLUITING (LM)

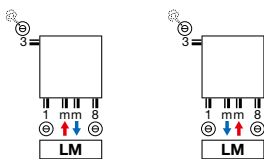

mm aansluiting alleen mogelijk bij even aantal buizen.
Andere aansluitmogelijkheden, zie p. 255

NEW



Ventielset haaks kleur

art. nr. 1182 105 0000 9016
prijs €201
 Andere kleuren, zie p. 366
 Koppelingen, zie p. 380



Thermostaatkop

Traffic White
 art. nr. 1182 030 0000 9016
prijs €40

AANBEVOLEN VOOR BADKAMER EN KEUKEN IN OPTIE



handdoekbeugel (RAL 9005)
 art. nr. zie p. 254

prijs €157
Andere accessoires, zie p. 254



HOE VIOLA-A VERTICAAL BESTELLEN

Leveringstermijn 15 - 30 werkdagen
(zonder transportduur)

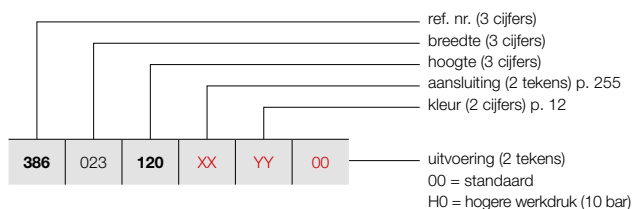

HOE VOORRAADRADIATOR VIOLA-A VERTICAAL BESTELLEN

Leveringstermijn 5 werkdagen
(zonder transportduur)

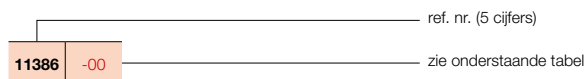

VIOLA-A VERTICAAL (V1-ZB-A)

225



V1-ZB-A

PRIJSGROEP: VPG2 - STAAL DESIGNRADIATOREN

BESTELCODE MAATWERK VIOLA-A VERTICAAL	TECHNISCHE GEGEVENS									STANDAARDKLEUR		ANDERE KLEUREN					
	buizen	breedte (L mm)	hoogte (H mm)	75/65/20 (Watt) (φ50K)	55/45/20 (Watt) (φ30K)	n-exp.	gewicht (kg)	inhoud (l)	el. weerst. (Watt)	prijs RAL 9016 (€)	verkorte ref. nr. RAL 9016 voorraad		prijs kleur (€)				
REF. NR. VIOLA-A VERTICAAL V1-ZB-A : 386																	
386	023	120	XX	YY	00	3	237	1200	371	189	1,32	7,80	2,40	-	352	-	405
		140				3	237	1400	427	218	1,32	9,00	2,73	-	387	-	446
		160				3	237	1600	483	246	1,32	9,90	3,03	-	413	-	475
		180				3	237	1800	535	273	1,32	11,10	3,33	-	444	-	511
		200				3	237	2000	589	301	1,30	12,30	3,60	-	478	-	550
		220				3	237	2200	640	327	1,28	13,50	3,90	-	509	-	585
		240				3	237	2400	689	352	1,27	14,40	4,20	-	537	-	618
386	031	120	XX	YY	00	4	317	1200	480	245	1,31	10,40	3,20	-	413	-	475
		140				4	317	1400	551	281	1,31	12,00	3,64	-	454	-	522
		160				4	317	1600	624	318	1,31	13,20	4,04	-	493	-	567
		180				4	317	1800	695	355	1,32	14,80	4,44	-	530	-	610
		200				4	317	2000	764	390	1,30	16,40	4,80	-	572	-	658
		220				4	317	2200	831	424	1,29	18,00	5,20	-	609	-	700
		240				4	317	2400	894	456	1,27	19,20	5,60	-	650	-	748
386	039	120	XX	YY	00	5	397	1200	585	298	1,31	13,00	4,00	-	475	-	546
		140				5	397	1400	673	343	1,31	15,00	4,55	-	521	-	599
		160				5	397	1600	762	389	1,31	16,50	5,05	-	572	-	658
		180				5	397	1800	850	434	1,31	18,50	5,55	-	619	-	712
		200				5	397	2000	936	478	1,30	20,50	6,00	-	666	-	766
		220				5	397	2200	1017	519	1,29	22,50	6,50	-	713	-	820
		240				5	397	2400	1094	558	1,28	24,00	7,00	-	758	-	872
386	047	120	XX	YY	00	6	477	1200	689	352	1,31	15,60	4,80	-	537	-	618
		140				6	477	1400	792	404	1,31	18,00	5,46	-	594	-	683
		160				6	477	1600	897	458	1,31	19,80	6,06	-	650	-	748
		180				6	477	1800	1003	512	1,31	22,20	6,66	-	706	-	812
		200				6	477	2000	1104	563	1,30	24,60	7,20	-	758	11386-01	872
		220				6	477	2200	1200	612	1,29	27,00	7,80	-	814	-	936
		240				6	477	2400	1291	659	1,28	28,80	8,40	-	869	-	999
386	055	120	XX	YY	00	7	557	1200	790	403	1,30	18,20	5,60	-	604	-	695
		140				7	557	1400	909	464	1,31	21,00	6,37	-	666	-	766
		160				7	557	1600	1029	525	1,31	23,10	7,07	-	726	-	835
		180				7	557	1800	1154	589	1,31	25,90	7,77	-	792	-	911
		200				7	557	2000	1269	647	1,30	28,70	8,40	-	852	-	980
		220				7	557	2200	1380	704	1,29	31,50	9,10	-	915	-	1052
		240				7	557	2400	1485	758	1,28	33,60	9,80	-	977	-	1124
386	063	120	XX	YY	00	8	637	1200	891	455	1,30	20,80	6,40	-	665	-	765
		140				8	637	1400	1024	522	1,30	24,00	7,28	-	735	-	845
		160				8	637	1600	1159	591	1,31	26,40	8,08	-	806	-	927
		180				8	637	1800	1302	664	1,31	29,60	8,88	-	876	-	1007
		200				8	637	2000	1433	731	1,30	32,80	9,60	-	948	-	1090
		220				8	637	2200	1557	794	1,29	36,00	10,40	-	1013	-	1165
		240				8	637	2400	1676	855	1,29	38,40	11,20	-	1086	-	1249

Conform EN442-1: 2014: radiatoren en convectoren

Voor meer details over onze artikel-data, zie artikel-database: <https://www.installdata.be>

Voor de warmteafgiftes van andere regimes, kijkt u op p. 370 (correctiefactoren)

BELGIË. Prijzen in euro (excl. BTW)

VIOLA-A VERTICAAL (V1-ZB-A)



V1-ZB-A

HOE VIOLA-A VERTICAAL BESTELLEN

Leveringstermijn 15 - 30 werkdagen
(zonder transportduur)

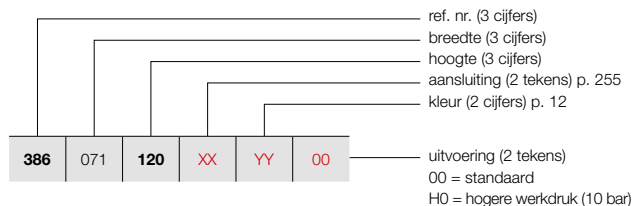

PRIJSGROEP: VPG2 - STAAL DESIGNRADIATOREN

BESTELCODE MAATWERK VIOLA-A VERTICAAL	TECHNISCHE GEGEVENS									STANDAARDKLEUR	ANDERE KLEUREN
	buizen	breedte (L mm)	hoogte (H mm)	75/65/20 (Watt) (Φ50K)	55/45/20 (Watt) (Φ30K)	n-exp.	gewicht (kg)	inhoud (l)	el. weerst. (Watt)	prijs RAL 9016 (€)	prijs kleur (€)
REF. NR. VIOLA-A VERTICAAL V1-ZB-A : 386											
386	071	120	XX	YY	00						
		140								726	835
		160								806	927
		180								881	1013
		200								963	1107
		220								1042	1198
		240								1118	1286
										1194	1373
386	079	120	XX	YY	00						
		140								788	906
		160								876	1007
		180								963	1107
		200								1047	1204
		220								1134	1304
		240								1223	1406
										1307	1503
386	087	120	XX	YY	00						
		140								852	980
		160								946	1088
		180								1039	1195
		200								1134	1304
		220								1228	1412
		240								1322	1520
										1416	1628
386	095	120	XX	YY	00						
		140								914	1051
		160								1012	1164
		180								1116	1283
		200								1217	1400
		220								1322	1520
		240								1422	1635
										1526	1755
386	103	120	XX	YY	00						
		140								1039	1195
		160								1155	1328
		180								1274	1465
		200								1392	1601
		220								1506	1732
		240								1627	1871
										1744	2006

Conform EN442-1: 2014: radiatoren en convectoren

Voor meer details over onze artikel-data, zie artikel-database: <https://www.installdata.be>

Voor de warmteafgifte van andere regimes, kijkt u op p. 370 (correctiefactoren)
BELGIË. Prijzen in euro (excl. BTW)

HOE VIOLA-A VERTICAAL BESTELLEN

Leveringstermijn 15 - 30 werkdagen
(zonder transportduur)

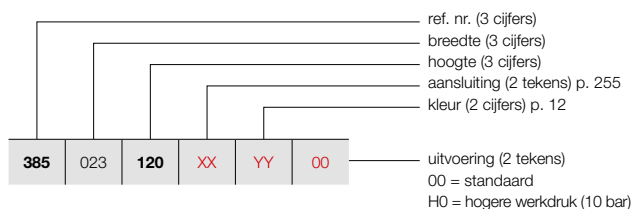

VIOLA-A VERTICAAL (V1L1-ZB-A)



V1L1-ZB-A

PRIJSGROEP: VPG2 - STAAL DESIGNRADIATOREN

BESTELCODE MAATWERK VIOLA-A VERTICAAL	TECHNISCHE GEGEVENS							STANDAARDKLEUR		ANDERE KLEUREN						
	buizen	breedte (L mm)	hoogte (H mm)	75/65/20 (Watt) (Φ50K)	55/45/20 (Watt) (Φ30K)	n-exp.	gewicht (kg)	inhoud (l)	el. weerst. (Watt)	prijs RAL 9016 (€)	prijs kleur (€)					
REF. NR. VIOLA-A VERTICAAL V1L1-ZB-A : 385																
385	023	120	XX	YY	00	3	237	1200	464	237	1,28	10,50	2,40	-	439	505
		140				3	237	1400	531	271	1,28	12,60	2,73	-	479	551
		160				3	237	1600	597	305	1,29	14,40	3,03	-	518	596
		180				3	237	1800	661	337	1,29	15,90	3,33	-	559	643
		200				3	237	2000	723	369	1,30	18,30	3,60	-	598	688
		220				3	237	2200	784	400	1,32	19,80	3,90	-	634	729
		240				3	237	2400	843	430	1,33	21,60	4,20	-	675	776
385	031	120	XX	YY	00	4	317	1200	605	309	1,28	14,00	3,20	-	518	596
		140				4	317	1400	693	354	1,29	16,80	3,64	-	567	652
		160				4	317	1600	778	397	1,29	19,20	4,04	-	617	710
		180				4	317	1800	861	439	1,29	21,20	4,44	-	666	766
		200				4	317	2000	943	481	1,31	24,40	4,80	-	714	821
		220				4	317	2200	1022	521	1,32	26,40	5,20	-	760	874
		240				4	317	2400	1099	561	1,33	28,80	5,60	-	811	933
385	039	120	XX	YY	00	5	397	1200	743	379	1,29	17,50	4,00	-	597	687
		140				5	397	1400	851	434	1,29	21,00	4,55	-	654	752
		160				5	397	1600	956	488	1,29	24,00	5,05	-	714	821
		180				5	397	1800	1058	540	1,30	26,50	5,55	-	771	887
		200				5	397	2000	1158	591	1,31	30,50	6,00	-	831	956
		220				5	397	2200	1255	640	1,32	33,00	6,50	-	891	1025
		240				5	397	2400	1350	689	1,33	36,00	7,00	-	950	1093
385	047	120	XX	YY	00	6	477	1200	879	448	1,29	21,00	4,80	-	675	776
		140				6	477	1400	1007	514	1,29	25,20	5,46	-	745	857
		160				6	477	1600	1131	577	1,30	28,80	6,06	-	811	933
		180				6	477	1800	1252	639	1,30	31,80	6,66	-	879	1011
		200				6	477	2000	1370	699	1,31	36,60	7,20	-	950	1093
		220				6	477	2200	1485	758	1,32	39,60	7,80	-	1016	1168
		240				6	477	2400	1598	815	1,33	43,20	8,40	-	1086	1249
385	055	120	XX	YY	00	7	557	1200	1013	517	1,29	24,50	5,60	-	753	866
		140				7	557	1400	1160	592	1,30	29,40	6,37	-	831	956
		160				7	557	1600	1303	665	1,30	33,60	7,07	-	911	1048
		180				7	557	1800	1443	736	1,31	37,10	7,77	-	986	1134
		200				7	557	2000	1579	806	1,31	42,70	8,40	-	1066	1226
		220				7	557	2200	1712	873	1,32	46,20	9,10	-	1145	1317
		240				7	557	2400	1841	939	1,33	50,40	9,80	-	1226	1410
385	063	120	XX	YY	00	8	637	1200	1146	585	1,29	28,00	6,40	-	830	955
		140				8	637	1400	1312	669	1,30	33,60	7,28	-	918	1056
		160				8	637	1600	1474	752	1,31	38,40	8,08	-	1007	1158
		180				8	637	1800	1632	833	1,31	42,40	8,88	-	1093	1257
		200				8	637	2000	1786	911	1,32	48,80	9,60	-	1185	1363
		220				8	637	2200	1936	988	1,32	52,80	10,40	-	1272	1463
		240				8	637	2400	2083	1063	1,33	57,60	11,20	-	1361	1565

Conform EN442-1: 2014: radiatoren en convectoren

Voor meer details over onze artikel-data, zie artikel-database: <https://www.installdata.be>
Voor de warmteafgiftes van andere regimes, kijkt u op p. 370 (correctiefactoren)
BELGIË. Prijzen in euro (excl. BTW)

STAAL DESIGNRADIATOREN

VIOLA-A VERTICAAL (V1L1-ZB-A)



V1L1-ZB-A

HOE VIOLA-A VERTICAAL BESTELLEN

Leveringstermijn 15 - 30 werkdagen
(zonder transportduur)

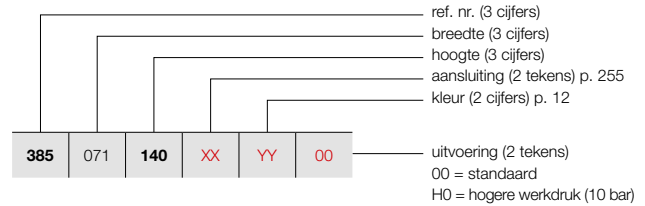

PRIJSGROEP: VPG2 - STAAL DESIGNRADIATOREN

BESTELCODE MAATWERK VIOLA-A VERTICAAL							TECHNISCHE GEGEVENS					STANDAARDKLEUR	ANDERE KLEUREN			
buizen	breedte (L mm)	hoogte (H mm)	75/65/20 (Watt) (Ø50K)	55/45/20 (Watt) (Ø30K)	n-exp.	gewicht (kg)	inhoud (l)	el. weerst. (Watt)	prijs RAL 9016 (€)	prijs kleur (€)						
REF. NR. VIOLA-A VERTICAAL V1L1-ZB-A : 385																
385	071	140	XX	YY	00	9	717	1400	1462	746	1,30	37,80	8,19	-	1007	1158
		160				9	717	1600	1643	838	1,31	43,20	9,09	-	1105	1271
		180				9	717	1800	1819	928	1,32	47,70	9,99	-	1200	1380
		200				9	717	2000	1990	1015	1,32	54,90	10,80	-	1301	1496
		220				9	717	2200	2158	1101	1,32	59,40	11,70	-	1397	1607
		240				9	717	2400	2321	1184	1,33	64,80	12,60	-	1493	1717
385	079	120	XX	YY	00	10	797	1200	1407	718	1,30	35,00	8,00	-	985	1133
		140				10	797	1400	1611	822	1,31	42,00	9,10	-	1093	1257
		160				10	797	1600	1810	923	1,31	48,00	10,10	-	1200	1380
		180				10	797	1800	2004	1022	1,32	53,00	11,10	-	1311	1508
		200				10	797	2000	2194	1119	1,32	61,00	12,00	-	1416	1628
		220				10	797	2200	2387	1218	1,32	66,00	13,00	-	1526	1755
		240				10	797	2400	2558	1305	1,33	72,00	14,00	-	1633	1878
385	087	120	XX	YY	00	11	877	1200	1536	784	1,30	38,50	8,80	-	1066	1226
		140				11	877	1400	1759	897	1,31	46,20	10,01	-	1183	1360
		160				11	877	1600	1976	1008	1,32	52,80	11,11	-	1300	1495
		180				11	877	1800	2189	1117	1,32	58,30	12,21	-	1416	1628
		200				11	877	2000	2394	1221	1,33	67,10	13,20	-	1533	1763
		220				11	877	2200	2596	1324	1,33	72,60	14,30	-	1653	1901
		240				11	877	2400	2792	1424	1,33	79,20	15,40	-	1770	2036
385	095	120	XX	YY	00	12	957	1200	1665	849	1,31	42,00	9,60	-	1143	1314
		140				12	957	1400	1907	973	1,31	50,40	10,92	-	1271	1462
		160				12	957	1600	2142	1093	1,32	57,60	12,12	-	1396	1605
		180				12	957	1800	2371	1210	1,33	63,60	13,32	-	1525	1754
		200				12	957	2000	2595	1324	1,33	73,20	14,40	-	1653	1901
		220				12	957	2200	2813	1435	1,33	79,20	15,60	-	1777	2044
		240				12	957	2400	3026	1544	1,33	86,40	16,80	-	1906	2192
385	103	120	XX	YY	00	13	1037	1200	1792	914	1,31	45,50	10,40	-	1300	1495
		140				13	1037	1400	2052	1047	1,32	54,60	11,83	-	1444	1661
		160				13	1037	1600	2306	1177	1,33	62,40	13,13	-	1593	1832
		180				13	1037	1800	2552	1302	1,33	68,90	14,43	-	1738	1999
		200				13	1037	2000	2793	1425	1,33	79,30	15,60	-	1884	2167
		220				13	1037	2200	3028	1545	1,33	85,80	16,90	-	2031	2336
		240				13	1037	2400	3257	1662	1,33	93,60	18,20	-	2182	2509

Conform EN442-1: 2014: radiatoren en convectoren

Voor meer details over onze artikel-data, zie artikel-database: <https://www.installdata.be>

Voor de warmteafgifte van andere regimes, kijkt u op p. 370 (correctiefactoren)
BELGIË. Prijzen in euro (excl. BTW)

HOE VIOLA-A VERTICAAL BESTELLEN

Leveringstermijn 15 - 30 werkdagen
(zonder transportduur)

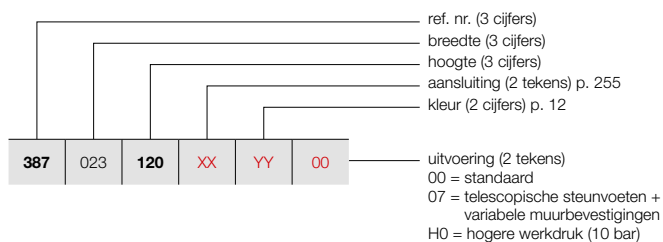

HOE VOORRAADRADIATOR VIOLA-A VERTICAAL BESTELLEN

Leveringstermijn 5 werkdagen
(zonder transportduur)

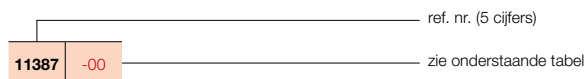

VIOLA-A VERTICAAL (V2-ZB-A)

229



V2-ZB-A

PRIJSGROEP: VPG2 - STAAL DESIGNRADIATOREN

BESTELCODE MAATWERK VIOLA-A VERTICAAL	TECHNISCHE GEGEVENS							STANDAARDKLEUR		ANDERE KLEUREN							
	buizen	breedte (L mm)	hoogte (H mm)	75/65/20 (Watt) (Φ50K)	55/45/20 (Watt) (Φ30K)	n-exp.	gewicht (kg)	inhoud (l)	el. weerst. (Watt)		prijs RAL 9016 (€)	verkorte ref. nr. RAL 9016 voorraad	prijs kleur (€)				
REF. NR. VIOLA-A VERTICAAL V2-ZB-A : 387																	
387	023	120	XX	YY	00	3	237	1200	509	260	1,33	14,40	4,59	-	598	-	688
		140				3	237	1400	587	299	1,34	16,80	5,04	-	652	-	750
		160				3	237	1600	664	339	1,35	18,90	5,52	-	706	-	812
		180				3	237	1800	743	379	1,35	21,30	5,97	-	757	-	871
		200				3	237	2000	821	419	1,35	23,40	6,39	-	811	-	933
		220				3	237	2200	900	459	1,34	25,80	6,81	-	865	-	995
		240				3	237	2400	979	499	1,34	28,20	7,23	-	918	-	1056
387	031	120	XX	YY	00	4	317	1200	655	334	1,33	19,20	6,12	-	706	-	812
		140				4	317	1400	755	385	1,34	22,40	6,72	-	771	-	887
		160				4	317	1600	854	436	1,35	25,20	7,36	-	840	-	966
		180				4	317	1800	952	486	1,35	28,40	7,96	-	904	-	1040
		200				4	317	2000	1050	536	1,35	31,20	8,52	-	970	-	1116
		220				4	317	2200	1147	585	1,35	34,40	9,08	-	1038	-	1194
		240				4	317	2400	1244	635	1,34	37,60	9,64	-	1105	-	1271
387	039	120	XX	YY	00	5	397	1200	802	409	1,33	24,00	7,65	-	810	-	932
		140				5	397	1400	923	471	1,34	28,00	8,40	-	892	-	1026
		160				5	397	1600	1043	532	1,35	31,50	9,20	-	970	-	1116
		180				5	397	1800	1162	593	1,36	35,50	9,95	-	1052	-	1210
		200				5	397	2000	1279	653	1,35	39,00	10,65	-	1132	-	1302
		220				5	397	2200	1394	711	1,35	43,00	11,35	-	1211	-	1393
		240				5	397	2400	1509	770	1,34	47,00	12,05	-	1292	-	1486
387	047	120	XX	YY	00	6	477	1200	948	484	1,34	28,80	9,18	-	918	-	1056
		140				6	477	1400	1092	557	1,34	33,60	10,08	-	1009	-	1160
		160				6	477	1600	1232	629	1,35	37,80	11,04	-	1105	-	1271
		180				6	477	1800	1371	699	1,36	42,60	11,94	-	1198	-	1378
		200				6	477	2000	1507	769	1,35	46,80	12,78	-	1292	-	1486
		220				6	477	2200	1642	838	1,35	51,60	13,62	-	1386	-	1594
		240				6	477	2400	1775	906	1,34	56,40	14,46	-	1479	-	1701
387	055	120	XX	YY	00	7	557	1200	1094	558	1,34	33,60	10,71	-	1023	-	1176
		140				7	557	1400	1260	643	1,34	39,20	11,76	-	1132	-	1302
		160				7	557	1600	1422	726	1,35	44,10	12,88	-	1236	-	1421
		180				7	557	1800	1580	806	1,36	49,70	13,93	-	1344	-	1546
		200				7	557	2000	1736	886	1,36	54,60	14,91	-	1446	-	1663
		220				7	557	2200	1889	964	1,35	60,20	15,89	-	1553	-	1786
		240				7	557	2400	2040	1041	1,35	65,80	16,87	-	1663	-	1912
387	063	120	XX	YY	00	8	637	1200	1240	633	1,34	38,40	12,24	-	1129	-	1298
		140				8	637	1400	1428	729	1,35	44,80	13,44	-	1248	-	1435
		160				8	637	1600	1611	822	1,35	50,40	14,72	-	1368	-	1573
		180				8	637	1800	1790	913	1,36	56,80	15,92	-	1489	-	1712
		200				8	637	2000	1965	1003	1,36	62,40	17,04	-	1608	11387-01	1849
		220				8	637	2200	2136	1090	1,35	68,80	18,16	-	1727	-	1986
		240				8	637	2400	2305	1176	1,35	75,20	19,28	-	1848	-	2125

Conform EN442-1: 2014: radiatoren en convectoren

Voor meer details over onze artikel-data, zie artikel-database: <https://www.installdata.be>

Voor de warmteafgiftes van andere regimes, kijkt u op p. 370 (correctiefactoren)

BELGIË. Prijzen in euro (excl. BTW)

VIOLA-A VERTICAAL (V2-ZB-A)



V2-ZB-A

HOE VIOLA-A VERTICAAL BESTELLEN

Leveringstermijn 15 - 30 werkdagen
(zonder transportduur)

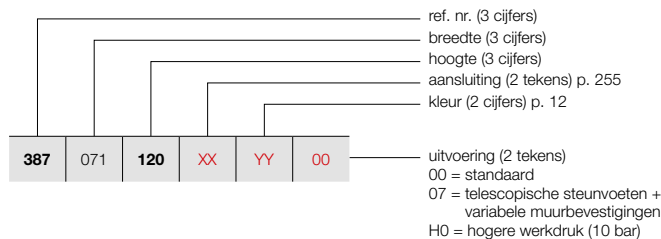

PRIJSGROEP: VPG2 - STAAL DESIGNRADIATOREN

BESTELCODE MAATWERK VIOLA-A VERTICAAL							TECHNISCHE GEGEVENS					STANDAARDKLEUR	ANDERE KLEUREN			
buizen	breedte (L mm)	hoogte (H mm)	75/65/20 (Watt) (Φ50K)	55/45/20 (Watt) (Φ30K)	n-exp.	gewicht (kg)	inhoud (l)	el. weerst. (Watt)	prijs RAL 9016 (€)	prijs kleur (€)						
REF. NR. VIOLA-A VERTICAAL V2-ZB-A : 387																
387	071	120	XX	YY	00	9	717	1200	1387	708	1,34	43,20	13,77	-	1236	1421
		140				9	717	1400	1596	814	1,35	50,40	15,12	-	1368	1573
		160				9	717	1600	1801	919	1,36	56,70	16,56	-	1500	1725
		180				9	717	1800	1999	1020	1,36	63,90	17,91	-	1634	1879
		200				9	717	2000	2194	1119	1,36	70,20	19,17	-	1769	2034
		220				9	717	2200	2384	1216	1,35	77,40	20,43	-	1903	2188
		240				9	717	2400	2570	1311	1,35	84,60	21,69	-	2033	2338
387	079	120	XX	YY	00	10	797	1200	1533	782	1,34	48,00	15,30	-	1337	1538
		140				10	797	1400	1765	901	1,35	56,00	16,80	-	1489	1712
		160				10	797	1600	1990	1015	1,36	63,00	18,40	-	1634	1879
		180				10	797	1800	2209	1127	1,37	71,00	19,90	-	1781	2048
		200				10	797	2000	2422	1236	1,36	78,00	21,30	-	1926	2215
		220				10	797	2200	2631	1342	1,36	86,00	22,70	-	2071	2382
		240				10	797	2400	2836	1447	1,35	94,00	24,10	-	2220	2553
387	087	120	XX	YY	00	11	877	1200	1679	857	1,34	52,80	16,83	-	1446	1663
		140				11	877	1400	1933	986	1,35	61,60	18,48	-	1605	1846
		160				11	877	1600	2179	1112	1,36	69,30	20,24	-	1764	2029
		180				11	877	1800	2418	1234	1,37	78,10	21,89	-	1926	2215
		200				11	877	2000	2651	1353	1,36	85,80	23,43	-	2087	2400
		220				11	877	2200	2878	1468	1,36	94,60	24,97	-	2246	2583
		240				11	877	2400	3101	1582	1,35	103,40	26,51	-	2408	2769
387	095	120	XX	YY	00	12	957	1200	1825	931	1,35	57,60	18,36	-	1551	1784
		140				12	957	1400	2101	1072	1,35	67,20	20,16	-	1723	1981
		160				12	957	1600	2369	1209	1,36	75,60	22,08	-	1899	2184
		180				12	957	1800	2628	1341	1,37	85,20	23,88	-	2070	2381
		200				12	957	2000	2880	1469	1,36	93,60	25,56	-	2246	2583
		220				12	957	2200	3126	1595	1,36	103,20	27,24	-	2416	2778
		240				12	957	2400	3366	1717	1,36	112,80	28,92	-	2593	2982
387	103	120	XX	YY	00	13	1037	1200	1972	1006	1,35	62,40	19,89	-	1764	2029
		140				13	1037	1400	2270	1158	1,36	72,80	21,84	-	1964	2259
		160				13	1037	1600	2558	1305	1,36	81,90	23,92	-	2163	2487
		180				13	1037	1800	2837	1447	1,37	92,30	25,87	-	2363	2717
		200				13	1037	2000	3109	1586	1,37	101,40	27,69	-	2564	2949
		220				13	1037	2200	3373	1721	1,36	111,80	29,51	-	2765	3180
		240				13	1037	2400	3631	1853	1,36	122,20	31,33	-	2967	3412

Conform EN442-1: 2014: radiatoren en convectoren

Voor meer details over onze artikel-data, zie artikel-database: <https://www.installdata.be>

Voor de warmteafgifte van andere regimes, kijkt u op p. 370 (correctiefactoren)
BELGIË. Prijzen in euro (excl. BTW)

TYPES

- H1-RO-A enkele rij buizen, H2-RO-A dubbele rij buizen, H1L1-RO-A, H2L1-RO-A, H2L2-RO-A (1 of 2 rijen stalen lamellen)

BUIZEN

- Horizontaal, rechthoekig 77 x 10 mm

COLLECTOREN

- H1-RO-A en H1L1-RO-A: 35 x 43 mm
- H2-RO-A en H2L1-RO-A: 35 x 41 mm
- H2L2-RO-A: 35 x 81 mm

KLEUREN

- Standaardkleur wit RAL 9016
- Uitgebreide kleurenkaart zie p. 12

SPECIAAL

- Bij types H1L1-RO-A / H2L1-RO-A en H2L2-RO-A zijn 1 of 2 rijen stalen lamellen ter verhoging van de warmteafgifte op de platovale buizen gepuntlast.
- Standaard met rooster.
- H1L1-RO-A ook verkrijgbaar als toiletradiator (500 x 400 mm)

BEVESTIGINGEN

- Muurbevestigingen standaard (inbegrepen in de verpakking van de radiator)
- Bovenste beugel in kleur van de radiator, onderaan:
 - Afstandshouder radiator wit = afstandshouder wit.
 - Afstandshouder radiator in kleur = afstandshouder RAL 7024.
- **H2-RO-A/H2L1-RO-A:** Radiator met telescopische steunvoeten + variabele muurbevestiging: gelieve bij bestelling code **07** aan te geven bij "Afwerking" (zie p. 252).
- **H2-RO-A/H2L1-RO-A:** Ook verkrijgbaar als vrijstaande radiator (zie p. 253)

TECHNISCH

- Weerstandsgelast (onzichtbare lasnaden)
- ATL-grondlaag, poedercoating
- Standaardwerkdruk: 4 bar. Meerprijs hogere werkdruk (10 bar): +10%.
- De leveringstermijn van radiator met een hogere werkdruk is 1 week extra.
- Maximale bedrijfstemperatuur: 110°C

ELEKTRISCH

- ✗ Zuiver elektrische radiator in de fabriek voorgevuld
- ✗ Gemengde radiator

TECHNISCHE TEKENINGEN

- Zie p. 257

AANSLUITING

- ✗ Eénpuntsaansluiting voor éénpijpsysteem
- ✗ Eénpuntsaansluiting voor tweepijpsysteem
- ✓ Tweepuntsaansluiting voor éénpijpsysteem (aansluiting via het geïntegreerd ventiel) (zie p. 363)
- ✓ Tweepuntsaansluiting voor tweepijpsysteem (standaard) (zie p. 362)
- ✓ Geïntegreerd ventiel (**meerprijs €120**) (radiator speciaal te bestellen) (zie p. 363)
- Aansluitingen: 1/2" (binnendraad)



STAAL DESIGNRADIATOREN

VIOLA-A HORIZONTAAL

In het verlengde van een grote traditie

Ook de Viola-A Horizontaal combineert, net als de Viola-A Verticaal een sobere, uniforme look met een optimale warmteafgifte. De radiator is beschikbaar in enkele en dubbele uitvoering. Het design is sober en overal toepasbaar. Kan ook in een vrijstaande opstelling worden geïnstalleerd.

AANBEVOLEN AANSLUITING

GEÏNTEGREERD VENTIEL (MEERPRIJS)

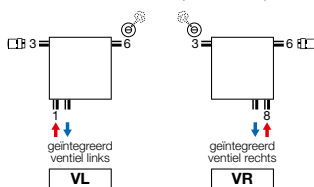

Meerprijs: €120 (zie p. 363)

Andere aansluitmogelijkheden, zie p. 255
Thermostaatkop apart te bestellen



art. nr. 1182 301 0000 0099

prijs €157

Koppelingen, zie p. 377



art. nr. 11911630102

prijs €48

Thermostaatkop apart te bestellen

AANBEVOLEN VOOR BADKAMER EN KEUKEN IN OPTIE



handdoekbeugel (RAL 9005)

art. nr. zie p. 254

prijs €157

Andere accessoires, zie p. 254



H2-RO-A / H2L1-RO-A

VIOLA-A HORIZONTAAL (H1-RO-A)



H1-RO-A
(thermostaatkop apart te bestellen)

HOE VIOLA-A HORIZONTAAL BESTELLEN

Leveringstermijn 15 - 30 werkdagen
(zonder transportduur)

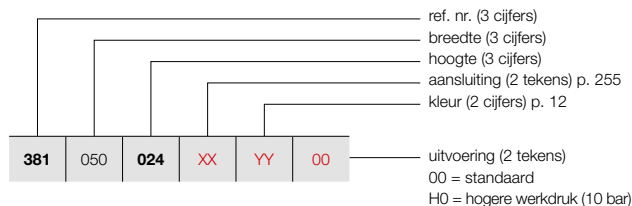

PRIJSGROEP: VPG2 - STAAL DESIGNRADIATOREN

BESTELCODE MAATWERK VIOLA-A HORIZONTAAL	TECHNISCHE GEGEVENS									STANDAARDKLEUR	ANDERE KLEUREN					
	buizen	breedte (L mm)	hoogte (H mm)	75/65/20 (Watt) (Φ50K)	55/45/20 (Watt) (Φ30K)	n-exp.	gewicht (kg)	inhoud (l)	el. weerst. (Watt)	prijs RAL 9016 (€)	prijs kleur (€)					
REF. NR. VIOLA-A HORIZONTAAL H1-RO-A : 381																
381	050	024	XX	YY	00	3	500	240	141	72	1,25	3,15	1,00	-	265	305
		032				4	500	320	179	91	1,25	3,25	1,40	-	418	343
		040				5	500	400	223	114	1,26	5,50	1,70	-	455	523
		048				6	500	480	266	136	1,26	6,60	2,05	-	487	542
		056				7	500	560	310	158	1,26	7,70	2,40	-	402	462
		064				8	500	640	353	180	1,26	8,80	2,75	-	439	505
		072				9	500	720	396	202	1,26	9,90	3,10	-	474	545
		080				10	500	800	438	223	1,26	11,00	3,50	-	509	585
		088				11	500	880	481	245	1,27	12,10	3,85	-	545	627
381	060	024	XX	YY	00	3	600	240	169	86	1,25	3,78	1,20	-	284	327
		032				4	600	320	215	110	1,25	3,90	1,68	-	323	371
		040				5	600	400	267	136	1,26	6,60	2,04	-	361	415
		048				6	600	480	319	163	1,26	7,92	2,46	-	401	461
		056				7	600	560	371	189	1,26	9,24	2,88	-	562	628
		064				8	600	640	423	216	1,26	10,56	3,30	-	599	671
		072				9	600	720	475	242	1,26	11,88	3,72	-	518	596
		080				10	600	800	526	268	1,26	13,20	4,20	-	561	645
		088				11	600	880	577	294	1,27	14,52	4,62	-	598	688
381	070	024	XX	YY	00	3	700	240	197	100	1,25	4,41	1,40	-	308	354
		032				4	700	320	251	128	1,25	4,55	1,96	-	350	403
		040				5	700	400	312	159	1,26	7,70	2,38	-	395	454
		048				6	700	480	372	190	1,26	9,24	2,87	-	434	619
		056				7	700	560	433	221	1,26	10,78	3,36	-	478	550
		064				8	700	640	494	252	1,26	12,32	3,85	-	519	597
		072				9	700	720	554	283	1,26	13,86	4,34	-	564	649
		080				10	700	800	613	313	1,26	15,40	4,90	-	607	698
		088				11	700	880	673	343	1,27	16,94	5,39	-	651	749
381	080	024	XX	YY	00	3	800	240	225	115	1,25	5,04	1,60	-	327	376
		032				4	800	320	286	146	1,25	5,20	2,24	-	376	432
		040				5	800	400	356	182	1,26	8,80	2,72	-	421	484
		048				6	800	480	426	217	1,26	10,56	3,28	-	471	542
		056				7	800	560	495	253	1,26	12,32	3,84	-	516	593
		064				8	800	640	564	288	1,26	14,08	4,40	-	563	647
		072				9	800	720	633	323	1,26	15,84	4,96	-	729	820
		080				10	800	800	701	358	1,26	17,60	5,60	-	654	752
		088				11	800	880	769	392	1,27	19,36	6,16	-	703	928
381	090	024	XX	YY	00	3	900	240	253	129	1,25	5,67	1,80	-	350	403
		032				4	900	320	322	164	1,25	5,85	2,52	-	400	460
		040				5	900	400	401	204	1,26	9,90	3,06	-	448	515
		048				6	900	480	479	244	1,26	11,88	3,69	-	502	577
		056				7	900	560	557	284	1,26	13,86	4,32	-	557	641
		064				8	900	640	635	324	1,26	15,84	4,95	-	605	696
		072				9	900	720	712	363	1,26	17,82	5,58	-	653	751
		080				10	900	800	788	402	1,26	19,80	6,30	-	707	813
		088				11	900	880	865	441	1,27	21,78	6,93	-	756	869

Conform EN442-1: 2014: radiatoren en convectoren

Voor meer details over onze artikel-data, zie artikel-database: <https://www.installdata.be>

Voor de warmteafgiftes van andere regimes, kijkt u op p. 370 (correctiefactoren)
BELGIË. Prijzen in euro (excl. BTW)

HOE VIOLA-A HORIZONTAAL BESTELLEN

Leveringstermijn 15 - 30 werkdagen
(zonder transportduur)

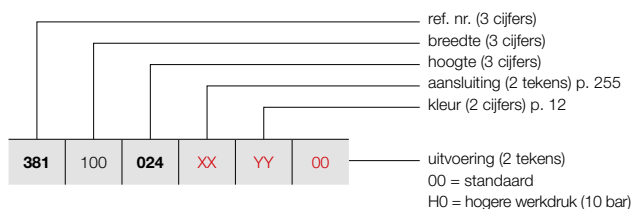

VIOLA-A HORIZONTAAL (H1-RO-A)

233



H1-RO-A
(thermostaatkop apart te bestellen)

PRIJSGROEP: VPG2 - STAAL DESIGNRADIATOREN

BESTELCODE MAATWERK VIOLA-A HORIZONTAAL	TECHNISCHE GEGEVENS							STANDAARDKLEUR		ANDERE KLEUREN	
	buizen	breedte (L mm)	hoogte (H mm)	75/65/20 (Watt) (Φ50K)	55/45/20 (Watt) (Φ30K)	n-exp.	gewicht (kg)	inhoud (l)	el. weerst. (Watt)	prijs RAL 9016 (€)	prijs kleur (€)
REF. NR. VIOLA-A HORIZONTAAL H1-RO-A : 381											
381	100	024	XX	YY	00						
		032								368	423
		040								425	489
		048								479	551
		056								534	614
		064								587	675
		072								646	743
		080								698	803
		088								754	867
										809	930
381	110	024	XX	YY	00						
		032								395	454
		040								448	515
		048								509	585
		056								568	653
		064								647	721
		072								747	821
		080								864	947
		088								948	1026
										1022	1115
381	120	024	XX	YY	00						
		032								412	474
		040								475	546
		048								537	618
		056								598	688
		064								666	766
		072								724	818
		080								792	891
		088								852	980
										915	1052
381	140	024	XX	YY	00						
		032								456	524
		040								527	606
		048								598	688
		056								669	769
		064								737	848
		072								809	930
		080								878	1010
		088								953	1096
										1022	1175
381	160	024	XX	YY	00						
		032								498	573
		040								577	664
		048								654	752
		056								735	845
		064								814	936
		072								892	1026
		080								970	1116
		088								1048	1205
										1129	1298

Conform EN442-1: 2014: radiatoren en convectoren

Voor meer details over onze artikel-data, zie artikel-database: <https://www.installdata.be>

Voor de warmteafgiftes van andere regimes, kijkt u op p. 370 (correctiefactoren)
BELGIË. Prijzen in euro (excl. BTW)

VIOLA-A HORIZONTAAL (H1-RO-A)



H1-RO-A
(thermostaatkop apart te bestellen)

HOE VIOLA-A HORIZONTAAL BESTELLEN

Leveringstermijn 15 - 30 werkdagen
(zonder transportduur)

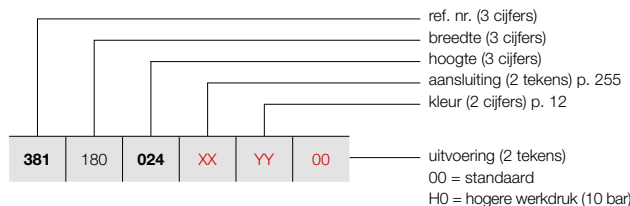

PRIJSGROEP: VPG2 - STAAL DESIGNRADIATOREN

BESTELCODE MAATWERK VIOLA-A HORIZONTAAL	TECHNISCHE GEGEVENS									STANDAARDKLEUR	ANDERE KLEUREN
	buizen	breedte (L mm)	hoogte (H mm)	75/65/20 (Watt) (Ø50K)	55/45/20 (Watt) (Ø30K)	n-exp.	gewicht (kg)	inhoud (l)	el. weerst. (Watt)	prijs RAL 9016 (€)	prijs kleur (€)
REF. NR. VIOLA-A HORIZONTAAL H1-RO-A : 381											
381	180	024	XX	YY	00						
		032								542	623
		040								628	722
		048								716	823
		056								803	923
		064								888	1021
		072								974	1120
		080								1062	1221
		088								1147	1319
										1233	1418
381	200	024	XX	YY	00						
		032								582	669
		040								677	779
		048								771	887
		056								867	997
		064								1083	1107
		072								1054	1212
		080								1150	1323
		088								1243	1429
										1336	1536
381	220	024	XX	YY	00						
		032								627	721
		040								730	840
		048								832	957
		056								932	1072
		064								1038	1194
		072								1138	1309
		080								1239	1425
		088								1342	1543
										1444	1661
381	240	024	XX	YY	00						
		032								670	771
		040								783	900
		048								892	1026
		056								1003	1153
		064								1111	1278
		072								1223	1406
		080								1329	1528
		088								1440	1656
										1550	1783
381	260	024	XX	YY	00						
		032								714	821
		040								831	956
		048								950	1093
		056								1068	1228
		064								1186	1364
		072								1302	1497
		080								1421	1634
		088								1541	1772
										1656	1904

Conform EN442-1: 2014: radiatoren en convectoren

Voor meer details over onze artikel-data, zie artikel-database: <https://www.installdata.be>
Voor de warmteafgifte van andere regimes, kijkt u op p. 370 (correctiefactoren)
BELGIË. Prijzen in euro (excl. BTW)

HOE VIOLA-A HORIZONTAAL BESTELLEN

Leveringstermijn 15 - 30 werkdagen
(zonder transportduur)

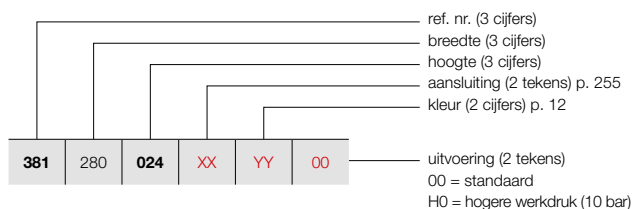

VIOLA-A HORIZONTAAL (H1-RO-A)

235



H1-RO-A
(thermostaatkop apart te bestellen)

PRIJSGROEP: VPG2 - STAAL DESIGNRADIATOREN

BESTELCODE MAATWERK VIOLA-A HORIZONTAAL	TECHNISCHE GEGEVENS							STANDAARDKLEUR		ANDERE KLEUREN	
	buizen	breedte (L mm)	hoogte (H mm)	75/65/20 (Watt) (Φ50K)	55/45/20 (Watt) (Φ30K)	n-exp.	gewicht (kg)	inhoud (l)	el. weerst. (Watt)	prijs RAL 9016 (€)	prijs kleur (€)
REF. NR. VIOLA-A HORIZONTAAL H1-RO-A : 381											
381	280	024	XX	YY	00						
		032								756	869
		040								881	1013
		048								1007	1158
		056								1135	1305
		064								1258	1447
		072								1386	1594
		080								1511	1738
		088								1636	1881
										1762	2026
381	300	024	XX	YY	00						
		032								799	919
		040								930	1070
		048								1067	1227
		056								1199	1379
		064								1332	1532
		072								1469	1689
		080								1598	1838
		088								1732	1992
										1867	2147

Conform EN442-1: 2014: radiatoren en convectoren

Voor meer details over onze artikel-data, zie artikel-database: <https://www.installdata.be>
Voor de warmteafgiftes van andere regimes, kijkt u op p. 370 (correctiefactoren)
BELGIË. Prijzen in euro (excl. BTW)

VIOLA-A HORIZONTAAL (H1L1-RO-A)



H1L1-RO-A
(thermostaatkop apart te bestellen)

HOE VIOLA-A HORIZONTAAL BESTELLEN

Leveringstermijn 15 - 30 werkdagen
(zonder transportduur)

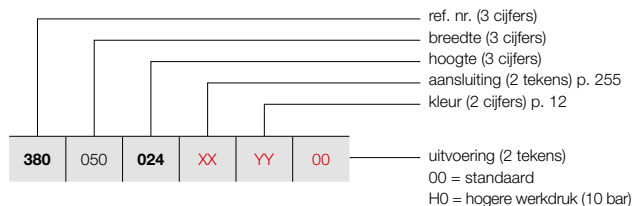

PRIJSGROEP: VPG2 - STAAL DESIGNRADIATOREN

BESTELCODE MAATWERK VIOLA-A HORIZONTAAL							TECHNISCHE GEGEVENS					STANDAARDKLEUR	ANDERE KLEUREN			
buizen	breedte (L mm)	hoogte (H mm)	75/65/20 (Watt) (Φ50K)	55/45/20 (Watt) (Φ30K)	n-exp.	gewicht (kg)	inhoud (l)	el. weerst. (Watt)	prijs RAL 9016 (€)	prijs kleur (€)						
REF. NR. VIOLA-A HORIZONTAAL H1L1-RO-A : 380																
380	050	024	XX	YY	00	3	500	240	261	133	1,24	5,45	1,00	-	305	351
		032				4	500	320	334	170	1,26	7,30	1,40	-	349	401
		040				5	500	400	399	204	1,27	9,10	1,70	-	516	575
		048				6	500	480	464	237	1,28	10,95	2,05	-	440	506
		056				7	500	560	530	270	1,30	12,75	2,40	-	488	561
		064				8	500	640	581	296	1,30	14,60	2,75	-	532	612
		072				9	500	720	618	315	1,30	15,70	3,10	-	578	665
		080				10	500	800	684	349	1,31	18,25	3,50	-	626	840
		088				11	500	880	719	367	1,31	19,35	3,85	-	670	771
380	060	024	XX	YY	00	3	600	240	313	160	1,24	6,54	1,20	-	331	381
		032				4	600	320	401	204	1,26	8,76	1,68	-	388	446
		040				5	600	400	479	244	1,27	10,92	2,04	-	558	624
		048				6	600	480	557	284	1,28	13,14	2,46	-	489	562
		056				7	600	560	635	324	1,30	15,30	2,88	-	537	618
		064				8	600	640	697	356	1,30	17,52	3,30	-	590	679
		072				9	600	720	741	378	1,30	18,84	3,72	-	646	743
		080				10	600	800	821	419	1,31	21,90	4,20	-	696	800
		088				11	600	880	863	440	1,31	23,22	4,62	-	751	864
380	070	024	XX	YY	00	3	700	240	365	186	1,24	7,63	1,40	-	359	413
		032				4	700	320	468	239	1,26	10,22	1,96	-	419	482
		040				5	700	400	559	285	1,27	12,74	2,38	-	478	550
		048				6	700	480	650	331	1,28	15,33	2,87	-	535	615
		056				7	700	560	741	378	1,30	17,85	3,36	-	714	683
		064				8	700	640	813	415	1,30	20,44	3,85	-	771	869
		072				9	700	720	865	441	1,30	21,98	4,34	-	712	819
		080				10	700	800	958	489	1,31	25,55	4,90	-	766	881
		088				11	700	880	1007	514	1,31	27,09	5,39	-	826	950
380	080	024	XX	YY	00	3	800	240	418	213	1,24	8,72	1,60	-	394	453
		032				4	800	320	534	273	1,26	11,68	2,24	-	456	524
		040				5	800	400	638	326	1,27	14,56	2,72	-	518	596
		048				6	800	480	742	379	1,28	17,52	3,28	-	581	668
		056				7	800	560	847	432	1,30	20,40	3,84	-	649	746
		064				8	800	640	930	474	1,30	23,36	4,40	-	833	940
		072				9	800	720	988	504	1,30	25,12	4,96	-	776	892
		080				10	800	800	1094	558	1,31	29,20	5,60	-	840	966
		088				11	800	880	1150	587	1,31	30,96	6,16	-	1024	1160
380	090	024	XX	YY	00	3	900	240	470	240	1,24	9,81	1,80	-	421	484
		032				4	900	320	601	307	1,26	13,14	2,52	-	492	566
		040				5	900	400	718	366	1,27	16,38	3,06	-	562	646
		048				6	900	480	835	426	1,28	19,71	3,69	-	630	725
		056				7	900	560	953	486	1,30	22,95	4,32	-	701	806
		064				8	900	640	1046	534	1,30	26,28	4,95	-	770	886
		072				9	900	720	1112	567	1,30	28,26	5,58	-	841	967
		080				10	900	800	1231	628	1,31	32,85	6,30	-	913	1050
		088				11	900	880	1294	660	1,31	34,83	6,93	-	982	1129

HOE VIOLA-A HORIZONTAAL BESTELLEN

Leveringstermijn 15 - 30 werkdagen
(zonder transportduur)

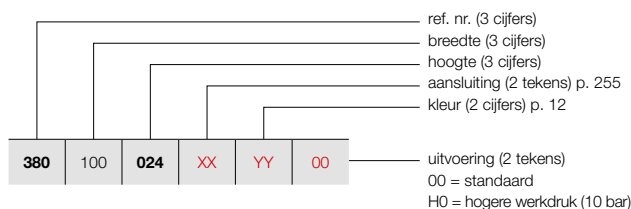

VIOLA-A HORIZONTAAL (H1L1-RO-A)



H1L1-RO-A
(thermostaatkop apart te bestellen)

PRIJSGROEP: VPG2 - STAAL DESIGNRADIATOREN

BESTELCODE MAATWERK VIOLA-A HORIZONTAAL	TECHNISCHE GEGEVENS							STANDAARDKLEUR	ANDERE KLEUREN			
	buizen	breedte (L mm)	hoogte (H mm)	75/65/20 (Watt) (φ50K)	55/45/20 (Watt) (φ30K)	n-exp.	gewicht (kg)			inhoud (l)	el. weerst. (Watt)	prijs RAL 9016 (€)
REF. NR. VIOLA-A HORIZONTAAL H1L1-RO-A : 380												
380 100 024 XX YY 00	3	1000	240	522	266	1,24	10,90	2,00	-	448	515	
	4	1000	320	668	341	1,26	14,60	2,80	-	524	603	
	5	1000	400	798	407	1,27	18,20	3,40	-	605	696	
	6	1000	480	928	473	1,28	21,90	4,10	-	677	779	
	7	1000	560	1059	540	1,30	25,50	4,80	-	754	867	
	8	1000	640	1162	593	1,30	29,20	5,50	-	831	956	
	9	1000	720	1235	630	1,30	31,40	6,20	-	907	1043	
	10	1000	800	1368	698	1,31	36,50	7,00	-	982	1129	
	11	1000	880	1438	734	1,31	38,70	7,70	-	1061	1220	
	380 110 024 XX YY 00	3	1100	240	574	293	1,24	11,99	2,20	-	479	551
		4	1100	320	735	375	1,26	16,06	3,08	-	563	647
5		1100	400	878	448	1,27	20,02	3,74	-	646	743	
6		1100	480	1021	521	1,28	24,09	4,51	-	726	835	
7		1100	560	1165	594	1,30	28,05	5,28	-	809	930	
8		1100	640	1278	652	1,30	32,12	6,05	-	892	1026	
9		1100	720	1359	693	1,30	34,54	6,82	-	971	1117	
10		1100	800	1505	768	1,31	40,15	7,70	-	1053	1211	
11		1100	880	1582	807	1,31	42,57	8,47	-	1136	1306	
380 120 024 XX YY 00		3	1200	240	626	320	1,24	13,08	2,40	-	510	587
		4	1200	320	802	409	1,26	17,52	3,36	-	598	688
	5	1200	400	958	489	1,27	21,84	4,08	-	684	787	
	6	1200	480	1114	568	1,28	26,28	4,92	-	774	1010	
	7	1200	560	1271	648	1,30	30,60	5,76	-	863	992	
	8	1200	640	1394	711	1,30	35,04	6,60	-	950	1093	
	9	1200	720	1482	756	1,30	37,68	7,44	-	1039	1195	
	10	1200	800	1642	838	1,31	43,80	8,40	-	1128	1297	
	11	1200	880	1726	880	1,31	46,44	9,24	-	1214	1396	
	380 140 024 XX YY 00	3	1400	240	731	373	1,24	15,26	2,80	-	568	653
		4	1400	320	935	477	1,26	20,44	3,92	-	670	771
5		1400	400	1117	570	1,27	25,48	4,76	-	767	882	
6		1400	480	1299	663	1,28	30,66	5,74	-	869	999	
7		1400	560	1483	756	1,30	35,70	6,72	-	970	1236	
8		1400	640	1627	830	1,30	40,88	7,70	-	1069	1229	
9		1400	720	1729	882	1,30	43,96	8,68	-	1167	1342	
10		1400	800	1915	977	1,31	51,10	9,80	-	1272	1463	
11		1400	880	2013	1027	1,31	54,18	10,78	-	1368	1573	
380 160 024 XX YY 00		3	1600	240	835	426	1,24	17,44	3,20	-	628	722
		4	1600	320	1069	545	1,26	23,36	4,48	-	740	851
	5	1600	400	1277	651	1,27	29,12	5,44	-	852	980	
	6	1600	480	1485	758	1,28	35,04	6,56	-	966	1111	
	7	1600	560	1694	864	1,30	40,80	7,68	-	1078	1240	
	8	1600	640	1859	949	1,30	46,72	8,80	-	1188	1366	
	9	1600	720	1976	1008	1,30	50,24	9,92	-	1301	1496	
	10	1600	800	2189	1117	1,31	58,40	11,20	-	1410	1622	
	11	1600	880	2301	1174	1,31	61,92	12,32	-	1526	1755	

Conform EN442-1: 2014: radiatoren en convectoren

Voor meer details over onze artikel-data, zie artikel-database: <https://www.installdata.be>

Voor de warmteafgiftes van andere regimes, kijkt u op p. 370 (correctiefactoren)
BELGIË. Prijzen in euro (excl. BTW)

VIOLA-A HORIZONTAAL (H1L1-RO-A)



H1L1-RO-A
(thermostaatkop apart te bestellen)

HOE VIOLA-A HORIZONTAAL BESTELLEN

Leveringstermijn 15 - 30 werkdagen
(zonder transportduur)

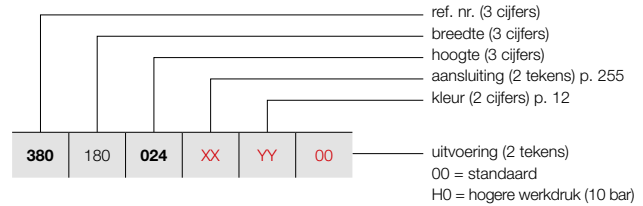

PRIJSGROEP: VPG2 - STAAL DESIGNRADIATOREN

BESTELCODE MAATWERK VIOLA-A HORIZONTAAL	TECHNISCHE GEGEVENS									STANDAARDKLEUR	ANDERE KLEUREN
	buizen	breedte (L mm)	hoogte (H mm)	75/65/20 (Watt) (Ø50K)	55/45/20 (Watt) (Ø30K)	n-exp.	gewicht (kg)	inhoud (l)	el. weerst. (Watt)	prijs RAL 9016 (€)	prijs kleur (€)
REF. NR. VIOLA-A HORIZONTAAL H1L1-RO-A : 380											
380	180	024	XX	YY	00						
		032								686	789
		040								811	933
		048								933	1073
		056								1061	1220
		064								1186	1364
		072								1309	1505
		080								1434	1649
		088								1553	1786
										1678	1930
380	200	024	XX	YY	00						
		032								750	863
		040								881	1013
		048								1021	1174
		056								1155	1328
		064								1292	1486
		072								1431	1646
		080								1564	1799
		088								1697	1952
										1836	2111
380	220	024	XX	YY	00						
		032								808	929
		040								956	1099
		048								1104	1270
		056								1249	1436
		064								1397	1607
		072								1546	1778
		080								1694	1948
		088								1840	2116
										1990	2289
380	240	024	XX	YY	00						
		032								865	995
		040								1024	1178
		048								1187	1365
		056								1346	1548
		064								1504	1730
		072								1668	1918
		080								1827	2101
		088								1984	2282
										2146	2468
380	260	024	XX	YY	00						
		032								923	1061
		040								1094	1258
		048								1271	1462
		056								1440	1656
		064								1612	1854
		072								1783	2050
		080								1958	2252
		088								2128	2447
										2300	2645

Conform EN442-1: 2014: radiatoren en convectoren

Voor meer details over onze artikel-data, zie artikel-database: <https://www.installdata.be>

Voor de warmteafgiftes van andere regimes, kijkt u op p. 370 (correctiefactoren)
BELGIË. Prijzen in euro (excl. BTW)

HOE VIOLA-A HORIZONTAAL BESTELLEN

Leveringstermijn 15 - 30 werkdagen
(zonder transportduur)

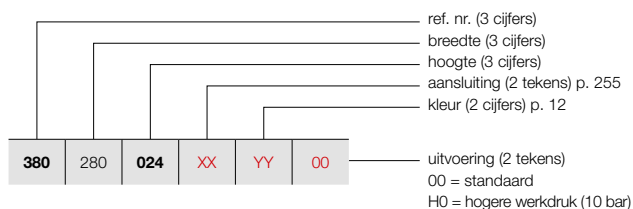

VIOLA-A HORIZONTAAL (H1L1-RO-A)

239



H1L1-RO-A
(thermostaatkop apart te bestellen)

PRIJSGROEP: VPG2 - STAAL DESIGNRADIATOREN

BESTELCODE MAATWERK VIOLA-A HORIZONTAAL	TECHNISCHE GEGEVENS								STANDAARDKLEUR		ANDERE KLEUREN					
	buizen	breedte (L mm)	hoogte (H mm)	75/65/20 (Watt) (Φ50K)	55/45/20 (Watt) (Φ30K)	n-exp.	gewicht (kg)	inhoud (l)	el. weerst. (Watt)	prijs RAL 9016 (€)	prijs kleur (€)					
REF. NR. VIOLA-A HORIZONTAAL H1L1-RO-A : 380																
380	280	024	XX	YY	00	3	2800	240	1462	746	1,24	30,52	5,60	-	983	1130
		032				4	2800	320	1870	954	1,26	40,88	7,84	-	1167	1342
		040				5	2800	400	2234	1140	1,27	50,96	9,52	-	1351	1554
		048				6	2800	480	2598	1326	1,28	61,32	11,48	-	1535	1765
		056				7	2800	560	2965	1513	1,30	71,40	13,44	-	1721	1979
		064				8	2800	640	3254	1660	1,30	81,76	15,40	-	1904	2190
		072				9	2800	720	3458	1764	1,30	87,92	17,36	-	2089	2402
		080				10	2800	800	3830	1954	1,31	102,20	19,60	-	2273	2614
		088				11	2800	880	4026	2054	1,31	108,36	21,56	-	2456	2824
380	300	024	XX	YY	00	3	3000	240	1566	799	1,24	32,70	6,00	-	1045	1202
		032				4	3000	320	2004	1022	1,26	43,80	8,40	-	1238	1424
		040				5	3000	400	2394	1221	1,27	54,60	10,20	-	1437	1653
		048				6	3000	480	2784	1420	1,28	65,70	12,30	-	1632	1877
		056				7	3000	560	3177	1621	1,30	76,50	14,40	-	1829	2103
		064				8	3000	640	3486	1779	1,30	87,60	16,50	-	2021	2324
		072				9	3000	720	3705	1890	1,30	94,20	18,60	-	2220	2553
		080				10	3000	800	4104	2094	1,31	109,50	21,00	-	2413	2775
		088				11	3000	880	4314	2201	1,31	116,10	23,10	-	2608	2999

Conform EN442-1: 2014: radiatoren en convectoren

Voor meer details over onze artikel-data, zie artikel-database: <https://www.installdata.be>
Voor de warmteafgiftes van andere regimes, kijkt u op p. 370 (correctiefactoren)
BELGIË. Prijzen in euro (excl. BTW)

VIOLA-A HORIZONTAAL (H2-RO-A)



H2-RO-A
(thermostaatkop apart te bestellen)

HOE VIOLA-A HORIZONTAAL BESTELLEN

Leveringstermijn 15 - 30 werkdagen
(zonder transportduur)

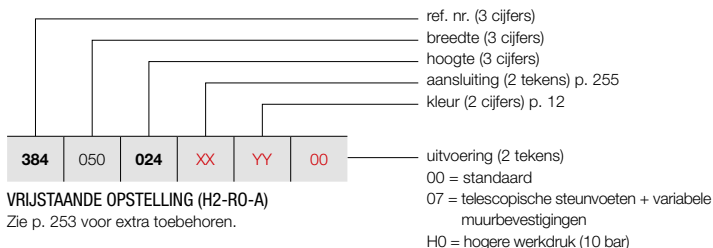

VRIJSTAANDE OPSTELLING (H2-RO-A)

Zie p. 253 voor extra toebehoren.

PRIJSGROEP: VPG2 - STAAL DESIGNRADIATOREN

BESTELCODE MAATWERK VIOLA-A HORIZONTAAL	TECHNISCHE GEGEVENS									STANDAARDKLEUR	ANDERE KLEUREN
	buizen	breedte (L mm)	hoogte (H mm)	75/65/20 (Watt) (Φ50K)	55/45/20 (Watt) (Φ30K)	n-exp.	gewicht (kg)	inhoud (l)	el. weerst. (Watt)	prijs RAL 9016 (€)	prijs kleur (€)
REF. NR. VIOLA-A HORIZONTAAL H2-RO-A : 384											
384	050	024	XX	YY	00						
		032								498	573
		040								568	653
		048								641	737
		056								712	819
		064								781	898
		072								850	978
		080								919	1057
		088								990	1139
										1062	1221
384	060	024	XX	YY	00						
		032								535	615
		040								614	706
		048								690	794
		056								770	886
		064								847	1094
		072								924	1063
		080								1005	1156
		088								1083	1245
										1158	1332
384	070	024	XX	YY	00						
		032								574	660
		040								663	762
		048								748	860
		056								831	956
		064								916	1053
		072								1005	1156
		080								1090	1254
		088								1176	1352
										1260	1449
384	080	024	XX	YY	00						
		032								611	703
		040								706	812
		048								799	919
		056								893	1027
		064								985	1133
		072								1081	1243
		080								1174	1350
		088								1271	1462
										1362	1566
384	090	024	XX	YY	00						
		032								649	746
		040								752	865
		048								972	980
		056								954	1097
		064								1054	1212
		072								1156	1329
		080								1257	1446
		088								1362	1566
										1464	1684

Conform EN442-1: 2014: radiatoren en convectoren

Voor meer details over onze artikel-data, zie artikel-database: <https://www.installdata.be>
Voor de warmteafgiftes van andere regimes, kijkt u op p. 370 (correctiefactoren)
BELGIË. Prijzen in euro (excl. BTW)

HOE VIOLA-A HORIZONTAAL BESTELLEN

Leveringstermijn 15 - 30 werkdagen
(zonder transportduur)

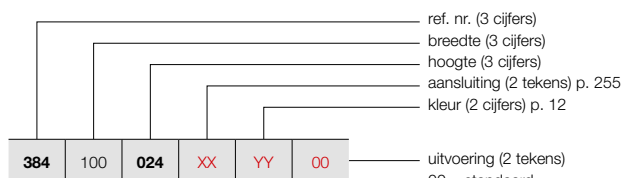

VRIJSTAANDE OPSTELLING (H2-RO-A)

Zie p. 253 voor extra toebehoren.

VIOLA-A HORIZONTAAL (H2-RO-A)



H2-RO-A
(thermostaatkop apart te bestellen)

PRIJSGROEP: VPG2 - STAAL DESIGNRADIATOREN

BESTELCODE MAATWERK VIOLA-A HORIZONTAAL	TECHNISCHE GEGEVENS							STANDAARDKLEUR	ANDERE KLEUREN			
	buizen	breedte (L mm)	hoogte (H mm)	75/65/20 (Watt) (Φ50K)	55/45/20 (Watt) (Φ30K)	n-exp.	gewicht (kg)			inhoud (l)	el. weerst. (Watt)	prijs RAL 9016 (€)
REF. NR. VIOLA-A HORIZONTAAL H2-RO-A : 384												
384 100 024 XX YY 00	3	1000	240	436	222	1,23	12,20	3,40	-	684	787	
	4	1000	320	545	278	1,22	16,30	4,50	-	797	917	
	5	1000	400	658	336	1,23	20,30	5,70	-	905	1041	
	6	1000	480	778	397	1,25	24,40	6,90	-	1012	1164	
	7	1000	560	907	463	1,26	28,50	8,10	-	1247	1416	
	8	1000	640	1046	534	1,27	32,50	9,30	-	1354	1539	
	9	1000	720	1199	612	1,28	36,60	10,50	-	1344	1546	
	10	1000	800	1325	676	1,28	40,70	11,40	-	1449	1666	
	11	1000	880	1451	740	1,29	44,70	12,40	-	1562	1796	
	384 110 024 XX YY 00	3	1100	240	480	245	1,23	13,42	3,74	-	723	831
		4	1100	320	600	306	1,22	17,93	4,95	-	840	966
5		1100	400	724	369	1,23	22,33	6,27	-	960	1104	
6		1100	480	856	437	1,25	26,84	7,59	-	1074	1235	
7		1100	560	998	509	1,26	31,35	8,91	-	1192	1371	
8		1100	640	1151	587	1,27	35,75	10,23	-	1311	1508	
9		1100	720	1319	673	1,28	40,26	11,55	-	1431	1646	
10		1100	800	1458	744	1,28	44,77	12,54	-	1545	1777	
11		1100	880	1596	814	1,29	49,17	13,64	-	1661	1910	
384 120 024 XX YY 00		3	1200	240	523	267	1,23	14,64	4,08	-	758	872
		4	1200	320	654	334	1,22	19,56	5,40	-	882	1014
	5	1200	400	790	403	1,23	24,36	6,84	-	1009	1160	
	6	1200	480	934	476	1,25	29,28	8,28	-	1256	1306	
	7	1200	560	1088	555	1,26	34,20	9,72	-	1380	1449	
	8	1200	640	1255	640	1,27	39,00	11,16	-	1387	1595	
	9	1200	720	1439	734	1,28	43,92	12,60	-	1511	1738	
	10	1200	800	1590	811	1,28	48,84	13,68	-	1636	1881	
	11	1200	880	1741	888	1,29	53,64	14,88	-	1762	2026	
	384 140 024 XX YY 00	3	1400	240	610	311	1,23	17,08	4,76	-	833	958
		4	1400	320	763	389	1,22	22,82	6,30	-	975	1121
5		1400	400	921	470	1,23	28,42	7,98	-	1115	1282	
6		1400	480	1089	556	1,25	34,16	9,66	-	1257	1446	
7		1400	560	1270	648	1,26	39,90	11,34	-	1397	1607	
8		1400	640	1464	747	1,27	45,50	13,02	-	1661	1892	
9		1400	720	1679	856	1,28	51,24	14,70	-	1680	1932	
10		1400	800	1855	946	1,28	56,98	15,96	-	1820	2093	
11		1400	880	2031	1036	1,29	62,58	17,36	-	1963	2257	
384 160 024 XX YY 00		3	1600	240	698	356	1,23	19,52	5,44	-	911	1048
		4	1600	320	872	445	1,22	26,08	7,20	-	1067	1227
	5	1600	400	1053	537	1,23	32,48	9,12	-	1225	1409	
	6	1600	480	1245	635	1,25	39,04	11,04	-	1380	1587	
	7	1600	560	1451	740	1,26	45,60	12,96	-	1535	1765	
	8	1600	640	1674	854	1,27	52,00	14,88	-	1693	1947	
	9	1600	720	1918	979	1,28	58,56	16,80	-	1849	2126	
	10	1600	800	2120	1082	1,28	65,12	18,24	-	2008	2309	
	11	1600	880	2322	1184	1,29	71,52	19,84	-	2162	2486	

Conform EN442-1: 2014: radiatoren en convectoren

Voor meer details over onze artikel-data, zie artikel-database: <https://www.installdata.be>

Voor de warmteafgiftes van andere regimes, kijkt u op p. 370 (correctiefactoren)
BELGIË. Prijzen in euro (excl. BTW)

VIOLA-A HORIZONTAAL (H2-RO-A)



H2-RO-A
(thermostaatkop apart te bestellen)

HOE VIOLA-A HORIZONTAAL BESTELLEN

Leveringstermijn 15 - 30 werkdagen
(zonder transportduur)

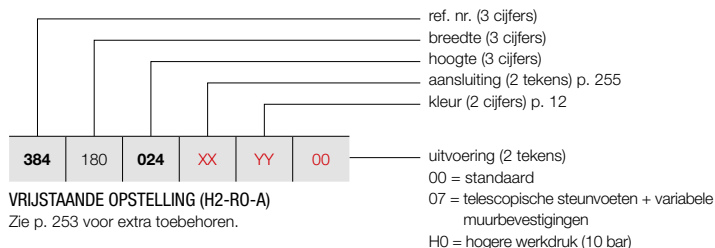

VRIJSTAANDE OPSTELLING (H2-RO-A)

Zie p. 253 voor extra toebehoren.

PRIJSGROEP: VPG2 - STAAL DESIGNRADIATOREN

BESTELCODE MAATWERK VIOLA-A HORIZONTAAL	TECHNISCHE GEGEVENS									STANDAARDKLEUR	ANDERE KLEUREN					
	buizen	breedte (L mm)	hoogte (H mm)	75/65/20 (Watt) (Φ50K)	55/45/20 (Watt) (Φ30K)	n-exp.	gewicht (kg)	inhoud (l)	el. weerst. (Watt)	prijs RAL 9016 (€)	prijs kleur (€)					
REF. NR. VIOLA-A HORIZONTAAL H2-RO-A : 384																
384	180	024	XX	YY	00	3	1800	240	785	400	1,23	21,96	6,12	-	982	1129
		032				4	1800	320	981	501	1,22	29,34	8,10	-	1155	1328
		040				5	1800	400	1184	604	1,23	36,54	10,26	-	1327	1526
		048				6	1800	480	1400	714	1,25	43,92	12,42	-	1500	1725
		056				7	1800	560	1633	833	1,26	51,30	14,58	-	1673	1924
		064				8	1800	640	1883	961	1,27	58,50	16,74	-	1847	2124
		072				9	1800	720	2158	1101	1,28	65,88	18,90	-	2016	2318
		080				10	1800	800	2385	1217	1,28	73,26	20,52	-	2192	2521
		088				11	1800	880	2612	1333	1,29	80,46	22,32	-	2362	2716
384	200	024	XX	YY	00	3	2000	240	872	445	1,23	24,40	6,80	-	1059	1218
		032				4	2000	320	1090	556	1,22	32,60	9,00	-	1244	1431
		040				5	2000	400	1316	671	1,23	40,60	11,40	-	1436	1651
		048				6	2000	480	1556	794	1,25	48,80	13,80	-	1625	1869
		056				7	2000	560	1814	926	1,26	57,00	16,20	-	1811	2083
		064				8	2000	640	2092	1067	1,27	65,00	18,60	-	2000	2300
		072				9	2000	720	2398	1223	1,28	73,20	21,00	-	2189	2517
		080				10	2000	800	2650	1352	1,28	81,40	22,80	-	2376	2732
		088				11	2000	880	2902	1481	1,29	89,40	24,80	-	2564	2949
384	220	024	XX	YY	00	3	2200	240	959	489	1,23	26,84	7,48	-	1132	1302
		032				4	2200	320	1199	612	1,22	35,86	9,90	-	1333	1533
		040				5	2200	400	1448	739	1,23	44,66	12,54	-	1542	1773
		048				6	2200	480	1712	873	1,25	53,68	15,18	-	1744	2006
		056				7	2200	560	1995	1018	1,26	62,70	17,82	-	1948	2240
		064				8	2200	640	2301	1174	1,27	71,50	20,46	-	2154	2477
		072				9	2200	720	2638	1346	1,28	80,52	23,10	-	2355	2708
		080				10	2200	800	2915	1487	1,28	89,54	25,08	-	2558	2942
		088				11	2200	880	3192	1629	1,29	98,34	27,28	-	2765	3180
384	240	024	XX	YY	00	3	2400	240	1046	534	1,23	29,28	8,16	-	1207	1388
		032				4	2400	320	1308	667	1,22	39,12	10,80	-	1424	1638
		040				5	2400	400	1579	806	1,23	48,72	13,68	-	1645	1892
		048				6	2400	480	1867	953	1,25	58,56	16,56	-	1865	2145
		056				7	2400	560	2177	1111	1,26	68,40	19,44	-	2087	2400
		064				8	2400	640	2510	1281	1,27	78,00	22,32	-	2304	2650
		072				9	2400	720	2878	1468	1,28	87,84	25,20	-	2525	2904
		080				10	2400	800	3180	1622	1,28	97,68	27,36	-	2747	3159
		088				11	2400	880	3482	1777	1,29	107,28	29,76	-	2964	3409
384	260	024	XX	YY	00	3	2600	240	1134	578	1,23	31,72	8,84	-	1278	1470
		032				4	2600	320	1417	723	1,22	42,38	11,70	-	1519	1747
		040				5	2600	400	1711	873	1,23	52,78	14,82	-	1751	2014
		048				6	2600	480	2023	1032	1,25	63,44	17,94	-	1989	2287
		056				7	2600	560	2358	1203	1,26	74,10	21,06	-	2223	2556
		064				8	2600	640	2720	1388	1,27	84,50	24,18	-	2460	2829
		072				9	2600	720	3117	1591	1,28	95,16	27,30	-	2693	3097
		080				10	2600	800	3445	1758	1,28	105,82	29,64	-	2929	3368
		088				11	2600	880	3773	1925	1,29	116,22	32,24	-	3164	3639

Conform EN442-1: 2014: radiatoren en convectoren

Voor meer details over onze artikel-data, zie artikel-database: <https://www.installdata.be>
Voor de warmteafgiftes van andere regimes, kijkt u op p. 370 (correctiefactoren)
BELGIË. Prijzen in euro (excl. BTW)

HOE VIOLA-A HORIZONTAAL BESTELLEN

Leveringstermijn 15 - 30 werkdagen
(zonder transportduur)

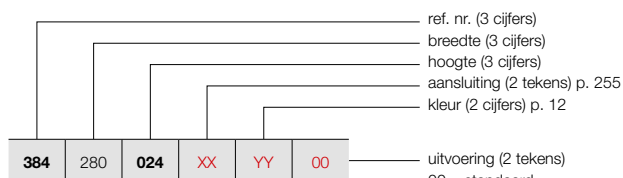

VRIJSTAANDE OPSTELLING (H2-RO-A)

Zie p. 253 voor extra toebehoren.

- 00 = standaard
- 07 = telescopische steunvoeten + variabele muurbevestigingen
- H0 = hogere werkdruk (10 bar)

VIOLA-A HORIZONTAAL (H2-RO-A)



H2-RO-A
(thermostaatkop apart te bestellen)

PRIJSGROEP: VPG2 - STAAL DESIGNRADIATOREN

BESTELCODE MAATWERK VIOLA-A HORIZONTAAL	TECHNISCHE GEGEVENS							STANDAARDKLEUR		ANDERE KLEUREN	
	buizen	breedte (L mm)	hoogte (H mm)	75/65/20 (Watt) (φ50K)	55/45/20 (Watt) (φ30K)	n-exp.	gewicht (kg)	inhoud (l)	el. weerst. (Watt)	prijs RAL 9016 (€)	prijs kleur (€)
REF. NR. VIOLA-A HORIZONTAAL H2-RO-A : 384											
384	280	024	XX	YY	00						
		032								1355	1558
		040								1605	1846
		048								1856	2134
		056								2108	2424
		064								2358	2712
		072								2610	3002
		080								2862	3291
		088								3114	3581
										3364	3869
384	300	024	XX	YY	00						
		032								1432	1647
		040								1696	1950
		048								1964	2259
		056								2233	2568
		064								2501	2876
		072								2765	3180
		080								3029	3483
		088								3298	3793
										3567	4102

Conform EN442-1: 2014: radiatoren en convectoren

Voor meer details over onze artikel-data, zie artikel-database: <https://www.installdata.be>
Voor de warmteafgiftes van andere regimes, kijkt u op p. 370 (correctiefactoren)
BELGIË. Prijzen in euro (excl. BTW)

VIOLA-A HORIZONTAAL (H2L1-RO-A)



H2L1-RO-A
(thermostaatkop apart te bestellen)

HOE VIOLA-A HORIZONTAAL BESTELLEN

Leveringstermijn 15 - 30 werkdagen
(zonder transportduur)

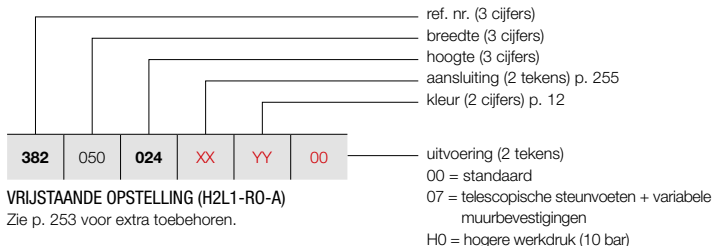

VRIJSTAANDE OPSTELLING (H2L1-RO-A)
 Zie p. 253 voor extra toebehoren.

PRIJSGROEP: VPG2 - STAAL DESIGNRADIATOREN

BESTELCODE MAATWERK VIOLA-A HORIZONTAAL							TECHNISCHE GEGEVENS					STANDAARDKLEUR	ANDERE KLEUREN			
buizen	breedte (L mm)	hoogte (H mm)	75/65/20 (Watt) (Φ50K)	55/45/20 (Watt) (Φ30K)	n-exp.	gewicht (kg)	inhoud (l)	el. weerst. (Watt)	prijs RAL 9016 (€)	prijs kleur (€)						
REF. NR. VIOLA-A HORIZONTAAL H2L1-RO-A : 382																
382	050	024 032 040 048 056 064 072 080 088	XX	YY	00	3 4 5 6 7 8 9 10 11	500 500 500 500 500 500 500 500 500	240 320 400 480 560 640 720 800 880	322 399 474 550 625 677 728 780 822	164 204 242 280 319 345 371 398 419	1,28 1,30 1,32 1,34 1,36 1,36 1,36 1,37 1,36	7,75 10,35 12,90 15,50 18,10 20,65 23,25 25,80 27,85	1,70 2,25 2,85 3,45 4,05 4,65 5,25 5,70 6,20	- - - - - - - - -	558 645 732 822 1032 1000 1086 1176 1263	642 742 842 945 1169 1150 1249 1352 1452
382	060	024 032 040 048 056 064 072 080 088	XX	YY	00	3 4 5 6 7 8 9 10 11	600 600 600 600 600 600 600 600 600	240 320 400 480 560 640 720 800 880	386 479 569 659 749 812 874 936 986	197 244 290 336 382 414 446 478 503	1,28 1,30 1,32 1,34 1,36 1,36 1,36 1,37 1,36	9,30 12,42 15,48 18,60 21,72 24,78 27,90 30,96 33,42	2,04 2,70 3,42 4,14 4,86 5,58 6,30 6,84 7,44	- - - - - - - - -	598 696 796 893 990 1087 1188 1284 1385	688 800 915 1027 1139 1250 1366 1477 1593
382	070	024 032 040 048 056 064 072 080 088	XX	YY	00	3 4 5 6 7 8 9 10 11	700 700 700 700 700 700 700 700 700	240 320 400 480 560 640 720 800 880	450 559 664 769 874 947 1019 1092 1151	230 285 339 393 446 483 520 557 587	1,28 1,30 1,32 1,34 1,36 1,36 1,36 1,37 1,36	10,85 14,49 18,06 21,70 25,34 28,91 32,55 36,12 38,99	2,38 3,15 3,99 4,83 5,67 6,51 7,35 7,98 8,68	- - - - - - - - -	643 751 857 966 1071 1180 1288 1395 1621	739 864 986 1111 1232 1357 1481 1604 1846
382	080	024 032 040 048 056 064 072 080 088	XX	YY	00	3 4 5 6 7 8 9 10 11	800 800 800 800 800 800 800 800 800	240 320 400 480 560 640 720 800 880	514 638 758 879 999 1082 1165 1248 1315	262 326 387 449 510 552 594 637 671	1,28 1,30 1,32 1,34 1,36 1,36 1,36 1,37 1,36	12,40 16,56 20,64 24,80 28,96 33,04 37,20 41,28 44,56	2,72 3,60 4,56 5,52 6,48 7,44 8,40 9,12 9,92	- - - - - - - - -	684 803 918 1037 1274 1392 1387 1504 1623	787 923 1056 1193 1447 1463 1595 1730 1866
382	090	024 032 040 048 056 064 072 080 088	XX	YY	00	3 4 5 6 7 8 9 10 11	900 900 900 900 900 900 900 900 900	240 320 400 480 560 640 720 800 880	579 718 853 989 1124 1218 1310 1404 1480	295 366 435 505 574 621 669 716 755	1,28 1,30 1,32 1,34 1,36 1,36 1,36 1,37 1,36	13,95 18,63 23,22 27,90 32,58 37,17 41,85 46,44 50,13	3,06 4,05 5,13 6,21 7,29 8,37 9,45 10,26 11,16	- - - - - - - - -	729 854 979 1109 1234 1362 1486 1612 1858	838 982 1126 1275 1419 1566 1709 1854 2119

Conform EN442-1: 2014: radiatoren en convectoren

Voor meer details over onze artikel-data, zie artikel-database: <https://www.installdata.be>
Voor de warmteafgiftes van andere regimes, kijkt u op p. 370 (correctiefactoren)
BELGIË. Prijzen in euro (excl. BTW)

HOE VIOLA-A HORIZONTAAL BESTELLEN

Leveringstermijn 15 - 30 werkdagen
(zonder transportduur)

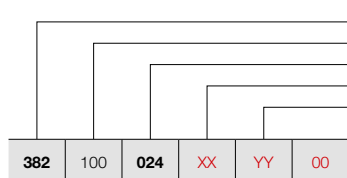

ref. nr. (3 cijfers)
breedte (3 cijfers)
hoogte (3 cijfers)
aansluiting (2 tekens) p. 255
kleur (2 cijfers) p. 12

uitvoering (2 tekens)
00 = standaard
07 = telescopische steunvoeten + variabele
muurbevestigingen
H0 = hogere werkdruk (10 bar)

VRIJSTAANDE OPSTELLING (H2L1-RO-A)

Zie p. 253 voor extra toebehoren.

VIOLA-A HORIZONTAAL (H2L1-RO-A)



H2L1-RO-A
(thermostaatkop apart te bestellen)

PRIJSGROEP: VPG2 - STAAL DESIGNRADIATOREN

BESTELCODE MAATWERK VIOLA-A HORIZONTAAL	TECHNISCHE GEGEVENS							STANDAARDKLEUR	ANDERE KLEUREN							
	buizen	breedte (L mm)	hoogte (H mm)	75/65/20 (Watt) (φ50K)	55/45/20 (Watt) (φ30K)	n-exp.	gewicht (kg)			inhoud (l)	el. weerst. (Watt)	prijs RAL 9016 (€)	prijs kleur (€)			
REF. NR. VIOLA-A HORIZONTAAL H2L1-RO-A : 382																
382	100	024	XX	YY	00	3	1000	240	643	328	1,28	15,50	3,40	-	770	886
		032				4	1000	320	798	407	1,30	20,70	4,50	-	907	1043
		040				5	1000	400	948	484	1,32	25,80	5,70	-	1045	1202
		048				6	1000	480	1099	561	1,34	31,00	6,90	-	1180	1357
		056				7	1000	560	1249	637	1,36	36,20	8,10	-	1435	1632
		064				8	1000	640	1353	690	1,36	41,30	9,30	-	1449	1666
		072				9	1000	720	1456	743	1,36	46,50	10,50	-	1586	1824
		080				10	1000	800	1560	796	1,37	51,60	11,40	-	1722	1980
		088				11	1000	880	1644	839	1,36	55,70	12,40	-	1860	2139
382	110	024	XX	YY	00	3	1100	240	707	361	1,28	17,05	3,74	-	814	936
		032				4	1100	320	878	448	1,30	22,77	4,95	-	961	1105
		040				5	1100	400	1043	532	1,32	28,38	6,27	-	1107	1273
		048				6	1100	480	1209	617	1,34	34,10	7,59	-	1249	1436
		056				7	1100	560	1374	701	1,36	39,82	8,91	-	1396	1605
		064				8	1100	640	1488	759	1,36	45,43	10,23	-	1542	1773
		072				9	1100	720	1602	817	1,36	51,15	11,55	-	1687	1940
		080				10	1100	800	1716	876	1,37	56,76	12,54	-	1833	2108
		088				11	1100	880	1808	923	1,36	61,27	13,64	-	1978	2275
382	120	024	XX	YY	00	3	1200	240	772	394	1,28	18,60	4,08	-	859	988
		032				4	1200	320	958	489	1,30	24,84	5,40	-	1011	1163
		040				5	1200	400	1138	580	1,32	30,96	6,84	-	1166	1341
		048				6	1200	480	1319	673	1,34	37,20	8,28	-	1323	1521
		056				7	1200	560	1499	765	1,36	43,44	9,72	-	1479	1701
		064				8	1200	640	1624	828	1,36	49,56	11,16	-	1752	1877
		072				9	1200	720	1747	891	1,36	55,80	12,60	-	1787	2055
		080				10	1200	800	1872	955	1,37	61,92	13,68	-	1943	2234
		088				11	1200	880	1973	1007	1,36	66,84	14,88	-	2097	2412
382	140	024	XX	YY	00	3	1400	240	900	459	1,28	21,70	4,76	-	946	1088
		032				4	1400	320	1117	570	1,30	28,98	6,30	-	1118	1286
		040				5	1400	400	1327	677	1,32	36,12	7,98	-	1293	1487
		048				6	1400	480	1539	785	1,34	43,40	9,66	-	1468	1688
		056				7	1400	560	1749	892	1,36	50,68	11,34	-	1639	1885
		064				8	1400	640	1894	966	1,36	57,82	13,02	-	1812	2084
		072				9	1400	720	2038	1040	1,36	65,10	14,70	-	1986	2284
		080				10	1400	800	2184	1114	1,37	72,24	15,96	-	2161	2485
		088				11	1400	880	2302	1174	1,36	77,98	17,36	-	2336	2686
382	160	024	XX	YY	00	3	1600	240	1029	525	1,28	24,80	5,44	-	1031	1186
		032				4	1600	320	1277	651	1,30	33,12	7,20	-	1226	1410
		040				5	1600	400	1517	774	1,32	41,28	9,12	-	1417	1630
		048				6	1600	480	1758	897	1,34	49,60	11,04	-	1609	1850
		056				7	1600	560	1998	1020	1,36	57,92	12,96	-	1923	2193
		064				8	1600	640	2165	1104	1,36	66,08	14,88	-	1994	2293
		072				9	1600	720	2330	1189	1,36	74,40	16,80	-	2189	2517
		080				10	1600	800	2496	1273	1,37	82,56	18,24	-	2379	2736
		088				11	1600	880	2630	1342	1,36	89,12	19,84	-	2572	2958

Conform EN442-1: 2014: radiatoren en convectoren

Voor meer details over onze artikel-data, zie artikel-database: <https://www.installdata.be>

Voor de warmteafgiftes van andere regimes, kijkt u op p. 370 (correctiefactoren)
BELGIË. Prijzen in euro (excl. BTW)

VIOLA-A HORIZONTAAL (H2L1-RO-A)



H2L1-RO-A
(thermostaatkop apart te bestellen)

HOE VIOLA-A HORIZONTAAL BESTELLEN

Leveringstermijn 15 - 30 werkdagen
(zonder transportduur)

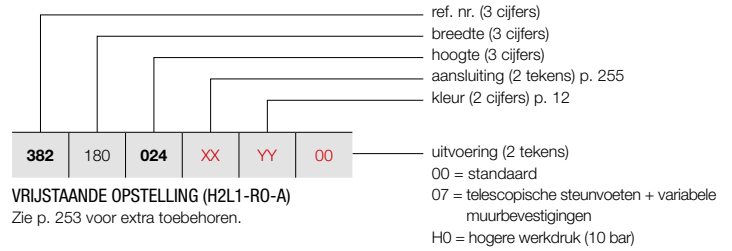

VRIJSTAANDE OPSTELLING (H2L1-RO-A)
Zie p. 253 voor extra toebehoren.

PRIJSGROEP: VPG2 - STAAL DESIGNRADIATOREN

BESTELCODE MAATWERK VIOLA-A HORIZONTAAL	TECHNISCHE GEGEVENS									STANDAARDKLEUR	ANDERE KLEUREN
	buizen	breedte (L mm)	hoogte (H mm)	75/65/20 (Watt) (Φ50K)	55/45/20 (Watt) (Φ30K)	n-exp.	gewicht (kg)	inhoud (l)	el. weerst. (Watt)	prijs RAL 9016 (€)	prijs kleur (€)
REF. NR. VIOLA-A HORIZONTAAL H2L1-RO-A : 382											
382	180	024	XX	YY	00						
		032								1118	1286
		040								1329	1528
		048								1542	1773
		056								1756	2019
		064								1964	2259
		072								2173	2499
		080								2387	2745
		088								2596	2985
										2809	3230
382	200	024	XX	YY	00						
		032								1202	1382
		040								1437	1653
		048								1668	1918
		056								1895	2179
		064								2124	2443
		072								2355	2708
		080								2587	2975
		088								2816	3238
										3045	3502
382	220	024	XX	YY	00						
		032								1293	1487
		040								1542	1773
		048								1791	2060
		056								2041	2347
		064								2288	2631
		072								2533	2913
		080								2786	3204
		088								3034	3489
										3282	3774
382	240	024	XX	YY	00						
		032								1378	1585
		040								1767	1894
		048								1914	2201
		056								2182	2509
		064								2571	2939
		072								2839	3247
		080								2986	3434
		088								3254	3742
										3522	4050
382	260	024	XX	YY	00						
		032								1468	1688
		040								1751	2014
		048								2041	2347
		056								2325	2674
		064								2610	3002
		072								2902	3337
		080								3185	3663
		088								3474	3995
										3760	4324

Conform EN442-1: 2014: radiatoren en convectoren

Voor meer details over onze artikel-data, zie artikel-database: <https://www.installdata.be>

Voor de warmteafgifte van andere regimes, kijkt u op p. 370 (correctiefactoren)
BELGIË. Prijzen in euro (excl. BTW)

VIOLA-A HORIZONTAAL (H2L2-RO-A)



H2L2-RO-A
(thermostaatkop apart te bestellen)

HOE VIOLA-A HORIZONTAAL BESTELLEN

Leveringstermijn 15 - 30 werkdagen
(zonder transportduur)

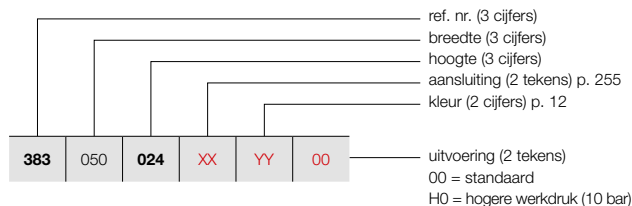

PRIJSGROEP: VPG2 - STAAL DESIGNRADIATOREN

BESTELCODE MAATWERK VIOLA-A HORIZONTAAL							TECHNISCHE GEGEVENS					STANDAARDKLEUR	ANDERE KLEUREN			
buizen	breedte (L mm)	hoogte (H mm)	75/65/20 (Watt) (Φ50K)	55/45/20 (Watt) (Φ30K)	n-exp.	gewicht (kg)	inhoud (l)	el. weerst. (Watt)	prijs RAL 9016 (€)	prijs kleur (€)						
REF. NR. VIOLA-A HORIZONTAAL H2L2-RO-A : 383																
383	050	024	XX	YY	00	3	500	240	433	221	1,25	9,70	2,00	-	602	692
		032				4	500	320	538	274	1,30	12,90	2,75	-	701	806
		040				5	500	400	663	338	1,31	16,10	3,45	-	802	922
		048				6	500	480	788	402	1,33	19,40	4,15	-	902	1037
		056				7	500	560	913	466	1,34	22,60	4,85	-	1003	1153
		064				8	500	640	993	507	1,34	25,85	5,50	-	1096	1260
		072				9	500	720	1073	547	1,34	29,10	6,20	-	1200	1380
		080				10	500	800	1153	588	1,36	32,30	6,90	-	1301	1616
		088				11	500	880	1204	614	1,36	34,45	7,60	-	1402	1612
383	060	024	XX	YY	00	3	600	240	519	265	1,25	11,64	2,40	-	652	750
		032				4	600	320	645	329	1,30	15,48	3,30	-	761	875
		040				5	600	400	796	406	1,31	19,32	4,14	-	876	1007
		048				6	600	480	946	482	1,33	23,28	4,98	-	989	1137
		056				7	600	560	1096	559	1,34	27,12	5,82	-	1096	1260
		064				8	600	640	1192	608	1,34	31,02	6,60	-	1212	1394
		072				9	600	720	1287	657	1,34	34,92	7,44	-	1323	1521
		080				10	600	800	1383	706	1,36	38,76	8,28	-	1437	1653
		088				11	600	880	1445	737	1,36	41,34	9,12	-	1548	1780
383	070	024	XX	YY	00	3	700	240	606	309	1,25	13,58	2,80	-	706	812
		032				4	700	320	753	384	1,30	18,06	3,85	-	830	955
		040				5	700	400	928	474	1,31	22,54	4,83	-	954	1097
		048				6	700	480	1103	563	1,33	27,16	5,81	-	1078	1240
		056				7	700	560	1278	652	1,34	31,64	6,79	-	1199	1379
		064				8	700	640	1390	709	1,34	36,19	7,70	-	1443	1641
		072				9	700	720	1502	766	1,34	40,74	8,68	-	1445	1662
		080				10	700	800	1614	823	1,36	45,22	9,66	-	1569	1804
		088				11	700	880	1686	860	1,36	48,23	10,64	-	1693	1947
383	080	024	XX	YY	00	3	800	240	692	353	1,25	15,52	3,20	-	757	871
		032				4	800	320	860	439	1,30	20,64	4,40	-	893	1027
		040				5	800	400	1061	541	1,31	25,76	5,52	-	1026	1180
		048				6	800	480	1261	643	1,33	31,04	6,64	-	1163	1337
		056				7	800	560	1461	745	1,34	36,16	7,76	-	1420	1615
		064				8	800	640	1589	811	1,34	41,36	8,80	-	1436	1771
		072				9	800	720	1716	876	1,34	46,56	9,92	-	1569	1804
		080				10	800	800	1844	941	1,36	51,68	11,04	-	1703	1958
		088				11	800	880	1926	983	1,36	55,12	12,16	-	1838	2114
383	090	024	XX	YY	00	3	900	240	779	397	1,25	17,46	3,60	-	810	932
		032				4	900	320	968	494	1,30	23,22	4,95	-	959	1103
		040				5	900	400	1193	609	1,31	28,98	6,21	-	1105	1271
		048				6	900	480	1418	724	1,33	34,92	7,47	-	1249	1436
		056				7	900	560	1643	838	1,34	40,68	8,73	-	1397	1607
		064				8	900	640	1787	912	1,34	46,53	9,90	-	1545	1777
		072				9	900	720	1931	985	1,34	52,38	11,16	-	1692	1946
		080				10	900	800	2075	1058	1,36	58,14	12,42	-	1838	2114
		088				11	900	880	2167	1106	1,36	62,01	13,68	-	1986	2284

Conform EN442-1: 2014: radiatoren en convectoren

Voor meer details over onze artikel-data, zie artikel-database: <https://www.installdata.be>
Voor de warmteafgifte van andere regimes, kijkt u op p. 370 (correctiefactoren)
BELGIË. Prijzen in euro (excl. BTW)

HOE VIOLA-A HORIZONTAAL BESTELLEN

Leveringstermijn 15 - 30 werkdagen
(zonder transportduur)

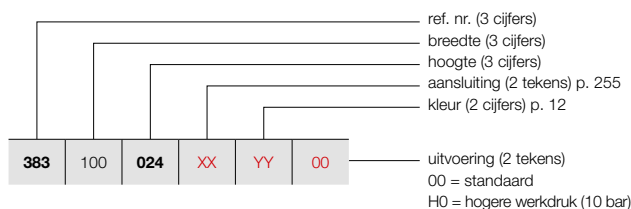

VIOLA-A HORIZONTAAL (H2L2-RO-A)

249



H2L2-RO-A
(thermostaatkop apart te bestellen)

PRIJSGROEP: VPG2 - STAAL DESIGNRADIATOREN

BESTELCODE MAATWERK VIOLA-A HORIZONTAAL	TECHNISCHE GEGEVENS							STANDAARDKLEUR	ANDERE KLEUREN			
	buizen	breedte (L mm)	hoogte (H mm)	75/65/20 (Watt) (Φ50K)	55/45/20 (Watt) (Φ30K)	n-exp.	gewicht (kg)			inhoud (l)	el. weerst. (Watt)	prijs RAL 9016 (€)
REF. NR. VIOLA-A HORIZONTAAL H2L2-RO-A : 383												
383 100 024 XX YY 00	3	1000	240	865	441	1,25	19,40	4,00	-	863	992	
	4	1000	320	1075	548	1,30	25,80	5,50	-	1022	1175	
	5	1000	400	1326	677	1,31	32,20	6,90	-	1180	1357	
	6	1000	480	1576	804	1,33	38,80	8,30	-	1336	1536	
	7	1000	560	1826	932	1,34	45,20	9,70	-	1494	1838	
	8	1000	640	1986	1013	1,34	51,70	11,00	-	1655	1903	
	9	1000	720	2145	1094	1,34	58,20	12,40	-	1934	2206	
	10	1000	800	2305	1176	1,36	64,60	13,80	-	1973	2269	
	11	1000	880	2408	1229	1,36	68,90	15,20	-	2133	2453	
	383 110 024 XX YY 00	3	1100	240	952	485	1,25	21,34	4,40	-	915	1052
		4	1100	320	1183	603	1,30	28,38	6,05	-	1084	1247
5		1100	400	1459	744	1,31	35,42	7,59	-	1256	1444	
6		1100	480	1734	884	1,33	42,68	9,13	-	1424	1638	
7		1100	560	2009	1025	1,34	49,72	10,67	-	1596	1835	
8		1100	640	2185	1115	1,34	56,87	12,10	-	1765	2030	
9		1100	720	2360	1204	1,34	64,02	13,64	-	1937	2228	
10		1100	800	2536	1294	1,36	71,06	15,18	-	2107	2423	
11		1100	880	2649	1351	1,36	75,79	16,72	-	2278	2620	
383 120 024 XX YY 00		3	1200	240	1038	530	1,25	23,28	4,80	-	968	1113
		4	1200	320	1290	658	1,30	30,96	6,60	-	1150	1323
	5	1200	400	1591	812	1,31	38,64	8,28	-	1330	1530	
	6	1200	480	1891	965	1,33	46,56	9,96	-	1513	1740	
	7	1200	560	2191	1118	1,34	54,24	11,64	-	1694	1948	
	8	1200	640	2383	1216	1,34	62,04	13,20	-	1879	2161	
	9	1200	720	2574	1313	1,34	69,84	14,88	-	2061	2370	
	10	1200	800	2766	1411	1,36	77,52	16,56	-	2240	2576	
	11	1200	880	2890	1474	1,36	82,68	18,24	-	2423	2786	
	383 140 024 XX YY 00	3	1400	240	1211	618	1,25	27,16	5,60	-	1072	1233
		4	1400	320	1505	768	1,30	36,12	7,70	-	1277	1469
5		1400	400	1856	947	1,31	45,08	9,66	-	1484	1707	
6		1400	480	2206	1126	1,33	54,32	11,62	-	1688	1941	
7		1400	560	2556	1304	1,34	63,28	13,58	-	2012	2176	
8		1400	640	2780	1419	1,34	72,38	15,40	-	2100	2415	
9		1400	720	3003	1532	1,34	81,48	17,36	-	2304	2650	
10		1400	800	3227	1646	1,36	90,44	19,32	-	2511	2888	
11		1400	880	3371	1720	1,36	96,46	21,28	-	2717	3125	
383 160 024 XX YY 00		3	1600	240	1384	706	1,25	31,04	6,40	-	1178	1355
		4	1600	320	1720	878	1,30	41,28	8,80	-	1406	1617
	5	1600	400	2122	1082	1,31	51,52	11,04	-	1634	1879	
	6	1600	480	2522	1287	1,33	62,08	13,28	-	1864	2144	
	7	1600	560	2922	1491	1,34	72,32	15,52	-	2093	2407	
	8	1600	640	3178	1621	1,34	82,72	17,60	-	2321	2669	
	9	1600	720	3432	1751	1,34	93,12	19,84	-	2551	2934	
	10	1600	800	3688	1882	1,36	103,36	22,08	-	2780	3197	
	11	1600	880	3853	1966	1,36	110,24	24,32	-	3008	3459	

Conform EN442-1: 2014: radiatoren en convectoren

Voor meer details over onze artikel-data, zie artikel-database: <https://www.installdata.be>

Voor de warmteafgiftes van andere regimes, kijkt u op p. 370 (correctiefactoren)
BELGIË. Prijzen in euro (excl. BTW)

HOE VIOLA-A HORIZONTAAL BESTELLEN

Leveringstermijn 15 - 30 werkdagen
(zonder transportduur)

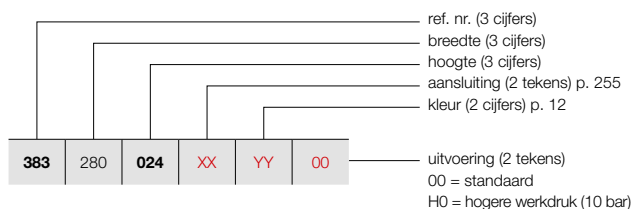

VIOLA-A HORIZONTAAL (H2L2-RO-A)

251



H2L2-RO-A
(thermostaatkop apart te bestellen)

PRIJSGROEP: VPG2 - STAAL DESIGNRADIATOREN

BESTELCODE MAATWERK VIOLA-A HORIZONTAAL	TECHNISCHE GEGEVENS								STANDAARDKLEUR		ANDERE KLEUREN
	buizen	breedte (L mm)	hoogte (H mm)	75/65/20 (Watt) (Φ50K)	55/45/20 (Watt) (Φ30K)	n-exp.	gewicht (kg)	inhoud (l)	el. weerst. (Watt)	prijs RAL 9016 (€)	prijs kleur (€)
REF. NR. VIOLA-A HORIZONTAAL H2L2-RO-A : 383											
383	280	024	XX	YY	00						
		032								1806	2077
		040								2175	2501
		048								2549	2931
		056								2915	3352
		064								3287	3780
		072								3652	4200
		080								4023	4626
										4393	5052
383	300	024	XX	YY	00						
		032								1910	2197
		040								2304	2650
		048								2695	3099
		056								3090	3554
		064								3483	4005
		072								3877	4459
										4267	4907



Conform EN442-1: 2014: radiatoren en convectoren

Voor meer details over onze artikel-data, zie artikel-database: <https://www.installdata.be>
Voor de warmteafgiftes van andere regimes, kijkt u op p. 370 (correctiefactoren)
BELGIË. Prijzen in euro (excl. BTW)

VIOLA-A WANDBEVESTIGING



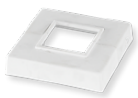

IN OPTIE

PRIJSGROEP: VPG10 - ACC.

WANDOPSTELLING	BREEDTE RADIATOR	KLEUR	ART. NR.	€
TELESCOPISCHE STEUNVOETEN + VARIABLE MUURBEVESTIGINGEN 	V2-ZB-A			
	(2 voeten)	RAL 9016	*	88
		KLEUR	*	101
	H2-RO-A, H2L1-RO-A			
	≤ 2000 mm (2 voeten)	RAL 9016	*	88
		KLEUR	*	101
≥ 2200 mm (3 voeten)	RAL 9016	*	134	
	KLEUR	*	154	
* Opgelet: Voeten moeten gelijktijdig met de radiator besteld worden. Gelieve bij bestelling code 07 aan te geven bij "Afwerking".				
AFDEKROZET STANDVOET CHAPE 	V2-ZB-A			
		RAL 9016	11810390000	31
• 56 x 56 mm. Aantal rozetten = aantal standvoeten				
AFDEKROZET STANDVOET AFGEWERKTE VLOER 	H2-RO-A, H2L1-RO-A			
		RAL 9016	11810400000	40
• 104 x 84 mm. Aantal rozetten = aantal standvoeten				

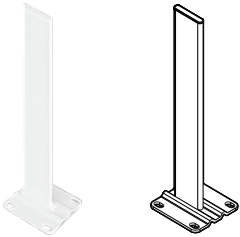
BELGIË. Prijzen in euro (excl. BTW)

PRIJSGROEP: VPG10 - ACC.

VRIJSTAANDE OPSTELLING	HOOGTE VOET	KLEUR	ART. NR.	€
STANDVOET VRIJSTAANDE OPSTELLING 	H2-RO-A, H2L1-RO-A			
	H = 450 mm	RAL 9016	11810350450	65
		KLEUR	11810350450C	75
	H = 550 mm	RAL 9016	11810350550	65
		KLEUR	11810350550C	75
	H = 600 mm	RAL 9016	11810350600	65
		KLEUR	11810350600C	75
	H = 650 mm	RAL 9016	11810350650	65
		KLEUR	11810350650C	75
	H = 750 mm	RAL 9016	11810350750	65
		KLEUR	11810350750C	75
	H = 850 mm	RAL 9016	11810350850	81
		KLEUR	11810350850C	92
	H = 900 mm	RAL 9016	11810350900	81
KLEUR		11810350900C	92	
H = 1050 mm	RAL 9016	11810351050	81	
	KLEUR	11810351050C	92	
H = 1200 mm	RAL 9016	11810351200	81	
	KLEUR	11810351200C	92	
BEVESTIGING STANDVOET VRIJSTAANDE OPSTELLING 	H2-RO-A, H2L1-RO-A			
		RAL 9016	11810360000	52
	KLEUR	11810360000C	60	
AFDEKROZET STANDVOET CHAPE 	H2-RO-A, H2L1-RO-A			
		RAL 9016	11810370000	14
	KLEUR	11810370000C	16	
AFDEKROZET STANDVOET AFGEWERKTE VLOER 	H2-RO-A, H2L1-RO-A			
		RAL 9016	11810380000	17
	KLEUR	11810380000C	19	

- Afgewerkte vloer: hoogte voet = hoogte radiator + 150 mm
- Chape: hoogte voet = hoogte radiator + 300 mm
- Zelf in te korten indien nodig

- 100 x 40 mm. Aantal rozetten = aantal standvoeten



- 115 x 110 mm. Aantal rozetten = aantal standvoeten

hoogte radiator (mm)	Lengte radiator (mm)	aantal standvoeten	aantal bevestigingen standvoet
240 - 880	500-2000	2x	2x
	2200-3000	3x	3x

BELGIË. Prijzen in euro (excl. BTW)

VIOLA-A ACCESSOIRES
 IN OPTIE

PRIJSGROEP: VPG10 - ACC.

ACCESSOIRES		KLEUR	ART. NR.	€
THERMOSTAATKOP		H1-RO-A, H1L1-RO-A, H2-RO-A, H2L1-RO-A, H2L2-RO-A		
		WIT	11911630102	48
THERMOSTAATKOP		H1-RO-A, H1L1-RO-A, H2-RO-A, H2L1-RO-A, H2L2-RO-A		
		CHROOM	11911631102	65

PRIJSGROEP: VPG10B - HANDDOEKBEUGELS

ACCESSOIRES	BREEDTE HANDDOEKBEUGEL	KLEUR	ART. NR.	€	
KNOP		V1-ZB-A, V1L1-ZB-A, V2-ZB-A			
		CHROOM	1183.411.0000.0099	94	
HANDDOEKBEUGEL		V1-ZB-A, V1L1-ZB-A, V2-ZB-A			
		H1-RO-A, H1L1-RO-A, H2-RO-A, H2L1-RO-A, H2L2-RO-A			
		500 mm	CHROOM	1183.270.0000.0099	157
		500 mm	RAL 9016	1183.270.0000.9016	157
	500 mm	RAL 9005 ^{mat}	1183.270.0000.9005	157	

- h = 70 mm; b = 70 mm; d = 51 mm; a = 43 mm;

- h = 55 mm; b = 500 mm; d = 53 mm; a = 38 mm;

^{mat} mat zwart

Montagevoorschriften accessoires: zie www.vasco.eu
BELGIË. Prijzen in euro (excl. BTW)

 d = afstand voorkant accessoire tot voorkant radiator
 a = afstand accessoire tot radiator
uit voorraad leverbaar

VIOLA-A VERTICAAL: V1-ZB-A / V1L1-ZB-A / V2-ZB-A (VOORRAAD)

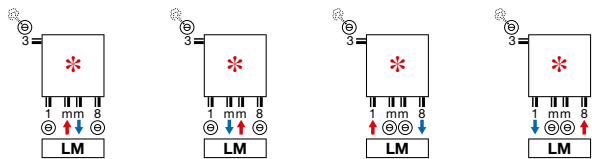

- * Aanvoer en retour kunnen verwisseld worden
- Bovenvermelde aansluiting voor voorraad radiator met even aantal buizen. Ook beschikbaar voor niet-voorraadradiatoren met even aantal buizen.

VIOLA-A VERTICAAL: V1-ZB-A / V1L1-ZB-A / V2-ZB-A (NIET-VOORRAAD)

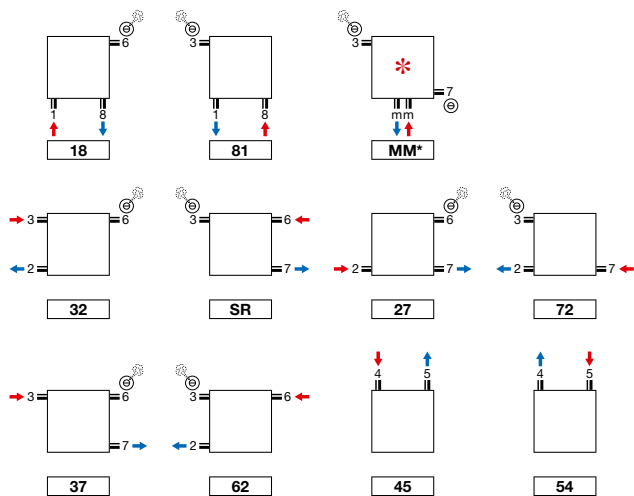

- * Aanvoer en retour kunnen verwisseld worden
- mm aansluiting alleen mogelijk bij even aantal buizen.

VIOLA-A HORIZONTAAL: H1-RO-A / H1L1-RO-A / H2-RO-A / H2L1-RO-A / H2L2-RO-A (NIET-VOORRAAD)

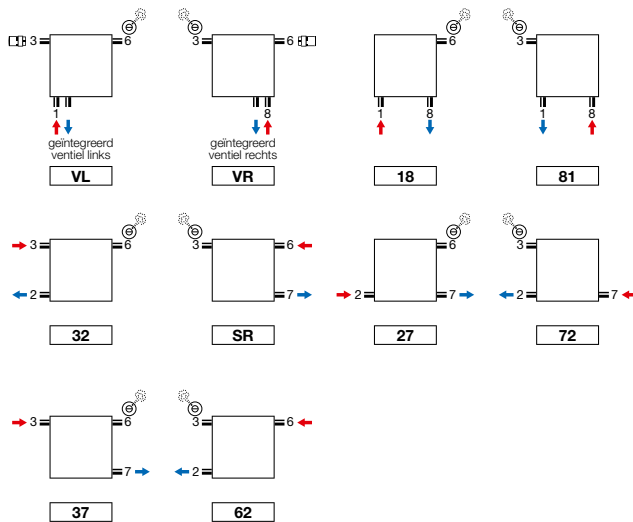

- Aansluiting VL en VR: thermostaatkop apart te bestellen
- Geïntegreerd ventiel (meerprijs) (zie p. 363)

Opmerking: het aansluiten van de radiator kan enkel volgens de getoonde aansluiticonen. Voor elke andere aansluitwijze nemen wij geen verantwoordelijkheid.

TULIPA-A VERTICAAL (TV1-A, TV2-A)



TULIPA-A VERTICAAL

Warmte in alle openheid

Een designradiator van de eerste generatie. Geschikt voor alle ruimten en toepassingen. Gekenmerkt door de klassieke open structuur en de loodrechte aansluiting van de buizen op de collector. De waarborg voor een smetteloos verwarmingscomfort waar dan ook in huis.

TYPES

- Eén (TV1-A) of twee rijen buizen (TV2-A)

BUIZEN

- Verticaal, platvaal 60 x 10 mm

COLLECTOREN

- Horizontaal, achterliggend, rond Ø 32 mm

KLEUREN

- Standaardkleur wit RAL 9016
- Uitgebreide kleurenkaart zie p. 12

SPECIAAL

- Tulipa-A 6 en 8 buizen: aansluiting 1mm8, 18, 81 niet mogelijk

BEVESTIGINGEN

- Muurbevestigingen standaard (inbegrepen in de verpakking van de radiator)
- **TV1-A / TV2-A:** ook verkrijgbaar als vrijstaande opstelling, zie p. 272. Extra muurbevestigingssteun nodig voor hoogte radiator > 600 mm

TECHNISCH

- Weerstandsgelast (onzichtbare lasnaden)
- ATL-grondlaag, poedercoating
- Standaardwerkdruk: 6 bar. Meerprijs hogere werkdruk (10 bar): +10%.
- De leveringstermijn van radiator met een hogere werkdruk is 1 week extra.
- Maximale bedrijfstemperatuur: 110°C

ELEKTRISCH

- ✗ Zuiver elektrische radiator in de fabriek voorgevuld
- ✗ Gemengde radiator

TECHNISCHE TEKENINGEN

- Zie p. 275

AANSLUITING

- ✗ Eénpuntsaansluiting voor éénpijpssysteem
- ✗ Eénpuntsaansluiting voor tweepijpssysteem
- ✓ Tweepuntsaansluiting voor éénpijpssysteem (aansluiting via de middenaansluiting) (zie p. 362)
- ✓ Tweepuntsaansluiting voor tweepijpssysteem (standaard) (zie p. 362)
- ✗ Geïntegreerd ventiel
- Aansluitingen: ½" (binnendraad)

AANBEVOLEN AANSLUITING (LM)

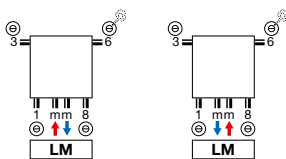

Andere aansluitmogelijkheden, zie p. 274

NEW



Ventielset haaks kleur

art. nr. 1182 105 0000 9016

prijs €201

Andere kleuren, zie p. 366

Koppelingen, zie p. 380



Thermostaatkop

Traffic White

art. nr. 1182 030 0000 9016

prijs €40

AANBEVOLEN VOOR BADKAMER EN KEUKEN IN OPTIE



handdoekbeugel (RAL 9005)

art. nr. zie p. 273

prijs €157

Andere accessoires, zie p. 273



TV1-A / TV2-A

HOE TULIPA-A VERTICAAL BESTELLEN

Leveringstermijn 15 - 30 werkdagen
(zonder transportduur)

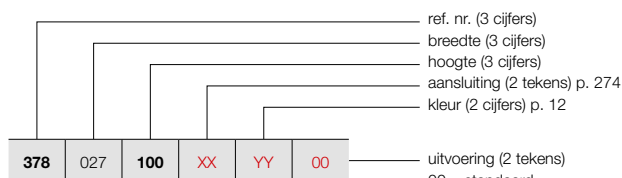

VRIJSTAANDE OPSTELLING (TV1-A)

Zie p. 272 voor extra toebehoren.

HOE VOORRAADRADIATOR TULIPA-A VERTICAAL BESTELLEN

Leveringstermijn 5 werkdagen
(zonder transportduur)

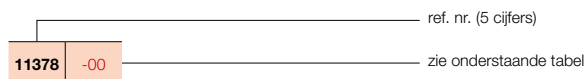

TULIPA-A VERTICAAL (TV1-A)



TV1-A

PRIJSGROEP: VPG2 - STAAL DESIGNRADIATOREN

BESTELCODE MAATWERK TULIPA-A VERTICAAL	TECHNISCHE GEGEVENS								STANDAARDKLEUR		ANDERE KLEUREN	
	buizen	breedte (L mm)	hoogte (H mm)	75/65/20 (Watt) (Φ50K)	55/45/20 (Watt) (Φ30K)	n-exp.	gewicht (kg)	inhoud (l)	el. weerst. (Watt)	prijs RAL 9016 (€)		verkorte ref. nr. RAL 9016 voorraad
REF. NR. TULIPA-A VERTICAAL TV1-A : 378												
378 027 100 XX YY 00	6	270	1000	384	204	1,24	9,60	2,64	-	284	-	327
	6	270	1200	456	240	1,24	11,40	3,12	-	312	-	359
	6	270	1500	564	294	1,25	14,40	3,84	-	354	-	407
	6	270	1600	600	312	1,26	15,00	4,08	-	367	-	422
	6	270	1800	660	342	1,26	16,80	4,56	-	397	-	457
	6	270	2000	738	384	1,27	18,60	4,98	-	425	-	489
	6	270	2200	810	420	1,27	20,40	5,46	-	452	-	520
	6	270	2500	912	474	1,28	23,40	6,18	-	494	-	568
	6	270	3000	1092	558	1,29	27,60	7,32	-	564	-	649
378 036 100 XX YY 00	8	360	1000	512	272	1,24	12,80	3,52	-	352	-	405
	8	360	1200	608	320	1,24	15,20	4,16	-	391	-	450
	8	360	1500	752	392	1,25	19,20	5,12	-	446	-	513
	8	360	1600	800	416	1,26	20,00	5,44	-	465	-	535
	8	360	1800	880	456	1,26	22,40	6,08	-	501	-	576
	8	360	2000	984	512	1,27	24,80	6,64	-	536	-	616
	8	360	2200	1080	560	1,27	27,20	7,28	-	575	-	661
	8	360	2500	1216	632	1,28	31,20	8,24	-	631	-	726
	8	360	3000	1456	744	1,29	36,80	9,76	-	725	-	834
378 045 100 XX YY 00	10	450	1000	640	340	1,24	16,00	4,40	-	417	-	480
	10	450	1200	760	400	1,24	19,00	5,20	-	467	-	537
	10	450	1500	940	490	1,25	24,00	6,40	-	538	-	619
	10	450	1600	1000	520	1,26	25,00	6,80	-	561	-	645
	10	450	1800	1100	570	1,26	28,00	7,60	-	606	-	697
	10	450	2000	1230	640	1,27	31,00	8,30	-	651	-	749
	10	450	2200	1350	700	1,27	34,00	9,10	-	697	-	802
	10	450	2500	1520	790	1,28	39,00	10,30	-	771	-	887
	10	450	3000	1820	930	1,29	46,00	12,20	-	882	-	1014
378 054 100 XX YY 00	12	540	1000	768	408	1,24	19,20	5,28	-	484	-	557
	12	540	1200	912	480	1,24	22,80	6,24	-	542	-	623
	12	540	1500	1128	588	1,25	28,80	7,68	-	625	-	719
	12	540	1600	1200	624	1,26	30,00	8,16	-	652	-	750
	12	540	1800	1320	684	1,26	33,60	9,12	-	712	11378-01	819
	12	540	2000	1476	768	1,27	37,20	9,96	-	761	11378-02	875
	12	540	2200	1620	840	1,27	40,80	10,92	-	822	-	945
	12	540	2500	1824	948	1,28	46,80	12,36	-	903	-	1038
	12	540	3000	2184	1116	1,29	55,20	14,64	-	1046	-	1203

Conform EN442-1: 2014: radiatoren en convectoren

Voor meer details over onze artikel-data, zie artikel-database: <https://www.installdata.be>
Voor de warmteafgiftes van andere regimes, kijkt u op p. 370 (correctiefactoren)
BELGIË. Prijzen in euro (excl. BTW)

TULIPA-A VERTICAAL (TV1-A)



TV1-A

HOE TULIPA-A VERTICAAL BESTELLEN

Leveringstermijn 15 - 30 werkdagen
(zonder transportduur)

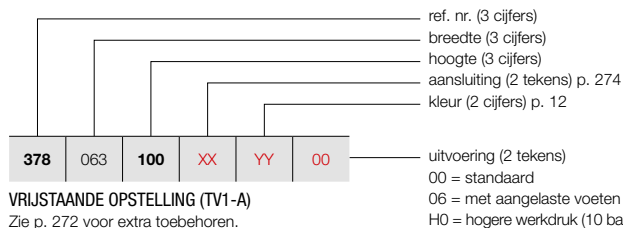

VRIJSTAANDE OPSTELLING (TV1-A)

Zie p. 272 voor extra toebehoren.

PRIJSGROEP: VPG2 - STAAL DESIGNRADIATOREN

BESTELCODE MAATWERK TULIPA-A VERTICAAL	TECHNISCHE GEGEVENS									STANDAARDKLEUR	ANDERE KLEUREN
	buizen	breedte (L mm)	hoogte (H mm)	75/65/20 (Watt) (Φ50K)	55/45/20 (Watt) (Φ30K)	n-exp.	gewicht (kg)	inhoud (l)	el. weerst. (Watt)	prijs RAL 9016 (€)	prijs kleur (€)
REF. NR. TULIPA-A VERTICAAL TV1-A : 378											
378	063	100	XX	YY	00						
		120								556	639
		150								619	712
		160								717	825
		180								751	864
		200								814	936
		220								878	1010
		250								946	1088
		300								1042	1198
										1202	1382
378	072	100	XX	YY	00						
		120								622	715
		150								695	799
		160								805	926
		180								842	968
		200								916	1053
		220								991	1140
		250								1067	1227
		300								1180	1357
										1365	1570
378	081	100	XX	YY	00						
		120								686	789
		150								770	886
		160								895	1029
		180								935	1075
		200								1022	1175
		220								1107	1273
		250								1189	1367
		300								1317	1515
										1526	1755
378	090	100	XX	YY	00						
		120								754	867
		150								845	972
		160								986	1134
		180								1036	1191
		200								1128	1297
		220								1217	1400
		250								1314	1511
		300								1450	1668
										1685	1938

Conform EN442-1: 2014: radiatoren en convectoren

Voor meer details over onze artikel-data, zie artikel-database: <https://www.installdata.be>

Voor de warmteafgifte van andere regimes, kijkt u op p. 370 (correctiefactoren)
BELGIË. Prijzen in euro (excl. BTW)

HOE TULIPA-A VERTICAAL BESTELLEN

Leveringstermijn 15 - 30 werkdagen
(zonder transportduur)

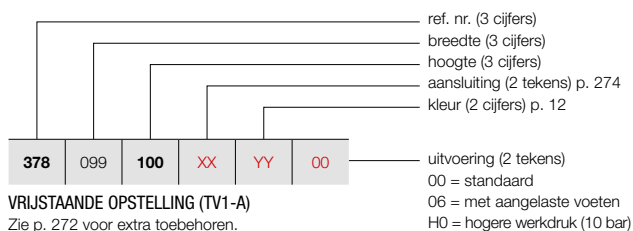

VRIJSTAANDE OPSTELLING (TV1-A)

Zie p. 272 voor extra toebehoren.

TULIPA-A VERTICAAL (TV1-A)



TV1-A

PRIJSGROEP: VPG2 - STAAL DESIGNRADIATOREN

BESTELCODE MAATWERK TULIPA-A VERTICAAL	TECHNISCHE GEGEVENS							STANDAARDKLEUR		ANDERE KLEUREN	
	buizen	breedte (L mm)	hoogte (H mm)	75/65/20 (Watt) (Φ50K)	55/45/20 (Watt) (Φ30K)	n-exp.	gewicht (kg)	inhoud (l)	el. weerst. (Watt)	prijs RAL 9016 (€)	prijs kleur (€)
REF. NR. TULIPA-A VERTICAAL TV1-A : 378											
378	099	100	XX	YY	00						
		120								822	945
		150								922	1060
		160								1076	1237
		180								1129	1298
		200								1231	1416
		220								1332	1532
		250								1437	1653
										1587	1825
378	108	100	XX	YY	00						
		120								888	1021
		150								1000	1150
		160								1168	1343
		180								1226	1410
		200								1333	1533
		220								1445	1662
										1557	1791
378	117	100	XX	YY	00						
		120								956	1099
		150								1078	1240
		160								1257	1446
		180								1319	1517
		200								1439	1655
										1559	1793
378	126	100	XX	YY	00						
		120								1022	1175
		150								1151	1324
		160								1345	1547
		180								1410	1622
										1543	1774

Conform EN442-1: 2014: radiatoren en convectoren

Voor meer details over onze artikel-data, zie artikel-database: <https://www.installdata.be>

Voor de warmteafgiftes van andere regimes, kijkt u op p. 370 (correctiefactoren)

BELGIË. Prijzen in euro (excl. BTW)

TULIPA-A VERTICAAL (TV2-A)



TV2-A

HOE TULIPA-A VERTICAAL BESTELLEN

Leveringstermijn 15 - 30 werkdagen
(zonder transportduur)

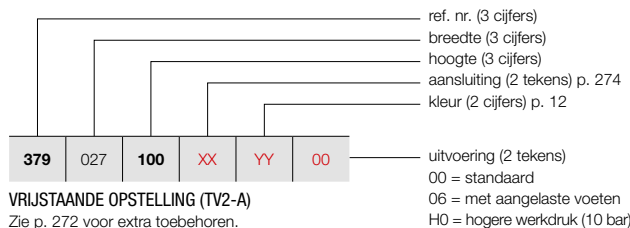

VRIJSTAANDE OPSTELLING (TV2-A)

Zie p. 272 voor extra toebehoren.

HOE VOORRAADRADIATOR VIOLA-A VERTICAAL BESTELLEN

Leveringstermijn 5 werkdagen
(zonder transportduur)

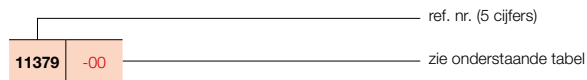

PRIJSGROEP: VPG2 - STAAL DESIGNRADIATOREN

BESTELCODE MAATWERK TULIPA-A VERTICAAL	TECHNISCHE GEGEVENS									STANDAARDKLEUR		ANDERE KLEUREN
	buizen	breedte (L mm)	hoogte (H mm)	75/65/20 (Watt) (Φ50K)	55/45/20 (Watt) (Φ30K)	n-exp.	gewicht (kg)	inhoud (l)	el. weerst. (Watt)	prijs RAL 9016 (€)	verkorte ref. nr. RAL 9016 voorraad	
REF. NR. TULIPA-A VERTICAAL TV2-A : 379												
379 027 100 XX YY 00	6	270	1000	636	330	1,26	18,60	4,98	-	498	-	573
	6	270	1200	750	390	1,26	22,20	5,94	-	547	-	629
	6	270	1500	924	480	1,27	27,60	7,32	-	622	-	715
	6	270	1600	984	504	1,28	29,40	7,80	-	646	-	743
	6	270	1800	1134	582	1,28	33,00	8,70	-	690	-	794
	6	270	2000	1212	624	1,29	36,60	9,66	-	745	-	857
	6	270	2200	1326	684	1,29	40,20	10,56	-	793	-	912
	6	270	2500	1500	768	1,30	45,60	12,00	-	866	-	996
	6	270	3000	1788	906	1,31	54,60	14,34	-	986	-	1134
379 036 100 XX YY 00	8	360	1000	848	440	1,26	24,80	6,64	-	614	-	706
	8	360	1200	1000	520	1,26	29,60	7,92	-	678	-	780
	8	360	1500	1232	640	1,27	36,80	9,76	-	781	-	898
	8	360	1600	1312	672	1,28	39,20	10,40	-	810	-	932
	8	360	1800	1512	776	1,28	44,00	11,60	-	876	-	1007
	8	360	2000	1616	832	1,29	48,80	12,88	-	943	-	1084
	8	360	2200	1768	912	1,29	53,60	14,08	-	1007	-	1158
	8	360	2500	2000	1024	1,30	60,80	16,00	-	1104	-	1270
	8	360	3000	2384	1208	1,31	72,80	19,12	-	1271	-	1462
379 045 100 XX YY 00	10	450	1000	1060	550	1,26	31,00	8,30	-	732	-	842
	10	450	1200	1250	650	1,26	37,00	9,90	-	811	-	933
	10	450	1500	1540	800	1,27	46,00	12,20	-	937	-	1078
	10	450	1600	1640	840	1,28	49,00	13,00	-	977	-	1124
	10	450	1800	1890	970	1,28	55,00	14,50	-	1061	-	1220
	10	450	2000	2020	1040	1,29	61,00	16,10	-	1141	-	1312
	10	450	2200	2210	1140	1,29	67,00	17,60	-	1223	-	1406
	10	450	2500	2500	1280	1,30	76,00	20,00	-	1346	-	1548
	10	450	3000	2980	1510	1,31	91,00	23,90	-	1548	-	1780
379 054 100 XX YY 00	12	540	1000	1272	660	1,26	37,20	9,96	-	847	-	974
	12	540	1200	1500	780	1,26	44,40	11,88	-	949	-	1091
	12	540	1500	1848	960	1,27	55,20	14,64	-	1096	-	1260
	12	540	1600	1968	1008	1,28	58,80	15,60	-	1144	-	1316
	12	540	1800	2268	1164	1,28	66,00	17,40	-	1240	-	1426
	12	540	2000	2424	1248	1,29	73,20	19,32	-	1336	11379-01	1536
	12	540	2200	2652	1368	1,29	80,40	21,12	-	1437	-	1653
	12	540	2500	3000	1536	1,30	91,20	24,00	-	1584	-	1822
	12	540	3000	3576	1812	1,31	109,20	28,68	-	1832	-	2107

Conform EN442-1: 2014: radiatoren en convectoren

Voor meer details over onze artikel-data, zie artikel-database: <https://www.installdata.be>
Voor de warmteafgifte van andere regimes, kijkt u op p. 370 (correctiefactoren)
BELGIË. Prijzen in euro (excl. BTW)

HOE TULIPA-A VERTICAAL BESTELLEN

Leveringstermijn 15 - 30 werkdagen
(zonder transportduur)

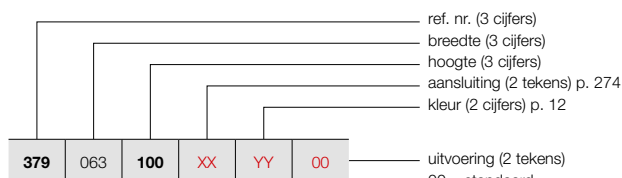

VRIJSTAANDE OPSTELLING (TV2-A)

Zie p. 272 voor extra toebehoren.

HOE VOORRAADRADIATOR VIOLA-A VERTICAAL BESTELLEN

Leveringstermijn 5 werkdagen
(zonder transportduur)

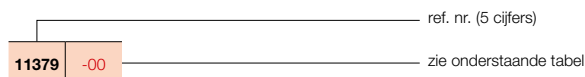

TULIPA-A VERTICAAL (TV2-A)



TV2-A

PRIJSGROEP: VPG2 - STAAL DESIGNRADIATOREN

BESTELCODE MAATWERK TULIPA-A VERTICAAL	TECHNISCHE GEGEVENS							STANDAARDKLEUR		ANDERE KLEUREN							
	buizen	breedte (L mm)	hoogte (H mm)	75/65/20 (Watt) (Φ50K)	55/45/20 (Watt) (Φ30K)	n-exp.	gewicht (kg)	inhoud (l)	el. weerst. (Watt)		prijs RAL 9016 (€)	verkorte ref. nr. RAL 9016 voorraad	prijs kleur (€)				
REF. NR. TULIPA-A VERTICAAL TV2-A : 379																	
379	063	100	XX	YY	00	14	630	1000	1484	770	1,26	43,40	11,62	-	967	-	1112
		120				14	630	1200	1750	910	1,26	51,80	13,86	-	1083	-	1245
		150				14	630	1500	2156	1120	1,27	64,40	17,08	-	1254	-	1442
		160				14	630	1600	2296	1176	1,28	68,60	18,20	-	1313	-	1510
		180				14	630	1800	2646	1358	1,28	77,00	20,30	-	1423	-	1636
		200				14	630	2000	2828	1456	1,29	85,40	22,54	-	1541	11379-02	1772
		220				14	630	2200	3094	1596	1,29	93,80	24,64	-	1653	-	1901
		250				14	630	2500	3500	1792	1,30	106,40	28,00	-	1822	-	2095
		300				14	630	3000	4172	2114	1,31	127,40	33,46	-	2107	-	2423
379	072	100	XX	YY	00	16	720	1000	1696	880	1,26	49,60	13,28	-	1086	-	1249
		120				16	720	1200	2000	1040	1,26	59,20	15,84	-	1215	-	1397
		150				16	720	1500	2464	1280	1,27	73,60	19,52	-	1413	-	1625
		160				16	720	1600	2624	1344	1,28	78,40	20,80	-	1478	-	1700
		180				16	720	1800	3024	1552	1,28	88,00	23,20	-	1603	-	1843
		200				16	720	2000	3232	1664	1,29	97,60	25,76	-	1733	-	1993
		220				16	720	2200	3536	1824	1,29	107,20	28,16	-	1865	-	2145
		250				16	720	2500	4000	2048	1,30	121,60	32,00	-	2063	-	2372
		300				16	720	3000	4768	2416	1,31	145,60	38,24	-	2388	-	2746
379	081	100	XX	YY	00	18	810	1000	1908	990	1,26	55,80	14,94	-	1201	-	1381
		120				18	810	1200	2250	1170	1,26	66,60	17,82	-	1350	-	1553
		150				18	810	1500	2772	1440	1,27	82,80	21,96	-	1565	-	1800
		160				18	810	1600	2952	1512	1,28	88,20	23,40	-	1639	-	1885
		180				18	810	1800	3402	1746	1,28	99,00	26,10	-	1787	-	2055
		200				18	810	2000	3636	1872	1,29	109,80	28,98	-	1936	-	2226
		220				18	810	2200	3978	2052	1,29	120,60	31,68	-	2084	-	2397
		250				18	810	2500	4500	2304	1,30	136,80	36,00	-	2304	-	2650
		300				18	810	3000	5364	2718	1,31	163,80	43,02	-	2672	-	3073
379	090	100	XX	YY	00	20	900	1000	2120	1100	1,26	62,00	16,60	-	1320	-	1518
		120				20	900	1200	2500	1300	1,26	74,00	19,80	-	1482	-	1704
		150				20	900	1500	3080	1600	1,27	92,00	24,40	-	1725	-	1984
		160				20	900	1600	3280	1680	1,28	98,00	26,00	-	1808	-	2079
		180				20	900	1800	3780	1940	1,28	110,00	29,00	-	1971	-	2267
		200				20	900	2000	4040	2080	1,29	122,00	32,20	-	2133	-	2453
		220				20	900	2200	4420	2280	1,29	134,00	35,20	-	2298	-	2643
		250				20	900	2500	5000	2560	1,30	152,00	40,00	-	2544	-	2926
		300				20	900	3000	5960	3020	1,31	182,00	47,80	-	2949	-	3391

Conform EN442-1: 2014: radiatoren en convectoren

Voor meer details over onze artikel-data, zie artikel-database: <https://www.installdata.be>
Voor de warmteafgiftes van andere regimes, kijkt u op p. 370 (correctiefactoren)
BELGIË. Prijzen in euro (excl. BTW)

TULIPA-A VERTICAAL (TV2-A)



TV2-A

HOE TULIPA-A VERTICAAL BESTELLEN

Leveringstermijn 15 - 30 werkdagen
(zonder transportduur)

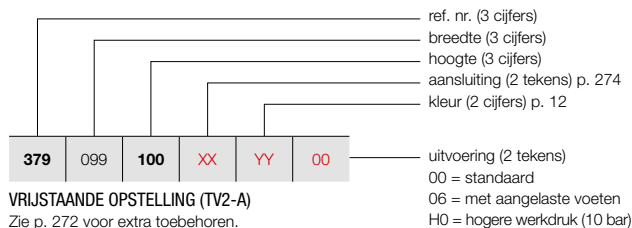

VRIJSTAANDE OPSTELLING (TV2-A)

Zie p. 272 voor extra toebehoren.

PRIJSGROEP: VPG2 - STAAL DESIGNRADIATOREN

BESTELCODE MAATWERK TULIPA-A VERTICAAL							TECHNISCHE GEGEVENS					STANDAARDKLEUR	ANDERE KLEUREN				
379	099	100	XX	YY	00	buizen	breedte (L mm)	hoogte (H mm)	75/65/20 (Watt) (Φ50K)	55/45/20 (Watt) (Φ30K)	n-exp.	gewicht (kg)	inhoud (l)	el. weerst. (Watt)	prijs RAL 9016 (€)	prijs kleur (€)	
REF. NR. TULIPA-A VERTICAAL TV2-A : 379																	
379	099	100	XX	YY	00	22	990	1000	2332	1210	1,26	68,20	18,26	-	1437	1653	
		120				22	990	1200	2750	1430	1,26	81,40	21,78	-	1616	1858	
		150				22	990	1500	3388	1760	1,27	101,20	26,84	-	1884	2167	
		160				22	990	1600	3608	1848	1,28	107,80	28,60	-	1974	2270	
		180				22	990	1800	4158	2134	1,28	121,00	31,90	-	2155	2478	
		200				22	990	2000	4444	2288	1,29	134,20	35,42	-	2336	2686	
		220				22	990	2200	4862	2508	1,29	147,40	38,72	-	2514	2891	
250	22	990	2500	5500	2816	1,30	167,20	44,00	-	2779	3196						
379	108	100	XX	YY	00	24	1080	1000	2544	1320	1,26	74,40	19,92	-	1552	1785	
		120				24	1080	1200	3000	1560	1,26	88,80	23,76	-	1748	2010	
		150				24	1080	1500	3696	1920	1,27	110,40	29,28	-	2043	2349	
		160				24	1080	1600	3936	2016	1,28	117,60	31,20	-	2143	2464	
		180				24	1080	1800	4536	2328	1,28	132,00	34,80	-	2337	2688	
		200				24	1080	2000	4848	2496	1,29	146,40	38,64	-	2530	2910	
		220				24	1080	2200	5304	2736	1,29	160,80	42,24	-	2726	3135	
379	117	100	XX	YY	00	26	1170	1000	2756	1430	1,26	80,60	21,58	-	1671	1922	
		120				26	1170	1200	3250	1690	1,26	96,20	25,74	-	1883	2165	
		150				26	1170	1500	4004	2080	1,27	119,60	31,72	-	2201	2531	
		160				26	1170	1600	4264	2184	1,28	127,40	33,80	-	2306	2652	
		180				26	1170	1800	4914	2522	1,28	143,00	37,70	-	2518	2896	
		200				26	1170	2000	5252	2704	1,29	158,60	41,86	-	2730	3140	
379	126	100	XX	YY	00	28	1260	1000	2968	1540	1,26	86,80	23,24	-	1787	2055	
		120				28	1260	1200	3500	1820	1,26	103,60	27,72	-	2014	2316	
		150				28	1260	1500	4312	2240	1,27	128,80	34,16	-	2356	2709	
		160				28	1260	1600	4592	2352	1,28	137,20	36,40	-	2469	2839	
		180				28	1260	1800	5292	2716	1,28	154,00	40,60	-	2697	3102	

Conform EN442-1: 2014: radiatoren en convectoren

Voor meer details over onze artikel-data, zie artikel-database: <https://www.installdata.be>

Voor de warmteafgifte van andere regimes, kijkt u op p. 370 (correctiefactoren)
BELGIË. Prijzen in euro (excl. BTW)

TYPES

- Eén (TH1-A) of twee rijen buizen (TH2-A)

BUIZEN

- Verticaal, platovaal 60 x 10 mm

COLLECTOREN

- Horizontaal, achterliggend, rond Ø 32 mm

KLEUREN

- Standaardkleur wit RAL 9016
- Uitgebreide kleurenkaart zie p. 12

SPECIAAL

- TH1-A ook verkrijgbaar als toiletradiator (540 x 500 mm)

BEVESTIGINGEN

- Muurbevestigingen standaard (inbegrepen in de verpakking van de radiator)
- **TH1-A / TH2-A:** ook verkrijgbaar als vrijstaande opstelling, zie p. 272. Extra muurbevestigingssteun nodig voor hoogte radiator > 600 mm.

TECHNISCH

- Weerstandsgelast (onzichtbare lasnaden)
- ATL-grondlaag, poedercoating
- Standaardwerkdruk: 6 bar. Meerprijs hogere werkdruk (10 bar): +10%.
- De leveringstermijn van radiator met een hogere werkdruk is 1 week extra.
- Maximale bedrijfstemperatuur: 110°C

ELEKTRISCH

- ✗ Zuiver elektrische radiator in de fabriek voorgevuld
- ✗ Gemengde radiator

TECHNISCHE TEKENINGEN

- Zie p. 275

AANSLUITING

- ✗ Eénpuntsaansluiting voor éénpijpsysteem
- ✗ Eénpuntsaansluiting voor tweepijpsysteem
- ✓ Tweepuntsaansluiting voor éénpijpsysteem (aansluiting via de middenaansluiting) (zie p. 362)
- ✓ Tweepuntsaansluiting voor tweepijpsysteem (standaard) (zie p. 362)
- ✗ Geïntegreerd ventiel
- Aansluitingen: ½" (binnendraad)

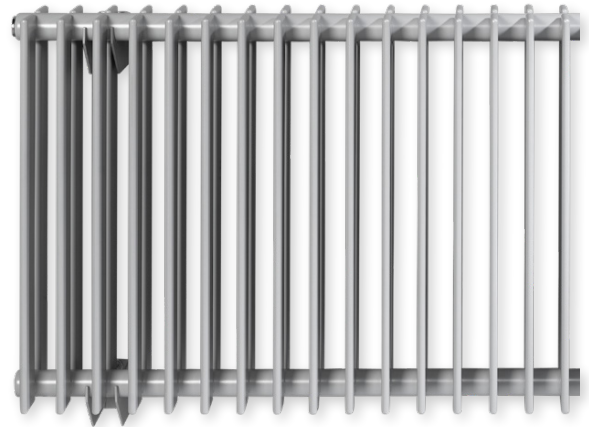
**TULIPA-A HORIZONTAAL****Eeuwige charme, tijdloze klasse**

De horizontale versie van de Tulipa-A. Het schoolvoorbeeld van een designradiator in zijn meest authentieke vorm. Gekenmerkt door de klassieke open structuur en de loodrechte aansluiting van de buizen op de collector. Een designradiator die blijft charmeren. Trendoverstijgend en overal toepasbaar.

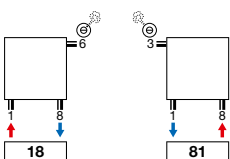
AANBEVOLEN AANSLUITING (18)

Andere aansluitmogelijkheden, zie p. 274



art. nr. 1182 101 0000 0099
prijs €234
Koppelingen, zie p. 377

AANBEVOLEN VOOR BADKAMER EN KEUKEN IN OPTIE

handdoekbeugel (RAL 9005)
art. nr. zie p. 273
prijs €157
Andere accessoires, zie p. 273



TH1-A / TH2-A

TULIPA-A HORIZONTAAL (TH1-A)



TH1-A

HOE TULIPA-A HORIZONTAAL BESTELLEN

Leveringstermijn 15 - 30 werkdagen
(zonder transportduur)

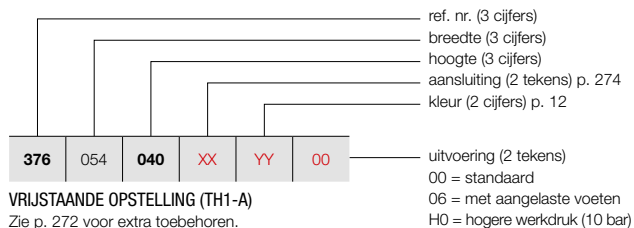

VRIJSTAANDE OPSTELLING (TH1-A)

Zie p. 272 voor extra toebehoren.

PRIJSGROEP: VPG2 - STAAL DESIGNRADIATOREN

BESTELCODE MAATWERK TULIPA-A HORIZONTAAL							TECHNISCHE GEGEVENS					STANDAARDKLEUR	ANDERE KLEUREN				
376	054	040	XX	YY	00	buizen	breedte (L mm)	hoogte (H mm)	75/65/20 (Watt) (Φ50K)	55/45/20 (Watt) (Φ30K)	n-exp.	gewicht (kg)	inhoud (l)	el. weerst. (Watt)	prijs RAL 9016 (€)	prijs kleur (€)	
REF. NR. TULIPA-A HORIZONTAAL TH1-A : 376																	
376	054	040	XX	YY	00	12	540	400	348	180	1,22	9,60	2,52	-	320	368	
		050				12	540	500	420	216	1,23	10,80	3,00	-	346	398	
		060				12	540	600	492	264	1,23	12,00	3,48	-	375	431	
		070				12	540	700	564	300	1,23	14,40	3,96	-	400	460	
		080				12	540	800	636	336	1,23	15,60	4,44	-	431	496	
		090				12	540	900	696	372	1,24	18,00	4,92	-	460	529	
376	063	040	XX	YY	00	14	630	400	406	210	1,22	11,20	2,94	-	355	408	
		050				14	630	500	490	252	1,23	12,60	3,50	-	391	450	
		060				14	630	600	574	308	1,23	15,40	4,06	-	421	484	
		070				14	630	700	658	350	1,23	16,80	4,62	-	454	522	
		080				14	630	800	742	392	1,23	18,20	5,18	-	488	561	
		090				14	630	900	812	434	1,24	21,00	5,74	-	518	596	
376	072	040	XX	YY	00	16	720	400	464	240	1,22	12,80	3,36	-	397	457	
		050				16	720	500	560	288	1,23	14,40	4,00	-	433	498	
		060				16	720	600	656	352	1,23	17,60	4,64	-	472	543	
		070				16	720	700	752	400	1,23	19,20	5,28	-	508	584	
		080				16	720	800	848	448	1,23	20,80	5,92	-	545	627	
		090				16	720	900	928	496	1,24	24,00	6,56	-	581	668	
376	081	040	XX	YY	00	18	810	400	522	270	1,22	14,40	3,78	-	434	499	
		050				18	810	500	630	324	1,23	16,20	4,50	-	475	546	
		060				18	810	600	738	396	1,23	19,80	5,22	-	518	596	
		070				18	810	700	846	450	1,23	21,60	5,94	-	562	646	
		080				18	810	800	954	504	1,23	23,40	6,66	-	605	696	
		090				18	810	900	1044	558	1,24	27,00	7,38	-	646	743	
376	090	040	XX	YY	00	20	900	400	580	300	1,22	16,00	4,20	-	474	545	
		050				20	900	500	700	360	1,23	18,00	5,00	-	519	597	
		060				20	900	600	820	440	1,23	22,00	5,80	-	567	652	
		070				20	900	700	940	500	1,23	24,00	6,60	-	612	704	
		080				20	900	800	1060	560	1,23	26,00	7,40	-	663	762	
		090				20	900	900	1160	620	1,24	30,00	8,20	-	710	817	
376	099	040	XX	YY	00	22	990	400	638	330	1,22	17,60	4,62	-	514	591	
		050				22	990	500	770	396	1,23	19,80	5,50	-	564	649	
		060				22	990	600	902	484	1,23	24,20	6,38	-	614	706	
		070				22	990	700	1034	550	1,23	26,40	7,26	-	667	767	
		080				22	990	800	1166	616	1,23	28,60	8,14	-	719	827	
		090				22	990	900	1276	682	1,24	33,00	9,02	-	767	882	
376	108	040	XX	YY	00	24	1080	400	696	360	1,22	19,20	5,04	-	556	639	
		050				24	1080	500	840	432	1,23	21,60	6,00	-	608	699	
		060				24	1080	600	984	528	1,23	26,40	6,96	-	665	765	
		070				24	1080	700	1128	600	1,23	28,80	7,92	-	720	828	
		080				24	1080	800	1272	672	1,23	31,20	8,88	-	776	892	
		090				24	1080	900	1392	744	1,24	36,00	9,84	-	831	956	

Conform EN442-1: 2014: radiatoren en convectoren

Voor meer details over onze artikel-data, zie artikel-database: <https://www.installdata.be>

Voor de warmteafgifte van andere regimes, kijkt u op p. 370 (correctiefactoren)

BELGIË. Prijzen in euro (excl. BTW)

HOE TULIPA-A HORIZONTAAL BESTELLEN

Leveringstermijn 15 - 30 werkdagen
(zonder transportduur)

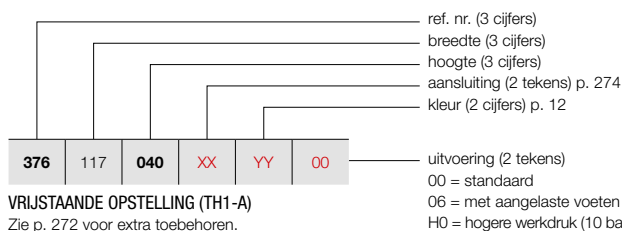

VRIJSTAANDE OPSTELLING (TH1-A)

Zie p. 272 voor extra toebehoren.

TULIPA-A HORIZONTAAL (TH1-A)



TH1-A

PRIJSGROEP: VPG2 - STAAL DESIGNRADIATOREN

BESTELCODE MAATWERK TULIPA-A HORIZONTAAL	TECHNISCHE GEGEVENS							STANDAARDKLEUR		ANDERE KLEUREN	
	buizen	breedte (L mm)	hoogte (H mm)	75/65/20 (Watt) (φ50K)	55/45/20 (Watt) (φ30K)	n-exp.	gewicht (kg)	inhoud (l)	el. weerst. (Watt)	prijs RAL 9016 (€)	prijs kleur (€)
REF. NR. TULIPA-A HORIZONTAAL TH1-A : 376											
376	117	040	XX	YY	00						
		050								589	677
		060								651	749
		070								714	821
		080								771	887
		090								832	957
										895	1029
376	126	040	XX	YY	00						
		050								630	725
		060								696	800
		070								759	873
		080								826	950
		090								892	1026
										959	1103
376	144	040	XX	YY	00						
		050								710	817
		060								785	903
		070								857	986
		080								930	1070
		090								1006	1157
										1082	1244
376	162	040	XX	YY	00						
		050								787	905
		060								870	1001
		070								956	1099
		080								1039	1195
		090								1123	1291
										1202	1382
376	180	040	XX	YY	00						
		050								864	994
		060								960	1105
		070								1050	1208
		080								1144	1316
		090								1237	1423
										1329	1528
376	198	040	XX	YY	00						
		050								943	1084
		060								1046	1203
		070								1148	1320
		080								1248	1435
		090								1351	1554
										1452	1670
376	216	040	XX	YY	00						
		050								1022	1175
		060								1134	1304
		070								1243	1429
		080								1356	1559
		090								1469	1689
										1582	1819

Conform EN442-1: 2014: radiatoren en convectoren

Voor meer details over onze artikel-data, zie artikel-database: <https://www.installdata.be>

Voor de warmteafgiftes van andere regimes, kijkt u op p. 370 (correctiefactoren)

BELGIË. Prijzen in euro (excl. BTW)

TULIPA-A HORIZONTAAL (TH1-A)



TH1-A

HOE TULIPA-A HORIZONTAAL BESTELLEN

Leveringstermijn 15 - 30 werkdagen
(zonder transportduur)

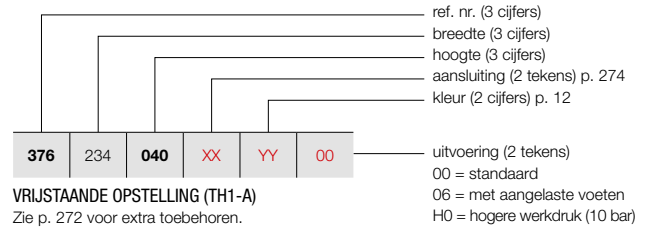

VRIJSTAANDE OPSTELLING (TH1-A)

Zie p. 272 voor extra toebehoren.

PRIJSGROEP: VPG2 - STAAL DESIGNRADIATOREN

BESTELCODE MAATWERK TULIPA-A HORIZONTAAL	TECHNISCHE GEGEVENS									STANDAARDKLEUR	ANDERE KLEUREN
	buizen	breedte (L mm)	hoogte (H mm)	75/65/20 (Watt) (Φ50K)	55/45/20 (Watt) (Φ30K)	n-exp.	gewicht (kg)	inhoud (l)	el. weerst. (Watt)	prijs RAL 9016 (€)	prijs kleur (€)
REF. NR. TULIPA-A HORIZONTAAL TH1-A : 376											
376	234	040	XX	YY	00						
		050									
		060									
		070									
		080									
		090									
376	252	040	XX	YY	00						
		050									
		060									
		070									
		080									
		090									
376	270	040	XX	YY	00						
		050									
		060									
		070									
		080									
376	288	040	XX	YY	00						
		050									
		060									
		070									
376	306	040	XX	YY	00						
		050									
		060									
		070									

Conform EN442-1: 2014: radiatoren en convectoren

Voor meer details over onze artikel-data, zie artikel-database: <https://www.installdata.be>

Voor de warmteafgifte van andere regimes, kijkt u op p. 370 (correctiefactoren)
BELGIË. Prijzen in euro (excl. BTW)

HOE TULIPA-A HORIZONTAAL BESTELLEN

Leveringstermijn 15 - 30 werkdagen
(zonder transportduur)

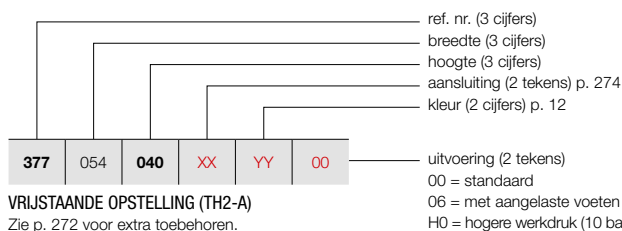

VRIJSTAANDE OPSTELLING (TH2-A)

Zie p. 272 voor extra toebehoren.

TULIPA-A HORIZONTAAL (TH2-A)

269



TH2-A

PRIJSGROEP: VPG2 - STAAL DESIGNRADIATOREN

BESTELCODE MAATWERK TULIPA-A HORIZONTAAL	TECHNISCHE GEGEVENS							STANDAARDKLEUR		ANDERE KLEUREN	
	buizen	breedte (L mm)	hoogte (H mm)	75/65/20 (Watt) (Φ50K)	55/45/20 (Watt) (Φ30K)	n-exp.	gewicht (kg)	inhoud (l)	el. weerst. (Watt)	prijs RAL 9016 (€)	prijs kleur (€)
REF. NR. TULIPA-A HORIZONTAAL TH2-A : 377											
377	054	040	XX	YY	00						
		050								561	645
		060								607	698
		070								653	751
		080								703	808
		090								753	866
										802	922
377	063	040	XX	YY	00						
		050								625	719
		060								678	780
		070								737	848
		080								797	917
		090								852	980
										911	1048
377	072	040	XX	YY	00						
		050								690	794
		060								758	872
		070								825	949
		080								888	1021
		090								956	1099
										1021	1174
377	081	040	XX	YY	00						
		050								760	874
		060								833	958
		070								911	1048
		080								979	1126
		090								1054	1212
										1129	1298
377	090	040	XX	YY	00						
		050								831	956
		060								913	1050
		070								991	1140
		080								1074	1235
		090								1155	1328
										1238	1424
377	099	040	XX	YY	00						
		050								897	1032
		060								986	1134
		070								1078	1240
		080								1166	1341
		090								1256	1444
										1347	1549
377	108	040	XX	YY	00						
		050								967	1112
		060								1066	1226
		070								1158	1332
		080								1258	1447
		090								1361	1565
										1452	1670

Conform EN442-1: 2014: radiatoren en convectoren

Voor meer details over onze artikel-data, zie artikel-database: <https://www.installdata.be>

Voor de warmteafgiftes van andere regimes, kijkt u op p. 370 (correctiefactoren)
BELGIË. Prijzen in euro (excl. BTW)

TULIPA-A HORIZONTAAL (TH2-A)



TH2-A

HOE TULIPA-A HORIZONTAAL BESTELLEN

Leveringstermijn 15 - 30 werkdagen
(zonder transportduur)

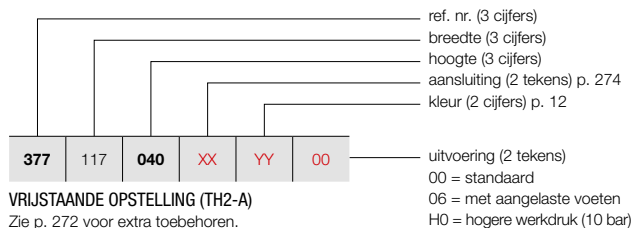

VRIJSTAANDE OPSTELLING (TH2-A)

Zie p. 272 voor extra toebehoren.

PRIJSGROEP: VPG2 - STAAL DESIGNRADIATOREN

BESTELCODE MAATWERK TULIPA-A HORIZONTAAL							TECHNISCHE GEGEVENS					STANDAARDKLEUR	ANDERE KLEUREN				
377	117	040	XX	YY	00	buizen	breedte (L mm)	hoogte (H mm)	75/65/20 (Watt) (Ø50K)	55/45/20 (Watt) (Ø30K)	n-exp.	gewicht (kg)	inhoud (l)	el. weerst. (Watt)	prijs RAL 9016 (€)	prijs kleur (€)	
REF. NR. TULIPA-A HORIZONTAAL TH2-A : 377																	
377	117	040	XX	YY	00	26	1170	400	1274	676	1,24	36,40	9,36	-	1037	1193	
		050				26	1170	500	1404	806	1,25	44,20	11,44	-	1141	1312	
		060				26	1170	600	1768	936	1,25	52,00	13,52	-	1247	1434	
		070				26	1170	700	2028	1066	1,25	57,20	15,60	-	1351	1554	
		080				26	1170	800	2262	1196	1,25	65,00	17,68	-	1461	1680	
		090				26	1170	900	2522	1300	1,26	72,80	19,50	-	1566	1801	
377	126	040	XX	YY	00	28	1260	400	1372	728	1,24	39,20	10,08	-	1105	1271	
		050				28	1260	500	1512	868	1,25	47,60	12,32	-	1217	1400	
		060				28	1260	600	1904	1008	1,25	56,00	14,56	-	1330	1530	
		070				28	1260	700	2184	1148	1,25	61,60	16,80	-	1445	1662	
		080				28	1260	800	2436	1288	1,25	70,00	19,04	-	1559	1793	
		090				28	1260	900	2716	1400	1,26	78,40	21,00	-	1674	1925	
377	144	040	XX	YY	00	32	1440	400	1568	832	1,24	44,80	11,52	-	1238	1424	
		050				32	1440	500	1728	992	1,25	54,40	14,08	-	1371	1577	
		060				32	1440	600	2176	1152	1,25	64,00	16,64	-	1496	1720	
		070				32	1440	700	2496	1312	1,25	70,40	19,20	-	1632	1877	
		080				32	1440	800	2784	1472	1,25	80,00	21,76	-	1761	2025	
		090				32	1440	900	3104	1600	1,26	89,60	24,00	-	1889	2172	
377	162	040	XX	YY	00	36	1620	400	1764	936	1,24	50,40	12,96	-	1377	1584	
		050				36	1620	500	1944	1116	1,25	61,20	15,84	-	1525	1754	
		060				36	1620	600	2448	1296	1,25	72,00	18,72	-	1671	1922	
		070				36	1620	700	2808	1476	1,25	79,20	21,60	-	1816	2088	
		080				36	1620	800	3132	1656	1,25	90,00	24,48	-	1964	2259	
		090				36	1620	900	3492	1800	1,26	100,80	27,00	-	2107	2423	
377	180	040	XX	YY	00	40	1800	400	1960	1040	1,24	56,00	14,40	-	1511	1738	
		050				40	1800	500	2160	1240	1,25	68,00	17,60	-	1675	1926	
		060				40	1800	600	2720	1440	1,25	80,00	20,80	-	1838	2114	
		070				40	1800	700	3120	1640	1,25	88,00	24,00	-	2000	2300	
		080				40	1800	800	3480	1840	1,25	100,00	27,20	-	2165	2490	
		090				40	1800	900	3880	2000	1,26	112,00	30,00	-	2326	2675	
377	198	040	XX	YY	00	44	1980	400	2156	1144	1,24	61,60	15,84	-	1651	1899	
		050				44	1980	500	2376	1364	1,25	74,80	19,36	-	1832	2107	
		060				44	1980	600	2992	1584	1,25	88,00	22,88	-	2011	2313	
		070				44	1980	700	3432	1804	1,25	96,80	26,40	-	2189	2517	
		080				44	1980	800	3828	2024	1,25	110,00	29,92	-	2365	2720	
		090				44	1980	900	4268	2200	1,26	123,20	33,00	-	2549	2931	
377	216	040	XX	YY	00	48	2160	400	2352	1248	1,24	67,20	17,28	-	1787	2055	
		050				48	2160	500	2592	1488	1,25	81,60	21,12	-	1983	2280	
		060				48	2160	600	3264	1728	1,25	96,00	24,96	-	2178	2505	
		070				48	2160	700	3744	1968	1,25	105,60	28,80	-	2372	2728	
		080				48	2160	800	4176	2208	1,25	120,00	32,64	-	2567	2952	
		090				48	2160	900	4656	2400	1,26	134,40	36,00	-	2766	3181	

Conform EN442-1: 2014: radiatoren en convectoren

Voor meer details over onze artikel-data, zie artikel-database: <https://www.installdata.be>

Voor de warmteafgifte van andere regimes, kijkt u op p. 370 (correctiefactoren)
BELGIË. Prijzen in euro (excl. BTW)

HOE TULIPA-A HORIZONTAAL BESTELLEN

Leveringstermijn 15 - 30 werkdagen
(zonder transportduur)

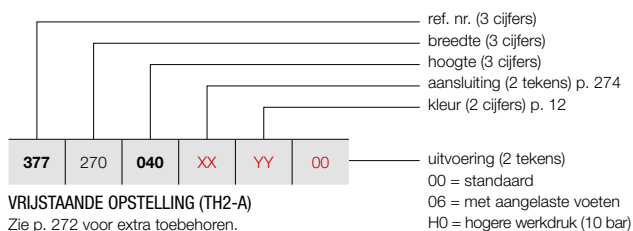

VRIJSTAANDE OPSTELLING (TH2-A)

Zie p. 272 voor extra toebehoren.

TULIPA-A HORIZONTAAL (TH2-A)



TH2-A

PRIJSGROEP: VPG2 - STAAL DESIGNRADIATOREN

BESTELCODE MAATWERK TULIPA-A HORIZONTAAL	TECHNISCHE GEGEVENS							STANDAARDKLEUR		ANDERE KLEUREN						
	buizen	breedte (L mm)	hoogte (H mm)	75/65/20 (Watt) (φ50K)	55/45/20 (Watt) (φ30K)	n-exp.	gewicht (kg)	inhoud (l)	el. weerst. (Watt)	prijs RAL 9016 (€)	prijs kleur (€)					
REF. NR. TULIPA-A HORIZONTAAL TH2-A : 377																
377	234	040	XX	YY	00	52	2340	400	2548	1352	1,24	72,80	18,72	-	1924	2213
		050				52	2340	500	2808	1612	1,25	88,40	22,88	-	2135	2455
		060				52	2340	600	3536	1872	1,25	104,00	27,04	-	2345	2697
		070				52	2340	700	4056	2132	1,25	114,40	31,20	-	2557	2941
		080				52	2340	800	4524	2392	1,25	130,00	35,36	-	2770	3186
		090				52	2340	900	5044	2600	1,26	145,60	39,00	-	2983	3430
		377				252	040	XX	YY	00	56	2520	400	2744	1456	1,24
050	56	2520	500	3024	1736		1,25				95,20	24,64	-	2288	2631	
060	56	2520	600	3808	2016		1,25				112,00	29,12	-	2515	2892	
070	56	2520	700	4368	2296		1,25				123,20	33,60	-	2744	3156	
080	56	2520	800	4872	2576		1,25				140,00	38,08	-	2971	3417	
090	56	2520	900	5432	2800		1,26				156,80	42,00	-	3199	3679	
377	270	040	XX	YY	00		60				2700	400	2940	1560	1,24	84,00
050		60				2700	500	3240	1860	1,25	102,00	26,40	-	2443	2809	
060		60				2700	600	4080	2160	1,25	120,00	31,20	-	2681	3083	
070		60				2700	700	4680	2460	1,25	132,00	36,00	-	2929	3368	
080		60				2700	800	5220	2760	1,25	150,00	40,80	-	3173	3649	
377		288				040	XX	YY	00	64	2880	400	3136	1664	1,24	89,60
050	64		2880	500	3456	1984				1,25	108,80	28,16	-	2594	2983	
060	64		2880	600	4352	2304				1,25	128,00	33,28	-	2856	3284	
070	64		2880	700	4992	2624				1,25	140,80	38,40	-	3114	3581	
377	306		040	XX	YY	00				68	3060	400	3332	1768	1,24	95,20
050		68	3060				500	3672	2108	1,25	115,60	29,92	-	2748	3160	
060		68	3060				600	4624	2448	1,25	136,00	35,36	-	3023	3476	
070		68	3060				700	5304	2788	1,25	149,60	40,80	-	3298	3793	

Conform EN442-1: 2014: radiatoren en convectoren

Voor meer details over onze artikel-data, zie artikel-database: <https://www.installdata.be>

Voor de warmteafgifte van andere regimes, kijkt u op p. 370 (correctiefactoren)

BELGIË. Prijzen in euro (excl. BTW)

TULIPA-A VRIJSTAANDE OPSTELLING IN OPTIE

PRIJSGROEP: VPG10 - ACC.

VRIJSTAANDE OPSTELLING		KLEUR	ART. NR.	€	
VASTE VOET		TV1-A / TH1-A			
		150 mm	RAL 9016	*	77
		(geen zijbevestiging)	KLEUR	*	88
		TV2-A / TH2-A			
		150 mm	RAL 9016	*	152
		(geen zijbevestiging)	KLEUR	*	175

- Extra muurbevestigingssteun nodig voor hoogte radiator > 600 mm (meegeleverd).
- Gelieve bij bestelling code **06** aan te geven bij "Afwerking" (vaste voet in de prijs inbegrepen).
- Geen rozetten beschikbaar.

	TV1-A / TV2-A		TH1-A / TH2-A	
		540 - 1440	1620 - 2340	> 2340
lengte radiator (mm)				
aantal voeten	2x	2x	3x	4x

BELGIË. Prijzen in euro (excl. BTW)

PRIJSGROEP: VPG10B - HANDDOEKBEUGELS

ACCESSOIRES	BREEDTE HANDDOEKBEUGEL	KLEUR	ART. NR.	€
HANDDOEKBEUGEL	TV1-A / TV2-A / TH1-A / TH2-A			
	500 mm	CHROOM	1183 269 0000 0099	157
	500 mm	RAL 9016	1183 269 0000 9016	157
	500 mm	RAL 9005 ^M	1183 269 0000 9005	157



- h = 55 mm; b = 500 mm; d = 58 mm; a = 43 mm;

^M mat zwart

Montagevoorschriften accessoires: zie www.vasco.eu
BELGIË. Prijzen in euro (excl. BTW)

d = afstand voorkant accessoire tot voorkant radiator
a = afstand accessoire tot radiator
uit voorraad leverbaar

TULIPA-A VERTICAAL: TV1-A / TV2-A (VOORRAAD)

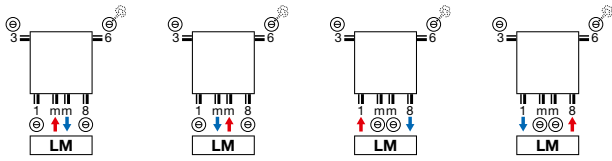

TULIPA-A HORIZONTAAL: TH1-A / TH2-A (NIET-VOORRAAD)

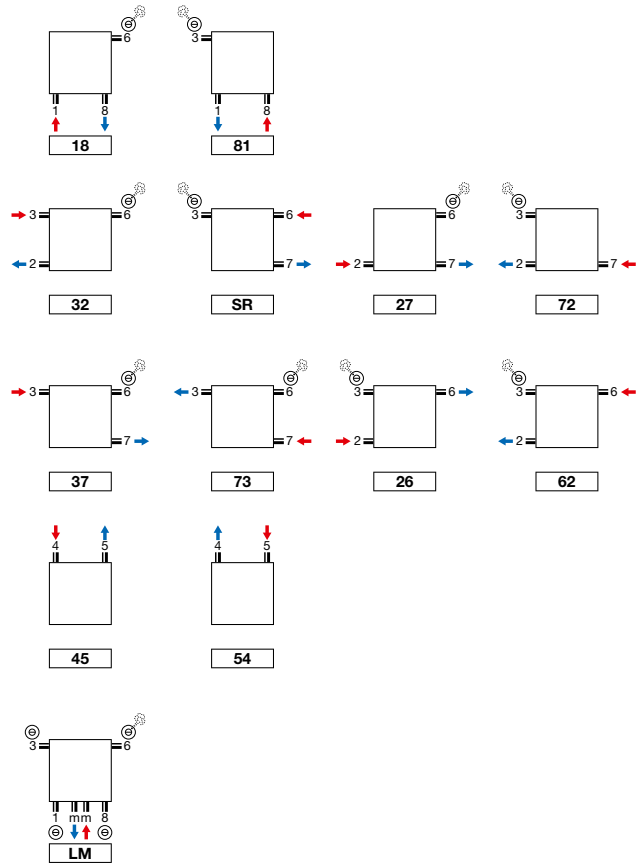

TULIPA-A VERTICAAL: TV1-A / TV2-A (NIET-VOORRAAD)

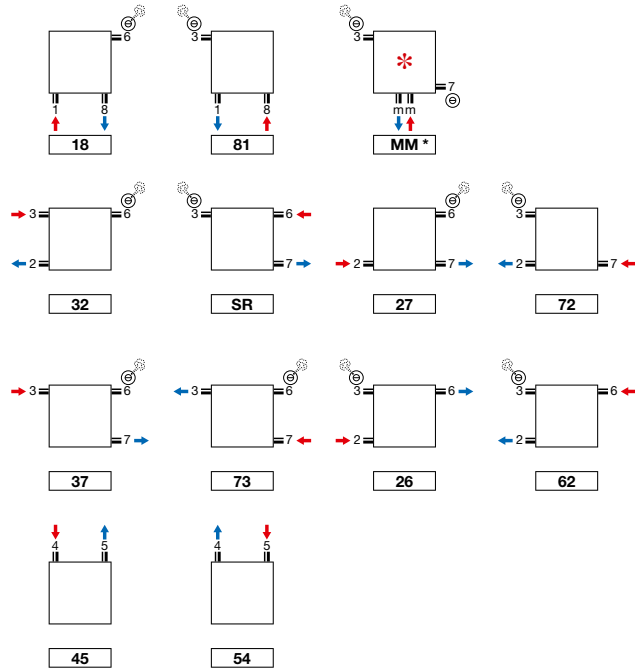

- * Aansluiting MM: aanvoer moet aan de rechterkant!
- Tulipa-A 6 en 8 buizen: aansluiting 1mm8, 18, 81 niet mogelijk

Opmerking: het aansluiten van de radiator kan enkel volgens de getoonde aansluiticonen. Voor elke andere aansluitwijze nemen wij geen verantwoordelijkheid.

TULIPA-A VERTICAAL (TV1-A, TV2-A)

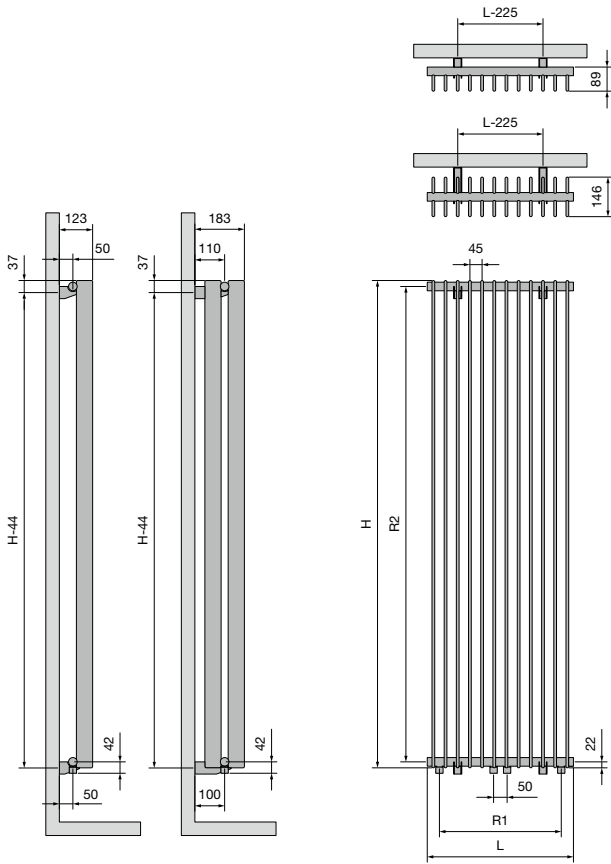

TV1-A / TV2-A

Breedte (L)	270	360	450	540	630	720	810	900	990	1080	1170	1260
Hartafstand tussen de onderaansluitingen 18 (R1)	180	270	360	450	540	630	720	810	900	990	1080	1170
Hoogte (H)	1000	1200	1500	1600	1800	2000	2200	2500	3000			
Hartafstand tussen de zijaansluitingen 32/SR (R2)	956	1156	1456	1556	1756	1956	2156	2456	2956			
Hartafstand tussen de ophangingen	H-44											

TULIPA-A HORIZONTAAL (TH1-A, TH2-A)

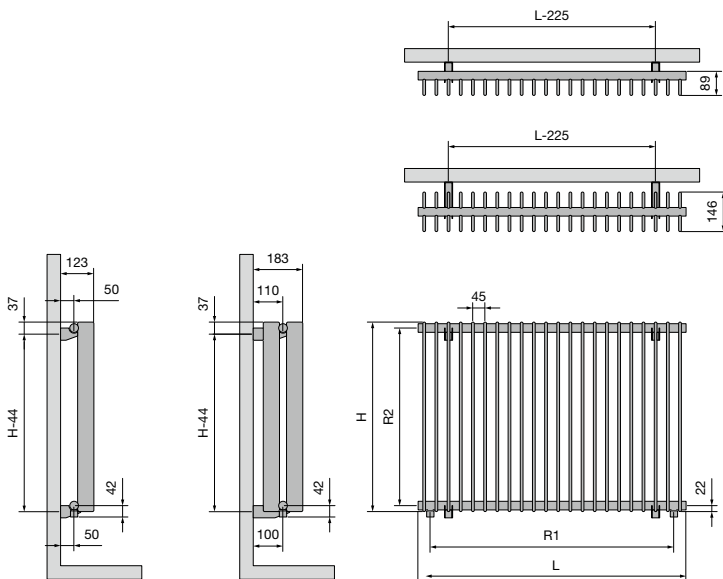

TH1-A / TH2-A

Breedte (L)	540	630	720	810	900	990	1080	1170	1260	1440	1620	1800	1980	2160	2340	2520	2700	2880	3060
Hartafstand tussen de onderaansluitingen 18 (R1)	450	540	630	720	810	900	990	1080	1170	1350	1530	1710	1890	2070	2250	2430	2610	2790	2970
Hoogte (H)	400	500	600	700	800	900													
Hartafstand tussen de zijaansluitingen 32/SR (R2)	356	456	556	656	756	856													
Hartafstand tussen de ophangingen	H-44																		