



Plintradiatoren

Maximale warmte, minimale impact.

Ook bij plintradiatoren vertaalt VASCO zijn kritische kijk op comfort en design in een doordachte totaaloplossing.

Elk ontwerp is gericht op maximaal rendement en een verfijnde, elegante uitstraling — ideaal voor plaatsing onder grote raamoppervlakken.

Ze zorgen voor een gelijkmatige warmteverdeling in de volledige ruimte en beperken warmteverlies via het glas tot een minimum.

Een discrete, efficiënte verwarmingsoplossing die perfect aansluit bij hedendaagse architectuur.

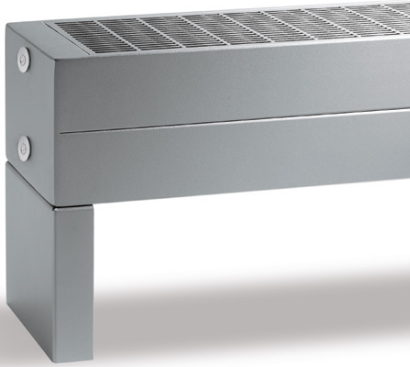

TYPES

- P1, P2, P3, P4

BUIZEN

- Horizontaal, rechthoekig 70 x 10 mm
- Tussen de rechthoekige buizen is een krachtige convectie-warmtewisselaar uit stalen precisiebuisen van Ø 12 x 1 mm en rechthoekige lamellen van 0,4 mm gelast.

COLLECTOREN

- 2 geïntegreerde stalen collectoren

KLEUREN

- Standaardkleur wit RAL 9016
- Uitgebreide kleurenkaart zie p. 12

SPECIAAL

- Type Primula wordt in 4 hoogtes (70, 140, 210 en 280 mm), in 5 dieptes (80, 130, 180, 230 en 280 mm) en in 20 lengtes (van 500 tot 3900 mm) geleverd.
- Een elegant afdekrooster wordt standaard meegeleverd.
- Muurbevestigingen, telescopische voetjes of kolomvoeten kunnen mits meerprijs meegeleverd worden (niet in de prijs inbegrepen).

BEVESTIGINGEN

- Apart te bestellen, niet in de prijs van de plint inbegrepen

TECHNISCH

- Elektrisch lasergelast (onzichtbare lasnaden)
- ATL-grondlaag, poedercoating
- Standaardwerkdruk: 4 bar
- Meerprijs voor hogere werkdruk (10 bar): + 10%.
- De leveringstermijn van radiator met een hogere werkdruk is 1 week extra.
- Maximale bedrijfstemperatuur: 110°C

ELEKTRISCH

- ✗ Zuiver elektrische radiator in de fabriek voorgevuld
- ✗ Gemengde radiator

TECHNISCHE TEKENINGEN

- Zie p. 320

AANSLUITING

- ✗ Eénpuntsaansluiting voor éénpijpssysteem
- ✗ Eénpuntsaansluiting voor tweepijpssysteem
- ✗ Tweepuntsaansluiting voor éénpijpssysteem
- ✓ Tweepuntsaansluiting voor tweepijpssysteem (standaard) (zie p. 362)
- ✗ Geïntegreerd ventiel
- Aansluitingen: 1/2" (binnendraad)

PRIMULA

Verwamingscomfort met ruimtegevoel

Een ruimte met grote raampartijen verwarmen, geheel in lijn met de interieurinrichting en de architectuur is een kolfje naar de hand van de Primula design plintradiator. De strakke, horizontale lijnvoering op lage hoogte draagt bij tot het gewenste ruimtegevoel en de hoge warmteafgifte, ook in de minimale uitvoering, maakt het eigentijds comfort compleet.

AANBEVOLEN AANSLUITING (18)

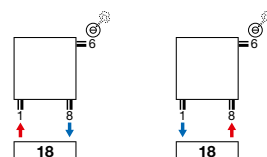

Andere aansluitmogelijkheden, zie p. 319



HOE P1/80 BESTELLEN

Leveringstermijn 15 - 30 werkdagen
(zonder transportduur)

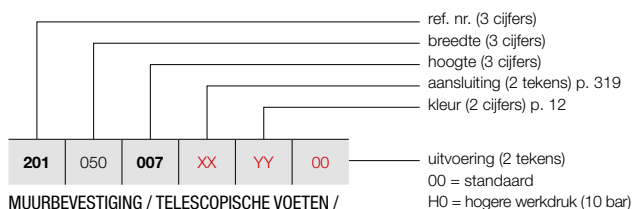

MUURBEVESTIGING / TELESCOPISCHE VOETEN /
KOLOMVOETEN

Zie p. 317 voor extra toebehoren.

PRIMULA P1 (P1/80)

297



P1

PRIJSGROEP: VPG3 - PLINTRADIATOREN

BESTELCODE MAATWERK P1	TECHNISCHE GEGEVENS											STANDAARDKLEUR	ANDERE KLEUREN			
	buizen	breedte (L mm)	hoogte (H mm)	75/65/20 (Watt) (Φ50K)	55/45/20 (Watt) (Φ30K)	n-exp.	gewicht (kg)	inhoud (l)	el. weerst. (Watt)	prijs RAL 9016 (€)	prijs kleur (€)					
REF. NR. P1/80 : 201																
201	050	007	XX	YY	00	-	500	70	203	101	1,36	3,07	0,66	-	298	343
201	060	007	XX	YY	00	-	600	70	243	121	1,36	3,68	0,79	-	312	359
201	070	007	XX	YY	00	-	700	70	284	142	1,36	4,29	0,92	-	326	375
201	080	007	XX	YY	00	-	800	70	324	162	1,36	4,90	1,05	-	339	390
201	090	007	XX	YY	00	-	900	70	365	182	1,36	5,52	1,18	-	353	406
201	100	007	XX	YY	00	-	1000	70	405	202	1,36	6,13	1,31	-	364	419
201	110	007	XX	YY	00	-	1100	70	446	223	1,36	6,74	1,44	-	385	443
201	120	007	XX	YY	00	-	1200	70	486	243	1,36	7,36	1,57	-	397	457
201	140	007	XX	YY	00	-	1400	70	567	283	1,36	8,58	1,83	-	424	488
201	160	007	XX	YY	00	-	1600	70	648	323	1,36	9,81	2,10	-	448	515
201	180	007	XX	YY	00	-	1800	70	729	364	1,36	11,03	2,36	-	479	551
201	200	007	XX	YY	00	-	2000	70	810	404	1,36	12,26	2,62	-	508	584
201	220	007	XX	YY	00	-	2200	70	891	445	1,36	13,49	2,88	-	534	614
201	240	007	XX	YY	00	-	2400	70	972	485	1,36	14,71	3,14	-	563	647
201	260	007	XX	YY	00	-	2600	70	1053	526	1,36	15,94	3,41	-	589	677
201	280	007	XX	YY	00	-	2800	70	1134	566	1,36	17,16	3,67	-	619	712
201	300	007	XX	YY	00	-	3000	70	1215	607	1,36	18,39	3,93	-	648	745
201	330	007	XX	YY	00	-	3300	70	1337	667	1,36	20,23	4,32	-	687	790
201	360	007	XX	YY	00	-	3600	70	1458	728	1,36	22,07	4,72	-	730	840
201	390	007	XX	YY	00	-	3900	70	1580	789	1,36	23,91	5,11	-	771	887

Conform EN442-1: 2014: radiatoren en convectoren

Voor meer details over onze artikel-data, zie artikel-database: <https://www.installdata.be>
Voor de warmteafgiftes van andere regimes, kijkt u op p. 370 (correctiefactoren)
BELGIË. Prijzen in euro (excl. BTW)

PRIMULA P1 (P1/130)



P1

HOE P1/130 BESTELLEN

Leveringstermijn 15 - 30 werkdagen
(zonder transportduur)

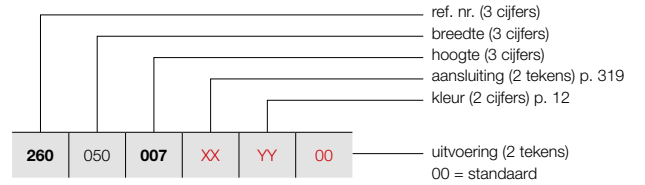

MUURBEVESTIGING / TELESCOPISCHE VOETEN / KOLOMVOETEN

Zie p. 317 voor extra toebehoren.

PRIJSGROEP: VPG3 - PLINTRADIATOREN

BESTELCODE MAATWERK P1	TECHNISCHE GEGEVENS										STANDAARDKLEUR	ANDERE KLEUREN
	buizen	breedte (L mm)	hoogte (H mm)	75/65/20 (Watt) (φ50K)	55/45/20 (Watt) (φ30K)	n-exp.	gewicht (kg)	inhoud (l)	el. weerst. (Watt)		prijs RAL 9016 (€)	prijs kleur (€)
REF. NR. P1/130 : 260												
260 050 007 XX YY 00	-	500	70	312	156	1,36	4,33	0,88	-		398	458
260 060 007 XX YY 00	-	600	70	374	187	1,36	5,19	1,05	-		419	482
260 070 007 XX YY 00	-	700	70	437	218	1,36	6,06	1,23	-		442	508
260 080 007 XX YY 00	-	800	70	499	249	1,36	6,92	1,40	-		465	535
260 090 007 XX YY 00	-	900	70	562	281	1,36	7,79	1,58	-		484	557
260 100 007 XX YY 00	-	1000	70	624	312	1,36	8,65	1,75	-		508	584
260 110 007 XX YY 00	-	1100	70	686	342	1,36	9,52	1,93	-		528	607
260 120 007 XX YY 00	-	1200	70	749	374	1,36	10,38	2,10	-		556	639
260 140 007 XX YY 00	-	1400	70	874	436	1,36	12,11	2,45	-		594	683
260 160 007 XX YY 00	-	1600	70	998	498	1,36	13,84	2,80	-		641	737
260 180 007 XX YY 00	-	1800	70	1123	561	1,36	15,57	3,15	-		681	783
260 200 007 XX YY 00	-	2000	70	1248	623	1,36	17,30	3,50	-		726	835
260 220 007 XX YY 00	-	2200	70	1373	685	1,36	19,03	3,85	-		770	886
260 240 007 XX YY 00	-	2400	70	1498	748	1,36	20,76	4,20	-		814	936
260 260 007 XX YY 00	-	2600	70	1622	810	1,36	22,49	4,55	-		859	988
260 280 007 XX YY 00	-	2800	70	1747	872	1,36	24,22	4,90	-		903	1038
260 300 007 XX YY 00	-	3000	70	1872	935	1,36	25,95	5,25	-		948	1090
260 330 007 XX YY 00	-	3300	70	2059	1028	1,36	28,55	5,78	-		1009	1160
260 360 007 XX YY 00	-	3600	70	2246	1121	1,36	31,14	6,30	-		1079	1241
260 390 007 XX YY 00	-	3900	70	2434	1215	1,36	33,74	6,83	-		1144	1316

Conform EN442-1: 2014: radiatoren en convectoren

Voor meer details over onze artikel-data, zie artikel-database: <https://www.installdata.be>

Voor de warmteafgiftes van andere regimes, kijkt u op p. 370 (correctiefactoren)
BELGIË. Prijzen in euro (excl. BTW)

HOE P1/180 BESTELLEN

Leveringstermijn 15 - 30 werkdagen
(zonder transportduur)

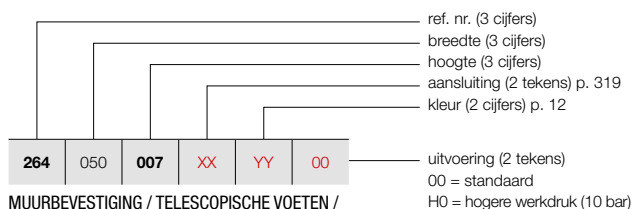

MUURBEVESTIGING / TELESCOPISCHE VOETEN /
KOLOMVOETEN

Zie p. 317 voor extra toebehoren.

PRIMULA P1 (P1/180)

299



P1

PRIJSGROEP: VPG3 - PLINTRADIATOREN

BESTELCODE MAATWERK P1	TECHNISCHE GEGEVENS											STANDAARDKLEUR	ANDERE KLEUREN			
	buizen	breedte (L mm)	hoogte (H mm)	75/65/20 (Watt) (Φ50K)	55/45/20 (Watt) (Φ30K)	n-exp.	gewicht (kg)	inhoud (l)	el. weerst. (Watt)	prijs RAL 9016 (€)	prijs kleur (€)					
REF. NR. P1/180 : 264																
264	050	007	XX	YY	00	-	500	70	422	212	1,35	5,70	1,05	-	527	606
264	060	007	XX	YY	00	-	600	70	506	254	1,35	6,84	1,26	-	563	647
264	070	007	XX	YY	00	-	700	70	590	296	1,35	7,98	1,47	-	597	687
264	080	007	XX	YY	00	-	800	70	674	338	1,35	9,12	1,68	-	630	725
264	090	007	XX	YY	00	-	900	70	759	381	1,35	10,26	1,89	-	666	766
264	100	007	XX	YY	00	-	1000	70	843	423	1,35	11,40	2,10	-	698	803
264	110	007	XX	YY	00	-	1100	70	927	465	1,35	12,54	2,31	-	734	844
264	120	007	XX	YY	00	-	1200	70	1012	508	1,35	13,68	2,52	-	766	881
264	140	007	XX	YY	00	-	1400	70	1180	592	1,35	15,96	2,94	-	834	959
264	160	007	XX	YY	00	-	1600	70	1349	677	1,35	18,24	3,36	-	905	1041
264	180	007	XX	YY	00	-	1800	70	1517	761	1,35	20,52	3,78	-	974	1120
264	200	007	XX	YY	00	-	2000	70	1686	846	1,35	22,80	4,20	-	1043	1199
264	220	007	XX	YY	00	-	2200	70	1855	931	1,35	25,08	4,62	-	1110	1277
264	240	007	XX	YY	00	-	2400	70	2023	1015	1,35	27,36	5,04	-	1178	1355
264	260	007	XX	YY	00	-	2600	70	2192	1100	1,35	29,64	5,46	-	1244	1431
264	280	007	XX	YY	00	-	2800	70	2360	1184	1,35	31,92	5,88	-	1315	1512
264	300	007	XX	YY	00	-	3000	70	2529	1269	1,35	34,20	6,30	-	1385	1593
264	330	007	XX	YY	00	-	3300	70	2782	1396	1,35	37,62	6,93	-	1485	1708
264	360	007	XX	YY	00	-	3600	70	3035	1523	1,35	41,04	7,56	-	1587	1825
264	390	007	XX	YY	00	-	3900	70	3288	1650	1,35	44,46	8,19	-	1692	1946

Conform EN442-1: 2014: radiatoren en convectoren

Voor meer details over onze artikel-data, zie artikel-database: <https://www.installdata.be>
Voor de warmteafgiftes van andere regimes, kijkt u op p. 370 (correctiefactoren)
BELGIË. Prijzen in euro (excl. BTW)

PRIMULA P1 (P1/230)



P1

HOE P1/230 BESTELLEN

Leveringstermijn 15 - 30 werkdagen
(zonder transportduur)

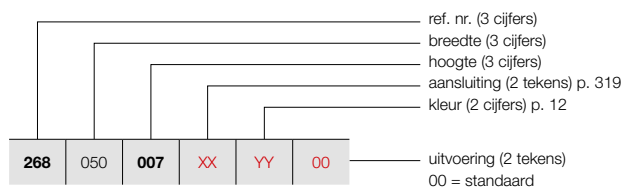

MUURBEVESTIGING / TELESCOPISCHE VOETEN /
KOLOMVOETEN

Zie p. 317 voor extra toebehoren.

ref. nr. (3 cijfers)
breedte (3 cijfers)
hoogte (3 cijfers)
aansluiting (2 tekens) p. 319
kleur (2 cijfers) p. 12

uitvoering (2 tekens)
00 = standaard
H0 = hogere werkdruk (10 bar)

PRIJSGROEP: VPG3 - PLINTRADIATOREN

BESTELCODE MAATWERK P1	TECHNISCHE GEGEVENS										STANDAARDKLEUR	ANDERE KLEUREN
	buizen	breedte (L mm)	hoogte (H mm)	75/65/20 (Watt) (φ50K)	55/45/20 (Watt) (φ30K)	n-exp.	gewicht (kg)	inhoud (l)	el. weerst. (Watt)		prijs RAL 9016 (€)	prijs kleur (€)
REF. NR. P1/230 : 268												
268 050 007 XX YY 00	-	500	70	523	258	1,38	6,90	1,20	-		672	773
268 060 007 XX YY 00	-	600	70	627	310	1,38	8,28	1,44	-		719	827
268 070 007 XX YY 00	-	700	70	732	362	1,38	9,66	1,68	-		761	875
268 080 007 XX YY 00	-	800	70	836	413	1,38	11,04	1,92	-		809	930
268 090 007 XX YY 00	-	900	70	941	465	1,38	12,42	2,16	-		854	982
268 100 007 XX YY 00	-	1000	70	1045	516	1,38	13,80	2,40	-		902	1037
268 110 007 XX YY 00	-	1100	70	1150	568	1,38	15,18	2,64	-		948	1090
268 120 007 XX YY 00	-	1200	70	1254	620	1,38	16,56	2,88	-		990	1139
268 140 007 XX YY 00	-	1400	70	1463	723	1,38	19,32	3,36	-		1082	1244
268 160 007 XX YY 00	-	1600	70	1672	826	1,38	22,08	3,84	-		1170	1346
268 180 007 XX YY 00	-	1800	70	1881	929	1,38	24,84	4,32	-		1261	1450
268 200 007 XX YY 00	-	2000	70	2090	1033	1,38	27,60	4,80	-		1355	1558
268 220 007 XX YY 00	-	2200	70	2299	1136	1,38	30,36	5,28	-		1444	1661
268 240 007 XX YY 00	-	2400	70	2508	1239	1,38	33,12	5,76	-		1533	1763
268 260 007 XX YY 00	-	2600	70	2717	1343	1,38	35,88	6,24	-		1626	1870
268 280 007 XX YY 00	-	2800	70	2926	1446	1,38	38,64	6,72	-		1716	1973
268 300 007 XX YY 00	-	3000	70	3135	1549	1,38	41,40	7,20	-		1806	2077
268 330 007 XX YY 00	-	3300	70	3449	1704	1,38	45,54	7,92	-		1944	2236
268 360 007 XX YY 00	-	3600	70	3762	1859	1,38	49,68	8,64	-		2077	2389
268 390 007 XX YY 00	-	3900	70	4076	2014	1,38	53,82	9,36	-		2213	2545

Conform EN442-1: 2014: radiatoren en convectoren

Voor meer details over onze artikel-data, zie artikel-database: <https://www.installdata.be>
Voor de warmteafgifte van andere regimes, kijkt u op p. 370 (correctiefactoren)
BELGIË. Prijzen in euro (excl. BTW)

HOE P1/280 BESTELLEN

Leveringstermijn 15 - 30 werkdagen
(zonder transportduur)

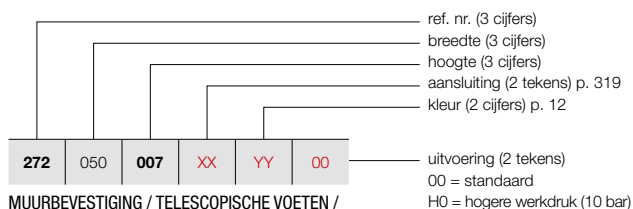

MUURBEVESTIGING / TELESCOPISCHE VOETEN /
KOLOMVOETEN

Zie p. 317 voor extra toebehoren.

PRIMULA P1 (P1/280)



P1

PRIJSGROEP: VPG3 - PLINTRADIATOREN

BESTELCODE MAATWERK P1	TECHNISCHE GEGEVENS											STANDAARDKLEUR	ANDERE KLEUREN			
	buizen	breedte (L mm)	hoogte (H mm)	75/65/20 (Watt) (Φ50K)	55/45/20 (Watt) (Φ30K)	n-exp.	gewicht (kg)	inhoud (l)	el. weerst. (Watt)	prijs RAL 9016 (€)	prijs kleur (€)					
REF. NR. P1/280 : 272																
272	050	007	XX	YY	00	-	500	70	630	315	1,36	8,00	1,40	-	826	950
272	060	007	XX	YY	00	-	600	70	756	377	1,36	9,60	1,68	-	879	1011
272	070	007	XX	YY	00	-	700	70	882	440	1,36	11,20	1,96	-	935	1075
272	080	007	XX	YY	00	-	800	70	1008	503	1,36	12,80	2,24	-	991	1140
272	090	007	XX	YY	00	-	900	70	1134	566	1,36	14,40	2,52	-	1048	1205
272	100	007	XX	YY	00	-	1000	70	1260	629	1,36	16,00	2,80	-	1105	1271
272	110	007	XX	YY	00	-	1100	70	1386	692	1,36	17,60	3,08	-	1158	1332
272	120	007	XX	YY	00	-	1200	70	1512	755	1,36	19,20	3,36	-	1215	1397
272	140	007	XX	YY	00	-	1400	70	1764	881	1,36	22,40	3,92	-	1326	1525
272	160	007	XX	YY	00	-	1600	70	2016	1006	1,36	25,60	4,48	-	1438	1654
272	180	007	XX	YY	00	-	1800	70	2268	1132	1,36	28,80	5,04	-	1549	1781
272	200	007	XX	YY	00	-	2000	70	2520	1258	1,36	32,00	5,60	-	1659	1908
272	220	007	XX	YY	00	-	2200	70	2772	1384	1,36	35,20	6,16	-	1771	2037
272	240	007	XX	YY	00	-	2400	70	3024	1510	1,36	38,40	6,72	-	1882	2164
272	260	007	XX	YY	00	-	2600	70	3276	1635	1,36	41,60	7,28	-	1993	2292
272	280	007	XX	YY	00	-	2800	70	3528	1761	1,36	44,80	7,84	-	2105	2421
272	300	007	XX	YY	00	-	3000	70	3780	1887	1,36	48,00	8,40	-	2214	2546
272	330	007	XX	YY	00	-	3300	70	4158	2076	1,36	52,80	9,24	-	2385	2743
272	360	007	XX	YY	00	-	3600	70	4536	2264	1,36	57,60	10,08	-	2551	2934
272	390	007	XX	YY	00	-	3900	70	4914	2453	1,36	62,40	10,92	-	2717	3125

Conform EN442-1: 2014: radiatoren en convectoren

Voor meer details over onze artikel-data, zie artikel-database: <https://www.installdata.be>
Voor de warmteafgiftes van andere regimes, kijkt u op p. 370 (correctiefactoren)
BELGIË. Prijzen in euro (excl. BTW)

PRIMULA P2 (P2/80)



P2

HOE P2/80 BESTELLEN

Leveringstermijn 15 - 30 werkdagen
(zonder transportduur)

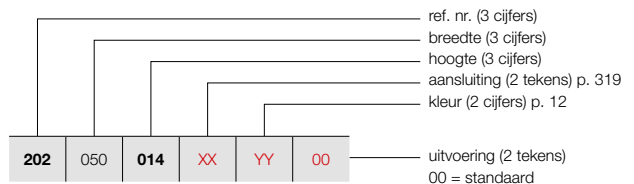

MUURBEVESTIGING / TELESCOPISCHE VOETEN /
KOLOMVOETEN

Zie p. 317 voor extra toebehoren.

PRIJSGROEP: VPG3 - PLINTRADIATOREN

BESTELCODE MAATWERK P2	TECHNISCHE GEGEVENS										STANDAARDKLEUR	ANDERE KLEUREN
	buizen	breedte (L mm)	hoogte (H mm)	75/65/20 (Watt) (φ50K)	55/45/20 (Watt) (φ30K)	n-exp.	gewicht (kg)	inhoud (l)	el. weerst. (Watt)		prijs RAL 9016 (€)	prijs kleur (€)
REF. NR. P2/80 : 202												
202 050 014 XX YY 00	-	500	140	304	153	1,35	5,73	1,46	-		350	403
202 060 014 XX YY 00	-	600	140	365	183	1,35	6,88	1,75	-		368	423
202 070 014 XX YY 00	-	700	140	426	214	1,35	8,02	2,04	-		394	453
202 080 014 XX YY 00	-	800	140	486	244	1,35	9,17	2,33	-		411	473
202 090 014 XX YY 00	-	900	140	547	274	1,35	10,31	2,62	-		433	498
202 100 014 XX YY 00	-	1000	140	608	305	1,35	11,46	2,91	-		454	522
202 110 014 XX YY 00	-	1100	140	669	336	1,35	12,61	3,20	-		474	545
202 120 014 XX YY 00	-	1200	140	730	366	1,35	13,75	3,49	-		496	570
202 140 014 XX YY 00	-	1400	140	851	427	1,35	16,04	4,07	-		535	615
202 160 014 XX YY 00	-	1600	140	973	488	1,35	18,34	4,66	-		578	665
202 180 014 XX YY 00	-	1800	140	1094	549	1,35	20,63	5,24	-		622	715
202 200 014 XX YY 00	-	2000	140	1216	610	1,35	22,92	5,82	-		664	764
202 220 014 XX YY 00	-	2200	140	1338	671	1,35	25,21	6,40	-		706	812
202 240 014 XX YY 00	-	2400	140	1459	732	1,35	27,50	6,98	-		748	860
202 260 014 XX YY 00	-	2600	140	1581	793	1,35	29,80	7,57	-		787	905
202 280 014 XX YY 00	-	2800	140	1702	854	1,35	32,09	8,15	-		830	955
202 300 014 XX YY 00	-	3000	140	1824	915	1,35	34,38	8,73	-		870	1001
202 330 014 XX YY 00	-	3300	140	2006	1007	1,35	37,82	9,60	-		930	1070
202 360 014 XX YY 00	-	3600	140	2189	1098	1,35	41,26	10,48	-		995	1144
202 390 014 XX YY 00	-	3900	140	2371	1190	1,35	44,69	11,35	-		1059	1218

Conform EN442-1: 2014: radiatoren en convectoren

Voor meer details over onze artikel-data, zie artikel-database: <https://www.installdata.be>

Voor de warmteafgiftes van andere regimes, kijkt u op p. 370 (correctiefactoren)
BELGIË. Prijzen in euro (excl. BTW)

HOE P2/130 BESTELLEN

Leveringstermijn 15 - 30 werkdagen
(zonder transportduur)

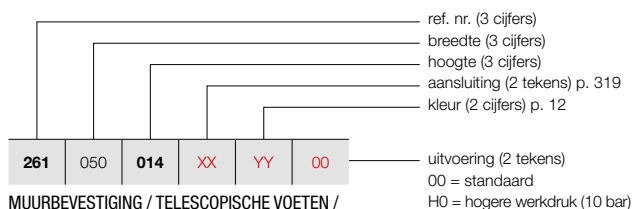

MUURBEVESTIGING / TELESCOPISCHE VOETEN /
KOLOMVOETEN

Zie p. 317 voor extra toebehoren.

PRIMULA P2 (P2/130)

303



P2

PRIJSGROEP: VPG3 - PLINTRADIATOREN

BESTELCODE MAATWERK P2	TECHNISCHE GEGEVENS											STANDAARDKLEUR	ANDERE KLEUREN			
	buizen	breedte (L mm)	hoogte (H mm)	75/65/20 (Watt) (Φ50K)	55/45/20 (Watt) (Φ30K)	n-exp.	gewicht (kg)	inhoud (l)	el. weerst. (Watt)	prijs RAL 9016 (€)	prijs kleur (€)					
REF. NR. P2/130 : 261																
261	050	014	XX	YY	00	-	500	140	442	221	1,36	7,77	1,87	-	452	520
261	060	014	XX	YY	00	-	600	140	530	265	1,36	9,32	2,24	-	490	564
261	070	014	XX	YY	00	-	700	140	619	309	1,36	10,87	2,61	-	527	606
261	080	014	XX	YY	00	-	800	140	707	353	1,36	12,42	2,98	-	567	652
261	090	014	XX	YY	00	-	900	140	796	397	1,36	13,98	3,36	-	606	697
261	100	014	XX	YY	00	-	1000	140	884	441	1,36	15,53	3,73	-	645	742
261	110	014	XX	YY	00	-	1100	140	972	485	1,36	17,08	4,10	-	678	780
261	120	014	XX	YY	00	-	1200	140	1061	530	1,36	18,64	4,48	-	719	827
261	140	014	XX	YY	00	-	1400	140	1238	618	1,36	21,74	5,22	-	796	915
261	160	014	XX	YY	00	-	1600	140	1414	706	1,36	24,85	5,97	-	869	999
261	180	014	XX	YY	00	-	1800	140	1591	794	1,36	27,95	6,71	-	946	1088
261	200	014	XX	YY	00	-	2000	140	1768	883	1,36	31,06	7,46	-	1021	1174
261	220	014	XX	YY	00	-	2200	140	1945	971	1,36	34,17	8,21	-	1094	1258
261	240	014	XX	YY	00	-	2400	140	2122	1059	1,36	37,27	8,95	-	1170	1346
261	260	014	XX	YY	00	-	2600	140	2298	1147	1,36	40,38	9,70	-	1247	1434
261	280	014	XX	YY	00	-	2800	140	2475	1236	1,36	43,48	10,44	-	1323	1521
261	300	014	XX	YY	00	-	3000	140	2652	1324	1,36	46,59	11,19	-	1397	1607
261	330	014	XX	YY	00	-	3300	140	2917	1456	1,36	51,25	12,31	-	1511	1738
261	360	014	XX	YY	00	-	3600	140	3182	1588	1,36	55,91	13,43	-	1627	1871
261	390	014	XX	YY	00	-	3900	140	3448	1721	1,36	60,57	14,55	-	1738	1999

Conform EN442-1: 2014: radiatoren en convectoren

Voor meer details over onze artikel-data, zie artikel-database: <https://www.installdata.be>
Voor de warmteafgiftes van andere regimes, kijkt u op p. 370 (correctiefactoren)
BELGIË. Prijzen in euro (excl. BTW)

PRIMULA P2 (P2/180)



P2

HOE P2/180 BESTELLEN

Leveringstermijn 15 - 30 werkdagen
(zonder transportduur)

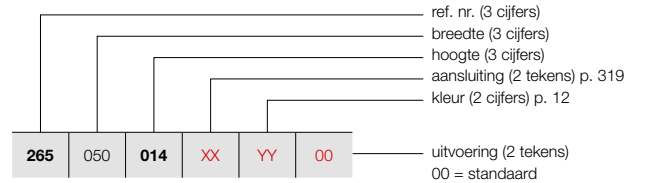

MUURBEVESTIGING / TELESCOPISCHE VOETEN / KOLOMVOETEN

Zie p. 317 voor extra toebehoren.

PRIJSGROEP: VPG3 - PLINTRADIATOREN

BESTELCODE MAATWERK P2	TECHNISCHE GEGEVENS										STANDAARDKLEUR	ANDERE KLEUREN				
	buizen	breedte (L mm)	hoogte (H mm)	75/65/20 (Watt) (φ50K)	55/45/20 (Watt) (φ30K)	n-exp.	gewicht (kg)	inhoud (l)	el. weerst. (Watt)		prijs RAL 9016 (€)	prijs kleur (€)				
REF. NR. P2/180 : 265																
265	050	014	XX	YY	00	-	500	140	611	305	1,36	9,90	2,23	-	597	687
265	060	014	XX	YY	00	-	600	140	733	366	1,36	11,88	2,67	-	651	749
265	070	014	XX	YY	00	-	700	140	855	427	1,36	13,86	3,12	-	706	812
265	080	014	XX	YY	00	-	800	140	977	488	1,36	15,84	3,56	-	758	872
265	090	014	XX	YY	00	-	900	140	1099	549	1,36	17,82	4,01	-	814	936
265	100	014	XX	YY	00	-	1000	140	1221	610	1,36	19,80	4,45	-	867	997
265	110	014	XX	YY	00	-	1100	140	1343	670	1,36	21,78	4,90	-	921	1059
265	120	014	XX	YY	00	-	1200	140	1465	731	1,36	23,76	5,34	-	975	1121
265	140	014	XX	YY	00	-	1400	140	1709	853	1,36	27,72	6,23	-	1083	1245
265	160	014	XX	YY	00	-	1600	140	1954	975	1,36	31,68	7,12	-	1192	1371
265	180	014	XX	YY	00	-	1800	140	2198	1097	1,36	35,64	8,01	-	1301	1496
265	200	014	XX	YY	00	-	2000	140	2442	1219	1,36	39,60	8,90	-	1407	1618
265	220	014	XX	YY	00	-	2200	140	2686	1341	1,36	43,56	9,79	-	1519	1747
265	240	014	XX	YY	00	-	2400	140	2930	1463	1,36	47,52	10,68	-	1626	1870
265	260	014	XX	YY	00	-	2600	140	3175	1585	1,36	51,48	11,57	-	1731	1991
265	280	014	XX	YY	00	-	2800	140	3419	1707	1,36	55,44	12,46	-	1839	2115
265	300	014	XX	YY	00	-	3000	140	3663	1829	1,36	59,40	13,35	-	1948	2240
265	330	014	XX	YY	00	-	3300	140	4029	2011	1,36	65,34	14,69	-	2110	2427
265	360	014	XX	YY	00	-	3600	140	4396	2195	1,36	71,28	16,02	-	2275	2616
265	390	014	XX	YY	00	-	3900	140	4762	2377	1,36	77,22	17,36	-	2434	2799

Conform EN442-1: 2014: radiatoren en convectoren

Voor meer details over onze artikel-data, zie artikel-database: <https://www.installdata.be>

Voor de warmteafgifte van andere regimes, kijkt u op p. 370 (correctiefactoren)
BELGIË. Prijzen in euro (excl. BTW)

HOE P2/230 BESTELLEN

Leveringstermijn 15 - 30 werkdagen
(zonder transportduur)

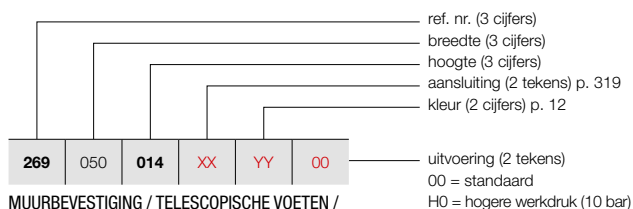

MUURBEVESTIGING / TELESCOPISCHE VOETEN /
KOLOMVOETEN

Zie p. 317 voor extra toebehoren.

PRIMULA P2 (P2/230)

305



P2

PRIJSGROEP: VPG3 - PLINTRADIATOREN

BESTELCODE MAATWERK P2	TECHNISCHE GEGEVENS										STANDAARDKLEUR	ANDERE KLEUREN				
	buizen	breedte (L mm)	hoogte (H mm)	75/65/20 (Watt) (Φ50K)	55/45/20 (Watt) (Φ30K)	n-exp.	gewicht (kg)	inhoud (l)	el. weerst. (Watt)		prijs RAL 9016 (€)	prijs kleur (€)				
REF. NR. P2/230 : 269																
269	050	014	XX	YY	00	-	500	140	756	375	1,37	11,88	2,73	-	766	881
269	060	014	XX	YY	00	-	600	140	907	450	1,37	14,25	3,27	-	842	968
269	070	014	XX	YY	00	-	700	140	1058	525	1,37	16,63	3,82	-	916	1053
269	080	014	XX	YY	00	-	800	140	1209	600	1,37	19,00	4,36	-	991	1140
269	090	014	XX	YY	00	-	900	140	1360	675	1,37	21,38	4,91	-	1068	1228
269	100	014	XX	YY	00	-	1000	140	1511	750	1,37	23,75	5,45	-	1143	1314
269	110	014	XX	YY	00	-	1100	140	1662	825	1,37	26,13	6,00	-	1216	1398
269	120	014	XX	YY	00	-	1200	140	1813	900	1,37	28,50	6,54	-	1293	1487
269	140	014	XX	YY	00	-	1400	140	2115	1050	1,37	33,25	7,63	-	1440	1656
269	160	014	XX	YY	00	-	1600	140	2418	1201	1,37	38,00	8,72	-	1589	1827
269	180	014	XX	YY	00	-	1800	140	2720	1351	1,37	42,75	9,81	-	1741	2002
269	200	014	XX	YY	00	-	2000	140	3022	1501	1,37	47,50	10,90	-	1888	2171
269	220	014	XX	YY	00	-	2200	140	3324	1651	1,37	52,25	11,99	-	2041	2347
269	240	014	XX	YY	00	-	2400	140	3626	1801	1,37	57,00	13,08	-	2191	2520
269	260	014	XX	YY	00	-	2600	140	3929	1951	1,37	61,75	14,17	-	2341	2692
269	280	014	XX	YY	00	-	2800	140	4231	2101	1,37	66,50	15,26	-	2489	2862
269	300	014	XX	YY	00	-	3000	140	4533	2251	1,37	71,25	16,35	-	2639	3035
269	330	014	XX	YY	00	-	3300	140	4986	2476	1,37	78,38	17,99	-	2861	3290
269	360	014	XX	YY	00	-	3600	140	5440	2702	1,37	85,50	19,62	-	3083	3545
269	390	014	XX	YY	00	-	3900	140	5893	2927	1,37	92,63	21,26	-	3312	3809

Conform EN442-1: 2014: radiatoren en convectoren

Voor meer details over onze artikel-data, zie artikel-database: <https://www.installdata.be>
Voor de warmteafgiftes van andere regimes, kijkt u op p. 370 (correctiefactoren)
BELGIË. Prijzen in euro (excl. BTW)

PRIMULA P2 (P2/280)



P2

HOE P2/280 BESTELLEN

Leveringstermijn 15 - 30 werkdagen
(zonder transportduur)

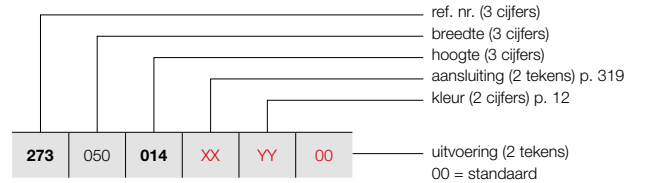

MUURBEVESTIGING / TELESCOPISCHE VOETEN /
KOLOMVOETEN

Zie p. 317 voor extra toebehoren.

PRIJSGROEP: VPG3 - PLINTRADIATOREN

BESTELCODE MAATWERK P2	TECHNISCHE GEGEVENS										STANDAARDKLEUR	ANDERE KLEUREN				
	buizen	breedte (L mm)	hoogte (H mm)	75/65/20 (Watt) (φ50K)	55/45/20 (Watt) (φ30K)	n-exp.	gewicht (kg)	inhoud (l)	el. weerst. (Watt)		prijs RAL 9016 (€)	prijs kleur (€)				
REF. NR. P2/280 : 273																
273	050	014	XX	YY	00	-	500	140	953	473	1,37	13,85	2,98	-	943	1084
273	060	014	XX	YY	00	-	600	140	1143	568	1,37	16,62	3,57	-	1036	1191
273	070	014	XX	YY	00	-	700	140	1334	663	1,37	19,39	4,17	-	1128	1297
273	080	014	XX	YY	00	-	800	140	1524	757	1,37	22,16	4,76	-	1217	1400
273	090	014	XX	YY	00	-	900	140	1715	852	1,37	24,93	5,36	-	1311	1508
273	100	014	XX	YY	00	-	1000	140	1905	946	1,37	27,70	5,95	-	1402	1612
273	110	014	XX	YY	00	-	1100	140	2096	1041	1,37	30,47	6,55	-	1491	1715
273	120	014	XX	YY	00	-	1200	140	2286	1135	1,37	33,24	7,14	-	1585	1823
273	140	014	XX	YY	00	-	1400	140	2667	1325	1,37	38,78	8,33	-	1769	2034
273	160	014	XX	YY	00	-	1600	140	3048	1514	1,37	44,32	9,52	-	1950	2243
273	180	014	XX	YY	00	-	1800	140	3429	1703	1,37	49,86	10,71	-	2135	2455
273	200	014	XX	YY	00	-	2000	140	3810	1892	1,37	55,40	11,90	-	2319	2667
273	220	014	XX	YY	00	-	2200	140	4191	2082	1,37	60,94	13,09	-	2503	2878
273	240	014	XX	YY	00	-	2400	140	4572	2271	1,37	66,48	14,28	-	2684	3087
273	260	014	XX	YY	00	-	2600	140	4953	2460	1,37	72,02	15,47	-	2871	3302
273	280	014	XX	YY	00	-	2800	140	5334	2649	1,37	77,56	16,66	-	3052	3510
273	300	014	XX	YY	00	-	3000	140	5715	2838	1,37	83,10	17,85	-	3240	3726
273	330	014	XX	YY	00	-	3300	140	6287	3123	1,37	91,41	19,64	-	3512	4039
273	360	014	XX	YY	00	-	3600	140	6858	3406	1,37	99,72	21,42	-	3787	4355
273	390	014	XX	YY	00	-	3900	140	7430	3690	1,37	108,03	23,21	-	4065	4675

Conform EN442-1: 2014: radiatoren en convectoren

Voor meer details over onze artikel-data, zie artikel-database: <https://www.installdata.be>

Voor de warmteafgifte van andere regimes, kijkt u op p. 370 (correctiefactoren)
BELGIË. Prijzen in euro (excl. BTW)

HOE P3/80 BESTELLEN

Leveringstermijn 15 - 30 werkdagen
(zonder transportduur)

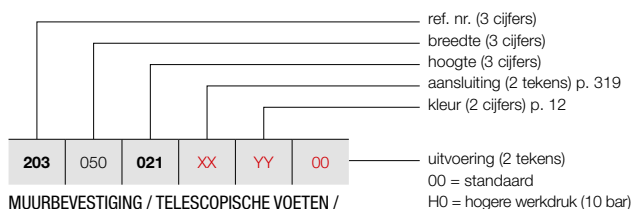

MUURBEVESTIGING / TELESCOPISCHE VOETEN /
KOLOMVOETEN

Zie p. 317 voor extra toebehoren.

PRIMULA P3 (P3/80)

307



P3

PRIJSGROEP: VPG3 - PLINTRADIATOREN

BESTELCODE MAATWERK P3	TECHNISCHE GEGEVENS										STANDAARDKLEUR	ANDERE KLEUREN				
	buizen	breedte (L mm)	hoogte (H mm)	75/65/20 (Watt) (Φ50K)	55/45/20 (Watt) (Φ30K)	n-exp.	gewicht (kg)	inhoud (l)	el. weerst. (Watt)	prijs RAL 9016 (€)	prijs kleur (€)					
REF. NR. P3/80 : 203																
203	050	021	XX	YY	00	-	500	210	378	190	1,35	8,40	2,25	-	498	573
203	060	021	XX	YY	00	-	600	210	454	228	1,35	10,08	2,70	-	521	599
203	070	021	XX	YY	00	-	700	210	529	265	1,35	11,76	3,15	-	556	639
203	080	021	XX	YY	00	-	800	210	605	304	1,35	13,44	3,60	-	577	664
203	090	021	XX	YY	00	-	900	210	680	341	1,35	15,12	4,05	-	605	696
203	100	021	XX	YY	00	-	1000	210	756	379	1,35	16,80	4,50	-	628	722
203	110	021	XX	YY	00	-	1100	210	832	417	1,35	18,48	4,95	-	654	752
203	120	021	XX	YY	00	-	1200	210	907	455	1,35	20,16	5,40	-	681	783
203	140	021	XX	YY	00	-	1400	210	1058	531	1,35	23,52	6,30	-	734	844
203	160	021	XX	YY	00	-	1600	210	1210	607	1,35	26,88	7,20	-	787	905
203	180	021	XX	YY	00	-	1800	210	1361	683	1,35	30,24	8,10	-	837	963
203	200	021	XX	YY	00	-	2000	210	1512	759	1,35	33,60	9,00	-	891	1025
203	220	021	XX	YY	00	-	2200	210	1663	834	1,35	36,96	9,90	-	943	1084
203	240	021	XX	YY	00	-	2400	210	1814	910	1,35	40,32	10,80	-	994	1143
203	260	021	XX	YY	00	-	2600	210	1966	986	1,35	43,68	11,70	-	1047	1204
203	280	021	XX	YY	00	-	2800	210	2117	1062	1,35	47,04	12,60	-	1095	1259
203	300	021	XX	YY	00	-	3000	210	2268	1138	1,35	50,40	13,50	-	1151	1324
203	330	021	XX	YY	00	-	3300	210	2495	1252	1,35	55,44	14,85	-	1230	1415
203	360	021	XX	YY	00	-	3600	210	2722	1366	1,35	60,48	16,20	-	1309	1505
203	390	021	XX	YY	00	-	3900	210	2948	1479	1,35	65,52	17,55	-	1387	1595

Conform EN442-1: 2014: radiatoren en convectoren

Voor meer details over onze artikel-data, zie artikel-database: <https://www.installdata.be>
Voor de warmteafgiftes van andere regimes, kijkt u op p. 370 (correctiefactoren)
BELGIË. Prijzen in euro (excl. BTW)

PRIMULA P3 (P3/130)



P3

HOE P3/130 BESTELLEN

Leveringstermijn 15 - 30 werkdagen
(zonder transportduur)

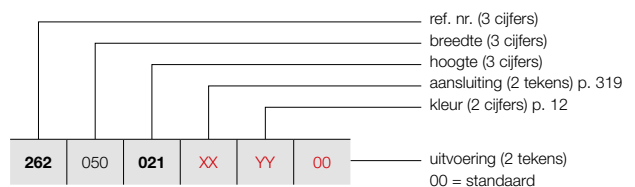

MUURBEVESTIGING / TELESCOPISCHE VOETEN / KOLOMVOETEN

Zie p. 317 voor extra toebehoren.

PRIJSGROEP: VPG3 - PLINTRADIATOREN

BESTELCODE MAATWERK P3	TECHNISCHE GEGEVENS										STANDAARDKLEUR	ANDERE KLEUREN				
	buizen	breedte (L mm)	hoogte (H mm)	75/65/20 (Watt) (φ50K)	55/45/20 (Watt) (φ30K)	n-exp.	gewicht (kg)	inhoud (l)	el. weerst. (Watt)		prijs RAL 9016 (€)	prijs kleur (€)				
REF. NR. P3/130 : 262																
262	050	021	XX	YY	00	-	500	210	560	281	1,35	11,20	2,85	-	602	692
262	060	021	XX	YY	00	-	600	210	672	337	1,35	13,44	3,42	-	643	739
262	070	021	XX	YY	00	-	700	210	784	393	1,35	15,68	3,99	-	683	785
262	080	021	XX	YY	00	-	800	210	896	450	1,35	17,92	4,56	-	725	834
262	090	021	XX	YY	00	-	900	210	1008	506	1,35	20,16	5,13	-	766	881
262	100	021	XX	YY	00	-	1000	210	1120	562	1,35	22,40	5,70	-	810	932
262	110	021	XX	YY	00	-	1100	210	1232	618	1,35	24,64	6,27	-	852	980
262	120	021	XX	YY	00	-	1200	210	1344	674	1,35	26,88	6,84	-	895	1029
262	140	021	XX	YY	00	-	1400	210	1568	787	1,35	31,36	7,98	-	977	1124
262	160	021	XX	YY	00	-	1600	210	1792	899	1,35	35,84	9,12	-	1066	1226
262	180	021	XX	YY	00	-	1800	210	2016	1012	1,35	40,32	10,26	-	1148	1320
262	200	021	XX	YY	00	-	2000	210	2240	1124	1,35	44,80	11,40	-	1233	1418
262	220	021	XX	YY	00	-	2200	210	2464	1236	1,35	49,28	12,54	-	1319	1517
262	240	021	XX	YY	00	-	2400	210	2688	1349	1,35	53,76	13,68	-	1402	1612
262	260	021	XX	YY	00	-	2600	210	2912	1461	1,35	58,24	14,82	-	1485	1708
262	280	021	XX	YY	00	-	2800	210	3136	1574	1,35	62,72	15,96	-	1569	1804
262	300	021	XX	YY	00	-	3000	210	3360	1686	1,35	67,20	17,10	-	1655	1903
262	330	021	XX	YY	00	-	3300	210	3696	1855	1,35	73,92	18,81	-	1782	2049
262	360	021	XX	YY	00	-	3600	210	4032	2023	1,35	80,64	20,52	-	1907	2193
262	390	021	XX	YY	00	-	3900	210	4368	2192	1,35	87,36	22,23	-	2036	2341

Conform EN442-1: 2014: radiatoren en convectoren

Voor meer details over onze artikel-data, zie artikel-database: <https://www.installdata.be>
Voor de warmteafgifte van andere regimes, kijkt u op p. 370 (correctiefactoren)
BELGIË. Prijzen in euro (excl. BTW)

HOE P3/180 BESTELLEN

Leveringstermijn 15 - 30 werkdagen
(zonder transportduur)

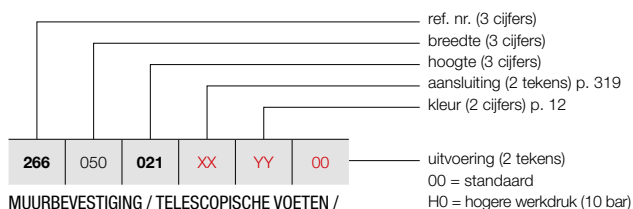

MUURBEVESTIGING / TELESCOPISCHE VOETEN /
KOLOMVOETEN

Zie p. 317 voor extra toebehoren.

PRIMULA P3 (P3/180)

309



P3

PRIJSGROEP: VPG3 - PLINTRADIATOREN

BESTELCODE MAATWERK P3	TECHNISCHE GEGEVENS											STANDAARDKLEUR	ANDERE KLEUREN			
	buizen	breedte (L mm)	hoogte (H mm)	75/65/20 (Watt) (Φ50K)	55/45/20 (Watt) (Φ30K)	n-exp.	gewicht (kg)	inhoud (l)	el. weerst. (Watt)	prijs RAL 9016 (€)	prijs kleur (€)					
REF. NR. P3/180 : 266																
266	050	021	XX	YY	00	-	500	210	771	381	1,38	14,10	3,40	-	767	882
266	060	021	XX	YY	00	-	600	210	925	457	1,38	16,92	4,08	-	830	955
266	070	021	XX	YY	00	-	700	210	1079	533	1,38	19,74	4,76	-	891	1025
266	080	021	XX	YY	00	-	800	210	1233	609	1,38	22,56	5,44	-	950	1093
266	090	021	XX	YY	00	-	900	210	1387	685	1,38	25,38	6,12	-	1008	1159
266	100	021	XX	YY	00	-	1000	210	1541	761	1,38	28,20	6,80	-	1069	1229
266	110	021	XX	YY	00	-	1100	210	1695	838	1,38	31,02	7,48	-	1131	1301
266	120	021	XX	YY	00	-	1200	210	1849	914	1,38	33,84	8,16	-	1189	1367
266	140	021	XX	YY	00	-	1400	210	2157	1066	1,38	39,48	9,52	-	1309	1505
266	160	021	XX	YY	00	-	1600	210	2466	1219	1,38	45,12	10,88	-	1431	1646
266	180	021	XX	YY	00	-	1800	210	2774	1371	1,38	50,76	12,24	-	1548	1780
266	200	021	XX	YY	00	-	2000	210	3082	1523	1,38	56,40	13,60	-	1669	1919
266	220	021	XX	YY	00	-	2200	210	3390	1675	1,38	62,04	14,96	-	1787	2055
266	240	021	XX	YY	00	-	2400	210	3698	1827	1,38	67,68	16,32	-	1905	2191
266	260	021	XX	YY	00	-	2600	210	4007	1980	1,38	73,32	17,68	-	2026	2330
266	280	021	XX	YY	00	-	2800	210	4315	2132	1,38	78,96	19,04	-	2146	2468
266	300	021	XX	YY	00	-	3000	210	4623	2284	1,38	84,60	20,40	-	2266	2606
266	330	021	XX	YY	00	-	3300	210	5085	2513	1,38	93,06	22,44	-	2445	2812
266	360	021	XX	YY	00	-	3600	210	5548	2741	1,38	101,52	24,48	-	2625	3019
266	390	021	XX	YY	00	-	3900	210	6010	2970	1,38	109,98	26,52	-	2805	3226

Conform EN442-1: 2014: radiatoren en convectoren

Voor meer details over onze artikel-data, zie artikel-database: <https://www.installdata.be>
Voor de warmteafgiftes van andere regimes, kijkt u op p. 370 (correctiefactoren)
BELGIË. Prijzen in euro (excl. BTW)

PRIMULA P3 (P3/230)



P3

HOE P3/230 BESTELLEN

Leveringstermijn 15 - 30 werkdagen
(zonder transportduur)

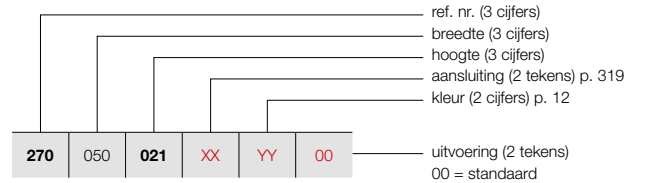

MUURBEVESTIGING / TELESCOPISCHE VOETEN /
KOLOMVOETEN

Zie p. 317 voor extra toebehoren.

PRIJSGROEP: VPG3 - PLINTRADIATOREN

BESTELCODE MAATWERK P3	TECHNISCHE GEGEVENS										STANDAARDKLEUR	ANDERE KLEUREN				
	buizen	breedte (L mm)	hoogte (H mm)	75/65/20 (Watt) (φ50K)	55/45/20 (Watt) (φ30K)	n-exp.	gewicht (kg)	inhoud (l)	el. weerst. (Watt)		prijs RAL 9016 (€)	prijs kleur (€)				
REF. NR. P3/230 : 270																
270	050	021	XX	YY	00	-	500	210	950	472	1,37	16,85	4,25	-	943	1084
270	060	021	XX	YY	00	-	600	210	1140	566	1,37	20,22	5,10	-	1021	1174
270	070	021	XX	YY	00	-	700	210	1330	661	1,37	23,59	5,95	-	1095	1259
270	080	021	XX	YY	00	-	800	210	1520	755	1,37	26,96	6,80	-	1178	1355
270	090	021	XX	YY	00	-	900	210	1710	849	1,37	30,33	7,65	-	1254	1442
270	100	021	XX	YY	00	-	1000	210	1900	944	1,37	33,70	8,50	-	1332	1532
270	110	021	XX	YY	00	-	1100	210	2090	1038	1,37	37,07	9,35	-	1410	1622
270	120	021	XX	YY	00	-	1200	210	2280	1132	1,37	40,44	10,20	-	1489	1712
270	140	021	XX	YY	00	-	1400	210	2660	1321	1,37	47,18	11,90	-	1647	1894
270	160	021	XX	YY	00	-	1600	210	3040	1510	1,37	53,92	13,60	-	1804	2075
270	180	021	XX	YY	00	-	1800	210	3420	1699	1,37	60,66	15,30	-	1959	2253
270	200	021	XX	YY	00	-	2000	210	3800	1887	1,37	67,40	17,00	-	2115	2432
270	220	021	XX	YY	00	-	2200	210	4180	2076	1,37	74,14	18,70	-	2273	2614
270	240	021	XX	YY	00	-	2400	210	4560	2265	1,37	80,88	20,40	-	2429	2793
270	260	021	XX	YY	00	-	2600	210	4940	2454	1,37	87,62	22,10	-	2586	2974
270	280	021	XX	YY	00	-	2800	210	5320	2642	1,37	94,36	23,80	-	2742	3153
270	300	021	XX	YY	00	-	3000	210	5700	2831	1,37	101,10	25,50	-	2901	3336
270	330	021	XX	YY	00	-	3300	210	6270	3114	1,37	111,21	28,05	-	3132	3602
270	360	021	XX	YY	00	-	3600	210	6840	3397	1,37	121,32	30,60	-	3365	3870
270	390	021	XX	YY	00	-	3900	210	7410	3680	1,37	131,43	33,15	-	3600	4140

Conform EN442-1: 2014: radiatoren en convectoren

Voor meer details over onze artikel-data, zie artikel-database: <https://www.installdata.be>

Voor de warmteafgiftes van andere regimes, kijkt u op p. 370 (correctiefactoren)
BELGIË. Prijzen in euro (excl. BTW)

HOE P3/280 BESTELLEN

Leveringstermijn 15 - 30 werkdagen
(zonder transportduur)

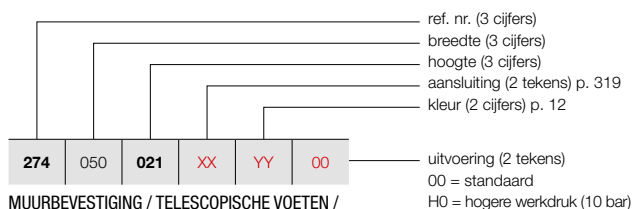

MUURBEVESTIGING / TELESCOPISCHE VOETEN /
KOLOMVOETEN

Zie p. 317 voor extra toebehoren.

PRIMULA P3 (P3/280)

311



P3

PRIJSGROEP: VPG3 - PLINTRADIATOREN

BESTELCODE MAATWERK P3	TECHNISCHE GEGEVENS											STANDAARDKLEUR	ANDERE KLEUREN			
	buizen	breedte (L mm)	hoogte (H mm)	75/65/20 (Watt) (Φ50K)	55/45/20 (Watt) (Φ30K)	n-exp.	gewicht (kg)	inhoud (l)	el. weerst. (Watt)	prijs RAL 9016 (€)	prijs kleur (€)					
REF. NR. P3/280 : 274																
274	050	021	XX	YY	00	-	500	210	1176	581	1,38	19,70	4,55	-	1116	1283
274	060	021	XX	YY	00	-	600	210	1411	697	1,38	23,64	5,46	-	1211	1393
274	070	021	XX	YY	00	-	700	210	1646	813	1,38	27,58	6,37	-	1302	1497
274	080	021	XX	YY	00	-	800	210	1881	929	1,38	31,52	7,28	-	1395	1604
274	090	021	XX	YY	00	-	900	210	2116	1046	1,38	35,46	8,19	-	1486	1709
274	100	021	XX	YY	00	-	1000	210	2351	1162	1,38	39,40	9,10	-	1583	1820
274	110	021	XX	YY	00	-	1100	210	2586	1278	1,38	43,34	10,01	-	1674	1925
274	120	021	XX	YY	00	-	1200	210	2821	1394	1,38	47,28	10,92	-	1765	2030
274	140	021	XX	YY	00	-	1400	210	3291	1626	1,38	55,16	12,74	-	1950	2243
274	160	021	XX	YY	00	-	1600	210	3762	1859	1,38	63,04	14,56	-	2137	2458
274	180	021	XX	YY	00	-	1800	210	4232	2091	1,38	70,92	16,38	-	2324	2673
274	200	021	XX	YY	00	-	2000	210	4702	2323	1,38	78,80	18,20	-	2510	2887
274	220	021	XX	YY	00	-	2200	210	5172	2556	1,38	86,68	20,02	-	2693	3097
274	240	021	XX	YY	00	-	2400	210	5642	2788	1,38	94,56	21,84	-	2881	3313
274	260	021	XX	YY	00	-	2600	210	6113	3021	1,38	102,44	23,66	-	3068	3528
274	280	021	XX	YY	00	-	2800	210	6583	3253	1,38	110,32	25,48	-	3250	3738
274	300	021	XX	YY	00	-	3000	210	7053	3485	1,38	118,20	27,30	-	3435	3950
274	330	021	XX	YY	00	-	3300	210	7758	3834	1,38	130,02	30,03	-	3718	4276
274	360	021	XX	YY	00	-	3600	210	8464	4182	1,38	141,84	32,76	-	3994	4593

Conform EN442-1: 2014: radiatoren en convectoren

Voor meer details over onze artikel-data, zie artikel-database: <https://www.installdata.be>
Voor de warmteafgiftes van andere regimes, kijkt u op p. 370 (correctiefactoren)
BELGIË. Prijzen in euro (excl. BTW)

PRIMULA P4 (P4/80)



P4

HOE P4/80 BESTELLEN

Leveringstermijn 15 - 30 werkdagen
(zonder transportduur)

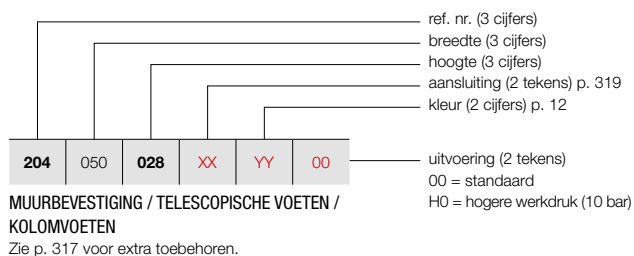

PRIJSGROEP: VPG3 - PLINTRADIATOREN

BESTELCODE MAATWERK P4	TECHNISCHE GEGEVENS										STANDAARDKLEUR	ANDERE KLEUREN
	buizen	breedte (L mm)	hoogte (H mm)	75/65/20 (Watt) (φ50K)	55/45/20 (Watt) (φ30K)	n-exp.	gewicht (kg)	inhoud (l)	el. weerst. (Watt)	prijs RAL 9016 (€)	prijs kleur (€)	
REF. NR. P4/80 : 204												
204 050 028 XX YY 00	-	500	280	435	219	1,34	11,07	3,05	-	630	725	
204 060 028 XX YY 00	-	600	280	522	263	1,34	13,28	3,65	-	667	767	
204 070 028 XX YY 00	-	700	280	609	307	1,34	15,50	4,26	-	701	806	
204 080 028 XX YY 00	-	800	280	696	351	1,34	17,71	4,87	-	736	846	
204 090 028 XX YY 00	-	900	280	783	395	1,34	19,93	5,48	-	770	886	
204 100 028 XX YY 00	-	1000	280	870	439	1,34	22,14	6,09	-	808	929	
204 110 028 XX YY 00	-	1100	280	957	483	1,34	24,35	6,70	-	841	967	
204 120 028 XX YY 00	-	1200	280	1044	527	1,34	26,57	7,31	-	877	1009	
204 140 028 XX YY 00	-	1400	280	1218	614	1,34	31,00	8,53	-	949	1091	
204 160 028 XX YY 00	-	1600	280	1392	702	1,34	35,42	9,74	-	1016	1168	
204 180 028 XX YY 00	-	1800	280	1566	790	1,34	39,85	10,96	-	1086	1249	
204 200 028 XX YY 00	-	2000	280	1740	878	1,34	44,28	12,18	-	1156	1329	
204 220 028 XX YY 00	-	2200	280	1914	965	1,34	48,71	13,40	-	1228	1412	
204 240 028 XX YY 00	-	2400	280	2088	1053	1,34	53,14	14,62	-	1298	1493	
204 260 028 XX YY 00	-	2600	280	2262	1141	1,34	57,56	15,83	-	1367	1572	
204 280 028 XX YY 00	-	2800	280	2436	1229	1,34	61,99	17,05	-	1438	1654	
204 300 028 XX YY 00	-	3000	280	2610	1316	1,34	66,42	18,27	-	1506	1732	
204 330 028 XX YY 00	-	3300	280	2871	1448	1,34	73,06	20,10	-	1613	1855	
204 360 028 XX YY 00	-	3600	280	3132	1580	1,34	79,70	21,92	-	1720	1978	
204 390 028 XX YY 00	-	3900	280	3393	1711	1,34	86,35	23,75	-	1825	2099	

Conform EN442-1: 2014: radiatoren en convectoren

Voor meer details over onze artikel-data, zie artikel-database: <https://www.installdata.be>
Voor de warmteafgiftes van andere regimes, kijkt u op p. 370 (correctiefactoren)
BELGIË. Prijzen in euro (excl. BTW)

HOE P4/130 BESTELLEN

Leveringstermijn 15 - 30 werkdagen
(zonder transportduur)

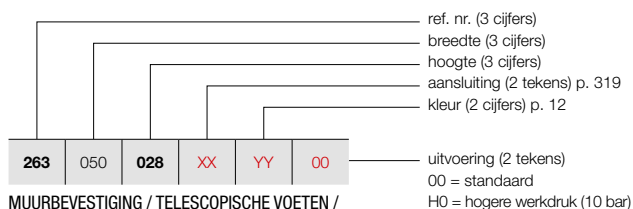

MUURBEVESTIGING / TELESCOPISCHE VOETEN /
KOLOMVOETEN

Zie p. 317 voor extra toebehoren.

PRIMULA P4 (P4/130)

313



P4

PRIJSGROEP: VPG3 - PLINTRADIATOREN

BESTELCODE MAATWERK P4	TECHNISCHE GEGEVENS											STANDAARDKLEUR	ANDERE KLEUREN			
	buizen	breedte (L mm)	hoogte (H mm)	75/65/20 (Watt) (Φ50K)	55/45/20 (Watt) (Φ30K)	n-exp.	gewicht (kg)	inhoud (l)	el. weerst. (Watt)	prijs RAL 9016 (€)	prijs kleur (€)					
REF. NR. P4/130 : 263																
263	050	028	XX	YY	00	-	500	280	678	333	1,39	14,64	3,84	-	706	812
263	060	028	XX	YY	00	-	600	280	813	400	1,39	17,57	4,61	-	758	872
263	070	028	XX	YY	00	-	700	280	949	467	1,39	20,50	5,38	-	814	936
263	080	028	XX	YY	00	-	800	280	1084	533	1,39	23,42	6,14	-	867	997
263	090	028	XX	YY	00	-	900	280	1220	600	1,39	26,35	6,91	-	921	1059
263	100	028	XX	YY	00	-	1000	280	1355	666	1,39	29,28	7,68	-	976	1122
263	110	028	XX	YY	00	-	1100	280	1491	733	1,39	32,21	8,45	-	1030	1185
263	120	028	XX	YY	00	-	1200	280	1626	799	1,39	35,14	9,22	-	1084	1247
263	140	028	XX	YY	00	-	1400	280	1897	933	1,39	40,99	10,75	-	1193	1372
263	160	028	XX	YY	00	-	1600	280	2168	1066	1,39	46,85	12,29	-	1302	1497
263	180	028	XX	YY	00	-	1800	280	2439	1199	1,39	52,70	13,82	-	1410	1622
263	200	028	XX	YY	00	-	2000	280	2710	1332	1,39	58,56	15,36	-	1523	1751
263	220	028	XX	YY	00	-	2200	280	2981	1466	1,39	64,42	16,90	-	1631	1876
263	240	028	XX	YY	00	-	2400	280	3252	1599	1,39	70,27	18,43	-	1737	1998
263	260	028	XX	YY	00	-	2600	280	3523	1732	1,39	76,13	19,97	-	1848	2125
263	280	028	XX	YY	00	-	2800	280	3794	1865	1,39	81,98	21,50	-	1956	2249
263	300	028	XX	YY	00	-	3000	280	4065	1998	1,39	87,84	23,04	-	2063	2372
263	330	028	XX	YY	00	-	3300	280	4472	2199	1,39	96,62	25,34	-	2231	2566
263	360	028	XX	YY	00	-	3600	280	4878	2398	1,39	105,41	27,65	-	2391	2750
263	390	028	XX	YY	00	-	3900	280	5285	2598	1,39	114,19	29,95	-	2554	2937

Conform EN442-1: 2014: radiatoren en convectoren

Voor meer details over onze artikel-data, zie artikel-database: <https://www.installdata.be>
Voor de warmteafgiftes van andere regimes, kijkt u op p. 370 (correctiefactoren)
BELGIË. Prijzen in euro (excl. BTW)

PRIMULA P4 (P4/180)



P4

HOE P4/180 BESTELLEN

Leveringstermijn 15 - 30 werkdagen
(zonder transportduur)

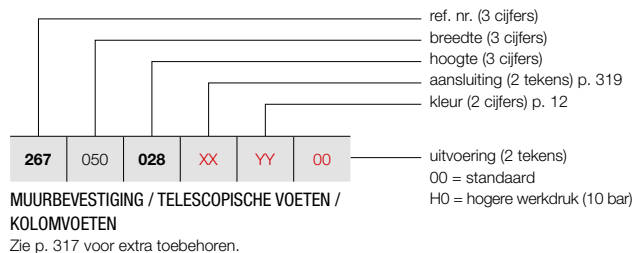

PRIJSGROEP: VPG3 - PLINTRADIATOREN

BESTELCODE MAATWERK P4	TECHNISCHE GEGEVENS										STANDAARDKLEUR	ANDERE KLEUREN				
	buizen	breedte (L mm)	hoogte (H mm)	75/65/20 (Watt) (φ50K)	55/45/20 (Watt) (φ30K)	n-exp.	gewicht (kg)	inhoud (l)	el. weerst. (Watt)		prijs RAL 9016 (€)	prijs kleur (€)				
REF. NR. P4/180 : 267																
267	050	028	XX	YY	00	-	500	280	919	449	1,40	18,30	4,58	-	911	1048
267	060	028	XX	YY	00	-	600	280	1103	539	1,40	21,96	5,49	-	983	1130
267	070	028	XX	YY	00	-	700	280	1287	629	1,40	25,62	6,41	-	1062	1221
267	080	028	XX	YY	00	-	800	280	1470	719	1,40	29,28	7,32	-	1136	1306
267	090	028	XX	YY	00	-	900	280	1654	809	1,40	32,94	8,24	-	1214	1396
267	100	028	XX	YY	00	-	1000	280	1838	899	1,40	36,60	9,15	-	1291	1485
267	110	028	XX	YY	00	-	1100	280	2022	989	1,40	40,26	10,07	-	1365	1570
267	120	028	XX	YY	00	-	1200	280	2206	1079	1,40	43,92	10,98	-	1440	1656
267	140	028	XX	YY	00	-	1400	280	2573	1258	1,40	51,24	12,81	-	1593	1832
267	160	028	XX	YY	00	-	1600	280	2941	1438	1,40	58,56	14,64	-	1744	2006
267	180	028	XX	YY	00	-	1800	280	3308	1618	1,40	65,88	16,47	-	1897	2182
267	200	028	XX	YY	00	-	2000	280	3676	1798	1,40	73,20	18,30	-	2051	2359
267	220	028	XX	YY	00	-	2200	280	4044	1978	1,40	80,52	20,13	-	2200	2530
267	240	028	XX	YY	00	-	2400	280	4411	2157	1,40	87,84	21,96	-	2353	2706
267	260	028	XX	YY	00	-	2600	280	4779	2337	1,40	95,16	23,79	-	2505	2881
267	280	028	XX	YY	00	-	2800	280	5146	2517	1,40	102,48	25,62	-	2662	3061
267	300	028	XX	YY	00	-	3000	280	5514	2697	1,40	109,80	27,45	-	2809	3230
267	330	028	XX	YY	00	-	3300	280	6065	2966	1,40	120,78	30,20	-	3037	3493
267	360	028	XX	YY	00	-	3600	280	6617	3236	1,40	131,76	32,94	-	3266	3756
267	390	028	XX	YY	00	-	3900	280	7168	3506	1,40	142,74	35,69	-	3493	4017

Conform EN442-1: 2014: radiatoren en convectoren

Voor meer details over onze artikel-data, zie artikel-database: <https://www.installdata.be>
Voor de warmteafgifte van andere regimes, kijkt u op p. 370 (correctiefactoren)
BELGIË. Prijzen in euro (excl. BTW)

HOE P4/230 BESTELLEN

Leveringstermijn 15 - 30 werkdagen
(zonder transportduur)

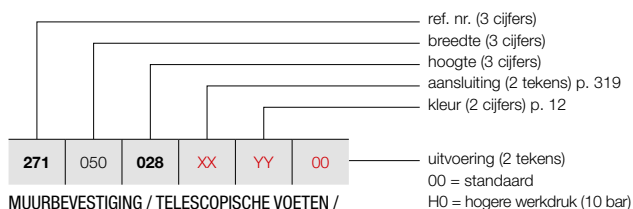

MUURBEVESTIGING / TELESCOPISCHE VOETEN /
KOLOMVOETEN

Zie p. 317 voor extra toebehoren.

PRIMULA P4 (P4/230)

315



P4

PRIJSGROEP: VPG3 - PLINTRADIATOREN

BESTELCODE MAATWERK P4	TECHNISCHE GEGEVENS											STANDAARDKLEUR	ANDERE KLEUREN			
	buizen	breedte (L mm)	hoogte (H mm)	75/65/20 (Watt) (Φ50K)	55/45/20 (Watt) (Φ30K)	n-exp.	gewicht (kg)	inhoud (l)	el. weerst. (Watt)	prijs RAL 9016 (€)	prijs kleur (€)					
REF. NR. P4/230 : 271																
271	050	028	XX	YY	00	-	500	280	1129	552	1,40	21,83	5,78	-	1135	1305
271	060	028	XX	YY	00	-	600	280	1355	663	1,40	26,19	6,93	-	1236	1421
271	070	028	XX	YY	00	-	700	280	1581	773	1,40	30,56	8,09	-	1336	1536
271	080	028	XX	YY	00	-	800	280	1806	883	1,40	34,92	9,24	-	1439	1655
271	090	028	XX	YY	00	-	900	280	2032	994	1,40	39,29	10,40	-	1542	1773
271	100	028	XX	YY	00	-	1000	280	2258	1104	1,40	43,65	11,55	-	1643	1889
271	110	028	XX	YY	00	-	1100	280	2484	1215	1,40	48,02	12,71	-	1744	2006
271	120	028	XX	YY	00	-	1200	280	2710	1326	1,40	52,38	13,86	-	1847	2124
271	140	028	XX	YY	00	-	1400	280	3161	1546	1,40	61,11	16,17	-	2051	2359
271	160	028	XX	YY	00	-	1600	280	3613	1767	1,40	69,84	18,48	-	2252	2590
271	180	028	XX	YY	00	-	1800	280	4064	1988	1,40	78,57	20,79	-	2456	2824
271	200	028	XX	YY	00	-	2000	280	4516	2209	1,40	87,30	23,10	-	2663	3062
271	220	028	XX	YY	00	-	2200	280	4968	2430	1,40	96,03	25,41	-	2862	3291
271	240	028	XX	YY	00	-	2400	280	5419	2651	1,40	104,76	27,72	-	3068	3528
271	260	028	XX	YY	00	-	2600	280	5871	2872	1,40	113,49	30,03	-	3269	3759
271	280	028	XX	YY	00	-	2800	280	6322	3092	1,40	122,22	32,34	-	3475	3996
271	300	028	XX	YY	00	-	3000	280	6774	3313	1,40	130,95	34,65	-	3675	4226
271	330	028	XX	YY	00	-	3300	280	7451	3644	1,40	144,05	38,12	-	3982	4579

Conform EN442-1: 2014: radiatoren en convectoren

Voor meer details over onze artikel-data, zie artikel-database: <https://www.installdata.be>
Voor de warmteafgiftes van andere regimes, kijkt u op p. 370 (correctiefactoren)
BELGIË. Prijzen in euro (excl. BTW)

PRIMULA P4 (P4/280)



P4

HOE P4/280 BESTELLEN

Leveringstermijn 15 - 30 werkdagen
(zonder transportduur)

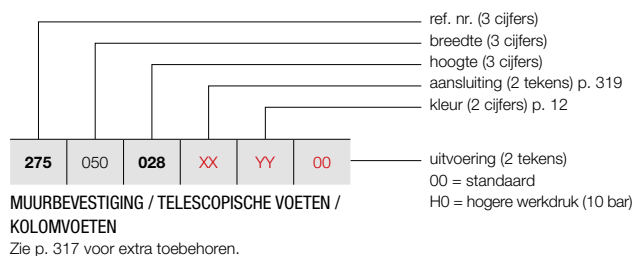

PRIJSGROEP: VPG3 - PLINTRADIATOREN

BESTELCODE MAATWERK P4	TECHNISCHE GEGEVENS										STANDAARDKLEUR	ANDERE KLEUREN				
	buizen	breedte (L mm)	hoogte (H mm)	75/65/20 (Watt) (φ50K)	55/45/20 (Watt) (φ30K)	n-exp.	gewicht (kg)	inhoud (l)	el. weerst. (Watt)		prijs RAL 9016 (€)	prijs kleur (€)				
REF. NR. P4/280 : 275																
275	050	028	XX	YY	00	-	500	280	1335	653	1,40	25,55	6,13	-	1367	1572
275	060	028	XX	YY	00	-	600	280	1602	784	1,40	30,66	7,35	-	1490	1714
275	070	028	XX	YY	00	-	700	280	1869	914	1,40	35,77	8,58	-	1613	1855
275	080	028	XX	YY	00	-	800	280	2136	1045	1,40	40,88	9,80	-	1733	1993
275	090	028	XX	YY	00	-	900	280	2403	1175	1,40	45,99	11,03	-	1860	2139
275	100	028	XX	YY	00	-	1000	280	2670	1306	1,40	51,10	12,25	-	1982	2279
275	110	028	XX	YY	00	-	1100	280	2937	1437	1,40	56,21	13,48	-	2105	2421
275	120	028	XX	YY	00	-	1200	280	3204	1567	1,40	61,32	14,70	-	2231	2566
275	140	028	XX	YY	00	-	1400	280	3738	1828	1,40	71,54	17,15	-	2470	2841
275	160	028	XX	YY	00	-	1600	280	4272	2090	1,40	81,76	19,60	-	2719	3127
275	180	028	XX	YY	00	-	1800	280	4806	2351	1,40	91,98	22,05	-	2963	3407
275	200	028	XX	YY	00	-	2000	280	5340	2612	1,40	102,20	24,50	-	3207	3688
275	220	028	XX	YY	00	-	2200	280	5874	2873	1,40	112,42	26,95	-	3453	3971
275	240	028	XX	YY	00	-	2400	280	6408	3134	1,40	122,64	29,40	-	3698	4253
275	260	028	XX	YY	00	-	2600	280	6942	3395	1,40	132,86	31,85	-	3943	4534
275	280	028	XX	YY	00	-	2800	280	7476	3657	1,40	143,08	34,30	-	4187	4815

Conform EN442-1: 2014: radiatoren en convectoren

Voor meer details over onze artikel-data, zie artikel-database: <https://www.installdata.be>

Voor de warmteafgiftes van andere regimes, kijkt u op p. 370 (correctiefactoren)
BELGIË. Prijzen in euro (excl. BTW)

PRIJSGROEP: VPG10 - ACC.

LENGTE IN MM NOODZAKELIJK AANTAL STUKS PER PLINT	ART. NR. P/80	ART. NR. P/130	ART. NR. P/180	ART. NR. P/230	ART. NR. P/280	KLEUR	€
--	------------------	-------------------	-------------------	-------------------	-------------------	-------	---

MUURBEVESTIGING*



500 - 1800: 2	1186 012 0000 9016	1186 022 0000 9016	1186 032 0000 9016	1186 042 0000 9016	1186 052 0000 9016	RAL 9016	30
	1186 012 0000 XXXX	1186 022 0000 XXXX	1186 032 0000 XXXX	1186 042 0000 XXXX	1186 052 0000 XXXX	KLEUR	35
2000 - 2400: 3	1186 013 0000 9016	1186 023 0000 9016	1186 033 0000 9016	1186 043 0000 9016	1186 053 0000 9016	RAL 9016	46
	1186 013 0000 XXXX	1186 023 0000 XXXX	1186 033 0000 XXXX	1186 043 0000 XXXX	1186 053 0000 XXXX	KLEUR	52
2600 - 3600: 4	1186 014 0000 9016	1186 024 0000 9016	1186 034 0000 9016	1186 044 0000 9016	1186 054 0000 9016	RAL 9016	61
	1186 014 0000 XXXX	1186 024 0000 XXXX	1186 034 0000 XXXX	1186 044 0000 XXXX	1186 054 0000 XXXX	KLEUR	69
3900: 5	1186 015 0000 9016	1186 025 0000 9016	1186 035 0000 9016	1186 045 0000 9016	1186 055 0000 9016	RAL 9016	76
	1186 015 0000 XXXX	1186 025 0000 XXXX	1186 035 0000 XXXX	1186 045 0000 XXXX	1186 055 0000 XXXX	KLEUR	87

Bij bestelling steeds het plinttype (80-130-180-230-280) en de kleur opgeven. Bij de muurbevestigingen zijn de volgende maximumbreedtes mogelijk:
bij P3: diepte = 180 mm, bij P4: diepte = 130 mm.

* noodzakelijk aantal stuks per plint:

in mm	P1					P2					P3			P4	
	80	130	180	230	280	80	130	180	230	280	80	130	180	80	130
tot 1800 mm	2	3	3	4	4	2	3	3	4	5	2	3	3	2	3
1900 - 2400 mm	2	3	3	4	4	2	3	3	4	6	2	3	3	3	3
2500 - 3600 mm	3	3	3	4	5	3	3	4	5	6	3	3	4	3	4
3700 - 3900 mm	3	3	3	4	5	3	3	4	5	6	3	4	4	3	4

BELGIË. Prijzen in euro (excl. BTW)

PRIMULA VRIJSTAANDE OPSTELLING IN OPTIE

PRIJSGROEP: VPG10 - ACC.

LENGTE IN MM NOODZAKELIJK AANTAL STUKS PER PLINT	ART. NR. P/80	ART. NR. P/130	ART. NR. P/180	ART. NR. P/230	ART. NR. P/280	KLEUR	€
--	------------------	-------------------	-------------------	-------------------	-------------------	-------	---



TELESCOPISCHE VOETEN

500 - 1800: 2	1186 112 0000 9016	1186 122 0000 9016	1186 132 0000 9016	1186 142 0000 9016	1186 152 0000 9016	RAL 9016	46
	1186 112 0000 XXXX	1186 122 0000 XXXX	1186 132 0000 XXXX	1186 142 0000 XXXX	1186 152 0000 XXXX	KLEUR	52
2000 - 2400: 3	1186 113 0000 9016	1186 123 0000 9016	1186 133 0000 9016	1186 143 0000 9016	1186 153 0000 9016	RAL 9016	68
	1186 113 0000 XXXX	1186 123 0000 XXXX	1186 133 0000 XXXX	1186 143 0000 XXXX	1186 153 0000 XXXX	KLEUR	79
2600 - 3600: 4	1186 114 0000 9016	1186 124 0000 9016	1186 134 0000 9016	1186 144 0000 9016	1186 154 0000 9016	RAL 9016	91
	1186 114 0000 XXXX	1186 124 0000 XXXX	1186 134 0000 XXXX	1186 144 0000 XXXX	1186 154 0000 XXXX	KLEUR	105
3900: 5	1186 115 0000 9016	1186 125 0000 9016	1186 135 0000 9016	1186 145 0000 9016	1186 155 0000 9016	RAL 9016	114
	1186 115 0000 XXXX	1186 125 0000 XXXX	1186 135 0000 XXXX	1186 145 0000 XXXX	1186 155 0000 XXXX	KLEUR	130

Bij bestelling van standconsoles het plinttype opgeven (80-130-180-230-280) en de kleur. Deze voeten worden standaard geleverd met roset. Max. hoogte voetjes: 265 mm. Min. hoogte voetjes: 205 mm. Het bovendee van het voetje bestaat uit een rechthoekige buis van 40/25 mm, het onderste uit een rechthoekige buis van 35/20 mm.

BELGIË. Prijzen in euro (excl. BTW)

PRIJSGROEP: VPG10 - ACC.

LENGTE IN MM NOODZAKELIJK AANTAL STUKS PER PLINT	KLEUR	ART. NR. P/80	€	ART. NR. P/130	€	ART. NR. P/180	€	ART. NR. P/230	€	ART. NR. P/280	€
--	-------	------------------	---	-------------------	---	-------------------	---	-------------------	---	-------------------	---



KOLOMVOETEN

500 - 1800: 2	RAL 9016	1186 212 0000 9016	93	1186 222 0000 9016	95	1186 232 0000 9016	97	1186 242 0000 9016	100	1186 252 0000 9016	107
	KLEUR	1186 212 0000 XXXX	107	1186 222 0000 XXXX	111	1186 232 0000 XXXX	113	1186 242 0000 XXXX	115	1186 252 0000 XXXX	121
2000 - 2400: 3	RAL 9016	1186 213 0000 9016	140	1186 223 0000 9016	143	1186 233 0000 9016	147	1186 243 0000 9016	150	1186 253 0000 9016	159
	KLEUR	1186 213 0000 XXXX	159	1186 223 0000 XXXX	166	1186 233 0000 XXXX	170	1186 243 0000 XXXX	173	1186 253 0000 XXXX	182
2600 - 3600: 4	RAL 9016	1186 214 0000 9016	186	1186 224 0000 9016	191	1186 234 0000 9016	196	1186 244 0000 9016	200	1186 254 0000 9016	213
	KLEUR	1186 214 0000 XXXX	213	1186 224 0000 XXXX	221	1186 234 0000 XXXX	226	1186 244 0000 XXXX	230	1186 254 0000 XXXX	243
3900: 5	RAL 9016	1186 215 0000 9016	234	1186 225 0000 9016	239	1186 235 0000 9016	244	1186 245 0000 9016	249	1186 255 0000 9016	266
	KLEUR	1186 215 0000 XXXX	266	1186 225 0000 XXXX	276	1186 235 0000 XXXX	283	1186 245 0000 XXXX	288	1186 255 0000 XXXX	304

Voor de eventuele inbouwmontage van een thermostaatventiel. De standaardhoogte van de kolomvoeten is 150 mm.

Aantal benodigde kolomvoeten = idem telescopische voetjes.

BELGIË. Prijzen in euro (excl. BTW)

PRIMULA: P1 / P2 / P3 / P4

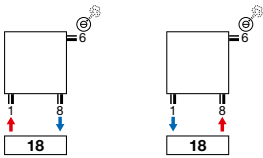

PRIMULA: P2 / P3 / P4

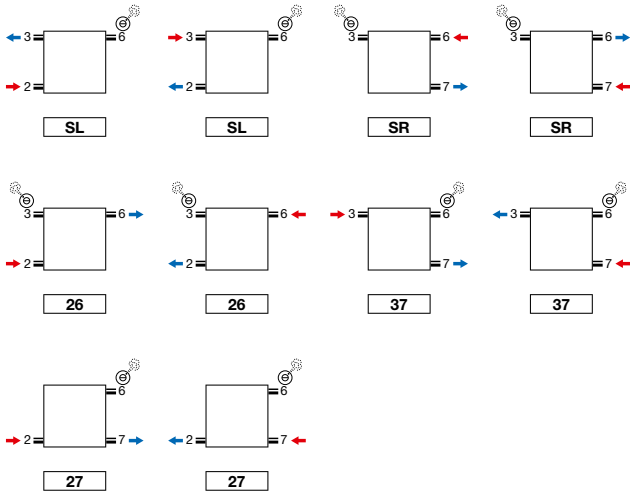

UNIVERSELE AANSLUITING

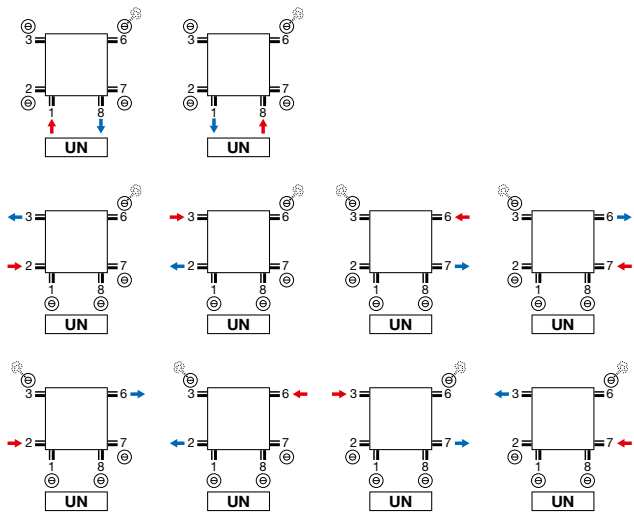

- P2, P3, P4 universele aansluiting (UN) 6 x ½ (1, 2, 3, 6, 7, 8)
- P1 universele aansluiting (US) 4 x ½ (1, 3, 6, 8)

OPMERKING TWEEPIJPSYSTEEM:

- niet mogelijk bij type P1: SL, SR

Opmerking: het aansluiten van de radiator kan enkel volgens de getoonde aansluiticonen. Voor elke andere aansluitwijze nemen wij geen verantwoordelijkheid.

PRIMULA (P1, P2, P3, P4)

Aansluiting 18 | Bovenaanzicht

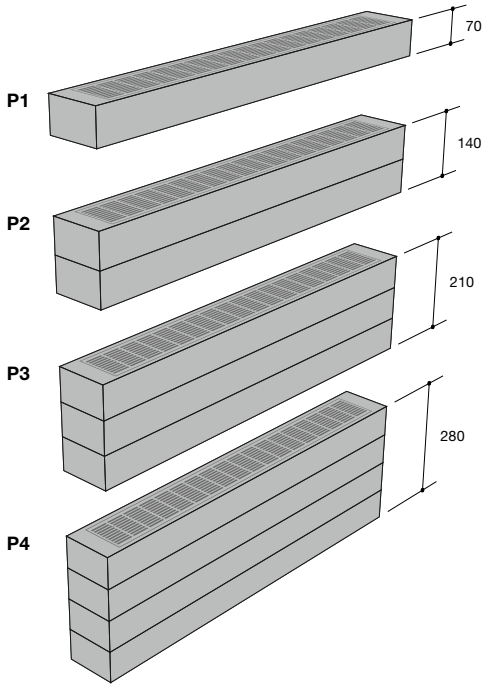
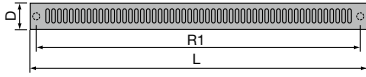

Universele aansluiting UN (standaard) | Zijaanzicht

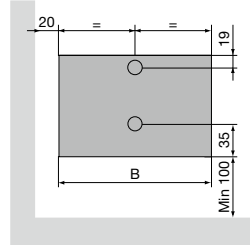

Aansluiting SL/SR | Zijaanzicht

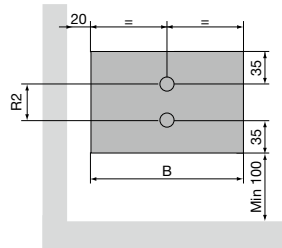

P1 / P2 / P3 / P4

Hartafstand tussen de onderaansluitingen 18 (R1)	Breedte (L) - 46
Hartafstand tussen de zijaansluitingen SL/SR (P2, P3, P4) (R2)	Hoogte (H) - 70
Afstand aansluiting tot de muur (S1)	20 + Diepte (D) / 2



PLINTRADIATOREN

Primula (P3), Traffic White