



Kolomradiatoren

## Een klassieker met kracht.

De VASCO kolomradiator combineert een hoog vermogen met een snelle en efficiënte warmteafgifte.

Hij levert uitstekende prestaties, ook in combinatie met lage watertemperatuursystemen zoals warmtepompen — een retro ontwerp in de meest duurzame zin van het woord.

Tot in het kleinste detail afgestemd op zuinig energieverbruik, met slimme aansluitingen, doordachte bevestigingssystemen en innovatieve technologische oplossingen.

Een tijdloze klassieker die kracht, comfort en efficiëntie moeiteloos verenigt.

---

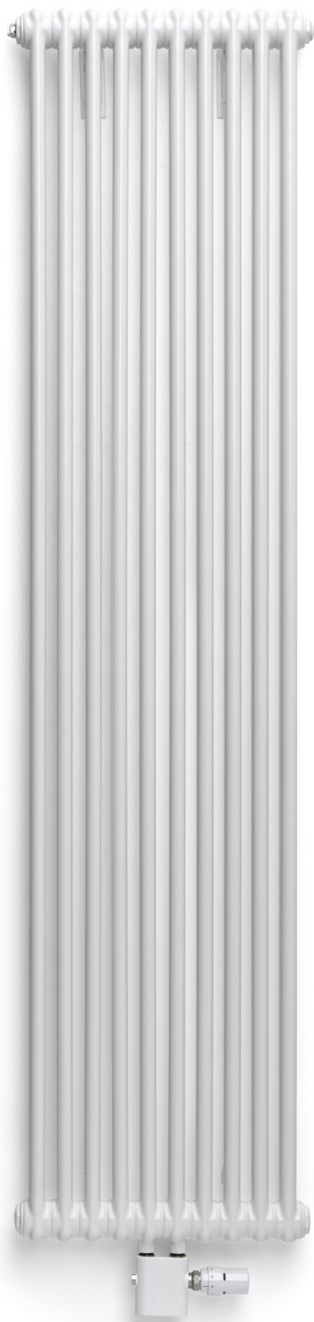

## RITMO VERTICAAL

### Hoge warmteafgifte

Met hun hoge warmteafgifte brengen VASCO's Ritmo-kolomradiatoren zelfs de grootste ruimtes in een mum van tijd op de gewenste temperatuur, zonder dat je dat merkt aan je energiefactuur. Door hun groot verwarmingsoppervlak zijn ze uitermate geschikt voor lage temperatuurverwarming. Zo geniet je van aangename temperaturen en een comfortabel binnenklimaat.

### TYPES

- 2 / 3 / 4 kolommen
- Bouwdiepte: 65 / 105 / 145 mm
- Bouwhoogte: 1500, 1800, 2000, 2200 mm
- Bouwlengte: 270, 360, 450, 540, 630, 720 mm

### BUIZEN

- Verticaal, 25 mm

### KLEUREN

- Standaardkleur wit RAL 9016
- Uitgebreide kleurenkaart zie p. 12

### BEVESTIGINGEN

- Wandmontage
- Muurbevestigingen standaard
- Bij witte radiatoren wordt standaard een witte klemconsole 30 mm en een witte afstandshouder geleverd
- Bij gekleurde radiatoren wordt standaard een klemconsole 30 mm in de kleur van de radiator en een afstandshouder in RAL 7024 geleverd

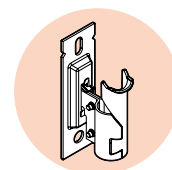

### TECHNISCH

- Bestaande uit kopstukken (bandstaal persdelen) en ronde buizen.
- ATL-grondlaag, poedercoating
- Standaardwerkdruk: 10 bar
- Maximale bedrijfstemperatuur: 110°C

### TECHNISCHE TEKENINGEN

- Zie p. 340

### AANSLUITING

- ✗ Eénpuntsaansluiting voor éénpijpsysteem
- ✗ Eénpuntsaansluiting voor tweepijpsysteem
- ✓ Tweepuntsaansluiting voor éénpijpsysteem (aansluiting via de middenaansluiting) (zie p. 362)
- ✓ Tweepuntsaansluiting voor tweepijpsysteem (standaard) (zie p. 362)
- ✗ Geïntegreerd ventiel
- Aansluitingen: 1/2" (binnendraad)

### AANBEVOLEN AANSLUITING (MM)

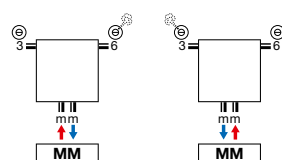

Andere aansluitmogelijkheden, zie p. 339

### AANBEVOLEN VOOR BADKAMER EN KEUKEN IN OPTIE



handdoekbeugel (chrom) art. nr. zie p. 338

prijs €149

**NEW**



### Ventielset haaks kleur

art. nr. 1182 105 0000 9016

**prijs €201**

Andere kleuren, zie p. 366

Koppelingen, zie p. 380



### Thermostaatkop

Traffic White

art. nr.

1182 030 0000 9016

**prijs €40**



## HOE RITMO VERTICAAL BESTELLEN

Leveringstermijn 15 - 30 werkdagen  
(zonder transportduur)

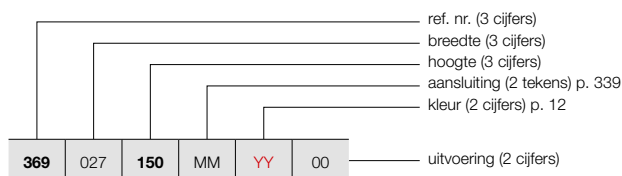

## RITMO VERTICAAL (2-KOLOM)

325



RITMO VB-2K/65  
(2-KOLOM)

### PRIJSGROEP: VPG5 - KOLOMRADIATOREN

BESTELCODE MAATWERK RITMO VERTICAAL	TECHNISCHE GEGEVENS								STANDAARDKLEUR		ANDERE KLEUREN					
	buizen	breedte (L mm)	hoogte (H mm)	75/65/20 (Watt) (φ50K)	55/45/20 (Watt) (φ30K)	n-exp.	gewicht (kg)	inhoud (l)	el. weerst. (Watt)	prijs RAL 9016 (€)	prijs kleur (€)					
<b>REF. NR. RITMO VERTICAAL VB-2K/65 : 369</b>																
<b>369</b>	027	150	MM	YY	00	6	270	1500	654	333	1,32	11,58	7,92	-	<b>427</b>	<b>491</b>
		180				6	270	1800	780	397	1,32	13,74	9,36	-	<b>482</b>	<b>554</b>
		200				6	270	2000	864	440	1,32	15,18	10,32	-	<b>540</b>	<b>621</b>
		220				6	270	2200	948	483	1,32	16,68	11,28	-	<b>718</b>	<b>826</b>
<b>369</b>	036	150	MM	YY	00	8	360	1500	872	444	1,32	15,44	10,56	-	<b>505</b>	<b>581</b>
		180				8	360	1800	1040	530	1,32	18,32	12,48	-	<b>570</b>	<b>656</b>
		200				8	360	2000	1152	587	1,32	20,24	13,76	-	<b>635</b>	<b>730</b>
		220				8	360	2200	1264	644	1,32	22,24	15,04	-	<b>806</b>	<b>927</b>
<b>369</b>	045	150	MM	YY	00	10	450	1500	1090	555	1,32	19,30	13,20	-	<b>581</b>	<b>668</b>
		180				10	450	1800	1300	662	1,32	22,90	15,60	-	<b>664</b>	<b>764</b>
		200				10	450	2000	1440	734	1,32	25,30	17,20	-	<b>713</b>	<b>820</b>
		220				10	450	2200	1580	805	1,32	27,80	18,80	-	<b>896</b>	<b>1030</b>
<b>369</b>	054	150	MM	YY	00	12	540	1500	1308	666	1,32	23,16	15,84	-	<b>679</b>	<b>781</b>
		180				12	540	1800	1560	795	1,32	27,48	18,72	-	<b>767</b>	<b>882</b>
		200				12	540	2000	1728	880	1,32	30,36	20,64	-	<b>844</b>	<b>971</b>
		220				12	540	2200	1896	966	1,32	33,36	22,56	-	<b>981</b>	<b>1128</b>
<b>369</b>	063	150	MM	YY	00	14	630	1500	1526	778	1,32	27,02	18,48	-	<b>779</b>	<b>896</b>
		180				14	630	1800	1820	927	1,32	32,06	21,84	-	<b>872</b>	<b>1003</b>
		200				14	630	2000	2016	1027	1,32	35,42	24,08	-	<b>976</b>	<b>1122</b>
		220				14	630	2200	2212	1127	1,32	38,92	26,32	-	<b>1070</b>	<b>1231</b>
<b>369</b>	072	150	MM	YY	00	16	720	1500	1744	889	1,32	30,88	21,12	-	<b>877</b>	<b>1009</b>
		180				16	720	1800	2080	1060	1,32	36,64	24,96	-	<b>981</b>	<b>1128</b>
		200				16	720	2000	2304	1174	1,32	40,48	27,52	-	<b>1086</b>	<b>1249</b>
		220				16	720	2200	2528	1288	1,32	44,48	30,08	-	<b>1156</b>	<b>1329</b>

Conform EN442-1: 2014: radiatoren en convectoren

Voor meer details over onze artikel-data, zie artikel-database: <https://www.installdata.be>

**Voor de warmteafgiftes van andere regimes, kijkt u op p. 370 (correctiefactoren)**  
**BELGIË. Prijzen in euro (excl. BTW)**

# RITMO VERTICAAL (3-KOLOM)

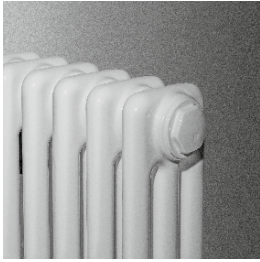

RITMO VB-3K/105  
(3-KOLOM)

## HOE RITMO VERTICAAL BESTELLEN

Leveringstermijn 15 - 30 werkdagen  
(zonder transportduur)

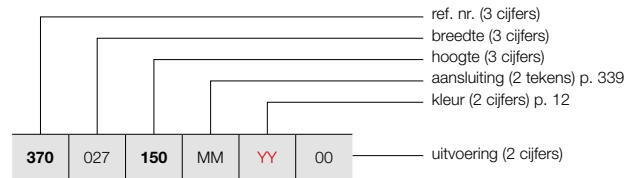

### PRIJSGROEP: VPG5 - KOLOMRADIATOREN

BESTELCODE MAATWERK RITMO VERTICAAL							TECHNISCHE GEGEVENS					STANDAARDKLEUR	ANDERE KLEUREN			
370	027	150	MM	YY	00	buizen	breedte (L mm)	hoogte (H mm)	75/65/20 (Watt) (Φ50K)	55/45/20 (Watt) (Φ30K)	n-exp.	gewicht (kg)	inhoud (l)	el. weerst. (Watt)	prijs RAL 9016 (€)	prijs kleur (€)
<b>REF. NR. RITMO VERTICAAL VB-3K/105 : 370</b>																
370	027	150	MM	YY	00	6	270	1500	882	443	1,35	17,34	11,76	-	559	643
		180				6	270	1800	1038	521	1,35	20,58	13,92	-	646	743
		200				6	270	2000	1140	575	1,34	22,80	15,36	-	659	758
		220				6	270	2200	1242	626	1,34	24,96	16,80	-	786	904
370	036	150	MM	YY	00	8	360	1500	1176	590	1,35	23,12	15,68	-	657	756
		180				8	360	1800	1384	694	1,35	27,44	18,56	-	766	881
		200				8	360	2000	1520	767	1,34	30,40	20,48	-	803	923
		220				8	360	2200	1656	835	1,34	33,28	22,40	-	927	1066
370	045	150	MM	YY	00	10	450	1500	1470	738	1,35	28,90	19,60	-	751	864
		180				10	450	1800	1730	868	1,35	34,30	23,20	-	877	1009
		200				10	450	2000	1900	958	1,34	38,00	25,60	-	926	1065
		220				10	450	2200	2070	1044	1,34	41,60	28,00	-	1077	1239
370	054	150	MM	YY	00	12	540	1500	1764	885	1,35	34,68	23,52	-	877	1009
		180				12	540	1800	2076	1042	1,35	41,16	27,84	-	1042	1198
		200				12	540	2000	2280	1150	1,34	45,60	30,72	-	1090	1254
		220				12	540	2200	2484	1253	1,34	49,92	33,60	-	1260	1449
370	063	150	MM	YY	00	14	630	1500	2058	1033	1,35	40,46	27,44	-	1008	1159
		180				14	630	1800	2422	1215	1,35	48,02	32,48	-	1170	1346
		200				14	630	2000	2660	1342	1,34	53,20	35,84	-	1235	1420
		220				14	630	2200	2898	1462	1,34	58,24	39,20	-	1410	1622
370	072	150	MM	YY	00	16	720	1500	2352	1180	1,35	46,24	31,36	-	1123	1291
		180				16	720	1800	2768	1389	1,35	54,88	37,12	-	1328	1527
		200				16	720	2000	3040	1533	1,34	60,80	40,96	-	1362	1566
		220				16	720	2200	3312	1670	1,34	66,56	44,80	-	1574	1810

Conform EN442-1: 2014: radiatoren en convectoren

Voor meer details over onze artikel-data, zie artikel-database: <https://www.installdata.be>

**Voor de warmteafgiftes van andere regimes, kijkt u op p. 370 (correctiefactoren)**  
**BELGIË. Prijzen in euro (excl. BTW)**

## HOE RITMO VERTICAAL BESTELLEN

Leveringstermijn 15 - 30 werkdagen  
(zonder transportduur)

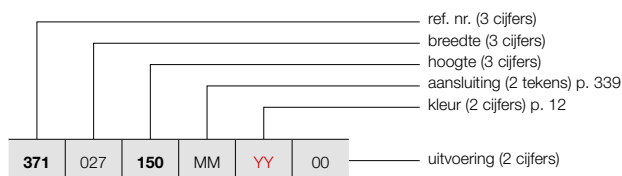

## RITMO VERTICAAL (4-KOLOM)

327



RITMO VB-4K/145  
(4-KOLOM)

### PRIJSGROEP: VPG5 - KOLOMRADIATOREN

BESTELCODE MAATWERK RITMO VERTICAAL	TECHNISCHE GEGEVENS								STANDAARDKLEUR	ANDERE KLEUREN						
	buizen	breedte (L mm)	hoogte (H mm)	75/65/20 (Watt) (Φ50K)	55/45/20 (Watt) (Φ30K)	n-exp.	gewicht (kg)	inhoud (l)			el. weerst. (Watt)	prijs RAL 9016 (€)	prijs kleur (€)			
<b>REF. NR. RITMO VERTICAAL VB-4K/145 : 371</b>																
<b>371</b>	<b>027</b>	<b>150</b>	<b>MM</b>	<b>YY</b>	<b>00</b>	6	270	1500	1116	560	1,35	23,10	15,60	-	<b>681</b>	<b>783</b>
		<b>180</b>				6	270	1800	1314	663	1,34	27,48	18,48	-	<b>818</b>	<b>941</b>
		<b>200</b>				6	270	2000	1446	729	1,34	30,36	20,40	-	<b>868</b>	<b>998</b>
		<b>220</b>				6	270	2200	1572	793	1,34	33,30	22,32	-	<b>1050</b>	<b>1208</b>
<b>371</b>	<b>036</b>	<b>150</b>	<b>MM</b>	<b>YY</b>	<b>00</b>	8	360	1500	1488	747	1,35	30,80	20,80	-	<b>804</b>	<b>925</b>
		<b>180</b>				8	360	1800	1752	884	1,34	36,64	24,64	-	<b>974</b>	<b>1120</b>
		<b>200</b>				8	360	2000	1928	972	1,34	40,48	27,20	-	<b>1044</b>	<b>1201</b>
		<b>220</b>				8	360	2200	2096	1057	1,34	44,40	29,76	-	<b>1212</b>	<b>1394</b>
<b>371</b>	<b>045</b>	<b>150</b>	<b>MM</b>	<b>YY</b>	<b>00</b>	10	450	1500	1860	933	1,35	38,50	26,00	-	<b>932</b>	<b>1072</b>
		<b>180</b>				10	450	1800	2190	1105	1,34	45,80	30,80	-	<b>1093</b>	<b>1257</b>
		<b>200</b>				10	450	2000	2410	1215	1,34	50,60	34,00	-	<b>1216</b>	<b>1398</b>
		<b>220</b>				10	450	2200	2620	1321	1,34	55,50	37,20	-	<b>1370</b>	<b>1576</b>
<b>371</b>	<b>054</b>	<b>150</b>	<b>MM</b>	<b>YY</b>	<b>00</b>	12	540	1500	2232	1120	1,35	46,20	31,20	-	<b>1084</b>	<b>1247</b>
		<b>180</b>				12	540	1800	2628	1325	1,34	54,96	36,96	-	<b>1243</b>	<b>1429</b>
		<b>200</b>				12	540	2000	2892	1459	1,34	60,72	40,80	-	<b>1496</b>	<b>1720</b>
		<b>220</b>				12	540	2200	3144	1586	1,34	66,60	44,64	-	<b>1589</b>	<b>1827</b>
<b>371</b>	<b>063</b>	<b>150</b>	<b>MM</b>	<b>YY</b>	<b>00</b>	14	630	1500	2604	1307	1,35	53,90	36,40	-	<b>1248</b>	<b>1435</b>
		<b>180</b>				14	630	1800	3066	1546	1,34	64,12	43,12	-	<b>1464</b>	<b>1684</b>
		<b>200</b>				14	630	2000	3374	1702	1,34	70,84	47,60	-	<b>1688</b>	<b>1941</b>
		<b>220</b>				14	630	2200	3668	1850	1,34	77,70	52,08	-	<b>1863</b>	<b>2142</b>
<b>371</b>	<b>072</b>	<b>150</b>	<b>MM</b>	<b>YY</b>	<b>00</b>	16	720	1500	2976	1493	1,35	61,60	41,60	-	<b>1384</b>	<b>1592</b>
		<b>180</b>				16	720	1800	3504	1767	1,34	73,28	49,28	-	<b>1723</b>	<b>1981</b>
		<b>200</b>				16	720	2000	3856	1945	1,34	80,96	54,40	-	<b>1925</b>	<b>2214</b>
		<b>220</b>				16	720	2200	4192	2114	1,34	88,80	59,52	-	<b>2095</b>	<b>2409</b>

Conform EN442-1: 2014: radiatoren en convectoren

Voor meer details over onze artikel-data, zie artikel-database: <https://www.installdata.be>

**Voor de warmteafgiftes van andere regimes, kijkt u op p. 370 (correctiefactoren)**

**BELGIË. Prijzen in euro (excl. BTW)**

## RITMO HORIZONTAAL (HB-2K/65, HB-3K/105, HB-4K/145)

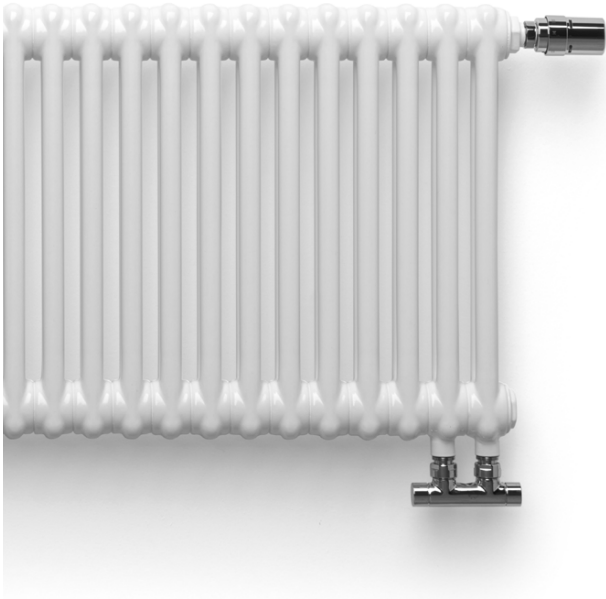

### TYPES

- 2 / 3 / 4 kolommen
- Bouwdiepte: 65 / 105 / 145 mm
- Bouwhoogte: 300, 400, 500, 600, 900 mm
- Bouwlengte: 450, 540, 630, 720, 810, 900, 990, 1080, 1170, 1260, 1350, 1440, 1530, 1620, 1710, 1800 mm

### BUIZEN

- Verticaal, 25 mm

### KLEUREN

- Standaardkleur wit RAL 9016
- Uitgebreide kleurenkaart zie p. 12

### BEVESTIGINGEN

- Vloer- of wandmontage
- Muurbevestigingen standaard
- Bij witte radiatoren wordt standaard een witte klemconsole 30 mm en een witte afstandshouder geleverd
- Bij gekleurde radiatoren wordt standaard een klemconsole 30 mm in de kleur van de radiator en een afstandshouder in RAL 7024 geleverd

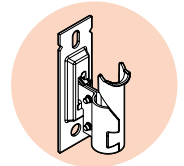

### TECHNISCH

- Bestaande uit kopstukken (bandstaal persdelen) en ronde buizen.
- ATL-grondlaag, poedercoating
- Standaardwerkdruk: 10 bar
- Maximale bedrijfstemperatuur: 110°C

### TECHNISCHE TEKENINGEN

- Zie p. 340

### AANSLUITING

- ✗ Eénpuntsaansluiting voor éénpijpssysteem
- ✗ Eénpuntsaansluiting voor tweepijpssysteem
- ✓ Tweepuntsaansluiting voor éénpijpssysteem (aansluiting via het geïntegreerd ventiel) (zie p. 363)
- ✓ Tweepuntsaansluiting voor tweepijpssysteem (standaard) (zie p. 362)
- ✓ Geïntegreerd ventiel (aansluiting VR) (**meerprijs: €85**) (thermostaatkop apart te bestellen, zie p. 338)
- Aansluitingen: 1/2" (binnendraad)

## RITMO HORIZONTAAL

### Van klassiek tot modern

Het authentieke karakter van de Ritmo-kolomradiator is voor heel wat design-liefhebbers een schot in de roos. Omdat ze in hoge hoogtematen beschikbaar zijn, komen deze designradiatoren optimaal tot hun recht in grote, hoge en open interieurs, van klassieke herenhuisen tot moderne industriële lofts. Deze radiatoren worden ook vaak toegepast in openbare ruimtes, aangezien ze met hun relatief brede openingen makkelijk te reinigen en dus erg onderhoudsvriendelijk zijn. Met hun karakteristieke retro-uitstraling zijn deze kolomradiatoren in vele uitvoeringen beschikbaar: in horizontale of verticale variant en in 2, 3 of 4 kolommen.

### AANBEVOLEN AANSLUITING GEÏNTEGREERD VENTIEL

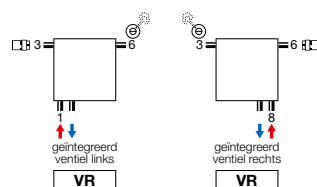

Andere aansluitmogelijkheden, zie p. 339

### AANBEVOLEN VOOR BADKAMER EN KEUKEN IN OPTIE



handdoekbeugel (chrom) art. nr. zie p. 338  
prijs €149



art. nr. 118230100000099  
prijs €157



wit art. nr. 11911630102  
prijs €48



chrom art. nr. 11911631102  
prijs €65



## HOE RITMO HORIZONTAAL BESTELLEN

Leveringstermijn 15 - 30 werkdagen  
(zonder transportduur)

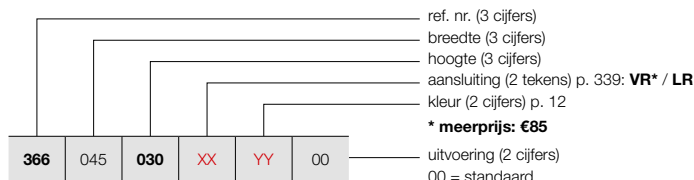

## RITMO HORIZONTAAL (2-KOLOM)

329

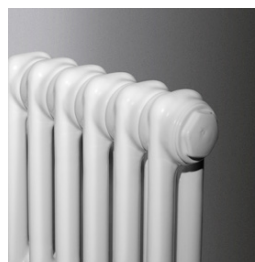

RITMO HB-2K/65  
(2-KOLOM) 4-AANSLUITINGEN

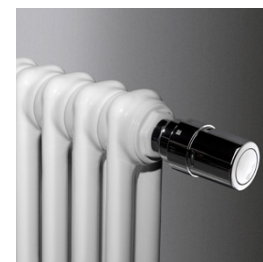

RITMO HB-2K/65  
(2-KOLOM) GEÏNTEGREERD VENTIEL  
(thermostaatkop apart te bestellen)

### PRIJSGROEP: VPG5 - KOLOMRADIATOREN

BESTELCODE MAATWERK RITMO HORIZONTAAL	TECHNISCHE GEGEVENS							STANDAARDKLEUR		ANDERE KLEUREN	
	buizen	breedte (L mm)	hoogte (H mm)	75/65/20 (Watt) (φ50K)	55/45/20 (Watt) (φ30K)	n-exp.	gewicht (kg)	inhoud (l)	el. weerst. (Watt)	prijs RAL 9016 (€)	prijs kleur (€)
<b>REF. NR. RITMO HORIZONTAAL HB-2K/65 : 366</b>											
366 045 030 XX YY 00	10	450	300	240	126	1,26	4,70	3,70	-	296	340
	10	450	400	310	159	1,31	5,90	4,50	-	307	353
	10	450	500	390	200	1,31	7,10	5,30	-	318	366
	10	450	600	460	123	1,31	8,30	6,10	-	329	378
	10	450	900	670	343	1,31	12,00	8,40	-	365	420
	10	450	900	670	343	1,31	12,00	8,40	-	365	420
366 054 030 XX YY 00	12	540	300	288	151	1,26	5,64	4,44	-	351	404
	12	540	400	372	191	1,31	7,08	5,40	-	362	416
	12	540	500	468	240	1,31	8,52	6,36	-	373	429
	12	540	600	552	147	1,31	9,96	7,32	-	384	442
	12	540	900	804	412	1,31	14,40	10,08	-	420	483
	12	540	900	804	412	1,31	14,40	10,08	-	420	483
366 063 030 XX YY 00	14	630	300	336	177	1,26	6,58	5,18	-	417	480
	14	630	400	434	222	1,31	8,26	6,30	-	427	491
	14	630	500	546	280	1,31	9,94	7,42	-	439	505
	14	630	600	644	172	1,31	11,62	8,54	-	449	516
	14	630	900	938	480	1,31	16,80	11,76	-	486	559
	14	630	900	938	480	1,31	16,80	11,76	-	486	559
366 072 030 XX YY 00	16	720	300	384	202	1,26	7,52	5,92	-	483	555
	16	720	400	496	254	1,31	9,44	7,20	-	493	567
	16	720	500	624	320	1,31	11,36	8,48	-	505	581
	16	720	600	736	197	1,31	13,28	9,76	-	515	592
	16	720	900	1072	549	1,31	19,20	13,44	-	552	635
	16	720	900	1072	549	1,31	19,20	13,44	-	552	635
366 081 030 XX YY 00	18	810	300	432	227	1,26	8,46	6,66	-	549	631
	18	810	400	558	286	1,31	10,62	8,10	-	559	643
	18	810	500	702	360	1,31	12,78	9,54	-	570	656
	18	810	600	828	221	1,31	14,94	10,98	-	581	668
	18	810	900	1206	618	1,31	21,60	15,12	-	618	711
	18	810	900	1206	618	1,31	21,60	15,12	-	618	711
366 090 030 XX YY 00	20	900	300	480	252	1,26	9,40	7,40	-	591	680
	20	900	400	620	318	1,31	11,80	9,00	-	603	693
	20	900	500	780	399	1,31	14,20	10,60	-	613	705
	20	900	600	920	246	1,31	16,60	12,20	-	625	719
	20	900	900	1340	686	1,31	24,00	16,80	-	661	760
	20	900	900	1340	686	1,31	24,00	16,80	-	661	760
366 099 030 XX YY 00	22	990	300	528	277	1,26	10,34	8,14	-	625	719
	22	990	400	682	349	1,31	12,98	9,90	-	635	730
	22	990	500	858	439	1,31	15,62	11,66	-	647	744
	22	990	600	1012	270	1,31	18,26	13,42	-	657	756
	22	990	900	1474	755	1,31	26,40	18,48	-	694	798
	22	990	900	1474	755	1,31	26,40	18,48	-	694	798
366 108 030 XX YY 00	24	1080	300	576	303	1,26	11,28	8,88	-	657	756
	24	1080	400	744	381	1,31	14,16	10,80	-	669	769
	24	1080	500	936	479	1,31	17,04	12,72	-	679	781
	24	1080	600	1104	295	1,31	19,92	14,64	-	691	795
	24	1080	900	1608	824	1,31	28,80	20,16	-	726	835
	24	1080	900	1608	824	1,31	28,80	20,16	-	726	835

Conform EN442-1: 2014: radiatoren en convectoren

Voor meer details over onze artikel-data, zie artikel-database: <https://www.installdata.be>

Voor de warmteafgiftes van andere regimes, kijkt u op p. 370 (correctiefactoren)  
BELGIË. Prijzen in euro (excl. BTW)

# RITMO HORIZONTAAL (2-KOLOM)

## HOE RITMO HORIZONTAAL BESTELLEN

Leveringstermijn 15 - 30 werkdagen  
(zonder transportduur)

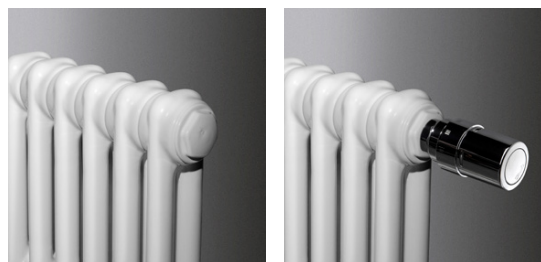

RITMO HB-2K/65  
(2-KOLOM) 4-AANSLUITINGEN

RITMO HB-2K/65  
(2-KOLOM) GEÏNTEGREERD VENTIEL  
(thermostaatkop apart te bestellen)



### PRIJSGROEP: VPG5 - KOLOMRADIATOREN

BESTELCODE MAATWERK RITMO HORIZONTAAL	TECHNISCHE GEGEVENS									STANDAARDKLEUR	ANDERE KLEUREN
	buizen	breedte (L mm)	hoogte (H mm)	75/65/20 (Watt) (Φ50K)	55/45/20 (Watt) (Φ30K)	n-exp.	gewicht (kg)	inhoud (l)	el. weerst. (Watt)	prijs RAL 9016 (€)	prijs kleur (€)
<b>REF. NR. RITMO HORIZONTAAL HB-2K/65 : 366</b>											
<b>366</b>	<b>117</b>	<b>030</b>	<b>XX</b>	<b>YY</b>	<b>00</b>						
		<b>040</b>								<b>718</b>	<b>826</b>
		<b>050</b>								<b>729</b>	<b>838</b>
		<b>060</b>								<b>740</b>	<b>851</b>
		<b>090</b>								<b>751</b>	<b>864</b>
										<b>787</b>	<b>905</b>
<b>366</b>	<b>126</b>	<b>030</b>	<b>XX</b>	<b>YY</b>	<b>00</b>						
		<b>040</b>								<b>779</b>	<b>896</b>
		<b>050</b>								<b>789</b>	<b>907</b>
		<b>060</b>								<b>800</b>	<b>920</b>
		<b>090</b>								<b>811</b>	<b>933</b>
										<b>847</b>	<b>974</b>
<b>366</b>	<b>135</b>	<b>030</b>	<b>XX</b>	<b>YY</b>	<b>00</b>						
		<b>040</b>								<b>844</b>	<b>971</b>
		<b>050</b>								<b>855</b>	<b>983</b>
		<b>060</b>								<b>866</b>	<b>996</b>
		<b>090</b>								<b>877</b>	<b>1009</b>
										<b>913</b>	<b>1050</b>
<b>366</b>	<b>144</b>	<b>030</b>	<b>XX</b>	<b>YY</b>	<b>00</b>						
		<b>040</b>								<b>910</b>	<b>1047</b>
		<b>050</b>								<b>921</b>	<b>1059</b>
		<b>060</b>								<b>932</b>	<b>1072</b>
		<b>090</b>								<b>943</b>	<b>1084</b>
										<b>979</b>	<b>1126</b>
<b>366</b>	<b>153</b>	<b>030</b>	<b>XX</b>	<b>YY</b>	<b>00</b>						
		<b>040</b>								<b>976</b>	<b>1122</b>
		<b>050</b>								<b>986</b>	<b>1134</b>
		<b>060</b>								<b>998</b>	<b>1148</b>
		<b>090</b>								<b>1008</b>	<b>1159</b>
										<b>1045</b>	<b>1202</b>
<b>366</b>	<b>162</b>	<b>030</b>	<b>XX</b>	<b>YY</b>	<b>00</b>						
		<b>040</b>								<b>1042</b>	<b>1198</b>
		<b>050</b>								<b>1052</b>	<b>1210</b>
		<b>060</b>								<b>1064</b>	<b>1224</b>
		<b>090</b>								<b>1074</b>	<b>1235</b>
										<b>1111</b>	<b>1278</b>
<b>366</b>	<b>171</b>	<b>030</b>	<b>XX</b>	<b>YY</b>	<b>00</b>						
		<b>040</b>								<b>1107</b>	<b>1273</b>
		<b>050</b>								<b>1118</b>	<b>1286</b>
		<b>060</b>								<b>1129</b>	<b>1298</b>
		<b>090</b>								<b>1140</b>	<b>1311</b>
										<b>1177</b>	<b>1354</b>
<b>366</b>	<b>180</b>	<b>030</b>	<b>XX</b>	<b>YY</b>	<b>00</b>						
		<b>040</b>								<b>1172</b>	<b>1348</b>
		<b>050</b>								<b>1184</b>	<b>1362</b>
		<b>060</b>								<b>1194</b>	<b>1373</b>
		<b>090</b>								<b>1206</b>	<b>1387</b>
										<b>1243</b>	<b>1429</b>

Conform EN442-1: 2014: radiatoren en convectoren

Voor meer details over onze artikel-data, zie artikel-database: <https://www.installdata.be>

Voor de warmteafgiftes van andere regimes, kijkt u op p. 370 (correctiefactoren)  
BELGIË. Prijzen in euro (excl. BTW)

## HOE RITMO HORIZONTAAL BESTELLEN

Leveringstermijn 15 - 30 werkdagen  
(zonder transportduur)

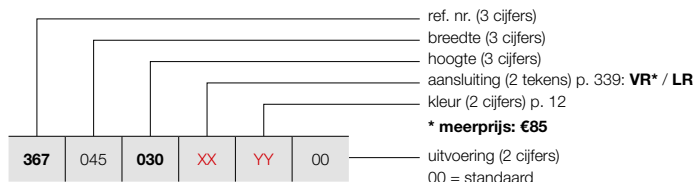

## RITMO HORIZONTAAL (3-KOLOM)

331

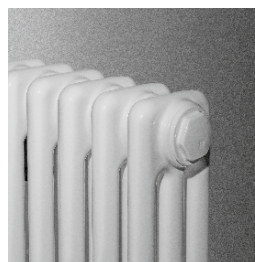

RITMO HB-3K/105  
(3-KOLOM) 4-AANSLUITINGEN



RITMO HB-3K/105  
(3-KOLOM) GEÏNTEGREERD VENTIEL  
(thermostaatkop apart te bestellen)

### PRIJSGROEP: VPG5 - KOLOMRADIATOREN

BESTELCODE MAATWERK RITMO HORIZONTAAL	TECHNISCHE GEGEVENS							STANDAARDKLEUR		ANDERE KLEUREN	
	buizen	breedte (L mm)	hoogte (H mm)	75/65/20 (Watt) (φ50K)	55/45/20 (Watt) (φ30K)	n-exp.	gewicht (kg)	inhoud (l)	el. weerst. (Watt)	prijs RAL 9016 (€)	prijs kleur (€)
<b>REF. NR. RITMO HORIZONTAAL HB-3K/105 : 367</b>											
367 045 030 XX YY 00	10	450	300	330	167	1,33	7,00	5,30	-	346	398
	10	450	400	430	215	1,36	8,80	6,50	-	357	411
	10	450	500	530	265	1,36	10,60	7,70	-	368	423
	10	450	600	630	315	1,36	12,50	8,90	-	379	436
	10	450	900	920	459	1,36	17,90	12,50	-	433	498
367 054 030 XX YY 00	12	540	300	396	201	1,33	8,40	6,36	-	403	463
	12	540	400	516	258	1,36	10,56	7,80	-	415	477
	12	540	500	636	258	1,36	12,72	9,24	-	425	489
	12	540	600	756	377	1,36	15,00	10,68	-	437	503
	12	540	900	1104	551	1,36	21,48	15,00	-	488	561
367 063 030 XX YY 00	14	630	300	462	234	1,33	9,80	7,42	-	461	530
	14	630	400	602	301	1,36	12,32	9,10	-	471	542
	14	630	500	742	301	1,36	14,84	10,78	-	483	555
	14	630	600	882	440	1,36	17,50	12,46	-	493	567
	14	630	900	1288	643	1,36	25,06	17,50	-	549	631
367 072 030 XX YY 00	16	720	300	528	268	1,33	11,20	8,48	-	524	603
	16	720	400	688	343	1,36	14,08	10,40	-	535	615
	16	720	500	848	343	1,36	16,96	12,32	-	545	627
	16	720	600	1008	503	1,36	20,00	14,24	-	557	641
	16	720	900	1472	735	1,36	28,64	20,00	-	623	716
367 081 030 XX YY 00	18	810	300	594	301	1,33	12,60	9,54	-	586	674
	18	810	400	774	386	1,36	15,84	11,70	-	598	688
	18	810	500	954	386	1,36	19,08	13,86	-	608	699
	18	810	600	1134	566	1,36	22,50	16,02	-	620	713
	18	810	900	1656	827	1,36	32,22	22,50	-	689	792
367 090 030 XX YY 00	20	900	300	660	335	1,33	14,00	10,60	-	647	744
	20	900	400	860	429	1,36	17,60	13,00	-	657	756
	20	900	500	1060	429	1,36	21,20	15,40	-	669	769
	20	900	600	1260	629	1,36	25,00	17,80	-	679	781
	20	900	900	1840	919	1,36	35,80	25,00	-	757	871
367 099 030 XX YY 00	22	990	300	726	368	1,33	15,40	11,66	-	686	789
	22	990	400	946	472	1,36	19,36	14,30	-	696	800
	22	990	500	1166	472	1,36	23,32	16,94	-	707	813
	22	990	600	1386	692	1,36	27,50	19,58	-	718	826
	22	990	900	2024	1010	1,36	39,38	27,50	-	789	907
367 108 030 XX YY 00	24	1080	300	792	401	1,33	16,80	12,72	-	723	831
	24	1080	400	1032	515	1,36	21,12	15,60	-	735	845
	24	1080	500	1272	515	1,36	25,44	18,48	-	745	857
	24	1080	600	1512	755	1,36	30,00	21,36	-	757	871
	24	1080	900	2208	1102	1,36	42,96	30,00	-	847	974

Conform EN442-1: 2014: radiatoren en convectoren

Voor meer details over onze artikel-data, zie artikel-database: <https://www.installdata.be>  
Voor de warmteafgiftes van andere regimes, kijkt u op p. 370 (correctiefactoren)  
BELGIË. Prijzen in euro (excl. BTW)

# RITMO HORIZONTAAL (3-KOLOM)

## HOE RITMO HORIZONTAAL BESTELLEN

Leveringstermijn 15 - 30 werkdagen  
(zonder transportduur)

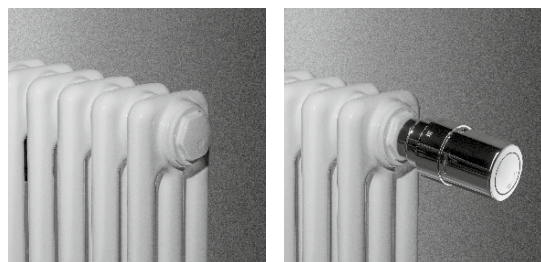

RITMO HB-3K/105  
(3-KOLOM) 4-AANSLUITINGEN

RITMO HB-3K/105  
(3-KOLOM) GEÏNTEGREERD VENTIEL  
(thermostaatkop apart te bestellen)



### PRIJSGROEP: VPG5 - KOLOMRADIATOREN

BESTELCODE MAATWERK RITMO HORIZONTAAL	TECHNISCHE GEGEVENS									STANDAARDKLEUR	ANDERE KLEUREN
	buizen	breedte (L mm)	hoogte (H mm)	75/65/20 (Watt) (Ø50K)	55/45/20 (Watt) (Ø30K)	n-exp.	gewicht (kg)	inhoud (l)	el. weerst. (Watt)	prijs RAL 9016 (€)	prijs kleur (€)
<b>REF. NR. RITMO HORIZONTAAL HB-3K/105 : 367</b>											
<b>367</b>	<b>117</b>	<b>030</b>	<b>XX</b>	<b>YY</b>	<b>00</b>						
		<b>040</b>								<b>787</b>	<b>905</b>
		<b>050</b>								<b>798</b>	<b>918</b>
		<b>060</b>								<b>809</b>	<b>930</b>
		<b>090</b>								<b>820</b>	<b>943</b>
										<b>959</b>	<b>1103</b>
<b>367</b>	<b>126</b>	<b>030</b>	<b>XX</b>	<b>YY</b>	<b>00</b>						
		<b>040</b>								<b>844</b>	<b>971</b>
		<b>050</b>								<b>855</b>	<b>983</b>
		<b>060</b>								<b>866</b>	<b>996</b>
		<b>090</b>								<b>877</b>	<b>1009</b>
										<b>1030</b>	<b>1185</b>
<b>367</b>	<b>135</b>	<b>030</b>	<b>XX</b>	<b>YY</b>	<b>00</b>						
		<b>040</b>								<b>903</b>	<b>1038</b>
		<b>050</b>								<b>914</b>	<b>1051</b>
		<b>060</b>								<b>925</b>	<b>1064</b>
		<b>090</b>								<b>936</b>	<b>1076</b>
										<b>1096</b>	<b>1260</b>
<b>367</b>	<b>144</b>	<b>030</b>	<b>XX</b>	<b>YY</b>	<b>00</b>						
		<b>040</b>								<b>961</b>	<b>1105</b>
		<b>050</b>								<b>972</b>	<b>1118</b>
		<b>060</b>								<b>983</b>	<b>1130</b>
		<b>090</b>								<b>994</b>	<b>1143</b>
										<b>1162</b>	<b>1336</b>
<b>367</b>	<b>153</b>	<b>030</b>	<b>XX</b>	<b>YY</b>	<b>00</b>						
		<b>040</b>								<b>1020</b>	<b>1173</b>
		<b>050</b>								<b>1030</b>	<b>1185</b>
		<b>060</b>								<b>1042</b>	<b>1198</b>
		<b>090</b>								<b>1052</b>	<b>1210</b>
										<b>1238</b>	<b>1424</b>
<b>367</b>	<b>162</b>	<b>030</b>	<b>XX</b>	<b>YY</b>	<b>00</b>						
		<b>040</b>								<b>1075</b>	<b>1236</b>
		<b>050</b>								<b>1087</b>	<b>1250</b>
		<b>060</b>								<b>1097</b>	<b>1262</b>
		<b>090</b>								<b>1109</b>	<b>1275</b>
										<b>1316</b>	<b>1513</b>
<b>367</b>	<b>171</b>	<b>030</b>	<b>XX</b>	<b>YY</b>	<b>00</b>						
		<b>040</b>								<b>1140</b>	<b>1311</b>
		<b>050</b>								<b>1151</b>	<b>1324</b>
		<b>060</b>								<b>1162</b>	<b>1336</b>
		<b>090</b>								<b>1172</b>	<b>1348</b>
										<b>1381</b>	<b>1588</b>
<b>367</b>	<b>180</b>	<b>030</b>	<b>XX</b>	<b>YY</b>	<b>00</b>						
		<b>040</b>								<b>1211</b>	<b>1393</b>
		<b>050</b>								<b>1223</b>	<b>1406</b>
		<b>060</b>								<b>1233</b>	<b>1418</b>
		<b>090</b>								<b>1245</b>	<b>1432</b>
										<b>1463</b>	<b>1682</b>

Conform EN442-1: 2014: radiatoren en convectoren

Voor meer details over onze artikel-data, zie artikel-database: <https://www.installdata.be>  
Voor de warmteafgiftes van andere regimes, kijkt u op p. 370 (correctiefactoren)  
BELGIË. Prijzen in euro (excl. BTW)

## HOE RITMO HORIZONTAAL BESTELLEN

Leveringstermijn 15 - 30 werkdagen  
(zonder transportduur)

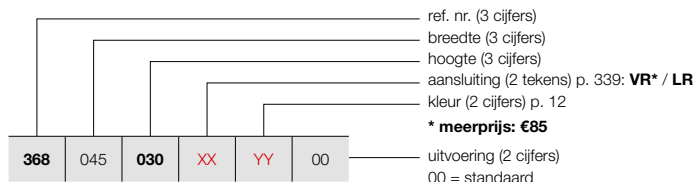

## RITMO HORIZONTAAL (4-KOLOM)

333



RITMO HB-4K/145  
(4-KOLOM) 4-AANSLUITINGEN



RITMO HB-4K/145  
(4-KOLOM) GEÏNTEGREERD VENTIEL  
(thermostaatkop apart te bestellen)

### PRIJSGROEP: VPG5 - KOLOMRADIATOREN

BESTELCODE MAATWERK RITMO HORIZONTAAL	TECHNISCHE GEGEVENS							STANDAARDKLEUR		ANDERE KLEUREN	
	buizen	breedte (L mm)	hoogte (H mm)	75/65/20 (Watt) (φ50K)	55/45/20 (Watt) (φ30K)	n-exp.	gewicht (kg)	inhoud (l)	el. weerst. (Watt)	prijs RAL 9016 (€)	prijs kleur (€)
<b>REF. NR. RITMO HORIZONTAAL HB-4K/145 : 368</b>											
368 045 030 XX YY 00	040	450	300	430	218	1,33	9,30	6,90	-	409	470
	050	450	400	560	281	1,35	11,80	8,50	-	420	483
	060	450	500	690	346	1,35	14,20	10,10	-	431	496
	090	450	600	810	406	1,35	16,60	11,70	-	442	508
		450	900	1170	587	1,35	23,90	16,50	-	510	587
368 054 030 XX YY 00	040	540	300	516	262	1,33	11,16	8,28	-	466	536
	050	540	400	672	337	1,35	14,16	10,20	-	477	549
	060	540	500	828	415	1,35	17,04	12,12	-	488	561
	090	540	600	972	488	1,35	19,92	14,04	-	498	573
		540	900	1404	704	1,35	28,68	19,80	-	591	680
368 063 030 XX YY 00	040	630	300	602	305	1,33	13,02	9,66	-	527	606
	050	630	400	784	393	1,35	16,52	11,90	-	537	618
	060	630	500	966	485	1,35	19,88	14,14	-	549	631
	090	630	600	1134	569	1,35	23,24	16,38	-	559	643
		630	900	1638	822	1,35	33,46	23,10	-	707	813
368 072 030 XX YY 00	040	720	300	688	349	1,33	14,88	11,04	-	581	668
	050	720	400	896	450	1,35	18,88	13,60	-	591	680
	060	720	500	1104	554	1,35	22,72	16,16	-	603	693
	090	720	600	1296	650	1,35	26,56	18,72	-	613	705
		720	900	1872	939	1,35	38,24	26,40	-	806	927
368 081 030 XX YY 00	040	810	300	774	392	1,33	16,74	12,42	-	657	756
	050	810	400	1008	506	1,35	21,24	15,30	-	669	769
	060	810	500	1242	623	1,35	25,56	18,18	-	679	781
	090	810	600	1458	732	1,35	29,88	21,06	-	691	795
		810	900	2106	1057	1,35	43,02	29,70	-	904	1040
368 090 030 XX YY 00	040	900	300	860	436	1,33	18,60	13,80	-	757	871
	050	900	400	1120	562	1,35	23,60	17,00	-	767	882
	060	900	500	1380	692	1,35	28,40	20,20	-	779	896
	090	900	600	1620	813	1,35	33,20	23,40	-	789	907
		900	900	2340	1174	1,35	47,80	33,00	-	1003	1153
368 099 030 XX YY 00	040	990	300	946	480	1,33	20,46	15,18	-	789	907
	050	990	400	1232	618	1,35	25,96	18,70	-	800	920
	060	990	500	1518	762	1,35	31,24	22,22	-	811	933
	090	990	600	1782	894	1,35	36,52	25,74	-	822	945
		990	900	2574	1292	1,35	52,58	36,30	-	1058	1217
368 108 030 XX YY 00	040	1080	300	1032	523	1,33	22,32	16,56	-	822	945
	050	1080	400	1344	674	1,35	28,32	20,40	-	833	958
	060	1080	500	1656	831	1,35	34,08	24,24	-	844	971
	090	1080	600	1944	975	1,35	39,84	28,08	-	855	983
		1080	900	2808	1409	1,35	57,36	39,60	-	1107	1273

Conform EN442-1: 2014: radiatoren en convectoren

Voor meer details over onze artikel-data, zie artikel-database: <https://www.installdata.be>  
Voor de warmteafgiftes van andere regimes, kijkt u op p. 370 (correctiefactoren)  
BELGIË. Prijzen in euro (excl. BTW)

# RITMO HORIZONTAAL (4-KOLOM)

## HOE RITMO HORIZONTAAL BESTELLEN

Leveringstermijn 15 - 30 werkdagen  
(zonder transportduur)

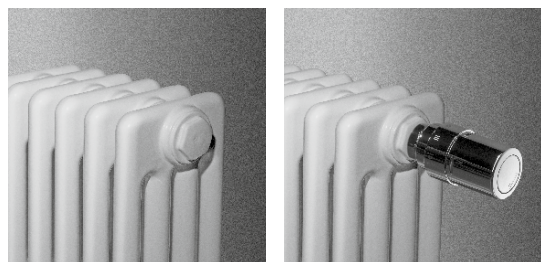

RITMO HB-4K/145  
(4-KOLOM) 4-AANSLUITINGEN

RITMO HB-4K/145  
(4-KOLOM) GEÏNTEGREERD VENTIEL  
(thermostaatkop apart te bestellen)

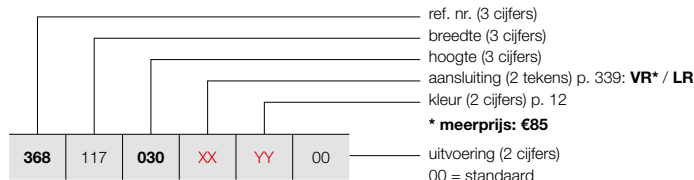



### PRIJSGROEP: VPG5 - KOLOMRADIATOREN

BESTELCODE MAATWERK RITMO HORIZONTAAL	TECHNISCHE GEGEVENS									STANDAARDKLEUR	ANDERE KLEUREN
	buizen	breedte (L mm)	hoogte (H mm)	75/65/20 (Watt) (Ø50K)	55/45/20 (Watt) (Ø30K)	n-exp.	gewicht (kg)	inhoud (l)	el. weerst. (Watt)	prijs RAL 9016 (€)	prijs kleur (€)
<b>REF. NR. RITMO HORIZONTAAL HB-4K/145 : 368</b>											
<b>368</b>	<b>117</b>	<b>030</b>	<b>XX</b>	<b>YY</b>	<b>00</b>						
		<b>040</b>								<b>965</b>	<b>1110</b>
		<b>050</b>								<b>976</b>	<b>1122</b>
		<b>060</b>								<b>986</b>	<b>1134</b>
		<b>090</b>								<b>998</b>	<b>1148</b>
										<b>1282</b>	<b>1474</b>
<b>368</b>	<b>126</b>	<b>030</b>	<b>XX</b>	<b>YY</b>	<b>00</b>						
		<b>040</b>								<b>1036</b>	<b>1191</b>
		<b>050</b>								<b>1047</b>	<b>1204</b>
		<b>060</b>								<b>1058</b>	<b>1217</b>
		<b>090</b>								<b>1069</b>	<b>1229</b>
										<b>1354</b>	<b>1557</b>
<b>368</b>	<b>135</b>	<b>030</b>	<b>XX</b>	<b>YY</b>	<b>00</b>						
		<b>040</b>								<b>1096</b>	<b>1260</b>
		<b>050</b>								<b>1107</b>	<b>1273</b>
		<b>060</b>								<b>1118</b>	<b>1286</b>
		<b>090</b>								<b>1129</b>	<b>1298</b>
										<b>1414</b>	<b>1626</b>
<b>368</b>	<b>144</b>	<b>030</b>	<b>XX</b>	<b>YY</b>	<b>00</b>						
		<b>040</b>								<b>1172</b>	<b>1348</b>
		<b>050</b>								<b>1184</b>	<b>1362</b>
		<b>060</b>								<b>1194</b>	<b>1373</b>
		<b>090</b>								<b>1206</b>	<b>1387</b>
										<b>1491</b>	<b>1715</b>
<b>368</b>	<b>153</b>	<b>030</b>	<b>XX</b>	<b>YY</b>	<b>00</b>						
		<b>040</b>								<b>1245</b>	<b>1432</b>
		<b>050</b>								<b>1255</b>	<b>1443</b>
		<b>060</b>								<b>1267</b>	<b>1457</b>
		<b>090</b>								<b>1277</b>	<b>1469</b>
										<b>1568</b>	<b>1803</b>
<b>368</b>	<b>162</b>	<b>030</b>	<b>XX</b>	<b>YY</b>	<b>00</b>						
		<b>040</b>								<b>1324</b>	<b>1523</b>
		<b>050</b>								<b>1336</b>	<b>1536</b>
		<b>060</b>								<b>1346</b>	<b>1548</b>
		<b>090</b>								<b>1357</b>	<b>1561</b>
										<b>1650</b>	<b>1898</b>
<b>368</b>	<b>171</b>	<b>030</b>	<b>XX</b>	<b>YY</b>	<b>00</b>						
		<b>040</b>								<b>1387</b>	<b>1595</b>
		<b>050</b>								<b>1397</b>	<b>1607</b>
		<b>060</b>								<b>1409</b>	<b>1620</b>
		<b>090</b>								<b>1419</b>	<b>1632</b>
										<b>1704</b>	<b>1960</b>
<b>368</b>	<b>180</b>	<b>030</b>	<b>XX</b>	<b>YY</b>	<b>00</b>						
		<b>040</b>								<b>1435</b>	<b>1650</b>
		<b>050</b>								<b>1446</b>	<b>1663</b>
		<b>060</b>								<b>1457</b>	<b>1676</b>
		<b>090</b>								<b>1468</b>	<b>1688</b>
										<b>1764</b>	<b>2029</b>

Conform EN442-1: 2014: radiatoren en convectoren

Voor meer details over onze artikel-data, zie artikel-database: <https://www.installdata.be>  
Voor de warmteafgiftes van andere regimes, kijkt u op p. 370 (correctiefactoren)  
BELGIË. Prijzen in euro (excl. BTW)

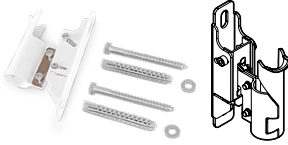
PRIJSGROEP: VPG10 - ACC.

BEVESTIGINGEN		KLEUR	ART. NR.	€
<b>KLEMCONSOLE VARIABEL</b>				
<b>KLEMCONSOLE VARIABEL</b> 	<b>RITMO VERTICAAL / RITMO HORIZONTAAL</b>			
	35 - 45 mm	RAL 9016	11872120000	<b>35</b>
		KLEUR	11872120000C	<b>40</b>
	45 - 60 mm	RAL 9016	11872130000	<b>40</b>
		KLEUR	11872130000C	<b>53</b>
<ul style="list-style-type: none"> <li>Wandafstand: 35 - 45 mm of 45 - 60 mm</li> </ul>				
<b>AFSTANDHOUDER</b>				
	<b>RITMO VERTICAAL / RITMO HORIZONTAAL</b>			
		RAL 9016	1187 209 0000 9016	<b>13</b>
	RAL 7024	1187 209 0000 7024	<b>14</b>	

hoogte (H mm)	2-kolom / 3-kolom / 4-kolom		
	300 - 900	1500 - 2200	
aantal buizen (n)	10 - 28	30 - 40	6 - 16
klemconsole variabel 35 - 45 mm	2x	3x	2x
klemconsole variabel 45 - 60 mm	2x	3x	2x
afstandhouder	2x	3x	2x

**HOE BESTELLEN**



- Kies de gewenste klemconsole in bovenstaande tabel.
- Afstandhouders dienen apart mee besteld te worden.

**BELGIË. Prijzen in euro (excl. BTW)**

# RITMO VRIJSTAANDE OPSTELLING

## IN OPTIE

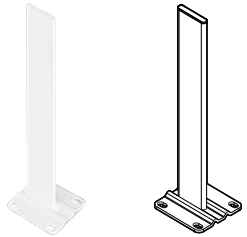
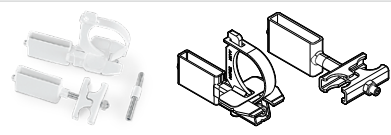

PRIJSGROEP: VPG10 - ACC.

VRIJSTAANDE OPSTELLING	HOOGTE VOET	KLEUR	ART. NR.	€
<b>STANDVOET VRIJSTAANDE OPSTELLING</b> 	<b>RITMO HORIZONTAAL</b>			
	H = 450 mm	RAL 9016	11810350450	<b>65</b>
		KLEUR	11810350450C	<b>75</b>
	H = 550 mm	RAL 9016	11810350550	<b>65</b>
		KLEUR	11810350550C	<b>75</b>
	H = 600 mm	RAL 9016	11810350600	<b>65</b>
		KLEUR	11810350600C	<b>75</b>
	H = 650 mm	RAL 9016	11810350650	<b>65</b>
		KLEUR	11810350650C	<b>75</b>
	H = 750 mm	RAL 9016	11810350750	<b>65</b>
		KLEUR	11810350750C	<b>75</b>
	H = 850 mm	RAL 9016	11810350850	<b>81</b>
		KLEUR	11810350850C	<b>92</b>
H = 900 mm	RAL 9016	11810350900	<b>81</b>	
	KLEUR	11810350900C	<b>92</b>	
H = 1050 mm	RAL 9016	11810351050	<b>81</b>	
	KLEUR	11810351050C	<b>92</b>	
H = 1200 mm	RAL 9016	11810351200	<b>81</b>	
	KLEUR	11810351200C	<b>92</b>	
<ul style="list-style-type: none"> <li>Afgewerkte vloer: hoogte voet = hoogte radiator + 150 mm</li> <li>Chape: hoogte voet = hoogte radiator + 300 mm</li> <li>Zelf in te korten indien nodig</li> </ul>				
<b>BEVESTIGING STANDVOET VRIJSTAANDE OPSTELLING</b> 	<b>RITMO HORIZONTAAL</b>			
		RAL 9016	11810290000	<b>85</b>
		KLEUR	11810290000C	<b>97</b>
<b>AFDEKROZET STANDVOET CHAPE</b> 	<b>RITMO HORIZONTAAL</b>			
		RAL 9016	11810370000	<b>14</b>
		KLEUR	11810370000C	<b>16</b>
<ul style="list-style-type: none"> <li>100 x 40 mm. Aantal rozetten = aantal standvoeten</li> </ul>				
<b>AFDEKROZET STANDVOET AFGEWERKTE VLOER</b> 	<b>RITMO HORIZONTAAL</b>			
		RAL 9016	11810380000	<b>17</b>
		KLEUR	11810380000C	<b>19</b>
<ul style="list-style-type: none"> <li>115 x 110 mm. Aantal rozetten = aantal standvoeten</li> </ul>				

hoogte (H mm)	2-kolom / 3-kolom / 4-kolom	
	300 – 900	
aantal buizen (n)	10 – 26	28 – 40
standvoet	2x	3x

**BELGIË. Prijzen in euro (excl. BTW)**

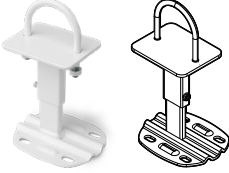
PRIJSGROEP: VPG10 - ACC.



		KLEUR	ART. NR.	€
<b>TELESCOPISCHE ONDERSTEUNVOET</b>  <ul style="list-style-type: none"> <li>• Hoogte: min. 200 mm, max. 230 mm</li> <li>• Telescopische ondersteunvoet steeds in combinatie met de wand- en klemconsoles</li> </ul>	<b>RITMO VERTICAAL / RITMO HORIZONTAAL</b>			
		RAL 9016	11810300000	<b>75</b>
		KLEUR	11810300000C	<b>86</b>
<b>AFDEKROZET ONDERSTEUNVOET CHAPE</b>  <ul style="list-style-type: none"> <li>• 70 x 40 mm. Aantal rozetten = aantal standvoeten</li> </ul>	<b>RITMO VERTICAAL / RITMO HORIZONTAAL</b>			
		RAL 9016	1181 032 0000 9016	<b>13</b>
<b>AFDEKROZET ONDERSTEUNVOET AFGEWERKTE VLOER</b>  <ul style="list-style-type: none"> <li>• 130 x 110 mm. Aantal rozetten = aantal standvoeten</li> </ul>	<b>RITMO VERTICAAL / RITMO HORIZONTAAL</b>			
		RAL 9016	1181 031 0000 9016	<b>17</b>

hoogte (H mm)	2-kolom / 3-kolom					4-kolom				
	300 – 600		900 – 2000		2200	300 – 600		900 – 2000		2200
aantal buizen (n)	10 – 24	26 – 40	6 – 24	26 – 40	6 – 16	10 – 24	26 – 40	6 – 24	26 – 40	6 – 16
telescopische ondersteunvoet	2x	3x	2x	3x	2x	2x	3x	2x	3x	3x

**BELGIË. Prijzen in euro (excl. BTW)**

**RITMO ACCESSOIRES**  
 IN OPTIE

PRIJSGROEP: VPG10 - ACC.

ACCESSOIRES		KLEUR	ART. NR.	€
		<b>RITMO HORIZONTAAL</b>		
THERMOSTAATKOP		WIT	11911630102	<b>48</b>
		<b>RITMO HORIZONTAAL</b>		
THERMOSTAATKOP		CHROOM	11911631102	<b>65</b>

PRIJSGROEP: VPG10B - HANDDOEKBEUGELS

ACCESSOIRES		KLEUR	ART. NR.	€
		<b>RITMO VERTICAAL / RITMO HORIZONTAAL</b>		
HANDDOEKBEUGEL		CHROOM	11832650000099	<b>149</b>

- b = 1000 mm (zelf in te korten)

Montagevoorschriften accessoires: zie [www.vasco.eu](http://www.vasco.eu)  
 BELGIË. Prijzen in euro (excl. BTW)

uit voorraad leverbaar

## RITMO: VERTICAAL

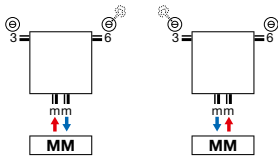

- Ontluchter in aansluiting 3 of 6.

## RITMO: HORIZONTAAL

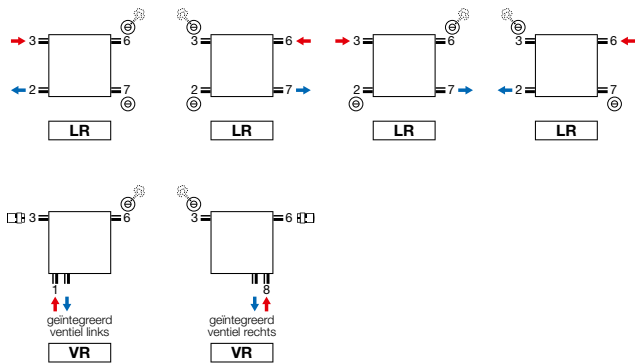

- Ontluchter in aansluiting 3 of 6.
- Geïntegreerd ventiel (aansluiting VR) (meerprijs: €85) (thermostaatkop apart te bestellen, zie p. 338). Plaatsing thermostaatkop links, door spiegelen van radiator.  
Opgelet: de aanvoer is aan de buitenkant van de radiator!

**Opmerking:** het aansluiten van de radiator kan enkel volgens de getoonde aansluiticonen. Voor elke andere aansluitwijze nemen wij geen verantwoordelijkheid.

**RITMO VERTICAAL**

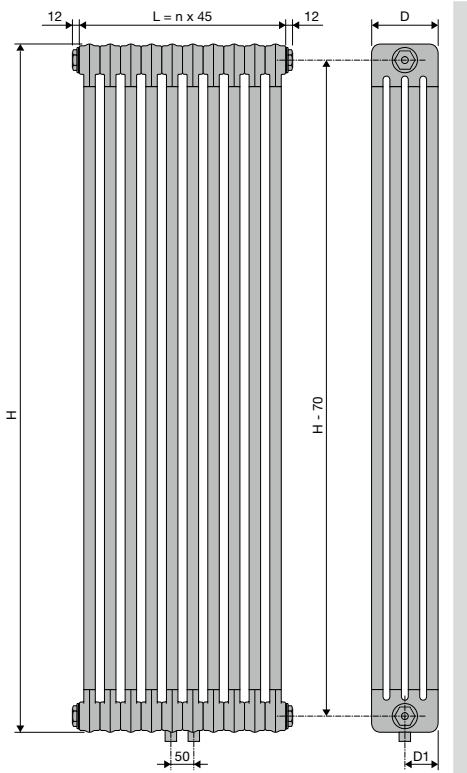

	<b>VB-2K/65 / VB-3K/105 / VB-4K/145</b>					
	H	1500	1800	2000	2200	
Diepte (D)	65	105	145			
D1	32,5	52,5	72,5			
Aantal leden (n)	6	8	10	12	14	16

**RITMO HORIZONTAAL**

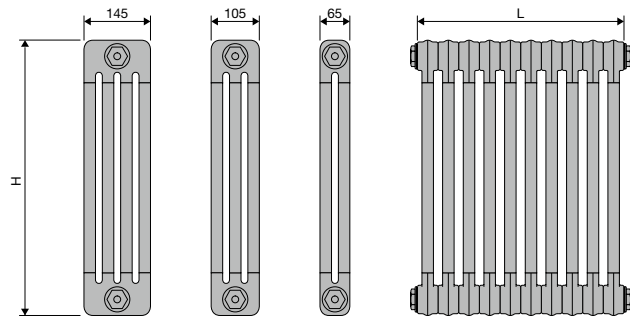
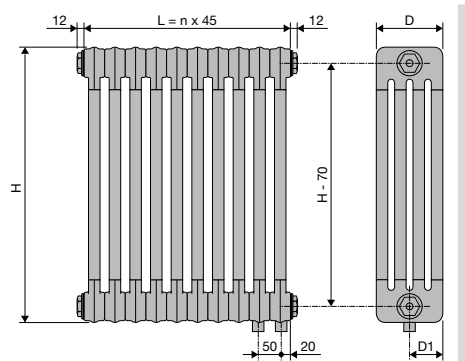
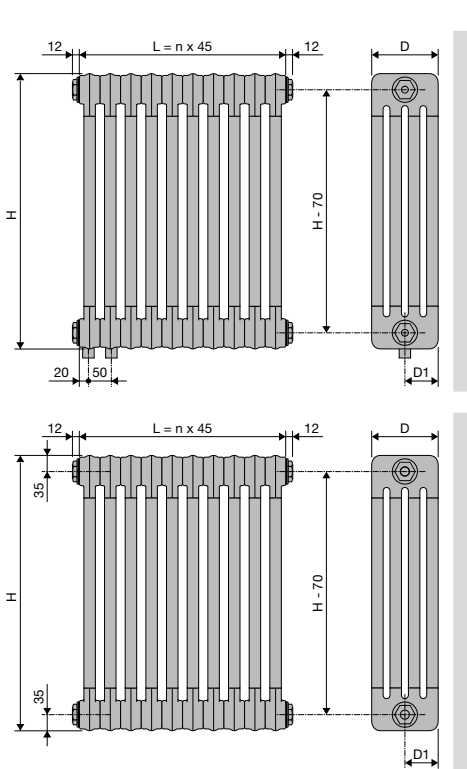

	<b>HB-2K/65 / HB-3K/105 / HB-4K/145</b>															
	H	300	400	500	600	900										
Diepte (D)	65	105	145													
D1	32,5	52,5	72,5													
Aantal leden (n)	10	12	14	16	18	20	22	24	26	28	30	32	34	36	38	40



KOLOMRADIATOREN

## VINTAGE (VINTAGE 50)



### TYPES

- Vintage 50: afstand tussen de leden 50 mm
- 4 dieptes (D110, D160, D220, D250)

### KLEUREN

- Standaardkleur S600 (witte fijn structuurlak) (RAL 9016: geen meerprijs 15%)
- Verkrijgbaar in transparante coating (kleurcode 57)
- **Opgelet: een radiator in transparante coating niet in vochtige ruimtes plaatsen!**
- Uitgebreide kleurenkaart zie p. 12

### SPECIAAL

- Vloer- of wandmontage

### BEVESTIGINGEN

- Standaard wandbevestigingen of ledenvoeten, 1/2" blindstop, 1/2" ontluchter
- Bevestigingen in de kleur van de radiator (aantal afhankelijk van de lengte van de radiator)
- De voeten en bevestigingen van radiatoren in transparante coating zijn gelakt in de kleur N507.

### TECHNISCH

- ATL-grondlaag, epoxy-polyester poedercoating
- Standaardwerkdruk: 5 bar
- Maximale bedrijfstemperatuur: 110°C

### TECHNISCHE TEKENINGEN

- Zie p. 358

### AANSLUITING

- 4x 1/2" (SL, SR, 26, 37)
- Ontluchter in aansluiting 3 of 6
- Aansluitingen: 1/2" (binnendraad)
- Aansluiting 27, 72: **meerprijs €75**

## VINTAGE

### Vroeger is weer helemaal van nu

Terug naar de 'oerradiator'. Erg populair omwille van de tot de verbeelding sprekende, authentieke look. Standaard aangeboden in een witte uitvoering, maar ook verkrijgbaar met een transparante coating voor een nog meer uitgesproken vintage look. De Vintage staat borg voor een zeer hoge warmteafgifte. Ideaal voor de verwarming van grote, hoge ruimten, ook in combinatie met energiezuinige technologieën. Een designradiator die als geen andere tot zijn recht komt in een retro-interieur en zich graag voor een raam laat plaatsen.

### AANBEVOLEN AANSLUITING (LR)

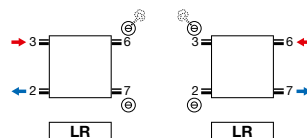

Andere aansluitmogelijkheden, zie p. 357



# HOE VINTAGE 50 BESTELLEN

Leveringstermijn 15 - 30 werkdagen  
(zonder transportduur)

# VINTAGE (VINTAGE 50 / D110)

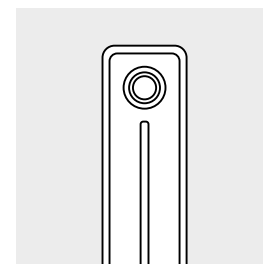
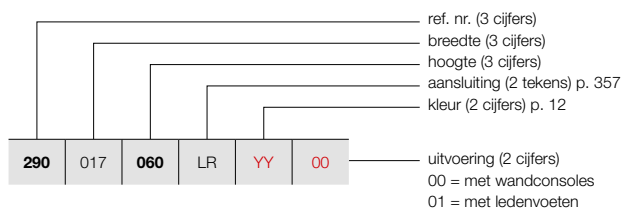

VINTAGE 50 / D110

## PRIJSGROEP: VPG5 - KOLOMRADIATOREN

BESTELCODE MAATWERK VINTAGE 50	TECHNISCHE GEGEVENS									STANDAARDKLEUR	ANDERE KLEUREN
	buizen	breedte (L mm)	hoogte (H mm)	75/65/20 (Watt) (Φ50K)	55/45/20 (Watt) (Φ30K)	n-exp.	gewicht (kg)	inhoud (l)	el. weerst. (Watt)		
<b>REF. NR. VINTAGE 50 VINTAGE 50/D110 : 290</b>											
290 017 060 LR YY 00	3	178	600	165	87	1,25	4,17	2,49	-	402	462
	3	178	1000	252	131	1,28	6,57	3,39	-	431	496
290 022 060 LR YY 00	4	228	600	220	116	1,25	5,56	3,32	-	424	488
	4	228	1000	336	175	1,28	8,76	4,52	-	460	529
290 027 060 LR YY 00	5	278	600	275	145	1,25	6,95	4,15	-	444	511
	5	278	1000	420	218	1,28	10,95	5,65	-	489	562
290 032 060 LR YY 00	6	328	600	330	174	1,25	8,34	4,98	-	467	537
	6	328	1000	504	262	1,28	13,14	6,78	-	516	593
290 037 060 LR YY 00	7	378	600	385	203	1,25	9,73	5,81	-	484	557
	7	378	1000	588	306	1,28	15,33	7,91	-	544	626
290 042 060 LR YY 00	8	428	600	440	232	1,25	11,12	6,64	-	514	591
	8	428	1000	672	349	1,28	17,52	9,04	-	578	665
290 047 060 LR YY 00	9	478	600	495	261	1,25	12,51	7,47	-	530	610
	9	478	1000	756	393	1,28	19,71	10,17	-	607	698
290 052 060 LR YY 00	10	528	600	550	290	1,25	13,90	8,30	-	556	639
	10	528	1000	840	437	1,28	21,90	11,30	-	633	728
290 057 060 LR YY 00	11	578	600	605	319	1,25	15,29	9,13	-	577	664
	11	578	1000	924	481	1,28	24,09	12,43	-	669	769
290 062 060 LR YY 00	12	628	600	660	349	1,25	16,68	9,96	-	598	688
	12	628	1000	1008	524	1,28	26,28	13,56	-	696	800
290 067 060 LR YY 00	13	678	600	715	378	1,25	18,07	10,79	-	619	712
	13	678	1000	1092	568	1,28	28,47	14,69	-	725	834
290 072 060 LR YY 00	14	728	600	770	407	1,25	19,46	11,62	-	636	731
	14	728	1000	1176	612	1,28	30,66	15,82	-	753	866
290 077 060 LR YY 00	15	778	600	825	436	1,25	20,85	12,45	-	654	752
	15	778	1000	1260	655	1,28	32,85	16,95	-	781	898
290 082 060 LR YY 00	16	828	600	880	465	1,25	22,24	13,28	-	676	777
	16	828	1000	1344	699	1,28	35,04	18,08	-	808	929
290 087 060 LR YY 00	17	878	600	935	494	1,25	23,63	14,11	-	696	800
	17	878	1000	1428	743	1,28	37,23	19,21	-	833	958
290 092 060 LR YY 00	18	928	600	990	523	1,25	25,02	14,94	-	717	825
	18	928	1000	1512	786	1,28	39,42	20,34	-	864	994
290 097 060 LR YY 00	19	978	600	1045	552	1,25	26,41	15,77	-	735	845
	19	978	1000	1596	830	1,28	41,61	21,47	-	892	1026

Conform EN442-1: 2014: radiatoren en convectoren

\* RAL 9016: geen meerprijs 15%  
 Voor meer details over onze artikel-data, zie artikel-database: <https://www.installdata.be>  
**Voor de warmteafgiftes van andere regimes, kijkt u op p. 370 (correctiefactoren)**  
**BELGIË. Prijzen in euro (excl. BTW)**

# VINTAGE (VINTAGE 50 / D110)

**HOE VINTAGE 50 BESTELLEN**  
 Leveringstermijn 15 - 30 werkdagen  
 (zonder transportduur)

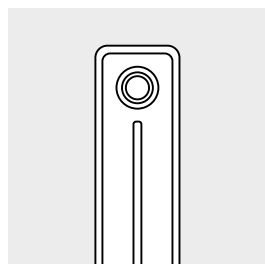

VINTAGE 50 / D110

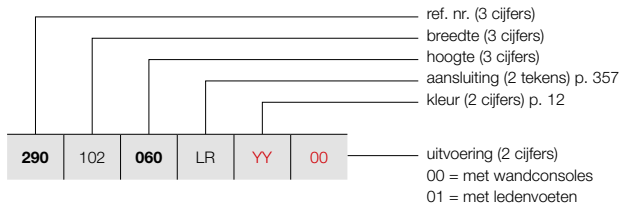

**PRIJSGROEP: VPG5 - KOLOMRADIATOREN**

BESTELCODE MAATWERK VINTAGE 50	TECHNISCHE GEGEVENS									STANDAARDKLEUR	ANDERE KLEUREN
	buizen	breedte (L mm)	hoogte (H mm)	75/65/20 (Watt) (Φ50K)	55/45/20 (Watt) (Φ30K)	n-exp.	gewicht (kg)	inhoud (l)	el. weerst. (Watt)	prijs S600* (€)	prijs kleur (€)
<b>REF. NR. VINTAGE 50 VINTAGE 50/D110 : 290</b>											
290 102 060 LR YY 00	20	1028	600	1100	581	1,25	27,80	16,60	-	756	869
	20	1028	1000	1680	874	1,28	43,80	22,60	-	918	1056
290 107 060 LR YY 00	21	1078	600	1155	610	1,25	29,19	17,43	-	792	911
	21	1078	1000	1764	917	1,28	45,99	23,73	-	963	1107
290 112 060 LR YY 00	22	1128	600	1210	639	1,25	30,58	18,26	-	809	930
	22	1128	1000	1848	961	1,28	48,18	24,86	-	989	1137
290 117 060 LR YY 00	23	1178	600	1265	668	1,25	31,97	19,09	-	830	955
	23	1178	1000	1932	1005	1,28	50,37	25,99	-	1013	1165
290 122 060 LR YY 00	24	1228	600	1320	697	1,25	33,36	19,92	-	847	974
	24	1228	1000	2016	1048	1,28	52,56	27,12	-	1045	1202
290 127 060 LR YY 00	25	1278	600	1375	726	1,25	34,75	20,75	-	869	999
	25	1278	1000	2100	1092	1,28	54,75	28,25	-	1071	1232
290 132 060 LR YY 00	26	1328	600	1430	755	1,25	36,14	21,58	-	905	1041
	26	1328	1000	2184	1136	1,28	56,94	29,38	-	1115	1282
290 137 060 LR YY 00	27	1378	600	1485	784	1,25	37,53	22,41	-	923	1061
	27	1378	1000	2268	1179	1,28	59,13	30,51	-	1145	1317
290 142 060 LR YY 00	28	1428	600	1540	813	1,25	38,92	23,24	-	946	1088
	28	1428	1000	2352	1223	1,28	61,32	31,64	-	1170	1346
290 147 060 LR YY 00	29	1478	600	1595	842	1,25	40,31	24,07	-	966	1111
	29	1478	1000	2436	1267	1,28	63,51	32,77	-	1199	1379
290 152 060 LR YY 00	30	1528	600	1650	871	1,25	41,70	24,90	-	983	1130
	30	1528	1000	2520	1310	1,28	65,70	33,90	-	1228	1412
290 157 060 LR YY 00	31	1578	600	1705	900	1,25	43,09	25,73	-	1005	1156
	31	1578	1000	2604	1354	1,28	67,89	35,03	-	1260	1449
290 162 060 LR YY 00	32	1628	600	1760	929	1,25	44,48	26,56	-	1023	1176
	32	1628	1000	2688	1398	1,28	70,08	36,16	-	1291	1485
290 167 060 LR YY 00	33	1678	600	1815	958	1,25	45,87	27,39	-	1086	1249
	33	1678	1000	2772	1442	1,28	72,27	37,29	-	1362	1566
290 172 060 LR YY 00	34	1728	600	1870	987	1,25	47,26	28,22	-	1107	1273
	34	1728	1000	2856	1485	1,28	74,46	38,42	-	1388	1596
290 177 060 LR YY 00	35	1778	600	1925	1017	1,25	48,65	29,05	-	1128	1297
	35	1778	1000	2940	1529	1,28	76,65	39,55	-	1416	1628
290 182 060 LR YY 00	36	1828	600	1980	1046	1,25	50,04	29,88	-	1151	1324
	36	1828	1000	3024	1573	1,28	78,84	40,68	-	1441	1657
290 187 060 LR YY 00	37	1878	600	2035	1075	1,25	51,43	30,71	-	1168	1343
	37	1878	1000	3108	1616	1,28	81,03	41,81	-	1471	1692

Conform EN442-1: 2014: radiatoren en convectoren

\* RAL 9016: geen meerprijs 15%  
 Voor meer details over onze artikel-data, zie artikel-database: <https://www.installdata.be>  
**Voor de warmteafgiftes van andere regimes, kijkt u op p. 370 (correctiefactoren)**  
**BELGIË. Prijzen in euro (excl. BTW)**

# HOE VINTAGE 50 BESTELLEN

Leveringstermijn 15 - 30 werkdagen  
(zonder transportduur)

# VINTAGE (VINTAGE 50 / D110)

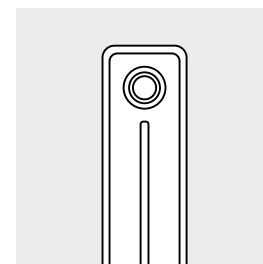
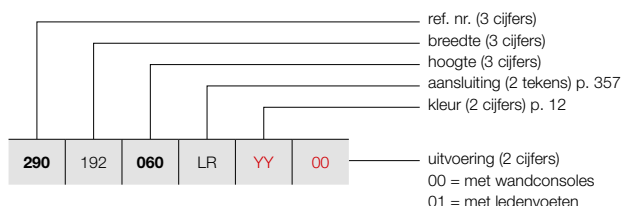

VINTAGE 50 / D110

## PRIJSGROEP: VPG5 - KOLOMRADIATOREN

BESTELCODE MAATWERK VINTAGE 50	TECHNISCHE GEGEVENS							STANDAARDKLEUR	ANDERE KLEUREN		
	buizen	breedte (L mm)	hoogte (H mm)	75/65/20 (Watt) (φ50K)	55/45/20 (Watt) (φ30K)	n-exp.	gewicht (kg)			inhoud (l)	el. weerst. (Watt)
<b>REF. NR. VINTAGE 50 VINTAGE 50/D110 : 290</b>											
290 192 060 LR YY 00	38	1928	600	2090	1104	1,25	52,82	31,54	-	1190	1369
	38	1928	1000	3192	1660	1,28	83,22	42,94	-	1496	1720
290 197 060 LR YY 00	39	1978	600	2145	1133	1,25	54,21	32,37	-	1211	1393
	39	1978	1000	3276	1704	1,28	85,41	44,07	-	1527	1756
290 202 060 LR YY 00	40	2028	600	2200	1162	1,25	55,60	33,20	-	1231	1416
	40	2028	1000	3360	1747	1,28	87,60	45,20	-	1552	1785
290 207 060 LR YY 00	41	2078	600	2255	1191	1,25	56,99	34,03	-	1248	1435
	41	2078	1000	3444	1791	1,28	89,79	46,33	-	1583	1820
290 212 060 LR YY 00	42	2128	600	2310	1220	1,25	58,38	34,86	-	1272	1463
	42	2128	1000	3528	1835	1,28	91,98	47,46	-	1609	1850
290 217 060 LR YY 00	43	2178	600	2365	1249	1,25	59,77	35,69	-	1291	1485
	43	2178	1000	3612	1878	1,28	94,17	48,59	-	1638	1884
290 222 060 LR YY 00	44	2228	600	2420	1278	1,25	61,16	36,52	-	1311	1508
	44	2228	1000	3696	1922	1,28	96,36	49,72	-	1668	1918
290 227 060 LR YY 00	45	2278	600	2475	1307	1,25	62,55	37,35	-	1327	1526
	45	2278	1000	3780	1966	1,28	98,55	50,85	-	1693	1947
290 232 060 LR YY 00	46	2328	600	2530	1336	1,25	63,94	38,18	-	1349	1551
290 237 060 LR YY 00	47	2378	600	2585	1365	1,25	65,33	39,01	-	1367	1572
290 242 060 LR YY 00	48	2428	600	2640	1394	1,25	66,72	39,84	-	1388	1596
290 247 060 LR YY 00	49	2478	600	2695	1423	1,25	68,11	40,67	-	1406	1617
290 252 060 LR YY 00	50	2528	600	2750	1452	1,25	69,50	41,50	-	1431	1646
290 257 060 LR YY 00	51	2578	600	2805	1481	1,25	70,89	42,33	-	1467	1687
290 262 060 LR YY 00	52	2628	600	2860	1510	1,25	72,28	43,16	-	1484	1707
290 267 060 LR YY 00	53	2678	600	2915	1539	1,25	73,67	43,99	-	1501	1726
290 272 060 LR YY 00	54	2728	600	2970	1568	1,25	75,06	44,82	-	1525	1754
290 277 060 LR YY 00	55	2778	600	3025	1597	1,25	76,45	45,65	-	1543	1774
290 282 060 LR YY 00	56	2828	600	3080	1626	1,25	77,84	46,48	-	1564	1799
290 287 060 LR YY 00	57	2878	600	3135	1655	1,25	79,23	47,31	-	1583	1820
290 292 060 LR YY 00	58	2928	600	3190	1685	1,25	80,62	48,14	-	1601	1841
290 297 060 LR YY 00	59	2978	600	3245	1714	1,25	82,01	48,97	-	1623	1866
290 302 060 LR YY 00	60	3028	600	3300	1743	1,25	83,40	49,80	-	1640	1886

Conform EN442-1: 2014: radiatoren en convectoren

\* RAL 9016: geen meerprijs 15%

Voor meer details over onze artikel-data, zie artikel-database: <https://www.installdata.be>

Voor de warmteafgiftes van andere regimes, kijkt u op p. 370 (correctiefactoren)  
BELGIË. Prijzen in euro (excl. BTW)

# VINTAGE (VINTAGE 50 / D160)

## HOE VINTAGE 50 BESTELLEN

Leveringstermijn 15 - 30 werkdagen  
(zonder transportduur)

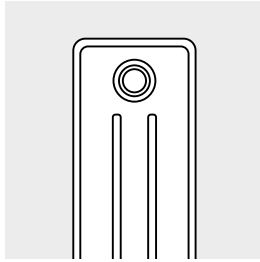

VINTAGE 50 / D160

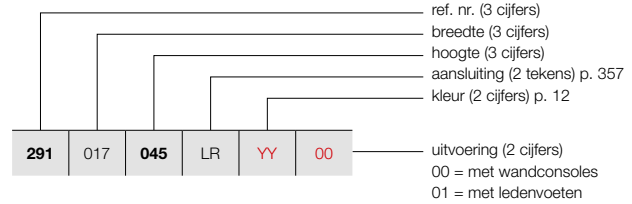

### PRIJSGROEP: VPG5 - KOLOMRADIATOREN

BESTELCODE MAATWERK VINTAGE 50	TECHNISCHE GEGEVENS									STANDAARDKLEUR	ANDERE KLEUREN					
	buizen	breedte (L mm)	hoogte (H mm)	75/65/20 (Watt) (Ø50K)	55/45/20 (Watt) (Ø30K)	n-exp.	gewicht (kg)	inhoud (l)	el. weerst. (Watt)	prijs S600* (€)	prijs kleur (€)					
<b>REF. NR. VINTAGE 50 VINTAGE 50/D160 : 291</b>																
<b>291</b>	017	<b>045</b> <b>060</b> <b>100</b>	LR	YY	00	3	178	450	174	92	1,24	4,47	2,82	-	<b>405</b>	<b>466</b>
						3	178	600	219	115	1,26	6,00	3,42	-	<b>424</b>	<b>488</b>
						3	178	1000	333	172	1,29	9,63	4,89	-	<b>463</b>	<b>532</b>
<b>291</b>	022	<b>045</b> <b>060</b> <b>100</b>	LR	YY	00	4	228	450	232	123	1,24	5,96	3,76	-	<b>429</b>	<b>493</b>
						4	228	600	292	153	1,26	8,00	4,56	-	<b>445</b>	<b>512</b>
						4	228	1000	444	230	1,29	12,84	6,52	-	<b>493</b>	<b>567</b>
<b>291</b>	027	<b>045</b> <b>060</b> <b>100</b>	LR	YY	00	5	278	450	290	154	1,24	7,45	4,70	-	<b>447</b>	<b>514</b>
						5	278	600	365	192	1,26	10,00	5,70	-	<b>473</b>	<b>544</b>
						5	278	1000	555	287	1,29	16,05	8,15	-	<b>530</b>	<b>610</b>
<b>291</b>	032	<b>045</b> <b>060</b> <b>100</b>	LR	YY	00	6	328	450	348	185	1,24	8,94	5,64	-	<b>469</b>	<b>539</b>
						6	328	600	438	230	1,26	12,00	6,84	-	<b>497</b>	<b>572</b>
						6	328	1000	666	345	1,29	19,26	9,78	-	<b>566</b>	<b>651</b>
<b>291</b>	037	<b>045</b> <b>060</b> <b>100</b>	LR	YY	00	7	378	450	406	215	1,24	10,43	6,58	-	<b>488</b>	<b>561</b>
						7	378	600	511	268	1,26	14,00	7,98	-	<b>519</b>	<b>597</b>
						7	378	1000	777	402	1,29	22,47	11,41	-	<b>604</b>	<b>695</b>
<b>291</b>	042	<b>045</b> <b>060</b> <b>100</b>	LR	YY	00	8	428	450	464	246	1,24	11,92	7,52	-	<b>515</b>	<b>592</b>
						8	428	600	584	307	1,26	16,00	9,12	-	<b>557</b>	<b>641</b>
						8	428	1000	888	459	1,29	25,68	13,04	-	<b>645</b>	<b>742</b>
<b>291</b>	047	<b>045</b> <b>060</b> <b>100</b>	LR	YY	00	9	478	450	522	277	1,24	13,41	8,46	-	<b>532</b>	<b>612</b>
						9	478	600	657	345	1,26	18,00	10,26	-	<b>577</b>	<b>664</b>
						9	478	1000	999	517	1,29	28,89	14,67	-	<b>677</b>	<b>779</b>
<b>291</b>	052	<b>045</b> <b>060</b> <b>100</b>	LR	YY	00	10	528	450	580	308	1,24	14,90	9,40	-	<b>556</b>	<b>639</b>
						10	528	600	730	384	1,26	20,00	11,40	-	<b>604</b>	<b>695</b>
						10	528	1000	1110	574	1,29	32,10	16,30	-	<b>714</b>	<b>821</b>
<b>291</b>	057	<b>045</b> <b>060</b> <b>100</b>	LR	YY	00	11	578	450	638	339	1,24	16,39	10,34	-	<b>578</b>	<b>665</b>
						11	578	600	803	422	1,26	22,00	12,54	-	<b>632</b>	<b>727</b>
						11	578	1000	1221	632	1,29	35,31	17,93	-	<b>756</b>	<b>869</b>
<b>291</b>	062	<b>045</b> <b>060</b> <b>100</b>	LR	YY	00	12	628	450	696	369	1,24	17,88	11,28	-	<b>598</b>	<b>688</b>
						12	628	600	876	460	1,26	24,00	13,68	-	<b>654</b>	<b>752</b>
						12	628	1000	1332	689	1,29	38,52	19,56	-	<b>792</b>	<b>911</b>
<b>291</b>	067	<b>045</b> <b>060</b> <b>100</b>	LR	YY	00	13	678	450	754	400	1,24	19,37	12,22	-	<b>617</b>	<b>710</b>
						13	678	600	949	499	1,26	26,00	14,82	-	<b>678</b>	<b>780</b>
						13	678	1000	1443	747	1,29	41,73	21,19	-	<b>825</b>	<b>949</b>
<b>291</b>	072	<b>045</b> <b>060</b> <b>100</b>	LR	YY	00	14	728	450	812	431	1,24	20,86	13,16	-	<b>634</b>	<b>729</b>
						14	728	600	1022	537	1,26	28,00	15,96	-	<b>706</b>	<b>812</b>
						14	728	1000	1554	804	1,29	44,94	22,82	-	<b>862</b>	<b>991</b>
<b>291</b>	077	<b>045</b> <b>060</b> <b>100</b>	LR	YY	00	15	778	450	870	462	1,24	22,35	14,10	-	<b>654</b>	<b>752</b>
						15	778	600	1095	575	1,26	30,00	17,10	-	<b>729</b>	<b>838</b>
						15	778	1000	1665	861	1,29	48,15	24,45	-	<b>895</b>	<b>1029</b>

Conform EN442-1: 2014: radiatoren en convectoren

\* RAL 9016: geen meerprijs 15%

Voor meer details over onze artikel-data, zie artikel-database: <https://www.installdata.be>

Voor de warmteafgifte van andere regimes, kijkt u op p. 370 (correctiefactoren)  
BELGIË. Prijzen in euro (excl. BTW)

# HOE VINTAGE 50 BESTELLEN

Leveringstermijn 15 - 30 werkdagen  
(zonder transportduur)

# VINTAGE (VINTAGE 50 / D160)

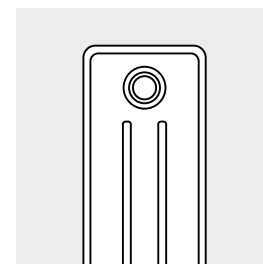
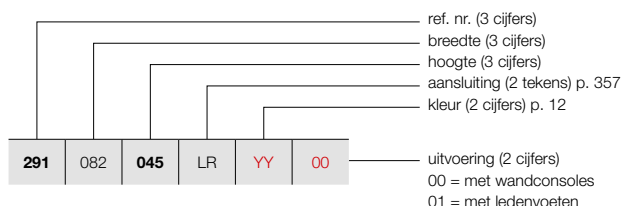

VINTAGE 50 / D160

## PRIJSGROEP: VPG5 - KOLOMRADIATOREN

BESTELCODE MAATWERK VINTAGE 50							TECHNISCHE GEGEVENS					STANDAARDKLEUR	ANDERE KLEUREN			
buizen	breedte (L mm)	hoogte (H mm)	75/65/20 (Watt) (φ50K)	55/45/20 (Watt) (φ30K)	n-exp.	gewicht (kg)	inhoud (l)	el. weerst. (Watt)	prijs S600* (€)	prijs kleur (€)						
<b>REF. NR. VINTAGE 50 VINTAGE 50/D160 : 291</b>																
291	082	045	LR	YY	00	16	828	450	928	493	1,24	23,84	15,04	-	<b>675</b>	<b>776</b>
		060				16	828	600	1168	614	1,26	32,00	18,24	-	<b>753</b>	<b>866</b>
		100				16	828	1000	1776	919	1,29	51,36	26,08	-	<b>929</b>	<b>1068</b>
291	087	045	LR	YY	00	17	878	450	986	523	1,24	25,33	15,98	-	<b>695</b>	<b>799</b>
		060				17	878	600	1241	652	1,26	34,00	19,38	-	<b>776</b>	<b>892</b>
		100				17	878	1000	1887	976	1,29	54,57	27,71	-	<b>966</b>	<b>1111</b>
291	092	045	LR	YY	00	18	928	450	1044	554	1,24	26,82	16,92	-	<b>714</b>	<b>821</b>
		060				18	928	600	1314	690	1,26	36,00	20,52	-	<b>802</b>	<b>922</b>
		100				18	928	1000	1998	1034	1,29	57,78	29,34	-	<b>1003</b>	<b>1153</b>
291	097	045	LR	YY	00	19	978	450	1102	585	1,24	28,31	17,86	-	<b>732</b>	<b>842</b>
		060				19	978	600	1387	729	1,26	38,00	21,66	-	<b>825</b>	<b>949</b>
		100				19	978	1000	2109	1091	1,29	60,99	30,97	-	<b>1037</b>	<b>1193</b>
291	102	045	LR	YY	00	20	1028	450	1160	616	1,24	29,80	18,80	-	<b>753</b>	<b>866</b>
		060				20	1028	600	1460	767	1,26	40,00	22,80	-	<b>847</b>	<b>974</b>
		100				20	1028	1000	2220	1149	1,29	64,20	32,60	-	<b>1071</b>	<b>1232</b>
291	107	045	LR	YY	00	21	1078	450	1218	646	1,24	31,29	19,74	-	<b>786</b>	<b>904</b>
		060				21	1078	600	1533	805	1,26	42,00	23,94	-	<b>887</b>	<b>1020</b>
		100				21	1078	1000	2331	1206	1,29	67,41	34,23	-	<b>1118</b>	<b>1286</b>
291	112	045	LR	YY	00	22	1128	450	1276	677	1,24	32,78	20,68	-	<b>806</b>	<b>927</b>
		060				22	1128	600	1606	844	1,26	44,00	25,08	-	<b>912</b>	<b>1049</b>
		100				22	1128	1000	2442	1263	1,29	70,62	35,86	-	<b>1155</b>	<b>1328</b>
291	117	045	LR	YY	00	23	1178	450	1334	708	1,24	34,27	21,62	-	<b>825</b>	<b>949</b>
		060				23	1178	600	1679	882	1,26	46,00	26,22	-	<b>932</b>	<b>1072</b>
		100				23	1178	1000	2553	1321	1,29	73,83	37,49	-	<b>1189</b>	<b>1367</b>
291	122	045	LR	YY	00	24	1228	450	1392	739	1,24	35,76	22,56	-	<b>842</b>	<b>968</b>
		060				24	1228	600	1752	920	1,26	48,00	27,36	-	<b>960</b>	<b>1104</b>
		100				24	1228	1000	2664	1378	1,29	77,04	39,12	-	<b>1227</b>	<b>1411</b>
291	127	045	LR	YY	00	25	1278	450	1450	770	1,24	37,25	23,50	-	<b>863</b>	<b>992</b>
		060				25	1278	600	1825	959	1,26	50,00	28,50	-	<b>982</b>	<b>1129</b>
		100				25	1278	1000	2775	1436	1,29	80,25	40,75	-	<b>1258</b>	<b>1447</b>
291	132	045	LR	YY	00	26	1328	450	1508	800	1,24	38,74	24,44	-	<b>902</b>	<b>1037</b>
		060				26	1328	600	1898	997	1,26	52,00	29,64	-	<b>1024</b>	<b>1178</b>
		100				26	1328	1000	2886	1493	1,29	83,46	42,38	-	<b>1314</b>	<b>1511</b>
291	137	045	LR	YY	00	27	1378	450	1566	831	1,24	40,23	25,38	-	<b>919</b>	<b>1057</b>
		060				27	1378	600	1971	1036	1,26	54,00	30,78	-	<b>1048</b>	<b>1205</b>
		100				27	1378	1000	2997	1551	1,29	86,67	44,01	-	<b>1349</b>	<b>1551</b>
291	142	045	LR	YY	00	28	1428	450	1624	862	1,24	41,72	26,32	-	<b>937</b>	<b>1078</b>
		060				28	1428	600	2044	1074	1,26	56,00	31,92	-	<b>1072</b>	<b>1233</b>
		100				28	1428	1000	3108	1608	1,29	89,88	45,64	-	<b>1385</b>	<b>1593</b>

Conform EN442-1: 2014: radiatoren en convectoren

\* RAL 9016: geen meerprijs 15%

Voor meer details over onze artikel-data, zie artikel-database: <https://www.installdata.be>

Voor de warmteafgiftes van andere regimes, kijkt u op p. 370 (correctiefactoren)

BELGIË. Prijzen in euro (excl. BTW)

# VINTAGE (VINTAGE 50 / D160)

**HOE VINTAGE 50 BESTELLEN**  
 Leveringstermijn 15 - 30 werkdagen  
 (zonder transportduur)

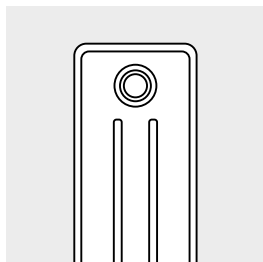

VINTAGE 50 / D160

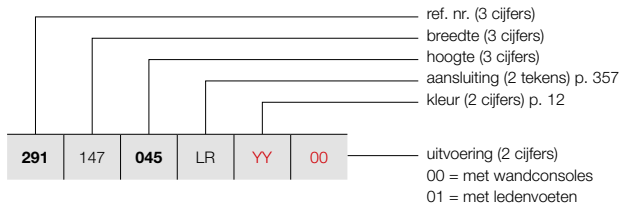

**PRIJSGROEP: VPG5 - KOLOMRADIATOREN**

BESTELCODE MAATWERK VINTAGE 50							TECHNISCHE GEGEVENS					STANDAARDKLEUR	ANDERE KLEUREN			
ref. nr.	breedte	hoogte	aansluiting	kleur	uitvoering	buizen	breedte (L mm)	hoogte (H mm)	75/65/20 (Watt) (Φ50K)	55/45/20 (Watt) (Φ30K)	n-exp.	gewicht (kg)	inhoud (l)	el. weerst. (Watt)	prijs S600* (€)	prijs kleur (€)
<b>REF. NR. VINTAGE 50 VINTAGE 50/D160 : 291</b>																
291	147	045 060 100	LR	YY	00	29	1478	450	1682	893	1,24	43,21	27,26	-	960	1104
						29	1478	600	2117	1112	1,26	58,00	33,06	-	1094	1258
						29	1478	1000	3219	1665	1,29	93,09	47,27	-	1418	1631
291	152	045 060 100	LR	YY	00	30	1528	450	1740	924	1,24	44,70	28,20	-	976	1122
						30	1528	600	2190	1151	1,26	60,00	34,20	-	1121	1289
						30	1528	1000	3330	1723	1,29	96,30	48,90	-	1450	1668
291	157	045 060	LR	YY	00	31	1578	450	1798	954	1,24	46,19	29,14	-	997	1147
						31	1578	600	2263	1189	1,26	62,00	34,34	-	1145	1317
291	162	045 060	LR	YY	00	32	1628	450	1856	985	1,24	47,68	30,08	-	1013	1165
						32	1628	600	2336	1227	1,26	64,00	36,48	-	1167	1342
291	167	045 060	LR	YY	00	33	1678	450	1914	1016	1,24	49,17	31,02	-	1079	1241
						33	1678	600	2409	1266	1,26	66,00	37,62	-	1236	1421
291	172	045 060	LR	YY	00	34	1728	450	1972	1047	1,24	50,66	31,96	-	1094	1258
						34	1728	600	2482	1304	1,26	68,00	38,76	-	1260	1449
291	177	045 060	LR	YY	00	35	1778	450	2030	1077	1,24	52,15	32,90	-	1115	1282
						35	1778	600	2555	1342	1,26	70,00	39,90	-	1282	1474
291	182	045 060	LR	YY	00	36	1828	450	2088	1108	1,24	53,64	33,84	-	1144	1316
						36	1828	600	2628	1381	1,26	72,00	41,04	-	1315	1512
291	187	045 060	LR	YY	00	37	1878	450	2146	1139	1,24	55,13	34,78	-	1161	1335
						37	1878	600	2701	1419	1,26	74,00	42,18	-	1336	1536
291	192	045 060	LR	YY	00	38	1928	450	2204	1170	1,24	56,62	35,72	-	1183	1360
						38	1928	600	2774	1457	1,26	76,00	43,32	-	1363	1567
291	197	045 060	LR	YY	00	39	1978	450	2262	1201	1,24	58,11	36,66	-	1199	1379
						39	1978	600	2847	1496	1,26	78,00	44,46	-	1387	1595
291	202	045 060	LR	YY	00	40	2028	450	2320	1231	1,24	59,60	37,60	-	1217	1400
						40	2028	600	2920	1534	1,26	80,00	45,60	-	1409	1620
291	207	045 060	LR	YY	00	41	2078	450	2378	1262	1,24	61,09	38,54	-	1238	1424
						41	2078	600	2993	1572	1,26	82,00	46,74	-	1436	1651
291	212	045 060	LR	YY	00	42	2128	450	2436	1293	1,24	62,58	39,48	-	1257	1446
						42	2128	600	3066	1611	1,26	84,00	47,88	-	1461	1680
291	217	045 060	LR	YY	00	43	2178	450	2494	1324	1,24	64,07	40,42	-	1276	1467
						43	2178	600	3139	1649	1,26	86,00	49,02	-	1482	1704
291	222	045 060	LR	YY	00	44	2228	450	2552	1355	1,24	65,56	41,36	-	1297	1492
						44	2228	600	3212	1688	1,26	88,00	50,16	-	1505	1731

Conform EN442-1: 2014: radiatoren en convectoren

\* RAL 9016: geen meerprijs 15%

Voor meer details over onze artikel-data, zie artikel-database: <https://www.installdata.be>

Voor de warmteafgiftes van andere regimes, kijkt u op p. 370 (correctiefactoren)

BELGIË. Prijzen in euro (excl. BTW)

## HOE VINTAGE 50 BESTELLEN

Leveringstermijn 15 - 30 werkdagen  
(zonder transportduur)

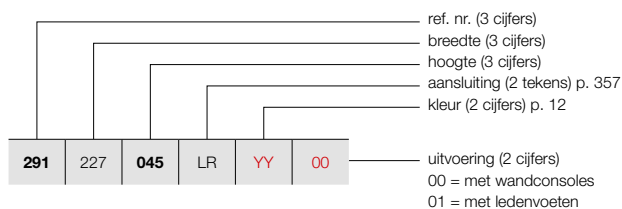

## VINTAGE (VINTAGE 50 / D160)

349

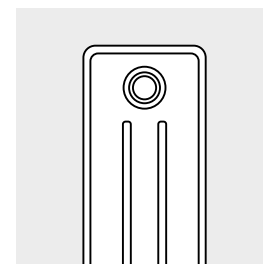

VINTAGE 50 / D160

### PRIJSGROEP: VPG5 - KOLOMRADIATOREN

BESTELCODE MAATWERK VINTAGE 50	TECHNISCHE GEGEVENS							STANDAARDKLEUR		ANDERE KLEUREN						
	buizen	breedte (L mm)	hoogte (H mm)	75/65/20 (Watt) (Φ50K)	55/45/20 (Watt) (Φ30K)	n-exp.	gewicht (kg)	inhoud (l)	el. weerst. (Watt)	prijs S600* (€)	prijs kleur (€)					
<b>REF. NR. VINTAGE 50 VINTAGE 50/D160 : 291</b>																
<b>291</b>	227	<b>045</b>	LR	<b>YY</b>	<b>00</b>											
		<b>060</b>														
						45	2278	450	2610	1385	1,24	67,05	42,30	-	<b>1316</b>	<b>1513</b>
						45	2278	600	3285	1726	1,26	90,00	51,30	-	<b>1529</b>	<b>1758</b>
<b>291</b>	232	<b>045</b>	LR	<b>YY</b>	<b>00</b>											
		<b>060</b>														
						46	2328	450	2668	1416	1,24	68,54	43,24	-	<b>1333</b>	<b>1533</b>
						46	2328	600	3358	1764	1,26	92,00	52,44	-	<b>1552</b>	<b>1785</b>
<b>291</b>	237	<b>045</b>	LR	<b>YY</b>	<b>00</b>											
		<b>060</b>														
						47	2378	450	2726	1447	1,24	70,03	44,18	-	<b>1355</b>	<b>1558</b>
						47	2378	600	3431	1803	1,26	94,00	53,58	-	<b>1579</b>	<b>1816</b>
<b>291</b>	242	<b>045</b>	LR	<b>YY</b>	<b>00</b>											
		<b>060</b>														
						48	2428	450	2784	1478	1,24	71,52	45,12	-	<b>1373</b>	<b>1579</b>
						48	2428	600	3504	1841	1,26	96,00	54,72	-	<b>1601</b>	<b>1841</b>
<b>291</b>	247	<b>045</b>	LR	<b>YY</b>	<b>00</b>											
						49	2478	450	2842	1508	1,24	73,01	46,06	-	<b>1393</b>	<b>1602</b>
<b>291</b>	252	<b>045</b>	LR	<b>YY</b>	<b>00</b>											
						50	2528	450	2900	1539	1,24	74,50	47,00	-	<b>1410</b>	<b>1622</b>
<b>291</b>	257	<b>045</b>	LR	<b>YY</b>	<b>00</b>											
						51	2578	450	2958	1570	1,24	75,99	47,94	-	<b>1447</b>	<b>1664</b>
<b>291</b>	262	<b>045</b>	LR	<b>YY</b>	<b>00</b>											
						52	2628	450	3016	1601	1,24	77,48	48,88	-	<b>1470</b>	<b>1691</b>
<b>291</b>	267	<b>045</b>	LR	<b>YY</b>	<b>00</b>											
						53	2678	450	3074	1632	1,24	78,97	49,82	-	<b>1486</b>	<b>1709</b>
<b>291</b>	272	<b>045</b>	LR	<b>YY</b>	<b>00</b>											
						54	2728	450	3132	1662	1,24	80,46	50,76	-	<b>1506</b>	<b>1732</b>
<b>291</b>	277	<b>045</b>	LR	<b>YY</b>	<b>00</b>											
						55	2778	450	3190	1693	1,24	81,95	51,70	-	<b>1527</b>	<b>1756</b>
<b>291</b>	282	<b>045</b>	LR	<b>YY</b>	<b>00</b>											
						56	2828	450	3248	1724	1,24	83,44	52,64	-	<b>1546</b>	<b>1778</b>
<b>291</b>	287	<b>045</b>	LR	<b>YY</b>	<b>00</b>											
						57	2878	450	3306	1755	1,24	84,93	53,58	-	<b>1565</b>	<b>1800</b>
<b>291</b>	292	<b>045</b>	LR	<b>YY</b>	<b>00</b>											
						58	2928	450	3364	1786	1,24	86,42	54,52	-	<b>1585</b>	<b>1823</b>
<b>291</b>	297	<b>045</b>	LR	<b>YY</b>	<b>00</b>											
						59	2978	450	3422	1816	1,24	87,91	55,46	-	<b>1603</b>	<b>1843</b>
<b>291</b>	302	<b>045</b>	LR	<b>YY</b>	<b>00</b>											
						60	3028	450	3480	1847	1,24	89,40	56,40	-	<b>1625</b>	<b>1869</b>

Conform EN442-1: 2014: radiatoren en convectoren

\* RAL 9016: geen meerprijs 15%

Voor meer details over onze artikel-data, zie artikel-database: <https://www.installdata.be>

**Voor de warmteafgiftes van andere regimes, kijkt u op p. 370 (correctiefactoren)**  
**BELGIË. Prijzen in euro (excl. BTW)**

# VINTAGE (VINTAGE 50 / D220)

## HOE VINTAGE 50 BESTELLEN

Leveringstermijn 15 - 30 werkdagen  
(zonder transportduur)

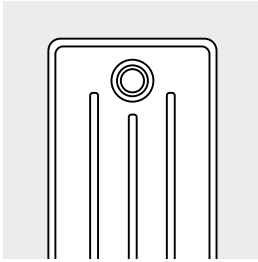

VINTAGE 50 / D220

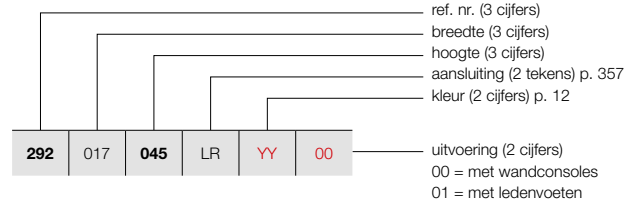

### PRIJSGROEP: VPG5 - KOLOMRADIATOREN

BESTELCODE MAATWERK VINTAGE 50							TECHNISCHE GEGEVENS					STANDAARDKLEUR	ANDERE KLEUREN			
buizen	breedte (L mm)	hoogte (H mm)	75/65/20 (Watt) (Ø50K)	55/45/20 (Watt) (Ø30K)	n-exp.	gewicht (kg)	inhoud (l)	el. weerst. (Watt)	prijs S600* (€)	prijs kleur (€)						
<b>REF. NR. VINTAGE 50 VINTAGE 50/D220 : 292</b>																
<b>292</b>	<b>017</b>	<b>045</b>	<b>LR</b>	<b>YY</b>	<b>00</b>	3	178	450	225	119	1,25	6,00	3,69	-	<b>421</b>	<b>484</b>
		<b>060</b>				3	178	600	282	148	1,26	7,86	4,44	-	<b>440</b>	<b>506</b>
		<b>100</b>				3	178	1000	435	226	1,28	13,68	7,26	-	<b>488</b>	<b>561</b>
<b>292</b>	<b>022</b>	<b>045</b>	<b>LR</b>	<b>YY</b>	<b>00</b>	4	228	450	300	158	1,25	8,00	4,92	-	<b>443</b>	<b>509</b>
		<b>060</b>				4	228	600	376	198	1,26	10,48	5,92	-	<b>472</b>	<b>543</b>
		<b>100</b>				4	228	1000	580	302	1,28	18,24	9,68	-	<b>532</b>	<b>612</b>
<b>292</b>	<b>027</b>	<b>045</b>	<b>LR</b>	<b>YY</b>	<b>00</b>	5	278	450	375	198	1,25	10,00	6,15	-	<b>471</b>	<b>542</b>
		<b>060</b>				5	278	600	470	247	1,26	13,10	7,40	-	<b>502</b>	<b>577</b>
		<b>100</b>				5	278	1000	725	377	1,28	22,80	12,10	-	<b>578</b>	<b>665</b>
<b>292</b>	<b>032</b>	<b>045</b>	<b>LR</b>	<b>YY</b>	<b>00</b>	6	328	450	450	238	1,25	12,00	7,38	-	<b>493</b>	<b>567</b>
		<b>060</b>				6	328	600	564	296	1,26	15,72	8,88	-	<b>530</b>	<b>610</b>
		<b>100</b>				6	328	1000	870	452	1,28	27,36	14,52	-	<b>625</b>	<b>719</b>
<b>292</b>	<b>037</b>	<b>045</b>	<b>LR</b>	<b>YY</b>	<b>00</b>	7	378	450	525	277	1,25	14,00	8,61	-	<b>516</b>	<b>593</b>
		<b>060</b>				7	378	600	658	346	1,26	18,34	10,36	-	<b>562</b>	<b>646</b>
		<b>100</b>				7	378	1000	1015	528	1,28	31,92	16,94	-	<b>669</b>	<b>769</b>
<b>292</b>	<b>042</b>	<b>045</b>	<b>LR</b>	<b>YY</b>	<b>00</b>	8	428	450	600	317	1,25	16,00	9,84	-	<b>547</b>	<b>629</b>
		<b>060</b>				8	428	600	752	395	1,26	20,96	11,84	-	<b>598</b>	<b>688</b>
		<b>100</b>				8	428	1000	1160	603	1,28	36,48	19,36	-	<b>720</b>	<b>828</b>
<b>292</b>	<b>047</b>	<b>045</b>	<b>LR</b>	<b>YY</b>	<b>00</b>	9	478	450	675	356	1,25	18,00	11,07	-	<b>568</b>	<b>653</b>
		<b>060</b>				9	478	600	846	444	1,26	23,58	13,32	-	<b>627</b>	<b>721</b>
		<b>100</b>				9	478	1000	1305	679	1,28	41,04	21,78	-	<b>763</b>	<b>877</b>
<b>292</b>	<b>052</b>	<b>045</b>	<b>LR</b>	<b>YY</b>	<b>00</b>	10	528	450	750	396	1,25	20,00	12,30	-	<b>590</b>	<b>679</b>
		<b>060</b>				10	528	600	940	494	1,26	26,20	14,80	-	<b>654</b>	<b>752</b>
		<b>100</b>				10	528	1000	1450	754	1,28	45,60	24,20	-	<b>810</b>	<b>932</b>
<b>292</b>	<b>057</b>	<b>045</b>	<b>LR</b>	<b>YY</b>	<b>00</b>	11	578	450	825	436	1,25	22,00	13,53	-	<b>625</b>	<b>719</b>
		<b>060</b>				11	578	600	1034	543	1,26	28,82	16,28	-	<b>690</b>	<b>794</b>
		<b>100</b>				11	578	1000	1595	829	1,28	50,16	26,62	-	<b>863</b>	<b>992</b>
<b>292</b>	<b>062</b>	<b>045</b>	<b>LR</b>	<b>YY</b>	<b>00</b>	12	628	450	900	475	1,25	24,00	14,76	-	<b>648</b>	<b>745</b>
		<b>060</b>				12	628	600	1128	593	1,26	31,44	17,76	-	<b>723</b>	<b>831</b>
		<b>100</b>				12	628	1000	1740	905	1,28	54,72	29,04	-	<b>907</b>	<b>1043</b>
<b>292</b>	<b>067</b>	<b>045</b>	<b>LR</b>	<b>YY</b>	<b>00</b>	13	678	450	975	515	1,25	26,00	15,99	-	<b>670</b>	<b>771</b>
		<b>060</b>				13	678	600	1222	642	1,26	34,06	19,24	-	<b>753</b>	<b>866</b>
		<b>100</b>				13	678	1000	1885	980	1,28	59,28	31,46	-	<b>953</b>	<b>1096</b>
<b>292</b>	<b>072</b>	<b>045</b>	<b>LR</b>	<b>YY</b>	<b>00</b>	14	728	450	1050	554	1,25	28,00	17,22	-	<b>690</b>	<b>794</b>
		<b>060</b>				14	728	600	1316	691	1,26	36,68	20,72	-	<b>783</b>	<b>900</b>
		<b>100</b>				14	728	1000	2030	1056	1,28	63,84	33,88	-	<b>995</b>	<b>1144</b>
<b>292</b>	<b>077</b>	<b>045</b>	<b>LR</b>	<b>YY</b>	<b>00</b>	15	778	450	1125	594	1,25	30,00	18,45	-	<b>717</b>	<b>825</b>
		<b>060</b>				15	778	600	1410	741	1,26	39,30	22,20	-	<b>810</b>	<b>932</b>
		<b>100</b>				15	778	1000	2175	1131	1,28	68,40	36,30	-	<b>1042</b>	<b>1198</b>

Conform EN442-1: 2014: radiatoren en convectoren

\* RAL 9016: geen meerprijs 15%

Voor meer details over onze artikel-data, zie artikel-database: <https://www.installdata.be>

Voor de warmteafgifte van andere regimes, kijkt u op p. 370 (correctiefactoren)  
BELGIË. Prijzen in euro (excl. BTW)

# HOE VINTAGE 50 BESTELLEN

Leveringstermijn 15 - 30 werkdagen  
(zonder transportduur)

# VINTAGE (VINTAGE 50 / D220)

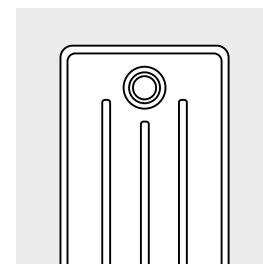
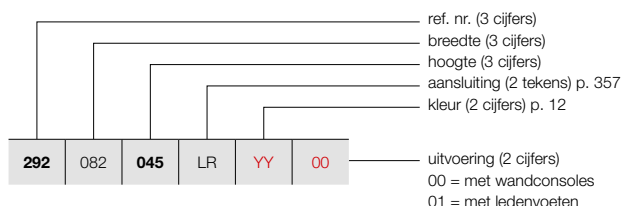

VINTAGE 50 / D220

## PRIJSGROEP: VPG5 - KOLOMRADIATOREN

BESTELCODE MAATWERK VINTAGE 50	TECHNISCHE GEGEVENS							STANDAARDKLEUR	ANDERE KLEUREN							
	buizen	breedte (L mm)	hoogte (H mm)	75/65/20 (Watt) (φ50K)	55/45/20 (Watt) (φ30K)	n-exp.	gewicht (kg)			inhoud (l)	el. weerst. (Watt)	prijs S600* (€)	prijs kleur (€)			
REF. NR. VINTAGE 50 VINTAGE 50/D220 : 292																
292	082	045	LR	YY	00	16	828	450	1200	634	1,25	32,00	19,68	-	737	848
		060				16	828	600	1504	790	1,26	41,92	23,68	-	840	966
		100				16	828	1000	2320	1206	1,28	72,96	38,72	-	1086	1249
292	087	045	LR	YY	00	17	878	450	1275	673	1,25	34,00	20,91	-	760	874
		060				17	878	600	1598	840	1,26	44,54	25,16	-	870	1001
		100				17	878	1000	2465	1282	1,28	77,52	41,14	-	1132	1302
292	092	045	LR	YY	00	18	928	450	1350	713	1,25	36,00	22,14	-	786	904
		060				18	928	600	1692	889	1,26	47,16	26,64	-	902	1037
		100				18	928	1000	2610	1357	1,28	82,08	43,56	-	1176	1352
292	097	045	LR	YY	00	19	978	450	1425	752	1,25	38,00	23,37	-	809	930
		060				19	978	600	1786	938	1,26	49,78	28,12	-	927	1066
		100				19	978	1000	2755	1433	1,28	86,64	45,98	-	1223	1406
292	102	045	LR	YY	00	20	1028	450	1500	792	1,25	40,00	24,60	-	831	956
		060				20	1028	600	1880	988	1,26	52,40	29,60	-	960	1104
		100				20	1028	1000	2900	1508	1,28	91,20	48,40	-	1263	1452
292	107	045	LR	YY	00	21	1078	450	1575	832	1,25	42,00	25,83	-	869	999
		060				21	1078	600	1974	1037	1,26	55,02	31,08	-	1003	1153
		100				21	1078	1000	3045	1584	1,28	95,76	50,82	-	1325	1524
292	112	045	LR	YY	00	22	1128	450	1650	871	1,25	44,00	27,06	-	893	1027
		060				22	1128	600	2068	1086	1,26	57,64	32,56	-	1031	1186
		100				22	1128	1000	3190	1659	1,28	100,32	53,24	-	1368	1573
292	117	045	LR	YY	00	23	1178	450	1725	911	1,25	46,00	28,29	-	915	1052
		060				23	1178	600	2162	1136	1,26	60,26	34,04	-	1062	1221
		100				23	1178	1000	3335	1734	1,28	104,88	55,66	-	1415	1627
292	122	045	LR	YY	00	24	1228	450	1800	951	1,25	48,00	29,52	-	937	1078
		060				24	1228	600	2256	1185	1,26	62,88	35,52	-	1090	1254
		100				24	1228	1000	3480	1810	1,28	109,44	58,08	-	1461	1680
292	127	045	LR	YY	00	25	1278	450	1875	990	1,25	50,00	30,75	-	963	1107
		060				25	1278	600	2350	1235	1,26	65,50	37,00	-	1118	1286
		100				25	1278	1000	3625	1885	1,28	114,00	60,50	-	1501	1726
292	132	045	LR	YY	00	26	1328	450	1950	1030	1,25	52,00	31,98	-	1004	1155
		060				26	1328	600	2444	1284	1,26	68,12	38,48	-	1166	1341
		100				26	1328	1000	3770	1961	1,28	118,56	62,92	-	1566	1801
292	137	045	LR	YY	00	27	1378	450	2025	1069	1,25	54,00	33,21	-	1025	1179
		060				27	1378	600	2538	1333	1,26	70,74	39,96	-	1194	1373
		100				27	1378	1000	3915	2036	1,28	123,12	65,34	-	1611	1853
292	142	045	LR	YY	00	28	1428	450	2100	1109	1,25	56,00	34,44	-	1048	1205
		060				28	1428	600	2632	1383	1,26	73,36	41,44	-	1227	1411
		100				28	1428	1000	4060	2111	1,28	127,68	67,76	-	1655	1903

Conform EN442-1: 2014: radiatoren en convectoren

\* RAL 9016: geen meerprijs 15%

Voor meer details over onze artikel-data, zie artikel-database: <https://www.installdata.be>

Voor de warmteafgiftes van andere regimes, kijkt u op p. 370 (correctiefactoren)

BELGIË. Prijzen in euro (excl. BTW)

# VINTAGE (VINTAGE 50 / D220)

## HOE VINTAGE 50 BESTELLEN

Leveringstermijn 15 - 30 werkdagen  
(zonder transportduur)

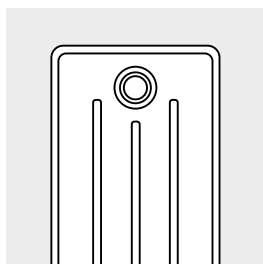

VINTAGE 50 / D220

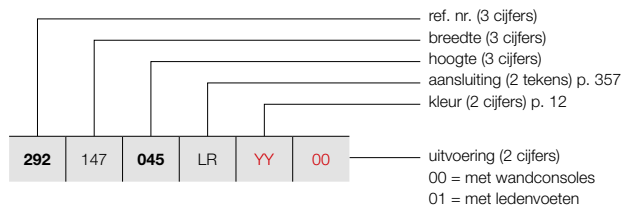

### PRIJSGROEP: VPG5 - KOLOMRADIATOREN

BESTELCODE MAATWERK VINTAGE 50							TECHNISCHE GEGEVENS					STANDAARDKLEUR	ANDERE KLEUREN					
292	147	045	LR	YY	00	060	100	buizen	breedte (L mm)	hoogte (H mm)	75/65/20 (Watt) (Φ50K)	55/45/20 (Watt) (Φ30K)	n-exp.	gewicht (kg)	inhoud (l)	el. weerst. (Watt)	prijs S600* (€)	prijs kleur (€)
<b>REF. NR. VINTAGE 50 VINTAGE 50/D220 : 292</b>																		
292	147	045	LR	YY	00	060	100	29	1478	450	2175	1149	1,25	58,00	35,67	-	1072	1233
		060						29	1478	600	2726	1432	1,26	75,98	42,92	-	1254	1442
		100						29	1478	1000	4205	2187	1,28	132,24	70,18	-	1701	1956
292	152	045	LR	YY	00	060	100	30	1528	450	2250	1188	1,25	60,00	36,90	-	1093	1257
		060						30	1528	600	2820	1482	1,26	78,60	44,40	-	1282	1474
		100						30	1528	1000	4350	2262	1,28	136,80	72,60	-	1744	2006
292	157	045	LR	YY	00	060		31	1578	450	2325	1228	1,25	62,00	38,13	-	1118	1286
		060						31	1578	600	2914	1531	1,26	81,22	45,88	-	1315	1512
292	162	045	LR	YY	00	060		32	1628	450	2400	1267	1,25	64,00	39,36	-	1144	1316
		060						32	1628	600	3008	1580	1,26	83,84	47,36	-	1344	1546
292	167	045	LR	YY	00	060		33	1678	450	2475	1307	1,25	66,00	40,59	-	1210	1392
		060						33	1678	600	3102	1630	1,26	86,46	48,84	-	1416	1628
292	172	045	LR	YY	00	060		34	1728	450	2550	1347	1,25	68,00	41,82	-	1233	1418
		060						34	1728	600	3196	1679	1,26	89,08	50,32	-	1444	1661
292	177	045	LR	YY	00	060		35	1778	450	2625	1386	1,25	70,00	43,05	-	1254	1442
		060						35	1778	600	3290	1728	1,26	91,70	51,80	-	1477	1699
292	182	045	LR	YY	00	060		36	1828	450	2700	1426	1,25	72,00	44,28	-	1282	1474
		060						36	1828	600	3384	1778	1,26	94,32	53,28	-	1509	1735
292	187	045	LR	YY	00	060		37	1878	450	2775	1465	1,25	74,00	45,51	-	1309	1505
		060						37	1878	600	3478	1827	1,26	96,36	54,76	-	1541	1772
292	192	045	LR	YY	00	060		38	1928	450	2850	1505	1,25	76,00	46,74	-	1329	1528
		060						38	1928	600	3572	1877	1,26	99,56	56,24	-	1568	1803
292	197	045	LR	YY	00	060		39	1978	450	2925	1545	1,25	78,00	47,97	-	1355	1558
		060						39	1978	600	3666	1926	1,26	102,18	57,72	-	1597	1837
292	202	045	LR	YY	00	060		40	2028	450	3000	1584	1,25	80,00	49,20	-	1377	1584
		060						40	2028	600	3760	1975	1,26	104,80	59,20	-	1630	1875
292	207	045	LR	YY	00	060		41	2078	450	3075	1624	1,25	82,00	50,43	-	1401	1611
		060						41	2078	600	3854	2025	1,26	107,42	60,68	-	1656	1904
292	212	045	LR	YY	00	060		42	2128	450	3150	1663	1,25	84,00	51,66	-	1423	1636
		060						42	2128	600	3948	2074	1,26	110,04	62,16	-	1687	1940
292	217	045	LR	YY	00	060		43	2178	450	3225	1703	1,25	86,00	52,89	-	1445	1662
		060						43	2178	600	4042	2124	1,26	112,66	63,64	-	1716	1973
292	222	045	LR	YY	00	060		44	2228	450	3300	1743	1,25	88,00	54,12	-	1471	1692
		060						44	2228	600	4136	2173	1,26	115,28	65,12	-	1745	2007

Conform EN442-1: 2014: radiatoren en convectoren

\* RAL 9016: geen meerprijs 15%

Voor meer details over onze artikel-data, zie artikel-database: <https://www.installdata.be>

Voor de warmteafgiftes van andere regimes, kijkt u op p. 370 (correctiefactoren)

BELGIË. Prijzen in euro (excl. BTW)

## HOE VINTAGE 50 BESTELLEN

Leveringstermijn 15 - 30 werkdagen  
(zonder transportduur)

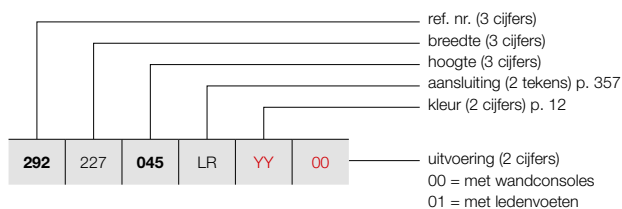

## VINTAGE (VINTAGE 50 / D220)

353

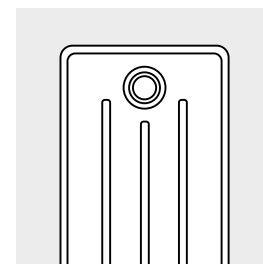

VINTAGE 50 / D220

### PRIJSGROEP: VPG5 - KOLOMRADIATOREN

BESTELCODE MAATWERK VINTAGE 50	TECHNISCHE GEGEVENS							STANDAARDKLEUR	ANDERE KLEUREN							
	buizen	breedte (L mm)	hoogte (H mm)	75/65/20 (Watt) (Φ50K)	55/45/20 (Watt) (Φ30K)	n-exp.	gewicht (kg)			inhoud (l)	el. weerst. (Watt)	prijs S600* (€)	prijs kleur (€)			
<b>REF. NR. VINTAGE 50 VINTAGE 50/D220 : 292</b>																
<b>292</b>	227	<b>045</b>	LR	<b>YY</b>	<b>00</b>											
		<b>060</b>														
						45	2278	450	3375	1782	1,25	90,00	55,35	-	<b>1491</b>	<b>1715</b>
						45	2278	600	4230	2222	1,26	117,90	66,60	-	<b>1774</b>	<b>2040</b>
<b>292</b>	232	<b>045</b>	LR	<b>YY</b>	<b>00</b>											
		<b>060</b>														
						46	2328	450	3450	1822	1,25	93,84	56,58	-	<b>1519</b>	<b>1747</b>
						46	2328	600	4324	2272	1,26	120,52	68,08	-	<b>1805</b>	<b>2076</b>
<b>292</b>	237	<b>045</b>	LR	<b>YY</b>	<b>00</b>											
		<b>060</b>														
						47	2378	450	3525	1861	1,25	94,00	57,81	-	<b>1541</b>	<b>1772</b>
						47	2378	600	4418	2321	1,26	123,14	69,56	-	<b>1834</b>	<b>2109</b>
<b>292</b>	242	<b>045</b>	LR	<b>YY</b>	<b>00</b>											
		<b>060</b>														
						48	2428	450	3600	1901	1,25	96,00	59,04	-	<b>1564</b>	<b>1799</b>
						48	2428	600	4512	2370	1,26	125,76	71,04	-	<b>1863</b>	<b>2142</b>
<b>292</b>	247	<b>045</b>	LR	<b>YY</b>	<b>00</b>											
		<b>060</b>														
						49	2478	450	3675	1941	1,25	99,96	60,27	-	<b>1585</b>	<b>1823</b>
						49	2478	600	4606	2420	1,26	128,38	72,52	-	<b>1889</b>	<b>2172</b>
<b>292</b>	252	<b>045</b>	LR	<b>YY</b>	<b>00</b>											
		<b>060</b>														
						50	2528	450	3750	1980	1,25	102,00	61,50	-	<b>1609</b>	<b>1850</b>
						50	2528	600	4700	2469	1,26	131,00	74,00	-	<b>1924</b>	<b>2213</b>
<b>292</b>	257	<b>045</b>	LR	<b>YY</b>	<b>00</b>											
		<b>060</b>														
						51	2578	450	3825	2020	1,25	104,04	62,73	-	<b>1651</b>	<b>1899</b>
<b>292</b>	262	<b>045</b>	LR	<b>YY</b>	<b>00</b>											
		<b>060</b>														
						52	2628	450	3900	2059	1,25	106,08	63,96	-	<b>1673</b>	<b>1924</b>
<b>292</b>	267	<b>045</b>	LR	<b>YY</b>	<b>00</b>											
		<b>060</b>														
						53	2678	450	3975	2099	1,25	108,12	65,19	-	<b>1696</b>	<b>1950</b>
<b>292</b>	272	<b>045</b>	LR	<b>YY</b>	<b>00</b>											
		<b>060</b>														
						54	2728	450	4050	2139	1,25	110,16	66,42	-	<b>1720</b>	<b>1978</b>
<b>292</b>	277	<b>045</b>	LR	<b>YY</b>	<b>00</b>											
		<b>060</b>														
						55	2778	450	4125	2178	1,25	112,20	67,65	-	<b>1743</b>	<b>2004</b>
<b>292</b>	282	<b>045</b>	LR	<b>YY</b>	<b>00</b>											
		<b>060</b>														
						56	2828	450	4200	2218	1,25	114,24	68,88	-	<b>1764</b>	<b>2029</b>
<b>292</b>	287	<b>045</b>	LR	<b>YY</b>	<b>00</b>											
		<b>060</b>														
						57	2878	450	4275	2257	1,25	116,28	70,11	-	<b>1791</b>	<b>2060</b>
<b>292</b>	292	<b>045</b>	LR	<b>YY</b>	<b>00</b>											
		<b>060</b>														
						58	2928	450	4350	2297	1,25	118,32	71,34	-	<b>1812</b>	<b>2084</b>
<b>292</b>	297	<b>045</b>	LR	<b>YY</b>	<b>00</b>											
		<b>060</b>														
						59	2978	450	4425	2337	1,25	120,36	72,57	-	<b>1836</b>	<b>2111</b>
<b>292</b>	302	<b>045</b>	LR	<b>YY</b>	<b>00</b>											
		<b>060</b>														
						60	3028	450	4500	2376	1,25	122,40	73,80	-	<b>1860</b>	<b>2139</b>

Conform EN442-1: 2014: radiatoren en convectoren

\* RAL 9016: geen meerprijs 15%

Voor meer details over onze artikel-data, zie artikel-database: <https://www.installdata.be>

**Voor de warmteafgiftes van andere regimes, kijkt u op p. 370 (correctiefactoren)**

**BELGIË. Prijzen in euro (excl. BTW)**

# VINTAGE (VINTAGE 50 / D250)

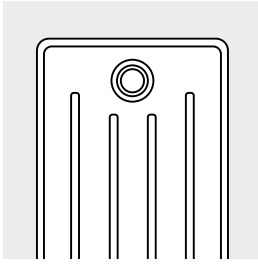

VINTAGE 50 / D250

## HOE VINTAGE 50 BESTELLEN

Leveringstermijn 15 - 30 werkdagen  
(zonder transportduur)

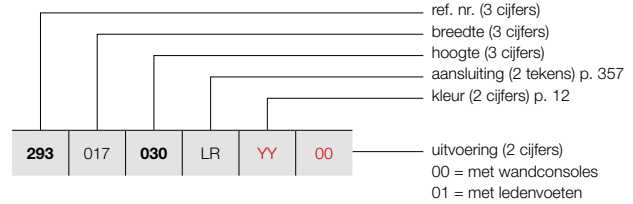

### PRIJSGROEP: VPG5 - KOLOMRADIATOREN

BESTELCODE MAATWERK VINTAGE 50	TECHNISCHE GEGEVENS										STANDAARDKLEUR	ANDERE KLEUREN
	buizen	breedte (L mm)	hoogte (H mm)	75/65/20 (Watt) (Ø50K)	55/45/20 (Watt) (Ø30K)	n-exp.	gewicht (kg)	inhoud (l)	el. weerst. (Watt)	prijs S600* (€)	prijs kleur (€)	
REF. NR. VINTAGE 50 VINTAGE 50/D250 : 293												
293 017 030 LR YY 00	3	178	300	186	98	1,26	4,56	2,97	-	429	493	
293 022 030 LR YY 00	4	228	300	248	130	1,26	6,08	3,96	-	452	520	
293 027 030 LR YY 00	5	278	300	310	163	1,26	7,60	4,95	-	475	546	
293 032 030 LR YY 00	6	328	300	372	195	1,26	9,12	5,94	-	498	573	
293 037 030 LR YY 00	7	378	300	434	228	1,26	10,64	6,93	-	519	597	
293 042 030 LR YY 00	8	428	300	496	261	1,26	12,16	7,92	-	553	636	
293 047 030 LR YY 00	9	478	300	558	293	1,26	13,68	8,91	-	573	659	
293 052 030 LR YY 00	10	528	300	620	326	1,26	15,20	9,90	-	594	683	
293 057 030 LR YY 00	11	578	300	682	358	1,26	16,72	10,89	-	625	719	
293 062 030 LR YY 00	12	628	300	744	391	1,26	18,34	11,88	-	649	746	
293 067 030 LR YY 00	13	678	300	806	423	1,26	19,76	12,87	-	669	769	
293 072 030 LR YY 00	14	728	300	868	456	1,26	21,28	13,86	-	690	794	
293 077 030 LR YY 00	15	778	300	930	489	1,26	22,80	14,85	-	716	823	
293 082 030 LR YY 00	16	828	300	992	521	1,26	24,32	15,84	-	736	846	
293 087 030 LR YY 00	17	878	300	1054	554	1,26	25,84	16,83	-	758	872	
293 092 030 LR YY 00	18	928	300	1116	586	1,26	27,36	17,82	-	783	900	
293 097 030 LR YY 00	19	978	300	1178	619	1,26	28,88	18,81	-	804	925	
293 102 030 LR YY 00	20	1028	300	1240	651	1,26	30,40	19,80	-	826	950	
293 107 030 LR YY 00	21	1078	300	1302	684	1,26	31,92	20,79	-	863	992	
293 112 030 LR YY 00	22	1128	300	1364	717	1,26	33,44	21,78	-	882	1014	
293 117 030 LR YY 00	23	1178	300	1426	749	1,26	34,96	22,77	-	911	1048	
293 122 030 LR YY 00	24	1228	300	1488	782	1,26	36,68	23,76	-	929	1068	
293 127 030 LR YY 00	25	1278	300	1550	814	1,26	38,00	24,75	-	954	1097	
293 132 030 LR YY 00	26	1328	300	1612	847	1,26	39,52	25,74	-	997	1147	
293 137 030 LR YY 00	27	1378	300	1674	879	1,26	41,04	26,73	-	1021	1174	
293 142 030 LR YY 00	28	1428	300	1736	912	1,26	42,56	27,72	-	1043	1199	
293 147 030 LR YY 00	29	1478	300	1798	945	1,26	44,08	28,71	-	1066	1226	

Conform EN442-1: 2014: radiatoren en convectoren

\* RAL 9016: geen meerprijs 15%  
Voor meer details over onze artikel-data, zie artikel-database: <https://www.installdata.be>  
Voor de warmteafgiftes van andere regimes, kijkt u op p. 370 (correctiefactoren)  
BELGIË. Prijzen in euro (excl. BTW)

# HOE VINTAGE 50 BESTELLEN

Leveringstermijn 15 - 30 werkdagen  
(zonder transportduur)

# VINTAGE (VINTAGE 50 / D250)

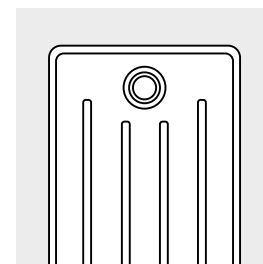
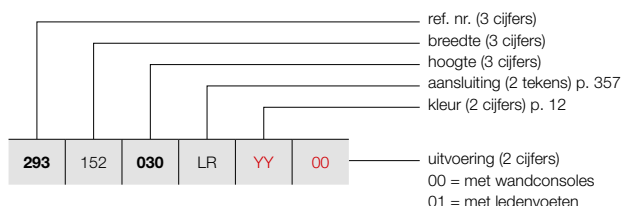

VINTAGE 50 / D250

## PRIJSGROEP: VPG5 - KOLOMRADIATOREN

BESTELCODE MAATWERK VINTAGE 50	TECHNISCHE GEGEVENS										STANDAARDKLEUR	ANDERE KLEUREN
	buizen	breedte (L mm)	hoogte (H mm)	75/65/20 (Watt) (Φ50K)	55/45/20 (Watt) (Φ30K)	n-exp.	gewicht (kg)	inhoud (l)	el. weerst. (Watt)	prijs S600* (€)		
REF. NR. VINTAGE 50 VINTAGE 50/D250 : 293												
293 152 030 LR YY 00	30	1528	300	1860	977	1,26	45,60	29,70	-	1086	1249	
293 157 030 LR YY 00	31	1578	300	1922	1010	1,26	47,12	30,69	-	1111	1278	
293 162 030 LR YY 00	32	1628	300	1984	1042	1,26	48,64	31,68	-	1134	1304	
293 167 030 LR YY 00	33	1678	300	2046	1075	1,26	50,16	32,67	-	1198	1378	
293 172 030 LR YY 00	34	1728	300	2108	1107	1,26	51,68	33,66	-	1223	1406	
293 177 030 LR YY 00	35	1778	300	2170	1140	1,26	53,20	34,65	-	1240	1426	
293 182 030 LR YY 00	36	1828	300	2232	1173	1,26	55,02	35,64	-	1273	1464	
293 187 030 LR YY 00	37	1878	300	2294	1205	1,26	56,24	36,63	-	1294	1488	
293 192 030 LR YY 00	38	1928	300	2356	1238	1,26	57,76	37,62	-	1316	1513	
293 197 030 LR YY 00	39	1978	300	2418	1270	1,26	59,28	38,61	-	1336	1536	
293 202 030 LR YY 00	40	2028	300	2480	1303	1,26	60,80	39,60	-	1362	1566	
293 207 030 LR YY 00	41	2078	300	2542	1336	1,26	62,32	40,59	-	1385	1593	
293 212 030 LR YY 00	42	2128	300	2604	1368	1,26	63,84	41,58	-	1404	1615	
293 217 030 LR YY 00	43	2178	300	2666	1401	1,26	65,36	42,57	-	1431	1646	
293 222 030 LR YY 00	44	2228	300	2728	1433	1,26	66,88	43,56	-	1447	1664	
293 227 030 LR YY 00	45	2278	300	2790	1466	1,26	68,40	44,55	-	1476	1697	
293 232 030 LR YY 00	46	2328	300	2852	1498	1,26	69,92	45,54	-	1492	1716	
293 237 030 LR YY 00	47	2378	300	2914	1531	1,26	71,44	46,53	-	1519	1747	
293 242 030 LR YY 00	48	2428	300	2976	1564	1,26	73,36	47,52	-	1541	1772	
293 247 030 LR YY 00	49	2478	300	3038	1596	1,26	74,48	48,51	-	1562	1796	
293 252 030 LR YY 00	50	2528	300	3100	1629	1,26	76,00	49,50	-	1585	1823	
293 257 030 LR YY 00	51	2578	300	3162	1661	1,26	77,52	50,49	-	1631	1876	
293 262 030 LR YY 00	52	2628	300	3224	1694	1,26	79,04	51,48	-	1653	1901	
293 267 030 LR YY 00	53	2678	300	3286	1726	1,26	80,56	52,47	-	1674	1925	
293 272 030 LR YY 00	54	2728	300	3348	1759	1,26	82,08	53,46	-	1696	1950	
293 277 030 LR YY 00	55	2778	300	3410	1792	1,26	83,60	54,45	-	1720	1978	
293 282 030 LR YY 00	56	2828	300	3472	1824	1,26	85,12	55,44	-	1741	2002	

Conform EN442-1: 2014: radiatoren en convectoren

\* RAL 9016: geen meerprijs 15%  
 Voor meer details over onze artikel-data, zie artikel-database: <https://www.installdata.be>  
**Voor de warmteafgiftes van andere regimes, kijkt u op p. 370 (correctiefactoren)**  
**BELGIË. Prijzen in euro (excl. BTW)**

## VINTAGE (VINTAGE 50 / D250)

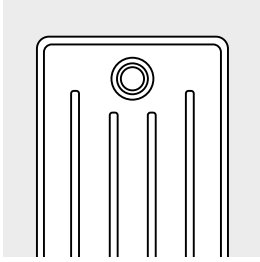

VINTAGE 50 / D250

### HOE VINTAGE 50 BESTELLEN

Leveringstermijn 15 - 30 werkdagen  
(zonder transportduur)

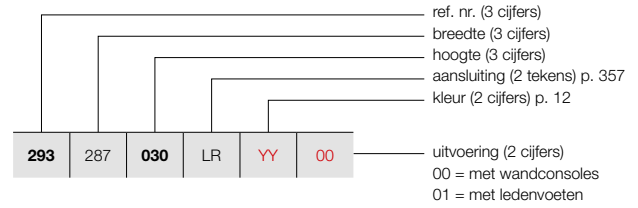

### PRIJSGROEP: VPG5 - KOLOMRADIATOREN

BESTELCODE MAATWERK VINTAGE 50	TECHNISCHE GEGEVENS										STANDAARDKLEUR	ANDERE KLEUREN
	buizen	breedte (L mm)	hoogte (H mm)	75/65/20 (Watt) (Φ50K)	55/45/20 (Watt) (Φ30K)	n-exp.	gewicht (kg)	inhoud (l)	el. weerst. (Watt)	prijs S600* (€)	prijs kleur (€)	
REF. NR. VINTAGE 50 VINTAGE 50/D250 : 293												
<b>293</b>   287   <b>030</b>   LR   <b>YY</b>   <b>00</b>	57	2878	300	3534	1857	1,26	86,64	56,43	-	<b>1764</b>	<b>2029</b>	
<b>293</b>   292   <b>030</b>   LR   <b>YY</b>   <b>00</b>	58	2928	300	3596	1889	1,26	88,16	57,42	-	<b>1787</b>	<b>2055</b>	
<b>293</b>   297   <b>030</b>   LR   <b>YY</b>   <b>00</b>	59	2978	300	3658	1922	1,26	89,68	58,41	-	<b>1810</b>	<b>2082</b>	
<b>293</b>   302   <b>030</b>   LR   <b>YY</b>   <b>00</b>	60	3028	300	3720	1954	1,26	91,70	59,40	-	<b>1833</b>	<b>2108</b>	



Conform EN442-1: 2014: radiatoren en convectoren

\* RAL 9016: geen meerprijs 15%

Voor meer details over onze artikel-data, zie artikel-database: <https://www.installdata.be>

**Voor de warmteafgifte van andere regimes, kijkt u op p. 370 (correctiefactoren)**  
**BELGIË. Prijzen in euro (excl. BTW)**

PRIJSGROEP: VPG10 - ACC.

BEVESTIGINGEN		VINTAGE 50	KLEUR
WANDBEVESTIGING			in de kleur van de radiator*
LEDENVOETEN		VINTAGE 50 2 voeten voor 25 leden 3 voeten voor 50 leden 4 voeten voor 60 leden	in de kleur van de radiator*

\* Voeten en bevestigingen voor radiatoren in transparante coating zijn gelakt in de kleur N507.

## VINTAGE AANSLUITINGEN

### VINTAGE: VINTAGE 50

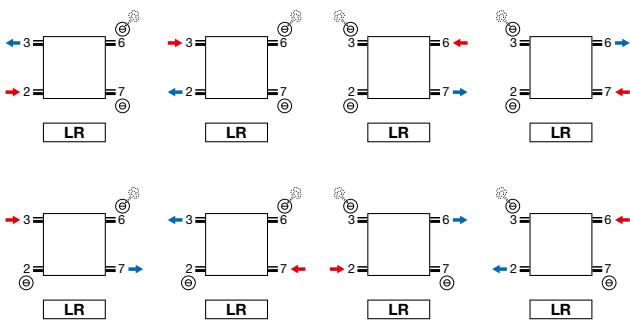

- Ontluchter in aansluiting 3 of 6.

### VINTAGE: VINTAGE 50

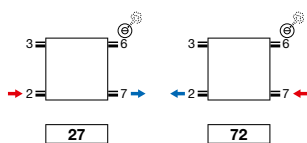

- Ontluchter in aansluiting 3 of 6.
- Aansluitingen op speciale aanvraag: meerprijs €75

**Opmerking:** het aansluiten van de radiator kan enkel volgens de getoonde aansluiticonen. Voor elke andere aansluitwijze nemen wij geen verantwoordelijkheid.

**VINTAGE** (VINTAGE 50)

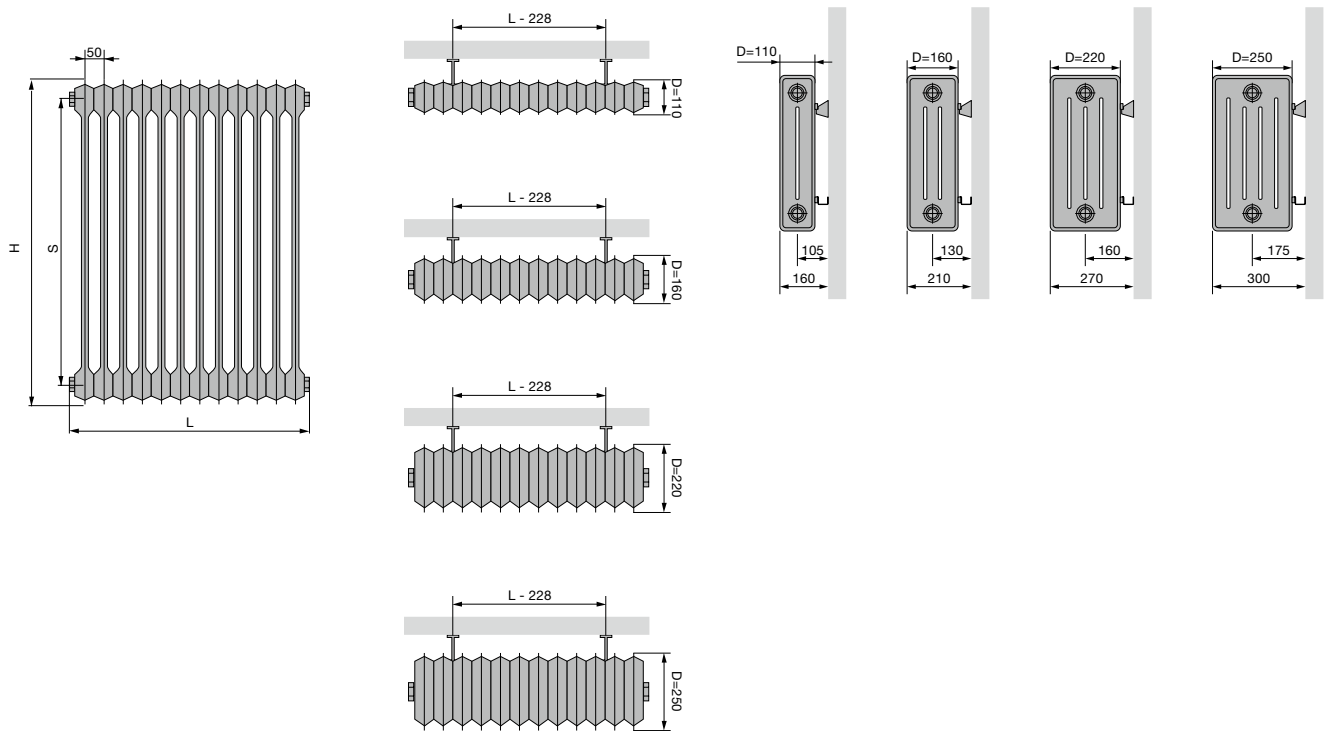

**VINTAGE 50**

Hoogte (H)	300	450	600	1000
Hartafstand tussen de zijaansluitingen (S)	200	350	500	900

VINTAGE (VINTAGE 50)

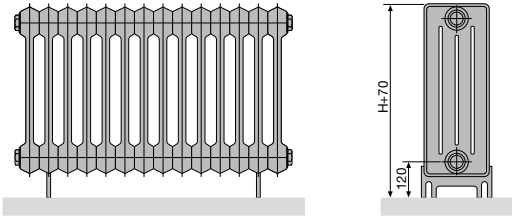

VINTAGE 50 (VLOERMONTAGE)

Aantal leden	2-25	26-50	51-60
Aantal voeten	2	3	4

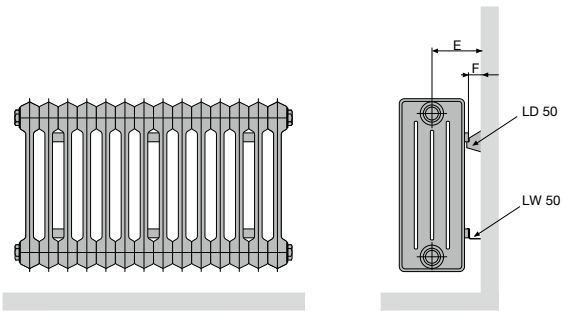

VINTAGE 50 (WANDMONTAGE) LD 50 + LW 50

Diepte (D)	110	160	220	250
Afstand tussen wand en aansluiting (E)	105	130	160	175
Afstand tussen wand en achterkant radiator (F)	50			

VINTAGE 50 (WANDMONTAGE)

Aantal leden	3-5	6-25	26-50	51-60
Aantal muurbevestigingen set LD 50 + LW 50	1	2	3	4

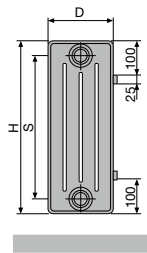

VINTAGE 50

Hoogte (H)	300	450	600	1000
Hartafstand tussen de zijansluitingen (S)	200	350	500	900

