

Kolomradiatoren



De VASCO kolomradiator koppelt een groot vermogen aan een snelle warmteafgifte.

Hij kan zowel tegen de wand als vrijstaand worden geïnstalleerd en levert ook topprestaties in combinatie met lage watertemperatuursystemen zoals warmtepompen. **Een retro radiator in de meest duurzame zin van het woord.**

De VASCO kolomradiator is tot in het kleinste detail op een zuinig en duurzaam energieverbruik afgestemd.

Met slimme aansluitingen en bevestigingssystemen en innoverende technologische oplossingen.

Kolomradiatoren

Ritmo	302
Vintage	320

RITMO VERTICAAL (VB-2K/65, VB-3K/105, VB-4K/145)



RITMO VERTICAAL

Hoge warmteafgifte

Met hun hoge warmteafgifte brengen VASCO's Ritmo-kolomradiatoren zelfs de grootste ruimtes in een mum van tijd op de gewenste temperatuur, zonder dat je dat merkt aan je energiefactuur. Door hun groot verwarmingsoppervlak zijn ze uitermate geschikt voor lage temperatuurverwarming. Zo geniet je van aangename temperaturen en een comfortabel binnenklimaat.

TYPES

- 2 / 3 / 4 kolommen
- Bouwdiepte: 65 / 105 / 145 mm
- Bouwhoogte: 1500, 1800, 2000, 2200 mm
- Bouwlengte: 270, 360, 450, 540, 630, 720 mm

BUIZEN

- Verticaal, 25 mm

KLEUREN

- Standaardkleur wit RAL 9016
- Uitgebreide kleurenkaart zie p. 12

BEVESTIGINGEN

- Wandmontage
- Muurbevestigingen standaard
- Bij witte radiatoren wordt standaard een witte klemconsole 30 mm en een witte afstandshouder geleverd
- Bij gekleurde radiatoren wordt standaard een klemconsole 30 mm in de kleur van de radiator en een afstandshouder in RAL 7024 geleverd

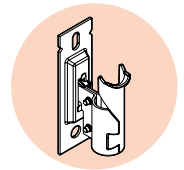

TECHNISCH

- Bestaande uit kopstukken (bandstaal persdelen) en ronde buizen.
- ATL-grondlaag, poedercoating
- Standaardwerkdruk: 10 bar
- Maximale bedrijfstemperatuur: 110°C

TECHNISCHE TEKENINGEN

- Zie p. 318

AANSLUITING

- ✗ Eénpuntsaansluiting voor éénpijpsysteem
- ✗ Eénpuntsaansluiting voor tweepijpsysteem
- ✓ Tweepuntsaansluiting voor éénpijpsysteem (aansluiting via de middenaansluiting) (zie p. 340)
- ✓ Tweepuntsaansluiting voor tweepijpsysteem (standaard) (zie p. 340)
- ✗ Geïntegreerd ventiel
- Aansluitingen: 1/2" (binnendraad)

AANBEVOLEN AANSLUITING (MM)

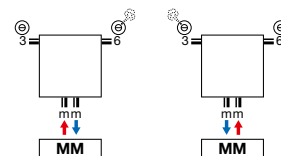

Andere aansluitmogelijkheden, zie p. 317



wit
art. nr.
1182 001 0000 9016
prijs € 138



chrom
art. nr.
1182 001 0000 0099
prijs € 159

AANBEVOLEN VOOR BADKAMER EN KEUKEN IN OPTIE



handdoekbeugel (chrom)
art. nr. zie p. 316
prijs € 138



wit
art. nr. 11911630102
prijs € 50



chrom
art. nr. 11911631102
prijs € 64



HOE RITMO VERTICAAL BESTELLEN

Leveringstermijn 15 - 30 werkdagen
(zonder transportduur)

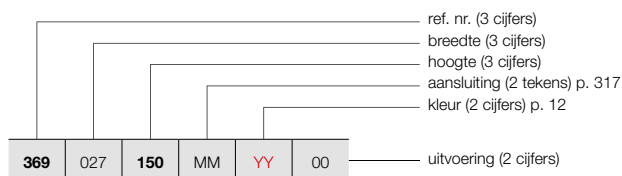

RITMO VERTICAAL (2-KOLOM)



RITMO VB-2K/65
(2-KOLOM)

PRIJSGROEP: VPG5 - KOLOMRADIATOREN

BESTELCODE MAATWERK RITMO VERTICAAL	TECHNISCHE GEGEVENS								STANDAARDKLEUR		ANDERE KLEUREN					
	buizen	breedte (L mm)	hoogte (H mm)	75/65/20 (Watt) (Φ50K)	55/45/20 (Watt) (Φ30K)	n-exp.	gewicht (kg)	inhoud (l)	el. weerst. (Watt)	prijs RAL 9016 (€)	prijs kleur (€)					
REF. NR. RITMO VERTICAAL VB-2K/65 : 369																
369	027	150	MM	YY	00	6	270	1500	654	333	1,32	11,58	7,92	-	390	449
		180				6	270	1800	780	397	1,32	13,74	9,36	-	439	505
		200				6	270	2000	864	440	1,32	15,18	10,32	-	493	567
		220				6	270	2200	948	483	1,32	16,68	11,28	-	655	753
369	036	150	MM	YY	00	8	360	1500	872	444	1,32	15,44	10,56	-	460	529
		180				8	360	1800	1040	530	1,32	18,32	12,48	-	520	598
		200				8	360	2000	1152	587	1,32	20,24	13,76	-	580	667
		220				8	360	2200	1264	644	1,32	22,24	15,04	-	735	845
369	045	150	MM	YY	00	10	450	1500	1090	555	1,32	19,30	13,20	-	530	610
		180				10	450	1800	1300	662	1,32	22,90	15,60	-	605	696
		200				10	450	2000	1440	734	1,32	25,30	17,20	-	650	748
		220				10	450	2200	1580	805	1,32	27,80	18,80	-	817	940
369	054	150	MM	YY	00	12	540	1500	1308	666	1,32	23,16	15,84	-	620	713
		180				12	540	1800	1560	795	1,32	27,48	18,72	-	700	805
		200				12	540	2000	1728	880	1,32	30,36	20,64	-	770	886
		220				12	540	2200	1896	966	1,32	33,36	22,56	-	895	1029
369	063	150	MM	YY	00	14	630	1500	1526	778	1,32	27,02	18,48	-	710	817
		180				14	630	1800	1820	927	1,32	32,06	21,84	-	795	914
		200				14	630	2000	2016	1027	1,32	35,42	24,08	-	890	1024
		220				14	630	2200	2212	1127	1,32	38,92	26,32	-	976	1122
369	072	150	MM	YY	00	16	720	1500	1744	889	1,32	30,88	21,12	-	800	920
		180				16	720	1800	2080	1060	1,32	36,64	24,96	-	895	1029
		200				16	720	2000	2304	1174	1,32	40,48	27,52	-	990	1139
		220				16	720	2200	2528	1288	1,32	44,48	30,08	-	1054	1212

Conform EN442-1: 2014: radiatoren en convectoren

Voor meer details over onze artikel-data, zie artikel-database: <https://www.2ba.nl>

Voor de warmteafgifte van andere regimes, kijkt u op p. 348 (correctiefactoren)
NEDERLAND. Prijzen in euro (excl. BTW)

RITMO VERTICAAL (3-KOLOM)



RITMO VB-3K/105
(3-KOLOM)

HOE RITMO VERTICAAL BESTELLEN

Leveringstermijn 15 - 30 werkdagen
(zonder transportduur)

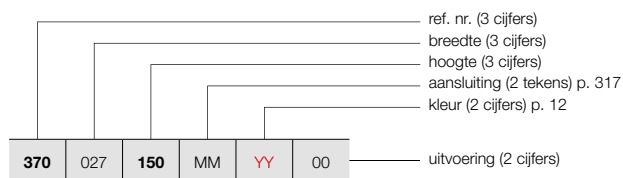

PRIJSGROEP: VPG5 - KOLOMRADIATOREN

BESTELCODE MAATWERK RITMO VERTICAAL	TECHNISCHE GEGEVENS									STANDAARDKLEUR	ANDERE KLEUREN
	buizen	breedte (L mm)	hoogte (H mm)	75/65/20 (Watt) (Φ50K)	55/45/20 (Watt) (Φ30K)	n-exp.	gewicht (kg)	inhoud (l)	el. weerst. (Watt)	prijs RAL 9016 (€)	prijs kleur (€)
REF. NR. RITMO VERTICAAL VB-3K/105 : 370											
370	027	150	MM	YY	00						
		180								510	587
		200								589	677
		220								602	692
										717	825
370	036	150	MM	YY	00						
		180								600	690
		200								699	804
		220								732	842
										846	973
370	045	150	MM	YY	00						
		180								685	788
		200								800	920
		220								845	972
										983	1130
370	054	150	MM	YY	00						
		180								800	920
		200								950	1093
		220								994	1143
										1150	1323
370	063	150	MM	YY	00						
		180								920	1058
		200								1068	1228
		220								1127	1296
										1286	1479
370	072	150	MM	YY	00						
		180								1025	1179
		200								1212	1394
		220								1242	1428
										1436	1651

Conform EN442-1: 2014: radiatoren en convectoren

Voor meer details over onze artikel-data, zie artikel-database: <https://www.2ba.nl>

Voor de warmteafgiftes van andere regimes, kijkt u op p. 348 (correctiefactoren)
NEDERLAND. Prijzen in euro (excl. BTW)

HOE RITMO VERTICAAL BESTELLEN

Leveringstermijn 15 - 30 werkdagen
(zonder transportduur)

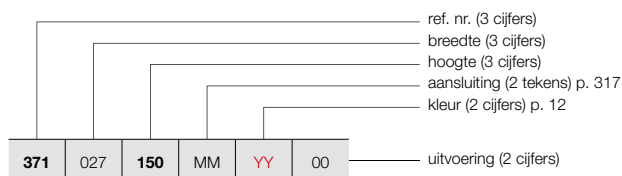

RITMO VERTICAAL (4-KOLOM)



RITMO VB-4K/145
(4-KOLOM)

PRIJSGROEP: VPG5 - KOLOMRADIATOREN

BESTELCODE MAATWERK RITMO VERTICAAL	TECHNISCHE GEGEVENS								STANDAARDKLEUR	ANDERE KLEUREN						
	buizen	breedte (L mm)	hoogte (H mm)	75/65/20 (Watt) (Φ50K)	55/45/20 (Watt) (Φ30K)	n-exp.	gewicht (kg)	inhoud (l)			el. weerst. (Watt)	prijs RAL 9016 (€)	prijs kleur (€)			
REF. NR. RITMO VERTICAAL VB-4K/145 : 371																
371	027	150	MM	YY	00	6	270	1500	1116	560	1,35	23,10	15,60	-	622	715
		180				6	270	1800	1314	663	1,34	27,48	18,48	-	746	858
		200				6	270	2000	1446	729	1,34	30,36	20,40	-	792	911
		220				6	270	2200	1572	793	1,34	33,30	22,32	-	958	1102
371	036	150	MM	YY	00	8	360	1500	1488	747	1,35	30,80	20,80	-	733	843
		180				8	360	1800	1752	884	1,34	36,64	24,64	-	888	1021
		200				8	360	2000	1928	972	1,34	40,48	27,20	-	952	1095
		220				8	360	2200	2096	1057	1,34	44,40	29,76	-	1106	1272
371	045	150	MM	YY	00	10	450	1500	1860	933	1,35	38,50	26,00	-	850	978
		180				10	450	1800	2190	1105	1,34	45,80	30,80	-	997	1147
		200				10	450	2000	2410	1215	1,34	50,60	34,00	-	1110	1277
		220				10	450	2200	2620	1321	1,34	55,50	37,20	-	1250	1438
371	054	150	MM	YY	00	12	540	1500	2232	1120	1,35	46,20	31,20	-	989	1137
		180				12	540	1800	2628	1325	1,34	54,96	36,96	-	1133	1303
		200				12	540	2000	2892	1459	1,34	60,72	40,80	-	1365	1570
		220				12	540	2200	3144	1586	1,34	66,60	44,64	-	1450	1668
371	063	150	MM	YY	00	14	630	1500	2604	1307	1,35	53,90	36,40	-	1138	1309
		180				14	630	1800	3066	1546	1,34	64,12	43,12	-	1336	1536
		200				14	630	2000	3374	1702	1,34	70,84	47,60	-	1540	1771
		220				14	630	2200	3668	1850	1,34	77,70	52,08	-	1700	1955
371	072	150	MM	YY	00	16	720	1500	2976	1493	1,35	61,60	41,60	-	1262	1451
		180				16	720	1800	3504	1767	1,34	73,28	49,28	-	1572	1808
		200				16	720	2000	3856	1945	1,34	80,96	54,40	-	1756	2019
		220				16	720	2200	4192	2114	1,34	88,80	59,52	-	1911	2198

Conform EN442-1: 2014: radiatoren en convectoren

Voor meer details over onze artikel-data, zie artikel-database: <https://www.2ba.nl>

Voor de warmteafgifte van andere regimes, kijkt u op p. 348 (correctiefactoren)
NEDERLAND. Prijzen in euro (excl. BTW)

RITMO HORIZONTAAL (HB-2K/65, HB-3K/105, HB-4K/145)

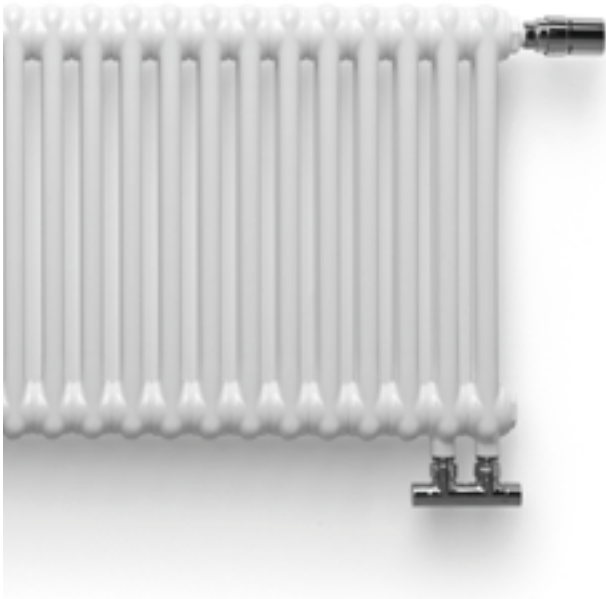

TYPES

- 2 / 3 / 4 kolommen
- Bouwdiepte: 65 / 105 / 145 mm
- Bouwhoogte: 300, 400, 500, 600, 900 mm
- Bouwlengte: 450, 540, 630, 720, 810, 900, 990, 1080, 1170, 1260, 1350, 1440, 1530, 1620, 1710, 1800 mm

BUIZEN

- Verticaal, 25 mm

KLEUREN

- Standaardkleur wit RAL 9016
- Uitgebreide kleurenkaart zie p. 12

BEVESTIGINGEN

- Vloer- of wandmontage
- Muurbevestigingen standaard
- Bij witte radiatoren wordt standaard een witte klemconsole 30 mm en een witte afstandshouder geleverd
- Bij gekleurde radiatoren wordt standaard een klemconsole 30 mm in de kleur van de radiator en een afstandshouder in RAL 7024 geleverd

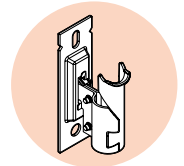

TECHNISCH

- Bestaande uit kopstukken (bandstaal persdelen) en ronde buizen.
- ATL-grondlaag, poedercoating
- Standaardwerkdruk: 10 bar
- Maximale bedrijfstemperatuur: 110°C

TECHNISCHE TEKENINGEN

- Zie p. 318

AANSLUITING

- ✗ Eénpuntsaansluiting voor éénpijpssysteem
- ✗ Eénpuntsaansluiting voor tweepijpssysteem
- ✓ Tweepuntsaansluiting voor éénpijpssysteem (aansluiting via het geïntegreerd ventiel) (zie p. 342)
- ✓ Tweepuntsaansluiting voor tweepijpssysteem (standaard) (zie p. 340)
- ✓ Geïntegreerd ventiel (aansluiting VR) (**meerprijs: €77**) (thermostaatkop apart te bestellen, zie p. 316)
- Aansluitingen: 1/2" (binnendraad)

RITMO HORIZONTAAL

Van klassiek tot modern

Het authentieke karakter van de Ritmo-kolomradiator is voor heel wat design-liefhebbers een schot in de roos. Omdat ze in hoge hoogtematen beschikbaar zijn, komen deze designradiatoren optimaal tot hun recht in grote, hoge en open interieurs, van klassieke herenhuisen tot moderne industriële lofts. Deze radiatoren worden ook vaak toegepast in openbare ruimtes, aangezien ze met hun relatief brede openingen makkelijk te reinigen en dus erg onderhoudsvriendelijk zijn. Met hun karakteristieke retro-uitstraling zijn deze kolomradiatoren in vele uitvoeringen beschikbaar: in horizontale of verticale variant en in 2, 3 of 4 kolommen.

AANBEVOLEN AANSLUITING GEÏNTEGREERD VENTIEL

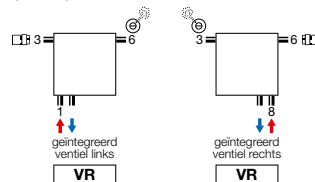

Andere aansluitmogelijkheden, zie p. 317

AANBEVOLEN VOOR BADKAMER EN KEUKEN IN OPTIE



handdoekbeugel (chrom) art. nr. zie p. 316
prijs € 138



art. nr. 118230100000099
prijs € 159



wit art. nr. 11911630102
prijs € 50



chrom art. nr. 11911631102
prijs € 64



HOE RITMO HORIZONTAAL BESTELLEN

Leveringstermijn 15 - 30 werkdagen
(zonder transportduur)

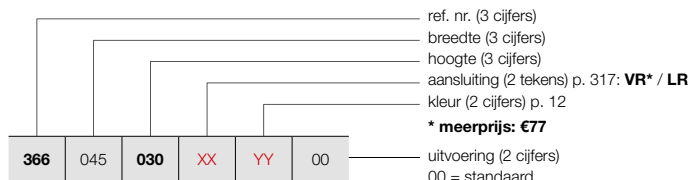

RITMO HORIZONTAAL (2-KOLOM)



RITMO HB-2K/65
(2-KOLOM) 4-AANSLUITINGEN



RITMO HB-2K/65
(2-KOLOM) GEÏNTEGREERD VENTIEL
(thermostaatkop apart te bestellen)

PRIJSGROEP: VPG5 - KOLOMRADIATOREN

BESTELCODE MAATWERK RITMO HORIZONTAAL	TECHNISCHE GEGEVENS							STANDAARDKLEUR		ANDERE KLEUREN	
	buizen	breedte (L mm)	hoogte (H mm)	75/65/20 (Watt) (φ50K)	55/45/20 (Watt) (φ30K)	n-exp.	gewicht (kg)	inhoud (l)	el. weerst. (Watt)	prijs RAL 9016 (€)	prijs kleur (€)
REF. NR. RITMO HORIZONTAAL HB-2K/65 : 366											
366 045 030 XX YY 00	10	450	300	240	123	1,26	4,70	3,70	-	270	311
	10	450	400	310	158	1,31	5,90	4,50	-	280	322
	10	450	500	390	200	1,31	7,10	5,30	-	290	334
	10	450	600	460	235	1,31	8,30	6,10	-	300	345
	10	450	900	670	343	1,31	12,00	8,40	-	333	383
	10	450	900	670	343	1,31	12,00	8,40	-	333	383
366 054 030 XX YY 00	12	540	300	288	147	1,26	5,64	4,44	-	320	368
	12	540	400	372	190	1,31	7,08	5,40	-	330	380
	12	540	500	468	240	1,31	8,52	6,36	-	340	391
	12	540	600	552	283	1,31	9,96	7,32	-	350	403
	12	540	900	804	412	1,31	14,40	10,08	-	383	440
	12	540	900	804	412	1,31	14,40	10,08	-	383	440
366 063 030 XX YY 00	14	630	300	336	172	1,26	6,58	5,18	-	380	437
	14	630	400	434	222	1,31	8,26	6,30	-	390	449
	14	630	500	546	280	1,31	9,94	7,42	-	400	460
	14	630	600	644	330	1,31	11,62	8,54	-	410	472
	14	630	900	938	481	1,31	16,80	11,76	-	443	509
	14	630	900	938	481	1,31	16,80	11,76	-	443	509
366 072 030 XX YY 00	16	720	300	384	196	1,26	7,52	5,92	-	440	506
	16	720	400	496	254	1,31	9,44	7,20	-	450	518
	16	720	500	624	320	1,31	11,36	8,48	-	460	529
	16	720	600	736	377	1,31	13,28	9,76	-	470	541
	16	720	900	1072	549	1,31	19,20	13,44	-	503	578
	16	720	900	1072	549	1,31	19,20	13,44	-	503	578
366 081 030 XX YY 00	18	810	300	432	221	1,26	8,46	6,66	-	500	575
	18	810	400	558	286	1,31	10,62	8,10	-	510	587
	18	810	500	702	360	1,31	12,78	9,54	-	520	598
	18	810	600	828	424	1,31	14,94	10,98	-	530	610
	18	810	900	1206	618	1,31	21,60	15,12	-	563	647
	18	810	900	1206	618	1,31	21,60	15,12	-	563	647
366 090 030 XX YY 00	20	900	300	480	246	1,26	9,40	7,40	-	540	621
	20	900	400	620	317	1,31	11,80	9,00	-	550	633
	20	900	500	780	400	1,31	14,20	10,60	-	560	644
	20	900	600	920	471	1,31	16,60	12,20	-	570	656
	20	900	900	1340	687	1,31	24,00	16,80	-	603	693
	20	900	900	1340	687	1,31	24,00	16,80	-	603	693
366 099 030 XX YY 00	22	990	300	528	270	1,26	10,34	8,14	-	570	656
	22	990	400	682	349	1,31	12,98	9,90	-	580	667
	22	990	500	858	440	1,31	15,62	11,66	-	590	679
	22	990	600	1012	518	1,31	18,26	13,42	-	600	690
	22	990	900	1474	755	1,31	26,40	18,48	-	633	728
	22	990	900	1474	755	1,31	26,40	18,48	-	633	728
366 108 030 XX YY 00	24	1080	300	576	295	1,26	11,28	8,88	-	600	690
	24	1080	400	744	381	1,31	14,16	10,80	-	610	702
	24	1080	500	936	480	1,31	17,04	12,72	-	620	713
	24	1080	600	1104	566	1,31	19,92	14,64	-	630	725
	24	1080	900	1608	824	1,31	28,80	20,16	-	663	762
	24	1080	900	1608	824	1,31	28,80	20,16	-	663	762

Conform EN442-1: 2014: radiatoren en convectoren

Voor meer details over onze artikel-data, zie artikel-database: <https://www.2ba.nl>

Voor de warmteafgiftes van andere regimes, kijkt u op p. 348 (correctiefactoren)
NEDERLAND. Prijzen in euro (excl. BTW)

VASCO

RITMO HORIZONTAAL (2-KOLOM)

HOE RITMO HORIZONTAAL BESTELLEN

Leveringstermijn 15 - 30 werkdagen
(zonder transportduur)

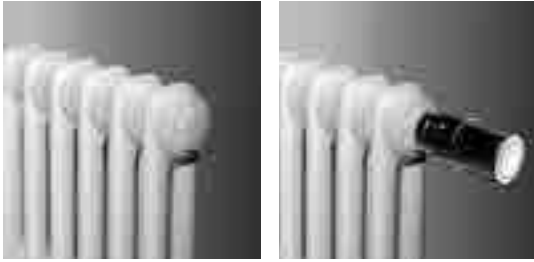

RITMO HB-2K/65
(2-KOLOM) 4-AANSLUITINGEN

RITMO HB-2K/65
(2-KOLOM) GEÏNTEGREERD VENTIEL
(thermostaatkop apart te bestellen)

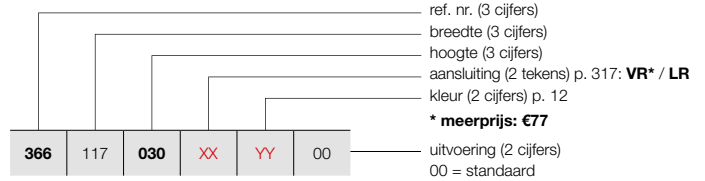

PRIJSGROEP: VPG5 - KOLOMRADIATOREN

BESTELCODE MAATWERK RITMO HORIZONTAAL	TECHNISCHE GEGEVENS									STANDAARDKLEUR	ANDERE KLEUREN
	buizen	breedte (L mm)	hoogte (H mm)	75/65/20 (Watt) (Ø50K)	55/45/20 (Watt) (Ø30K)	n-exp.	gewicht (kg)	inhoud (l)	el. weerst. (Watt)	prijs RAL 9016 (€)	prijs kleur (€)
REF. NR. RITMO HORIZONTAAL HB-2K/65 : 366											
366	117	030	XX	YY	00						
		040								655	753
		050								665	765
		060								675	776
		090								685	788
										718	826
366	126	030	XX	YY	00						
		040								710	817
		050								720	828
		060								730	840
		090								740	851
										773	889
366	135	030	XX	YY	00						
		040								770	886
		050								780	897
		060								790	909
		090								800	920
										833	958
366	144	030	XX	YY	00						
		040								830	955
		050								840	966
		060								850	978
		090								860	989
										893	1027
366	153	030	XX	YY	00						
		040								890	1024
		050								900	1035
		060								910	1047
		090								920	1058
										953	1096
366	162	030	XX	YY	00						
		040								950	1093
		050								960	1104
		060								970	1116
		090								980	1127
										1013	1165
366	171	030	XX	YY	00						
		040								1010	1162
		050								1020	1173
		060								1030	1185
		090								1040	1196
										1073	1234
366	180	030	XX	YY	00						
		040								1070	1231
		050								1080	1242
		060								1090	1254
		090								1100	1265
										1133	1303

Conform EN442-1: 2014: radiatoren en convectoren

Voor meer details over onze artikel-data, zie artikel-database: <https://www.2ba.nl>

Voor de warmteafgiftes van andere regimes, kijkt u op p. 348 (correctiefactoren)
NEDERLAND. Prijzen in euro (excl. BTW)

HOE RITMO HORIZONTAAL BESTELLEN

Leveringstermijn 15 - 30 werkdagen
(zonder transportduur)

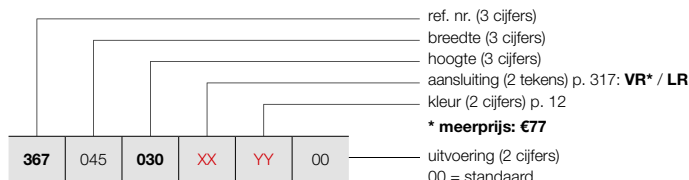

RITMO HORIZONTAAL (3-KOLOM)



RITMO HB-3K/105
(3-KOLOM) 4-AANSLUITINGEN



RITMO HB-3K/105
(3-KOLOM) GEÏNTEGREERD VENTIEL
(thermostaatkop apart te bestellen)

PRIJSGROEP: VPG5 - KOLOMRADIATOREN

BESTELCODE MAATWERK RITMO HORIZONTAAL	TECHNISCHE GEGEVENS							STANDAARDKLEUR		ANDERE KLEUREN	
	buizen	breedte (L mm)	hoogte (H mm)	75/65/20 (Watt) (φ50K)	55/45/20 (Watt) (φ30K)	n-exp.	gewicht (kg)	inhoud (l)	el. weerst. (Watt)	prijs RAL 9016 (€)	prijs kleur (€)
REF. NR. RITMO HORIZONTAAL HB-3K/105 : 367											
367 045 030 XX YY 00	10	450	300	330	167	1,33	7,00	5,30	-	316	363
	10	450	400	430	215	1,36	8,80	6,50	-	326	375
	10	450	500	530	265	1,36	10,60	7,70	-	336	386
	10	450	600	630	315	1,36	12,50	8,90	-	346	398
	10	450	900	920	459	1,36	17,90	12,50	-	395	454
	040										
050											
060											
090											
367 054 030 XX YY 00	12	540	300	396	201	1,33	8,40	6,36	-	368	423
	12	540	400	516	258	1,36	10,56	7,80	-	378	435
	12	540	500	636	258	1,36	12,72	9,24	-	388	446
	12	540	600	756	377	1,36	15,00	10,68	-	398	458
	12	540	900	1104	551	1,36	21,48	15,00	-	445	512
	040										
050											
060											
090											
367 063 030 XX YY 00	14	630	300	462	234	1,33	9,80	7,42	-	420	483
	14	630	400	602	301	1,36	12,32	9,10	-	430	495
	14	630	500	742	301	1,36	14,84	10,78	-	440	506
	14	630	600	882	440	1,36	17,50	12,46	-	450	518
	14	630	900	1288	643	1,36	25,06	17,50	-	500	575
	040										
050											
060											
090											
367 072 030 XX YY 00	16	720	300	528	268	1,33	11,20	8,48	-	478	550
	16	720	400	688	343	1,36	14,08	10,40	-	488	561
	16	720	500	848	343	1,36	16,96	12,32	-	498	573
	16	720	600	1008	503	1,36	20,00	14,24	-	508	584
	16	720	900	1472	735	1,36	28,64	20,00	-	568	653
	040										
050											
060											
090											
367 081 030 XX YY 00	18	810	300	594	301	1,33	12,60	9,54	-	535	615
	18	810	400	774	386	1,36	15,84	11,70	-	545	627
	18	810	500	954	386	1,36	19,08	13,86	-	555	638
	18	810	600	1134	566	1,36	22,50	16,02	-	565	650
	18	810	900	1656	827	1,36	32,22	22,50	-	628	722
	040										
050											
060											
090											
367 090 030 XX YY 00	20	900	300	660	335	1,33	14,00	10,60	-	590	679
	20	900	400	860	429	1,36	17,60	13,00	-	600	690
	20	900	500	1060	429	1,36	21,20	15,40	-	610	702
	20	900	600	1260	629	1,36	25,00	17,80	-	620	713
	20	900	900	1840	919	1,36	35,80	25,00	-	690	794
	040										
050											
060											
090											
367 099 030 XX YY 00	22	990	300	726	368	1,33	15,40	11,66	-	625	719
	22	990	400	946	472	1,36	19,36	14,30	-	635	730
	22	990	500	1166	472	1,36	23,32	16,94	-	645	742
	22	990	600	1386	692	1,36	27,50	19,58	-	655	753
	22	990	900	2024	1010	1,36	39,38	27,50	-	720	828
	040										
050											
060											
090											
367 108 030 XX YY 00	24	1080	300	792	401	1,33	16,80	12,72	-	660	759
	24	1080	400	1032	515	1,36	21,12	15,60	-	670	771
	24	1080	500	1272	515	1,36	25,44	18,48	-	680	782
	24	1080	600	1512	755	1,36	30,00	21,36	-	690	794
	24	1080	900	2208	1102	1,36	42,96	30,00	-	773	889
	040										
050											
060											
090											

Conform EN442-1: 2014: radiatoren en convectoren

Voor meer details over onze artikel-data, zie artikel-database: <https://www.2ba.nl>

Voor de warmteafgiftes van andere regimes, kijkt u op p. 348 (correctiefactoren)
NEDERLAND. Prijzen in euro (excl. BTW)

VASCO

RITMO HORIZONTAAL (3-KOLOM)

HOE RITMO HORIZONTAAL BESTELLEN

Leveringstermijn 15 - 30 werkdagen
(zonder transportduur)

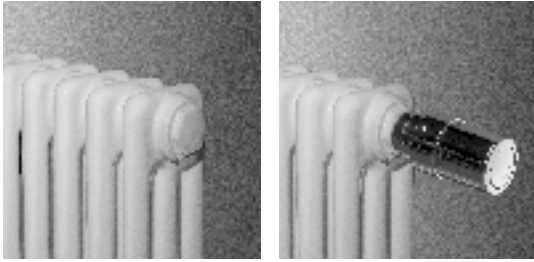

RITMO HB-3K/105
(3-KOLOM) 4-AANSLUITINGEN

RITMO HB-3K/105
(3-KOLOM) GEÏNTEGREERD VENTIEL
(thermostaatkop apart te bestellen)

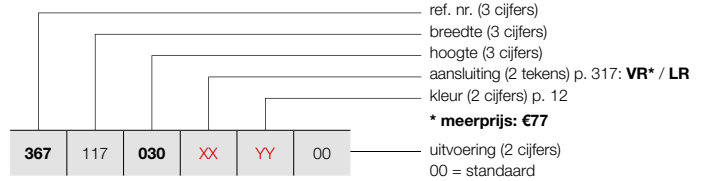

PRIJSGROEP: VPG5 - KOLONRADIATOREN

BESTELCODE MAATWERK RITMO HORIZONTAAL	TECHNISCHE GEGEVENS									STANDAARDKLEUR	ANDERE KLEUREN
	buizen	breedte (L mm)	hoogte (H mm)	75/65/20 (Watt) (Ø50K)	55/45/20 (Watt) (Ø30K)	n-exp.	gewicht (kg)	inhoud (l)	el. weerst. (Watt)	prijs RAL 9016 (€)	prijs kleur (€)
REF. NR. RITMO HORIZONTAAL HB-3K/105 : 367											
367	117	030	XX	YY	00						
		040								718	826
		050								728	837
		060								738	849
		090								748	860
										875	1006
367	126	030	XX	YY	00						
		040								770	886
		050								780	897
		060								790	909
		090								800	920
										940	1081
367	135	030	XX	YY	00						
		040								824	948
		050								834	959
		060								844	971
		090								854	982
										1000	1150
367	144	030	XX	YY	00						
		040								877	1009
		050								887	1020
		060								897	1032
		090								907	1043
										1060	1219
367	153	030	XX	YY	00						
		040								930	1070
		050								940	1081
		060								950	1093
		090								960	1104
										1130	1300
367	162	030	XX	YY	00						
		040								981	1128
		050								991	1140
		060								1001	1151
		090								1011	1163
										1200	1380
367	171	030	XX	YY	00						
		040								1040	1196
		050								1050	1208
		060								1060	1219
		090								1070	1231
										1260	1449
367	180	030	XX	YY	00						
		040								1105	1271
		050								1115	1282
		060								1125	1294
		090								1135	1305
										1335	1535

Conform EN442-1: 2014: radiatoren en convectoren

Voor meer details over onze artikel-data, zie artikel-database: <https://www.2ba.nl>

Voor de warmteafgifte van andere regimes, kijkt u op p. 348 (correctiefactoren)
NEDERLAND. Prijzen in euro (excl. BTW)

HOE RITMO HORIZONTAAL BESTELLEN

Leveringstermijn 15 - 30 werkdagen
(zonder transportduur)

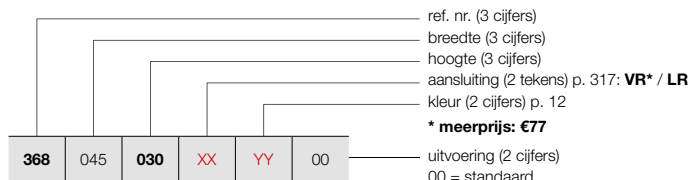

RITMO HORIZONTAAL (4-KOLOM)



RITMO HB-4K/145
(4-KOLOM) 4-AANSLUITINGEN



RITMO HB-4K/145
(4-KOLOM) GEÏNTEGREERD VENTIEL
(thermostaatkop apart te bestellen)

PRIJSGROEP: VPG5 - KOLOMRADIATOREN

BESTELCODE MAATWERK RITMO HORIZONTAAL	TECHNISCHE GEGEVENS							STANDAARDKLEUR		ANDERE KLEUREN	
	buizen	breedte (L mm)	hoogte (H mm)	75/65/20 (Watt) (φ50K)	55/45/20 (Watt) (φ30K)	n-exp.	gewicht (kg)	inhoud (l)	el. weerst. (Watt)	prijs RAL 9016 (€)	prijs kleur (€)
REF. NR. RITMO HORIZONTAAL HB-4K/145 : 368											
368 045 030 XX YY 00	040	450	300	430	218	1,33	9,30	6,90	-	373	429
	050	450	400	560	281	1,35	11,80	8,50	-	383	440
	060	450	500	690	346	1,35	14,20	10,10	-	393	452
	090	450	600	810	406	1,35	16,60	11,70	-	403	463
		450	900	1170	587	1,35	23,90	16,50	-	465	535
368 054 030 XX YY 00	040	540	300	516	262	1,33	11,16	8,28	-	425	489
	050	540	400	672	337	1,35	14,16	10,20	-	435	500
	060	540	500	828	415	1,35	17,04	12,12	-	445	512
	090	540	600	972	488	1,35	19,92	14,04	-	455	523
		540	900	1404	704	1,35	28,68	19,80	-	540	621
368 063 030 XX YY 00	040	630	300	602	305	1,33	13,02	9,66	-	480	552
	050	630	400	784	393	1,35	16,52	11,90	-	490	564
	060	630	500	966	485	1,35	19,88	14,14	-	500	575
	090	630	600	1134	569	1,35	23,24	16,38	-	510	587
		630	900	1638	822	1,35	33,46	23,10	-	645	742
368 072 030 XX YY 00	040	720	300	688	349	1,33	14,88	11,04	-	530	610
	050	720	400	896	450	1,35	18,88	13,60	-	540	621
	060	720	500	1104	554	1,35	22,72	16,16	-	550	633
	090	720	600	1296	650	1,35	26,56	18,72	-	560	644
		720	900	1872	939	1,35	38,24	26,40	-	735	845
368 081 030 XX YY 00	040	810	300	774	392	1,33	16,74	12,42	-	600	690
	050	810	400	1008	506	1,35	21,24	15,30	-	610	702
	060	810	500	1242	623	1,35	25,56	18,18	-	620	713
	090	810	600	1458	732	1,35	29,88	21,06	-	630	725
		810	900	2106	1057	1,35	43,02	29,70	-	825	949
368 090 030 XX YY 00	040	900	300	860	436	1,33	18,60	13,80	-	690	794
	050	900	400	1120	562	1,35	23,60	17,00	-	700	805
	060	900	500	1380	692	1,35	28,40	20,20	-	710	817
	090	900	600	1620	813	1,35	33,20	23,40	-	720	828
		900	900	2340	1174	1,35	47,80	33,00	-	915	1052
368 099 030 XX YY 00	040	990	300	946	480	1,33	20,46	15,18	-	720	828
	050	990	400	1232	618	1,35	25,96	18,70	-	730	840
	060	990	500	1518	762	1,35	31,24	22,22	-	740	851
	090	990	600	1782	894	1,35	36,52	25,74	-	750	863
		990	900	2574	1292	1,35	52,58	36,30	-	965	1110
368 108 030 XX YY 00	040	1080	300	1032	523	1,33	22,32	16,56	-	750	863
	050	1080	400	1344	674	1,35	28,32	20,40	-	760	874
	060	1080	500	1656	831	1,35	34,08	24,24	-	770	886
	090	1080	600	1944	975	1,35	39,84	28,08	-	780	897
		1080	900	2808	1409	1,35	57,36	39,60	-	1010	1162

Conform EN442-1: 2014: radiatoren en convectoren

Voor meer details over onze artikel-data, zie artikel-database: <https://www.2ba.nl>

Voor de warmteafgifte van andere regimes, kijkt u op p. 348 (correctiefactoren)
NEDERLAND. Prijzen in euro (excl. BTW)

RITMO HORIZONTAAL (4-KOLOM)

HOE RITMO HORIZONTAAL BESTELLEN

Leveringstermijn 15 - 30 werkdagen
(zonder transportduur)

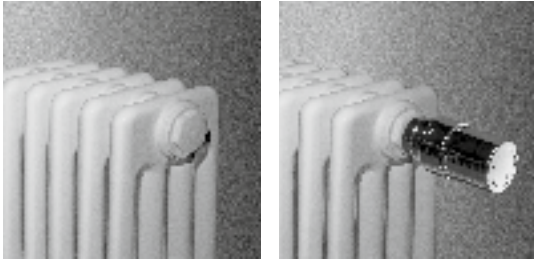

RITMO HB-4K/145
(4-KOLOM) 4-AANSLUITINGEN

RITMO HB-4K/145
(4-KOLOM) GEÏNTEGREERD VENTIEL
(thermostaatkop apart te bestellen)

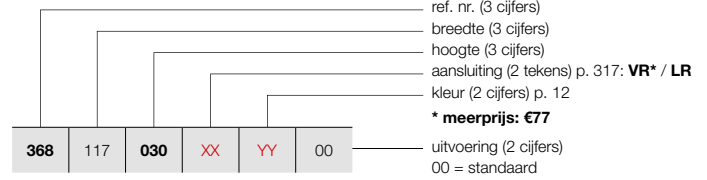

PRIJSGROEP: VPG5 - KOLOMRADIATOREN

BESTELCODE MAATWERK RITMO HORIZONTAAL	TECHNISCHE GEGEVENS									STANDAARDKLEUR	ANDERE KLEUREN
	buizen	breedte (L mm)	hoogte (H mm)	75/65/20 (Watt) (Φ50K)	55/45/20 (Watt) (Φ30K)	n-exp.	gewicht (kg)	inhoud (l)	el. weerst. (Watt)	prijs RAL 9016 (€)	prijs kleur (€)
REF. NR. RITMO HORIZONTAAL HB-4K/145 : 368											
368	117	030	XX	YY	00						
		040								880	1012
		050								890	1024
		060								900	1035
		090								910	1047
										1170	1346
368	126	030	XX	YY	00						
		040								945	1087
		050								955	1098
		060								965	1110
		090								975	1121
										1235	1420
368	135	030	XX	YY	00						
		040								1000	1150
		050								1010	1162
		060								1020	1173
		090								1030	1185
										1290	1484
368	144	030	XX	YY	00						
		040								1070	1231
		050								1080	1242
		060								1090	1254
		090								1100	1265
										1360	1564
368	153	030	XX	YY	00						
		040								1135	1305
		050								1145	1317
		060								1155	1328
		090								1165	1340
										1430	1645
368	162	030	XX	YY	00						
		040								1208	1389
		050								1218	1401
		060								1228	1412
		090								1238	1424
										1505	1731
368	171	030	XX	YY	00						
		040								1265	1455
		050								1275	1466
		060								1285	1478
		090								1295	1489
										1555	1788
368	180	030	XX	YY	00						
		040								1309	1505
		050								1319	1517
		060								1329	1528
		090								1339	1540
										1609	1850

Conform EN442-1: 2014: radiatoren en convectoren

Voor meer details over onze artikel-data, zie artikel-database: <https://www.2ba.nl>

Voor de warmteafgiftes van andere regimes, kijkt u op p. 348 (correctiefactoren)
NEDERLAND. Prijzen in euro (excl. BTW)

PRIJSGROEP: VPG10 - ACC.

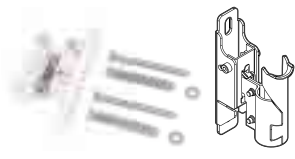
BEVESTIGINGEN		KLEUR	ART. NR.	€
KLEMCONSOLE VARIABEL				
KLEMCONSOLE VARIABEL 	RITMO VERTICAAL / RITMO HORIZONTAAL			
	35 - 45 mm	RAL 9016	118721200009016	32
		KLEUR	11872120000XXXX	42
	45 - 60 mm	RAL 9016	118721300009016	37
		KLEUR	11872130000XXXX	49
<ul style="list-style-type: none"> Wandafstand: 35 - 45 mm of 45 - 60 mm 				
AFSTANDHOUDER				
RITMO VERTICAAL / RITMO HORIZONTAAL				
		RAL 9016	118720900009016	11
		RAL 7024	118720900007024	12

hoogte (H mm)	2-kolom / 3-kolom / 4-kolom		
	300 - 900	1500 - 2200	
aantal buizen (n)	10 - 28	30 - 40	6 - 16
klemconsole variabel 35 - 45 mm	2x	3x	2x
klemconsole variabel 45 - 60 mm	2x	3x	2x
afstandhouder	2x	3x	2x

HOE BESTELLEN

1. Kies de gewenste klemconsole in bovenstaande tabel.
2. Afstandhouders dienen apart mee besteld te worden.

NEDERLAND. Prijzen in euro (excl. BTW)

RITMO VRIJSTAANDE OPSTELLING

IN OPTIE

PRIJSGROEP: VPG10 - ACC.

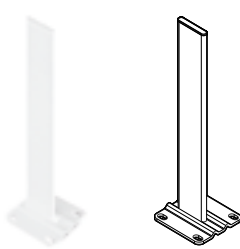
VRIJSTAANDE OPSTELLING	HOOGTE VOET	KLEUR	ART. NR.	€
STANDVOET VRIJSTAANDE OPSTELLING 	RITMO HORIZONTAAL			
	H = 450 mm	RAL 9016	11810350450	60
		KLEUR	11810350450C	69
	H = 550 mm	RAL 9016	11810350550	60
		KLEUR	11810350550C	69
	H = 600 mm	RAL 9016	11810350600	60
		KLEUR	11810350600C	69
	H = 650 mm	RAL 9016	11810350650	60
		KLEUR	11810350650C	69
	H = 750 mm	RAL 9016	11810350750	60
		KLEUR	11810350750C	69
	H = 850 mm	RAL 9016	11810350850	74
		KLEUR	11810350850C	85
	H = 900 mm	RAL 9016	11810350900	74
	KLEUR	11810350900C	85	
H = 1050 mm	RAL 9016	11810351050	74	
	KLEUR	11810351050C	85	
H = 1200 mm	RAL 9016	11810351200	74	
	KLEUR	11810351200C	85	

- Afgewerkte vloer: hoogte voet = hoogte radiator + 150 mm
- Chape: hoogte voet = hoogte radiator + 300 mm
- Zelf in te korten indien nodig

BEVESTIGING STANDVOET VRIJSTAANDE OPSTELLING 	RITMO HORIZONTAAL			
	RAL 9016		1181 029 0000 9016	78
	KLEUR		1181 029 0000 XXXX	84

AFDEKROZET STANDVOET CHAPE 	RITMO HORIZONTAAL			
	RAL 9016		11810370000	12
	KLEUR		11810370000C	14

- 100 x 40 mm. Aantal rozetten = aantal standvoeten



AFDEKROZET STANDVOET AFGEWERKTE VLOER 	RITMO HORIZONTAAL			
	RAL 9016		11810380000	15
	KLEUR		11810380000C	17

- 115 x 110 mm. Aantal rozetten = aantal standvoeten

hoogte (H mm)	2-kolom / 3-kolom / 4-kolom	
	300 – 900	
aantal buizen (n)	10 – 26	28 – 40
standvoet	2x	3x

NEDERLAND. Prijzen in euro (excl. BTW)

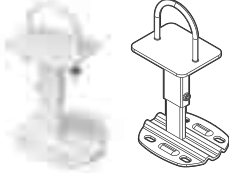
PRIJSGROEP: VPG10 - ACC.



		KLEUR	ART. NR.	€
TELESCOPISCHE ONDERSTEUNVOET  <ul style="list-style-type: none"> • Hoogte: min. 200 mm, max. 230 mm • Telescopische ondersteunvoet steeds in combinatie met de wand- en klemconsoles 	RITMO VERTICAAL / RITMO HORIZONTAAL			
		RAL 9016	1181 030 0000 9016	69
		KLEUR	1181 030 0000 XXXX	89
AFDEKROZET ONDERSTEUNVOET CHAPE  <ul style="list-style-type: none"> • 70 x 40 mm. Aantal rozetten = aantal standvoeten 	RITMO VERTICAAL / RITMO HORIZONTAAL			
		RAL 9016	1181 032 0000 9016	12
AFDEKROZET ONDERSTEUNVOET AFGEWERKTE VLOER  <ul style="list-style-type: none"> • 130 x 110 mm. Aantal rozetten = aantal standvoeten 	RITMO VERTICAAL / RITMO HORIZONTAAL			
		RAL 9016	1181 031 0000 9016	15

hoogte (H mm)	2-kolom / 3-kolom					4-kolom				
	300 – 600		900 – 2000		2200	300 – 600		900 – 2000		2200
aantal buizen (n)	10 – 24	26 – 40	6 – 24	26 – 40	6 – 16	10 – 24	26 – 40	6 – 24	26 – 40	6 – 16
telescopische ondersteunvoet	2x	3x	2x	3x	2x	2x	3x	2x	3x	3x

NEDERLAND. Prijzen in euro (excl. BTW)

RITMO ACCESSOIRES
IN OPTIE

PRIJSGROEP: VPG10 - ACC.

ACCESSOIRES		KLEUR	ART. NR.	€
		RITMO VERTICAAL / RITMO HORIZONTAAL		
THERMOSTAATKOP		WIT	11911630102	50
		RITMO VERTICAAL / RITMO HORIZONTAAL		
THERMOSTAATKOP		CHROOM	11911631102	64

PRIJSGROEP: VPG10B - HANDDOEKBEUGELS

ACCESSOIRES		KLEUR	ART. NR.	€
		RITMO VERTICAAL / RITMO HORIZONTAAL		
HANDDOEKBEUGEL		CHROOM	11832650000099	138

- b = 1000 mm (zelf in te korten)

Montagevoorschriften accessoires: zie www.vasco.eu
NEDERLAND. Prijzen in euro (excl. BTW)

uit voorraad leverbaar

RITMO: VERTICAAL

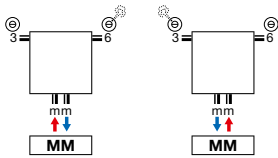

- Ontluchter in aansluiting 3 of 6.

RITMO: HORIZONTAAL

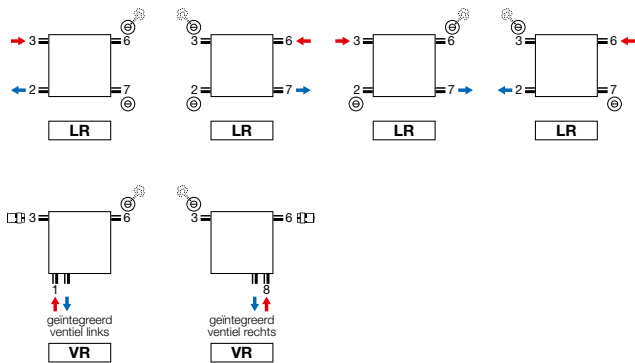

- Ontluchter in aansluiting 3 of 6.
- Geïntegreerd ventiel (aansluiting VR) (meerprijs: €77) (thermostaatkop apart te bestellen, zie p. 316). Plaatsing thermostaatkop links, door spiegelen van radiator. Opgelet: de aanvoer is aan de buitenkant van de radiator!

Opmerking: het aansluiten van de radiator kan enkel volgens de getoonde aansluiticonen. Voor elke andere aansluitwijze nemen wij geen verantwoordelijkheid.

RITMO VERTICAAL

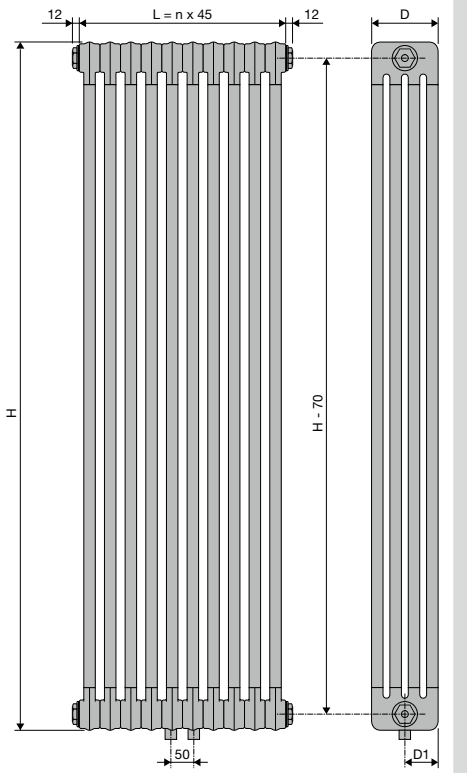

VB-2K/65 / VB-3K/105 / VB-4K/145						
	H	1500	1800	2000	2200	
Diepte (D)	65	105	145			
D1	32,5	52,5	72,5			
Aantal leden (n)	6	8	10	12	14	16

RITMO HORIZONTAAL

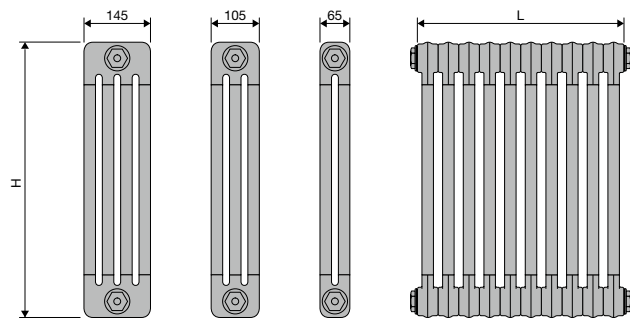
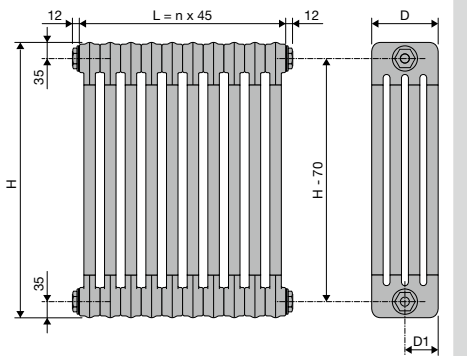
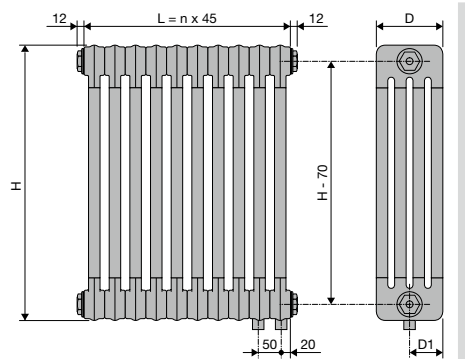
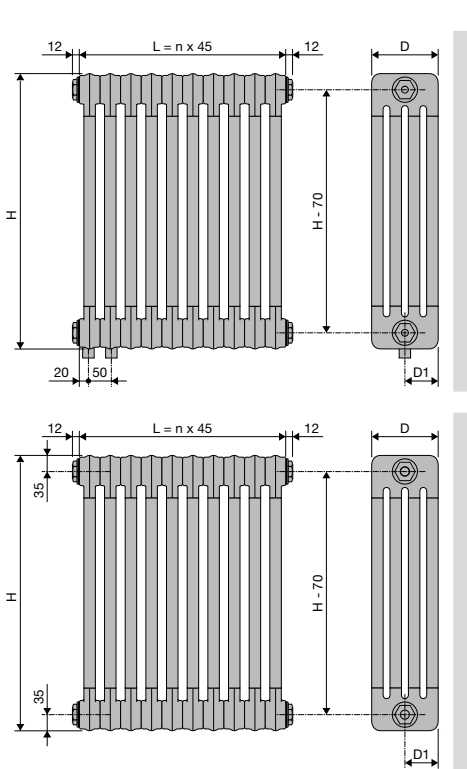

HB-2K/65 / HB-3K/105 / HB-4K/145

	H	300	400	500	600	900										
Diepte (D)	65	105	145													
D1	32,5	52,5	72,5													
Aantal leden (n)	10	12	14	16	18	20	22	24	26	28	30	32	34	36	38	40



VINTAGE (VINTAGE 50)



TYPES

- Vintage 50: afstand tussen de leden 50 mm
- 4 dieptes (D110, D160, D220, D250)

KLEUREN

- Standaardkleur S600 (witte fijn structuurlak) (RAL 9016: geen meerprijs 15%)
- Verkrijgbaar in transparante coating (kleurcode 57)
- **Opgelet: een radiator in transparante coating niet in vochtige ruimtes plaatsen!**
- Uitgebreide kleurenkaart zie p. 12

SPECIAAL

- Vloer- of wandmontage

BEVESTIGINGEN

- Standaard wandbevestigingen of ledenvoeten, 1/2" blindstop, 1/2" ontluchter
- Bevestigingen in de kleur van de radiator (aantal afhankelijk van de lengte van de radiator)
- De voeten en bevestigingen van radiatoren in transparante coating zijn gelakt in de kleur N507.

TECHNISCH

- KTL-grondlaag, epoxy-polyester poedercoating
- Standaardwerkdruk: 5 bar
- Maximale bedrijfstemperatuur: 110°C

TECHNISCHE TEKENINGEN

- Zie p. 336

AANSLUITING

- 4x 1/2" (SL, SR, 26, 37)
- Ontluchter in aansluiting 3 of 6
- Aansluitingen: 1/2" (binnendraad)
- Aansluiting 27, 72: **meerprijs €80**

VINTAGE

Vroeger is weer helemaal van nu

Terug naar de 'oerradiator'. Erg populair omwille van de tot de verbeelding sprekende, authentieke look. Standaard aangeboden in een witte uitvoering, maar ook verkrijgbaar met een transparante coating voor een nog meer uitgesproken vintage look. De Vintage staat borg voor een zeer hoge warmteafgifte. Ideaal voor de verwarming van grote, hoge ruimten, ook in combinatie met energiezuinige technologieën. Een designradiator die als geen andere tot zijn recht komt in een retro-interieur en zich graag voor een raam laat plaatsen.

AANBEVOLEN AANSLUITING (LR)

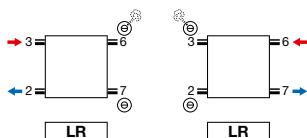

Andere aansluitmogelijkheden, zie p. 335



HOE VINTAGE 50 BESTELLEN

Leveringstermijn 15 - 30 werkdagen
(zonder transportduur)

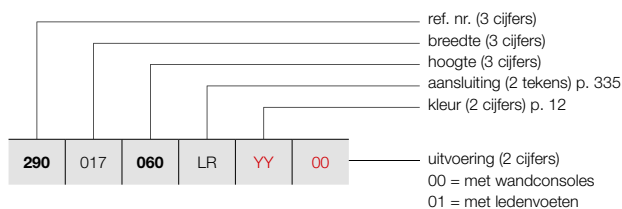

VINTAGE (VINTAGE 50 / D110)

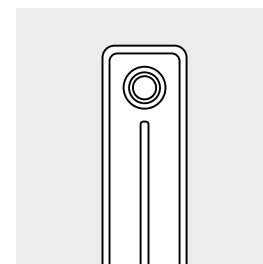

VINTAGE 50 / D110

PRIJSGROEP: VPG5 - KOLOMRADIATOREN

BESTELCODE MAATWERK VINTAGE 50	TECHNISCHE GEGEVENS							STANDAARDKLEUR		ANDERE KLEUREN	
	buizen	breedte (L mm)	hoogte (H mm)	75/65/20 (Watt) (Φ50K)	55/45/20 (Watt) (Φ30K)	n-exp.	gewicht (kg)	inhoud (l)	el. weerst. (Watt)	prijs S600* (€)	prijs kleur (€)
REF. NR. VINTAGE 50 VINTAGE 50/D110 : 290											
290 017 060 LR YY 00	3	178	600	165	87	1,25	4,17	2,49	-	374	430
	3	178	1000	252	131	1,28	6,57	3,39	-	396	455
290 022 060 LR YY 00	4	228	600	220	116	1,25	5,56	3,32	-	390	449
	4	228	1000	336	175	1,28	8,76	4,52	-	422	485
290 027 060 LR YY 00	5	278	600	275	145	1,25	6,95	4,15	-	408	469
	5	278	1000	420	218	1,28	10,95	5,65	-	450	518
290 032 060 LR YY 00	6	328	600	330	174	1,25	8,34	4,98	-	430	495
	6	328	1000	504	262	1,28	13,14	6,78	-	475	546
290 037 060 LR YY 00	7	378	600	385	203	1,25	9,73	5,81	-	445	512
	7	378	1000	588	306	1,28	15,33	7,91	-	503	578
290 042 060 LR YY 00	8	428	600	440	232	1,25	11,12	6,64	-	473	544
	8	428	1000	672	349	1,28	17,52	9,04	-	531	611
290 047 060 LR YY 00	9	478	600	495	261	1,25	12,51	7,47	-	488	561
	9	478	1000	756	393	1,28	19,71	10,17	-	558	642
290 052 060 LR YY 00	10	528	600	550	290	1,25	13,90	8,30	-	511	588
	10	528	1000	840	437	1,28	21,90	11,30	-	584	672
290 057 060 LR YY 00	11	578	600	605	319	1,25	15,29	9,13	-	530	610
	11	578	1000	924	481	1,28	24,09	12,43	-	616	708
290 062 060 LR YY 00	12	628	600	660	349	1,25	16,68	9,96	-	552	635
	12	628	1000	1008	524	1,28	26,28	13,56	-	642	738
290 067 060 LR YY 00	13	678	600	715	378	1,25	18,07	10,79	-	569	654
	13	678	1000	1092	568	1,28	28,47	14,69	-	669	769
290 072 060 LR YY 00	14	728	600	770	407	1,25	19,46	11,62	-	588	676
	14	728	1000	1176	612	1,28	30,66	15,82	-	692	796
290 077 060 LR YY 00	15	778	600	825	436	1,25	20,85	12,45	-	605	696
	15	778	1000	1260	655	1,28	32,85	16,95	-	719	827
290 082 060 LR YY 00	16	828	600	880	465	1,25	22,24	13,28	-	622	715
	16	828	1000	1344	699	1,28	35,04	18,08	-	743	854
290 087 060 LR YY 00	17	878	600	935	494	1,25	23,63	14,11	-	642	738
	17	878	1000	1428	743	1,28	37,23	19,21	-	769	884
290 092 060 LR YY 00	18	928	600	990	523	1,25	25,02	14,94	-	661	760
	18	928	1000	1512	786	1,28	39,42	20,34	-	797	917
290 097 060 LR YY 00	19	978	600	1045	552	1,25	26,41	15,77	-	675	776
	19	978	1000	1596	830	1,28	41,61	21,47	-	821	944

Conform EN442-1: 2014: radiatoren en convectoren

* RAL 9016: geen meerprijs 15%

Voor meer details over onze artikel-data, zie artikel-database: <https://www.2ba.nl>

Voor de warmteafgiftes van andere regimes, kijkt u op p. 348 (correctiefactoren)

NETERLAND. Prijzen in euro (excl. BTW)



VINTAGE (VINTAGE 50 / D110)

HOE VINTAGE 50 BESTELLEN
Leveringstermijn 15 - 30 werkdagen
(zonder transportduur)

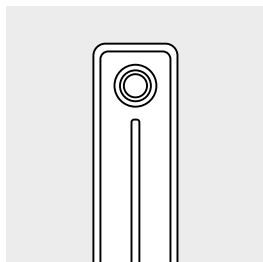

VINTAGE 50 / D110

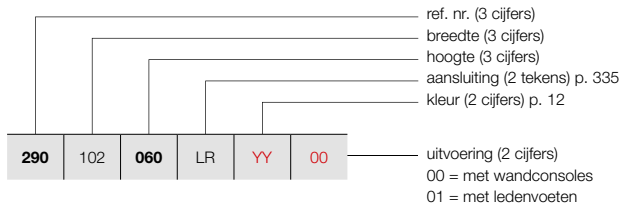

PRIJSGROEP: VPG5 - KOLOMRADIATOREN

BESTELCODE MAATWERK VINTAGE 50	TECHNISCHE GEGEVENS									STANDAARDKLEUR	ANDERE KLEUREN
	buizen	breedte (L mm)	hoogte (H mm)	75/65/20 (Watt) (Φ50K)	55/45/20 (Watt) (Φ30K)	n-exp.	gewicht (kg)	inhoud (l)	el. weerst. (Watt)	prijs S600* (€)	prijs kleur (€)
REF. NR. VINTAGE 50 VINTAGE 50/D110 : 290											
290 102 060 LR YY 00	20	1028	600	1100	581	1,25	27,80	16,60	-	694	798
	20	1028	1000	1680	874	1,28	43,80	22,60	-	846	973
290 107 060 LR YY 00	21	1078	600	1155	610	1,25	29,19	17,43	-	728	837
	21	1078	1000	1764	917	1,28	45,99	23,73	-	886	1019
290 112 060 LR YY 00	22	1128	600	1210	639	1,25	30,58	18,26	-	744	856
	22	1128	1000	1848	961	1,28	48,18	24,86	-	912	1049
290 117 060 LR YY 00	23	1178	600	1265	668	1,25	31,97	19,09	-	766	881
	23	1178	1000	1932	1005	1,28	50,37	25,99	-	934	1074
290 122 060 LR YY 00	24	1228	600	1320	697	1,25	33,36	19,92	-	781	898
	24	1228	1000	2016	1048	1,28	52,56	27,12	-	961	1105
290 127 060 LR YY 00	25	1278	600	1375	726	1,25	34,75	20,75	-	800	920
	25	1278	1000	2100	1092	1,28	54,75	28,25	-	987	1135
290 132 060 LR YY 00	26	1328	600	1430	755	1,25	36,14	21,58	-	835	960
	26	1328	1000	2184	1136	1,28	56,94	29,38	-	1029	1183
290 137 060 LR YY 00	27	1378	600	1485	784	1,25	37,53	22,41	-	851	979
	27	1378	1000	2268	1179	1,28	59,13	30,51	-	1054	1212
290 142 060 LR YY 00	28	1428	600	1540	813	1,25	38,92	23,24	-	872	1003
	28	1428	1000	2352	1223	1,28	61,32	31,64	-	1081	1243
290 147 060 LR YY 00	29	1478	600	1595	842	1,25	40,31	24,07	-	889	1022
	29	1478	1000	2436	1267	1,28	63,51	32,77	-	1104	1270
290 152 060 LR YY 00	30	1528	600	1650	871	1,25	41,70	24,90	-	905	1041
	30	1528	1000	2520	1310	1,28	65,70	33,90	-	1131	1301
290 157 060 LR YY 00	31	1578	600	1705	900	1,25	43,09	25,73	-	924	1063
	31	1578	1000	2604	1354	1,28	67,89	35,03	-	1163	1337
290 162 060 LR YY 00	32	1628	600	1760	929	1,25	44,48	26,56	-	942	1083
	32	1628	1000	2688	1398	1,28	70,08	36,16	-	1187	1365
290 167 060 LR YY 00	33	1678	600	1815	958	1,25	45,87	27,39	-	1000	1150
	33	1678	1000	2772	1442	1,28	72,27	37,29	-	1254	1442
290 172 060 LR YY 00	34	1728	600	1870	987	1,25	47,26	28,22	-	1017	1170
	34	1728	1000	2856	1485	1,28	74,46	38,42	-	1279	1471
290 177 060 LR YY 00	35	1778	600	1925	1017	1,25	48,65	29,05	-	1038	1194
	35	1778	1000	2940	1529	1,28	76,65	39,55	-	1302	1497
290 182 060 LR YY 00	36	1828	600	1980	1046	1,25	50,04	29,88	-	1061	1220
	36	1828	1000	3024	1573	1,28	78,84	40,68	-	1328	1527
290 187 060 LR YY 00	37	1878	600	2035	1075	1,25	51,43	30,71	-	1079	1241
	37	1878	1000	3108	1616	1,28	81,03	41,81	-	1355	1558

Conform EN442-1: 2014: radiatoren en convectoren

* RAL 9016: geen meerprijs 15%

Voor meer details over onze artikel-data, zie artikel-database: <https://www.2ba.nl>

Voor de warmteafgiftes van andere regimes, kijkt u op p. 348 (correctiefactoren)

NETERLAND. Prijzen in euro (excl. BTW)

HOE VINTAGE 50 BESTELLEN

Leveringstermijn 15 - 30 werkdagen
(zonder transportduur)

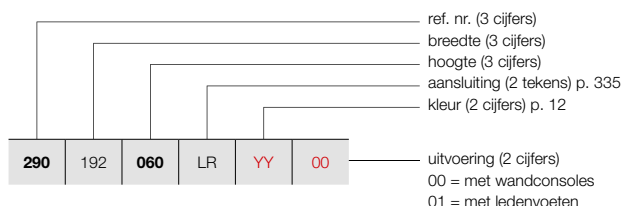

VINTAGE (VINTAGE 50 / D110)

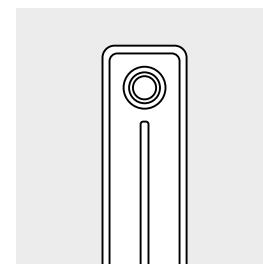

VINTAGE 50 / D110

PRIJSGROEP: VPG5 - KOLOMRADIATOREN

BESTELCODE MAATWERK VINTAGE 50	TECHNISCHE GEGEVENS							STANDAARDKLEUR	ANDERE KLEUREN		
	buizen	breedte (L mm)	hoogte (H mm)	75/65/20 (Watt) (φ50K)	55/45/20 (Watt) (φ30K)	n-exp.	gewicht (kg)			inhoud (l)	el. weerst. (Watt)
REF. NR. VINTAGE 50 VINTAGE 50/D110 : 290											
290 192 060 LR YY 00	38	1928	600	2090	1104	1,25	52,82	31,54	-	1096	1260
	38	1928	1000	3192	1660	1,28	83,22	42,94	-	1379	1586
290 197 060 LR YY 00	39	1978	600	2145	1133	1,25	54,21	32,37	-	1117	1285
	39	1978	1000	3276	1704	1,28	85,41	44,07	-	1407	1618
290 202 060 LR YY 00	40	2028	600	2200	1162	1,25	55,60	33,20	-	1134	1304
	40	2028	1000	3360	1747	1,28	87,60	45,20	-	1431	1646
290 207 060 LR YY 00	41	2078	600	2255	1191	1,25	56,99	34,03	-	1148	1320
	41	2078	1000	3444	1791	1,28	89,79	46,33	-	1457	1676
290 212 060 LR YY 00	42	2128	600	2310	1220	1,25	58,38	34,86	-	1170	1346
	42	2128	1000	3528	1835	1,28	91,98	47,46	-	1482	1704
290 217 060 LR YY 00	43	2178	600	2365	1249	1,25	59,77	35,69	-	1187	1365
	43	2178	1000	3612	1878	1,28	94,17	48,59	-	1510	1737
290 222 060 LR YY 00	44	2228	600	2420	1278	1,25	61,16	36,52	-	1207	1388
	44	2228	1000	3696	1922	1,28	96,36	49,72	-	1535	1765
290 227 060 LR YY 00	45	2278	600	2475	1307	1,25	62,55	37,35	-	1221	1404
	45	2278	1000	3780	1966	1,28	98,55	50,85	-	1561	1795
290 232 060 LR YY 00	46	2328	600	2530	1336	1,25	63,94	38,18	-	1243	1429
290 237 060 LR YY 00	47	2378	600	2585	1365	1,25	65,33	39,01	-	1259	1448
290 242 060 LR YY 00	48	2428	600	2640	1394	1,25	66,72	39,84	-	1279	1471
290 247 060 LR YY 00	49	2478	600	2695	1423	1,25	68,11	40,67	-	1296	1490
290 252 060 LR YY 00	50	2528	600	2750	1452	1,25	69,50	41,50	-	1317	1515
290 257 060 LR YY 00	51	2578	600	2805	1481	1,25	70,89	42,33	-	1350	1553
290 262 060 LR YY 00	52	2628	600	2860	1510	1,25	72,28	43,16	-	1366	1571
290 267 060 LR YY 00	53	2678	600	2915	1539	1,25	73,67	43,99	-	1382	1589
290 272 060 LR YY 00	54	2728	600	2970	1568	1,25	75,06	44,82	-	1405	1616
290 277 060 LR YY 00	55	2778	600	3025	1597	1,25	76,45	45,65	-	1422	1635
290 282 060 LR YY 00	56	2828	600	3080	1626	1,25	77,84	46,48	-	1440	1656
290 287 060 LR YY 00	57	2878	600	3135	1655	1,25	79,23	47,31	-	1457	1676
290 292 060 LR YY 00	58	2928	600	3190	1685	1,25	80,62	48,14	-	1474	1695
290 297 060 LR YY 00	59	2978	600	3245	1714	1,25	82,01	48,97	-	1493	1717
290 302 060 LR YY 00	60	3028	600	3300	1743	1,25	83,40	49,80	-	1512	1739

Conform EN442-1: 2014: radiatoren en convectoren

* RAL 9016: geen meerprijs 15%

Voor meer details over onze artikel-data, zie artikel-database: <https://www.2ba.nl>

Voor de warmteafgiftes van andere regimes, kijkt u op p. 348 (correctiefactoren)
 NEDERLAND. Prijzen in euro (excl. BTW)

VINTAGE (VINTAGE 50 / D160)

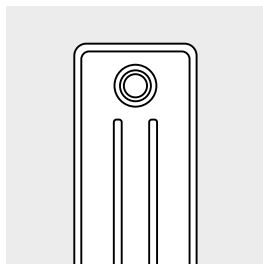

VINTAGE 50 / D160

HOE VINTAGE 50 BESTELLEN

Leveringstermijn 15 - 30 werkdagen
(zonder transportduur)

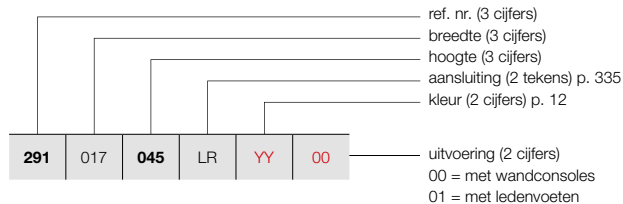

PRIJSGROEP: VPG5 - KOLOMRADIATOREN

BESTELCODE MAATWERK VINTAGE 50							TECHNISCHE GEGEVENS					STANDAARDKLEUR	ANDERE KLEUREN			
buizen	breedte (L mm)	hoogte (H mm)	75/65/20 (Watt) (Ø50K)	55/45/20 (Watt) (Ø30K)	n-exp.	gewicht (kg)	inhoud (l)	el. weerst. (Watt)	prijs S600* (€)	prijs kleur (€)						
REF. NR. VINTAGE 50 VINTAGE 50/D160 : 291																
291	017	045	LR	YY	00	3	178	450	174	92	1,24	4,47	2,82	-	376	432
		060				3	178	600	219	115	1,26	6,00	3,42	-	390	449
		100				3	178	1000	333	172	1,29	9,63	4,89	-	426	490
291	022	045	LR	YY	00	4	228	450	232	123	1,24	5,96	3,76	-	395	454
		060				4	228	600	292	153	1,26	8,00	4,56	-	409	470
		100				4	228	1000	444	230	1,29	12,84	6,52	-	455	523
291	027	045	LR	YY	00	5	278	450	290	154	1,24	7,45	4,70	-	414	476
		060				5	278	600	365	192	1,26	10,00	5,70	-	436	501
		100				5	278	1000	555	287	1,29	16,05	8,15	-	488	561
291	032	045	LR	YY	00	6	328	450	348	185	1,24	8,94	5,64	-	432	497
		060				6	328	600	438	230	1,26	12,00	6,84	-	457	526
		100				6	328	1000	666	345	1,29	19,26	9,78	-	522	600
291	037	045	LR	YY	00	7	378	450	406	215	1,24	10,43	6,58	-	449	516
		060				7	378	600	511	268	1,26	14,00	7,98	-	478	550
		100				7	378	1000	777	402	1,29	22,47	11,41	-	555	638
291	042	045	LR	YY	00	8	428	450	464	246	1,24	11,92	7,52	-	474	545
		060				8	428	600	584	307	1,26	16,00	9,12	-	512	589
		100				8	428	1000	888	459	1,29	25,68	13,04	-	593	682
291	047	045	LR	YY	00	9	478	450	522	277	1,24	13,41	8,46	-	489	562
		060				9	478	600	657	345	1,26	18,00	10,26	-	530	610
		100				9	478	1000	999	517	1,29	28,89	14,67	-	623	716
291	052	045	LR	YY	00	10	528	450	580	308	1,24	14,90	9,40	-	511	588
		060				10	528	600	730	384	1,26	20,00	11,40	-	555	638
		100				10	528	1000	1110	574	1,29	32,10	16,30	-	657	756
291	057	045	LR	YY	00	11	578	450	638	339	1,24	16,39	10,34	-	531	611
		060				11	578	600	803	422	1,26	22,00	12,54	-	581	668
		100				11	578	1000	1221	632	1,29	35,31	17,93	-	694	798
291	062	045	LR	YY	00	12	628	450	696	369	1,24	17,88	11,28	-	552	635
		060				12	628	600	876	460	1,26	24,00	13,68	-	605	696
		100				12	628	1000	1332	689	1,29	38,52	19,56	-	728	837
291	067	045	LR	YY	00	13	678	450	754	400	1,24	19,37	12,22	-	568	653
		060				13	678	600	949	499	1,26	26,00	14,82	-	625	719
		100				13	678	1000	1443	747	1,29	41,73	21,19	-	759	873
291	072	045	LR	YY	00	14	728	450	812	431	1,24	20,86	13,16	-	585	673
		060				14	728	600	1022	537	1,26	28,00	15,96	-	649	746
		100				14	728	1000	1554	804	1,29	44,94	22,82	-	794	913
291	077	045	LR	YY	00	15	778	450	870	462	1,24	22,35	14,10	-	605	696
		060				15	778	600	1095	575	1,26	30,00	17,10	-	671	772
		100				15	778	1000	1665	861	1,29	48,15	24,45	-	823	946

Conform EN442-1: 2014: radiatoren en convectoren

* RAL 9016: geen meerprijs 15%

Voor meer details over onze artikel-data, zie artikel-database: <https://www.2ba.nl>

Voor de warmteafgiftes van andere regimes, kijkt u op p. 348 (correctiefactoren)
 NEDERLAND. Prijzen in euro (excl. BTW)

HOE VINTAGE 50 BESTELLEN

Leveringstermijn 15 - 30 werkdagen
(zonder transportduur)

VINTAGE (VINTAGE 50 / D160)

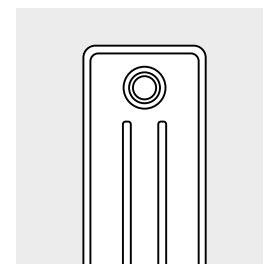
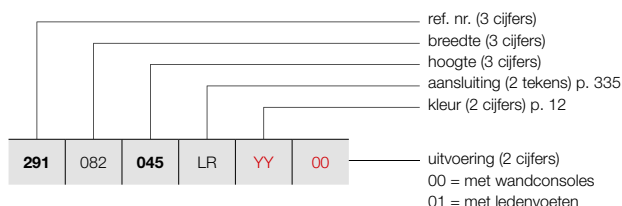

VINTAGE 50 / D160

PRIJSGROEP: VPG5 - KOLOMRADIATOREN

BESTELCODE MAATWERK VINTAGE 50	TECHNISCHE GEGEVENS							STANDAARDKLEUR	ANDERE KLEUREN							
	buizen	breedte (L mm)	hoogte (H mm)	75/65/20 (Watt) (φ50K)	55/45/20 (Watt) (φ30K)	n-exp.	gewicht (kg)			inhoud (l)	el. weerst. (Watt)	prijs S600* (€)	prijs kleur (€)			
REF. NR. VINTAGE 50 VINTAGE 50/D160 : 291																
291	082	045	LR	YY	00	16	828	450	928	493	1,24	23,84	15,04	-	621	714
		060				16	828	600	1168	614	1,26	32,00	18,24	-	692	796
		100				16	828	1000	1776	919	1,29	51,36	26,08	-	855	983
291	087	045	LR	YY	00	17	878	450	986	523	1,24	25,33	15,98	-	640	736
		060				17	878	600	1241	652	1,26	34,00	19,38	-	716	823
		100				17	878	1000	1887	976	1,29	54,57	27,71	-	889	1022
291	092	045	LR	YY	00	18	928	450	1044	554	1,24	26,82	16,92	-	657	756
		060				18	928	600	1314	690	1,26	36,00	20,52	-	739	850
		100				18	928	1000	1998	1034	1,29	57,78	29,34	-	922	1060
291	097	045	LR	YY	00	19	978	450	1102	585	1,24	28,31	17,86	-	673	774
		060				19	978	600	1387	729	1,26	38,00	21,66	-	759	873
		100				19	978	1000	2109	1091	1,29	60,99	30,97	-	954	1097
291	102	045	LR	YY	00	20	1028	450	1160	616	1,24	29,80	18,80	-	692	796
		060				20	1028	600	1460	767	1,26	40,00	22,80	-	781	898
		100				20	1028	1000	2220	1149	1,29	64,20	32,60	-	987	1135
291	107	045	LR	YY	00	21	1078	450	1218	646	1,24	31,29	19,74	-	724	833
		060				21	1078	600	1533	805	1,26	42,00	23,94	-	818	941
		100				21	1078	1000	2331	1206	1,29	67,41	34,23	-	1031	1186
291	112	045	LR	YY	00	22	1128	450	1276	677	1,24	32,78	20,68	-	742	853
		060				22	1128	600	1606	844	1,26	44,00	25,08	-	839	965
		100				22	1128	1000	2442	1263	1,29	70,62	35,86	-	1064	1224
291	117	045	LR	YY	00	23	1178	450	1334	708	1,24	34,27	21,62	-	759	873
		060				23	1178	600	1679	882	1,26	46,00	26,22	-	858	987
		100				23	1178	1000	2553	1321	1,29	73,83	37,49	-	1095	1259
291	122	045	LR	YY	00	24	1228	450	1392	739	1,24	35,76	22,56	-	775	891
		060				24	1228	600	1752	920	1,26	48,00	27,36	-	883	1015
		100				24	1228	1000	2664	1378	1,29	77,04	39,12	-	1129	1298
291	127	045	LR	YY	00	25	1278	450	1450	770	1,24	37,25	23,50	-	795	914
		060				25	1278	600	1825	959	1,26	50,00	28,50	-	904	1040
		100				25	1278	1000	2775	1436	1,29	80,25	40,75	-	1161	1335
291	132	045	LR	YY	00	26	1328	450	1508	800	1,24	38,74	24,44	-	832	957
		060				26	1328	600	1898	997	1,26	52,00	29,64	-	946	1088
		100				26	1328	1000	2886	1493	1,29	83,46	42,38	-	1211	1393
291	137	045	LR	YY	00	27	1378	450	1566	831	1,24	40,23	25,38	-	847	974
		060				27	1378	600	1971	1036	1,26	54,00	30,78	-	966	1111
		100				27	1378	1000	2997	1551	1,29	86,67	44,01	-	1243	1429
291	142	045	LR	YY	00	28	1428	450	1624	862	1,24	41,72	26,32	-	863	992
		060				28	1428	600	2044	1074	1,26	56,00	31,92	-	988	1136
		100				28	1428	1000	3108	1608	1,29	89,88	45,64	-	1275	1466

Conform EN442-1: 2014: radiatoren en convectoren

* RAL 9016: geen meerprijs 15%

Voor meer details over onze artikel-data, zie artikel-database: <https://www.2ba.nl>

Voor de warmteafgiftes van andere regimes, kijkt u op p. 348 (correctiefactoren)
 NEDERLAND. Prijzen in euro (excl. BTW)



VINTAGE (VINTAGE 50 / D160)

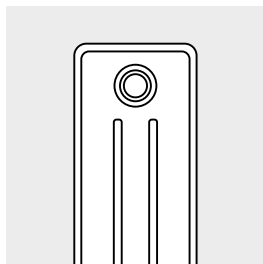

VINTAGE 50 / D160

HOE VINTAGE 50 BESTELLEN

Leveringstermijn 15 - 30 werkdagen
(zonder transportduur)

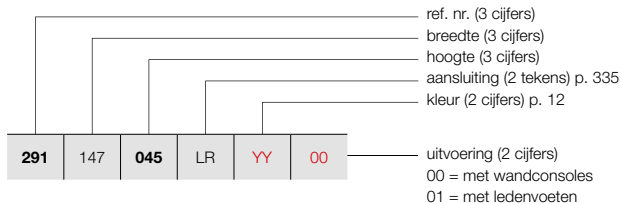

PRIJSGROEP: VPG5 - KOLOMRADIATOREN

BESTELCODE MAATWERK VINTAGE 50							TECHNISCHE GEGEVENS					STANDAARDKLEUR	ANDERE KLEUREN			
buizen	breedte (L mm)	hoogte (H mm)	75/65/20 (Watt) (Φ50K)	55/45/20 (Watt) (Φ30K)	n-exp.	gewicht (kg)	inhoud (l)	el. weerst. (Watt)	prijs S600* (€)	prijs kleur (€)						
REF. NR. VINTAGE 50 VINTAGE 50/D160 : 291																
291	147	045	LR	YY	00	29	1478	450	1682	893	1,24	43,21	27,26	-	883	1015
		060				29	1478	600	2117	1112	1,26	58,00	33,06	-	1008	1159
		100				29	1478	1000	3219	1665	1,29	93,09	47,27	-	1306	1502
291	152	045	LR	YY	00	30	1528	450	1740	924	1,24	44,70	28,20	-	900	1035
		060				30	1528	600	2190	1151	1,26	60,00	34,20	-	1034	1189
		100				30	1528	1000	3330	1723	1,29	96,30	48,90	-	1336	1536
291	157	045	LR	YY	00	31	1578	450	1798	954	1,24	46,19	29,14	-	918	1056
		060				31	1578	600	2263	1189	1,26	62,00	34,34	-	1054	1212
291	162	045	LR	YY	00	32	1628	450	1856	985	1,24	47,68	30,08	-	934	1074
		060				32	1628	600	2336	1227	1,26	64,00	36,48	-	1076	1237
291	167	045	LR	YY	00	33	1678	450	1914	1016	1,24	49,17	31,02	-	994	1143
		060				33	1678	600	2409	1266	1,26	66,00	37,62	-	1138	1309
291	172	045	LR	YY	00	34	1728	450	1972	1047	1,24	50,66	31,96	-	1008	1159
		060				34	1728	600	2482	1304	1,26	68,00	38,76	-	1163	1337
291	177	045	LR	YY	00	35	1778	450	2030	1077	1,24	52,15	32,90	-	1029	1183
		060				35	1778	600	2555	1342	1,26	70,00	39,90	-	1180	1357
291	182	045	LR	YY	00	36	1828	450	2088	1108	1,24	53,64	33,84	-	1053	1211
		060				36	1828	600	2628	1381	1,26	72,00	41,04	-	1213	1395
291	187	045	LR	YY	00	37	1878	450	2146	1139	1,24	55,13	34,78	-	1068	1228
		060				37	1878	600	2701	1419	1,26	74,00	42,18	-	1229	1413
291	192	045	LR	YY	00	38	1928	450	2204	1170	1,24	56,62	35,72	-	1088	1251
		060				38	1928	600	2774	1457	1,26	76,00	43,32	-	1256	1444
291	197	045	LR	YY	00	39	1978	450	2262	1201	1,24	58,11	36,66	-	1104	1270
		060				39	1978	600	2847	1496	1,26	78,00	44,46	-	1278	1470
291	202	045	LR	YY	00	40	2028	450	2320	1231	1,24	59,60	37,60	-	1122	1290
		060				40	2028	600	2920	1534	1,26	80,00	45,60	-	1299	1494
291	207	045	LR	YY	00	41	2078	450	2378	1262	1,24	61,09	38,54	-	1142	1313
		060				41	2078	600	2993	1572	1,26	82,00	46,74	-	1322	1520
291	212	045	LR	YY	00	42	2128	450	2436	1293	1,24	62,58	39,48	-	1160	1334
		060				42	2128	600	3066	1611	1,26	84,00	47,88	-	1347	1549
291	217	045	LR	YY	00	43	2178	450	2494	1324	1,24	64,07	40,42	-	1176	1352
		060				43	2178	600	3139	1649	1,26	86,00	49,02	-	1365	1570
291	222	045	LR	YY	00	44	2228	450	2552	1355	1,24	65,56	41,36	-	1194	1373
		060				44	2228	600	3212	1688	1,26	88,00	50,16	-	1386	1594

Conform EN442-1: 2014: radiatoren en convectoren

* RAL 9016: geen meerprijs 15%

Voor meer details over onze artikel-data, zie artikel-database: <https://www.2ba.nl>

Voor de warmteafgiftes van andere regimes, kijkt u op p. 348 (correctiefactoren)
NEDERLAND. Prijzen in euro (excl. BTW)

HOE VINTAGE 50 BESTELLEN

Leveringstermijn 15 - 30 werkdagen
(zonder transportduur)

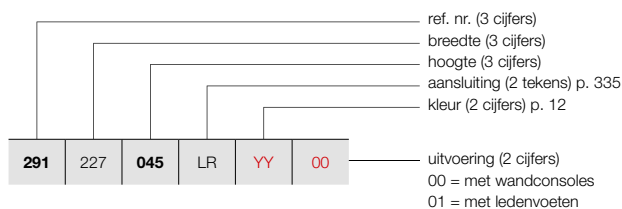

VINTAGE (VINTAGE 50 / D160)

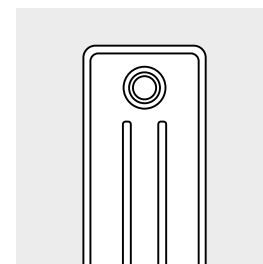

VINTAGE 50 / D160

PRIJSGROEP: VPG5 - KOLOMRADIATOREN

BESTELCODE MAATWERK VINTAGE 50	TECHNISCHE GEGEVENS							STANDAARDKLEUR	ANDERE KLEUREN							
	buizen	breedte (L mm)	hoogte (H mm)	75/65/20 (Watt) (Φ50K)	55/45/20 (Watt) (Φ30K)	n-exp.	gewicht (kg)			inhoud (l)	el. weerst. (Watt)	prijs S600* (€)	prijs kleur (€)			
REF. NR. VINTAGE 50 VINTAGE 50/D160 : 291																
291	227	045	LR	YY	00											
		060														
						45	2278	450	2610	1385	1,24	67,05	42,30	-	1214	1396
						45	2278	600	3285	1726	1,26	90,00	51,30	-	1409	1620
291	232	045	LR	YY	00											
		060														
						46	2328	450	2668	1416	1,24	68,54	43,24	-	1227	1411
						46	2328	600	3358	1764	1,26	92,00	52,44	-	1431	1646
291	237	045	LR	YY	00											
		060														
						47	2378	450	2726	1447	1,24	70,03	44,18	-	1247	1434
						47	2378	600	3431	1803	1,26	94,00	53,58	-	1454	1672
291	242	045	LR	YY	00											
		060														
						48	2428	450	2784	1478	1,24	71,52	45,12	-	1265	1455
						48	2428	600	3504	1841	1,26	96,00	54,72	-	1474	1695
291	247	045	LR	YY	00											
						49	2478	450	2842	1508	1,24	73,01	46,06	-	1282	1474
291	252	045	LR	YY	00											
						50	2528	450	2900	1539	1,24	74,50	47,00	-	1300	1495
291	257	045	LR	YY	00											
						51	2578	450	2958	1570	1,24	75,99	47,94	-	1334	1534
291	262	045	LR	YY	00											
						52	2628	450	3016	1601	1,24	77,48	48,88	-	1354	1557
291	267	045	LR	YY	00											
						53	2678	450	3074	1632	1,24	78,97	49,82	-	1369	1574
291	272	045	LR	YY	00											
						54	2728	450	3132	1662	1,24	80,46	50,76	-	1388	1596
291	277	045	LR	YY	00											
						55	2778	450	3190	1693	1,24	81,95	51,70	-	1407	1618
291	282	045	LR	YY	00											
						56	2828	450	3248	1724	1,24	83,44	52,64	-	1426	1640
291	287	045	LR	YY	00											
						57	2878	450	3306	1755	1,24	84,93	53,58	-	1442	1658
291	292	045	LR	YY	00											
						58	2928	450	3364	1786	1,24	86,42	54,52	-	1460	1679
291	297	045	LR	YY	00											
						59	2978	450	3422	1816	1,24	87,91	55,46	-	1477	1699
291	302	045	LR	YY	00											
						60	3028	450	3480	1847	1,24	89,40	56,40	-	1495	1719

Conform EN442-1: 2014: radiatoren en convectoren

* RAL 9016: geen meerprijs 15%

Voor meer details over onze artikel-data, zie artikel-database: <https://www.2ba.nl>

Voor de warmteafgiftes van andere regimes, kijkt u op p. 348 (correctiefactoren)
NEDERLAND. Prijzen in euro (excl. BTW)

VINTAGE (VINTAGE 50 / D220)

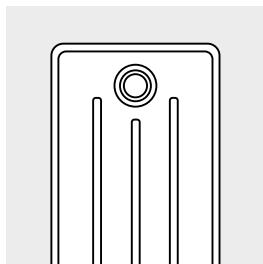

VINTAGE 50 / D220

HOE VINTAGE 50 BESTELLEN

Leveringstermijn 15 - 30 werkdagen
(zonder transportduur)

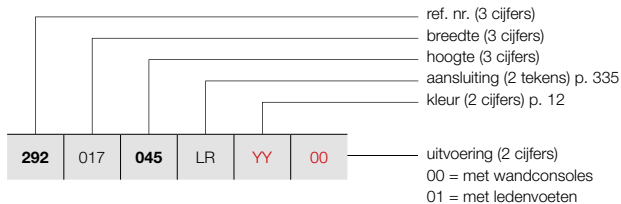

PRIJSGROEP: VPG5 - KOLOMRADIATOREN

BESTELCODE MAATWERK VINTAGE 50							TECHNISCHE GEGEVENS					STANDAARDKLEUR	ANDERE KLEUREN			
buizen	breedte (L mm)	hoogte (H mm)	75/65/20 (Watt) (Φ50K)	55/45/20 (Watt) (Φ30K)	n-exp.	gewicht (kg)	inhoud (l)	el. weerst. (Watt)	prijs S600* (€)	prijs kleur (€)						
REF. NR. VINTAGE 50 VINTAGE 50/D220 : 292																
292	017	045	LR	YY	00	3	178	450	225	119	1,25	6,00	3,69	-	389	447
		060				3	178	600	282	148	1,26	7,86	4,44	-	405	466
		100				3	178	1000	435	226	1,28	13,68	7,26	-	449	516
292	022	045	LR	YY	00	4	228	450	300	158	1,25	8,00	4,92	-	407	468
		060				4	228	600	376	198	1,26	10,48	5,92	-	434	499
		100				4	228	1000	580	302	1,28	18,24	9,68	-	489	562
292	027	045	LR	YY	00	5	278	450	375	198	1,25	10,00	6,15	-	433	498
		060				5	278	600	470	247	1,26	13,10	7,40	-	462	531
		100				5	278	1000	725	377	1,28	22,80	12,10	-	531	611
292	032	045	LR	YY	00	6	328	450	450	238	1,25	12,00	7,38	-	455	523
		060				6	328	600	564	296	1,26	15,72	8,88	-	488	561
		100				6	328	1000	870	452	1,28	27,36	14,52	-	576	662
292	037	045	LR	YY	00	7	378	450	525	277	1,25	14,00	8,61	-	475	546
		060				7	378	600	658	346	1,26	18,34	10,36	-	517	595
		100				7	378	1000	1015	528	1,28	31,92	16,94	-	616	708
292	042	045	LR	YY	00	8	428	450	600	317	1,25	16,00	9,84	-	507	583
		060				8	428	600	752	395	1,26	20,96	11,84	-	552	635
		100				8	428	1000	1160	603	1,28	36,48	19,36	-	663	762
292	047	045	LR	YY	00	9	478	450	675	356	1,25	18,00	11,07	-	524	603
		060				9	478	600	846	444	1,26	23,58	13,32	-	578	665
		100				9	478	1000	1305	679	1,28	41,04	21,78	-	703	808
292	052	045	LR	YY	00	10	528	450	750	396	1,25	20,00	12,30	-	545	627
		060				10	528	600	940	494	1,26	26,20	14,80	-	605	696
		100				10	528	1000	1450	754	1,28	45,60	24,20	-	745	857
292	057	045	LR	YY	00	11	578	450	825	436	1,25	22,00	13,53	-	576	662
		060				11	578	600	1034	543	1,26	28,82	16,28	-	636	731
		100				11	578	1000	1595	829	1,28	50,16	26,62	-	795	914
292	062	045	LR	YY	00	12	628	450	900	475	1,25	24,00	14,76	-	595	684
		060				12	628	600	1128	593	1,26	31,44	17,76	-	666	766
		100				12	628	1000	1740	905	1,28	54,72	29,04	-	836	961
292	067	045	LR	YY	00	13	678	450	975	515	1,25	26,00	15,99	-	617	710
		060				13	678	600	1222	642	1,26	34,06	19,24	-	692	796
		100				13	678	1000	1885	980	1,28	59,28	31,46	-	877	1009
292	072	045	LR	YY	00	14	728	450	1050	554	1,25	28,00	17,22	-	636	731
		060				14	728	600	1316	691	1,26	36,68	20,72	-	721	829
		100				14	728	1000	2030	1056	1,28	63,84	33,88	-	916	1053
292	077	045	LR	YY	00	15	778	450	1125	594	1,25	30,00	18,45	-	661	760
		060				15	778	600	1410	741	1,26	39,30	22,20	-	745	857
		100				15	778	1000	2175	1131	1,28	68,40	36,30	-	958	1102

Conform EN442-1: 2014: radiatoren en convectoren

* RAL 9016: geen meerprijs 15%

Voor meer details over onze artikel-data, zie artikel-database: <https://www.2ba.nl>

Voor de warmteafgifte van andere regimes, kijkt u op p. 348 (correctiefactoren)
NEDERLAND. Prijzen in euro (excl. BTW)

HOE VINTAGE 50 BESTELLEN

Leveringstermijn 15 - 30 werkdagen
(zonder transportduur)

VINTAGE (VINTAGE 50 / D220)

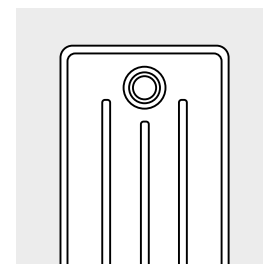
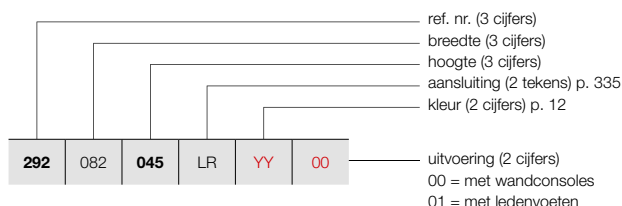

VINTAGE 50 / D220

PRIJSGROEP: VPG5 - KOLOMRADIATOREN

BESTELCODE MAATWERK VINTAGE 50	TECHNISCHE GEGEVENS							STANDAARDKLEUR	ANDERE KLEUREN							
	buizen	breedte (L mm)	hoogte (H mm)	75/65/20 (Watt) (φ50K)	55/45/20 (Watt) (φ30K)	n-exp.	gewicht (kg)			inhoud (l)	el. weerst. (Watt)	prijs S600* (€)	prijs kleur (€)			
REF. NR. VINTAGE 50 VINTAGE 50/D220 : 292																
292	082	045	LR	YY	00	16	828	450	1200	634	1,25	32,00	19,68	-	680	782
		060				16	828	600	1504	790	1,26	41,92	23,68	-	773	889
		100				16	828	1000	2320	1206	1,28	72,96	38,72	-	1000	1150
292	087	045	LR	YY	00	17	878	450	1275	673	1,25	34,00	20,91	-	701	806
		060				17	878	600	1598	840	1,26	44,54	25,16	-	801	921
		100				17	878	1000	2465	1282	1,28	77,52	41,14	-	1043	1199
292	092	045	LR	YY	00	18	928	450	1350	713	1,25	36,00	22,14	-	724	833
		060				18	928	600	1692	889	1,26	47,16	26,64	-	832	957
		100				18	928	1000	2610	1357	1,28	82,08	43,56	-	1083	1245
292	097	045	LR	YY	00	19	978	450	1425	752	1,25	38,00	23,37	-	744	856
		060				19	978	600	1786	938	1,26	49,78	28,12	-	854	982
		100				19	978	1000	2755	1433	1,28	86,64	45,98	-	1125	1294
292	102	045	LR	YY	00	20	1028	450	1500	792	1,25	40,00	24,60	-	767	882
		060				20	1028	600	1880	988	1,26	52,40	29,60	-	883	1015
		100				20	1028	1000	2900	1508	1,28	91,20	48,40	-	1166	1341
292	107	045	LR	YY	00	21	1078	450	1575	832	1,25	42,00	25,83	-	800	920
		060				21	1078	600	1974	1037	1,26	55,02	31,08	-	922	1060
		100				21	1078	1000	3045	1584	1,28	95,76	50,82	-	1219	1402
292	112	045	LR	YY	00	22	1128	450	1650	871	1,25	44,00	27,06	-	822	945
		060				22	1128	600	2068	1086	1,26	57,64	32,56	-	950	1093
		100				22	1128	1000	3190	1659	1,28	100,32	53,24	-	1260	1449
292	117	045	LR	YY	00	23	1178	450	1725	911	1,25	46,00	28,29	-	842	968
		060				23	1178	600	2162	1136	1,26	60,26	34,04	-	978	1125
		100				23	1178	1000	3335	1734	1,28	104,88	55,66	-	1301	1496
292	122	045	LR	YY	00	24	1228	450	1800	951	1,25	48,00	29,52	-	863	992
		060				24	1228	600	2256	1185	1,26	62,88	35,52	-	1003	1153
		100				24	1228	1000	3480	1810	1,28	109,44	58,08	-	1347	1549
292	127	045	LR	YY	00	25	1278	450	1875	990	1,25	50,00	30,75	-	886	1019
		060				25	1278	600	2350	1235	1,26	65,50	37,00	-	1031	1186
		100				25	1278	1000	3625	1885	1,28	114,00	60,50	-	1382	1589
292	132	045	LR	YY	00	26	1328	450	1950	1030	1,25	52,00	31,98	-	923	1061
		060				26	1328	600	2444	1284	1,26	68,12	38,48	-	1074	1235
		100				26	1328	1000	3770	1961	1,28	118,56	62,92	-	1443	1659
292	137	045	LR	YY	00	27	1378	450	2025	1069	1,25	54,00	33,21	-	947	1089
		060				27	1378	600	2538	1333	1,26	70,74	39,96	-	1101	1266
		100				27	1378	1000	3915	2036	1,28	123,12	65,34	-	1483	1705
292	142	045	LR	YY	00	28	1428	450	2100	1109	1,25	56,00	34,44	-	966	1111
		060				28	1428	600	2632	1383	1,26	73,36	41,44	-	1129	1298
		100				28	1428	1000	4060	2111	1,28	127,68	67,76	-	1524	1753

Conform EN442-1: 2014: radiatoren en convectoren

* RAL 9016: geen meerprijs 15%

Voor meer details over onze artikel-data, zie artikel-database: <https://www.2ba.nl>

Voor de warmteafgiftes van andere regimes, kijkt u op p. 348 (correctiefactoren)
 NEDERLAND. Prijzen in euro (excl. BTW)

VINTAGE (VINTAGE 50 / D220)

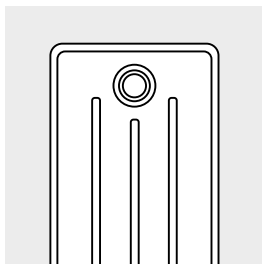

VINTAGE 50 / D220

HOE VINTAGE 50 BESTELLEN
Leveringstermijn 15 - 30 werkdagen
(zonder transportduur)

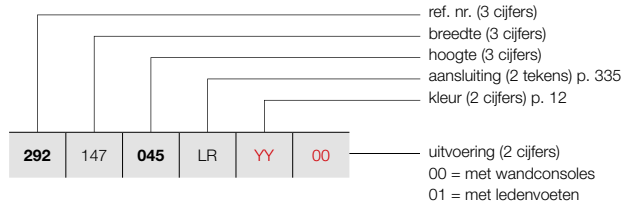

PRIJSGROEP: VPG5 - KOLOMRADIATOREN

BESTELCODE MAATWERK VINTAGE 50							TECHNISCHE GEGEVENS					STANDAARDKLEUR	ANDERE KLEUREN					
292	147	045	LR	YY	00	060	100	buizen	breedte (L mm)	hoogte (H mm)	75/65/20 (Watt) (Φ50K)	55/45/20 (Watt) (Φ30K)	n-exp.	gewicht (kg)	inhoud (l)	el. weerst. (Watt)	prijs S600* (€)	prijs kleur (€)
REF. NR. VINTAGE 50 VINTAGE 50/D220 : 292																		
292	147	045	LR	YY	00	060	100	29	1478	450	2175	1149	1,25	58,00	35,67	-	988	1136
		060						29	1478	600	2726	1432	1,26	75,98	42,92	-	1152	1325
		100						29	1478	1000	4205	2187	1,28	132,24	70,18	-	1566	1801
292	152	045	LR	YY	00	060	100	30	1528	450	2250	1188	1,25	60,00	36,90	-	1007	1158
		060						30	1528	600	2820	1482	1,26	78,60	44,40	-	1180	1357
		100						30	1528	1000	4350	2262	1,28	136,80	72,60	-	1607	1848
292	157	045	LR	YY	00	060	100	31	1578	450	2325	1228	1,25	62,00	38,13	-	1031	1186
		060						31	1578	600	2914	1531	1,26	81,22	45,88	-	1213	1395
292	162	045	LR	YY	00	060	100	32	1628	450	2400	1267	1,25	64,00	39,36	-	1053	1211
		060						32	1628	600	3008	1580	1,26	83,84	47,36	-	1238	1424
292	167	045	LR	YY	00	060	100	33	1678	450	2475	1307	1,25	66,00	40,59	-	1115	1282
		060						33	1678	600	3102	1630	1,26	86,46	48,84	-	1302	1497
292	172	045	LR	YY	00	060	100	34	1728	450	2550	1347	1,25	68,00	41,82	-	1136	1306
		060						34	1728	600	3196	1679	1,26	89,08	50,32	-	1329	1528
292	177	045	LR	YY	00	060	100	35	1778	450	2625	1386	1,25	70,00	43,05	-	1152	1325
		060						35	1778	600	3290	1728	1,26	91,70	51,80	-	1359	1563
292	182	045	LR	YY	00	060	100	36	1828	450	2700	1426	1,25	72,00	44,28	-	1180	1357
		060						36	1828	600	3384	1778	1,26	94,32	53,28	-	1390	1599
292	187	045	LR	YY	00	060	100	37	1878	450	2775	1465	1,25	74,00	45,51	-	1206	1387
		060						37	1878	600	3478	1827	1,26	96,36	54,76	-	1417	1630
292	192	045	LR	YY	00	060	100	38	1928	450	2850	1505	1,25	76,00	46,74	-	1224	1408
		060						38	1928	600	3572	1877	1,26	99,56	56,24	-	1444	1661
292	197	045	LR	YY	00	060	100	39	1978	450	2925	1545	1,25	78,00	47,97	-	1247	1434
		060						39	1978	600	3666	1926	1,26	102,18	57,72	-	1472	1693
292	202	045	LR	YY	00	060	100	40	2028	450	3000	1584	1,25	80,00	49,20	-	1267	1457
		060						40	2028	600	3760	1975	1,26	104,80	59,20	-	1500	1725
292	207	045	LR	YY	00	060	100	41	2078	450	3075	1624	1,25	82,00	50,43	-	1292	1486
		060						41	2078	600	3854	2025	1,26	107,42	60,68	-	1525	1754
292	212	045	LR	YY	00	060	100	42	2128	450	3150	1663	1,25	84,00	51,66	-	1311	1508
		060						42	2128	600	3948	2074	1,26	110,04	62,16	-	1553	1786
292	217	045	LR	YY	00	060	100	43	2178	450	3225	1703	1,25	86,00	52,89	-	1331	1531
		060						43	2178	600	4042	2124	1,26	112,66	63,64	-	1579	1816
292	222	045	LR	YY	00	060	100	44	2228	450	3300	1743	1,25	88,00	54,12	-	1355	1558
		060						44	2228	600	4136	2173	1,26	115,28	65,12	-	1609	1850

Conform EN442-1: 2014: radiatoren en convectoren

* RAL 9016: geen meerprijs 15%

Voor meer details over onze artikel-data, zie artikel-database: <https://www.2ba.nl>

Voor de warmteafgiftes van andere regimes, kijkt u op p. 348 (correctiefactoren)

NETERLAND. Prijzen in euro (excl. BTW)

HOE VINTAGE 50 BESTELLEN

Leveringstermijn 15 - 30 werkdagen
(zonder transportduur)

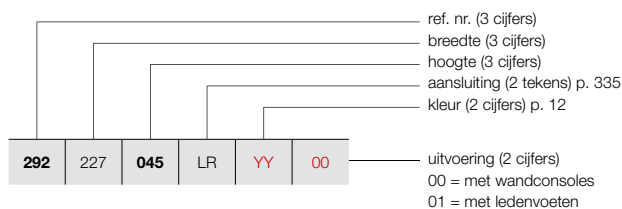

VINTAGE (VINTAGE 50 / D220)

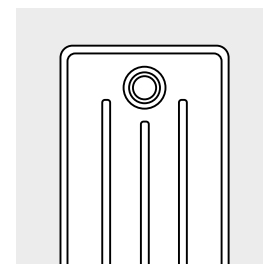

VINTAGE 50 / D220

PRIJSGROEP: VPG5 - KOLOMRADIATOREN

BESTELCODE MAATWERK VINTAGE 50	TECHNISCHE GEGEVENS							STANDAARDKLEUR	ANDERE KLEUREN							
	buizen	breedte (L mm)	hoogte (H mm)	75/65/20 (Watt) (Φ50K)	55/45/20 (Watt) (Φ30K)	n-exp.	gewicht (kg)			inhoud (l)	el. weerst. (Watt)	prijs S600* (€)	prijs kleur (€)			
REF. NR. VINTAGE 50 VINTAGE 50/D220 : 292																
292	227	045	LR	YY	00											
		060														
						45	2278	450	3375	1782	1,25	90,00	55,35	-	1374	1580
						45	2278	600	4230	2222	1,26	117,90	66,60	-	1634	1879
292	232	045	LR	YY	00											
		060														
						46	2328	450	3450	1822	1,25	93,84	56,58	-	1399	1609
						46	2328	600	4324	2272	1,26	120,52	68,08	-	1662	1911
292	237	045	LR	YY	00											
		060														
						47	2378	450	3525	1861	1,25	94,00	57,81	-	1417	1630
						47	2378	600	4418	2321	1,26	123,14	69,56	-	1690	1944
292	242	045	LR	YY	00											
		060														
						48	2428	450	3600	1901	1,25	96,00	59,04	-	1440	1656
						48	2428	600	4512	2370	1,26	125,76	71,04	-	1716	1973
292	247	045	LR	YY	00											
		060														
						49	2478	450	3675	1941	1,25	99,96	60,27	-	1460	1679
						49	2478	600	4606	2420	1,26	128,38	72,52	-	1742	2003
292	252	045	LR	YY	00											
		060														
						50	2528	450	3750	1980	1,25	102,00	61,50	-	1482	1704
						50	2528	600	4700	2469	1,26	131,00	74,00	-	1773	2039
292	257	045	LR	YY	00											
		060														
						51	2578	450	3825	2020	1,25	104,04	62,73	-	1521	1749
292	262	045	LR	YY	00											
		060														
						52	2628	450	3900	2059	1,25	106,08	63,96	-	1541	1772
292	267	045	LR	YY	00											
		060														
						53	2678	450	3975	2099	1,25	108,12	65,19	-	1563	1797
292	272	045	LR	YY	00											
		060														
						54	2728	450	4050	2139	1,25	110,16	66,42	-	1584	1822
292	277	045	LR	YY	00											
		060														
						55	2778	450	4125	2178	1,25	112,20	67,65	-	1606	1847
292	282	045	LR	YY	00											
		060														
						56	2828	450	4200	2218	1,25	114,24	68,88	-	1624	1868
292	287	045	LR	YY	00											
		060														
						57	2878	450	4275	2257	1,25	116,28	70,11	-	1649	1896
292	292	045	LR	YY	00											
		060														
						58	2928	450	4350	2297	1,25	118,32	71,34	-	1669	1919
292	297	045	LR	YY	00											
		060														
						59	2978	450	4425	2337	1,25	120,36	72,57	-	1692	1946
292	302	045	LR	YY	00											
		060														
						60	3028	450	4500	2376	1,25	122,40	73,80	-	1712	1969

Conform EN442-1: 2014: radiatoren en convectoren

* RAL 9016: geen meerprijs 15%
 Voor meer details over onze artikel-data, zie artikel-database: <https://www.2ba.nl>
Voor de warmteafgiftes van andere regimes, kijkt u op p. 348 (correctiefactoren)
NEDERLAND. Prijzen in euro (excl. BTW)

VINTAGE (VINTAGE 50 / D250)

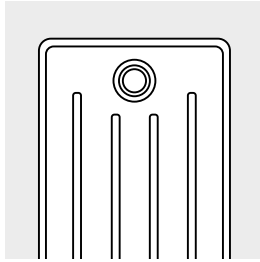

VINTAGE 50 / D250

HOE VINTAGE 50 BESTELLEN
Leveringstermijn 15 - 30 werkdagen
(zonder transportduur)

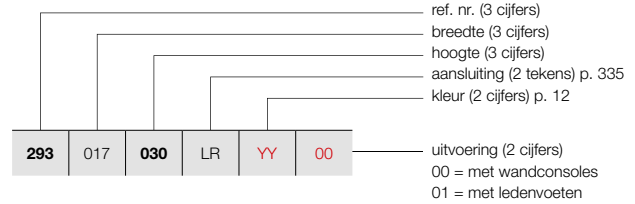

PRIJSGROEP: VPG5 - KOLOMRADIATOREN

BESTELCODE MAATWERK VINTAGE 50	TECHNISCHE GEGEVENS										STANDAARDKLEUR	ANDERE KLEUREN
	buizen	breedte (L mm)	hoogte (H mm)	75/65/20 (Watt) (Φ50K)	55/45/20 (Watt) (Φ30K)	n-exp.	gewicht (kg)	inhoud (l)	el. weerst. (Watt)	prijs S600* (€)	prijs kleur (€)	
REF. NR. VINTAGE 50 VINTAGE 50/D250 : 293												
293 017 030 LR YY 00	3	178	300	186	98	1,26	4,56	2,97	-	395	454	
293 022 030 LR YY 00	4	228	300	248	130	1,26	6,08	3,96	-	417	480	
293 027 030 LR YY 00	5	278	300	310	163	1,26	7,60	4,95	-	440	506	
293 032 030 LR YY 00	6	328	300	372	195	1,26	9,12	5,94	-	458	527	
293 037 030 LR YY 00	7	378	300	434	228	1,26	10,64	6,93	-	478	550	
293 042 030 LR YY 00	8	428	300	496	261	1,26	12,16	7,92	-	510	587	
293 047 030 LR YY 00	9	478	300	558	293	1,26	13,68	8,91	-	527	606	
293 052 030 LR YY 00	10	528	300	620	326	1,26	15,20	9,90	-	549	631	
293 057 030 LR YY 00	11	578	300	682	358	1,26	16,72	10,89	-	576	662	
293 062 030 LR YY 00	12	628	300	744	391	1,26	18,34	11,88	-	596	685	
293 067 030 LR YY 00	13	678	300	806	423	1,26	19,76	12,87	-	616	708	
293 072 030 LR YY 00	14	728	300	868	456	1,26	21,28	13,86	-	636	731	
293 077 030 LR YY 00	15	778	300	930	489	1,26	22,80	14,85	-	660	759	
293 082 030 LR YY 00	16	828	300	992	521	1,26	24,32	15,84	-	679	781	
293 087 030 LR YY 00	17	878	300	1054	554	1,26	25,84	16,83	-	699	804	
293 092 030 LR YY 00	18	928	300	1116	586	1,26	27,36	17,82	-	721	829	
293 097 030 LR YY 00	19	978	300	1178	619	1,26	28,88	18,81	-	741	852	
293 102 030 LR YY 00	20	1028	300	1240	651	1,26	30,40	19,80	-	760	874	
293 107 030 LR YY 00	21	1078	300	1302	684	1,26	31,92	20,79	-	795	914	
293 112 030 LR YY 00	22	1128	300	1364	717	1,26	33,44	21,78	-	815	937	
293 117 030 LR YY 00	23	1178	300	1426	749	1,26	34,96	22,77	-	838	964	
293 122 030 LR YY 00	24	1228	300	1488	782	1,26	36,68	23,76	-	855	983	
293 127 030 LR YY 00	25	1278	300	1550	814	1,26	38,00	24,75	-	879	1011	
293 132 030 LR YY 00	26	1328	300	1612	847	1,26	39,52	25,74	-	918	1056	
293 137 030 LR YY 00	27	1378	300	1674	879	1,26	41,04	26,73	-	940	1081	
293 142 030 LR YY 00	28	1428	300	1736	912	1,26	42,56	27,72	-	960	1104	
293 147 030 LR YY 00	29	1478	300	1798	945	1,26	44,08	28,71	-	981	1128	

Conform EN442-1: 2014: radiatoren en convectoren

* RAL 9016: geen meerprijs 15%

Voor meer details over onze artikel-data, zie artikel-database: <https://www.2ba.nl>

Voor de warmteafgiftes van andere regimes, kijkt u op p. 348 (correctiefactoren)
NEDERLAND. Prijzen in euro (excl. BTW)

HOE VINTAGE 50 BESTELLEN

Leveringstermijn 15 - 30 werkdagen
(zonder transportduur)

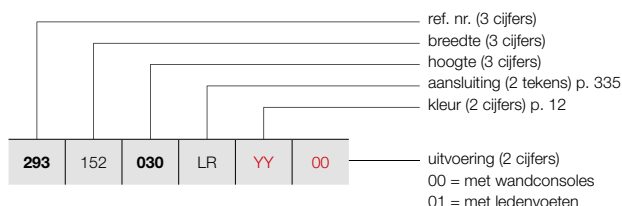

VINTAGE (VINTAGE 50 / D250)

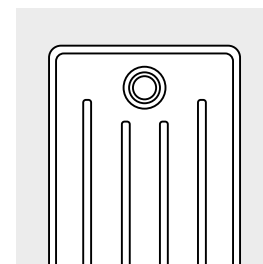

VINTAGE 50 / D250

PRIJSGROEP: VPG5 - KOLOMRADIATOREN

BESTELCODE MAATWERK VINTAGE 50	TECHNISCHE GEGEVENS										STANDAARDKLEUR	ANDERE KLEUREN				
	buizen	breedte (L mm)	hoogte (H mm)	75/65/20 (Watt) (Φ50K)	55/45/20 (Watt) (Φ30K)	n-exp.	gewicht (kg)	inhoud (l)	el. weerst. (Watt)	prijs S600* (€)			prijs kleur (€)			
REF. NR. VINTAGE 50 VINTAGE 50/D250 : 293																
293	152	030	LR	YY	00	30	1528	300	1860	977	1,26	45,60	29,70	-	1000	1150
293	157	030	LR	YY	00	31	1578	300	1922	1010	1,26	47,12	30,69	-	1022	1175
293	162	030	LR	YY	00	32	1628	300	1984	1042	1,26	48,64	31,68	-	1044	1201
293	167	030	LR	YY	00	33	1678	300	2046	1075	1,26	50,16	32,67	-	1102	1267
293	172	030	LR	YY	00	34	1728	300	2108	1107	1,26	51,68	33,66	-	1125	1294
293	177	030	LR	YY	00	35	1778	300	2170	1140	1,26	53,20	34,65	-	1144	1316
293	182	030	LR	YY	00	36	1828	300	2232	1173	1,26	55,02	35,64	-	1171	1347
293	187	030	LR	YY	00	37	1878	300	2294	1205	1,26	56,24	36,63	-	1191	1370
293	192	030	LR	YY	00	38	1928	300	2356	1238	1,26	57,76	37,62	-	1214	1396
293	197	030	LR	YY	00	39	1978	300	2418	1270	1,26	59,28	38,61	-	1229	1413
293	202	030	LR	YY	00	40	2028	300	2480	1303	1,26	60,80	39,60	-	1254	1442
293	207	030	LR	YY	00	41	2078	300	2542	1336	1,26	62,32	40,59	-	1275	1466
293	212	030	LR	YY	00	42	2128	300	2604	1368	1,26	63,84	41,58	-	1295	1489
293	217	030	LR	YY	00	43	2178	300	2666	1401	1,26	65,36	42,57	-	1317	1515
293	222	030	LR	YY	00	44	2228	300	2728	1433	1,26	66,88	43,56	-	1334	1534
293	227	030	LR	YY	00	45	2278	300	2790	1466	1,26	68,40	44,55	-	1358	1562
293	232	030	LR	YY	00	46	2328	300	2852	1498	1,26	69,92	45,54	-	1375	1581
293	237	030	LR	YY	00	47	2378	300	2914	1531	1,26	71,44	46,53	-	1399	1609
293	242	030	LR	YY	00	48	2428	300	2976	1564	1,26	73,36	47,52	-	1417	1630
293	247	030	LR	YY	00	49	2478	300	3038	1596	1,26	74,48	48,51	-	1437	1653
293	252	030	LR	YY	00	50	2528	300	3100	1629	1,26	76,00	49,50	-	1460	1679
293	257	030	LR	YY	00	51	2578	300	3162	1661	1,26	77,52	50,49	-	1503	1728
293	262	030	LR	YY	00	52	2628	300	3224	1694	1,26	79,04	51,48	-	1522	1750
293	267	030	LR	YY	00	53	2678	300	3286	1726	1,26	80,56	52,47	-	1542	1773
293	272	030	LR	YY	00	54	2728	300	3348	1759	1,26	82,08	53,46	-	1563	1797
293	277	030	LR	YY	00	55	2778	300	3410	1792	1,26	83,60	54,45	-	1584	1822
293	282	030	LR	YY	00	56	2828	300	3472	1824	1,26	85,12	55,44	-	1604	1845

Conform EN442-1: 2014: radiatoren en convectoren

* RAL 9016: geen meerprijs 15%

Voor meer details over onze artikel-data, zie artikel-database: <https://www.2ba.nl>

Voor de warmteafgiftes van andere regimes, kijkt u op p. 348 (correctiefactoren)
NEDERLAND. Prijzen in euro (excl. BTW)

VINTAGE (VINTAGE 50 / D250)

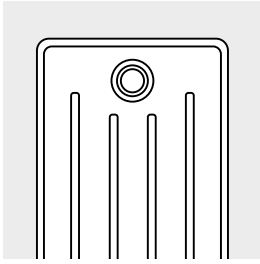

VINTAGE 50 / D250

HOE VINTAGE 50 BESTELLEN

Leveringstermijn 15 - 30 werkdagen
(zonder transportduur)

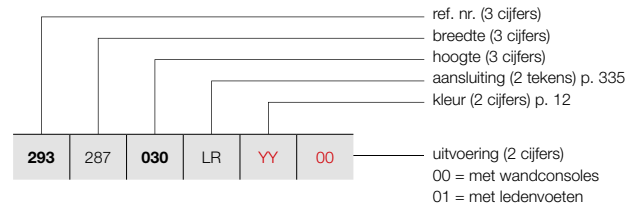

PRIJSGROEP: VPG5 - KOLOMRADIATOREN

BESTELCODE MAATWERK VINTAGE 50	TECHNISCHE GEGEVENS										STANDAARDKLEUR	ANDERE KLEUREN
	buizen	breedte (L mm)	hoogte (H mm)	75/65/20 (Watt) (Φ50K)	55/45/20 (Watt) (Φ30K)	n-exp.	gewicht (kg)	inhoud (l)	el. weerst. (Watt)	prijs S600* (€)	prijs kleur (€)	
REF. NR. VINTAGE 50 VINTAGE 50/D250 : 293												
293 287 030 LR YY 00	57	2878	300	3534	1857	1,26	86,64	56,43	-	1624	1868	
293 292 030 LR YY 00	58	2928	300	3596	1889	1,26	88,16	57,42	-	1646	1893	
293 297 030 LR YY 00	59	2978	300	3658	1922	1,26	89,68	58,41	-	1666	1916	
293 302 030 LR YY 00	60	3028	300	3720	1954	1,26	91,70	59,40	-	1687	1940	



Conform EN442-1: 2014: radiatoren en convectoren

* RAL 9016: geen meerprijs 15%

Voor meer details over onze artikel-data, zie artikel-database: <https://www.2ba.nl>

Voor de warmteafgiftes van andere regimes, kijkt u op p. 348 (correctiefactoren)
NEDERLAND. Prijzen in euro (excl. BTW)

PRIJSGROEP: VPG10 - ACC.

BEVESTIGINGEN		VINTAGE 50	KLEUR
WANDBEVESTIGING			in de kleur van de radiator*
LEDENVOETEN		<p>VINTAGE 50</p> <p>2 voeten voor 25 leden</p> <p>3 voeten voor 50 leden</p> <p>4 voeten voor 60 leden</p>	in de kleur van de radiator*

* Voeten en bevestigingen voor radiatoren in transparante coating zijn gelakt in de kleur N507.

VINTAGE AANSLUITINGEN

VINTAGE: VINTAGE 50

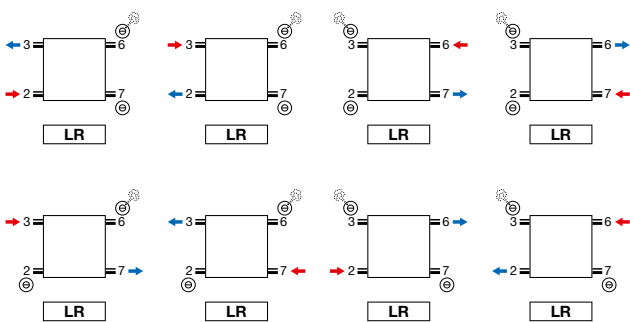

- Ontluchter in aansluiting 3 of 6.

VINTAGE: VINTAGE 50

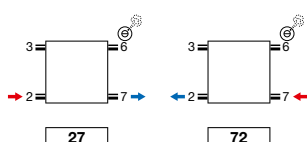

- Ontluchter in aansluiting 3 of 6.
- Aansluitingen op speciale aanvraag: meerprijs €80

Opmerking: het aansluiten van de radiator kan enkel volgens de getoonde aansluiticonen. Voor elke andere aansluitwijze nemen wij geen verantwoordelijkheid.

VINTAGE (VINTAGE 50)

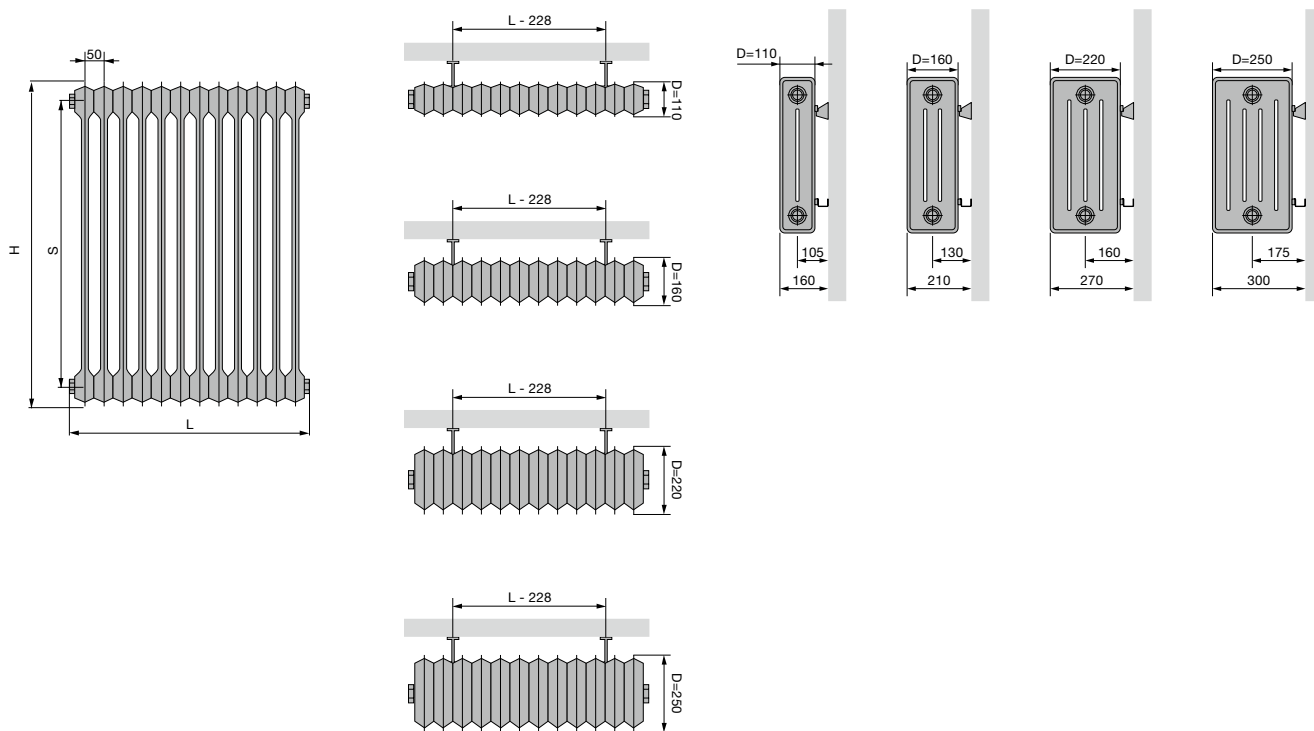

VINTAGE 50

Hoogte (H)	300	450	600	1000
Hartafstand tussen de zijaansluitingen (S)	200	350	500	900

VINTAGE (VINTAGE 50)

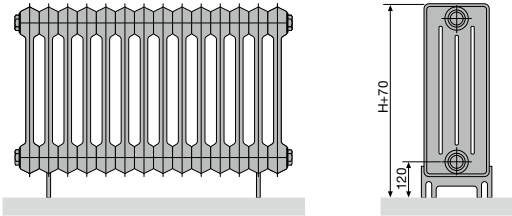

VINTAGE 50 (VLOERMONTAGE)

Aantal leden	2-25	26-50	51-60
Aantal voeten	2	3	4

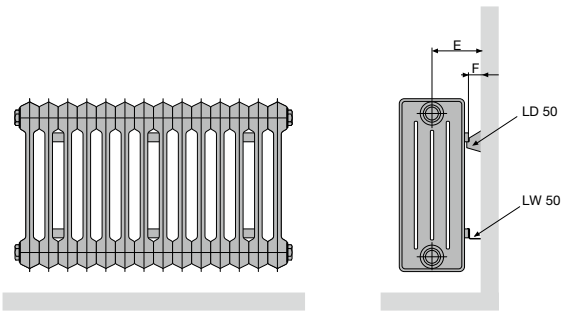

VINTAGE 50 (WANDMONTAGE) LD 50 + LW 50

Diepte (D)	110	160	220	250
Afstand tussen wand en aansluiting (E)	105	130	160	175
Afstand tussen wand en achterkant radiator (F)	50			

VINTAGE 50 (WANDMONTAGE)

Aantal leden	3-5	6-25	26-50	51-60
Aantal muurbevestigingen set LD 50 + LW 50	1	2	3	4

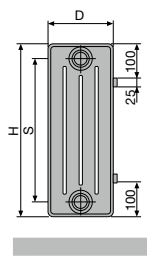

VINTAGE 50

Hoogte (H)	300	450	600	1000
Hartafstand tussen de zijansluitingen (S)	200	350	500	900

