

Plintradiatoren



VASCO past zijn kritische kijk op comfort en design ook toe op zijn plintradiatoren.

Hier is alles toegespitst op **een zo hoog mogelijk rendement** en een zo fraai mogelijke vormgeving. De beste en elegantste manier om de ruimte onder grote raamoppervlakken te voorzien van een passende verwarmingsoplossing.

VASCO plintradiatoren zorgen voor een gelijkmatige warmteverdeling in de hele woonruimte, met **een minimum aan warmteverlies via het raam.**

Ze kunnen **zowel vrijstaand als via een bevestiging aan de muur** geïnstalleerd worden, in de passende hoogte, diepte en lengte al naargelang van de benodigde verwarmingscapaciteit.

Plintradiatoren

Primula

274



TYPES

- P1, P2, P3, P4

BUIZEN

- Horizontaal, rechthoekig 70 x 10 mm
- Tussen de rechthoekige buizen is een krachtige convectie-warmtewisselaar uit stalen precisiebuisen van Ø 12 x 1 mm en rechthoekige lamellen van 0,4 mm gelast.

COLLECTOREN

- 2 geïntegreerde stalen collectoren

KLEUREN

- Standaardkleur wit RAL 9016
- Uitgebreide kleurenkaart zie p. 12

SPECIAAL

- Type Primula wordt in 4 hoogtes (70, 140, 210 en 280 mm), in 5 dieptes (80, 130, 180, 230 en 280 mm) en in 20 lengtes (van 500 tot 3900 mm) geleverd.
- Een elegant afdekrooster wordt standaard meegeleverd.
- Muurbevestigingen, telescopische voetjes of kolomvoeten kunnen mits meerprijs meegeleverd worden (niet in de prijs inbegrepen).

BEVESTIGINGEN

- Apart te bestellen, niet in de prijs van de plint inbegrepen

TECHNISCH

- Elektrisch lasergelast (onzichtbare lasnaden)
- KTL-grondlaag, poedercoating
- Standaardwerkdruk: 4 bar
- Meerprijs voor hogere werkdruk (10 bar): + 10%.
- De leveringstermijn van radiator met een hogere werkdruk is 1 week extra.
- Maximale bedrijfstemperatuur: 110°C

ELEKTRISCH

- ✗ Zuiver elektrische radiator in de fabriek voorgevuld
- ✗ Gemengde radiator

TECHNISCHE TEKENINGEN

- Zie p. 298

AANSLUITING

- ✓ Eénpuntsaansluiting voor éénpijpssysteem (radiator speciaal te bestellen) **(op aanvraag)** (zie p. 341)
- ✓ Eénpuntsaansluiting voor tweepijpssysteem (radiator speciaal te bestellen) **(op aanvraag)** (zie p. 341)
- ✗ Tweepuntsaansluiting voor éénpijpssysteem
- ✓ Tweepuntsaansluiting voor tweepijpssysteem (standaard) (zie p. 340)
- ✗ Geïntegreerd ventiel
- Aansluitingen: ½" (binnendraad)

PRIMULA

Verwamingscomfort met ruimtegevoel

Een ruimte met grote raampartijen verwarmen, geheel in lijn met de interieurinrichting en de architectuur is een kolfje naar de hand van de Primula design plintradiator. De strakke, horizontale lijnvoering op lage hoogte draagt bij tot het gewenste ruimtegevoel en de hoge warmteafgifte, ook in de minimale uitvoering, maakt het eigentijds comfort compleet.

AANBEVOLEN AANSLUITING (18)

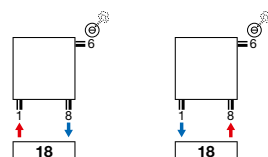

Andere aansluitmogelijkheden, zie p. 297



HOE P1/80 BESTELLEN

Leveringstermijn 15 - 30 werkdagen
(zonder transportduur)

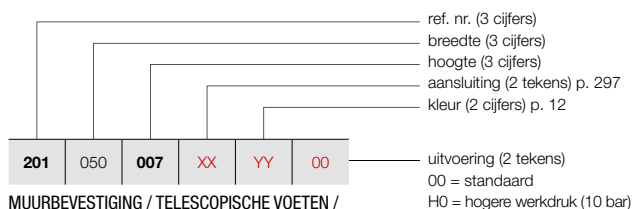

MUURBEVESTIGING / TELESCOPISCHE VOETEN / KOLOMVOETEN

Zie p. 295 voor extra toebehoren.

PRIMULA P1 (P1/80)



P1

PRIJSGROEP: VPG3 - PLINTRADIATOREN

BESTELCODE MAATWERK P1	TECHNISCHE GEGEVENS											STANDAARDKLEUR	ANDERE KLEUREN			
	buizen	breedte (L mm)	hoogte (H mm)	75/65/20 (Watt) (Φ50K)	55/45/20 (Watt) (Φ30K)	n-exp.	gewicht (kg)	inhoud (l)	el. weerst. (Watt)			prijs RAL 9016 (€)	prijs kleur (€)			
REF. NR. P1/80 : 201																
201	050	007	XX	YY	00	-	500	70	203	101	1,36	3,07	0,66	-	297	342
201	060	007	XX	YY	00	-	600	70	243	121	1,36	3,68	0,79	-	311	358
201	070	007	XX	YY	00	-	700	70	284	142	1,36	4,29	0,92	-	324	373
201	080	007	XX	YY	00	-	800	70	324	162	1,36	4,90	1,05	-	339	390
201	090	007	XX	YY	00	-	900	70	365	182	1,36	5,52	1,18	-	356	409
201	100	007	XX	YY	00	-	1000	70	405	202	1,36	6,13	1,31	-	366	421
201	110	007	XX	YY	00	-	1100	70	446	223	1,36	6,74	1,44	-	379	436
201	120	007	XX	YY	00	-	1200	70	486	243	1,36	7,36	1,57	-	395	454
201	140	007	XX	YY	00	-	1400	70	567	283	1,36	8,58	1,83	-	426	490
201	160	007	XX	YY	00	-	1600	70	648	323	1,36	9,81	2,10	-	450	518
201	180	007	XX	YY	00	-	1800	70	729	364	1,36	11,03	2,36	-	477	549
201	200	007	XX	YY	00	-	2000	70	810	404	1,36	12,26	2,62	-	510	587
201	220	007	XX	YY	00	-	2200	70	891	445	1,36	13,49	2,88	-	531	611
201	240	007	XX	YY	00	-	2400	70	972	485	1,36	14,71	3,14	-	561	645
201	260	007	XX	YY	00	-	2600	70	1053	526	1,36	15,94	3,41	-	589	677
201	280	007	XX	YY	00	-	2800	70	1134	566	1,36	17,16	3,67	-	617	710
201	300	007	XX	YY	00	-	3000	70	1215	607	1,36	18,39	3,93	-	646	743
201	330	007	XX	YY	00	-	3300	70	1337	667	1,36	20,23	4,32	-	688	791
201	360	007	XX	YY	00	-	3600	70	1458	728	1,36	22,07	4,72	-	729	838
201	390	007	XX	YY	00	-	3900	70	1580	789	1,36	23,91	5,11	-	770	886

Conform EN442-1: 2014: radiatoren en convectoren

Voor meer details over onze artikel-data, zie artikel-database: <https://www.installdata.be>
Voor de warmteafgiftes van andere regimes, kijkt u op p. 348 (correctiefactoren)
NEDERLAND. Prijzen in euro (excl. BTW)

PRIMULA P1 (P1/130)



P1

HOE P1/130 BESTELLEN

Leveringstermijn 15 - 30 werkdagen
(zonder transportduur)

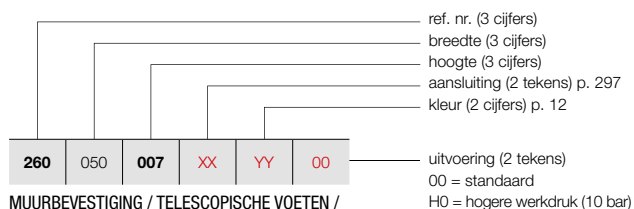

MUURBEVESTIGING / TELESCOPISCHE VOETEN /
KOLOMVOETEN

Zie p. 295 voor extra toebehoren.

PRIJSGROEP: VPG3 - PLINTRADIATOREN

BESTELCODE MAATWERK P1	TECHNISCHE GEGEVENS										STANDAARDKLEUR	ANDERE KLEUREN
	buizen	breedte (L mm)	hoogte (H mm)	75/65/20 (Watt) (φ50K)	55/45/20 (Watt) (φ30K)	n-exp.	gewicht (kg)	inhoud (l)	el. weerst. (Watt)		prijs RAL 9016 (€)	prijs kleur (€)
REF. NR. P1/130 : 260												
260 050 007 XX YY 00	-	500	70	312	156	1,36	4,33	0,88	-		396	455
260 060 007 XX YY 00	-	600	70	374	187	1,36	5,19	1,05	-		419	482
260 070 007 XX YY 00	-	700	70	437	218	1,36	6,06	1,23	-		441	507
260 080 007 XX YY 00	-	800	70	499	249	1,36	6,92	1,40	-		462	531
260 090 007 XX YY 00	-	900	70	562	281	1,36	7,79	1,58	-		482	554
260 100 007 XX YY 00	-	1000	70	624	312	1,36	8,65	1,75	-		510	587
260 110 007 XX YY 00	-	1100	70	686	342	1,36	9,52	1,93	-		527	606
260 120 007 XX YY 00	-	1200	70	749	374	1,36	10,38	2,10	-		551	634
260 140 007 XX YY 00	-	1400	70	874	436	1,36	12,11	2,45	-		594	683
260 160 007 XX YY 00	-	1600	70	998	498	1,36	13,84	2,80	-		636	731
260 180 007 XX YY 00	-	1800	70	1123	561	1,36	15,57	3,15	-		684	787
260 200 007 XX YY 00	-	2000	70	1248	623	1,36	17,30	3,50	-		725	834
260 220 007 XX YY 00	-	2200	70	1373	685	1,36	19,03	3,85	-		769	884
260 240 007 XX YY 00	-	2400	70	1498	748	1,36	20,76	4,20	-		814	936
260 260 007 XX YY 00	-	2600	70	1622	810	1,36	22,49	4,55	-		854	982
260 280 007 XX YY 00	-	2800	70	1747	872	1,36	24,22	4,90	-		900	1035
260 300 007 XX YY 00	-	3000	70	1872	935	1,36	25,95	5,25	-		946	1088
260 330 007 XX YY 00	-	3300	70	2059	1028	1,36	28,55	5,78	-		1007	1158
260 360 007 XX YY 00	-	3600	70	2246	1121	1,36	31,14	6,30	-		1074	1235
260 390 007 XX YY 00	-	3900	70	2434	1215	1,36	33,74	6,83	-		1142	1313

Conform EN442-1: 2014: radiatoren en convectoren

Voor meer details over onze artikel-data, zie artikel-database: <https://www.installdata.be>
Voor de warmteafgifte van andere regimes, kijkt u op p. 348 (correctiefactoren)
NEDERLAND. Prijzen in euro (excl. BTW)

HOE P1/180 BESTELLEN

Leveringstermijn 15 - 30 werkdagen
(zonder transportduur)

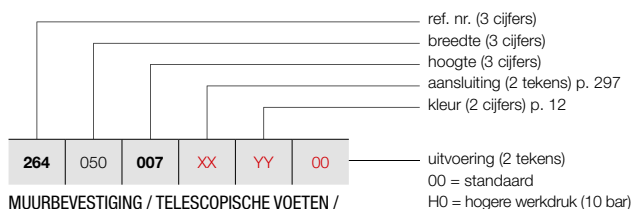

MUURBEVESTIGING / TELESCOPISCHE VOETEN /
KOLOMVOETEN

Zie p. 295 voor extra toebehoren.

PRIMULA P1 (P1/180)



P1

PRIJSGROEP: VPG3 - PLINTRADIATOREN

BESTELCODE MAATWERK P1	TECHNISCHE GEGEVENS											STANDAARDKLEUR	ANDERE KLEUREN			
	buizen	breedte (L mm)	hoogte (H mm)	75/65/20 (Watt) (Φ50K)	55/45/20 (Watt) (Φ30K)	n-exp.	gewicht (kg)	inhoud (l)	el. weerst. (Watt)	prijs RAL 9016 (€)	prijs kleur (€)					
REF. NR. P1/180 : 264																
264	050	007	XX	YY	00	-	500	70	422	212	1,35	5,70	1,05	-	527	606
264	060	007	XX	YY	00	-	600	70	506	254	1,35	6,84	1,26	-	559	643
264	070	007	XX	YY	00	-	700	70	590	296	1,35	7,98	1,47	-	595	684
264	080	007	XX	YY	00	-	800	70	674	338	1,35	9,12	1,68	-	629	723
264	090	007	XX	YY	00	-	900	70	759	381	1,35	10,26	1,89	-	663	762
264	100	007	XX	YY	00	-	1000	70	843	423	1,35	11,40	2,10	-	696	800
264	110	007	XX	YY	00	-	1100	70	927	465	1,35	12,54	2,31	-	733	843
264	120	007	XX	YY	00	-	1200	70	1012	508	1,35	13,68	2,52	-	767	882
264	140	007	XX	YY	00	-	1400	70	1180	592	1,35	15,96	2,94	-	835	960
264	160	007	XX	YY	00	-	1600	70	1349	677	1,35	18,24	3,36	-	903	1038
264	180	007	XX	YY	00	-	1800	70	1517	761	1,35	20,52	3,78	-	971	1117
264	200	007	XX	YY	00	-	2000	70	1686	846	1,35	22,80	4,20	-	1039	1195
264	220	007	XX	YY	00	-	2200	70	1855	931	1,35	25,08	4,62	-	1105	1271
264	240	007	XX	YY	00	-	2400	70	2023	1015	1,35	27,36	5,04	-	1176	1352
264	260	007	XX	YY	00	-	2600	70	2192	1100	1,35	29,64	5,46	-	1245	1432
264	280	007	XX	YY	00	-	2800	70	2360	1184	1,35	31,92	5,88	-	1311	1508
264	300	007	XX	YY	00	-	3000	70	2529	1269	1,35	34,20	6,30	-	1378	1585
264	330	007	XX	YY	00	-	3300	70	2782	1396	1,35	37,62	6,93	-	1482	1704
264	360	007	XX	YY	00	-	3600	70	3035	1523	1,35	41,04	7,56	-	1585	1823
264	390	007	XX	YY	00	-	3900	70	3288	1650	1,35	44,46	8,19	-	1687	1940

Conform EN442-1: 2014: radiatoren en convectoren

Voor meer details over onze artikel-data, zie artikel-database: <https://www.installdata.be>
Voor de warmteafgiftes van andere regimes, kijkt u op p. 348 (correctiefactoren)
NEDERLAND. Prijzen in euro (excl. BTW)

PRIMULA P1 (P1/230)



P1

HOE P1/230 BESTELLEN

Leveringstermijn 15 - 30 werkdagen
(zonder transportduur)

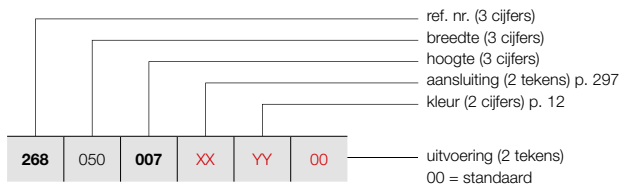

MUURBEVESTIGING / TELESCOPISCHE VOETEN /
KOLOMVOETEN

Zie p. 295 voor extra toebehoren.

PRIJSGROEP: VPG3 - PLINTRADIATOREN

BESTELCODE MAATWERK P1	TECHNISCHE GEGEVENS										STANDAARDKLEUR	ANDERE KLEUREN
	buizen	breedte (L mm)	hoogte (H mm)	75/65/20 (Watt) (φ50K)	55/45/20 (Watt) (φ30K)	n-exp.	gewicht (kg)	inhoud (l)	el. weerst. (Watt)		prijs RAL 9016 (€)	prijs kleur (€)
REF. NR. P1/230 : 268												
268 050 007 XX YY 00	-	500	70	523	258	1,38	6,90	1,20	-		672	773
268 060 007 XX YY 00	-	600	70	627	310	1,38	8,28	1,44	-		717	825
268 070 007 XX YY 00	-	700	70	732	362	1,38	9,66	1,68	-		761	875
268 080 007 XX YY 00	-	800	70	836	413	1,38	11,04	1,92	-		808	929
268 090 007 XX YY 00	-	900	70	941	465	1,38	12,42	2,16	-		851	979
268 100 007 XX YY 00	-	1000	70	1045	516	1,38	13,80	2,40	-		899	1034
268 110 007 XX YY 00	-	1100	70	1150	568	1,38	15,18	2,64	-		946	1088
268 120 007 XX YY 00	-	1200	70	1254	620	1,38	16,56	2,88	-		988	1136
268 140 007 XX YY 00	-	1400	70	1463	723	1,38	19,32	3,36	-		1079	1241
268 160 007 XX YY 00	-	1600	70	1672	826	1,38	22,08	3,84	-		1170	1346
268 180 007 XX YY 00	-	1800	70	1881	929	1,38	24,84	4,32	-		1259	1448
268 200 007 XX YY 00	-	2000	70	2090	1033	1,38	27,60	4,80	-		1351	1554
268 220 007 XX YY 00	-	2200	70	2299	1136	1,38	30,36	5,28	-		1442	1658
268 240 007 XX YY 00	-	2400	70	2508	1239	1,38	33,12	5,76	-		1530	1760
268 260 007 XX YY 00	-	2600	70	2717	1343	1,38	35,88	6,24	-		1621	1864
268 280 007 XX YY 00	-	2800	70	2926	1446	1,38	38,64	6,72	-		1712	1969
268 300 007 XX YY 00	-	3000	70	3135	1549	1,38	41,40	7,20	-		1804	2075
268 330 007 XX YY 00	-	3300	70	3449	1704	1,38	45,54	7,92	-		1939	2230
268 360 007 XX YY 00	-	3600	70	3762	1859	1,38	49,68	8,64	-		2073	2384
268 390 007 XX YY 00	-	3900	70	4076	2014	1,38	53,82	9,36	-		2211	2543

Conform EN442-1: 2014: radiatoren en convectoren

Voor meer details over onze artikel-data, zie artikel-database: <https://www.installdata.be>
Voor de warmteafgifte van andere regimes, kijkt u op p. 348 (correctiefactoren)
NEDERLAND. Prijzen in euro (excl. BTW)

HOE P1/280 BESTELLEN

Leveringstermijn 15 - 30 werkdagen
(zonder transportduur)

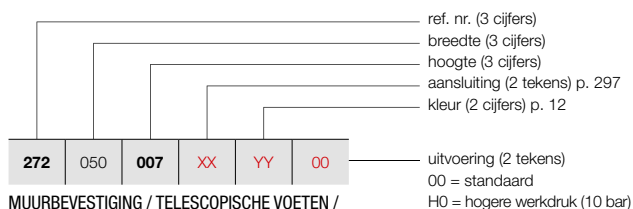

MUURBEVESTIGING / TELESCOPISCHE VOETEN /
KOLOMVOETEN

Zie p. 295 voor extra toebehoren.

PRIMULA P1 (P1/280)



P1

PRIJSGROEP: VPG3 - PLINTRADIATOREN

BESTELCODE MAATWERK P1	TECHNISCHE GEGEVENS											STANDAARDKLEUR	ANDERE KLEUREN			
	buizen	breedte (L mm)	hoogte (H mm)	75/65/20 (Watt) (Φ50K)	55/45/20 (Watt) (Φ30K)	n-exp.	gewicht (kg)	inhoud (l)	el. weerst. (Watt)			prijs RAL 9016 (€)	prijs kleur (€)			
REF. NR. P1/280 : 272																
272	050	007	XX	YY	00	-	500	70	630	315	1,36	8,00	1,40	-	823	946
272	060	007	XX	YY	00	-	600	70	756	377	1,36	9,60	1,68	-	880	1012
272	070	007	XX	YY	00	-	700	70	882	440	1,36	11,20	1,96	-	933	1073
272	080	007	XX	YY	00	-	800	70	1008	503	1,36	12,80	2,24	-	989	1137
272	090	007	XX	YY	00	-	900	70	1134	566	1,36	14,40	2,52	-	1047	1204
272	100	007	XX	YY	00	-	1000	70	1260	629	1,36	16,00	2,80	-	1101	1266
272	110	007	XX	YY	00	-	1100	70	1386	692	1,36	17,60	3,08	-	1159	1333
272	120	007	XX	YY	00	-	1200	70	1512	755	1,36	19,20	3,36	-	1214	1396
272	140	007	XX	YY	00	-	1400	70	1764	881	1,36	22,40	3,92	-	1323	1521
272	160	007	XX	YY	00	-	1600	70	2016	1006	1,36	25,60	4,48	-	1433	1648
272	180	007	XX	YY	00	-	1800	70	2268	1132	1,36	28,80	5,04	-	1544	1776
272	200	007	XX	YY	00	-	2000	70	2520	1258	1,36	32,00	5,60	-	1656	1904
272	220	007	XX	YY	00	-	2200	70	2772	1384	1,36	35,20	6,16	-	1770	2036
272	240	007	XX	YY	00	-	2400	70	3024	1510	1,36	38,40	6,72	-	1880	2162
272	260	007	XX	YY	00	-	2600	70	3276	1635	1,36	41,60	7,28	-	1988	2286
272	280	007	XX	YY	00	-	2800	70	3528	1761	1,36	44,80	7,84	-	2098	2413
272	300	007	XX	YY	00	-	3000	70	3780	1887	1,36	48,00	8,40	-	2212	2544
272	330	007	XX	YY	00	-	3300	70	4158	2076	1,36	52,80	9,24	-	2377	2734
272	360	007	XX	YY	00	-	3600	70	4536	2264	1,36	57,60	10,08	-	2543	2924
272	390	007	XX	YY	00	-	3900	70	4914	2453	1,36	62,40	10,92	-	2710	3117

Conform EN442-1: 2014: radiatoren en convectoren

Voor meer details over onze artikel-data, zie artikel-database: <https://www.installdata.be>
Voor de warmteafgiftes van andere regimes, kijkt u op p. 348 (correctiefactoren)
NEDERLAND. Prijzen in euro (excl. BTW)

PRIMULA P2 (P2/80)



P2

HOE P2/80 BESTELLEN

Leveringstermijn 15 - 30 werkdagen
(zonder transportduur)

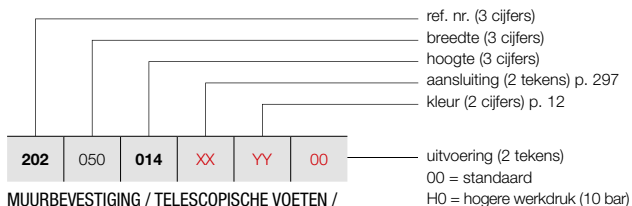

MUURBEVESTIGING / TELESCOPISCHE VOETEN /
KOLOMVOETEN

Zie p. 295 voor extra toebehoren.

PRIJSGROEP: VPG3 - PLINTRADIATOREN

BESTELCODE MAATWERK P2	TECHNISCHE GEGEVENS										STANDAARDKLEUR	ANDERE KLEUREN
	buizen	breedte (L mm)	hoogte (H mm)	75/65/20 (Watt) (φ50K)	55/45/20 (Watt) (φ30K)	n-exp.	gewicht (kg)	inhoud (l)	el. weerst. (Watt)		prijs RAL 9016 (€)	prijs kleur (€)
REF. NR. P2/80 : 202												
202 050 014 XX YY 00	-	500	140	304	153	1,35	5,73	1,46	-		350	403
202 060 014 XX YY 00	-	600	140	365	183	1,35	6,88	1,75	-		369	424
202 070 014 XX YY 00	-	700	140	426	214	1,35	8,02	2,04	-		390	449
202 080 014 XX YY 00	-	800	140	486	244	1,35	9,17	2,33	-		408	469
202 090 014 XX YY 00	-	900	140	547	274	1,35	10,31	2,62	-		433	498
202 100 014 XX YY 00	-	1000	140	608	305	1,35	11,46	2,91	-		454	522
202 110 014 XX YY 00	-	1100	140	669	336	1,35	12,61	3,20	-		474	545
202 120 014 XX YY 00	-	1200	140	730	366	1,35	13,75	3,49	-		492	566
202 140 014 XX YY 00	-	1400	140	851	427	1,35	16,04	4,07	-		535	615
202 160 014 XX YY 00	-	1600	140	973	488	1,35	18,34	4,66	-		578	665
202 180 014 XX YY 00	-	1800	140	1094	549	1,35	20,63	5,24	-		618	711
202 200 014 XX YY 00	-	2000	140	1216	610	1,35	22,92	5,82	-		661	760
202 220 014 XX YY 00	-	2200	140	1338	671	1,35	25,21	6,40	-		701	806
202 240 014 XX YY 00	-	2400	140	1459	732	1,35	27,50	6,98	-		743	854
202 260 014 XX YY 00	-	2600	140	1581	793	1,35	29,80	7,57	-		785	903
202 280 014 XX YY 00	-	2800	140	1702	854	1,35	32,09	8,15	-		826	950
202 300 014 XX YY 00	-	3000	140	1824	915	1,35	34,38	8,73	-		869	999
202 330 014 XX YY 00	-	3300	140	2006	1007	1,35	37,82	9,60	-		931	1071
202 360 014 XX YY 00	-	3600	140	2189	1098	1,35	41,26	10,48	-		994	1143
202 390 014 XX YY 00	-	3900	140	2371	1190	1,35	44,69	11,35	-		1055	1213

Conform EN442-1: 2014: radiatoren en convectoren

Voor meer details over onze artikel-data, zie artikel-database: <https://www.installdata.be>
Voor de warmteafgifte van andere regimes, kijkt u op p. 348 (correctiefactoren)
NEDERLAND. Prijzen in euro (excl. BTW)

HOE P2/130 BESTELLEN

Leveringstermijn 15 - 30 werkdagen
(zonder transportduur)

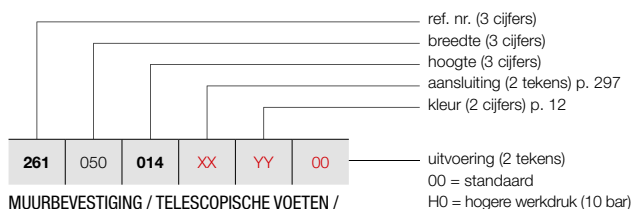

MUURBEVESTIGING / TELESCOPISCHE VOETEN /
KOLOMVOETEN

Zie p. 295 voor extra toebehoren.

PRIMULA P2 (P2/130)



P2

PRIJSGROEP: VPG3 - PLINTRADIATOREN

BESTELCODE MAATWERK P2	TECHNISCHE GEGEVENS											STANDAARDKLEUR	ANDERE KLEUREN			
	buizen	breedte (L mm)	hoogte (H mm)	75/65/20 (Watt) (Φ50K)	55/45/20 (Watt) (Φ30K)	n-exp.	gewicht (kg)	inhoud (l)	el. weerst. (Watt)	prijs RAL 9016 (€)	prijs kleur (€)					
REF. NR. P2/130 : 261																
261	050	014	XX	YY	00	-	500	140	442	221	1,36	7,77	1,87	-	453	521
261	060	014	XX	YY	00	-	600	140	530	265	1,36	9,32	2,24	-	488	561
261	070	014	XX	YY	00	-	700	140	619	309	1,36	10,87	2,61	-	527	606
261	080	014	XX	YY	00	-	800	140	707	353	1,36	12,42	2,98	-	565	650
261	090	014	XX	YY	00	-	900	140	796	397	1,36	13,98	3,36	-	604	695
261	100	014	XX	YY	00	-	1000	140	884	441	1,36	15,53	3,73	-	642	738
261	110	014	XX	YY	00	-	1100	140	972	485	1,36	17,08	4,10	-	679	781
261	120	014	XX	YY	00	-	1200	140	1061	530	1,36	18,64	4,48	-	717	825
261	140	014	XX	YY	00	-	1400	140	1238	618	1,36	21,74	5,22	-	791	910
261	160	014	XX	YY	00	-	1600	140	1414	706	1,36	24,85	5,97	-	866	996
261	180	014	XX	YY	00	-	1800	140	1591	794	1,36	27,95	6,71	-	942	1083
261	200	014	XX	YY	00	-	2000	140	1768	883	1,36	31,06	7,46	-	1017	1170
261	220	014	XX	YY	00	-	2200	140	1945	971	1,36	34,17	8,21	-	1094	1258
261	240	014	XX	YY	00	-	2400	140	2122	1059	1,36	37,27	8,95	-	1170	1346
261	260	014	XX	YY	00	-	2600	140	2298	1147	1,36	40,38	9,70	-	1245	1432
261	280	014	XX	YY	00	-	2800	140	2475	1236	1,36	43,48	10,44	-	1320	1518
261	300	014	XX	YY	00	-	3000	140	2652	1324	1,36	46,59	11,19	-	1398	1608
261	330	014	XX	YY	00	-	3300	140	2917	1456	1,36	51,25	12,31	-	1510	1737
261	360	014	XX	YY	00	-	3600	140	3182	1588	1,36	55,91	13,43	-	1622	1865
261	390	014	XX	YY	00	-	3900	140	3448	1721	1,36	60,57	14,55	-	1736	1996

Conform EN442-1: 2014: radiatoren en convectoren

Voor meer details over onze artikel-data, zie artikel-database: <https://www.installdata.be>
Voor de warmteafgiftes van andere regimes, kijkt u op p. 348 (correctiefactoren)
NEDERLAND. Prijzen in euro (excl. BTW)

PRIMULA P2 (P2/180)



P2

HOE P2/180 BESTELLEN

Leveringstermijn 15 - 30 werkdagen
(zonder transportduur)

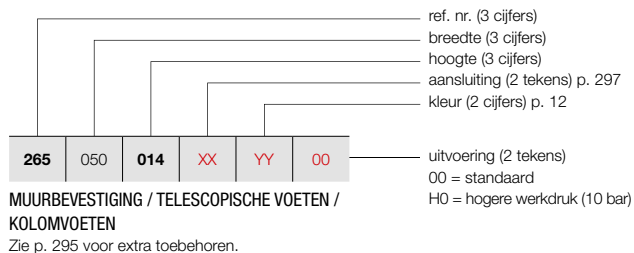

PRIJSGROEP: VPG3 - PLINTRADIATOREN

BESTELCODE MAATWERK P2	TECHNISCHE GEGEVENS										STANDAARDKLEUR	ANDERE KLEUREN
	buizen	breedte (L mm)	hoogte (H mm)	75/65/20 (Watt) (φ50K)	55/45/20 (Watt) (φ30K)	n-exp.	gewicht (kg)	inhoud (l)	el. weerst. (Watt)		prijs RAL 9016 (€)	prijs kleur (€)
REF. NR. P2/180 : 265												
265 050 014 XX YY 00	-	500	140	611	305	1,36	9,90	2,23	-		595	684
265 060 014 XX YY 00	-	600	140	733	366	1,36	11,88	2,67	-		650	748
265 070 014 XX YY 00	-	700	140	855	427	1,36	13,86	3,12	-		702	807
265 080 014 XX YY 00	-	800	140	977	488	1,36	15,84	3,56	-		758	872
265 090 014 XX YY 00	-	900	140	1099	549	1,36	17,82	4,01	-		813	935
265 100 014 XX YY 00	-	1000	140	1221	610	1,36	19,80	4,45	-		863	992
265 110 014 XX YY 00	-	1100	140	1343	670	1,36	21,78	4,90	-		918	1056
265 120 014 XX YY 00	-	1200	140	1465	731	1,36	23,76	5,34	-		974	1120
265 140 014 XX YY 00	-	1400	140	1709	853	1,36	27,72	6,23	-		1082	1244
265 160 014 XX YY 00	-	1600	140	1954	975	1,36	31,68	7,12	-		1188	1366
265 180 014 XX YY 00	-	1800	140	2198	1097	1,36	35,64	8,01	-		1297	1492
265 200 014 XX YY 00	-	2000	140	2442	1219	1,36	39,60	8,90	-		1406	1617
265 220 014 XX YY 00	-	2200	140	2686	1341	1,36	43,56	9,79	-		1513	1740
265 240 014 XX YY 00	-	2400	140	2930	1463	1,36	47,52	10,68	-		1621	1864
265 260 014 XX YY 00	-	2600	140	3175	1585	1,36	51,48	11,57	-		1730	1990
265 280 014 XX YY 00	-	2800	140	3419	1707	1,36	55,44	12,46	-		1836	2111
265 300 014 XX YY 00	-	3000	140	3663	1829	1,36	59,40	13,35	-		1945	2237
265 330 014 XX YY 00	-	3300	140	4029	2011	1,36	65,34	14,69	-		2106	2422
265 360 014 XX YY 00	-	3600	140	4396	2195	1,36	71,28	16,02	-		2268	2608
265 390 014 XX YY 00	-	3900	140	4762	2377	1,36	77,22	17,36	-		2430	2795

Conform EN442-1: 2014: radiatoren en convectoren

Voor meer details over onze artikel-data, zie artikel-database: <https://www.installdata.be>
Voor de warmteafgiftes van andere regimes, kijkt u op p. 348 (correctiefactoren)
NEDERLAND. Prijzen in euro (excl. BTW)

HOE P2/230 BESTELLEN

Leveringstermijn 15 - 30 werkdagen
(zonder transportduur)

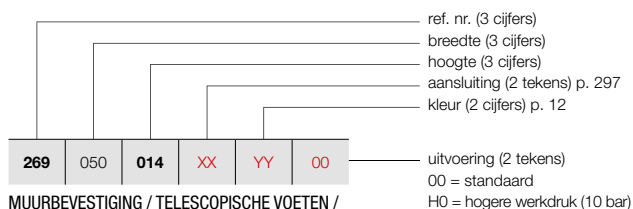

MUURBEVESTIGING / TELESCOPISCHE VOETEN / KOLOMVOETEN

Zie p. 295 voor extra toebehoren.

PRIMULA P2 (P2/230)



P2

PRIJSGROEP: VPG3 - PLINTRADIATOREN

BESTELCODE MAATWERK P2	TECHNISCHE GEGEVENS										STANDAARDKLEUR	ANDERE KLEUREN				
	buizen	breedte (L mm)	hoogte (H mm)	75/65/20 (Watt) (Φ50K)	55/45/20 (Watt) (Φ30K)	n-exp.	gewicht (kg)	inhoud (l)	el. weerst. (Watt)		prijs RAL 9016 (€)	prijs kleur (€)				
REF. NR. P2/230 : 269																
269	050	014	XX	YY	00	-	500	140	756	375	1,37	11,88	2,73	-	767	882
269	060	014	XX	YY	00	-	600	140	907	450	1,37	14,25	3,27	-	841	967
269	070	014	XX	YY	00	-	700	140	1058	525	1,37	16,63	3,82	-	915	1052
269	080	014	XX	YY	00	-	800	140	1209	600	1,37	19,00	4,36	-	989	1137
269	090	014	XX	YY	00	-	900	140	1360	675	1,37	21,38	4,91	-	1065	1225
269	100	014	XX	YY	00	-	1000	140	1511	750	1,37	23,75	5,45	-	1139	1310
269	110	014	XX	YY	00	-	1100	140	1662	825	1,37	26,13	6,00	-	1215	1397
269	120	014	XX	YY	00	-	1200	140	1813	900	1,37	28,50	6,54	-	1285	1478
269	140	014	XX	YY	00	-	1400	140	2115	1050	1,37	33,25	7,63	-	1437	1653
269	160	014	XX	YY	00	-	1600	140	2418	1201	1,37	38,00	8,72	-	1588	1826
269	180	014	XX	YY	00	-	1800	140	2720	1351	1,37	42,75	9,81	-	1737	1998
269	200	014	XX	YY	00	-	2000	140	3022	1501	1,37	47,50	10,90	-	1887	2170
269	220	014	XX	YY	00	-	2200	140	3324	1651	1,37	52,25	11,99	-	2036	2341
269	240	014	XX	YY	00	-	2400	140	3626	1801	1,37	57,00	13,08	-	2184	2512
269	260	014	XX	YY	00	-	2600	140	3929	1951	1,37	61,75	14,17	-	2332	2682
269	280	014	XX	YY	00	-	2800	140	4231	2101	1,37	66,50	15,26	-	2481	2853
269	300	014	XX	YY	00	-	3000	140	4533	2251	1,37	71,25	16,35	-	2631	3026
269	330	014	XX	YY	00	-	3300	140	4986	2476	1,37	78,38	17,99	-	2857	3286
269	360	014	XX	YY	00	-	3600	140	5440	2702	1,37	85,50	19,62	-	3080	3542
269	390	014	XX	YY	00	-	3900	140	5893	2927	1,37	92,63	21,26	-	3304	3800

Conform EN442-1: 2014: radiatoren en convectoren

Voor meer details over onze artikel-data, zie artikel-database: <https://www.installdata.be>
Voor de warmteafgiftes van andere regimes, kijkt u op p. 348 (correctiefactoren)
NEDERLAND. Prijzen in euro (excl. BTW)

PRIMULA P2 (P2/280)



P2

HOE P2/280 BESTELLEN

Leveringstermijn 15 - 30 werkdagen
(zonder transportduur)

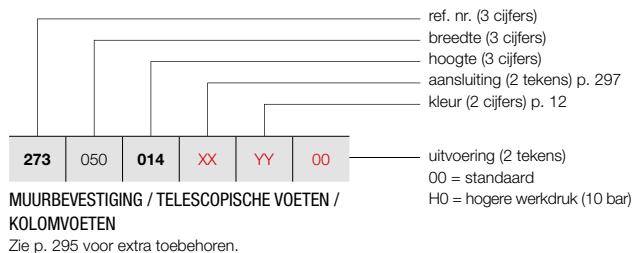

PRIJSGROEP: VPG3 - PLINTRADIATOREN

BESTELCODE MAATWERK P2	TECHNISCHE GEGEVENS										STANDAARDKLEUR	ANDERE KLEUREN				
	buizen	breedte (L mm)	hoogte (H mm)	75/65/20 (Watt) (φ50K)	55/45/20 (Watt) (φ30K)	n-exp.	gewicht (kg)	inhoud (l)	el. weerst. (Watt)		prijs RAL 9016 (€)	prijs kleur (€)				
REF. NR. P2/280 : 273																
273	050	014	XX	YY	00	-	500	140	953	473	1,37	13,85	2,98	-	941	1082
273	060	014	XX	YY	00	-	600	140	1143	568	1,37	16,62	3,57	-	1034	1189
273	070	014	XX	YY	00	-	700	140	1334	663	1,37	19,39	4,17	-	1125	1294
273	080	014	XX	YY	00	-	800	140	1524	757	1,37	22,16	4,76	-	1216	1398
273	090	014	XX	YY	00	-	900	140	1715	852	1,37	24,93	5,36	-	1306	1502
273	100	014	XX	YY	00	-	1000	140	1905	946	1,37	27,70	5,95	-	1400	1610
273	110	014	XX	YY	00	-	1100	140	2096	1041	1,37	30,47	6,55	-	1489	1712
273	120	014	XX	YY	00	-	1200	140	2286	1135	1,37	33,24	7,14	-	1582	1819
273	140	014	XX	YY	00	-	1400	140	2667	1325	1,37	38,78	8,33	-	1766	2031
273	160	014	XX	YY	00	-	1600	140	3048	1514	1,37	44,32	9,52	-	1947	2239
273	180	014	XX	YY	00	-	1800	140	3429	1703	1,37	49,86	10,71	-	2132	2452
273	200	014	XX	YY	00	-	2000	140	3810	1892	1,37	55,40	11,90	-	2313	2660
273	220	014	XX	YY	00	-	2200	140	4191	2082	1,37	60,94	13,09	-	2497	2872
273	240	014	XX	YY	00	-	2400	140	4572	2271	1,37	66,48	14,28	-	2679	3081
273	260	014	XX	YY	00	-	2600	140	4953	2460	1,37	72,02	15,47	-	2864	3294
273	280	014	XX	YY	00	-	2800	140	5334	2649	1,37	77,56	16,66	-	3049	3506
273	300	014	XX	YY	00	-	3000	140	5715	2838	1,37	83,10	17,85	-	3228	3712
273	330	014	XX	YY	00	-	3300	140	6287	3123	1,37	91,41	19,64	-	3506	4032
273	360	014	XX	YY	00	-	3600	140	6858	3406	1,37	99,72	21,42	-	3778	4345
273	390	014	XX	YY	00	-	3900	140	7430	3690	1,37	108,03	23,21	-	4052	4660

Conform EN442-1: 2014: radiatoren en convectoren

Voor meer details over onze artikel-data, zie artikel-database: <https://www.installdata.be>
Voor de warmteafgiftes van andere regimes, kijkt u op p. 348 (correctiefactoren)
NEDERLAND. Prijzen in euro (excl. BTW)

HOE P3/80 BESTELLEN

Leveringstermijn 15 - 30 werkdagen
(zonder transportduur)

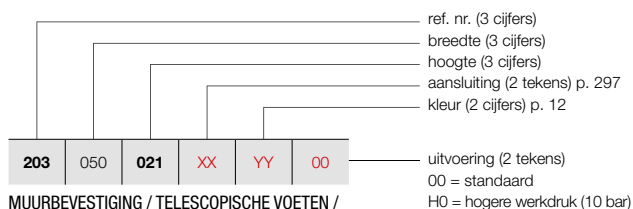

MUURBEVESTIGING / TELESCOPISCHE VOETEN /
KOLOMVOETEN

Zie p. 295 voor extra toebehoren.

PRIMULA P3 (P3/80)



P3

PRIJSGROEP: VPG3 - PLINTRADIATOREN

BESTELCODE MAATWERK P3	TECHNISCHE GEGEVENS											STANDAARDKLEUR	ANDERE KLEUREN			
	buizen	breedte (L mm)	hoogte (H mm)	75/65/20 (Watt) (Φ50K)	55/45/20 (Watt) (Φ30K)	n-exp.	gewicht (kg)	inhoud (l)	el. weerst. (Watt)	prijs RAL 9016 (€)	prijs kleur (€)					
REF. NR. P3/80 : 203																
203	050	021	XX	YY	00	-	500	210	378	190	1,35	8,40	2,25	-	495	569
203	060	021	XX	YY	00	-	600	210	454	228	1,35	10,08	2,70	-	524	603
203	070	021	XX	YY	00	-	700	210	529	265	1,35	11,76	3,15	-	551	634
203	080	021	XX	YY	00	-	800	210	605	304	1,35	13,44	3,60	-	577	664
203	090	021	XX	YY	00	-	900	210	680	341	1,35	15,12	4,05	-	603	693
203	100	021	XX	YY	00	-	1000	210	756	379	1,35	16,80	4,50	-	627	721
203	110	021	XX	YY	00	-	1100	210	832	417	1,35	18,48	4,95	-	654	752
203	120	021	XX	YY	00	-	1200	210	907	455	1,35	20,16	5,40	-	680	782
203	140	021	XX	YY	00	-	1400	210	1058	531	1,35	23,52	6,30	-	735	845
203	160	021	XX	YY	00	-	1600	210	1210	607	1,35	26,88	7,20	-	783	900
203	180	021	XX	YY	00	-	1800	210	1361	683	1,35	30,24	8,10	-	838	964
203	200	021	XX	YY	00	-	2000	210	1512	759	1,35	33,60	9,00	-	889	1022
203	220	021	XX	YY	00	-	2200	210	1663	834	1,35	36,96	9,90	-	941	1082
203	240	021	XX	YY	00	-	2400	210	1814	910	1,35	40,32	10,80	-	994	1143
203	260	021	XX	YY	00	-	2600	210	1966	986	1,35	43,68	11,70	-	1045	1202
203	280	021	XX	YY	00	-	2800	210	2117	1062	1,35	47,04	12,60	-	1096	1260
203	300	021	XX	YY	00	-	3000	210	2268	1138	1,35	50,40	13,50	-	1146	1318
203	330	021	XX	YY	00	-	3300	210	2495	1252	1,35	55,44	14,85	-	1225	1409
203	360	021	XX	YY	00	-	3600	210	2722	1366	1,35	60,48	16,20	-	1302	1497
203	390	021	XX	YY	00	-	3900	210	2948	1479	1,35	65,52	17,55	-	1381	1588

Conform EN442-1: 2014: radiatoren en convectoren

Voor meer details over onze artikel-data, zie artikel-database: <https://www.installdata.be>
Voor de warmteafgiftes van andere regimes, kijkt u op p. 348 (correctiefactoren)
NEDERLAND. Prijzen in euro (excl. BTW)

PRIMULA P3 (P3/130)



P3

HOE P3/130 BESTELLEN

Leveringstermijn 15 - 30 werkdagen
(zonder transportduur)

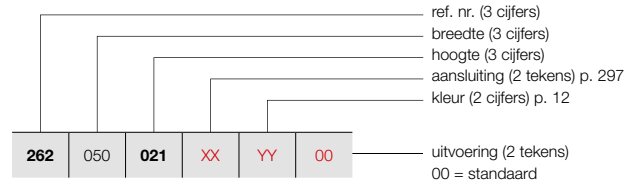

MUURBEVESTIGING / TELESCOPISCHE VOETEN /
KOLOMVOETEN

Zie p. 295 voor extra toebehoren.

PRIJSGROEP: VPG3 - PLINTRADIATOREN

BESTELCODE MAATWERK P3	TECHNISCHE GEGEVENS										STANDAARDKLEUR	ANDERE KLEUREN				
	buizen	breedte (L mm)	hoogte (H mm)	75/65/20 (Watt) (φ50K)	55/45/20 (Watt) (φ30K)	n-exp.	gewicht (kg)	inhoud (l)	el. weerst. (Watt)		prijs RAL 9016 (€)	prijs kleur (€)				
REF. NR. P3/130 : 262																
262	050	021	XX	YY	00	-	500	210	560	281	1,35	11,20	2,85	-	599	689
262	060	021	XX	YY	00	-	600	210	672	337	1,35	13,44	3,42	-	640	736
262	070	021	XX	YY	00	-	700	210	784	393	1,35	15,68	3,99	-	684	787
262	080	021	XX	YY	00	-	800	210	896	450	1,35	17,92	4,56	-	725	834
262	090	021	XX	YY	00	-	900	210	1008	506	1,35	20,16	5,13	-	767	882
262	100	021	XX	YY	00	-	1000	210	1120	562	1,35	22,40	5,70	-	808	929
262	110	021	XX	YY	00	-	1100	210	1232	618	1,35	24,64	6,27	-	850	978
262	120	021	XX	YY	00	-	1200	210	1344	674	1,35	26,88	6,84	-	893	1027
262	140	021	XX	YY	00	-	1400	210	1568	787	1,35	31,36	7,98	-	978	1125
262	160	021	XX	YY	00	-	1600	210	1792	899	1,35	35,84	9,12	-	1061	1220
262	180	021	XX	YY	00	-	1800	210	2016	1012	1,35	40,32	10,26	-	1145	1317
262	200	021	XX	YY	00	-	2000	210	2240	1124	1,35	44,80	11,40	-	1227	1411
262	220	021	XX	YY	00	-	2200	210	2464	1236	1,35	49,28	12,54	-	1317	1515
262	240	021	XX	YY	00	-	2400	210	2688	1349	1,35	53,76	13,68	-	1400	1610
262	260	021	XX	YY	00	-	2600	210	2912	1461	1,35	58,24	14,82	-	1482	1704
262	280	021	XX	YY	00	-	2800	210	3136	1574	1,35	62,72	15,96	-	1568	1803
262	300	021	XX	YY	00	-	3000	210	3360	1686	1,35	67,20	17,10	-	1652	1900
262	330	021	XX	YY	00	-	3300	210	3696	1855	1,35	73,92	18,81	-	1778	2045
262	360	021	XX	YY	00	-	3600	210	4032	2023	1,35	80,64	20,52	-	1904	2190
262	390	021	XX	YY	00	-	3900	210	4368	2192	1,35	87,36	22,23	-	2029	2333

Conform EN442-1: 2014: radiatoren en convectoren

Voor meer details over onze artikel-data, zie artikel-database: <https://www.installdata.be>

Voor de warmteafgiftes van andere regimes, kijkt u op p. 348 (correctiefactoren)
NEDERLAND. Prijzen in euro (excl. BTW)

HOE P3/180 BESTELLEN

Leveringstermijn 15 - 30 werkdagen
(zonder transportduur)

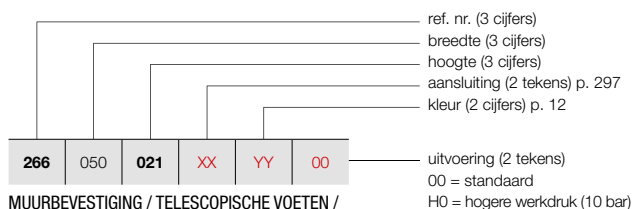

MUURBEVESTIGING / TELESCOPISCHE VOETEN / KOLOMVOETEN

Zie p. 295 voor extra toebehoren.

PRIMULA P3 (P3/180)



P3

PRIJSGROEP: VPG3 - PLINTRADIATOREN

BESTELCODE MAATWERK P3	TECHNISCHE GEGEVENS											STANDAARDKLEUR	ANDERE KLEUREN			
	buizen	breedte (L mm)	hoogte (H mm)	75/65/20 (Watt) (Φ50K)	55/45/20 (Watt) (Φ30K)	n-exp.	gewicht (kg)	inhoud (l)	el. weerst. (Watt)	prijs RAL 9016 (€)	prijs kleur (€)					
REF. NR. P3/180 : 266																
266	050	021	XX	YY	00	-	500	210	771	381	1,38	14,10	3,40	-	769	884
266	060	021	XX	YY	00	-	600	210	925	457	1,38	16,92	4,08	-	832	957
266	070	021	XX	YY	00	-	700	210	1079	533	1,38	19,74	4,76	-	888	1021
266	080	021	XX	YY	00	-	800	210	1233	609	1,38	22,56	5,44	-	948	1090
266	090	021	XX	YY	00	-	900	210	1387	685	1,38	25,38	6,12	-	1005	1156
266	100	021	XX	YY	00	-	1000	210	1541	761	1,38	28,20	6,80	-	1066	1226
266	110	021	XX	YY	00	-	1100	210	1695	838	1,38	31,02	7,48	-	1128	1297
266	120	021	XX	YY	00	-	1200	210	1849	914	1,38	33,84	8,16	-	1185	1363
266	140	021	XX	YY	00	-	1400	210	2157	1066	1,38	39,48	9,52	-	1305	1501
266	160	021	XX	YY	00	-	1600	210	2466	1219	1,38	45,12	10,88	-	1427	1641
266	180	021	XX	YY	00	-	1800	210	2774	1371	1,38	50,76	12,24	-	1543	1774
266	200	021	XX	YY	00	-	2000	210	3082	1523	1,38	56,40	13,60	-	1663	1912
266	220	021	XX	YY	00	-	2200	210	3390	1675	1,38	62,04	14,96	-	1782	2049
266	240	021	XX	YY	00	-	2400	210	3698	1827	1,38	67,68	16,32	-	1903	2188
266	260	021	XX	YY	00	-	2600	210	4007	1980	1,38	73,32	17,68	-	2021	2324
266	280	021	XX	YY	00	-	2800	210	4315	2132	1,38	78,96	19,04	-	2142	2463
266	300	021	XX	YY	00	-	3000	210	4623	2284	1,38	84,60	20,40	-	2262	2601
266	330	021	XX	YY	00	-	3300	210	5085	2513	1,38	93,06	22,44	-	2439	2805
266	360	021	XX	YY	00	-	3600	210	5548	2741	1,38	101,52	24,48	-	2620	3013
266	390	021	XX	YY	00	-	3900	210	6010	2970	1,38	109,98	26,52	-	2796	3215

Conform EN442-1: 2014: radiatoren en convectoren

Voor meer details over onze artikel-data, zie artikel-database: <https://www.installdata.be>
Voor de warmteafgiftes van andere regimes, kijkt u op p. 348 (correctiefactoren)
NEDERLAND. Prijzen in euro (excl. BTW)

PRIMULA P3 (P3/230)



P3

HOE P3/230 BESTELLEN

Leveringstermijn 15 - 30 werkdagen
(zonder transportduur)

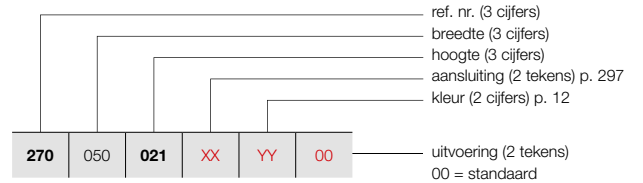

MUURBEVESTIGING / TELESCOPISCHE VOETEN /
KOLOMVOETEN

Zie p. 295 voor extra toebehoren.

PRIJSGROEP: VPG3 - PLINTRADIATOREN

BESTELCODE MAATWERK P3	TECHNISCHE GEGEVENS										STANDAARDKLEUR	ANDERE KLEUREN
	buizen	breedte (L mm)	hoogte (H mm)	75/65/20 (Watt) (φ50K)	55/45/20 (Watt) (φ30K)	n-exp.	gewicht (kg)	inhoud (l)	el. weerst. (Watt)		prijs RAL 9016 (€)	prijs kleur (€)
REF. NR. P3/230 : 270												
270 050 021 XX YY 00	-	500	210	950	472	1,37	16,85	4,25	-		940	1081
270 060 021 XX YY 00	-	600	210	1140	566	1,37	20,22	5,10	-		1017	1170
270 070 021 XX YY 00	-	700	210	1330	661	1,37	23,59	5,95	-		1095	1259
270 080 021 XX YY 00	-	800	210	1520	755	1,37	26,96	6,80	-		1175	1351
270 090 021 XX YY 00	-	900	210	1710	849	1,37	30,33	7,65	-		1253	1441
270 100 021 XX YY 00	-	1000	210	1900	944	1,37	33,70	8,50	-		1329	1528
270 110 021 XX YY 00	-	1100	210	2090	1038	1,37	37,07	9,35	-		1408	1619
270 120 021 XX YY 00	-	1200	210	2280	1132	1,37	40,44	10,20	-		1486	1709
270 140 021 XX YY 00	-	1400	210	2660	1321	1,37	47,18	11,90	-		1644	1891
270 160 021 XX YY 00	-	1600	210	3040	1510	1,37	53,92	13,60	-		1797	2067
270 180 021 XX YY 00	-	1800	210	3420	1699	1,37	60,66	15,30	-		1953	2246
270 200 021 XX YY 00	-	2000	210	3800	1887	1,37	67,40	17,00	-		2110	2427
270 220 021 XX YY 00	-	2200	210	4180	2076	1,37	74,14	18,70	-		2267	2607
270 240 021 XX YY 00	-	2400	210	4560	2265	1,37	80,88	20,40	-		2422	2785
270 260 021 XX YY 00	-	2600	210	4940	2454	1,37	87,62	22,10	-		2579	2966
270 280 021 XX YY 00	-	2800	210	5320	2642	1,37	94,36	23,80	-		2736	3146
270 300 021 XX YY 00	-	3000	210	5700	2831	1,37	101,10	25,50	-		2893	3327
270 330 021 XX YY 00	-	3300	210	6270	3114	1,37	111,21	28,05	-		3127	3596
270 360 021 XX YY 00	-	3600	210	6840	3397	1,37	121,32	30,60	-		3360	3864
270 390 021 XX YY 00	-	3900	210	7410	3680	1,37	131,43	33,15	-		3593	4132

Conform EN442-1: 2014: radiatoren en convectoren

Voor meer details over onze artikel-data, zie artikel-database: <https://www.installdata.be>

Voor de warmteafgifte van andere regimes, kijkt u op p. 348 (correctiefactoren)
NEDERLAND. Prijzen in euro (excl. BTW)

HOE P3/280 BESTELLEN

Leveringstermijn 15 - 30 werkdagen
(zonder transportduur)

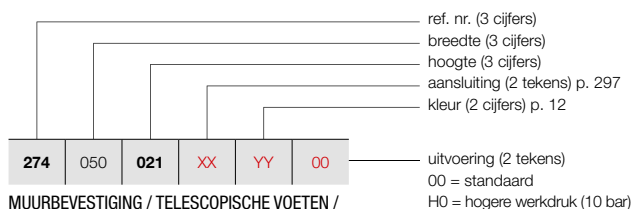

MUURBEVESTIGING / TELESCOPISCHE VOETEN /
KOLOMVOETEN

Zie p. 295 voor extra toebehoren.

PRIMULA P3 (P3/280)



P3

PRIJSGROEP: VPG3 - PLINTRADIATOREN

BESTELCODE MAATWERK P3	TECHNISCHE GEGEVENS											STANDAARDKLEUR	ANDERE KLEUREN			
	buizen	breedte (L mm)	hoogte (H mm)	75/65/20 (Watt) (Φ50K)	55/45/20 (Watt) (Φ30K)	n-exp.	gewicht (kg)	inhoud (l)	el. weerst. (Watt)	prijs RAL 9016 (€)	prijs kleur (€)					
REF. NR. P3/280 : 274																
274	050	021	XX	YY	00	-	500	210	1176	581	1,38	19,70	4,55	-	1117	1285
274	060	021	XX	YY	00	-	600	210	1411	697	1,38	23,64	5,46	-	1209	1390
274	070	021	XX	YY	00	-	700	210	1646	813	1,38	27,58	6,37	-	1299	1494
274	080	021	XX	YY	00	-	800	210	1881	929	1,38	31,52	7,28	-	1391	1600
274	090	021	XX	YY	00	-	900	210	2116	1046	1,38	35,46	8,19	-	1484	1707
274	100	021	XX	YY	00	-	1000	210	2351	1162	1,38	39,40	9,10	-	1577	1814
274	110	021	XX	YY	00	-	1100	210	2586	1278	1,38	43,34	10,01	-	1669	1919
274	120	021	XX	YY	00	-	1200	210	2821	1394	1,38	47,28	10,92	-	1761	2025
274	140	021	XX	YY	00	-	1400	210	3291	1626	1,38	55,16	12,74	-	1947	2239
274	160	021	XX	YY	00	-	1600	210	3762	1859	1,38	63,04	14,56	-	2133	2453
274	180	021	XX	YY	00	-	1800	210	4232	2091	1,38	70,92	16,38	-	2317	2665
274	200	021	XX	YY	00	-	2000	210	4702	2323	1,38	78,80	18,20	-	2503	2878
274	220	021	XX	YY	00	-	2200	210	5172	2556	1,38	86,68	20,02	-	2688	3091
274	240	021	XX	YY	00	-	2400	210	5642	2788	1,38	94,56	21,84	-	2874	3305
274	260	021	XX	YY	00	-	2600	210	6113	3021	1,38	102,44	23,66	-	3059	3518
274	280	021	XX	YY	00	-	2800	210	6583	3253	1,38	110,32	25,48	-	3243	3729
274	300	021	XX	YY	00	-	3000	210	7053	3485	1,38	118,20	27,30	-	3430	3945
274	330	021	XX	YY	00	-	3300	210	7758	3834	1,38	130,02	30,03	-	3705	4261
274	360	021	XX	YY	00	-	3600	210	8464	4182	1,38	141,84	32,76	-	3983	4580

Conform EN442-1: 2014: radiatoren en convectoren

Voor meer details over onze artikel-data, zie artikel-database: <https://www.installdata.be>
Voor de warmteafgiftes van andere regimes, kijkt u op p. 348 (correctiefactoren)
NETERLAND. Prijzen in euro (excl. BTW)

PRIMULA P4 (P4/80)



P4

HOE P4/80 BESTELLEN

Leveringstermijn 15 - 30 werkdagen
(zonder transportduur)

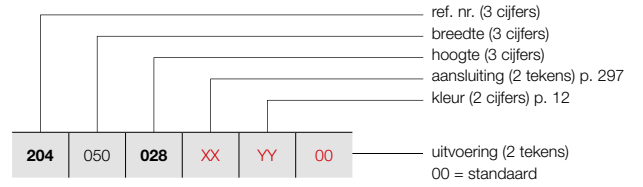

MUURBEVESTIGING / TELESCOPISCHE VOETEN /
KOLOMVOETEN

Zie p. 295 voor extra toebehoren.

PRIJSGROEP: VPG3 - PLINTRADIATOREN

BESTELCODE MAATWERK P4	TECHNISCHE GEGEVENS										STANDAARDKLEUR	ANDERE KLEUREN				
	buizen	breedte (L mm)	hoogte (H mm)	75/65/20 (Watt) (φ50K)	55/45/20 (Watt) (φ30K)	n-exp.	gewicht (kg)	inhoud (l)	el. weerst. (Watt)		prijs RAL 9016 (€)	prijs kleur (€)				
REF. NR. P4/80 : 204																
204	050	028	XX	YY	00	-	500	280	435	219	1,34	11,07	3,05	-	629	723
204	060	028	XX	YY	00	-	600	280	522	263	1,34	13,28	3,65	-	665	765
204	070	028	XX	YY	00	-	700	280	609	307	1,34	15,50	4,26	-	699	804
204	080	028	XX	YY	00	-	800	280	696	351	1,34	17,71	4,87	-	738	849
204	090	028	XX	YY	00	-	900	280	783	395	1,34	19,93	5,48	-	770	886
204	100	028	XX	YY	00	-	1000	280	870	439	1,34	22,14	6,09	-	805	926
204	110	028	XX	YY	00	-	1100	280	957	483	1,34	24,35	6,70	-	840	966
204	120	028	XX	YY	00	-	1200	280	1044	527	1,34	26,57	7,31	-	876	1007
204	140	028	XX	YY	00	-	1400	280	1218	614	1,34	31,00	8,53	-	947	1089
204	160	028	XX	YY	00	-	1600	280	1392	702	1,34	35,42	9,74	-	1015	1167
204	180	028	XX	YY	00	-	1800	280	1566	790	1,34	39,85	10,96	-	1084	1247
204	200	028	XX	YY	00	-	2000	280	1740	878	1,34	44,28	12,18	-	1152	1325
204	220	028	XX	YY	00	-	2200	280	1914	965	1,34	48,71	13,40	-	1224	1408
204	240	028	XX	YY	00	-	2400	280	2088	1053	1,34	53,14	14,62	-	1295	1489
204	260	028	XX	YY	00	-	2600	280	2262	1141	1,34	57,56	15,83	-	1365	1570
204	280	028	XX	YY	00	-	2800	280	2436	1229	1,34	61,99	17,05	-	1433	1648
204	300	028	XX	YY	00	-	3000	280	2610	1316	1,34	66,42	18,27	-	1506	1732
204	330	028	XX	YY	00	-	3300	280	2871	1448	1,34	73,06	20,10	-	1610	1852
204	360	028	XX	YY	00	-	3600	280	3132	1580	1,34	79,70	21,92	-	1716	1973
204	390	028	XX	YY	00	-	3900	280	3393	1711	1,34	86,35	23,75	-	1820	2093

Conform EN442-1: 2014: radiatoren en convectoren

Voor meer details over onze artikel-data, zie artikel-database: <https://www.installdata.be>

Voor de warmteafgiftes van andere regimes, kijkt u op p. 348 (correctiefactoren)
NEDERLAND. Prijzen in euro (excl. BTW)

HOE P4/130 BESTELLEN

Leveringstermijn 15 - 30 werkdagen
(zonder transportduur)

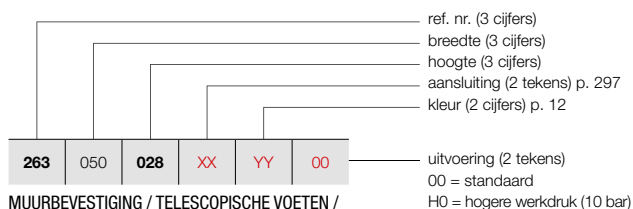

MUURBEVESTIGING / TELESCOPISCHE VOETEN / KOLOMVOETEN

Zie p. 295 voor extra toebehoren.

PRIMULA P4 (P4/130)



P4

PRIJSGROEP: VPG3 - PLINTRADIATOREN

BESTELCODE MAATWERK P4	TECHNISCHE GEGEVENS											STANDAARDKLEUR	ANDERE KLEUREN			
	buizen	breedte (L mm)	hoogte (H mm)	75/65/20 (Watt) (Φ50K)	55/45/20 (Watt) (Φ30K)	n-exp.	gewicht (kg)	inhoud (l)	el. weerst. (Watt)	prijs RAL 9016 (€)	prijs kleur (€)					
REF. NR. P4/130 : 263																
263	050	028	XX	YY	00	-	500	280	678	333	1,39	14,64	3,84	-	701	806
263	060	028	XX	YY	00	-	600	280	813	400	1,39	17,57	4,61	-	758	872
263	070	028	XX	YY	00	-	700	280	949	467	1,39	20,50	5,38	-	813	935
263	080	028	XX	YY	00	-	800	280	1084	533	1,39	23,42	6,14	-	863	992
263	090	028	XX	YY	00	-	900	280	1220	600	1,39	26,35	6,91	-	919	1057
263	100	028	XX	YY	00	-	1000	280	1355	666	1,39	29,28	7,68	-	974	1120
263	110	028	XX	YY	00	-	1100	280	1491	733	1,39	32,21	8,45	-	1030	1185
263	120	028	XX	YY	00	-	1200	280	1626	799	1,39	35,14	9,22	-	1083	1245
263	140	028	XX	YY	00	-	1400	280	1897	933	1,39	40,99	10,75	-	1191	1370
263	160	028	XX	YY	00	-	1600	280	2168	1066	1,39	46,85	12,29	-	1299	1494
263	180	028	XX	YY	00	-	1800	280	2439	1199	1,39	52,70	13,82	-	1408	1619
263	200	028	XX	YY	00	-	2000	280	2710	1332	1,39	58,56	15,36	-	1515	1742
263	220	028	XX	YY	00	-	2200	280	2981	1466	1,39	64,42	16,90	-	1624	1868
263	240	028	XX	YY	00	-	2400	280	3252	1599	1,39	70,27	18,43	-	1734	1994
263	260	028	XX	YY	00	-	2600	280	3523	1732	1,39	76,13	19,97	-	1842	2118
263	280	028	XX	YY	00	-	2800	280	3794	1865	1,39	81,98	21,50	-	1949	2241
263	300	028	XX	YY	00	-	3000	280	4065	1998	1,39	87,84	23,04	-	2058	2367
263	330	028	XX	YY	00	-	3300	280	4472	2199	1,39	96,62	25,34	-	2222	2555
263	360	028	XX	YY	00	-	3600	280	4878	2398	1,39	105,41	27,65	-	2386	2744
263	390	028	XX	YY	00	-	3900	280	5285	2598	1,39	114,19	29,95	-	2546	2928

Conform EN442-1: 2014: radiatoren en convectoren

Voor meer details over onze artikel-data, zie artikel-database: <https://www.installdata.be>
Voor de warmteafgiftes van andere regimes, kijkt u op p. 348 (correctiefactoren)
NEDERLAND. Prijzen in euro (excl. BTW)

PRIMULA P4 (P4/180)



P4

HOE P4/180 BESTELLEN

Leveringstermijn 15 - 30 werkdagen
(zonder transportduur)

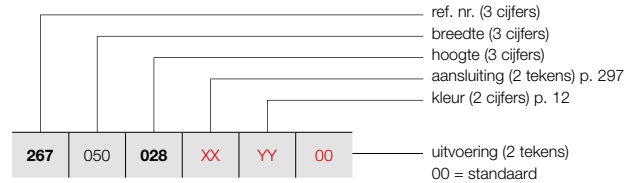

MUURBEVESTIGING / TELESCOPISCHE VOETEN /
KOLOMVOETEN

Zie p. 295 voor extra toebehoren.

PRIJSGROEP: VPG3 - PLINTRADIATOREN

BESTELCODE MAATWERK P4	TECHNISCHE GEGEVENS										STANDAARDKLEUR	ANDERE KLEUREN				
	buizen	breedte (L mm)	hoogte (H mm)	75/65/20 (Watt) (φ50K)	55/45/20 (Watt) (φ30K)	n-exp.	gewicht (kg)	inhoud (l)	el. weerst. (Watt)		prijs RAL 9016 (€)	prijs kleur (€)				
REF. NR. P4/180 : 267																
267	050	028	XX	YY	00	-	500	280	919	449	1,40	18,30	4,58	-	905	1041
267	060	028	XX	YY	00	-	600	280	1103	539	1,40	21,96	5,49	-	984	1132
267	070	028	XX	YY	00	-	700	280	1287	629	1,40	25,62	6,41	-	1056	1214
267	080	028	XX	YY	00	-	800	280	1470	719	1,40	29,28	7,32	-	1134	1304
267	090	028	XX	YY	00	-	900	280	1654	809	1,40	32,94	8,24	-	1211	1393
267	100	028	XX	YY	00	-	1000	280	1838	899	1,40	36,60	9,15	-	1283	1475
267	110	028	XX	YY	00	-	1100	280	2022	989	1,40	40,26	10,07	-	1362	1566
267	120	028	XX	YY	00	-	1200	280	2206	1079	1,40	43,92	10,98	-	1437	1653
267	140	028	XX	YY	00	-	1400	280	2573	1258	1,40	51,24	12,81	-	1589	1827
267	160	028	XX	YY	00	-	1600	280	2941	1438	1,40	58,56	14,64	-	1740	2001
267	180	028	XX	YY	00	-	1800	280	3308	1618	1,40	65,88	16,47	-	1891	2175
267	200	028	XX	YY	00	-	2000	280	3676	1798	1,40	73,20	18,30	-	2046	2353
267	220	028	XX	YY	00	-	2200	280	4044	1978	1,40	80,52	20,13	-	2197	2527
267	240	028	XX	YY	00	-	2400	280	4411	2157	1,40	87,84	21,96	-	2349	2701
267	260	028	XX	YY	00	-	2600	280	4779	2337	1,40	95,16	23,79	-	2500	2875
267	280	028	XX	YY	00	-	2800	280	5146	2517	1,40	102,48	25,62	-	2652	3050
267	300	028	XX	YY	00	-	3000	280	5514	2697	1,40	109,80	27,45	-	2802	3222
267	330	028	XX	YY	00	-	3300	280	6065	2966	1,40	120,78	30,20	-	3030	3485
267	360	028	XX	YY	00	-	3600	280	6617	3236	1,40	131,76	32,94	-	3259	3748
267	390	028	XX	YY	00	-	3900	280	7168	3506	1,40	142,74	35,69	-	3486	4009

Conform EN442-1: 2014: radiatoren en convectoren

Voor meer details over onze artikel-data, zie artikel-database: <https://www.installdata.be>

Voor de warmteafgiftes van andere regimes, kijkt u op p. 348 (correctiefactoren)
NEDERLAND. Prijzen in euro (excl. BTW)

HOE P4/230 BESTELLEN

Leveringstermijn 15 - 30 werkdagen
(zonder transportduur)

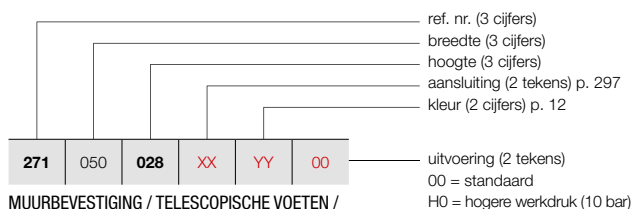

MUURBEVESTIGING / TELESCOPISCHE VOETEN /
KOLOMVOETEN

Zie p. 295 voor extra toebehoren.

PRIMULA P4 (P4/230)



P4

PRIJSGROEP: VPG3 - PLINTRADIATOREN

BESTELCODE MAATWERK P4	TECHNISCHE GEGEVENS											STANDAARDKLEUR	ANDERE KLEUREN			
	buizen	breedte (L mm)	hoogte (H mm)	75/65/20 (Watt) (Φ50K)	55/45/20 (Watt) (Φ30K)	n-exp.	gewicht (kg)	inhoud (l)	el. weerst. (Watt)			prijs RAL 9016 (€)	prijs kleur (€)			
REF. NR. P4/230 : 271																
271	050	028	XX	YY	00	-	500	280	1129	552	1,40	21,83	5,78	-	1133	1303
271	060	028	XX	YY	00	-	600	280	1355	663	1,40	26,19	6,93	-	1229	1413
271	070	028	XX	YY	00	-	700	280	1581	773	1,40	30,56	8,09	-	1333	1533
271	080	028	XX	YY	00	-	800	280	1806	883	1,40	34,92	9,24	-	1434	1649
271	090	028	XX	YY	00	-	900	280	2032	994	1,40	39,29	10,40	-	1538	1769
271	100	028	XX	YY	00	-	1000	280	2258	1104	1,40	43,65	11,55	-	1637	1883
271	110	028	XX	YY	00	-	1100	280	2484	1215	1,40	48,02	12,71	-	1740	2001
271	120	028	XX	YY	00	-	1200	280	2710	1326	1,40	52,38	13,86	-	1842	2118
271	140	028	XX	YY	00	-	1400	280	3161	1546	1,40	61,11	16,17	-	2046	2353
271	160	028	XX	YY	00	-	1600	280	3613	1767	1,40	69,84	18,48	-	2250	2588
271	180	028	XX	YY	00	-	1800	280	4064	1988	1,40	78,57	20,79	-	2453	2821
271	200	028	XX	YY	00	-	2000	280	4516	2209	1,40	87,30	23,10	-	2654	3052
271	220	028	XX	YY	00	-	2200	280	4968	2430	1,40	96,03	25,41	-	2857	3286
271	240	028	XX	YY	00	-	2400	280	5419	2651	1,40	104,76	27,72	-	3059	3518
271	260	028	XX	YY	00	-	2600	280	5871	2872	1,40	113,49	30,03	-	3264	3754
271	280	028	XX	YY	00	-	2800	280	6322	3092	1,40	122,22	32,34	-	3465	3985
271	300	028	XX	YY	00	-	3000	280	6774	3313	1,40	130,95	34,65	-	3670	4221
271	330	028	XX	YY	00	-	3300	280	7451	3644	1,40	144,05	38,12	-	3972	4568

Conform EN442-1: 2014: radiatoren en convectoren

Voor meer details over onze artikel-data, zie artikel-database: <https://www.installdata.be>
Voor de warmteafgiftes van andere regimes, kijkt u op p. 348 (correctiefactoren)
NEDERLAND. Prijzen in euro (excl. BTW)

PRIMULA P4 (P4/280)



P4

HOE P4/280 BESTELLEN

Leveringstermijn 15 - 30 werkdagen
(zonder transportduur)

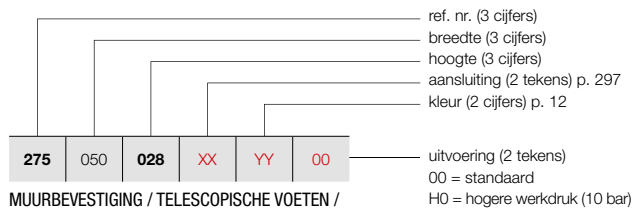

MUURBEVESTIGING / TELESCOPISCHE VOETEN /
KOLOMVOETEN

Zie p. 295 voor extra toebehoren.

PRIJSGROEP: VPG3 - PLINTRADIATOREN

BESTELCODE MAATWERK P4	TECHNISCHE GEGEVENS										STANDAARDKLEUR	ANDERE KLEUREN				
	buizen	breedte (L mm)	hoogte (H mm)	75/65/20 (Watt) (φ50K)	55/45/20 (Watt) (φ30K)	n-exp.	gewicht (kg)	inhoud (l)	el. weerst. (Watt)		prijs RAL 9016 (€)	prijs kleur (€)				
REF. NR. P4/280 : 275																
275	050	028	XX	YY	00	-	500	280	1335	653	1,40	25,55	6,13	-	1365	1570
275	060	028	XX	YY	00	-	600	280	1602	784	1,40	30,66	7,35	-	1488	1711
275	070	028	XX	YY	00	-	700	280	1869	914	1,40	35,77	8,58	-	1610	1852
275	080	028	XX	YY	00	-	800	280	2136	1045	1,40	40,88	9,80	-	1734	1994
275	090	028	XX	YY	00	-	900	280	2403	1175	1,40	45,99	11,03	-	1853	2131
275	100	028	XX	YY	00	-	1000	280	2670	1306	1,40	51,10	12,25	-	1979	2276
275	110	028	XX	YY	00	-	1100	280	2937	1437	1,40	56,21	13,48	-	2098	2413
275	120	028	XX	YY	00	-	1200	280	3204	1567	1,40	61,32	14,70	-	2222	2555
275	140	028	XX	YY	00	-	1400	280	3738	1828	1,40	71,54	17,15	-	2466	2836
275	160	028	XX	YY	00	-	1600	280	4272	2090	1,40	81,76	19,60	-	2711	3118
275	180	028	XX	YY	00	-	1800	280	4806	2351	1,40	91,98	22,05	-	2956	3399
275	200	028	XX	YY	00	-	2000	280	5340	2612	1,40	102,20	24,50	-	3201	3681
275	220	028	XX	YY	00	-	2200	280	5874	2873	1,40	112,42	26,95	-	3446	3963
275	240	028	XX	YY	00	-	2400	280	6408	3134	1,40	122,64	29,40	-	3690	4244
275	260	028	XX	YY	00	-	2600	280	6942	3395	1,40	132,86	31,85	-	3934	4524
275	280	028	XX	YY	00	-	2800	280	7476	3657	1,40	143,08	34,30	-	4182	4809

Conform EN442-1: 2014: radiatoren en convectoren

Voor meer details over onze artikel-data, zie artikel-database: <https://www.installdata.be>
Voor de warmteafgiftes van andere regimes, kijkt u op p. 348 (correctiefactoren)
NETERLAND. Prijzen in euro (excl. BTW)

PRIJSGROEP: VPG10 - ACC.

LENGTE IN MM NOODZAKELIJK AANTAL STUKS PER PLINT	ART. NR. P/80	ART. NR. P/130	ART. NR. P/180	ART. NR. P/230	ART. NR. P/280	KLEUR	€
--	------------------	-------------------	-------------------	-------------------	-------------------	-------	---

MUURBEVESTIGING*



500 - 1800: 2	1186 012 0000 9016	1186 022 0000 9016	1186 032 0000 9016	1186 042 0000 9016	1186 052 0000 9016	RAL 9016	30
	1186 012 0000 XXXX	1186 022 0000 XXXX	1186 032 0000 XXXX	1186 042 0000 XXXX	1186 052 0000 XXXX	KLEUR	34
2000 - 2400: 3	1186 013 0000 9016	1186 023 0000 9016	1186 033 0000 9016	1186 043 0000 9016	1186 053 0000 9016	RAL 9016	45
	1186 013 0000 XXXX	1186 023 0000 XXXX	1186 033 0000 XXXX	1186 043 0000 XXXX	1186 053 0000 XXXX	KLEUR	51
2600 - 3600: 4	1186 014 0000 9016	1186 024 0000 9016	1186 034 0000 9016	1186 044 0000 9016	1186 054 0000 9016	RAL 9016	60
	1186 014 0000 XXXX	1186 024 0000 XXXX	1186 034 0000 XXXX	1186 044 0000 XXXX	1186 054 0000 XXXX	KLEUR	68
3900: 5	1186 015 0000 9016	1186 025 0000 9016	1186 035 0000 9016	1186 045 0000 9016	1186 055 0000 9016	RAL 9016	75
	1186 015 0000 XXXX	1186 025 0000 XXXX	1186 035 0000 XXXX	1186 045 0000 XXXX	1186 055 0000 XXXX	KLEUR	85

Bij bestelling steeds het plinttype (80-130-180-230-280) en de kleur opgeven. Bij de muurbevestigingen zijn de volgende maximumbreedtes mogelijk:
bij P3: diepte = 180 mm, bij P4: diepte = 130 mm.

* noodzakelijk aantal stuks per plint:

in mm	P1					P2					P3			P4	
	80	130	180	230	280	80	130	180	230	280	80	130	180	80	130
tot 1800 mm	2	3	3	4	4	2	3	3	4	5	2	3	3	2	3
1900 - 2400 mm	2	3	3	4	4	2	3	3	4	6	2	3	3	3	3
2500 - 3600 mm	3	3	3	4	5	3	3	4	5	6	3	3	4	3	4
3700 - 3900 mm	3	3	3	4	5	3	3	4	5	6	3	4	4	3	4

NEDERLAND. Prijzen in euro (excl. BTW)

PRIMULA VRIJSTAANDE OPSTELLING
IN OPTIE

PRIJSGROEP: VPG10 - ACC.

LENGTE IN MM NOODZAKELIJK AANTAL STUKS PER PLINT	ART. NR. P/80	ART. NR. P/130	ART. NR. P/180	ART. NR. P/230	ART. NR. P/280	KLEUR	€
--	------------------	-------------------	-------------------	-------------------	-------------------	-------	---



TELESCOPISCHE VOETEN

500 - 1800: 2	1186 112 0000 9016	1186 122 0000 9016	1186 132 0000 9016	1186 142 0000 9016	1186 152 0000 9016	RAL 9016	46
	1186 112 0000 XXXX	1186 122 0000 XXXX	1186 132 0000 XXXX	1186 142 0000 XXXX	1186 152 0000 XXXX	KLEUR	52
2000 - 2400: 3	1186 113 0000 9016	1186 123 0000 9016	1186 133 0000 9016	1186 143 0000 9016	1186 153 0000 9016	RAL 9016	69
	1186 113 0000 XXXX	1186 123 0000 XXXX	1186 133 0000 XXXX	1186 143 0000 XXXX	1186 153 0000 XXXX	KLEUR	78
2600 - 3600: 4	1186 114 0000 9016	1186 124 0000 9016	1186 134 0000 9016	1186 144 0000 9016	1186 154 0000 9016	RAL 9016	92
	1186 114 0000 XXXX	1186 124 0000 XXXX	1186 134 0000 XXXX	1186 144 0000 XXXX	1186 154 0000 XXXX	KLEUR	104
3900: 5	1186 115 0000 9016	1186 125 0000 9016	1186 135 0000 9016	1186 145 0000 9016	1186 155 0000 9016	RAL 9016	115
	1186 115 0000 XXXX	1186 125 0000 XXXX	1186 135 0000 XXXX	1186 145 0000 XXXX	1186 155 0000 XXXX	KLEUR	130

Bij bestelling van standconsoles het plinttype opgeven (80-130-180-230-280) en de kleur. Deze voeten worden standaard geleverd met roset. Max. hoogte voetjes: 265 mm. Min. hoogte voetjes: 205 mm. Het bovendeele van het voetje bestaat uit een rechthoekige buis van 40/25 mm, het onderste uit een rechthoekige buis van 35/20 mm.

NEDERLAND. Prijzen in euro (excl. BTW)

PRIJSGROEP: VPG10 - ACC.

LENGTE IN MM NOODZAKELIJK AANTAL STUKS PER PLINT	KLEUR	ART. NR. P/80	€	ART. NR. P/130	€	ART. NR. P/180	€	ART. NR. P/230	€	ART. NR. P/280	€
--	-------	------------------	---	-------------------	---	-------------------	---	-------------------	---	-------------------	---



KOLOMVOETEN

500 - 1800: 2	RAL 9016	1186 212 0000 9016	100	1186 222 0000 9016	102	1186 232 0000 9016	104	1186 242 0000 9016	106	1186 252 0000 9016	112
	KLEUR	1186 212 0000 XXXX	116	1186 222 0000 XXXX	118	1186 232 0000 XXXX	120	1186 242 0000 XXXX	122	1186 252 0000 XXXX	128
2000 - 2400: 3	RAL 9016	1186 213 0000 9016	150	1186 223 0000 9016	153	1186 233 0000 9016	156	1186 243 0000 9016	159	1186 253 0000 9016	168
	KLEUR	1186 213 0000 XXXX	174	1186 223 0000 XXXX	177	1186 233 0000 XXXX	180	1186 243 0000 XXXX	183	1186 253 0000 XXXX	192
2600 - 3600: 4	RAL 9016	1186 214 0000 9016	200	1186 224 0000 9016	204	1186 234 0000 9016	208	1186 244 0000 9016	212	1186 254 0000 9016	224
	KLEUR	1186 214 0000 XXXX	232	1186 224 0000 XXXX	236	1186 234 0000 XXXX	240	1186 244 0000 XXXX	244	1186 254 0000 XXXX	256
3900: 5	RAL 9016	1186 215 0000 9016	250	1186 225 0000 9016	255	1186 235 0000 9016	260	1186 245 0000 9016	265	1186 255 0000 9016	280
	KLEUR	1186 215 0000 XXXX	290	1186 225 0000 XXXX	295	1186 235 0000 XXXX	300	1186 245 0000 XXXX	305	1186 255 0000 XXXX	320

Voor de eventuele inbouwmontage van een thermostaatventiel. De standaardhoogte van de kolomvoeten is 150 mm. Aantal benodigde kolomvoeten = idem telescopische voetjes.

NEDERLAND. Prijzen in euro (excl. BTW)

PRIMULA: P1 / P2 / P3 / P4

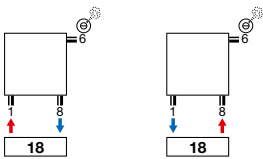

PRIMULA: P2 / P3 / P4

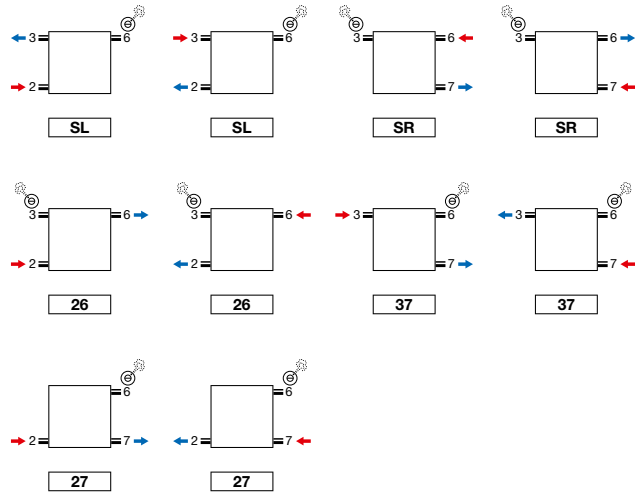

UNIVERSELE AANSLUITING

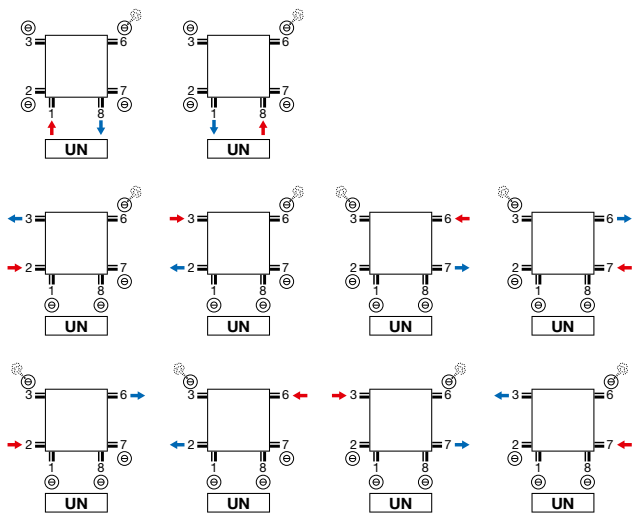

- P2, P3, P4 universele aansluiting 6 x ½ (1, 2, 3, 6, 7, 8)
- P1 universele aansluiting 4 x ½ (1, 3, 6, 8)

OPMERKING TWEEPIJPSSYSTEEM:

- niet mogelijk bij type P1: SL, SR

Opmerking: het aansluiten van de radiator kan enkel volgens de getoonde aansluiticonen. Voor elke andere aansluitwijze nemen wij geen verantwoordelijkheid.

PRIMULA (P1, P2, P3, P4)

Aansluiting 18 | Bovenaanzicht

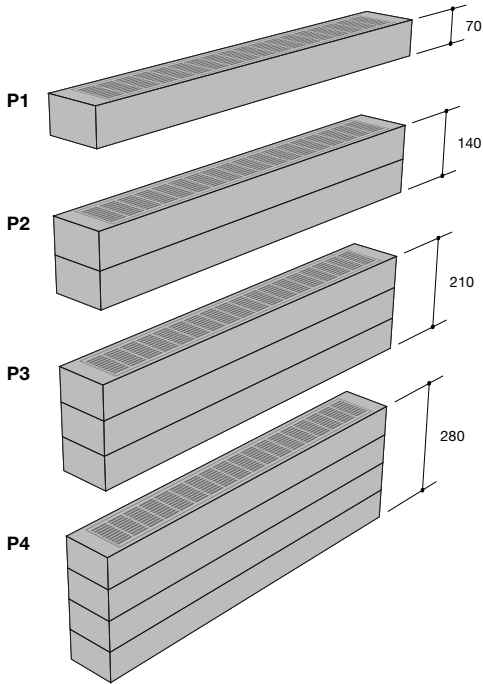
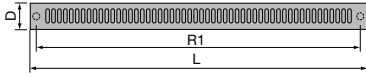

Universele aansluiting UN (standaard) | Zijaanzicht

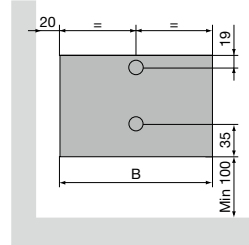

Aansluiting SL/SR | Zijaanzicht

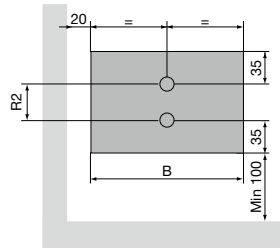

P1 / P2 / P3 / P4

Hartafstand tussen de onderaansluitingen 18 (R1)	Breedte (L) - 46
Hartafstand tussen de zijaansluitingen SL/SR (P2, P3, P4) (R2)	Hoogte (H) - 70
Afstand aansluiting tot de muur (S1)	20 + Diepte (D) / 2



VASCO