

Plintradiatoren



VASCO past zijn kritische kijk op comfort en design ook toe op zijn plintradiatoren.

Hier is alles toegespitst op **een zo hoog mogelijk rendement** en een zo fraai mogelijke vormgeving. De beste en elegantste manier om de ruimte onder grote raamoppervlakken te voorzien van een passende verwarmingsoplossing.

VASCO plintradiatoren zorgen voor een gelijkmatige warmteverdeling in de hele woonruimte, met **een minimum aan warmteverlies via het raam.**

Ze kunnen **zowel vrijstaand als via een bevestiging aan de muur** geïnstalleerd worden, in de passende hoogte, diepte en lengte al naargelang van de benodigde verwarmingscapaciteit.

Plintradiatoren

Primula

274



TYPES

- P1, P2, P3, P4

BUIZEN

- Horizontaal, rechthoekig 70 x 10 mm
- Tussen de rechthoekige buizen is een krachtige convectie-warmtewisselaar uit stalen precisiebuisen van Ø 12 x 1 mm en rechthoekige lamellen van 0,4 mm gelast.

COLLECTOREN

- 2 geïntegreerde stalen collectoren

KLEUREN

- Standaardkleur wit RAL 9016
- Uitgebreide kleurenkaart zie p. 12

SPECIAAL

- Type Primula wordt in 4 hoogtes (70, 140, 210 en 280 mm), in 5 dieptes (80, 130, 180, 230 en 280 mm) en in 20 lengtes (van 500 tot 3900 mm) geleverd.
- Een elegant afdekrooster wordt standaard meegeleverd.
- Muurbevestigingen, telescopische voetjes of kolomvoeten kunnen mits meerprijs meegeleverd worden (niet in de prijs inbegrepen).

BEVESTIGINGEN

- Apart te bestellen, niet in de prijs van de plint inbegrepen

TECHNISCH

- Elektrisch lasergelast (onzichtbare lasnaden)
- KTL-grondlaag, poedercoating
- Standaardwerkdruk: 4 bar
- Meerprijs voor hogere werkdruk (10 bar): + 10%.
- De leveringstermijn van radiator met een hogere werkdruk is 1 week extra.
- Maximale bedrijfstemperatuur: 110°C

ELEKTRISCH

- ✗ Zuiver elektrische radiator in de fabriek voorgevuld
- ✗ Gemengde radiator

TECHNISCHE TEKENINGEN

- Zie p. 298

AANSLUITING

- ✓ Eénpuntsaansluiting voor éénpijpssysteem (radiator speciaal te bestellen) **(op aanvraag)** (zie p. 341)
- ✓ Eénpuntsaansluiting voor tweepijpssysteem (radiator speciaal te bestellen) **(op aanvraag)** (zie p. 341)
- ✗ Tweepuntsaansluiting voor éénpijpssysteem
- ✓ Tweepuntsaansluiting voor tweepijpssysteem (standaard) (zie p. 340)
- ✗ Geïntegreerd ventiel
- Aansluitingen: ½" (binnendraad)

PRIMULA

Verwamingscomfort met ruimtegevoel

Een ruimte met grote raampartijen verwarmen, geheel in lijn met de interieurinrichting en de architectuur is een kolfje naar de hand van de Primula design plintradiator. De strakke, horizontale lijnvoering op lage hoogte draagt bij tot het gewenste ruimtegevoel en de hoge warmteafgifte, ook in de minimale uitvoering, maakt het eigentijds comfort compleet.

AANBEVOLEN AANSLUITING (18)

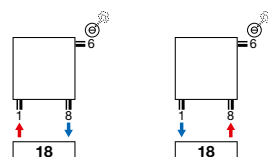

Andere aansluitmogelijkheden, zie p. 297



HOE P1/80 BESTELLEN

Leveringstermijn 15 - 30 werkdagen
(zonder transportduur)

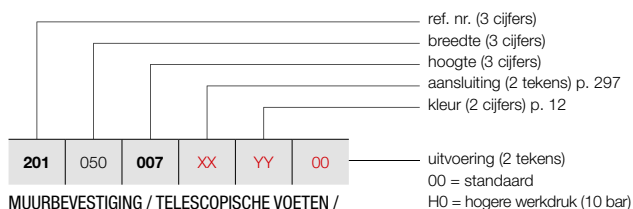

MUURBEVESTIGING / TELESCOPISCHE VOETEN / KOLOMVOETEN

Zie p. 295 voor extra toebehoren.

PRIMULA P1 (P1/80)



P1

PRIJSGROEP: VPG3 - PLINTRADIATOREN

BESTELCODE MAATWERK P1	TECHNISCHE GEGEVENS											STANDAARDKLEUR	ANDERE KLEUREN			
	buizen	breedte (L mm)	hoogte (H mm)	75/65/20 (Watt) (Φ50K)	55/45/20 (Watt) (Φ30K)	n-exp.	gewicht (kg)	inhoud (l)	el. weerst. (Watt)	prijs RAL 9016 (€)	prijs kleur (€)					
REF. NR. P1/80 : 201																
201	050	007	XX	YY	00	-	500	70	203	101	1,36	3,07	0,66	-	272	313
201	060	007	XX	YY	00	-	600	70	243	121	1,36	3,68	0,79	-	285	328
201	070	007	XX	YY	00	-	700	70	284	142	1,36	4,29	0,92	-	297	342
201	080	007	XX	YY	00	-	800	70	324	162	1,36	4,90	1,05	-	309	355
201	090	007	XX	YY	00	-	900	70	365	182	1,36	5,52	1,18	-	322	370
201	100	007	XX	YY	00	-	1000	70	405	202	1,36	6,13	1,31	-	332	382
201	110	007	XX	YY	00	-	1100	70	446	223	1,36	6,74	1,44	-	351	404
201	120	007	XX	YY	00	-	1200	70	486	243	1,36	7,36	1,57	-	362	416
201	140	007	XX	YY	00	-	1400	70	567	283	1,36	8,58	1,83	-	387	445
201	160	007	XX	YY	00	-	1600	70	648	323	1,36	9,81	2,10	-	409	470
201	180	007	XX	YY	00	-	1800	70	729	364	1,36	11,03	2,36	-	437	503
201	200	007	XX	YY	00	-	2000	70	810	404	1,36	12,26	2,62	-	463	532
201	220	007	XX	YY	00	-	2200	70	891	445	1,36	13,49	2,88	-	487	560
201	240	007	XX	YY	00	-	2400	70	972	485	1,36	14,71	3,14	-	514	591
201	260	007	XX	YY	00	-	2600	70	1053	526	1,36	15,94	3,41	-	538	619
201	280	007	XX	YY	00	-	2800	70	1134	566	1,36	17,16	3,67	-	564	649
201	300	007	XX	YY	00	-	3000	70	1215	607	1,36	18,39	3,93	-	591	680
201	330	007	XX	YY	00	-	3300	70	1337	667	1,36	20,23	4,32	-	626	720
201	360	007	XX	YY	00	-	3600	70	1458	728	1,36	22,07	4,72	-	666	766
201	390	007	XX	YY	00	-	3900	70	1580	789	1,36	23,91	5,11	-	704	810

Conform EN442-1: 2014: radiatoren en convectoren

Voor meer details over onze artikel-data, zie artikel-database: <https://www.installdata.be>
Voor de warmteafgiftes van andere regimes, kijkt u op p. 348 (correctiefactoren)
BELGIË. Prijzen in euro (excl. BTW)

PRIMULA P1 (P1/130)



P1

HOE P1/130 BESTELLEN

Leveringstermijn 15 - 30 werkdagen
(zonder transportduur)

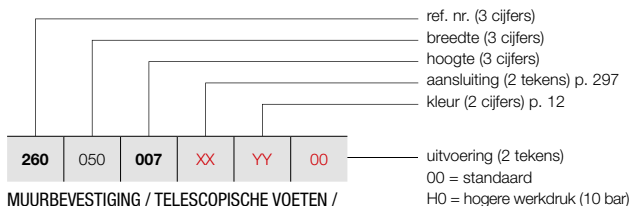

MUURBEVESTIGING / TELESCOPISCHE VOETEN /
KOLOMVOETEN

Zie p. 295 voor extra toebehoren.

PRIJSGROEP: VPG3 - PLINTRADIATOREN

BESTELCODE MAATWERK P1	TECHNISCHE GEGEVENS										STANDAARDKLEUR	ANDERE KLEUREN
	buizen	breedte (L mm)	hoogte (H mm)	75/65/20 (Watt) (φ50K)	55/45/20 (Watt) (φ30K)	n-exp.	gewicht (kg)	inhoud (l)	el. weerst. (Watt)		prijs RAL 9016 (€)	prijs kleur (€)
REF. NR. P1/130 : 260												
260 050 007 XX YY 00	-	500	70	312	156	1,36	4,33	0,88	-		363	417
260 060 007 XX YY 00	-	600	70	374	187	1,36	5,19	1,05	-		382	439
260 070 007 XX YY 00	-	700	70	437	218	1,36	6,06	1,23	-		403	463
260 080 007 XX YY 00	-	800	70	499	249	1,36	6,92	1,40	-		424	488
260 090 007 XX YY 00	-	900	70	562	281	1,36	7,79	1,58	-		441	507
260 100 007 XX YY 00	-	1000	70	624	312	1,36	8,65	1,75	-		463	532
260 110 007 XX YY 00	-	1100	70	686	342	1,36	9,52	1,93	-		481	553
260 120 007 XX YY 00	-	1200	70	749	374	1,36	10,38	2,10	-		507	583
260 140 007 XX YY 00	-	1400	70	874	436	1,36	12,11	2,45	-		541	622
260 160 007 XX YY 00	-	1600	70	998	498	1,36	13,84	2,80	-		584	672
260 180 007 XX YY 00	-	1800	70	1123	561	1,36	15,57	3,15	-		622	715
260 200 007 XX YY 00	-	2000	70	1248	623	1,36	17,30	3,50	-		663	762
260 220 007 XX YY 00	-	2200	70	1373	685	1,36	19,03	3,85	-		703	808
260 240 007 XX YY 00	-	2400	70	1498	748	1,36	20,76	4,20	-		743	854
260 260 007 XX YY 00	-	2600	70	1622	810	1,36	22,49	4,55	-		784	902
260 280 007 XX YY 00	-	2800	70	1747	872	1,36	24,22	4,90	-		824	948
260 300 007 XX YY 00	-	3000	70	1872	935	1,36	25,95	5,25	-		865	995
260 330 007 XX YY 00	-	3300	70	2059	1028	1,36	28,55	5,78	-		921	1059
260 360 007 XX YY 00	-	3600	70	2246	1121	1,36	31,14	6,30	-		985	1133
260 390 007 XX YY 00	-	3900	70	2434	1215	1,36	33,74	6,83	-		1044	1201

Conform EN442-1: 2014: radiatoren en convectoren

Voor meer details over onze artikel-data, zie artikel-database: <https://www.installdata.be>
Voor de warmteafgifte van andere regimes, kijkt u op p. 348 (correctiefactoren)
BELGIË. Prijzen in euro (excl. BTW)

HOE P1/180 BESTELLEN

Leveringstermijn 15 - 30 werkdagen
(zonder transportduur)

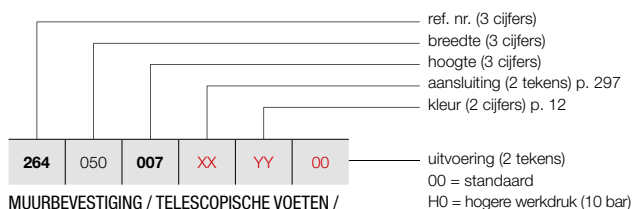

MUURBEVESTIGING / TELESCOPISCHE VOETEN /
KOLOMVOETEN

Zie p. 295 voor extra toebehoren.

PRIMULA P1 (P1/180)



P1

PRIJSGROEP: VPG3 - PLINTRADIATOREN

BESTELCODE MAATWERK P1	TECHNISCHE GEGEVENS											STANDAARDKLEUR	ANDERE KLEUREN			
	buizen	breedte (L mm)	hoogte (H mm)	75/65/20 (Watt) (Φ50K)	55/45/20 (Watt) (Φ30K)	n-exp.	gewicht (kg)	inhoud (l)	el. weerst. (Watt)	prijs RAL 9016 (€)	prijs kleur (€)					
REF. NR. P1/180 : 264																
264	050	007	XX	YY	00	-	500	70	422	212	1,35	5,70	1,05	-	480	552
264	060	007	XX	YY	00	-	600	70	506	254	1,35	6,84	1,26	-	514	591
264	070	007	XX	YY	00	-	700	70	590	296	1,35	7,98	1,47	-	544	626
264	080	007	XX	YY	00	-	800	70	674	338	1,35	9,12	1,68	-	575	661
264	090	007	XX	YY	00	-	900	70	759	381	1,35	10,26	1,89	-	607	698
264	100	007	XX	YY	00	-	1000	70	843	423	1,35	11,40	2,10	-	637	733
264	110	007	XX	YY	00	-	1100	70	927	465	1,35	12,54	2,31	-	669	769
264	120	007	XX	YY	00	-	1200	70	1012	508	1,35	13,68	2,52	-	699	804
264	140	007	XX	YY	00	-	1400	70	1180	592	1,35	15,96	2,94	-	761	875
264	160	007	XX	YY	00	-	1600	70	1349	677	1,35	18,24	3,36	-	826	950
264	180	007	XX	YY	00	-	1800	70	1517	761	1,35	20,52	3,78	-	888	1021
264	200	007	XX	YY	00	-	2000	70	1686	846	1,35	22,80	4,20	-	951	1094
264	220	007	XX	YY	00	-	2200	70	1855	931	1,35	25,08	4,62	-	1012	1164
264	240	007	XX	YY	00	-	2400	70	2023	1015	1,35	27,36	5,04	-	1074	1235
264	260	007	XX	YY	00	-	2600	70	2192	1100	1,35	29,64	5,46	-	1134	1304
264	280	007	XX	YY	00	-	2800	70	2360	1184	1,35	31,92	5,88	-	1199	1379
264	300	007	XX	YY	00	-	3000	70	2529	1269	1,35	34,20	6,30	-	1263	1452
264	330	007	XX	YY	00	-	3300	70	2782	1396	1,35	37,62	6,93	-	1355	1558
264	360	007	XX	YY	00	-	3600	70	3035	1523	1,35	41,04	7,56	-	1448	1665
264	390	007	XX	YY	00	-	3900	70	3288	1650	1,35	44,46	8,19	-	1543	1774

Conform EN442-1: 2014: radiatoren en convectoren

Voor meer details over onze artikel-data, zie artikel-database: <https://www.installdata.be>
Voor de warmteafgiftes van andere regimes, kijkt u op p. 348 (correctiefactoren)
BELGIË. Prijzen in euro (excl. BTW)

PRIMULA P1 (P1/230)



P1

HOE P1/230 BESTELLEN

Leveringstermijn 15 - 30 werkdagen
(zonder transportduur)

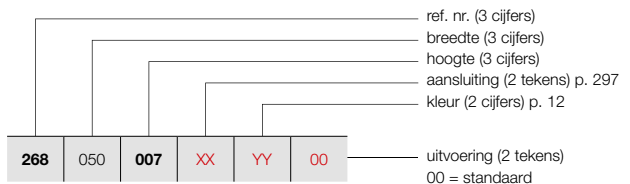

MUURBEVESTIGING / TELESCOPISCHE VOETEN /
KOLOMVOETEN

Zie p. 295 voor extra toebehoren.

PRIJSGROEP: VPG3 - PLINTRADIATOREN

BESTELCODE MAATWERK P1	TECHNISCHE GEGEVENS										STANDAARDKLEUR	ANDERE KLEUREN
	buizen	breedte (L mm)	hoogte (H mm)	75/65/20 (Watt) (φ50K)	55/45/20 (Watt) (φ30K)	n-exp.	gewicht (kg)	inhoud (l)	el. weerst. (Watt)		prijs RAL 9016 (€)	prijs kleur (€)
REF. NR. P1/230 : 268												
268 050 007 XX YY 00	-	500	70	523	258	1,38	6,90	1,20	-		613	705
268 060 007 XX YY 00	-	600	70	627	310	1,38	8,28	1,44	-		656	754
268 070 007 XX YY 00	-	700	70	732	362	1,38	9,66	1,68	-		694	798
268 080 007 XX YY 00	-	800	70	836	413	1,38	11,04	1,92	-		738	849
268 090 007 XX YY 00	-	900	70	941	465	1,38	12,42	2,16	-		779	896
268 100 007 XX YY 00	-	1000	70	1045	516	1,38	13,80	2,40	-		823	946
268 110 007 XX YY 00	-	1100	70	1150	568	1,38	15,18	2,64	-		865	995
268 120 007 XX YY 00	-	1200	70	1254	620	1,38	16,56	2,88	-		903	1038
268 140 007 XX YY 00	-	1400	70	1463	723	1,38	19,32	3,36	-		987	1135
268 160 007 XX YY 00	-	1600	70	1672	826	1,38	22,08	3,84	-		1068	1228
268 180 007 XX YY 00	-	1800	70	1881	929	1,38	24,84	4,32	-		1151	1324
268 200 007 XX YY 00	-	2000	70	2090	1033	1,38	27,60	4,80	-		1236	1421
268 220 007 XX YY 00	-	2200	70	2299	1136	1,38	30,36	5,28	-		1317	1515
268 240 007 XX YY 00	-	2400	70	2508	1239	1,38	33,12	5,76	-		1398	1608
268 260 007 XX YY 00	-	2600	70	2717	1343	1,38	35,88	6,24	-		1483	1705
268 280 007 XX YY 00	-	2800	70	2926	1446	1,38	38,64	6,72	-		1565	1800
268 300 007 XX YY 00	-	3000	70	3135	1549	1,38	41,40	7,20	-		1647	1894
268 330 007 XX YY 00	-	3300	70	3449	1704	1,38	45,54	7,92	-		1773	2039
268 360 007 XX YY 00	-	3600	70	3762	1859	1,38	49,68	8,64	-		1895	2179
268 390 007 XX YY 00	-	3900	70	4076	2014	1,38	53,82	9,36	-		2019	2322

Conform EN442-1: 2014: radiatoren en convectoren

Voor meer details over onze artikel-data, zie artikel-database: <https://www.installdata.be>
Voor de warmteafgifte van andere regimes, kijkt u op p. 348 (correctiefactoren)
BELGIË. Prijzen in euro (excl. BTW)

HOE P1/280 BESTELLEN

Leveringstermijn 15 - 30 werkdagen
(zonder transportduur)

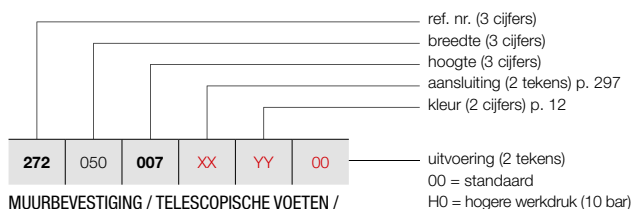

MUURBEVESTIGING / TELESCOPISCHE VOETEN /
KOLOMVOETEN

Zie p. 295 voor extra toebehoren.

PRIMULA P1 (P1/280)



P1

PRIJSGROEP: VPG3 - PLINTRADIATOREN

BESTELCODE MAATWERK P1	TECHNISCHE GEGEVENS											STANDAARDKLEUR	ANDERE KLEUREN			
	buizen	breedte (L mm)	hoogte (H mm)	75/65/20 (Watt) (Φ50K)	55/45/20 (Watt) (Φ30K)	n-exp.	gewicht (kg)	inhoud (l)	el. weerst. (Watt)	prijs RAL 9016 (€)	prijs kleur (€)					
REF. NR. P1/280 : 272																
272	050	007	XX	YY	00	-	500	70	630	315	1,36	8,00	1,40	-	753	866
272	060	007	XX	YY	00	-	600	70	756	377	1,36	9,60	1,68	-	802	922
272	070	007	XX	YY	00	-	700	70	882	440	1,36	11,20	1,96	-	853	981
272	080	007	XX	YY	00	-	800	70	1008	503	1,36	12,80	2,24	-	904	1040
272	090	007	XX	YY	00	-	900	70	1134	566	1,36	14,40	2,52	-	956	1099
272	100	007	XX	YY	00	-	1000	70	1260	629	1,36	16,00	2,80	-	1008	1159
272	110	007	XX	YY	00	-	1100	70	1386	692	1,36	17,60	3,08	-	1056	1214
272	120	007	XX	YY	00	-	1200	70	1512	755	1,36	19,20	3,36	-	1109	1275
272	140	007	XX	YY	00	-	1400	70	1764	881	1,36	22,40	3,92	-	1210	1392
272	160	007	XX	YY	00	-	1600	70	2016	1006	1,36	25,60	4,48	-	1312	1509
272	180	007	XX	YY	00	-	1800	70	2268	1132	1,36	28,80	5,04	-	1413	1625
272	200	007	XX	YY	00	-	2000	70	2520	1258	1,36	32,00	5,60	-	1514	1741
272	220	007	XX	YY	00	-	2200	70	2772	1384	1,36	35,20	6,16	-	1616	1858
272	240	007	XX	YY	00	-	2400	70	3024	1510	1,36	38,40	6,72	-	1717	1975
272	260	007	XX	YY	00	-	2600	70	3276	1635	1,36	41,60	7,28	-	1818	2091
272	280	007	XX	YY	00	-	2800	70	3528	1761	1,36	44,80	7,84	-	1920	2208
272	300	007	XX	YY	00	-	3000	70	3780	1887	1,36	48,00	8,40	-	2020	2323
272	330	007	XX	YY	00	-	3300	70	4158	2076	1,36	52,80	9,24	-	2175	2501
272	360	007	XX	YY	00	-	3600	70	4536	2264	1,36	57,60	10,08	-	2327	2676
272	390	007	XX	YY	00	-	3900	70	4914	2453	1,36	62,40	10,92	-	2479	2851

Conform EN442-1: 2014: radiatoren en convectoren

Voor meer details over onze artikel-data, zie artikel-database: <https://www.installdata.be>
Voor de warmteafgiftes van andere regimes, kijkt u op p. 348 (correctiefactoren)
BELGIË. Prijzen in euro (excl. BTW)

PRIMULA P2 (P2/80)



P2

HOE P2/80 BESTELLEN

Leveringstermijn 15 - 30 werkdagen
(zonder transportduur)

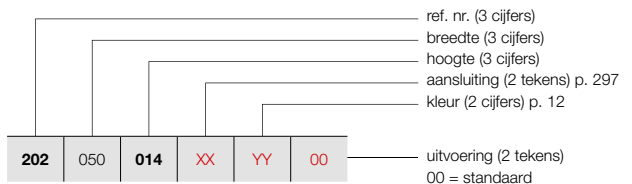

MUURBEVESTIGING / TELESCOPISCHE VOETEN /
KOLOMVOETEN

Zie p. 295 voor extra toebehoren.

PRIJSGROEP: VPG3 - PLINTRADIATOREN

BESTELCODE MAATWERK P2	TECHNISCHE GEGEVENS										STANDAARDKLEUR	ANDERE KLEUREN
	buizen	breedte (L mm)	hoogte (H mm)	75/65/20 (Watt) (φ50K)	55/45/20 (Watt) (φ30K)	n-exp.	gewicht (kg)	inhoud (l)	el. weerst. (Watt)		prijs RAL 9016 (€)	prijs kleur (€)
REF. NR. P2/80 : 202												
202 050 014 XX YY 00	-	500	140	304	153	1,35	5,73	1,46	-		319	367
202 060 014 XX YY 00	-	600	140	365	183	1,35	6,88	1,75	-		336	386
202 070 014 XX YY 00	-	700	140	426	214	1,35	8,02	2,04	-		359	413
202 080 014 XX YY 00	-	800	140	486	244	1,35	9,17	2,33	-		375	431
202 090 014 XX YY 00	-	900	140	547	274	1,35	10,31	2,62	-		395	454
202 100 014 XX YY 00	-	1000	140	608	305	1,35	11,46	2,91	-		414	476
202 110 014 XX YY 00	-	1100	140	669	336	1,35	12,61	3,20	-		433	498
202 120 014 XX YY 00	-	1200	140	730	366	1,35	13,75	3,49	-		453	521
202 140 014 XX YY 00	-	1400	140	851	427	1,35	16,04	4,07	-		488	561
202 160 014 XX YY 00	-	1600	140	973	488	1,35	18,34	4,66	-		527	606
202 180 014 XX YY 00	-	1800	140	1094	549	1,35	20,63	5,24	-		567	652
202 200 014 XX YY 00	-	2000	140	1216	610	1,35	22,92	5,82	-		605	696
202 220 014 XX YY 00	-	2200	140	1338	671	1,35	25,21	6,40	-		644	741
202 240 014 XX YY 00	-	2400	140	1459	732	1,35	27,50	6,98	-		683	785
202 260 014 XX YY 00	-	2600	140	1581	793	1,35	29,80	7,57	-		718	826
202 280 014 XX YY 00	-	2800	140	1702	854	1,35	32,09	8,15	-		757	871
202 300 014 XX YY 00	-	3000	140	1824	915	1,35	34,38	8,73	-		794	913
202 330 014 XX YY 00	-	3300	140	2006	1007	1,35	37,82	9,60	-		848	975
202 360 014 XX YY 00	-	3600	140	2189	1098	1,35	41,26	10,48	-		908	1044
202 390 014 XX YY 00	-	3900	140	2371	1190	1,35	44,69	11,35	-		966	1111

Conform EN442-1: 2014: radiatoren en convectoren

Voor meer details over onze artikel-data, zie artikel-database: <https://www.installdata.be>
Voor de warmteafgifte van andere regimes, kijkt u op p. 348 (correctiefactoren)
BELGIË. Prijzen in euro (excl. BTW)

HOE P2/130 BESTELLEN

Leveringstermijn 15 - 30 werkdagen
(zonder transportduur)

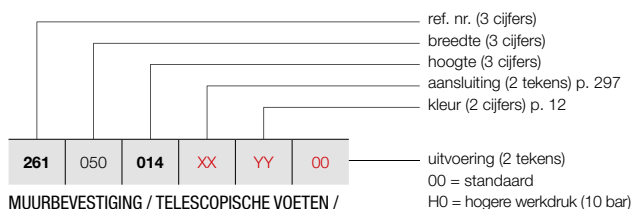

MUURBEVESTIGING / TELESCOPISCHE VOETEN /
KOLOMVOETEN

Zie p. 295 voor extra toebehoren.

PRIMULA P2 (P2/130)



P2

PRIJSGROEP: VPG3 - PLINTRADIATOREN

BESTELCODE MAATWERK P2	TECHNISCHE GEGEVENS											STANDAARDKLEUR	ANDERE KLEUREN			
	buizen	breedte (L mm)	hoogte (H mm)	75/65/20 (Watt) (Φ50K)	55/45/20 (Watt) (Φ30K)	n-exp.	gewicht (kg)	inhoud (l)	el. weerst. (Watt)	prijs RAL 9016 (€)	prijs kleur (€)					
REF. NR. P2/130 : 261																
261	050	014	XX	YY	00	-	500	140	442	221	1,36	7,77	1,87	-	413	475
261	060	014	XX	YY	00	-	600	140	530	265	1,36	9,32	2,24	-	447	514
261	070	014	XX	YY	00	-	700	140	619	309	1,36	10,87	2,61	-	480	552
261	080	014	XX	YY	00	-	800	140	707	353	1,36	12,42	2,98	-	518	596
261	090	014	XX	YY	00	-	900	140	796	397	1,36	13,98	3,36	-	553	636
261	100	014	XX	YY	00	-	1000	140	884	441	1,36	15,53	3,73	-	588	676
261	110	014	XX	YY	00	-	1100	140	972	485	1,36	17,08	4,10	-	619	712
261	120	014	XX	YY	00	-	1200	140	1061	530	1,36	18,64	4,48	-	656	754
261	140	014	XX	YY	00	-	1400	140	1238	618	1,36	21,74	5,22	-	726	835
261	160	014	XX	YY	00	-	1600	140	1414	706	1,36	24,85	5,97	-	793	912
261	180	014	XX	YY	00	-	1800	140	1591	794	1,36	27,95	6,71	-	863	992
261	200	014	XX	YY	00	-	2000	140	1768	883	1,36	31,06	7,46	-	931	1071
261	220	014	XX	YY	00	-	2200	140	1945	971	1,36	34,17	8,21	-	998	1148
261	240	014	XX	YY	00	-	2400	140	2122	1059	1,36	37,27	8,95	-	1068	1228
261	260	014	XX	YY	00	-	2600	140	2298	1147	1,36	40,38	9,70	-	1137	1308
261	280	014	XX	YY	00	-	2800	140	2475	1236	1,36	43,48	10,44	-	1207	1388
261	300	014	XX	YY	00	-	3000	140	2652	1324	1,36	46,59	11,19	-	1275	1466
261	330	014	XX	YY	00	-	3300	140	2917	1456	1,36	51,25	12,31	-	1378	1585
261	360	014	XX	YY	00	-	3600	140	3182	1588	1,36	55,91	13,43	-	1484	1707
261	390	014	XX	YY	00	-	3900	140	3448	1721	1,36	60,57	14,55	-	1585	1823

Conform EN442-1: 2014: radiatoren en convectoren

Voor meer details over onze artikel-data, zie artikel-database: <https://www.installdata.be>
Voor de warmteafgiftes van andere regimes, kijkt u op p. 348 (correctiefactoren)
BELGIË. Prijzen in euro (excl. BTW)

PRIMULA P2 (P2/180)



P2

HOE P2/180 BESTELLEN

Leveringstermijn 15 - 30 werkdagen
(zonder transportduur)

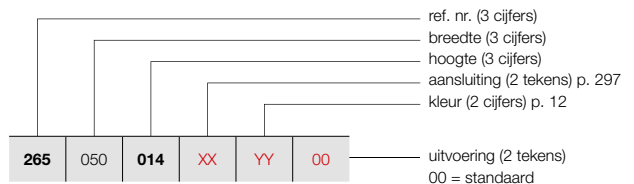

MUURBEVESTIGING / TELESCOPISCHE VOETEN /
KOLOMVOETEN

Zie p. 295 voor extra toebehoren.

PRIJSGROEP: VPG3 - PLINTRADIATOREN

BESTELCODE MAATWERK P2	TECHNISCHE GEGEVENS										STANDAARDKLEUR	ANDERE KLEUREN
	buizen	breedte (L mm)	hoogte (H mm)	75/65/20 (Watt) (φ50K)	55/45/20 (Watt) (φ30K)	n-exp.	gewicht (kg)	inhoud (l)	el. weerst. (Watt)		prijs RAL 9016 (€)	prijs kleur (€)
REF. NR. P2/180 : 265												
265 050 014 XX YY 00	-	500	140	611	305	1,36	9,90	2,23	-		544	626
265 060 014 XX YY 00	-	600	140	733	366	1,36	11,88	2,67	-		594	683
265 070 014 XX YY 00	-	700	140	855	427	1,36	13,86	3,12	-		644	741
265 080 014 XX YY 00	-	800	140	977	488	1,36	15,84	3,56	-		691	795
265 090 014 XX YY 00	-	900	140	1099	549	1,36	17,82	4,01	-		743	854
265 100 014 XX YY 00	-	1000	140	1221	610	1,36	19,80	4,45	-		791	910
265 110 014 XX YY 00	-	1100	140	1343	670	1,36	21,78	4,90	-		840	966
265 120 014 XX YY 00	-	1200	140	1465	731	1,36	23,76	5,34	-		889	1022
265 140 014 XX YY 00	-	1400	140	1709	853	1,36	27,72	6,23	-		988	1136
265 160 014 XX YY 00	-	1600	140	1954	975	1,36	31,68	7,12	-		1088	1251
265 180 014 XX YY 00	-	1800	140	2198	1097	1,36	35,64	8,01	-		1187	1365
265 200 014 XX YY 00	-	2000	140	2442	1219	1,36	39,60	8,90	-		1283	1475
265 220 014 XX YY 00	-	2200	140	2686	1341	1,36	43,56	9,79	-		1386	1594
265 240 014 XX YY 00	-	2400	140	2930	1463	1,36	47,52	10,68	-		1483	1705
265 260 014 XX YY 00	-	2600	140	3175	1585	1,36	51,48	11,57	-		1579	1816
265 280 014 XX YY 00	-	2800	140	3419	1707	1,36	55,44	12,46	-		1678	1930
265 300 014 XX YY 00	-	3000	140	3663	1829	1,36	59,40	13,35	-		1777	2044
265 330 014 XX YY 00	-	3300	140	4029	2011	1,36	65,34	14,69	-		1925	2214
265 360 014 XX YY 00	-	3600	140	4396	2195	1,36	71,28	16,02	-		2075	2386
265 390 014 XX YY 00	-	3900	140	4762	2377	1,36	77,22	17,36	-		2220	2553

Conform EN442-1: 2014: radiatoren en convectoren

Voor meer details over onze artikel-data, zie artikel-database: <https://www.installdata.be>
Voor de warmteafgiftes van andere regimes, kijkt u op p. 348 (correctiefactoren)
BELGIË. Prijzen in euro (excl. BTW)

HOE P2/230 BESTELLEN

Leveringstermijn 15 - 30 werkdagen
(zonder transportduur)

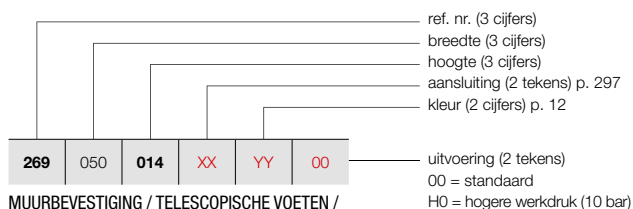

MUURBEVESTIGING / TELESCOPISCHE VOETEN / KOLOMVOETEN

Zie p. 295 voor extra toebehoren.

PRIMULA P2 (P2/230)



P2

PRIJSGROEP: VPG3 - PLINTRADIATOREN

BESTELCODE MAATWERK P2	TECHNISCHE GEGEVENS											STANDAARDKLEUR	ANDERE KLEUREN			
	buizen	breedte (L mm)	hoogte (H mm)	75/65/20 (Watt) (Φ50K)	55/45/20 (Watt) (Φ30K)	n-exp.	gewicht (kg)	inhoud (l)	el. weerst. (Watt)	prijs RAL 9016 (€)	prijs kleur (€)					
REF. NR. P2/230 : 269																
269	050	014	XX	YY	00	-	500	140	756	375	1,37	11,88	2,73	-	699	804
269	060	014	XX	YY	00	-	600	140	907	450	1,37	14,25	3,27	-	768	883
269	070	014	XX	YY	00	-	700	140	1058	525	1,37	16,63	3,82	-	836	961
269	080	014	XX	YY	00	-	800	140	1209	600	1,37	19,00	4,36	-	904	1040
269	090	014	XX	YY	00	-	900	140	1360	675	1,37	21,38	4,91	-	974	1120
269	100	014	XX	YY	00	-	1000	140	1511	750	1,37	23,75	5,45	-	1043	1199
269	110	014	XX	YY	00	-	1100	140	1662	825	1,37	26,13	6,00	-	1110	1277
269	120	014	XX	YY	00	-	1200	140	1813	900	1,37	28,50	6,54	-	1179	1356
269	140	014	XX	YY	00	-	1400	140	2115	1050	1,37	33,25	7,63	-	1314	1511
269	160	014	XX	YY	00	-	1600	140	2418	1201	1,37	38,00	8,72	-	1450	1668
269	180	014	XX	YY	00	-	1800	140	2720	1351	1,37	42,75	9,81	-	1588	1826
269	200	014	XX	YY	00	-	2000	140	3022	1501	1,37	47,50	10,90	-	1723	1981
269	220	014	XX	YY	00	-	2200	140	3324	1651	1,37	52,25	11,99	-	1862	2141
269	240	014	XX	YY	00	-	2400	140	3626	1801	1,37	57,00	13,08	-	1999	2299
269	260	014	XX	YY	00	-	2600	140	3929	1951	1,37	61,75	14,17	-	2135	2455
269	280	014	XX	YY	00	-	2800	140	4231	2101	1,37	66,50	15,26	-	2271	2612
269	300	014	XX	YY	00	-	3000	140	4533	2251	1,37	71,25	16,35	-	2407	2768
269	330	014	XX	YY	00	-	3300	140	4986	2476	1,37	78,38	17,99	-	2610	3002
269	360	014	XX	YY	00	-	3600	140	5440	2702	1,37	85,50	19,62	-	2812	3234
269	390	014	XX	YY	00	-	3900	140	5893	2927	1,37	92,63	21,26	-	3021	3474

Conform EN442-1: 2014: radiatoren en convectoren

Voor meer details over onze artikel-data, zie artikel-database: <https://www.installdata.be>
Voor de warmteafgiftes van andere regimes, kijkt u op p. 348 (correctiefactoren)
BELGIË. Prijzen in euro (excl. BTW)

PRIMULA P2 (P2/280)



P2

HOE P2/280 BESTELLEN

Leveringstermijn 15 - 30 werkdagen
(zonder transportduur)

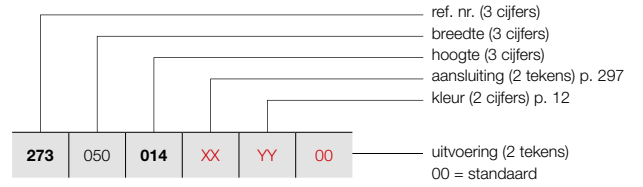

MUURBEVESTIGING / TELESCOPISCHE VOETEN /
KOLOMVOETEN

Zie p. 295 voor extra toebehoren.

PRIJSGROEP: VPG3 - PLINTRADIATOREN

BESTELCODE MAATWERK P2	TECHNISCHE GEGEVENS										STANDAARDKLEUR	ANDERE KLEUREN
	buizen	breedte (L mm)	hoogte (H mm)	75/65/20 (Watt) (φ50K)	55/45/20 (Watt) (φ30K)	n-exp.	gewicht (kg)	inhoud (l)	el. weerst. (Watt)		prijs RAL 9016 (€)	prijs kleur (€)
REF. NR. P2/280 : 273												
273 050 014 XX YY 00	-	500	140	953	473	1,37	13,85	2,98	-		860	989
273 060 014 XX YY 00	-	600	140	1143	568	1,37	16,62	3,57	-		945	1087
273 070 014 XX YY 00	-	700	140	1334	663	1,37	19,39	4,17	-		1029	1183
273 080 014 XX YY 00	-	800	140	1524	757	1,37	22,16	4,76	-		1111	1278
273 090 014 XX YY 00	-	900	140	1715	852	1,37	24,93	5,36	-		1196	1375
273 100 014 XX YY 00	-	1000	140	1905	946	1,37	27,70	5,95	-		1279	1471
273 110 014 XX YY 00	-	1100	140	2096	1041	1,37	30,47	6,55	-		1360	1564
273 120 014 XX YY 00	-	1200	140	2286	1135	1,37	33,24	7,14	-		1446	1663
273 140 014 XX YY 00	-	1400	140	2667	1325	1,37	38,78	8,33	-		1614	1856
273 160 014 XX YY 00	-	1600	140	3048	1514	1,37	44,32	9,52	-		1779	2046
273 180 014 XX YY 00	-	1800	140	3429	1703	1,37	49,86	10,71	-		1948	2240
273 200 014 XX YY 00	-	2000	140	3810	1892	1,37	55,40	11,90	-		2115	2432
273 220 014 XX YY 00	-	2200	140	4191	2082	1,37	60,94	13,09	-		2283	2625
273 240 014 XX YY 00	-	2400	140	4572	2271	1,37	66,48	14,28	-		2448	2815
273 260 014 XX YY 00	-	2600	140	4953	2460	1,37	72,02	15,47	-		2619	3012
273 280 014 XX YY 00	-	2800	140	5334	2649	1,37	77,56	16,66	-		2785	3203
273 300 014 XX YY 00	-	3000	140	5715	2838	1,37	83,10	17,85	-		2955	3398
273 330 014 XX YY 00	-	3300	140	6287	3123	1,37	91,41	19,64	-		3204	3685
273 360 014 XX YY 00	-	3600	140	6858	3406	1,37	99,72	21,42	-		3455	3973
273 390 014 XX YY 00	-	3900	140	7430	3690	1,37	108,03	23,21	-		3708	4264

Conform EN442-1: 2014: radiatoren en convectoren

Voor meer details over onze artikel-data, zie artikel-database: <https://www.installdata.be>

Voor de warmteafgiftes van andere regimes, kijkt u op p. 348 (correctiefactoren)
BELGIË. Prijzen in euro (excl. BTW)

HOE P3/80 BESTELLEN

Leveringstermijn 15 - 30 werkdagen
(zonder transportduur)

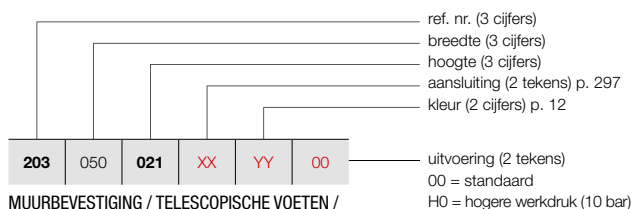

MUURBEVESTIGING / TELESCOPISCHE VOETEN /
KOLOMVOETEN

Zie p. 295 voor extra toebehoren.

PRIMULA P3 (P3/80)



P3

PRIJSGROEP: VPG3 - PLINTRADIATOREN

BESTELCODE MAATWERK P3	TECHNISCHE GEGEVENS											STANDAARDKLEUR	ANDERE KLEUREN			
	buizen	breedte (L mm)	hoogte (H mm)	75/65/20 (Watt) (Φ50K)	55/45/20 (Watt) (Φ30K)	n-exp.	gewicht (kg)	inhoud (l)	el. weerst. (Watt)	prijs RAL 9016 (€)	prijs kleur (€)					
REF. NR. P3/80 : 203																
203	050	021	XX	YY	00	-	500	210	378	190	1,35	8,40	2,25	-	455	523
203	060	021	XX	YY	00	-	600	210	454	228	1,35	10,08	2,70	-	476	547
203	070	021	XX	YY	00	-	700	210	529	265	1,35	11,76	3,15	-	507	583
203	080	021	XX	YY	00	-	800	210	605	304	1,35	13,44	3,60	-	526	605
203	090	021	XX	YY	00	-	900	210	680	341	1,35	15,12	4,05	-	552	635
203	100	021	XX	YY	00	-	1000	210	756	379	1,35	16,80	4,50	-	573	659
203	110	021	XX	YY	00	-	1100	210	832	417	1,35	18,48	4,95	-	597	687
203	120	021	XX	YY	00	-	1200	210	907	455	1,35	20,16	5,40	-	622	715
203	140	021	XX	YY	00	-	1400	210	1058	531	1,35	23,52	6,30	-	669	769
203	160	021	XX	YY	00	-	1600	210	1210	607	1,35	26,88	7,20	-	718	826
203	180	021	XX	YY	00	-	1800	210	1361	683	1,35	30,24	8,10	-	764	879
203	200	021	XX	YY	00	-	2000	210	1512	759	1,35	33,60	9,00	-	813	935
203	220	021	XX	YY	00	-	2200	210	1663	834	1,35	36,96	9,90	-	860	989
203	240	021	XX	YY	00	-	2400	210	1814	910	1,35	40,32	10,80	-	907	1043
203	260	021	XX	YY	00	-	2600	210	1966	986	1,35	43,68	11,70	-	955	1098
203	280	021	XX	YY	00	-	2800	210	2117	1062	1,35	47,04	12,60	-	999	1149
203	300	021	XX	YY	00	-	3000	210	2268	1138	1,35	50,40	13,50	-	1050	1208
203	330	021	XX	YY	00	-	3300	210	2495	1252	1,35	55,44	14,85	-	1122	1290
203	360	021	XX	YY	00	-	3600	210	2722	1366	1,35	60,48	16,20	-	1194	1373
203	390	021	XX	YY	00	-	3900	210	2948	1479	1,35	65,52	17,55	-	1265	1455

Conform EN442-1: 2014: radiatoren en convectoren

Voor meer details over onze artikel-data, zie artikel-database: <https://www.installdata.be>
Voor de warmteafgiftes van andere regimes, kijkt u op p. 348 (correctiefactoren)
BELGIË. Prijzen in euro (excl. BTW)

PRIMULA P3 (P3/130)



P3

HOE P3/130 BESTELLEN

Leveringstermijn 15 - 30 werkdagen
(zonder transportduur)

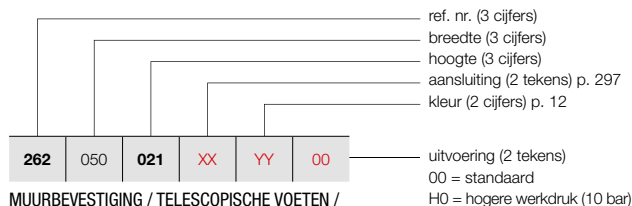

MUURBEVESTIGING / TELESCOPISCHE VOETEN /
KOLOMVOETEN

Zie p. 295 voor extra toebehoren.

PRIJSGROEP: VPG3 - PLINTRADIATOREN

BESTELCODE MAATWERK P3	TECHNISCHE GEGEVENS										STANDAARDKLEUR	ANDERE KLEUREN				
	buizen	breedte (L mm)	hoogte (H mm)	75/65/20 (Watt) (φ50K)	55/45/20 (Watt) (φ30K)	n-exp.	gewicht (kg)	inhoud (l)	el. weerst. (Watt)		prijs RAL 9016 (€)	prijs kleur (€)				
REF. NR. P3/130 : 262																
262	050	021	XX	YY	00	-	500	210	560	281	1,35	11,20	2,85	-	549	631
262	060	021	XX	YY	00	-	600	210	672	337	1,35	13,44	3,42	-	586	674
262	070	021	XX	YY	00	-	700	210	784	393	1,35	15,68	3,99	-	623	716
262	080	021	XX	YY	00	-	800	210	896	450	1,35	17,92	4,56	-	662	761
262	090	021	XX	YY	00	-	900	210	1008	506	1,35	20,16	5,13	-	699	804
262	100	021	XX	YY	00	-	1000	210	1120	562	1,35	22,40	5,70	-	739	850
262	110	021	XX	YY	00	-	1100	210	1232	618	1,35	24,64	6,27	-	777	894
262	120	021	XX	YY	00	-	1200	210	1344	674	1,35	26,88	6,84	-	816	938
262	140	021	XX	YY	00	-	1400	210	1568	787	1,35	31,36	7,98	-	891	1025
262	160	021	XX	YY	00	-	1600	210	1792	899	1,35	35,84	9,12	-	972	1118
262	180	021	XX	YY	00	-	1800	210	2016	1012	1,35	40,32	10,26	-	1048	1205
262	200	021	XX	YY	00	-	2000	210	2240	1124	1,35	44,80	11,40	-	1125	1294
262	220	021	XX	YY	00	-	2200	210	2464	1236	1,35	49,28	12,54	-	1203	1383
262	240	021	XX	YY	00	-	2400	210	2688	1349	1,35	53,76	13,68	-	1279	1471
262	260	021	XX	YY	00	-	2600	210	2912	1461	1,35	58,24	14,82	-	1355	1558
262	280	021	XX	YY	00	-	2800	210	3136	1574	1,35	62,72	15,96	-	1431	1646
262	300	021	XX	YY	00	-	3000	210	3360	1686	1,35	67,20	17,10	-	1510	1737
262	330	021	XX	YY	00	-	3300	210	3696	1855	1,35	73,92	18,81	-	1625	1869
262	360	021	XX	YY	00	-	3600	210	4032	2023	1,35	80,64	20,52	-	1740	2001
262	390	021	XX	YY	00	-	3900	210	4368	2192	1,35	87,36	22,23	-	1857	2136

Conform EN442-1: 2014: radiatoren en convectoren

Voor meer details over onze artikel-data, zie artikel-database: <https://www.installdata.be>
Voor de warmteafgiftes van andere regimes, kijkt u op p. 348 (correctiefactoren)
BELGIË. Prijzen in euro (excl. BTW)

HOE P3/180 BESTELLEN

Leveringstermijn 15 - 30 werkdagen
(zonder transportduur)

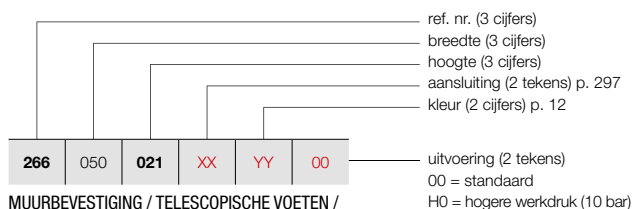

MUURBEVESTIGING / TELESCOPISCHE VOETEN / KOLOMVOETEN

Zie p. 295 voor extra toebehoren.

PRIMULA P3 (P3/180)



P3

PRIJSGROEP: VPG3 - PLINTRADIATOREN

BESTELCODE MAATWERK P3	TECHNISCHE GEGEVENS											STANDAARDKLEUR	ANDERE KLEUREN			
	buizen	breedte (L mm)	hoogte (H mm)	75/65/20 (Watt) (Φ50K)	55/45/20 (Watt) (Φ30K)	n-exp.	gewicht (kg)	inhoud (l)	el. weerst. (Watt)	prijs RAL 9016 (€)	prijs kleur (€)					
REF. NR. P3/180 : 266																
266	050	021	XX	YY	00	-	500	210	771	381	1,38	14,10	3,40	-	700	805
266	060	021	XX	YY	00	-	600	210	925	457	1,38	16,92	4,08	-	757	871
266	070	021	XX	YY	00	-	700	210	1079	533	1,38	19,74	4,76	-	813	935
266	080	021	XX	YY	00	-	800	210	1233	609	1,38	22,56	5,44	-	867	997
266	090	021	XX	YY	00	-	900	210	1387	685	1,38	25,38	6,12	-	920	1058
266	100	021	XX	YY	00	-	1000	210	1541	761	1,38	28,20	6,80	-	975	1121
266	110	021	XX	YY	00	-	1100	210	1695	838	1,38	31,02	7,48	-	1031	1186
266	120	021	XX	YY	00	-	1200	210	1849	914	1,38	33,84	8,16	-	1085	1248
266	140	021	XX	YY	00	-	1400	210	2157	1066	1,38	39,48	9,52	-	1194	1373
266	160	021	XX	YY	00	-	1600	210	2466	1219	1,38	45,12	10,88	-	1305	1501
266	180	021	XX	YY	00	-	1800	210	2774	1371	1,38	50,76	12,24	-	1412	1624
266	200	021	XX	YY	00	-	2000	210	3082	1523	1,38	56,40	13,60	-	1522	1750
266	220	021	XX	YY	00	-	2200	210	3390	1675	1,38	62,04	14,96	-	1630	1875
266	240	021	XX	YY	00	-	2400	210	3698	1827	1,38	67,68	16,32	-	1738	1999
266	260	021	XX	YY	00	-	2600	210	4007	1980	1,38	73,32	17,68	-	1848	2125
266	280	021	XX	YY	00	-	2800	210	4315	2132	1,38	78,96	19,04	-	1958	2252
266	300	021	XX	YY	00	-	3000	210	4623	2284	1,38	84,60	20,40	-	2067	2377
266	330	021	XX	YY	00	-	3300	210	5085	2513	1,38	93,06	22,44	-	2231	2566
266	360	021	XX	YY	00	-	3600	210	5548	2741	1,38	101,52	24,48	-	2395	2754
266	390	021	XX	YY	00	-	3900	210	6010	2970	1,38	109,98	26,52	-	2559	2943

Conform EN442-1: 2014: radiatoren en convectoren

Voor meer details over onze artikel-data, zie artikel-database: <https://www.installdata.be>
Voor de warmteafgiftes van andere regimes, kijkt u op p. 348 (correctiefactoren)
BELGIË. Prijzen in euro (excl. BTW)

PRIMULA P3 (P3/230)



P3

HOE P3/230 BESTELLEN

Leveringstermijn 15 - 30 werkdagen
(zonder transportduur)

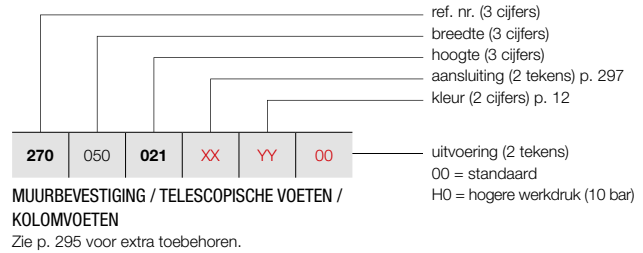

PRIJSGROEP: VPG3 - PLINTRADIATOREN

BESTELCODE MAATWERK P3	TECHNISCHE GEGEVENS										STANDAARDKLEUR	ANDERE KLEUREN
	buizen	breedte (L mm)	hoogte (H mm)	75/65/20 (Watt) (φ50K)	55/45/20 (Watt) (φ30K)	n-exp.	gewicht (kg)	inhoud (l)	el. weerst. (Watt)		prijs RAL 9016 (€)	prijs kleur (€)
REF. NR. P3/230 : 270												
270 050 021 XX YY 00	-	500	210	950	472	1,37	16,85	4,25	-		860	989
270 060 021 XX YY 00	-	600	210	1140	566	1,37	20,22	5,10	-		931	1071
270 070 021 XX YY 00	-	700	210	1330	661	1,37	23,59	5,95	-		999	1149
270 080 021 XX YY 00	-	800	210	1520	755	1,37	26,96	6,80	-		1074	1235
270 090 021 XX YY 00	-	900	210	1710	849	1,37	30,33	7,65	-		1144	1316
270 100 021 XX YY 00	-	1000	210	1900	944	1,37	33,70	8,50	-		1215	1397
270 110 021 XX YY 00	-	1100	210	2090	1038	1,37	37,07	9,35	-		1286	1479
270 120 021 XX YY 00	-	1200	210	2280	1132	1,37	40,44	10,20	-		1358	1562
270 140 021 XX YY 00	-	1400	210	2660	1321	1,37	47,18	11,90	-		1502	1727
270 160 021 XX YY 00	-	1600	210	3040	1510	1,37	53,92	13,60	-		1645	1892
270 180 021 XX YY 00	-	1800	210	3420	1699	1,37	60,66	15,30	-		1787	2055
270 200 021 XX YY 00	-	2000	210	3800	1887	1,37	67,40	17,00	-		1929	2218
270 220 021 XX YY 00	-	2200	210	4180	2076	1,37	74,14	18,70	-		2073	2384
270 240 021 XX YY 00	-	2400	210	4560	2265	1,37	80,88	20,40	-		2215	2547
270 260 021 XX YY 00	-	2600	210	4940	2454	1,37	87,62	22,10	-		2359	2713
270 280 021 XX YY 00	-	2800	210	5320	2642	1,37	94,36	23,80	-		2501	2876
270 300 021 XX YY 00	-	3000	210	5700	2831	1,37	101,10	25,50	-		2646	3043
270 330 021 XX YY 00	-	3300	210	6270	3114	1,37	111,21	28,05	-		2857	3286
270 360 021 XX YY 00	-	3600	210	6840	3397	1,37	121,32	30,60	-		3070	3531
270 390 021 XX YY 00	-	3900	210	7410	3680	1,37	131,43	33,15	-		3284	3777

Conform EN442-1: 2014: radiatoren en convectoren

Voor meer details over onze artikel-data, zie artikel-database: <https://www.installdata.be>

Voor de warmteafgiftes van andere regimes, kijkt u op p. 348 (correctiefactoren)
BELGIË. Prijzen in euro (excl. BTW)

HOE P3/280 BESTELLEN

Leveringstermijn 15 - 30 werkdagen
(zonder transportduur)

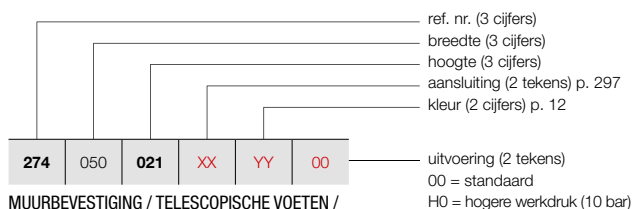

MUURBEVESTIGING / TELESCOPISCHE VOETEN /
KOLOMVOETEN

Zie p. 295 voor extra toebehoren.

PRIMULA P3 (P3/280)



P3

PRIJSGROEP: VPG3 - PLINTRADIATOREN

BESTELCODE MAATWERK P3	TECHNISCHE GEGEVENS											STANDAARDKLEUR	ANDERE KLEUREN			
	buizen	breedte (L mm)	hoogte (H mm)	75/65/20 (Watt) (Φ50K)	55/45/20 (Watt) (Φ30K)	n-exp.	gewicht (kg)	inhoud (l)	el. weerst. (Watt)	prijs RAL 9016 (€)	prijs kleur (€)					
REF. NR. P3/280 : 274																
274	050	021	XX	YY	00	-	500	210	1176	581	1,38	19,70	4,55	-	1018	1171
274	060	021	XX	YY	00	-	600	210	1411	697	1,38	23,64	5,46	-	1105	1271
274	070	021	XX	YY	00	-	700	210	1646	813	1,38	27,58	6,37	-	1188	1366
274	080	021	XX	YY	00	-	800	210	1881	929	1,38	31,52	7,28	-	1273	1464
274	090	021	XX	YY	00	-	900	210	2116	1046	1,38	35,46	8,19	-	1356	1559
274	100	021	XX	YY	00	-	1000	210	2351	1162	1,38	39,40	9,10	-	1444	1661
274	110	021	XX	YY	00	-	1100	210	2586	1278	1,38	43,34	10,01	-	1527	1756
274	120	021	XX	YY	00	-	1200	210	2821	1394	1,38	47,28	10,92	-	1610	1852
274	140	021	XX	YY	00	-	1400	210	3291	1626	1,38	55,16	12,74	-	1779	2046
274	160	021	XX	YY	00	-	1600	210	3762	1859	1,38	63,04	14,56	-	1949	2241
274	180	021	XX	YY	00	-	1800	210	4232	2091	1,38	70,92	16,38	-	2120	2438
274	200	021	XX	YY	00	-	2000	210	4702	2323	1,38	78,80	18,20	-	2290	2634
274	220	021	XX	YY	00	-	2200	210	5172	2556	1,38	86,68	20,02	-	2457	2826
274	240	021	XX	YY	00	-	2400	210	5642	2788	1,38	94,56	21,84	-	2628	3022
274	260	021	XX	YY	00	-	2600	210	6113	3021	1,38	102,44	23,66	-	2799	3219
274	280	021	XX	YY	00	-	2800	210	6583	3253	1,38	110,32	25,48	-	2965	3410
274	300	021	XX	YY	00	-	3000	210	7053	3485	1,38	118,20	27,30	-	3133	3603
274	330	021	XX	YY	00	-	3300	210	7758	3834	1,38	130,02	30,03	-	3392	3901
274	360	021	XX	YY	00	-	3600	210	8464	4182	1,38	141,84	32,76	-	3643	4189

Conform EN442-1: 2014: radiatoren en convectoren

Voor meer details over onze artikel-data, zie artikel-database: <https://www.installdata.be>
Voor de warmteafgiftes van andere regimes, kijkt u op p. 348 (correctiefactoren)
BELGIË. Prijzen in euro (excl. BTW)

PRIMULA P4 (P4/80)



P4

HOE P4/80 BESTELLEN

Leveringstermijn 15 - 30 werkdagen
(zonder transportduur)

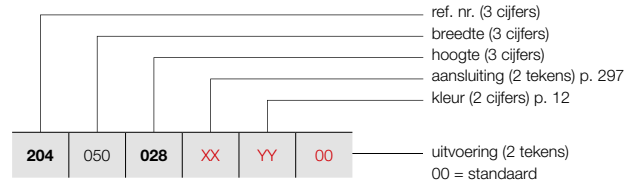

MUURBEVESTIGING / TELESCOPISCHE VOETEN /
KOLOMVOETEN

Zie p. 295 voor extra toebehoren.

PRIJSGROEP: VPG3 - PLINTRADIATOREN

BESTELCODE MAATWERK P4	TECHNISCHE GEGEVENS										STANDAARDKLEUR	ANDERE KLEUREN				
	buizen	breedte (L mm)	hoogte (H mm)	75/65/20 (Watt) (φ50K)	55/45/20 (Watt) (φ30K)	n-exp.	gewicht (kg)	inhoud (l)	el. weerst. (Watt)		prijs RAL 9016 (€)	prijs kleur (€)				
REF. NR. P4/80 : 204																
204	050	028	XX	YY	00	-	500	280	435	219	1,34	11,07	3,05	-	575	661
204	060	028	XX	YY	00	-	600	280	522	263	1,34	13,28	3,65	-	608	699
204	070	028	XX	YY	00	-	700	280	609	307	1,34	15,50	4,26	-	640	736
204	080	028	XX	YY	00	-	800	280	696	351	1,34	17,71	4,87	-	671	772
204	090	028	XX	YY	00	-	900	280	783	395	1,34	19,93	5,48	-	703	808
204	100	028	XX	YY	00	-	1000	280	870	439	1,34	22,14	6,09	-	737	848
204	110	028	XX	YY	00	-	1100	280	957	483	1,34	24,35	6,70	-	767	882
204	120	028	XX	YY	00	-	1200	280	1044	527	1,34	26,57	7,31	-	800	920
204	140	028	XX	YY	00	-	1400	280	1218	614	1,34	31,00	8,53	-	866	996
204	160	028	XX	YY	00	-	1600	280	1392	702	1,34	35,42	9,74	-	927	1066
204	180	028	XX	YY	00	-	1800	280	1566	790	1,34	39,85	10,96	-	990	1139
204	200	028	XX	YY	00	-	2000	280	1740	878	1,34	44,28	12,18	-	1054	1212
204	220	028	XX	YY	00	-	2200	280	1914	965	1,34	48,71	13,40	-	1120	1288
204	240	028	XX	YY	00	-	2400	280	2088	1053	1,34	53,14	14,62	-	1184	1362
204	260	028	XX	YY	00	-	2600	280	2262	1141	1,34	57,56	15,83	-	1247	1434
204	280	028	XX	YY	00	-	2800	280	2436	1229	1,34	61,99	17,05	-	1312	1509
204	300	028	XX	YY	00	-	3000	280	2610	1316	1,34	66,42	18,27	-	1374	1580
204	330	028	XX	YY	00	-	3300	280	2871	1448	1,34	73,06	20,10	-	1472	1693
204	360	028	XX	YY	00	-	3600	280	3132	1580	1,34	79,70	21,92	-	1569	1804
204	390	028	XX	YY	00	-	3900	280	3393	1711	1,34	86,35	23,75	-	1664	1914

Conform EN442-1: 2014: radiatoren en convectoren

Voor meer details over onze artikel-data, zie artikel-database: <https://www.installdata.be>

Voor de warmteafgiftes van andere regimes, kijkt u op p. 348 (correctiefactoren)
BELGIË. Prijzen in euro (excl. BTW)

HOE P4/130 BESTELLEN

Leveringstermijn 15 - 30 werkdagen
(zonder transportduur)

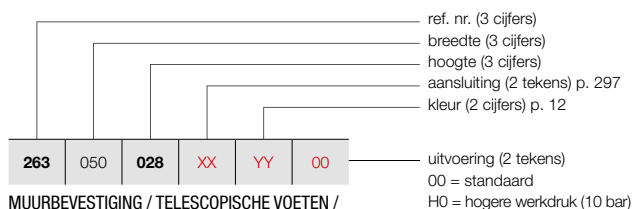

MUURBEVESTIGING / TELESCOPISCHE VOETEN /
KOLOMVOETEN

Zie p. 295 voor extra toebehoren.

PRIMULA P4 (P4/130)



P4

PRIJSGROEP: VPG3 - PLINTRADIATOREN

BESTELCODE MAATWERK P4	TECHNISCHE GEGEVENS											STANDAARDKLEUR	ANDERE KLEUREN			
	buizen	breedte (L mm)	hoogte (H mm)	75/65/20 (Watt) (Φ50K)	55/45/20 (Watt) (Φ30K)	n-exp.	gewicht (kg)	inhoud (l)	el. weerst. (Watt)	prijs RAL 9016 (€)	prijs kleur (€)					
REF. NR. P4/130 : 263																
263	050	028	XX	YY	00	-	500	280	678	333	1,39	14,64	3,84	-	644	741
263	060	028	XX	YY	00	-	600	280	813	400	1,39	17,57	4,61	-	691	795
263	070	028	XX	YY	00	-	700	280	949	467	1,39	20,50	5,38	-	743	854
263	080	028	XX	YY	00	-	800	280	1084	533	1,39	23,42	6,14	-	791	910
263	090	028	XX	YY	00	-	900	280	1220	600	1,39	26,35	6,91	-	840	966
263	100	028	XX	YY	00	-	1000	280	1355	666	1,39	29,28	7,68	-	890	1024
263	110	028	XX	YY	00	-	1100	280	1491	733	1,39	32,21	8,45	-	940	1081
263	120	028	XX	YY	00	-	1200	280	1626	799	1,39	35,14	9,22	-	989	1137
263	140	028	XX	YY	00	-	1400	280	1897	933	1,39	40,99	10,75	-	1089	1252
263	160	028	XX	YY	00	-	1600	280	2168	1066	1,39	46,85	12,29	-	1188	1366
263	180	028	XX	YY	00	-	1800	280	2439	1199	1,39	52,70	13,82	-	1286	1479
263	200	028	XX	YY	00	-	2000	280	2710	1332	1,39	58,56	15,36	-	1389	1597
263	220	028	XX	YY	00	-	2200	280	2981	1466	1,39	64,42	16,90	-	1488	1711
263	240	028	XX	YY	00	-	2400	280	3252	1599	1,39	70,27	18,43	-	1584	1822
263	260	028	XX	YY	00	-	2600	280	3523	1732	1,39	76,13	19,97	-	1685	1938
263	280	028	XX	YY	00	-	2800	280	3794	1865	1,39	81,98	21,50	-	1785	2053
263	300	028	XX	YY	00	-	3000	280	4065	1998	1,39	87,84	23,04	-	1882	2164
263	330	028	XX	YY	00	-	3300	280	4472	2199	1,39	96,62	25,34	-	2035	2340
263	360	028	XX	YY	00	-	3600	280	4878	2398	1,39	105,41	27,65	-	2181	2508
263	390	028	XX	YY	00	-	3900	280	5285	2598	1,39	114,19	29,95	-	2330	2680

Conform EN442-1: 2014: radiatoren en convectoren

Voor meer details over onze artikel-data, zie artikel-database: <https://www.installdata.be>
Voor de warmteafgiftes van andere regimes, kijkt u op p. 348 (correctiefactoren)
BELGIË. Prijzen in euro (excl. BTW)

PRIMULA P4 (P4/180)



P4

HOE P4/180 BESTELLEN

Leveringstermijn 15 - 30 werkdagen
(zonder transportduur)

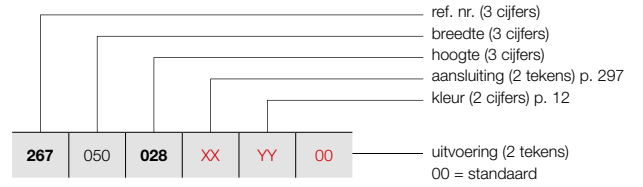

MUURBEVESTIGING / TELESCOPISCHE VOETEN /
KOLOMVOETEN

Zie p. 295 voor extra toebehoren.

PRIJSGROEP: VPG3 - PLINTRADIATOREN

BESTELCODE MAATWERK P4	TECHNISCHE GEGEVENS										STANDAARDKLEUR	ANDERE KLEUREN				
	buizen	breedte (L mm)	hoogte (H mm)	75/65/20 (Watt) (φ50K)	55/45/20 (Watt) (φ30K)	n-exp.	gewicht (kg)	inhoud (l)	el. weerst. (Watt)		prijs RAL 9016 (€)	prijs kleur (€)				
REF. NR. P4/180 : 267																
267	050	028	XX	YY	00	-	500	280	919	449	1,40	18,30	4,58	-	831	956
267	060	028	XX	YY	00	-	600	280	1103	539	1,40	21,96	5,49	-	897	1032
267	070	028	XX	YY	00	-	700	280	1287	629	1,40	25,62	6,41	-	969	1114
267	080	028	XX	YY	00	-	800	280	1470	719	1,40	29,28	7,32	-	1036	1191
267	090	028	XX	YY	00	-	900	280	1654	809	1,40	32,94	8,24	-	1108	1274
267	100	028	XX	YY	00	-	1000	280	1838	899	1,40	36,60	9,15	-	1177	1354
267	110	028	XX	YY	00	-	1100	280	2022	989	1,40	40,26	10,07	-	1245	1432
267	120	028	XX	YY	00	-	1200	280	2206	1079	1,40	43,92	10,98	-	1314	1511
267	140	028	XX	YY	00	-	1400	280	2573	1258	1,40	51,24	12,81	-	1453	1671
267	160	028	XX	YY	00	-	1600	280	2941	1438	1,40	58,56	14,64	-	1591	1830
267	180	028	XX	YY	00	-	1800	280	3308	1618	1,40	65,88	16,47	-	1730	1990
267	200	028	XX	YY	00	-	2000	280	3676	1798	1,40	73,20	18,30	-	1871	2152
267	220	028	XX	YY	00	-	2200	280	4044	1978	1,40	80,52	20,13	-	2007	2308
267	240	028	XX	YY	00	-	2400	280	4411	2157	1,40	87,84	21,96	-	2147	2469
267	260	028	XX	YY	00	-	2600	280	4779	2337	1,40	95,16	23,79	-	2285	2628
267	280	028	XX	YY	00	-	2800	280	5146	2517	1,40	102,48	25,62	-	2428	2792
267	300	028	XX	YY	00	-	3000	280	5514	2697	1,40	109,80	27,45	-	2562	2946
267	330	028	XX	YY	00	-	3300	280	6065	2966	1,40	120,78	30,20	-	2770	3186
267	360	028	XX	YY	00	-	3600	280	6617	3236	1,40	131,76	32,94	-	2979	3426
267	390	028	XX	YY	00	-	3900	280	7168	3506	1,40	142,74	35,69	-	3187	3665

Conform EN442-1: 2014: radiatoren en convectoren

Voor meer details over onze artikel-data, zie artikel-database: <https://www.installdata.be>

Voor de warmteafgiftes van andere regimes, kijkt u op p. 348 (correctiefactoren)
BELGIË. Prijzen in euro (excl. BTW)

HOE P4/230 BESTELLEN

Leveringstermijn 15 - 30 werkdagen
(zonder transportduur)

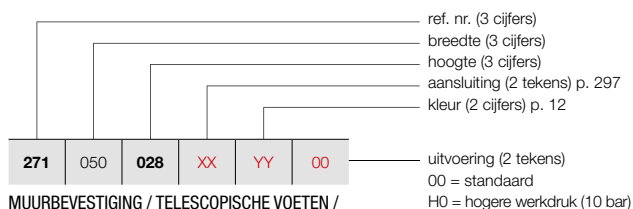

MUURBEVESTIGING / TELESCOPISCHE VOETEN /
KOLOMVOETEN

Zie p. 295 voor extra toebehoren.

PRIMULA P4 (P4/230)



P4

PRIJSGROEP: VPG3 - PLINTRADIATOREN

BESTELCODE MAATWERK P4	TECHNISCHE GEGEVENS											STANDAARDKLEUR	ANDERE KLEUREN			
	buizen	breedte (L mm)	hoogte (H mm)	75/65/20 (Watt) (Φ50K)	55/45/20 (Watt) (Φ30K)	n-exp.	gewicht (kg)	inhoud (l)	el. weerst. (Watt)	prijs RAL 9016 (€)	prijs kleur (€)					
REF. NR. P4/230 : 271																
271	050	028	XX	YY	00	-	500	280	1129	552	1,40	21,83	5,78	-	1035	1190
271	060	028	XX	YY	00	-	600	280	1355	663	1,40	26,19	6,93	-	1128	1297
271	070	028	XX	YY	00	-	700	280	1581	773	1,40	30,56	8,09	-	1218	1401
271	080	028	XX	YY	00	-	800	280	1806	883	1,40	34,92	9,24	-	1313	1510
271	090	028	XX	YY	00	-	900	280	2032	994	1,40	39,29	10,40	-	1407	1618
271	100	028	XX	YY	00	-	1000	280	2258	1104	1,40	43,65	11,55	-	1499	1724
271	110	028	XX	YY	00	-	1100	280	2484	1215	1,40	48,02	12,71	-	1591	1830
271	120	028	XX	YY	00	-	1200	280	2710	1326	1,40	52,38	13,86	-	1684	1937
271	140	028	XX	YY	00	-	1400	280	3161	1546	1,40	61,11	16,17	-	1871	2152
271	160	028	XX	YY	00	-	1600	280	3613	1767	1,40	69,84	18,48	-	2054	2362
271	180	028	XX	YY	00	-	1800	280	4064	1988	1,40	78,57	20,79	-	2240	2576
271	200	028	XX	YY	00	-	2000	280	4516	2209	1,40	87,30	23,10	-	2429	2793
271	220	028	XX	YY	00	-	2200	280	4968	2430	1,40	96,03	25,41	-	2611	3003
271	240	028	XX	YY	00	-	2400	280	5419	2651	1,40	104,76	27,72	-	2799	3219
271	260	028	XX	YY	00	-	2600	280	5871	2872	1,40	113,49	30,03	-	2982	3429
271	280	028	XX	YY	00	-	2800	280	6322	3092	1,40	122,22	32,34	-	3170	3646
271	300	028	XX	YY	00	-	3000	280	6774	3313	1,40	130,95	34,65	-	3353	3856
271	330	028	XX	YY	00	-	3300	280	7451	3644	1,40	144,05	38,12	-	3633	4178

Conform EN442-1: 2014: radiatoren en convectoren

Voor meer details over onze artikel-data, zie artikel-database: <https://www.installdata.be>
Voor de warmteafgiftes van andere regimes, kijkt u op p. 348 (correctiefactoren)
BELGIË. Prijzen in euro (excl. BTW)

PRIMULA P4 (P4/280)



P4

HOE P4/280 BESTELLEN

Leveringstermijn 15 - 30 werkdagen
(zonder transportduur)

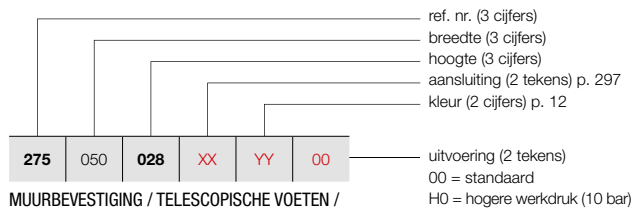

MUURBEVESTIGING / TELESCOPISCHE VOETEN /
KOLOMVOETEN

Zie p. 295 voor extra toebehoren.

PRIJSGROEP: VPG3 - PLINTRADIATOREN

BESTELCODE MAATWERK P4	TECHNISCHE GEGEVENS										STANDAARDKLEUR	ANDERE KLEUREN				
	buizen	breedte (L mm)	hoogte (H mm)	75/65/20 (Watt) (φ50K)	55/45/20 (Watt) (φ30K)	n-exp.	gewicht (kg)	inhoud (l)	el. weerst. (Watt)		prijs RAL 9016 (€)	prijs kleur (€)				
REF. NR. P4/280 : 275																
275	050	028	XX	YY	00	-	500	280	1335	653	1,40	25,55	6,13	-	1247	1434
275	060	028	XX	YY	00	-	600	280	1602	784	1,40	30,66	7,35	-	1359	1563
275	070	028	XX	YY	00	-	700	280	1869	914	1,40	35,77	8,58	-	1472	1693
275	080	028	XX	YY	00	-	800	280	2136	1045	1,40	40,88	9,80	-	1581	1818
275	090	028	XX	YY	00	-	900	280	2403	1175	1,40	45,99	11,03	-	1697	1952
275	100	028	XX	YY	00	-	1000	280	2670	1306	1,40	51,10	12,25	-	1808	2079
275	110	028	XX	YY	00	-	1100	280	2937	1437	1,40	56,21	13,48	-	1920	2208
275	120	028	XX	YY	00	-	1200	280	3204	1567	1,40	61,32	14,70	-	2035	2340
275	140	028	XX	YY	00	-	1400	280	3738	1828	1,40	71,54	17,15	-	2254	2592
275	160	028	XX	YY	00	-	1600	280	4272	2090	1,40	81,76	19,60	-	2480	2852
275	180	028	XX	YY	00	-	1800	280	4806	2351	1,40	91,98	22,05	-	2703	3108
275	200	028	XX	YY	00	-	2000	280	5340	2612	1,40	102,20	24,50	-	2926	3365
275	220	028	XX	YY	00	-	2200	280	5874	2873	1,40	112,42	26,95	-	3150	3623
275	240	028	XX	YY	00	-	2400	280	6408	3134	1,40	122,64	29,40	-	3374	3880
275	260	028	XX	YY	00	-	2600	280	6942	3395	1,40	132,86	31,85	-	3597	4137
275	280	028	XX	YY	00	-	2800	280	7476	3657	1,40	143,08	34,30	-	3820	4393

Conform EN442-1: 2014: radiatoren en convectoren

Voor meer details over onze artikel-data, zie artikel-database: <https://www.installdata.be>

Voor de warmteafgiftes van andere regimes, kijkt u op p. 348 (correctiefactoren)

BELGIË. Prijzen in euro (excl. BTW)

PRIJSGROEP: VPG10 - ACC.

LENGTE IN MM NOODZAKELIJK AANTAL STUKS PER PLINT	ART. NR. P/80	ART. NR. P/130	ART. NR. P/180	ART. NR. P/230	ART. NR. P/280	KLEUR	€
--	------------------	-------------------	-------------------	-------------------	-------------------	-------	---

MUURBEVESTIGING*



500 - 1800: 2	1186 012 0000 9016	1186 022 0000 9016	1186 032 0000 9016	1186 042 0000 9016	1186 052 0000 9016	RAL 9016	28
	1186 012 0000 XXXX	1186 022 0000 XXXX	1186 032 0000 XXXX	1186 042 0000 XXXX	1186 052 0000 XXXX	KLEUR	32
2000 - 2400: 3	1186 013 0000 9016	1186 023 0000 9016	1186 033 0000 9016	1186 043 0000 9016	1186 053 0000 9016	RAL 9016	42
	1186 013 0000 XXXX	1186 023 0000 XXXX	1186 033 0000 XXXX	1186 043 0000 XXXX	1186 053 0000 XXXX	KLEUR	48
2600 - 3600: 4	1186 014 0000 9016	1186 024 0000 9016	1186 034 0000 9016	1186 044 0000 9016	1186 054 0000 9016	RAL 9016	56
	1186 014 0000 XXXX	1186 024 0000 XXXX	1186 034 0000 XXXX	1186 044 0000 XXXX	1186 054 0000 XXXX	KLEUR	64
3900: 5	1186 015 0000 9016	1186 025 0000 9016	1186 035 0000 9016	1186 045 0000 9016	1186 055 0000 9016	RAL 9016	70
	1186 015 0000 XXXX	1186 025 0000 XXXX	1186 035 0000 XXXX	1186 045 0000 XXXX	1186 055 0000 XXXX	KLEUR	80

Bij bestelling steeds het plinttype (80-130-180-230-280) en de kleur opgeven. Bij de muurbevestigingen zijn de volgende maximumbreedtes mogelijk:
bij P3: diepte = 180 mm, bij P4: diepte = 130 mm.

* noodzakelijk aantal stuks per plint:

in mm	P1					P2					P3			P4	
	80	130	180	230	280	80	130	180	230	280	80	130	180	80	130
tot 1800 mm	2	3	3	4	4	2	3	3	4	5	2	3	3	2	3
1900 - 2400 mm	2	3	3	4	4	2	3	3	4	6	2	3	3	3	3
2500 - 3600 mm	3	3	3	4	5	3	3	4	5	6	3	3	4	3	4
3700 - 3900 mm	3	3	3	4	5	3	3	4	5	6	3	4	4	3	4

BELGIË. Prijzen in euro (excl. BTW)

PRIMULA VRIJSTAANDE OPSTELLING
IN OPTIE

PRIJSGROEP: VPG10 - ACC.

LENGTE IN MM NOODZAKELIJK AANTAL STUKS PER PLINT	ART. NR. P/80	ART. NR. P/130	ART. NR. P/180	ART. NR. P/230	ART. NR. P/280	KLEUR	€
--	------------------	-------------------	-------------------	-------------------	-------------------	-------	---



TELESCOPISCHE VOETEN

500 - 1800: 2	1186 112 0000 9016	1186 122 0000 9016	1186 132 0000 9016	1186 142 0000 9016	1186 152 0000 9016	RAL 9016	42
	1186 112 0000 XXXX	1186 122 0000 XXXX	1186 132 0000 XXXX	1186 142 0000 XXXX	1186 152 0000 XXXX	KLEUR	48
2000 - 2400: 3	1186 113 0000 9016	1186 123 0000 9016	1186 133 0000 9016	1186 143 0000 9016	1186 153 0000 9016	RAL 9016	63
	1186 113 0000 XXXX	1186 123 0000 XXXX	1186 133 0000 XXXX	1186 143 0000 XXXX	1186 153 0000 XXXX	KLEUR	72
2600 - 3600: 4	1186 114 0000 9016	1186 124 0000 9016	1186 134 0000 9016	1186 144 0000 9016	1186 154 0000 9016	RAL 9016	84
	1186 114 0000 XXXX	1186 124 0000 XXXX	1186 134 0000 XXXX	1186 144 0000 XXXX	1186 154 0000 XXXX	KLEUR	96
3900: 5	1186 115 0000 9016	1186 125 0000 9016	1186 135 0000 9016	1186 145 0000 9016	1186 155 0000 9016	RAL 9016	105
	1186 115 0000 XXXX	1186 125 0000 XXXX	1186 135 0000 XXXX	1186 145 0000 XXXX	1186 155 0000 XXXX	KLEUR	120

Bij bestelling van standconsoles het plinttype opgeven (80-130-180-230-280) en de kleur. Deze voeten worden standaard geleverd met roset. Max. hoogte voetjes: 265 mm. Min. hoogte voetjes: 205 mm. Het bovendee van het voetje bestaat uit een rechthoekige buis van 40/25 mm, het onderste uit een rechthoekige buis van 35/20 mm.

BELGIË. Prijzen in euro (excl. BTW)

PRIJSGROEP: VPG10 - ACC.

LENGTE IN MM NOODZAKELIJK AANTAL STUKS PER PLINT	KLEUR	ART. NR. P/80	€	ART. NR. P/130	€	ART. NR. P/180	€	ART. NR. P/230	€	ART. NR. P/280	€
--	-------	------------------	---	-------------------	---	-------------------	---	-------------------	---	-------------------	---



KOLOMVOETEN

500 - 1800: 2	RAL 9016	1186 212 0000 9016	86	1186 222 0000 9016	88	1186 232 0000 9016	90	1186 242 0000 9016	92	1186 252 0000 9016	98
	KLEUR	1186 212 0000 XXXX	98	1186 222 0000 XXXX	102	1186 232 0000 XXXX	104	1186 242 0000 XXXX	106	1186 252 0000 XXXX	112
2000 - 2400: 3	RAL 9016	1186 213 0000 9016	129	1186 223 0000 9016	132	1186 233 0000 9016	135	1186 243 0000 9016	138	1186 253 0000 9016	147
	KLEUR	1186 213 0000 XXXX	147	1186 223 0000 XXXX	153	1186 233 0000 XXXX	156	1186 243 0000 XXXX	159	1186 253 0000 XXXX	168
2600 - 3600: 4	RAL 9016	1186 214 0000 9016	172	1186 224 0000 9016	176	1186 234 0000 9016	180	1186 244 0000 9016	184	1186 254 0000 9016	196
	KLEUR	1186 214 0000 XXXX	196	1186 224 0000 XXXX	204	1186 234 0000 XXXX	208	1186 244 0000 XXXX	212	1186 254 0000 XXXX	224
3900: 5	RAL 9016	1186 215 0000 9016	215	1186 225 0000 9016	220	1186 235 0000 9016	225	1186 245 0000 9016	230	1186 255 0000 9016	245
	KLEUR	1186 215 0000 XXXX	245	1186 225 0000 XXXX	255	1186 235 0000 XXXX	260	1186 245 0000 XXXX	265	1186 255 0000 XXXX	280

Voor de eventuele inbouwmontage van een thermostaatventiel. De standaardhoogte van de kolomvoeten is 150 mm.
Aantal benodigde kolomvoeten = idem telescopische voetjes.

BELGIË. Prijzen in euro (excl. BTW)

PRIMULA: P1 / P2 / P3 / P4

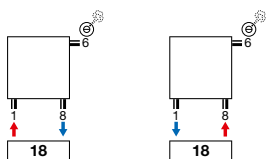

PRIMULA: P2 / P3 / P4

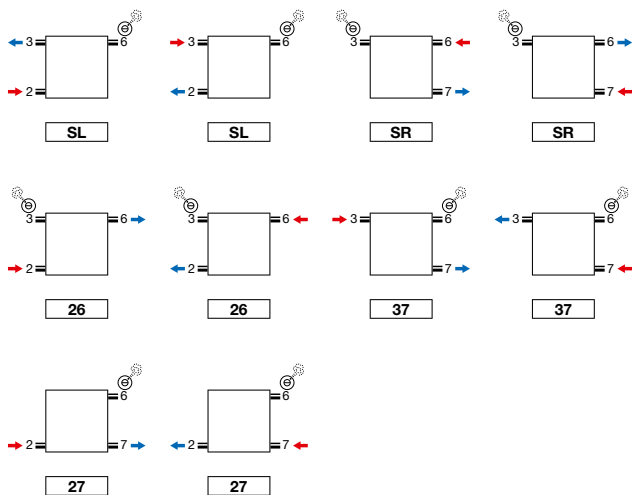

UNIVERSELE AANSLUITING

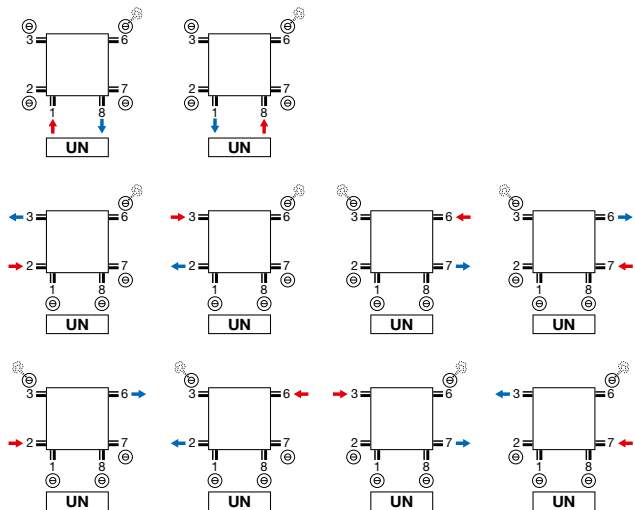

- P2, P3, P4 universele aansluiting 6 x ½ (1, 2, 3, 6, 7, 8)
- P1 universele aansluiting 4 x ½ (1, 3, 6, 8)

OPMERKING TWEEPIJPSYSTEEM:

- niet mogelijk bij type P1: SL, SR

Opmerking: het aansluiten van de radiator kan enkel volgens de getoonde aansluiticonen. Voor elke andere aansluitwijze nemen wij geen verantwoordelijkheid.

PRIMULA (P1, P2, P3, P4)

Aansluiting 18 | Bovenaanzicht

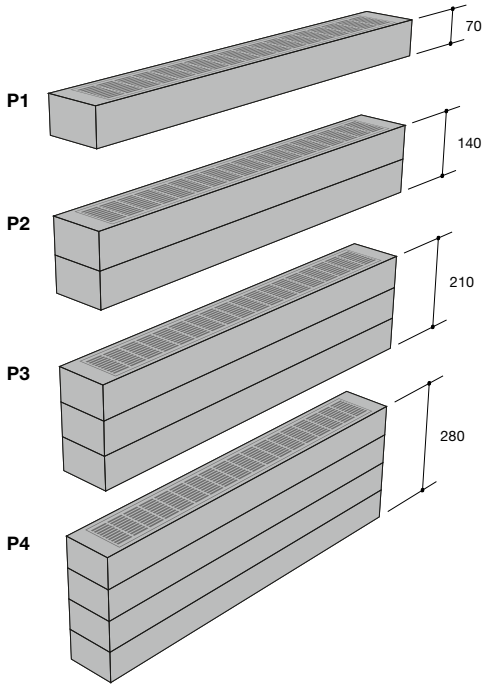
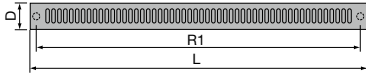

Universele aansluiting UN (standaard) | Zijaanzicht

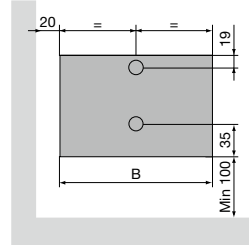

Aansluiting SL/SR | Zijaanzicht

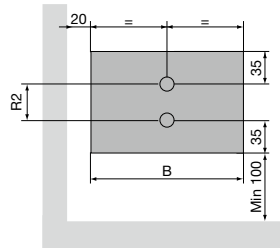

P1 / P2 / P3 / P4

Hartafstand tussen de onderaansluitingen 18 (R1)	Breedte (L) - 46
Hartafstand tussen de zijaansluitingen SL/SR (P2, P3, P4) (R2)	Hoogte (H) - 70
Afstand aansluiting tot de muur (S1)	20 + Diepte (D) / 2



VASCO